

# IACS

INTERNATIONAL ASSOCIATION OF CLASSIFICATION SOCIETIES LTD.

PERMANENT SECRETARIAT: 4 Matthew Parker Street

Westminster, London SW1H 9NP, UNITED KINGDOM

TEL: +44(0)207 976 0660

INTERNET: [permsec@iacs.org.uk](mailto:permsec@iacs.org.uk) Web Site: [www.iacs.org.uk](http://www.iacs.org.uk)

---

June 2023

## History Files (HF) and Technical Background (TB) documents for URs concerning Mooring and Anchoring (UR A)

Res. No.	Title	Current Rev.	HF/TB?
UR A1	Anchoring Equipment	Rev.8 June 2023	HF
UR A2	Shipboard fittings and supporting hull structures associated with towing and mooring on conventional ships	Rev.5 Sep 2020	HF
UR A3	Anchor Windlass Design and Testing	Rev.1 June 2019	HF

## UR A1 “Anchoring Equipment”

### Summary

This revision introduces clarifications and updates to requirements regarding:

- purpose of anchoring equipment
- application of UR A1
- alternative method for calculations of anchoring equipment
- anchoring equipment for tugs
- use of wire rope in place of chain cable

### Part A. Revision History

Version no.	Approval date	Implementation date when applicable
Rev.8 (June 2023)	15 June 2023	1 July 2024
Corr.1 (Sep 2021)	03 September 2021	-
Rev.7 (Sep 2020)	25 September 2020	1 January 2022
Corr.2 (Mar 2017)	15 March 2017	1 July 2018
Corr.1 (Dec 2016)	-	-
Rev.6 (Oct 2016)	31 October 2016	1 January 2018
Rev.5 (June 2005)	June 2005	1 January 2007
Rev.4 (Aug 1999)	Aug 1999	2000
Rev.3 (1994)	1994	1995
Rev.2 (1992)	1992	1993
Rev.1 (1987)	1987	1988
New (1981)	1981	1982

#### • Rev. 8 (June 2023)

##### 1 Origin of Change:

- Suggestion by IACS member

##### 2 Main Reason for Change:

The present text of UR A1 contains general requirements for all types of ships. For fishing vessels and smaller ships with EN lower than 205 but greater than 50 operating in unrestricted service, UR A1 has been reviewed and updated to ensure a common standard for anchoring equipment requirements to reduce the number of reservations of IACS member societies against parts of UR A1.

##### 3 List of non-IACS Member classification societies contributing or participating in IACS Working Group:

None



#### 4 History of Decisions Made:

The present text of UR A1 contains general requirements for all types of ships. For fishing vessels and smaller ships with EN lower than 205 but greater than 50 operating in unrestricted service, UR A1 has been reviewed and updated to ensure a common standard for anchoring equipment requirements to reduce the number of reservations of IACS member societies against parts of UR A1.

#### 5 Other Resolutions Changes:

Rec.10

#### 6 Any hinderance to MASS, including any other new technologies:

None

#### 7 Dates:

Original Proposal:	31 March 2021	(Made by IACS Member)
Panel Approval:	25 May 2023	(Ref: PH20005_IHak)
GPG Approval:	15 June 2023	(Ref: 21027_IGi)

- **Corr.1 (Sep 2021)**

#### 1 Origin of Change:

Suggestion by IACS member

#### 2 Main Reason for Change:

In Rev.7 the definition of parameter "a" was changed unintentionally which is now corrected and clarified.

#### 3 List of non-IACS Member classification societies contributing or participating in IACS Working Group:

None

#### 4 History of Decisions Made:

Definition of parameter "a" within the definition of the effective height was discussed in Hull Panel, especially, if the deck camber should be included in parameter "a" or not. The inclusion of deck camber would increase the equipment number in general. As this was not supported by the Panel and the HF and TB to Rev.7 does not include information about changing this important parameter by adding the camber it was decided to correct the definition of parameter "a" by replacing "distance" by "vertical distance at hull side" and removing "at centreline". This is also in line with the definition of the same parameter in the previous revisions of UR A1 (before Rev.7). Figure 1 has been updated accordingly by removing "a". The upper deck as indicated in Figure 1 has been clarified to be measured at centreline to be consistent with the description given in the definition of 'h<sub>i</sub>'.

## 5 Other Resolutions Changes:

None

## 6 Any hinderance to MASS, including any other new technologies:

None

## 7 Dates:

Original Proposal	: 13 July 2021	Made by: Hull Panel Chair
Panel Approval	: 25 August 2021	(Ref: PH21016_IHe)
GPG Approval	: 03 September 2021	(Ref: 21136_IGc)

### • Rev.7 (Sep 2020)

#### .1 Origin for Change:

Suggestion by IACS member

#### .2 Main Reason for Change:

In the recent years, the installation of equipment in the funnel such as scrubber resulted in the increase of funnel breadth. An IACS Member raised a question about how to treat the funnel whose breadth exceeds B/4 in the Equipment Number (EN) calculation specified in UR A1.2.1.

Additionally, an IACS Member highlighted differences in the approaches adopted in the UR A1 and A2.

In UR A1.7.3, the stresses of hull supporting structure of anchor windlass and chain stopper are to be computed using a gross thickness approach while in UR A2.1.5 and A2.2.5 a net thickness approach is requested for the calculation of hull supporting structure.

#### .3 List of non-IACS Member Classification Societies contributing or participating in IACS Working Group:

None

#### .4 History of Decisions Made:

The Hull Panel discussed about the increase in funnels size and decided to update the UR A1. Funnels with breadth exceeding B/4 shall be considered in the Equipment Number (EN) calculation specified in UR A1.2.1.

A separate TB has been developed detailing the scope for the consideration of funnels as summarized hereafter:

- The breadth of the funnel is considered in the front shape area
- The part of the funnel with a total breadth less than B/4 is disregarded in the front

shape area and in the side projected area.

- The effective area of accommodation deck considered in the calculation of the parameter  $h$  is considered as a shield in front of the funnel and is so deduced from the front shape area of the funnels.

The case where several funnels are fitted in the ship are also contemplated in this revision. In this case the Hull Panel decided to consider the sum of the breadth of each funnel having breadth bigger than  $B/4$ .

Additionally, as suggested by one Member, the Hull Panel decided to align the approaches utilized in UR A1 and A2. In line with UR A2, the permissible stress acting on the supporting hull structures of windlass and chain stoppers from UR A1 were modified to adopt a net thickness approach. Consequently, a new paragraph for corrosion addition was introduced in UR A1.

The guidance of meshing size for strength assessment by means of finite element analysis is newly introduced in line with the coarse mesh criteria as commonly adopted in FEA.

As a result from the Hull Panel review, the permissible stress in A1.7.3 was modified to the net thickness basis in line with A2.1.5 & A2.2.5. The guidance for finite element modelling for strength assessment by means of finite element analysis was provided in A1.7.3 also in line with A2.1.5 & A2.2.5. The new section A1.7.4 for the corrosion addition has been included in line with A2.4.

#### **.5 Other Resolutions Changes:**

UR A2 & Rec 10

#### **6 Any hinderance to MASS, including any other new technologies:**

None

#### **.7 Dates:**

Original Proposal:	27 March 2018 (Ref: PH18006/PH18013)
Panel Approval:	27 August 2020 (Ref: 12106_PHI)
GPG Approval:	25 September 2020 (Ref: 12106_IGzd)

- **Corr.2 (Mar 2017)**

#### **.1 Origin for Change:**

- Suggestion by IACS member

#### **.2 Main Reason for Change:**

To modify the effective date of the UR A1, UR A2 from 1 January 2018 to 1 July 2018 in order to have a consistent effective date of a planned RCN/URCN which is to incorporate the updates made to UR A1, UR A2 and Rec. 10.

**.3 List of non-IACS Member Classification Societies contributing through the TC Forum and/or participating in IACS Working Group:**

None

**.4 History of Decisions Made**

None

**.5 Other Resolutions Changes**

None

**.6 Dates:**

Original Proposal: 03 February 2017 by Hull Panel  
Panel Approval: 10 February 2017 (Ref: PH17002).  
GPG Approval: 15 March 2017 (Ref: 17022\_IGb)

• **Corr.1 (Dec 2016)**

**.1 Origin for Change:**

Other (Editorial correction identified by Hull Panel)

**.2 Main Reason for Change:**

Editorial correction identified by Hull Panel.

**.3 List of non-IACS Member Classification Societies contributing through the TC Forum and/or participating in IACS Working Group:**

None

**.4 History of Decisions Made**

None.

**.5 Other Resolutions Changes**

None

**.6 Dates:**

Original Proposal: 07 November 2016 by Hull Panel  
Panel Approval: 09 December 2016 (Ref: PH7011\_IHcg).  
GPG Approval: N.A.

- **Rev.6 (Oct 2016)**

**.1 Origin for Change:**

- Request by non-IACS entity
- Suggestion by IACS member

**.2 Main Reason for Change:**

Due to concerns raised by the industry in view of an increasing number of incidents, such as anchor losses, IACS decided to review and update UR A1 and Recommendation No. 10 "Anchoring, Mooring, and Towing Equipment". Operational practices being adopted by many owners, in particular, anchoring in unsheltered waters, have been considered for the review of the existing criteria for anchoring to reflect current practice.

**.3 List of non-IACS Member Classification Societies contributing through the TC Forum and/or participating in IACS Working Group:**

None.

**.4 History of Decisions Made:**

GPG approved the initial Form A for the review of UR A1, UR A2, and Rec. No. 10 on 6 November 2009 (9633\_IGc) and a revised Form A on 8 November 2010 (10035\_IGg). The task was extended to allow for more extensive investigations and the associated Form A was approved by GPG on 23 August 2012 (12106\_IGd).

The final draft revision of UR A1 and the associated technical background document were approved by Hull Panel on 6 January 2016.

**.5 Other Resolutions Changes:**

Recommendation No. 10 "Anchoring, Mooring, and Towing Equipment" was revised in parallel to and aligned with UR A1. A new Unified Requirement A3 "Anchor Windlass Design and Testing" has been set up. UR A3 is to refer to UR A1 in terms of required anchor and chain as well as requirements to hull supporting structures of anchor windlass and chain stopper.

**.6 Dates:**

Original Proposal: 18 September 2007 made by GPG (6111cIGb)  
Panel Approval: 03 October 2016 (Ref: PH7011)  
GPG Approval: 31 October 2016 (12106\_IGs)

- **Rev.5 (June 2005)**

Refer to the TB document in Part B.

- **Rev.4 (Aug 1999)**

No history files or TB document available.

- **Rev.3 (1994)**

No history files or TB document available.

- **Rev.2 (1992)**

No history files or TB document available.

- **Rev.1 (1987)**

No history files or TB document available.

- **New (1981)**

No history files or TB document available.

## **Part B. Technical Background**

List of Technical Background (TB) documents for UR A1:

Annex 1. **TB for Rev.5 (June 2005)**

See separate TB document in Annex 1.

Annex 2. **TB for Rev.6 (Oct 2016)**

See separate TB document in Annex 2.

Annex 3. **TB for Rev.7 (Sep 2020)**

See separate TB document in Annex 3.

Annex 4. **TB for Rev.8 (June 2023)**

See separate TB document in Annex 4.

*Note: There are no separate Technical Background (TB) documents available for New (1981), Rev.1 (1987), Rev.2 (1992), Rev.3 (1994), Rev.4 (Aug 1999), Corr.1 (Dec 2016), Corr.2 (Mar 2017) and Corr.1 (Sep 2021).*

**Technical Background Document  
UR A1 (Rev.5, June 2005)**

**Requirements for Equipment**

**1. Background- Review of UR A1**

WP/MW Chairman reported in his final report to GPG that:

In relation to development of requirement for anchor (Task No.46), the draft amendment to UR A1 which is to be handled by the CG/MA was proposed for consideration and action by the GPG. The GPG is requested to convey the draft to the Hull Panel and appropriate Project Team on M/A for their technical consideration.

**2. GPG undertook the review and approval of UR A1(Rev.5)**

GPG agreed that section 1.1.2.3 of REC 10 be deleted to avoid any conflict between UR A1 and REC 10 in relation to the anchor proof testing.

Permsec  
01/06/2005



## **Technical Background (TB) document for UR A1 (Rev.6 Oct 2016)**

### **1. Scope and objectives**

Due to concerns raised by the industry in view of an increasing number of incidents like anchor losses UR A1 has been reviewed and updated. Operational practices being adopted by many owners, in particular, anchoring in unsheltered waters have been considered for the review of the existing criteria for anchoring to reflect current practice. Extensive numerical calculations have been carried out to verify the existing environment conditions and to establish alternative environment conditions for the required anchoring equipment for anchoring in unsheltered waters including wave loads.

For further information see Attachment 1.

### **2. Engineering background for technical basis and rationale**

See Attachment 1.

### **3. Source/derivation of the proposed IACS Resolution**

See Attachment 1.

### **4. Summary of Changes intended for the revised Resolution**

UR A1 has been reviewed and updated with respect to environmental criteria for the required anchoring equipment. Based on extensive numerical calculations the existing environment conditions were verified. To reflect current anchoring practice, alternative environment conditions for the required anchoring equipment have been specified for anchoring in unsheltered waters including wave loads.

Provisions have been added for wire ropes for anchors, similar to those in Recommendation No. 10, to reduce the number of reservations of IACS member societies against parts of UR A1.

Furthermore, requirements for hull supporting structures of anchor windlass and chain stopper have been introduced.

With this revision also several editorial changes have been introduced.

See Attachment 1 for more detailed information.

### **5. Points of discussions or possible discussions**

None.

### **6. Attachments if any**

See Attachment 1.

# Technical background to UR A1 (Rev.6 Oct 2016) 'Anchoring Equipment'

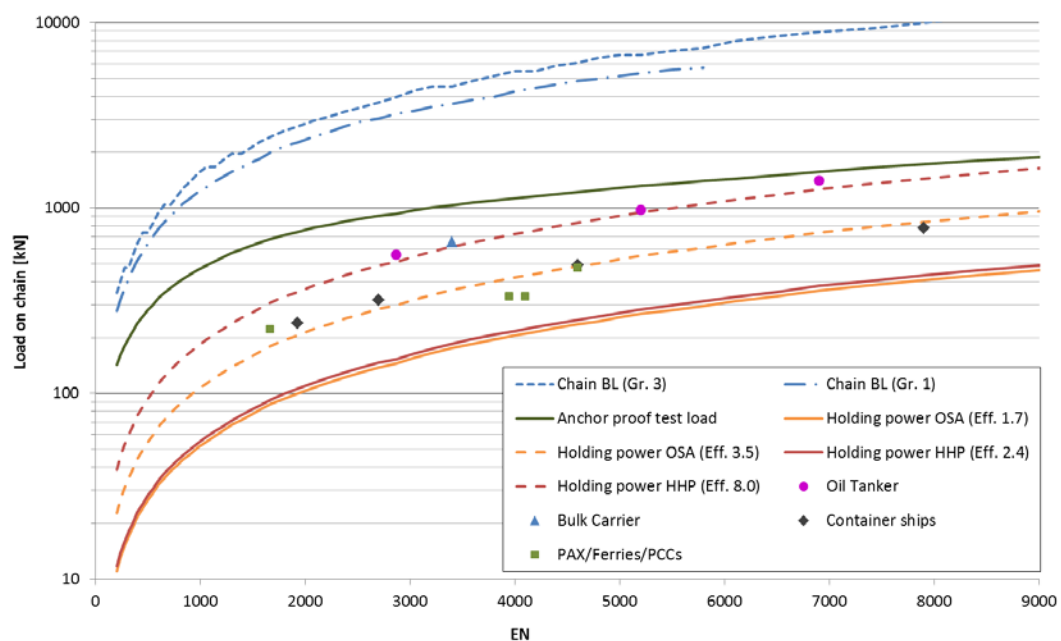
## A1.1. Design of the anchoring equipment

The required anchoring equipment given by UR A1 was reviewed with respect to the given environmental conditions. Furthermore, for the required anchoring equipment, alternative environmental conditions, including waves, were determined to serve as guidance for the limitations of the anchoring equipment used in semi-sheltered or unsheltered anchorages. For this, numerical anchoring calculations were performed for ships of different types and sizes under the following conditions:

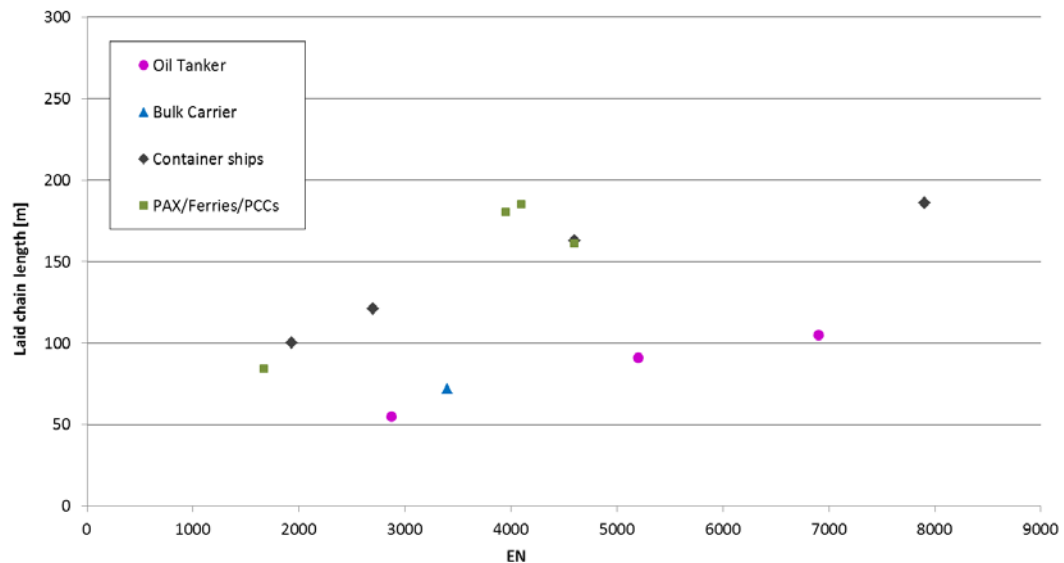
- a) Wind speed 25m/s, current speed 2.5 m/s, no waves, for:
  - i. maximum possible water depth maintaining a scope of six
  - ii. shallow water depth with maximum possible scope
- b) Wind speed 11m/s, current speed 1.54 m/s and significant wave height 2 m, for maximum possible water depth maintaining a scope of six

The results for the maximum calculated chain cable tensions for a), i) are shown below over the Equipment Number EN and are compared to:

- Holding power of ordinary stockless anchors (OSA) with a weight as required by UR A1 for anchor efficiencies of 1.7 and 3.5, representing sea bed consisting of soft mud and shingle/sand, respectively, according to OCIMF 'Anchoring Systems and Procedures'
- Holding power of high holding power anchors (HHP) with a weight as required by UR A1 for anchor efficiencies of 2.4 and 8.0, representing sea bed consisting of rock with thin mud layer and shingle/sand, respectively, according to OCIMF 'Anchoring Systems and Procedures'
- Proof test load for anchors with a weight as required by UR A1
- Breaking strength of chain cable of grades 1 and 3 as required by UR A1.



The laid length of the chain cable is important for the holding power of the anchor, which drastically reduces when the shank lifts from the sea bed. The results for the calculated minimum laid length of the chain cable for a), i) are shown below over the Equipment Number EN.



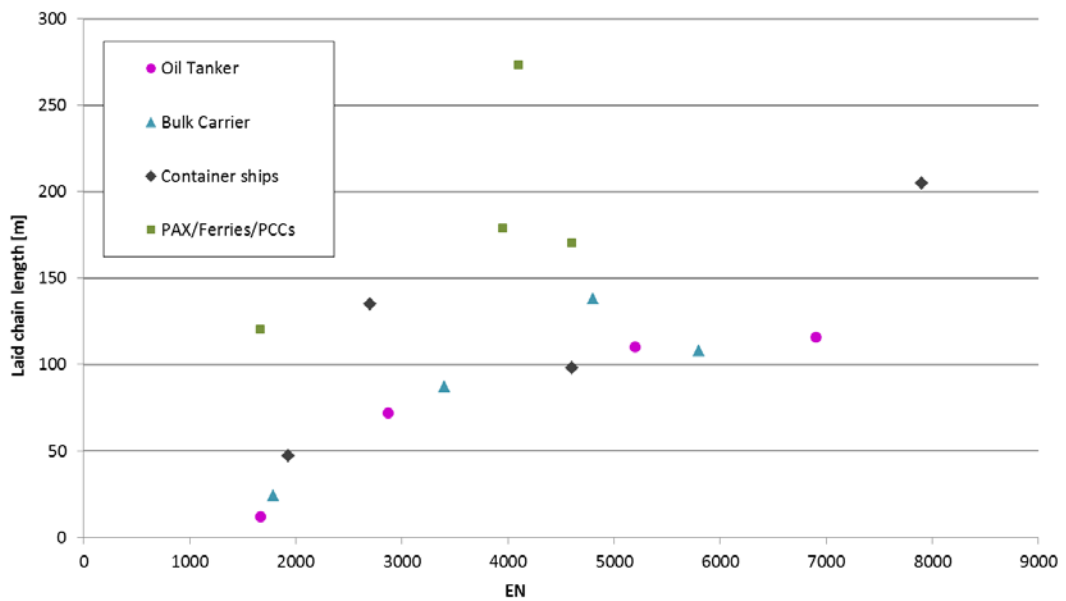
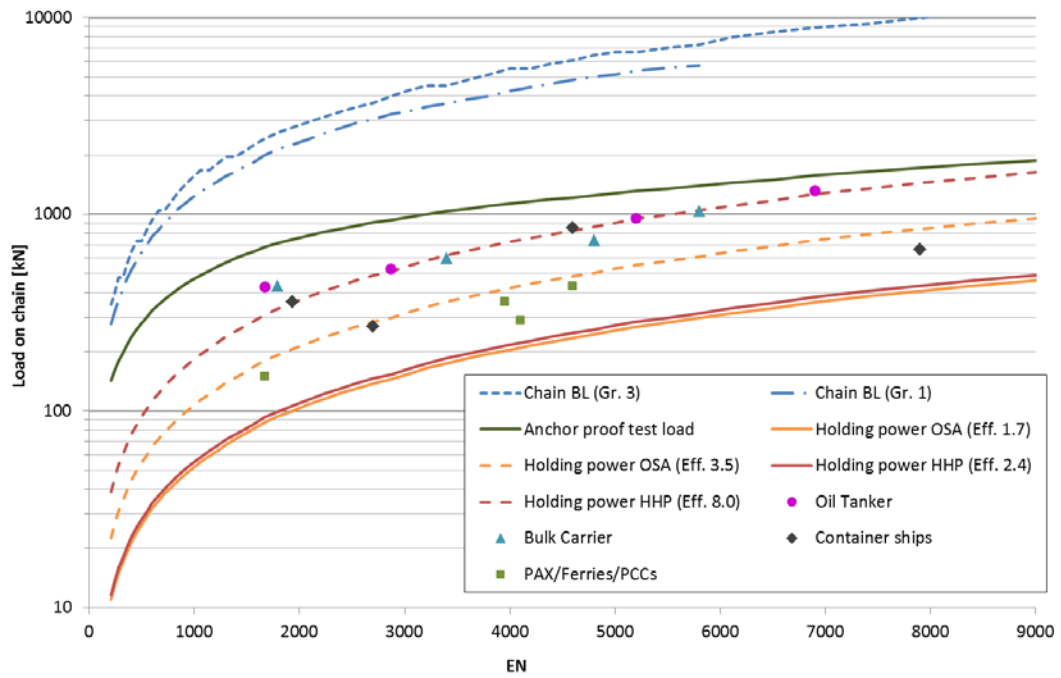
From the results it can be concluded that

- the required breaking strength of the chain cable is sufficient,
- the laid length is sufficient (> 0m),
- the holding power of HHP anchors is sufficient in good holding ground,
- the holding power of OSA is sufficient for slender ships like the assessed container ships, PAX, Ferries, and PCCs,
- the holding power of OSA even in good holding ground is insufficient for the blunt vessels, i.e., tankers and bulk carriers.

It needs to be observed that the chain cable tension at the anchor can be up to 30% less than the maximum chain cable tension, however, for blunt ships using OSA, anchor dragging may need to be expected for more benign environmental conditions than given in A1.1.4., i.e. already for combinations of wind speeds beyond 20m/s and current speeds beyond 2 m/s. Thus, it is recommended to choose HHP anchors for ships with high block coefficients, as e.g. oil tankers and bulk carriers.

Similar results were found for shallow water according to case a), ii).

The results for the maximum calculated chain cable tensions and minimum laid length for b) are shown below over the Equipment Number EN. The results for the chosen environmental conditions, compared to the limit curves of the anchor holding power and proof test load are similar to those for case a). Irrespective of the reduced chain cable tensions at the anchor, for the blunt ships but also for two of the assessed container ships, OSA do not provide sufficient holding power and dragging may be expected for more benign conditions than stated. Thus, it is recommended to choose HHP anchors for ships intended to be anchored under the given environmental conditions including wave loads.



According to the performed anchoring calculations, the required anchoring equipment is subject to the following limitations:

- Wind, current, and waves from ahead and in the same direction.
- No strong yaw and sway motions of more than  $\pm 10$  degrees, even of low frequency.
- Water depth to draught ratio not less than 1.5.

For water depth to draught ratios between 1.5 and 3, the maximum possible scope of chain cable should be provided. Disregarding these limitations may increase the loads on the anchoring equipment, and anchor dragging is to be expected under more benign environmental conditions than assumed.

If the anchoring equipment should be applicable for higher wind or current speed, the following means may be taken:

- Use HHP anchor with a weight as required for an OSA according to UR A1
- Provide longer chain cable
- Provide heavier chain cable for the shot of cable connected to the anchor

#### **A1.2. Equipment number and anchoring equipment table**

The required number of bower anchors as given in Table 1 was changed to two instead of three because the requirement for a third anchor was already left to the discretion of the individual class society in A1.4.2 of UR A1 Rev. 5.

#### **A1.5. Chain cables for bower anchors**

Chain cable may be replaced by wire ropes for both bower anchors for ships below 40 m in length instead of only for one of the two bower anchors for ships between 30 m and 40 m in length. An additional condition was added to UR A1, requesting all surfaces being in contact with the wire to be rounded with a radius of not less than 10 times the wire rope diameter, including the stem, to reduce the risk of damage to the ropes. This change was performed to align IACS member class requirements with respect to wire ropes for anchors and avoid reservations to this provision.

#### **A1.7. Hull supporting structure of anchor windlass and chain stopper**

This section was included as hull supporting structure of anchor windlass and chain stopper was not regulated by IACS but considered as gap with respect to UR A2 that imposes requirements for substructures of towing and mooring fittings and mooring winches. The given requirements are aligned with requirements in IACS Common Structural Rules for Bulk Carriers and Oil Tankers.

## Technical Background (TB) document for UR A1 (Rev.7 Sep 2020)

### 1. Scope and objectives

The increase of the funnel size due to the installation of equipment such as SOx scrubbers has been noticed on recent constructions. Funnels whose breadth exceeds B/4 is also more frequent. One Hull Panel Member raised this topic and proposed to study this issue. UR A1 had been reviewed and updated to treat those funnels in calculation of the Equipment Number (EN) specified in UR A1.2.1.

### 2. Numerical Calculation examples and comparison based on real cases

Ship Type	L x B x D (m)	EN present	EN modified	Differential	Efficient
Feeder	170.0 x 28.00 x 14.00	2,800	2,839	39	No change
Post- Panamax CNC	300.0 x 46.00 x 25.00	6,600	6,664	64	No change
Post Panamax CNC	350.0 x 50.00 x 30.00	7,350	7,420	70	Up grade
Panamax BC	220.0 x 32.20 x 20.00	3,500	3,545	45	No change
VLOC	300.0 x 55.00 x 25.00	6,070	6,147	77	Up grade
Oil/Chemical	140.0 x 25.00 x 13.00	1,400	1,475	75	No change
VLCC	325.0 x 65.00 x 29.00	7,390	7,481	91	Up grade

### 3. Summary of Changes intended for the revised requirements

UR A1 has been reviewed and updated with respect to the calculation of EN with the funnels whose breadth is exceeding B/4 in the transverse section of the ship.

The following principles have been agreed by the Hull Panel:

- When the breadth of the funnel exceeds B/4, its front and side projected areas are considered in the EN calculation.
- In case of several funnels, the total breadth of the funnels is considered.

#### Front Area:

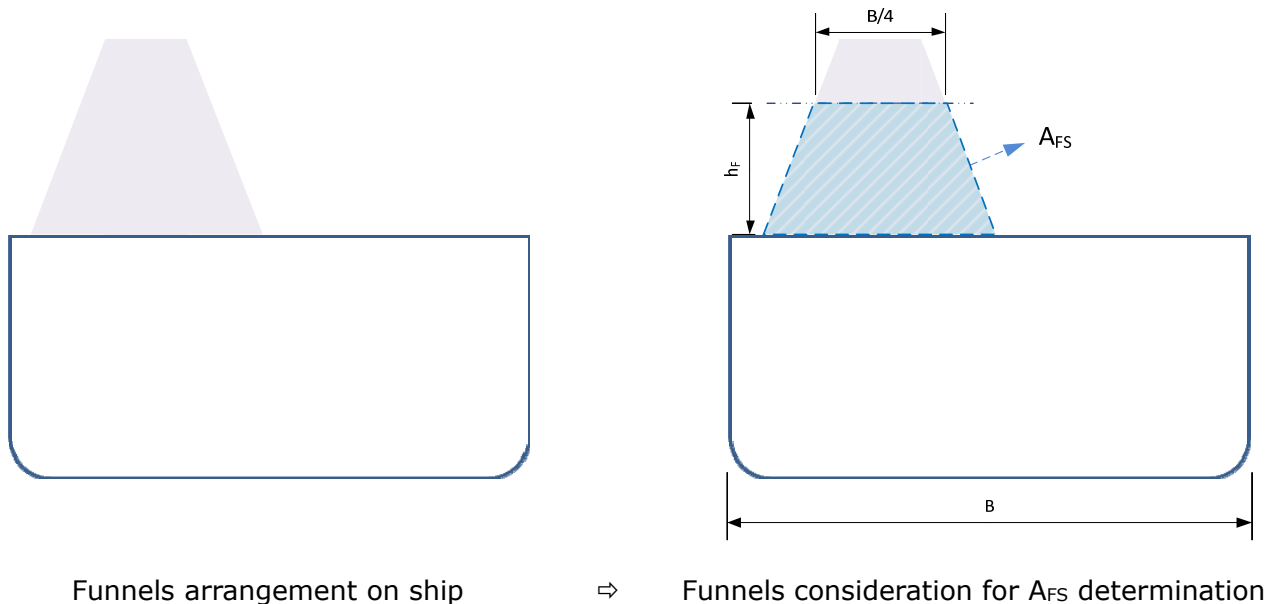
The funnel is usually located at the aft part of the ship, behind the accommodation. The same area shall not be accounted twice in the total front area, in the accommodation deck surface on one hand and in the funnel's areas on the other hand.

The shielded area of the accommodation  $S_{shield}$  is removed from the funnel area,  $A_{FS}$ , for obtaining the effective funnel area,  $S_{fun}$ :  $S_{fun} = A_{FS} - S_{shield}$

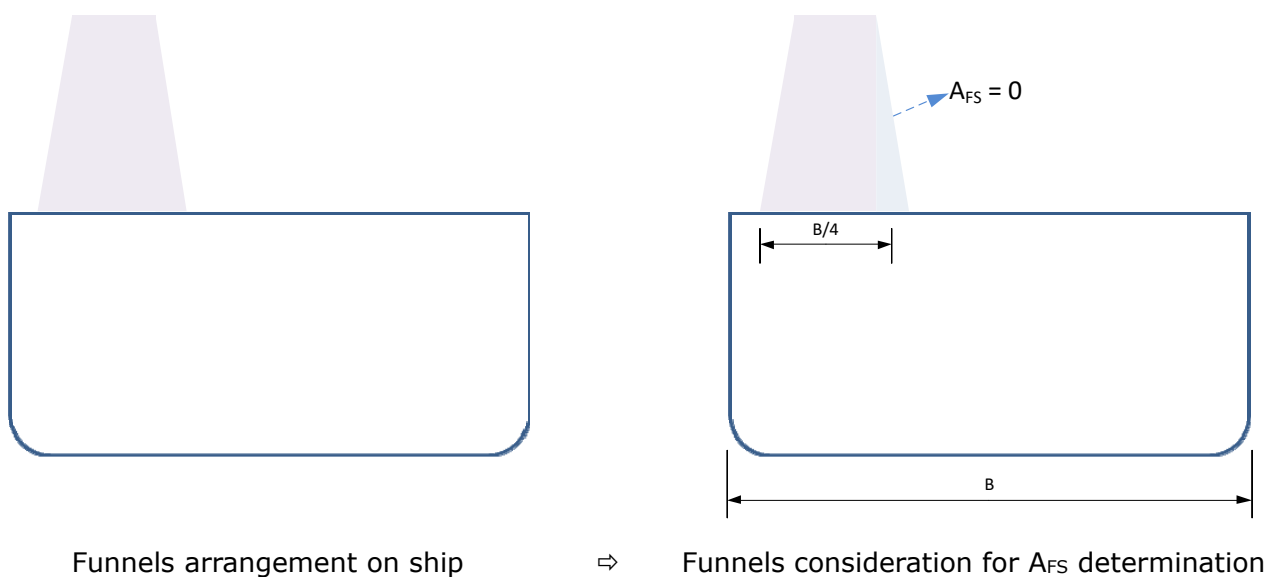
$S_{fun}$  is not to be taken less than zero.

Funnel area  $A_{FS}$ :

For single funnel,  $A_{FS}$  is estimated up to the  $h_F$  level obtained when the funnel breadth reaches  $B/4$ .



*Figure 1:  $A_{FS}$  determination for a single funnel*



*Figure 2: Funnel with breadth less than  $B/4$*

The following figure provides an example with the tiers no. 1 and 3 larger than  $B/4$  but the tier no.2 less than  $B/4$ . The shield areas are only considered for the tiers 1 and 3. There is no shield area for the tier 2. For tiers 1 and 3, the shields areas are calculated considering the tier breadth equivalent to  $B$

The effective height is limited when the funnel breadth reaches  $B/4$ .

The effective funnel area in green is obtained by the  $S_{shield1}$  and  $S_{shield2}$  from  $A_{FS}$  in blue:

$$S_{fun} = A_{FS} - S_{shield} = A_{FS} - (S_{shield1} + S_{shield2})$$

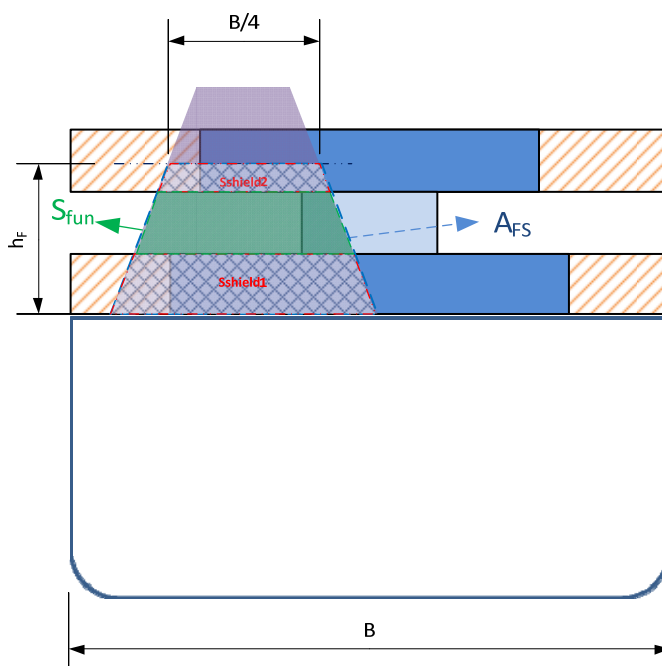
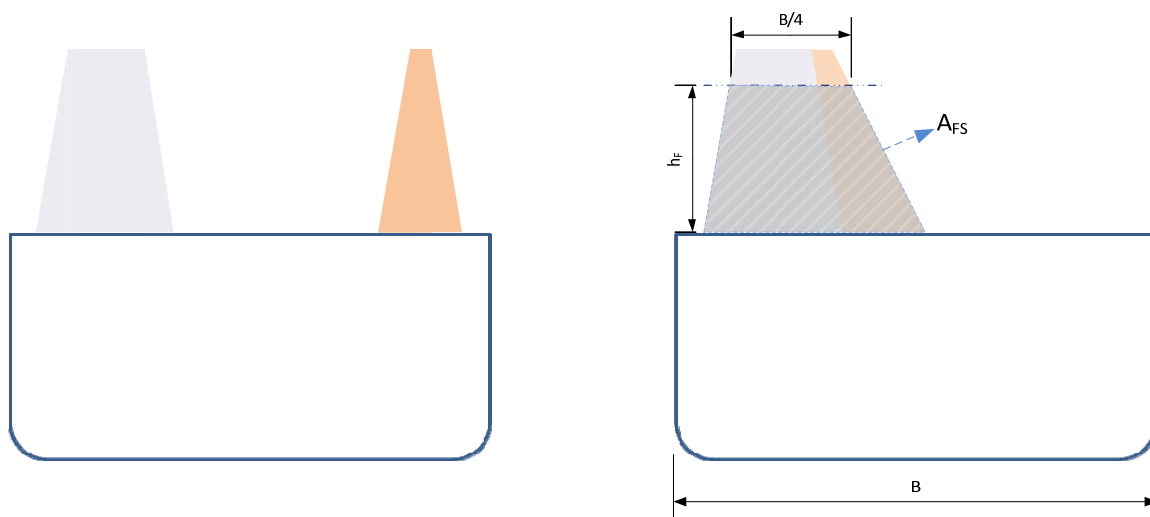


Figure 3: Example of  $A_{FS}$  and  $S_{fun}$  determination

When several funnels are arranged on the ship, the funnel area is estimated from the total breadth of all funnels fitted on the ship.

The resulting front shape area of the funnels,  $A_{FS}$ , may be limited below the level of the effective height of the funnels, i.e. the height where the total breadth of the funnels reaches  $B/4$  as shown in the following figures.



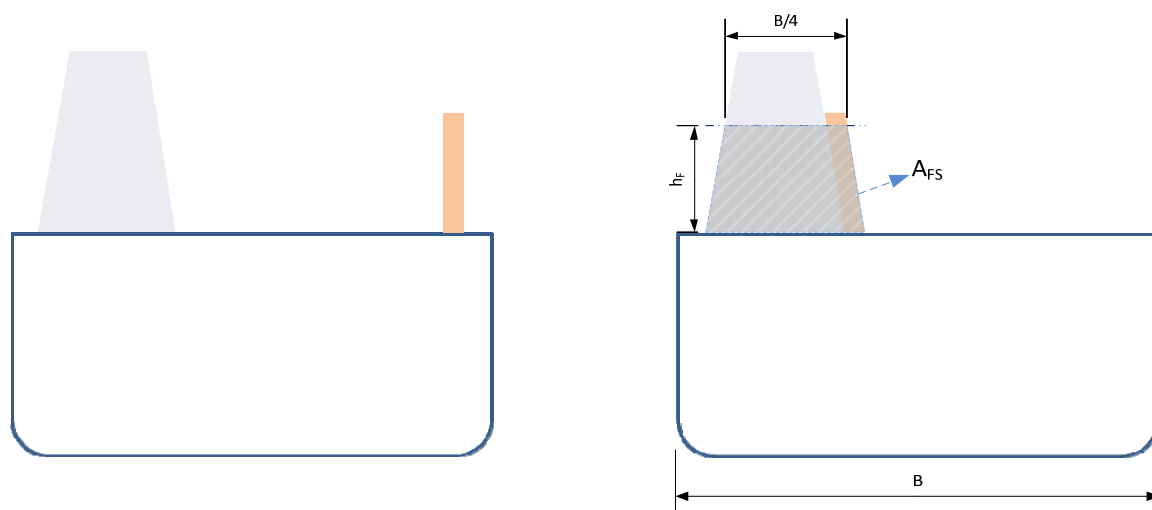
Funnels arrangement on ship

⇒

Funnels consideration for  $A_{FS}$  determination

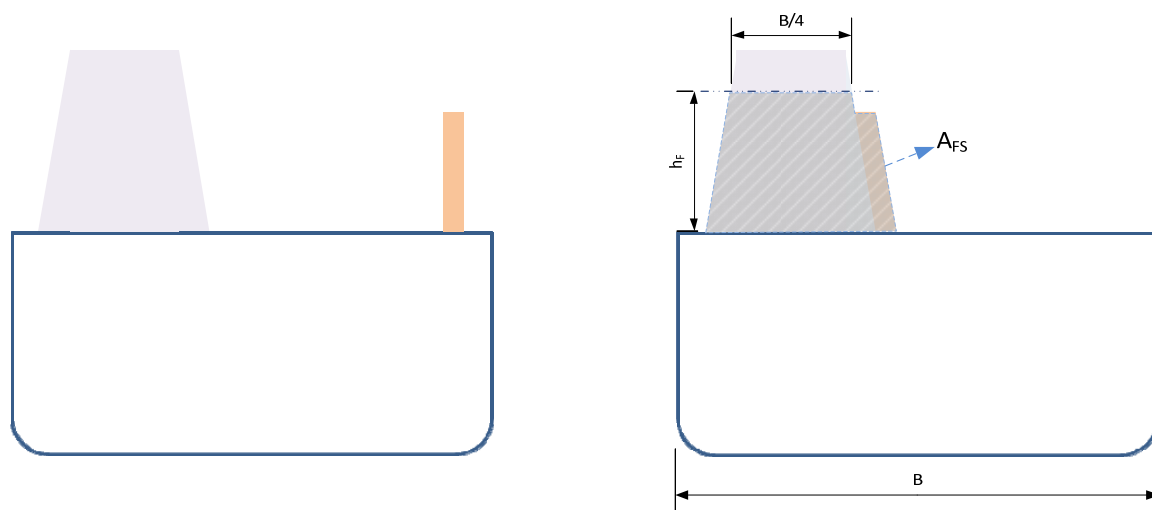
Figure 4: Two funnels case: same height - different breadths





Funnels arrangement on ship ⇒ Funnels consideration for  $A_{FS}$  determination

*Figure 5: Two funnels case:  $B/4$  breadth below the top of the smaller funnel*



Funnels arrangement on ship ⇒ Funnels consideration for  $A_{FS}$  determination

*Figure 6: Two funnels case:  $B/4$  above the top of the smaller funnel*

When the total breadth of the resulting front shape of the funnels is less than or equal to  $B/4$ , the area of the funnels may be disregarded ( $A_{FS} = 0$ ).

Shield area  $S_{shield}$ :

The total shield area  $S_{shield}$  is the sum of all shielded areas  $S_{shield i}$  of the accommodation deck "i" having a breadth greater than  $B/4$  and overlapping the front shape area of the funnels,  $A_{FS}$ .

The shield area,  $S_{shield i}$  of the accommodation deck "i" having a breadth greater than  $B/4$ , is the common area between the  $h_i \cdot B$  and the front funnels area as shown in UR A1 Figure 2.

Accommodation decks having a breadth less than or equal to  $B/4$  are not considered in

$S_{shield}$ .

#### Effective funnel area $S_{fun}$ :

The effective funnel area,  $S_{fun}$ , is obtained by deducing the shielded area of all the accommodation decks "i" considered in the h calculation (i.e. having a breadth less than or equal to B/4) from the front shape area of the funnel,  $A_{FS}$ :

$S_{fun}$  is defined as:

$$S_{fun} = A_{FS} - \sum_i S_{shield\ i} \text{ without being less than zero}$$

#### **Side projected area**

The funnel whose breadth is exceeding the B/4 is incorporated in "A", the ship side projected area calculation.

The funnel which reaches a breadth smaller than B/4 is disregarded in the ship side projected area. The funnel part above the effective height of the funnel,  $h_F$ , may be disregarded in the determination of "A".

When the ship is fitted with 2 or more funnels, the resulting global side projected area of the funnels is to be included in the side projected area calculation of the ship when  $A_{FS}$  is greater than zero.

The shielding effect of funnels is to be considered for the side projected area. A funnel may shield another one which is not to be accounted in this side area. If 2 funnels are fitted symmetrically as per the ship centerline axis, the side projected area corresponds to one funnel only and is considered if  $h_F > 0$ . For instance, when two funnels of the same dimensions are fitted symmetrically as per the ship centreline axis, the global side projected area of these 2 funnels may be taken as the area of one single funnel only.

The resulting side projected area of the funnels may be accounted if the funnels are not fitted symmetrically as per the ship centerline axis.

#### **4. Attachments if any**

---

## **Technical Background (TB) document for UR A1 (Rev.8 June 2023)**

### **1. Scope and objectives**

The present text of UR A1 contains general requirements for all types of ships. For fishing vessels and smaller ships with EN lower than 205 but greater than 50 operating in unrestricted service, the anchoring equipment is not covered by UR A1 but may be defined by IACS recommendation No. 10. UR A1 has been reviewed and updated to clarify the application for smaller ships and to deal with reservations of IACS member society against parts of UR A1.

For further information, see Attachment 1.

### **2. Engineering background for technical basis and rationale**

See Attachment 1.

#### **2a. Specification of the data utilised in the development/revision of the proposed IACS Resolution, if any**

None.

### **3. Source/derivation of the proposed IACS Resolution**

See Attachment 1.

### **4. Summary of Changes intended for the revised Resolution:**

See Attachment 1.

### **5. Points of discussions or possible discussions**

See Attachment 1.

### **6. Attachments if any**

See Attachment 1.

# Attachment 1 to Technical Background for UR A1 (Rev.8 June 2023)

## A1.1 Design of the anchoring equipment

### A 1.1.7

The requirements given in UR A1 regarding the strength of anchoring equipment are based on normal anchoring conditions, i.e., temporary anchoring of a ship within a harbour or sheltered area when the ship is awaiting berth. But ship safety also depends on anchoring equipment, especially in emergencies. Therefore, anchoring equipment shall be installed onboard and ready for use for ships that are not intended for regular anchoring operations.

### A1.1.8

This paragraph clarifies the application of UR A1, which depends on the ship size and type. The application is based on general IACS's scope (IACS GENERAL PROCEDURES, vol.1, A2) and IACS members' practices.

### A1.1.9

This paragraph clarifies the requirements given in UR A1 applicable for vessels with restricted service areas:

- A1.4.3 The bower anchors are to be connected to their cables and positioned on board ready for use.
- A1.4.4 Proof testing of anchors,
- A1.4.5 SHHP anchor material selection and toughness,
- A1.4.6 Fabricated anchors,
- A1.5.2 Grades of chain cables,
- A1.5.3 Proof and breaking loads of stud link chain cables,
- A1.6 Permissible wear down of stud link chain cable for bower anchors,
- A1.7 Supporting hull structures of anchor windlass and chain stopper

### A1.1.10

The definition of "unrestricted service" is based on IACS Rec.99. If the anchoring equipment is not designed for unrestricted service, the service restrictions shall be reflected in the vessel class notation.

## A1.2 Equipment number and anchoring equipment table

### A 1.2.4

This change was performed to align with IACS member class requirements. According to IACS UR A1, anchoring equipment is selected based on equipment number calculation. An alternative methodology based on forces of current and wind on the ship is introduced for ships with length less than 90m. This alternative methodology is described in Appendix B of IACS Recommendation 10.

### **A1.3 Anchoring equipment for tugs and dredgers**

#### **A1.3.1 Equipment for tugs**

The changes to IACS UR A1 are intended to provide unified anchoring requirements for towing vessels for unrestricted service and eliminate IACS member reservation on anchoring requirements for towing vessels for unrestricted service.

The revised requirements consider the feedback from ship owners and operators based on the satisfactory long service history of towing vessels fitted with a set of one anchor and chain.

Considering the unique operational profile for tugs constructed for towing service where the towing vessels are designed for unrestricted service, the typical towing vessels operate near a harbour or coastal area for the intended towing service. If there is damage to the temporary anchoring system, the towing vessel will be able to return to the home port to replace it promptly.

#### **A1.3.2 Equipment for dredgers**

Dredgers with an unusual design of the underwater part of the hull are to be covered by EN number equipment calculation. Consequently, direct force calculations for anchoring equipment described in appendix B of Rec. 10 are not applicable for such ships.

#### **A1.5 Chain cables for bower anchors**

This change was performed to align IACS member class requirements. Wire rope may replace chain cable for both bower anchors for ships below 90 m in length, which are not intended for regular anchoring. No length limitation is given to vessels with the anchoring equipment used for positioning with a minimum of 4 points anchoring, e.g., for cable or pipe laying. The requirements apply to bower anchors only.

An additional condition was added, requiring the anchor weight to be increased by 25% compared to anchors associated with chain cable, according to Table 1. The increased weight of the anchor (25%) and the wire cable length (50%) provide equivalent anchoring capabilities concerning horizontal pull force. The weight of the wire cable is 4-8 times lower than a chain cable of equal strength. It requires wire length to be approximately 2-3 times the chain cable to obtain equilibrium in static force analysis (catenary equations in anchor cable extending between the ship's hawse pipe and the anchor shank). In the same conditions, a shorter wire cable (1.5 times the chain cable) increases the angle between the cable and the seabed, resulting in a drop of anchor holding power. The increase in anchor weight compensates for that loss.

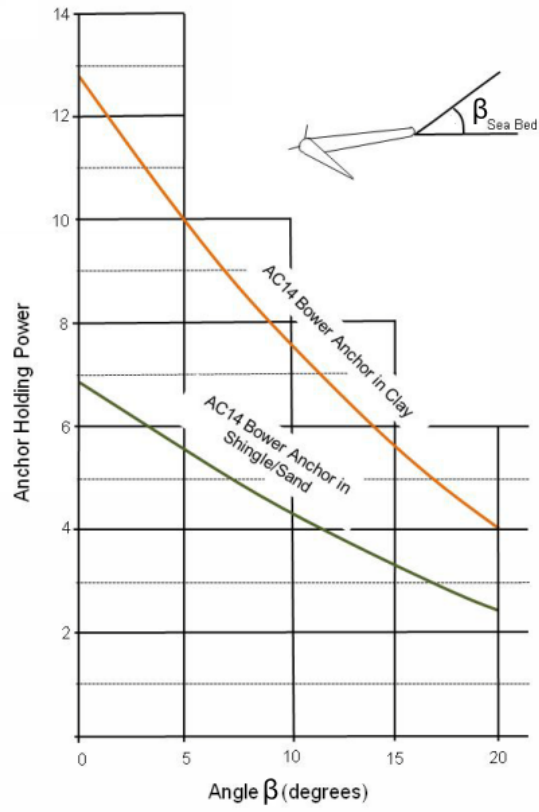


Figure 1: Relationship between anchor holding power and chain cable angle with seabed,  $\beta$

## UR A2 “Shipboard fittings and supporting hull structures associated with towing and mooring on conventional ships”

### Summary

This revision clarifies the determination of deck cargoes side projected area and introduces the guidance of meshing size for strength assessment by means of finite element analysis in line with coarse mesh criteria as commonly adopted in FEA.

### Part A. Revision History

Version no.	Approval date	Implementation date when applicable
Rev. 5 (Sep 2020)	25 September 2020	1 January 2022
Corr.2 (Mar 2017)	15 March 2017	1 July 2018
Corr.1 (Dec 2016)	-	-
Rev.4 (Oct 2016)	31 October 2016	1 January 2018
Corr.1 (Sept 2014)	09 September 2014	-
Rev.3 (July 2007)	10 July 2007	1 January 2007
Rev.2 (Sept 2006)	06 September 2006	1 January 2007
Rev.1 (July 2004)	05 July 2004	-
Corr.1 (Feb 2004)	20 February 2004	1 January 2005
New (Jan 2004)	09 January 2004	-

- **Rev.5 (Sep 2020)**

**.1 Origin for Change:**

- Request by non-IACS entity
- Suggestion by IACS Member

**.2 Main Reason for Change:**

IACS Member and Industry identified the necessity to clarify the determination of deck cargoes side projected area in note 1 of paragraphs UR A.2.1.3 and A.2.2.3.

Additionally, an IACS Member highlighted the differences in the approaches adopted in the UR A1 and A2.

In UR A1.7.3, the stresses of hull supporting structure of anchor windlass and chain stopper are to be computed using a gross thickness approach including its corresponding loads and criteria while in UR A2.1.5 and A2.2.5 a net thickness approach using its corresponding loads and criteria is requested.

Also, changes were made to align the text of UR with draft MSC.1/Circ.1175/Rev.1 (refer Annex 2 of SDC 6/13) approved by MSC 101 (refer para 12.9 of MSC 101/24).

**.3 List of non-IACS Member Classification Societies contributing or participating in IACS Working Group:**

None

**.4 History of Decisions Made**

The determination of the deck cargoes side projected area in note 1 of paragraphs A.2.1.3 and A.2.2.3 have been clarified through the definition of the loading condition to be considered. The side projected area of deck cargoes should be taken as given by the ship nominal capacity condition. See separate TB.

The guidance of meshing size for strength assessment with finite element analysis is provided in A2.1.5 and A2.2.5. The modified sentence "...a mesh size equal to the stiffener spacing is generally acceptable, and the mesh is to be fine enough to represent the geometry as realistically as possible." is referred from 1-7-2/2.4.2 (e) and 1-7-2/2.4.2 (f) of CSR-H.

**.5 Other Resolutions Changes**

UR A1 & Rec 10.

**.6 Any hinderance to MASS, including any other new technologies:**

None

**.7 Dates:**

Original Proposal: 17 May 2018 by Hull Panel  
Panel Approval: 27 August 2020 (Ref: 12106\_PHI)  
GPG Approval: 25 September 2020 (Ref: 12106\_IGzd)

• **Corr.2 (Mar 2017)**

**.1 Origin for Change:**

Suggestion by IACS member

**.2 Main Reason for Change:**

To modify the effective date of the UR A1, UR A2 from 1 January 2018 to 1 July 2018 in order to have a consistent effective date of a planned RCN/URCN which is to incorporate the updates made to UR A1, UR A2 and Rec. 10.

**.3 List of non-IACS Member Classification Societies contributing through the TC Forum and/or participating in IACS Working Group:**

None



#### **.4 History of Decisions Made**

None.

#### **.5 Other Resolutions Changes**

None

#### **.6 Dates:**

Original Proposal: 03 February 2017 by Hull Panel  
Panel Approval: 10 February 2017 (Ref: PH17002).  
GPG Approval: 15 March 2017 (Ref: 17022\_IGb)

#### **• Corr.1 (Dec 2016)**

##### **.1 Origin for Change:**

Other (Editorial correction identified by Hull Panel)

##### **.2 Main Reason for Change:**

Editorial correction identified by Hull Panel.

##### **.3 List of non-IACS Member Classification Societies contributing through the TC Forum and/or participating in IACS Working Group:**

None

#### **.4 History of Decisions Made**

None.

#### **.5 Other Resolutions Changes**

None

#### **.6 Dates:**

Original Proposal: 07 November 2016 by Hull Panel  
Panel Approval: 09 December 2016 (Ref: PH7011\_IHcg).  
GPG Approval: N.A.

#### **• Rev.4 (Oct 2016)**

##### **.1 Origin for Change:**

- Request by non-IACS entity
- Suggestion by IACS member

## **.2 Main Reason for Change:**

Due to recurrent incidents during mooring and towing, IACS decided to review and update Unified Requirement A2 and Recommendation No. 10 "Anchoring, Mooring, and Towing Equipment". Furthermore, IACS member comments to UR A2, Rev. 3 were addressed.

## **.3 List of non-IACS Member Classification Societies contributing through the TC Forum and/or participating in IACS Working Group:**

None.

## **.4 History of Decisions Made:**

GPG approved the initial Form A for the review of UR A1, UR A2, and Rec. No. 10 on 6 November 2009 (9633\_IGc) and a revised Form A on 8 November 2010 (10035\_IGg). The task was extended to allow for more extensive investigations and the associated Form A was approved by GPG on 23 August 2012 (12106\_IGd).

The final draft revision of UR A1 and the associated technical background document were approved by Hull Panel on 6 January 2016.

## **.5 Other Resolutions Changes:**

Recommendation No. 10 "Anchoring, Mooring, and Towing Equipment" was revised in parallel to UR A2, providing recommended strengths of mooring and tow lines, being the basis for design loads of fittings for mooring and other towing.

## **.6 Dates:**

Original Proposal: 18 September 2007 made by GPG (6111cIGb)

Panel Approval: 03 October 2016 (Ref: PH7011)

GPG Approval: 31 October 2016 (12106\_IGs)

### **• Corr.1 (Sept 2014)**

## **.1 Origin for Change:**

Suggestion by an IACS member.

## **.2 Main Reason for Change:**

To correct the reference of ISO 3913 in IACS UR A2. ISO 3913 is now withdrawn and replaced by ISO 13795.

## **.3 List of non-IACS Member Classification Societies contributing through the TC Forum and/or participating in IACS Working Group:**

None.

## **.4 History of Decisions Made:**

A GPG Member proposed the correction and approved by GPG. Permsec corrected the file and prepared a history file to record the correction.

**.5 Other Resolutions Changes:**

None

**.6 Dates:**

Original Proposal: 26 August 2014 Made by a Member  
GPG Approval: 09 September 2014 (Ref: 14141\_IGc)

- **Rev.3 (July 2007)**

Refer to the TB document in Part B.

- **Rev.2 (Sept 2006)**

Refer to the TB document in Part B.

- **Rev.1 (July 2004)**

“Contracted for Construction” statement added.  
No history files or TB document available.

- **Corr.1 (Feb 2004)**

No history files or TB document available.

- **New (Jan 2004)**

Refer to the TB document in Part B.

## Part B. Technical Background

List of Technical Background (TB) documents for UR A2:

Annex 1. **TB for New (Jan 2004)**

See separate TB document in Annex 1.

Annex 2. **TB for Rev.2 (Sept 2006)**

See separate TB document in Annex 2.

Annex 3. **Rev.3 (July 2007)**

See separate TB document in Annex 3.

Annex 4. **Rev.4 (Oct 2016)**

See separate TB document in Annex 4.

Annex 5. **Rev.5 (Sep 2020)**

See separate TB document in Annex 5.



*Note: There are no separate Technical Background (TB) documents available for Corr.1 (Feb 2004), Rev.1 (July 2004), Corr.1 (Sept 2014), Corr.1 (Dec 2016) and Corr.2 (Mar 2017).*

## UR A2 Technical Background

As a result of investigations regarding the damage caused to deck fittings by towing, IACS members have confirmed that their Rules and the regulatory bodies' standards (ISO) only provide the strength criteria for ropes, wires, fairleads, bollards, strong points, etc for anchoring and mooring. The ETA standard for emergency towing use with tankers has already been included in the Rules of members. Similarly the OCIMF has recommended towing arrangements for tankers over 20,000dwt.

In order to respond in a proper manner to the damage caused, it is necessary to analyse examples of the types of actual damage. However, owing to the time constraint and unavailability of information sources, the members were unable to look into an example of damage in depth.

Notwithstanding the above, if we accept the reasons for damage described in the Australian proposal, the following observations are made:

- Mooring fittings generally also serve as towing fittings.
- The strength of shipboard fittings for mooring is related to the required strength of the ship's mooring lines as per the regulatory bodies' standards (ISO). In the past there was no trouble because mooring force was typically higher than towing force. Now modern high-power tugs are capable of exerting towline forces that are well in excess of those exerted by tugs in services few years ago.  
Also tugboat operators may use their own towing lines, which have greater strength than mooring lines. Then it becomes difficult to predetermine working loads.

Shipbuilders have been executing reinforcement to the foundation structures that are loaded with towing forces. However these local reinforcements and strength investigations have been carried out their own way, individually, as seen in the existence of various types of foundations / construction. There are no unified standards for reinforcing the foundation of mooring fittings.

It should be noted that the Rules of some member Societies do actually prescribe local reinforcement, such as scantling-up of the foundation plate thickness for steering gear installation as well as reinforcement of foundation structure for cargo gear post

In order to increase attention to this matter by the shipping industry, we propose herewith requirements for the strength of deck fittings and tie-down structure reinforcement, for shipboard deck fittings used with tugs. Considering issues related to the safety of hull construction, it is considered better to specify a "Safe Working Load" for fittings rather than increasing scantlings specifically.

\*\*\*\*\*

1027IIGh 21/10/2003.

## Technical Background

### UR A2 (Rev.2, September 2006)

#### *“Shipboard fittings and supporting hull structures associated with towing and mooring on conventional vessels”*

#### 1. Scope and objective

Since the original UR A2 was withdrawn in 2005 reflecting the industry feedback, IACS have been receiving further industry inputs with respect to how shipboard fittings were to be designed, used and maintained for ship’s safe operation. These feedbacks were sent by shipbuilders, ship operators, tug operators and port authorities. In the meantime, MSC80 (18 to 27 May 2005) adopted MSC/Circ.1175, “Guidance on Shipboard Towing and Mooring Equipment”. The revised UR A2 was developed in line with the requirements in the MSC/Circ. 1175. The valuable comments from industry, approximately 20 organisations, are also considered and incorporated into the revision.

#### 2. Points of discussions or possible discussions

The following summarize the changes made in the revision:

1. In view of the concerns of industry about the corrosion, the revision provides the specific corrosion additions to the net thickness, on which basis all strength criteria as specified in the revision are satisfactorily complied with. The general requirements for survey after construction are also provided in order to maintain a sound structural condition under the supervision of the class. (see A2.0, A2.4 and A2.5).
2. The design loads for both towing and mooring are revised in accordance with the MSC/Circ. 1175. In addition to the specified minimum design load requirements, the revision covers a greater design load, which may be specially requested by the applicant, e.g., ship owner or ship operator. (see A2.1.3 and A2.2.3)
3. In selection of towing lines/mooring lines, it is also addressed that side projected area including maximum stacks of deck cargo is to be taken into account, of which concerns were raised by the Port of Rotterdam based on their own feasible study of mooring forces induced by the wind forces due to full stacks of deck cargoes. (see Note to A2.1.3.2 and A2.2.3.1).
4. To ensure safe towing and mooring operations, a preparation of the drawings, “towing and mooring arrangement plan” and “pilot card” for information of the operation for ship’s master and pilot respectively. (see A2.3)

#### 3. Source/ derivation of proposed requirement

Hull Panel

#### 4. Decision by voting

N.A.

#### 5. GPG Discussion

The following issues were discussed at GPG and decided upon by vote:

1. The draft UR was received from the Hull Panel without a proposed uniform application statement or date. A majority of Members agreed to the uniform application statement proposed by ABS (“contracted for construction from 1 January 2007”, with RS preferring the uniform application statement proposed by GPG Chairman (“contracted for construction after 1 July 2007”).
2. LR pointed out that there would be a gap between the contract for construction date associated with the amended UR A2 and the 1 January 2007 keel-laying date associated with the entry into force of -the revised SOLAS Reg. II-1/3-8. In order to bridge this gap, all Members agreed to task the Perm Sec to draft a simple UI of SOLAS Reg. II-1/3-8 stating that the requirements in UR A2 (Rev.2) are to be

applied for ships with a keel laying date on or after 1 January 2007. This will require Members to apply the requirements in UR A2 when acting on behalf of an Administration, unless otherwise instructed by the Administration, but provide Members additional time to implement the UR in their Rules.

**Permanent Secretariat Note [7 September 2006]:**

Following initial GPG approval, LR raised concerns that paragraph 2.2.3.1 of UR A2 refers to Recommendation 10, thus making it mandatory, and that Table 5 of Recommendation 10 specifies the number of mooring lines, whereas when it was copied into MSC/Circ.1175 the number of lines was omitted. This would mean that UR A2 could be considered as more restrictive than the Circular and thus an IACS member may be disadvantaged in comparison to a non-IACS member.

Further discussion was held by GPG members and it was agreed by all members to add a new footnote to A2.2.3.1 (and A2.1.3(2) which also refers to Recommendation 10) to clarify that Recommendation 10 is not a mandatory requirement. In addition the GPG Chairman has opened a new subject number to discuss the method of making reference to the mandatory/non-mandatory IACS and IMO Instruments in IACS mandatory Resolutions, i.e. footnote and Annex (GPG Small Group on Reference to Mandatory Resolutions, 6158).

LR was also concerned about a lack of harmonisation between UR A2 and CSR for both oil tankers and bulk carriers. Nine members (BV, KR, DNV, ABS, NK, RS, CCS, RINA and LR) agreed that this should be dealt with separately from the adoption of the draft UR A2 and that it should be considered and dealt with as rule change by PT1 and PT2 under the instruction of Hull Panel.

## **TECHNICAL BACKGROUND – Revised June 2007 (ref. 6111 IGM)**

### **UR A2 (Rev.2, September 2006)**

#### ***“Shipboard fittings and supporting hull structures associated with towing and mooring on conventional vessels”***

#### **1. Scope and objective**

Since the original UR A2 was withdrawn in 2005 reflecting the industry feedback, IACS have been receiving further industry inputs with respect to how shipboard fittings were to be designed, used and maintained for ship's safe operation. These feedbacks were sent by shipbuilders, ship operators, tug operators and port authorities. In the meantime, MSC80 (18 to 27 May 2005) adopted MSC/Circ.1175, “Guidance on Shipboard Towing and Mooring Equipment”. The revised UR A2 was developed in line with the requirements in the MSC/Circ. 1175. The valuable comments from industry, approximately 20 organisations, are also considered and incorporated into the revision.

#### **2. Points of discussions or possible discussions**

The following summarize the changes made in the revision:

1. In view of the concerns of industry about the corrosion, the revision provides the specific corrosion additions to the net thickness, on which basis all strength criteria as specified in the revision are satisfactorily complied with. The general requirements for survey after construction are also provided in order to maintain a sound structural condition under the supervision of the class. (see A2.0, A2.4 and A2.5).
2. The design loads for both towing and mooring are revised in accordance with the MSC/Circ. 1175. In addition to the specified minimum design load requirements, the revision covers a greater design load, which may be specially requested by the applicant, e.g., ship owner or ship operator. (see A2.1.3 and A2.2.3)
3. In selection of towing lines/mooring lines, it is also addressed that side projected area including maximum stacks of deck cargo is to be taken into account, of which concerns were raised by the Port of Rotterdam based on their own feasible study of mooring forces induced by the wind forces due to full stacks of deck cargoes. (see Note to A2.1.3.2 and A2.2.3.1).
4. To ensure safe towing and mooring operations, a preparation of the drawings, “towing and mooring arrangement plan” and “pilot card” for information of the operation for ship's master and pilot respectively is specified. This plan used for review/survey of shipboard fittings and supporting hull structures by classification society can be used as appropriate operation guidance for proper mooring of the vessel in line with the intent of design of deck fittings. (see A2.3)
5. To reflect the design conditions, especially for the vessel, of which deck fittings are designed based on the reduced breaking strength of mooring lines and the increased numbers of the mooring lines as permitted by the footnote of Table 5 of IACS Recommendation No. 10, the following information are to be clearly indicated on the plan:
  - .1 the arrangement of mooring lines showing number of the lines (N), together with
  - .2 the specified breaking strength of each mooring lines intended to be used (BS). (see A2.3.3)

#### **3. Source/ derivation of proposed requirement**

Hull Panel

#### **4. Decision by voting**

N.A.



## **5. GPG Discussion**

The following issues were discussed at GPG and decided upon by vote:

1. The draft UR was received from the Hull Panel without a proposed uniform application statement or date. A majority of Members agreed to the uniform application statement proposed by ABS (“contracted for construction from 1 January 2007”, with RS preferring the uniform application statement proposed by GPG Chairman (“contracted for construction after 1 July 2007”).
2. LR pointed out that there would be a gap between the contract for construction date associated with the amended UR A2 and the 1 January 2007 keel-laying date associated with the entry into force of -the revised SOLAS Reg. II-1/3-8. In order to bridge this gap, all Members agreed to task the Perm Sec to draft a simple UI of SOLAS Reg. II-1/3-8 stating that the requirements in UR A2 (Rev.2) are to be applied for ships with a keel laying date on or after 1 January 2007. This will require Members to apply the requirements in UR A2 when acting on behalf of an Administration, unless otherwise instructed by the Administration, but provide Members additional time to implement the UR in their Rules.

### **Permanent Secretariat Note [7 September 2006]:**

Following initial GPG approval, LR raised concerns that paragraph 2.2.3.1 of UR A2 refers to Recommendation 10, thus making it mandatory, and that Table 5 of Recommendation 10 specifies the number of mooring lines, whereas when it was copied into MSC/Circ.1175 the number of lines was omitted. This would mean that UR A2 could be considered as more restrictive than the Circular and thus an IACS member may be disadvantaged in comparison to a non-IACS member.

Further discussion was held by GPG members and it was agreed by all members to add a new footnote to A2.2.3.1 (and A2.1.3(2) which also refers to Recommendation 10) to clarify that Recommendation 10 is not a mandatory requirement. In addition the GPG Chairman has opened a new subject number to discuss the method of making reference to the mandatory/non-mandatory IACS and IMO Instruments in IACS mandatory Resolutions, i.e. footnote and Annex (GPG Small Group on Reference to Mandatory Resolutions, 6158).

LR was also concerned about a lack of harmonisation between UR A2 and CSR for both oil tankers and bulk carriers. Nine members (BV, KR, DNV, ABS, NK, RS, CCS, RINA and LR) agreed that this should be dealt with separately from the adoption of the draft UR A2 and that it should be considered and dealt with as rule change by PT1 and PT2 under the instruction of Hull Panel.

## TECHNICAL BACKGROUND

### UR A2 (Rev.3, July 2007)

*“Shipboard fittings and supporting hull structures associated with towing and mooring on conventional vessels”*

#### 1. Background

Following approval of UR A2 (Rev.2) in September 2006, LR proposed to amend TB in order to clarify GPG’s agreement *“to align the MSC Circular 1175 and UR A2 and introduced the note into paragraphs A2.1.3 and A.2.2.3 stating that only the breaking strengths in the Table 5 of Rec 10 are considered mandatory; the footnote to Table 5 of Rec 10 is not mandatory and thus A2 does not permit the reduction of the breaking strengths of Table 5 when the greater number of lines are used.”*

After GPG discussion in which members could not come to an unanimous decision, GPG Chair in 6111\_IGi tasked Hull Panel to answer the following:

*“For the application of the load considerations in UR A2.1.3 and A2.2.3, is there justification for accepting a reduction in the breaking strength of mooring and towing lines as permitted by the footnote to Table 5 of REC 10, in association with a corresponding increase in the number of mooring/towing lines?”*

Hull Panel agreed to the application of the footnote to Table 5 of IACS Recommendation No.10 and submitted a further revision to UR A2 to incorporate this.

#### 2. Discussion

The proposed revision to UR A2 was agreed by GPG, but there were concerns about the initial Technical Background information submitted by Hull Panel since it referred to the approval of ‘towing and mooring arrangements plans’. The technical background information was therefore resubmitted with 6111\_PHc (see Appendix 1) without reference to the approved plan, together with a revised Technical Background document for UR A2(Rev.2).

Since the revision to UR A2 (Rev.2) was made for clarification of its original intention of the requirements related to Design Load of Mooring equipment and its supporting structure, it was agreed that it should be applicable to ships with a keel laying date on or after 1 Jan 2007. It was also agreed that UI SC212 should be editorially modified to replace "UR A2 (Rev.2)" with "UR A2 (Rev.2 or Rev.3)".

#### 3. Conclusion

UR A2(Rev.3) and the revised TB for UR A2(Rev.3) were adopted on 10 July 2007 (6111\_IGo) – see also 6111\_IGm dated 6 June 2007.

Prepared by Permanent Secretariat  
July 2007

## **APPENDIX 1 - Hull Panel's Reply to GPG (attachment to 6111\_PHc)**

1. Hull Panel unanimously agrees that the footnote to Table 5 of IACS Recommendation No. 10 can be applied in determination of the breaking strength of mooring line for the application of the load consideration in UR A 2.2.3 based on the following current/additional provisions:

2. In A 2.3. "Towing and mooring arrangements plan" of the UR, it is required that "towing and mooring arrangements plan" is to be available on board for the guidance of the Master." This plan used for review/survey of shipboard fittings and supporting hull structures by member society can be used as appropriate operation guidance for proper mooring of the vessel in line with the intent of designs of deck fittings.

3. In order to reflect the design conditions, especially for the vessel, of which deck fittings are designed based on the reduced breaking strength of mooring lines and the increased numbers of the mooring lines as permitted by the footnote of Table 5 of IACS Recommendation No. 10, the following information are to be clearly indicated on the plan:

3.1. the arrangement of mooring lines showing number of the lines (N), together with

3.2. the breaking strength of each mooring line (BS)

4. HP will reflect the item 3 above into A 2.3 of the UR and submit for GPG's approval. The proposed changes to UR A2 (Rev. 2) is attached for ready reference.

## APPENDIX 2 – Revised TB for UR A2(Rev.2) (attachment to 6111\_PHc)

### Technical Background

#### UR A2 (Rev.2, September 2006)

#### *“Shipboard fittings and supporting hull structures associated with towing and mooring on conventional vessels”*

##### 1. Scope and objective

Since the original UR A2 was withdrawn in 2005 reflecting the industry feedback, IACS have been receiving further industry inputs with respect to how shipboard fittings were to be designed, used and maintained for ship's safe operation. These feedbacks were sent by shipbuilders, ship operators, tug operators and port authorities. In the meantime, MSC80 (18 to 27 May 2005) adopted MSC/Circ.1175, “Guidance on Shipboard Towing and Mooring Equipment”. The revised UR A2 was developed in line with the requirements in the MSC/Circ. 1175. The valuable comments from industry, approximately 20 organisations, are also considered and incorporated into the revision.

##### 2. Points of discussions or possible discussions

The following summarize the changes made in the revision:

1. In view of the concerns of industry about the corrosion, the revision provides the specific corrosion additions to the net thickness, on which basis all strength criteria as specified in the revision are satisfactorily complied with. The general requirements for survey after construction are also provided in order to maintain a sound structural condition under the supervision of the class. (see A2.0, A2.4 and A2.5).
2. The design loads for both towing and mooring are revised in accordance with the MSC/Circ. 1175. In addition to the specified minimum design load requirements, the revision covers a greater design load, which may be specially requested by the applicant, e.g., ship owner or ship operator. (see A2.1.3 and A2.2.3)
3. In selection of towing lines/mooring lines, it is also addressed that side projected area including maximum stacks of deck cargo is to be taken into account, of which concerns were raised by the Port of Rotterdam based on their own feasible study of mooring forces induced by the wind forces due to full stacks of deck cargoes. (see Note to A2.1.3.2 and A2.2.3.1).
4. To ensure safe towing and mooring operations, a preparation of the drawings, “towing and mooring arrangement plan” and “pilot card” for information of the operation for ship's master and pilot respectively is specified. This plan used for review/survey of shipboard fittings and supporting hull structures by classification society can be used as appropriate operation guidance for proper mooring of the vessel in line with the intent of design of deck fittings. (see A2.3)
5. To reflect the design conditions, especially for the vessel, of which deck fittings are designed based on the reduced breaking strength of mooring lines and the increased numbers of the mooring lines as permitted by the footnote of Table 5 of IACS Recommendation No. 10, the following information are to be clearly indicated on the plan:
  - .1 the arrangement of mooring lines showing number of the lines (N), together with
  - .2 the specified breaking strength of each mooring lines intended to be used (BS). (see A2.3.3)

##### 3. Source/ derivation of proposed requirement

Hull Panel

##### 4. Decision by voting

N.A.

## **5. GPG Discussion**

The following issues were discussed at GPG and decided upon by vote:

1. The draft UR was received from the Hull Panel without a proposed uniform application statement or date. A majority of Members agreed to the uniform application statement proposed by ABS (“contracted for construction from 1 January 2007”, with RS preferring the uniform application statement proposed by GPG Chairman (“contracted for construction after 1 July 2007”).
2. LR pointed out that there would be a gap between the contract for construction date associated with the amended UR A2 and the 1 January 2007 keel-laying date associated with the entry into force of -the revised SOLAS Reg. II-1/3-8. In order to bridge this gap, all Members agreed to task the Perm Sec to draft a simple UI of SOLAS Reg. II-1/3-8 stating that the requirements in UR A2 (Rev.2) are to be applied for ships with a keel laying date on or after 1 January 2007. This will require Members to apply the requirements in UR A2 when acting on behalf of an Administration, unless otherwise instructed by the Administration, but provide Members additional time to implement the UR in their Rules.

### **Permanent Secretariat Note [7 September 2006]:**

Following initial GPG approval, LR raised concerns that paragraph 2.2.3.1 of UR A2 refers to Recommendation 10, thus making it mandatory, and that Table 5 of Recommendation 10 specifies the number of mooring lines, whereas when it was copied into MSC/Circ.1175 the number of lines was omitted. This would mean that UR A2 could be considered as more restrictive than the Circular and thus an IACS member may be disadvantaged in comparison to a non-IACS member.

Further discussion was held by GPG members and it was agreed by all members to add a new footnote to A2.2.3.1 (and A2.1.3(2) which also refers to Recommendation 10) to clarify that Recommendation 10 is not a mandatory requirement. In addition the GPG Chairman has opened a new subject number to discuss the method of making reference to the mandatory/non-mandatory IACS and IMO Instruments in IACS mandatory Resolutions, i.e. footnote and Annex (GPG Small Group on Reference to Mandatory Resolutions, 6158).

LR was also concerned about a lack of harmonisation between UR A2 and CSR for both oil tankers and bulk carriers. Nine members (BV, KR, DNV, ABS, NK, RS, CCS, RINA and LR) agreed that this should be dealt with separately from the adoption of the draft UR A2 and that it should be considered and dealt with as rule change by PT1 and PT2 under the instruction of Hull Panel.

## **Technical Background (TB) document for UR A2 (Rev.4 Oct 2016)**

### **1. Scope and objectives**

Due to recurrent incidents during mooring and towing and IACS member comments to UR A2, Rev. 3, UR A2 has been reviewed and updated.

For further information see Attachment 1.

### **2. Engineering background for technical basis and rationale**

See Attachment 1.

### **3. Source/derivation of the proposed IACS Resolution**

See Attachment 1.

### **4. Summary of Changes intended for the revised Resolution**

Towing services have been clearly and, in part, newly defined. 'Other towing' has been designated as towing by another ship or a tug, e.g. such as to assist the ship in case of emergency, for the case that equipment is intended to be fitted for this.

Minimum loads have been introduced for the selection of shipboard fittings from industry standards. For shipboard fittings, not selected from an industry standard, design requirements have been introduced. For bollards and bitts, attachment points for the mooring or towing lines have been defined.

Basic requirements have been introduced for strength assessment with finite element analysis of the supporting hull structure as well as for shipboard fittings, not selected from an industry standard.

A safe towing load has been introduced next to the safe working load to better distinguish the purpose (towing or mooring) of different shipboard fittings.

The safety factor in the safe working load for mooring has been reduced to mitigate the impact on scantlings of the modified recommended strength of mooring lines for ships with Equipment Number EN > 2000 according to Recommendation No. 10, being the basis for the design load.

The safe towing load for 'other towing' has been reduced to 80% of the design load to include some safety margin, considering the newly defined purpose of 'other towing'.

Information on the acceptable environmental conditions for the recommended minimum breaking strength of mooring lines for ships with EN > 2000 has been required to be included on the towing and mooring arrangements plan and the pilot card.

The corrosion additions for ships other than CSR ships were modified to ease the survey of hull supporting structures.

A wear allowance was introduced and is to be applied to shipboard fittings, not selected from an industry standard.

See Attachment 1 for more detailed information.

## **5. Points of discussions or possible discussions**

The increase in recommended strength of mooring lines for ships with EN > 2000 according to the draft revision of Recommendation 10 may lead to scantling increase for some ships, refer to technical background of draft revision 3 of Recommendation No. 10. In the past, many ships have already been equipped with stronger and more lines than recommended by Recommendation No. 10 and the higher strength of the lines was, sometimes, sometimes not, considered for the design of fittings and supporting hull structure. Compared to the case that the higher strength of the lines was considered for the design of fittings and supporting hull structure, increase in scantlings is not, or only to a limited extent, to be expected. To mitigate the impact on scantlings, the safety factor in the safe working load for mooring has already been reduced from 1.25 to 1.15. For many smaller ships this will lead to similar or even lower scantlings than before. However, further reducing the safety factor or even reducing it below 1.0 would contradict other internationally accepted recommendations on mooring of ships, e.g., those from the Oil Companies International Marine Forum (OCIMF), refer to OCIMF Mooring Equipment Guidelines 3.

## **6. Attachments if any**

Attachment 1.

# Technical background to UR A2 (Rev.4 Oct 2016) 'Shipboard fittings and supporting hull structures associated with towing and mooring on conventional ships'

## A2.0. Application and definitions

The scope concerning towing was clearly defined and partly modified in that

- the UR is applicable to 'normal towing' defined as "towing operations necessary for manoeuvring in ports and sheltered waters associated with the normal operations of the ship",
- the UR is applicable to 'other towing' for ships intended to be fitted with equipment for towing by another ship or a tug, e.g. such as to assist the ship in case of emergency as given in SOLAS Regulation II-1/3-4 Paragraph 2 "Emergency towing procedures on ships",
- the UR is not applicable to escort towing as it is a special service in certain estuaries and typically regulated by the respective authorities,
- the UR is not applicable to canal transit towing as it is typically regulated by the respective authorities,
- the UR is not applicable to emergency towing for tankers as regulated by SOLAS regulation II-1/3-4 Paragraph 1 'Emergency towing arrangements on tankers'.

The definitions were updated in that 'special purpose ship' was defined as in MSC.266(84) as a mechanically self-propelled ship which by reason of its function carries on board more than 12 special personnel.

## A2.1. Towing

### A2.1.3. Load considerations

As the purpose of 'normal towing' and 'other towing' is clearly defined in A2.0, references to the purpose of the towing operations were deleted in A2.1.3.

For 'normal towing' it should be observed that increasingly tugs are in service that have static bollard pull of up to 80 t. The joint 'Guidelines on Design and Layout of Harbour Towing Equipment' of the European Tugowners Association and the European Maritime Pilots' Association recommend observing this for the design of towing equipment for normal towing. For towing fittings providing considerably lower strength the risk for overloading may be increased.

Design loads for 'other towing' were maintained for ships, not subject to SOLAS regulation II-1/3-4 Paragraph 1, but intended to be fitted with equipment for towing by another ship or a tug, e.g. such as to assist the ship in case of emergency as given in SOLAS Regulation II-1/3-4 Paragraph 2. It is to be observed that it is not mandatory to equip ships, not subject to SOLAS regulation II-1/3-4, with fittings designed for 'other towing'. However, in IACS Recommendation No. 10 'Anchoring, Mooring, and Towing Equipment', 2.5.2 it is recommended to provide towing arrangements fore and aft of sufficient strength for 'other towing' service.

A provision was added, giving the design load to be applied in case of the fitting is intended to be used for, both, 'normal towing' and 'other towing' operations. In this case the design



load is not to be less than the greater of the design loads for 'normal towing' and 'other towing'.

The Note in A2.1.3 was partly deleted as A2.1.3 2) clearly requires applying the minimum breaking strength of the tow line according to Rec. No. 10 to determine the design load for 'other towing'. Furthermore, the Note was reformulated. Side projected areas are required to be taken into account "*including that of deck cargoes as given by the loading manual*" instead of "*maximum stacks of deck cargoes*" in order to account also for deck cargo other than container stacks. A second Note was added, stating that "*the increase of the minimum breaking strength for synthetic ropes [...] needs not to be taken into account for the loads applied to shipboard fittings and supporting hull structure*" because this increase is related to aging and wear and, in case of polyamide, also allows for strength loss when wet.

A2.1.3 requires that the "*the design load is to be applied to fittings in all directions that may occur by taking into account the arrangement shown on the towing and mooring arrangements plan*". This provision shall ensure that not only the intended line leads as shown in the arrangement plan are considered for the application of the design load to a fitting but also other line leads if deemed possible as well as realistic based on the given arrangement.

#### **A2.1.4. Shipboard fittings**

Minimum load assumptions were added for the selection of shipboard fittings from industry standards, similar to the design loads given by A2.1.3. This ensures that the chosen fittings provide similar load capacity as the hull supporting structure and similar safety margins in TOW and SWL.

A2.1.4 allows for choosing towing bits (double bollards) explicitly for the towing rope attached with eye splice, which is the usual method in towing. This is possible if the industry standard distinguishes between different methods to attach the line, e.g. as the ISO standard for welded steel bollards (ISO 13795). Some standards for double bollards (e.g. JIS) provide information on maximum applicable rope tension irrespective of the method of application of the rope. In these cases, the bollard is to be selected based on these applicable rope tensions which are considered to be designed for, both, the line attached with eye splice as well as the line applied in figure-of-eight fashion.

More specific requirements were included for shipboard fittings not selected from an accepted industry standard, concerning the acting point of the towing force, allowable stresses, analysis methods, net scantling approach, as well as corrosion additions and wear allowance. It was allowed for load tests as alternative to strength calculations at the discretion of the classification society.

#### **A2.1.5. Supporting hull structure**

A sketch of a sample arrangement of reinforced members beneath shipboard fittings was added to the UR and it was pointed out that proper alignment of fitting and supporting hull structure is to be ensured. This is to put more focus on the effective arrangement of supporting hull structures and its alignment with the on deck structure, which is important to ensure structural behaviour in line with the design calculations. Several damage cases reported in the past can be related to ineffective structural reinforcement and alignment.

The acting point of the towing force on shipboard fittings was specified in detail for bollards and bits to be taken not less than 4/5 of the tube height above the base. This requirement is aligned with ISO 13795 "Welded steel bollards for sea-going vessels".

An allowable equivalent stress was introduced for strength assessment with finite element analysis equal to 100% of the specified minimum yield point of the material. Furthermore, basic modelling guidance for finite element analysis was added to A2.1.5. The basic mesh requirements for FE models are considered to yield stresses comparable to those calculated by beam theory calculations.

#### **A2.1.6. Safe Towing Load (TOW)**

A2.1.6 was modified in that it defines a safe towing load TOW as the load limit for towing purpose instead of a safe working load SWL in order to make the intended use of the fittings visible. The SWL is retained as marking of fittings intended for mooring purpose. This serves the purpose of preventing wrong operation as there are different safety factors for mooring and towing operations and, in particular, different typical attachment methods of the rope to double bollard with respect to mooring and towing operations. Double bollards for towing purpose may be selected for the rope attached with eye-splice (e.g. possible with ISO standard for welded steel bollards, ISO 13795) which, however, could lead to damage of the fitting when used with a rope attached in figure-of-eight fashion, as this attachment method can subject either of the two posts to a force twice as large as that from a rope attached with eye splice. If fittings are intended to be used also for mooring, the provisions for mooring according to A2.2 are to be observed and SWL is to be marked to the fitting in addition to TOW. In this case double bollards are to be selected to also resist the loads from mooring for the rope attached in figure-of-eight fashion. Thus, TOW and SWL as dedicated markings for towing and mooring purpose, respectively, are intended to make the use of double bollards safer as clear load limits are marked with respect to the different methods of attaching the rope to the fitting.

As in UR A2 Rev. 3, the design load for 'other towing', given by A2.1.3 (2), is equal to the minimum breaking strength of the tow line according to Rec. No. 10. However, in A2.1.6 3) TOW for 'other towing' is limited to not exceed 80% of the minimum breaking strength of the tow line. This aligns the safety factor included in the marked TOW with that of fittings for 'normal towing'. For the purpose of towing to assist the ship in case of emergency, it is considered necessary to include some additional margin. UR A2 Rev. 3 considered fittings for other towing to be used with the ship's own tow line that was expected to break under a load equal to its MBL. However, today it is to be expected that such towing in most cases will be performed by tugs using their own lines which have high safety factors and, thus, high strength that is likely to exceed the strength of shipboard fittings for 'other towing'. The towing line cannot be expected to break before the fitting.

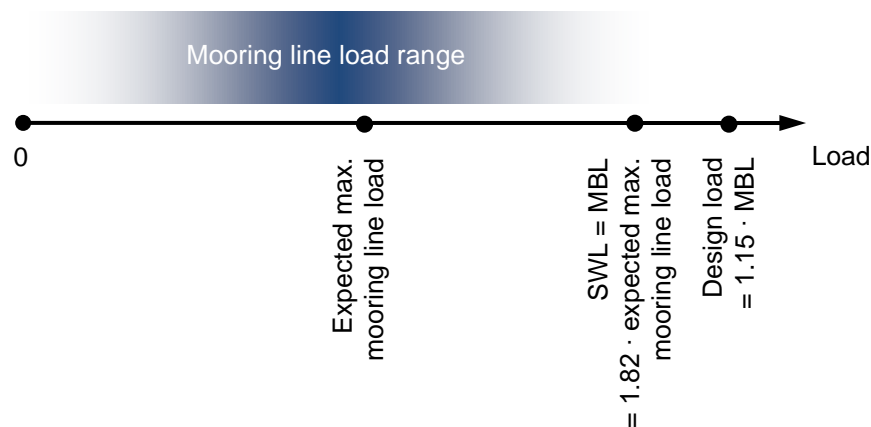
A2.1.6 6) requires to mark TOW (and SWL in case the fitting is intended to be used for, both, towing and mooring) in 't' (tonnes) on the fittings. This has not been defined in UR A2 Rev. 3. The unit 't' was confirmed by industry representatives as typical and preferable unit for the marking of deck fittings. Also, OCIMF recommends using this unit for marking of the load limit. Reasons are that this unit is commonly used, e.g., as load limit for lifting appliances and that the unit 'kN' could be confused with 't', which may result in considerable overload as a load in 'kN' is equivalent to about ten times a weight in 't'.

### **A2.2. Mooring**

#### **A2.2.3. Load considerations**

In A2.2.3 1) the safety factor in the design load for hull supporting structures of mooring fittings was modified in consequence of the revision of recommended mooring lines in Recommendation No. 10 where more advanced methods for the selection of mooring lines were introduced for ships with EN > 2000. To partly mitigate the impact of the new recommended line strength on the mooring equipment of ships with EN > 2000 the safety factor in the design load was reduced from 1.25 to 1.15. However, the MBL of the lines,

being the design load basis, also include safety margins with respect to the expected load level for the considered environmental conditions, i.e. for ships with EN > 2000 a factor of 1.82 is contained in the recommended MBL. The typical relation of the expected maximum mooring line load for the considered environmental conditions, MBL, SWL, and design load is shown in the figure below. To not reduce the standard compared to the UR A2 Rev. 3, the recommended mooring line strength for ships with EN ≤ 2000 was increased in Recommendation No. 10 by a factor of 1.25/1.15.



Note 1 was reformulated such that side-projected areas are required to be taken into account *“including that of deck cargoes as given by the loading manual”* instead of *“maximum stacks of deck cargoes”* in order to account also for deck cargo other than container stacks. A new Note 2 was added, stating that *“the increase of the minimum breaking strength for synthetic ropes [...] needs not to be taken into account for the loads applied to shipboard fittings and supporting hull structure”* because this increase is related to aging and wear and, in case of polyamide, also allows for strength loss when wet. Note 3 was deleted as not applicable anymore to Recommendation No. 10 Rev. 3. The former Note 2 and Note 4 were also deleted as A2.2.3 1) clearly requires applying the minimum breaking strength of the mooring line according to Recommendation No. 10 to determine the design load.

In A2.2.3 2) the design load for supporting hull structures for winches was modified. The intended maximum brake holding load of winches is required to be assumed not less than 80% of the minimum breaking load (MBL) of the mooring line according to the Recommendation No. 10. As the design load is defined as 1.25 times the intended maximum brake holding load, then the minimum design load is equal to the MBL of the mooring line. This was added because the brake holding load is considered unreliable for winches with certain brake types and when the brake holding load is not tested and adjusted on a regular basis. Over-tightened winch brakes but also other circumstances may subject the winch to the full MBL of the mooring line. This was confirmed by industry representatives and is in line with OCIMF ‘Mooring Equipment Guidelines’.

A2.2.3 4) requires that *“the design load is to be applied to fittings in all directions that may occur by taking into account the arrangement shown on the towing and mooring arrangements plan”*. This provision shall ensure that not only the intended line leads as shown in the arrangement plan are considered for the application of the design load to a fitting but also other line leads if deemed possible as well as realistic based on the given arrangement.

#### **A2.2.4. Shipboard fittings**

Refer to A2.1.4 for similar modifications. Other than in A2.1.4, mooring bitts (double bollards) are required to resist the loads caused by the mooring rope applied in figure-of-eight fashion, being the standard method and which can subject either of the two posts to a force twice as large as that from a rope attached with eye splice.

#### **A2.2.5. Supporting hull structure**

Refer to A2.1.5 for similar modifications. The acting point of the mooring force on shipboard fittings was also specified in detail for bollards and bitts to be taken 4/5 of the tube height above the base. Different from towing, if fins are fitted to the bollard tubes to keep the mooring line as low as possible, the attachment point of the mooring line may be taken at the location of the fins. Except for the latter, this requirement is aligned with ISO 13795 "Welded steel bollards for sea-going vessels".

#### **A2.2.6. Safe Working Load (SWL)**

In A2.2.6 2) the SWL was modified to "*not exceed the MBL of the mooring line according to Recommendation No. 10*" instead of "*80% of the design load per A2.2.3*". This is because the safety factor in the design load for mooring was changed to 1.15 and '80%' is not matching this safety factor anymore.

#### **A2.3. Towing and mooring arrangements plan**

To A.2.3 1) it was added that it is to be noted in the 'Towing and mooring arrangements plan' that TOW is the load limit for towing purpose and SWL that for mooring purpose. For double bollards it is to be noted that, if not otherwise chosen, TOW is the load limit for a towing line attached with eye-splice. This is in accordance with the definitions made in A2.1.6 and A2.2.6 and was added to ensure that the purpose of the markings on the mooring and towing fittings and the method of use is described in the documents available to the ship's crew.

To A.2.3 2) it was added that the SWL and TOW markings as given by the 'Towing and mooring arrangements plan' are subject to approval by the class society with respect to the purpose (mooring/harbour towing/other towing) and the manner of applying the towing or mooring line load including limiting fleet angles. This shall clarify which information on the 'Towing and mooring arrangements plan' is to be approved by the class society. It is thereby specified that the class society does not need to approve the arrangement of mooring and towing equipment.

A2.3 3) of UR A2 Rev. 3 requires the 'Towing and mooring arrangements plan' to show the number of mooring lines together with the breaking strength of each mooring line in case the deck fittings and their supporting hull structures were designed based on reduced breaking strength of mooring lines with corresponding increase of number of lines or vice versa. This requirement was changed such that the number of mooring lines and the breaking strength of each mooring line are to be shown in general to give overview of the available mooring lines.

To A2.3 2) it was added that the acceptable wind and current speed as given in IACS Recommendation No. 10 for the recommended minimum breaking strength of mooring lines is to be noted in the 'Towing and mooring arrangements plan' for ships with Equipment Number EN>2000. This information is considered important for the ship's crew, in particular, of large ships to be aware of limitations of the mooring equipment and, thus, to enable the early preparation of countermeasures (e.g. use of storm bollards, requesting tug assistance,

leaving or not entering port) in the case of deteriorating environmental conditions in order to prevent the ship to come loose from its moorings.

#### **A2.4. Corrosion addition**

The corrosion addition for supporting hull structures was modified to evade the problem of having different corrosion allowances for the same structural elements based on UR A2 on the one hand and based on other class rules (e.g. for deck structures) on the other hand. This was found to be a problem for survey. For supporting hull structures the individual corrosion addition according to the society's rules for the surrounding structure is to be applied. The procedure is similar to that of CSR. For all other structures (e.g. pedestals) not selected from an accepted industry standard, 2 mm corrosion addition was retained.

Also for shipboard fittings provisions were added that define the corrosion margins to be considered for design of fittings not selected from an accepted industry standard.

#### **A2.5. Wear allowance**

In addition to the corrosion addition, a wear allowance of 1 mm was defined for shipboard fittings, not selected from industry standards. The wear allowance was introduced to not achieve less scantlings than according to ISO standards, e.g. ISO 13795 for welded steel bollards, for the same load cases. In this respect it should be observed that no fabrication tolerances are considered by UR A2 in contrast to some industry standards, e.g. the ISO standards.

## Technical Background (TB) document for UR A2 (Rev.5 Sep 2020)

### 1. Scope and objectives

The scope of this revision is to clarify the determination of deck cargoes side projected area in note 1 of paragraphs UR A.2.1.3 and A.2.2.3.

### 2. Engineering background for technical basis and rationale

The determination of the deck cargoes side projected area in note 1 of paragraphs UR A.2.1.3 and A.2.2. have been clarified introducing the definition of the condition to be considered.

The side projected area of the deck cargoes should be determined for the ship nominal capacity condition.

The nominal capacity condition is defined in UR A2.0 Application and definitions.

The side projected area of the deck cargoes at nominal capacity should be presented in the ship arrangement (i.e. GA, Capacity Plan, Container Stowage Plan, etc.) being or not being part of a ship's manual (trim and stability booklet, loading manual, cargo securing manual, etc.).

The calculation of the EN referred to in UR A2 for towing and mooring is to be performed considering the side projected area of deck cargoes at nominal capacity condition combined with summer load line with even keel.

### 3. Source/derivation of the proposed IACS Resolution

None

### 4. Summary of Changes intended for the revised Resolution:

#### A2.0 Application and definitions

**The nominal capacity condition is defined as the theoretical condition where the maximum possible deck cargoes are included in the ship arrangement in their respective positions. For container ships the nominal capacity condition represents the theoretical condition where the maximum possible number of containers is included in the ship arrangement in their respective positions.**

#### Note 1 Paragraph A.2.1.3:

*1. Side projected area including that of deck cargoes as given by **the ship nominal capacity condition the loading manual** is to be taken into account for selection of towing lines and the loads applied to shipboard fittings and supporting hull structure. **The nominal capacity condition is defined in A2.0.***

**Note 1 Paragraph A.2.2.3:**

1. If not otherwise specified by Recommendation No. 10, side projected area including that of deck cargoes as given by **the ship nominal capacity condition** ~~the loading manual~~ is to be taken into account for selection of mooring lines and the loads applied to shipboard fittings and supporting hull structure. ***The nominal capacity condition is defined in A2.0.***

Also, changes were made to align the text of UR with draft MSC.1/Circ.1175/Rev.1 (refer Annex 2 of SDC 6/13) approved by MSC 101 (refer para 12.9 of MSC 101/24).

**5. Points of discussions or possible discussions**

None

**6. Attachments, if any**

None

## UR A3 “Anchor Windlass Design and Testing”

### Summary

The purpose of Revision 1 of this UR is to solve some issues in paragraphs 2.2 and 6.(a) in order to:

- a) consider additional exceptions for the selection of welding consumables; and
- b) align the marking examples with ISO4568:2006

### Part A. Revision History

Version no.	Approval date	Implementation date when applicable
Rev.1 (Jun 2019)	13 June 2019	1 July 2020
New (Jun 2017)	03 June 2017	1 July 2018

#### • Rev.1 (Jun 2019)

##### .1 Origin of Change:

- Suggestion by IACS member

##### .2 Main Reason for Change:

To modify requirements regarding welded fabrication taking into account welding consumables which are not specified in W17 nor W23 and to align requirements regarding the marking with requirements of ISO 4568:2006.

##### .3 List of non-IACS Member classification societies contributing through the TC Forum and/or participating in IACS Working Group:

None

##### .4 History of Decisions Made:

Form A agreed by Panel and submitted to GPG under 19023\_PMa dated 30/01/2019.

##### .5 Other Resolutions Changes

None

##### .6 Any hinderance to MASS, including any other new technologies:

None



**.7 Dates:**

Original Proposal: May 2018

Panel Approval: May 2019 (Ref: PM18917\_IMf)

GPG Approval: 13 June 2019 (Ref: 19023\_IGd)

• **New (Jun 2017)**

**.1 Origin of Change:**

- Other (*MAIB Report on the investigation of the catastrophic failure of windlass hydraulic motor on board Stellar Voyager off Tees Bay resulting in a major injury on 23 March 2009, Report No. 25/2009, December 2009.*)

**.2 Main Reason for Change:**

None

**.3 List of non-IACS Member classification societies contributing through the TC Forum and/or participating in IACS Working Group:**

None

**.4 History of Decisions Made:**

Form A agreed by Panel and submitted to GPG under 9616aPMa dated 25 Feb. 2011.

**.5 Other Resolutions Changes**

None

**.6 Dates:**

Original Proposal: 05 January 2011 Made by a Member

Panel Approval: 03 May 2017 (Ref:PM9910)

GPG Approval: 03 June 2017 (Ref: 9616aIGo)

## Part B. Technical Background

List of Technical Background (TB) documents for UR A3:

Annex 1. **TB for New (Jun 2017)**

See separate TB document in Annex 1.

Annex 2. **TB for Rev.1 (Jun 2019)**

See separate TB document in Annex 2.



## **Technical Background (TB) document for UR A3 (New June 2017)**

### **1. Scope and objectives**

Development of a UR for anchoring equipment, which would include measures to reduce catastrophic failure of windlass hydraulic motors. The MAIB recommended revision of UR A; however, UR A1 and UR A2 do not contain machinery requirements and are the responsibility of the Hull Panel. After discussion with the Hull Panel Chairman, it was suggested that a new UR be developed specifically for the machinery requirements (e.g. UR A3). Since there is a current project team for a Hull Panel task (PH7011), the comments (if any) of this project team and the Hull Panel should also contribute to the development of the Machinery Panel's UR for anchoring equipment.

The development of the Machinery Panel's UR for anchoring equipment should take into consideration the causes of the catastrophic failures and suggestions for requirements, such as, additional requirements for the windlass, consideration of different windlass types, requirements for the operators station or the required location of the operators station, material requirements and overpressure arrangement in the hydraulic system etc.

### **2. Engineering background for technical basis and rationale**

This task was triggered by the UK MAIB and their report on the investigation of the catastrophic failure of a windlass hydraulic motor on the Stellar Voyager. The MAIB recommended that IACS develop a Unified Requirement (UR) for anchoring equipment, which would include measures to prevent the catastrophic failure of windlass hydraulic motors through over-pressurisation and over-speed.

The intended benefit of the task would be that the UR would include measures that would reduce the potential to cause injury to persons. Please note that the MAIB Safety Bulletin 1/2009 documents that there had been similar catastrophic failures of hydraulic anchor windlasses on four vessels.

### **3. Source / derivation of the proposed IACS Resolution**

- Marine Accident Investigation Branch (MAIB) Report on the investigation of the catastrophic failure of windlass hydraulic motor on board Stellar Voyager off Tees Bay resulting in a major injury on 23 March 2009, Report No. 25/2009, December 2009.
- MAIB Safety Bulletin 1/2009 Catastrophic Failure of High Pressure Hydraulic Anchor Windlasses

Development of a draft UR for anchoring equipment which would include measures to prevent the catastrophic failure of windlass hydraulic motors, taking into account outcome or progress of the PT 54 under Hull Panel.

### **4. Summary of Changes intended for the revised Resolution**

None

### **5. Points of discussions or possible discussion**

The task was triggered by the UK MAIB and their report on the investigation of the catastrophic failure of a windlass hydraulic motor on the Stellar Voyager. The MAIB recommended that IACS develop a Unified Requirement (UR) for mooring and anchoring equipment, which would include measures to prevent the catastrophic failure of windlass hydraulic motors through over-pressurisation and over-speed.

An anchor windlass questionnaire was distributed to industry, responses to questions include concerns related to:

*> Anchoring in unrestricted areas triggers most failures of the windlass due to extreme overload. This happens mostly in a combination of strong wind, wave height and deep water. Windlass motors are very sensitive to load conditions due to their very low pulling capacity (nominal pull = 6,5% of chain MBL, max pull = 10% of MBL). What damages the motor is rendering when weighing anchor under high chain tension. Very few persons on-board a ship is aware of the specifications and the limitations of a windlass. Most persons believe the windlass is much stronger than it looks like. Classification societies supervise the building and installation of the anchoring equipment. Next time they make an inspection is at the 5 years docking. In the intermediate period, the anchoring equipment is left to the maintenance / inspection system on-board.*

*> The increased duty pull (1.5 times the nominal pull, per Rec. 10) is considered sufficient for dynamic loads when heaving anchor. However, braking loads associated with dropping the anchor are not.*

*> Technology for increased duty pull required for deeper anchorages and additional dynamic loads in waves, is available. The size of the windlass would not considerably increase.*

*> Regarding the necessity of the windlass to be able to recover the full length of chain cable and anchor, abrupt changes in depth represent a situation in which higher duty pull of the windlass would be beneficial, if the anchor drags towards the deeper water.*

Clarification on the different IACS panels and discussions occurring simultaneously were offered by Machinery Panel. Subject discussions in Hull Panel PT 54, and Machinery Panel task PM9910 were ongoing.

#### **Panel Discussions:**

The cause of the failure on Stella Voyager and other reference accidents was that the anchor chain and anchor weight exceeded the capacity of the hydraulic motor during the retrieval operation. The anchor chain rendered (was released), the hydraulic motor reversed, becoming a pump in a closed loop system. The resulting overpressure led to the catastrophic failure of the motor casing. Further, the safety relief valve was not dimensioned for handling rapid and continuous pressure rises.

The Panel discussed converting the existing Rec.10 into a UR and incorporating additional concerns from MAIB and industry.

Uncertain whether an increase in the capacity of the safety relief system would contribute to uncontrolled release of the anchor. This should be commented and investigated. Note that although the MAIB did not agree, the manufacturer indicated that the cause of the accident was over-speed and not overpressure. The MAIB identified over-speed as a hazard and it needs to be considered whether increased capacity of the safety relief system can contribute to over-speed incidents.

A proposal to define the term "ductile material" in terms of min. elongation, etc. was offered. This was considered redundant to the Material URs.

The MAIB report recommended OCIMF include guidance on weighing the anchor at the next revision of their publication for anchoring systems and procedures, lessons learned from the accident discussed in the report and minimising the anchor chain tension when heaving in on the windlass. The report recommended the windlass manufacturer provide comprehensive technical and operational instructions for all components of the windlass machinery. These recommendations have been incorporated in UR A3.1.3

Survey requirements for manufacture and testing have been included in UR A3.4 and A3.5 per the MAIB report recommendations.

The UR draft should include General requirements, Application scope, Definition, Plans and documents, Material, Design requirements, Test requirements and so on (reference to IACS Rec.10 & ISO 4568). The key issue is to solve the problem raised by MAIB on the prevention of personal injury caused by overload or over speed on hydraulic motor.

The PT raised some questions regarding design criteria and testing which are addressed in the following summary from the Machinery Panel's response:

- Regarding duty pull, the Machinery Panel elected to align the requirements with ISO 4568, Clause 5.4 and removing the wind and current criteria as had been agreed in earlier discussions. The given windlass capacity is related only to the weight of chain and anchorage depth. For anchorage depth deeper than 82.5 m, another formula is introduced in compliance with ISO 4568, Clause 5.4. For both cases, buoyancy is considered and the hawse pipe efficiency is assumed at 70%. For this, the anchor masses are defined as those provided in UR A1 and Recommendation 10. This is a function of a 30-minute continuous duty pull corresponding to the Grade and diameter of chain.
- Hull supporting structure is required to be efficiently bedded to the deck and is to comply with UR S27 (Strength Requirements for Fore Deck Fittings and Equipment). Supporting structure design bases are detailed in Class requirements, these requirements must define operating loads, sea loads and forces so as to permit the designer/shipyard design flexibility for structural arrangements.
- Regarding testing, the UR will permit holding power of the brake to be verified by testing or by calculation. This is satisfactory for preliminary design approvals; ultimately, all windlasses are to be tested under working conditions after installation on-board. Each unit is to be independently tested for braking, clutch functioning, lowering and hoisting of chain cable and anchor, proper riding of the chain over the cable lifter, proper transit of the chain through the hawse pipe and the chain pipe, and effecting proper stowage of the chain and the anchor. The braking capacity is to be tested by intermittently paying out and holding the chain cable by means of the application of the brake. Where the available water depth is insufficient, the proposed test method will be specially considered.

Regarding para. 3.1.1.(b) a discussion has been made in the panel about the need to include or not safety factors to be used in calculation.

It is to be noted that the original wording of the paragraph did not include a safety factor. After a deep discussion, the Panel has agreed to maintain the original wording, just as prescriptive text to raise attention for dynamic loads and not to include a safety factor.

Regarding Section 3.4, it is considered that a suitable protection system is to be provided particularly for axial piston hydraulic motor in considering the fact that most of secondary accident occurs by the failure of axial hydraulic motor, as reported for M/V "Stellar Voyager".

## **6. Attachments if any**

None

## Technical Background (TB) document for UR A3 (Rev.1 Jun 2019)

### 1. Scope and objectives

To modify requirements regarding welded fabrication taking into account welding consumables which are not specified in W17 nor W23 and to align requirements regarding the marking with requirements of ISO 4568:2006.

### 2. Engineering background for technical basis and rationale

This task was triggered by a member's suggestion regarding some unclear points on UR A3 (New June 2017).

After the viewpoint of each member was expressed and based on a qualified majority, it was concluded that the requirements for welding consumables and marking should be modified.

### 3. Source / derivation of the proposed IACS Resolution

- ISO 4568:2006
- UR W17 and W23

### 4. Summary of Changes intended for the revised Resolution

#### 1. Welding consumables

Regarding "Welding consumables are to be type-approved by the class society" in section 2.2, one member expressed concern that there are no suitable type-approved welding consumables depending on used base materials.

After discussion it was agreed by the qualified majority that welding consumables which fall outside the scope of UR W17 and W23 are to comply with the Rules of the class society or national/international standard.

In addition, it is unanimously agreed to modify "type-approved" into "approved" since UR W17 and W23 deal with "approval" and not "type-approval".

(Supplementary explanation)

Even when the UR W17 and UR W23 are not applicable, each society may have applicable additional requirements that continue to apply.

When the UR W17 and UR W23 are not applicable, and the society has no applicable additional requirements, the approval of consumables should not be required. In this case, the consumables are to comply with the national or international standard.

#### 2. Marking

One member raised a problem that the example of marking specified in section 6 differs from ISO 4568:2006 despite being based on the ISO standard.

After discussion it is unanimously agreed to align the requirements with ISO 4568:2006.

#### 3. Application of "2.2 Welded Fabrication"

One member proposed to clarify the application of "2.2 Welded Fabrication" since it is not stipulated though the material requirements (section 2.1) are clearly written that they are applied only to "materials used in the construction of torque-transmitting and load-bearing parts of windlasses".

Most members agreed to apply section 2.2 only to torque-transmitting and load-bearing parts, but the majority considered that paragraph 2.2 can be read as continuation of 2.1 and modification is not necessary.

**5. Points of discussions or possible discussion**

None

**6. Attachments if any**

None

# IACS

INTERNATIONAL ASSOCIATION OF CLASSIFICATION SOCIETIES LTD.  
PERMANENT SECRETARIAT: 36 BROADWAY, LONDON, SW1H 0BH, UNITED  
KINGDOM

TEL: +44(0)207 976 0660 FAX: +44(0)207 808 1100  
INTERNET: [permsec@iacs.org.uk](mailto:permsec@iacs.org.uk) Web Site: [www.iacs.org.uk](http://www.iacs.org.uk)

---

May 2024

## History Files (HF) and Technical Background (TB) documents for URs concerning Containers (UR C)

Res. No.	Title	Current Rev.	HF/TB ?
UR C1	Prototype and production certificates	Deleted (Mar 2000) <i>Downgraded to Rec.62</i>	TB
UR C2	General cargo containers: prototype test procedures and test measurements	Deleted (Mar 2000) <i>Downgraded to Rec.63</i>	TB
UR C3	Quality Control arrangements at works engaged in series production of containers	Deleted (Mar 2000) <i>Downgraded to Rec.64</i>	TB
UR C4	Tank containers: prototype test procedures and test measurements	Deleted (Mar 2000) <i>Downgraded to Rec.65</i>	TB
UR C5	Thermal containers: prototype test procedures and test measurements	Deleted (Mar 2000) <i>Downgraded to Rec.66</i>	TB
UR C6	Requirements for Lashing Software	New (May 2024)	TB
UR C7	Approval and Certification of Container Securing Systems	New (May 2024)	TB



## Technical Background for Recategorization of UR's on Containers as Recommendations

### 1. Scope of objectives

As a consequence of disbanding the CG/Containers, it was decided to downgrade the UR's on Containers to REC's.

### 2. Points of discussions or possible discussions

- The initial discussion on the need to keep CG/Containers took place at GPG 46 in 1999. In the 1998 annual progress report, the Chairman of CG/C reported GPG that due to some lack of enthusiasm within the CG/C, GPG attention was requested to intensify the CG/C activities.
- At GPG 47 meeting, GPG noted slow progress in CG/C and asked the Chairman of CG/C to submit to GPG a reasoning for this fact.
- As a follow-up to GPG 47, GPG discussed the future of CG/C and decided to disband it, having noted that other organizations such as ISO have a similar rules. (Date: 18 January 2000)

Ex-UR C's	New REC's
UR C 1	REC 62
UR C 2	REC 63
UR C 3	REC 64
UR C 4	REC 65
UR C 5	REC 66

Prepared by the IACS Permanent Secretariat

## UR C6 “Requirements for Lashing Software”

### Summary

UR C6 provides harmonised performance standards and requirements to facilitate consistent approval of lashing software.

### Part A. Revision History

Version no.	Approval date	Implementation date when applicable
NEW (May 2024)	15 May 2024	1 July 2025

- **NEW (May 2024)**

#### 1 Origin of Change:

Action initiated to address the issue announced at CCC8/12 on the absence of harmonised performance standards and guidelines required for consistent approval of lashing software.

#### 2 Main Reason for Change:

The main technical reason for the change is the absence of harmonised performance standards and guidelines required to facilitate consistent approval of lashing software. This issue was raised at CCC8/12 to justify the Committee’s decision to reject the draft unified interpretation proposed by IACS to recognise the use of lashing software as a supplement to approved Cargo Securing Manual (CSM).

#### 3 List of non-IACS Member classification societies contributing or participating in IACS Working Group:

None

#### 4 History of Decisions Made:

Following the issue announced at CCC8/12 on the absence of harmonised performance standards and guidelines for lashing software, the Hull Panel deemed it necessary to resolve unified requirements with the objective to provide requirements for lashing software to facilitate consistent approval of lashing software.

Therefore, a Project Team, PT PH51, was ad hoc nominated by the Hull Panel and commissioned to develop the harmonised performance standards and requirements for lashing software in UR C6.

**5 Other Resolutions Changes:**

No other solutions are required to be changed.

**6 Any hinderance to MASS, including any other new technologies:**

No hinderances to MASS are available.

**7 Dates:**

Original Proposal:

Developed by PT PH51

Panel Approval:

11 April 2024

Ref: PH22017\_IHau

GPG Approval:

15 May 2024

Ref: 23013\_IGg

\*\*\*\*\*

## **Part B. Technical Background**

List of Technical Background (TB) documents:

Annex 1. **TB for Original Resolution, UR C6 (New May 2024)**

See separate TB document in Annex 1.

## Technical Background (TB) document for UR C6 (New May 2024)

### 1. Scope and objectives

UR C6 (May 2024) is the original version of the newly introduced unified requirements with the aim to provide harmonised performance standards and requirements for lashing software; hence, achieving a uniform implementation and facilitating consistent approval in practice.

UR C6 (May 2024) achieves this objective by providing requirements on operation manual and functions of lashing software, prescribing test loading conditions, and presenting recommendations on approval, acceptable tolerance, and survey regime of lashing software.

### 2. Engineering background for technical basis and rationale

One of the technical basis of UR C6 (May 2024) traces back to SOLAS regulation where VI/5.6 states:

"All cargoes, other than solid and liquid bulk cargoes, cargo units and cargo transport units shall be loaded, stowed and secured throughout the voyage in accordance with the Cargo Securing Manual approved by the Administration. In ships with ro-ro spaces, as defined in regulation II-2/3.41, all securing of such cargoes, cargo units and cargo transport units, in accordance with the Cargo Securing Manual, shall be completed before the ship leaves the berth. The Cargo Securing Manual shall be drawn up to a standard at least equivalent to relevant guidelines developed by the Organization."

Furthermore, the approved CSM should be drawn up in accordance with the recommendations contained in the revised guidelines for the preparation of CSM contained in MSC.1/Circ.1353/Rev.2, as approved by MSC 102.

As actual loading conditions of the container ships can vary significantly due to varying container carrying arrangements and weights for different voyages, deviations from the sample loading conditions indicated in the approved stowage and securing plans can exist. Therefore, evaluation of actual loading conditions for compliance with container lashing rules by only using the stowage and securing plans in the approved CSM can be challenging without an automated means.

IACS noted that paragraph 3.2.5 of chapter 3 of MSC.1/Circ.1353/Rev.2 allows for a loading computer to be accepted as an alternative to documentation used to evaluate forces acting on non-standardized cargo units described in paragraphs 3.2.1 to 3.2.4 of MSC.1/Circ.1353/Rev.2, as follows:

".5 other operational arrangements such as electronic data processing (EDP) or use of a loading computer may be accepted as alternatives to the requirements of paragraphs 3.2.1 to 3.2.4 above, providing that this system contains the same information."

With the intent of providing a means to efficiently evaluate actual stowage and securing of cargo containers, IACS considered that lashing software, currently available, can be used by the crew as a supplement to the approved stowage and securing plans included in the approved CSM (MSC.1/Circ.1353/Rev.2, chapter 4).

In order to formally recognise the use of lashing software as a supplement to the approved CSM on an international basis, IACS proposed a draft unified interpretation to CCC8/12. The proposal received support in principle from the Sub-Committee. However, the general view of the Sub-Committee was that before mandating approval of the lashing software by the Administration, harmonised performance standards and guidelines are needed to allow the approval of lashing software to be carried out in a consistent manner. Subsequently, the Sub-Committee invited Member States and organisations to submit a new output proposal to the Committee.

UR C6 (May 2024) addresses the absence of harmonised performance standards and guidelines for lashing software by providing requirements to facilitate consistent approval of lashing software.

**2a. Specification of the data utilised in the development/revision of the proposed IACS Resolution, if any**

N/A

**3. Source/derivation of the proposed IACS Resolution**

The source of the information was obtained through the work of a project team supervised by the Hull Panel.

**4. Summary of Changes intended for the revised Resolution:**

UR C6 (May 2024) - Requirements for Lashing Software is the original version of this UR.

**5. Points of discussions or possible discussions**

UR C6 (May 2024) was made through discussions of the draft version provided by the project team within the Hull Panel which involved mainly incorporating individual comments and acceptance of the consolidated text.

**6. Attachments if any**

No documents are attached.

## UR C7 “Approval and Certification of Container Securing Systems”

### Summary

A new UR to define the scope of approval and certification of container securing systems is developed.

### Part A. Revision History

Version no.	Approval date	Implementation date when applicable
NEW (May 2024)	15 May 2023	1 July 2025

- **NEW (May 2024)**

#### 1 Origin of Change:

Action initiated to identify the regulatory gap regarding approval and certification of container securing systems.

#### 2 Main Reason for Change:

The main technical reason for the change is the regulatory gap among the Member Societies regarding the approval and certification of container securing systems.

#### 3 List of non-IACS Member classification societies contributing or participating in IACS Working Group:

None

#### 4 History of Decisions Made:

The project, PT PH51, was initiated by the Hull Panel to address the subject of Container Loss at Sea. The project team was commissioned to identify the gaps between the Rules of member Societies regarding the approval and certification of container securing systems to define the scope of approval and certification of container securing systems.

#### 5 Other Resolutions Changes:

No other solutions are changed.

#### 6 Any hinderance to MASS, including any other new technologies:

No hinderance to MASS available.

**7 Dates:**

Original Proposal:  
Panel Approval:  
GPG Approval:

Developed by PT PH51  
11 April 2024  
15 May 2024

Ref: PH22017aIHI  
Ref: 23013\_IGg

\*\*\*\*\*



## **Part B. Technical Background**

List of Technical Background (TB) documents:

Annex 1. **TB for Original Resolution, UR C7 (New May 2024)**

See separate TB document in Annex 1.

## **Technical Background (TB) document for UR C7 (New May 2024)**

### **1. Scope and objectives**

UR C7 (May 2024) is the original version of the newly introduced unified requirements with the aim to define the scope of approval and certification of container securing systems.

UR C7 (May 2024) achieves this objective by describing the plan, drawings and items to be approved or certified. The minimum requirements on the content of the plans or certification procedures have also been given.

### **2. Engineering background for technical basis and rationale**

It is imperative to the safety of the ship and the protection of the cargo and personnel that the cargo is secured properly especially accounting for strength of the ship structures and the securing devices. Hereto, the Member Societies shows regulatory gap regarding the approval and certification of container securing items. In order to identify this regulatory gap and define the approval and certification scope of container securing systems, a literature review involving Rules and guidelines of all Member Societies, and IMO and ISO regulations was conducted. UR C7 (May 2024) is the outcome of this study targeting to fill the gap by defining the minimum requirements for approval and certification of container securing systems recommended to increase safe transportation of containers and other standardised cargo.

#### **2a. Specification of the data utilised in the development/revision of the proposed IACS Resolution, if any**

N/A

### **3. Source/derivation of the proposed IACS Resolution**

The source of the information was obtained through the work of a project team supervised by the Hull Panel.

### **4. Summary of Changes intended for the revised Resolution:**

UR C7 (May 2024) - Approval and Certification of Container Securing Systems is the original version of this UR.

### **5. Points of discussions or possible discussions**

UR C7 (May 2024) was made through discussions of the draft version provided by the project team within the Hull Panel which involved mainly incorporating individual comments and acceptance of the consolidated text.

### **6. Attachments if any**

No documents are attached.

# IACS

INTERNATIONAL ASSOCIATION OF CLASSIFICATION SOCIETIES LTD.

PERMANENT SECRETARIAT: 4 Matthew Parker Street

Westminster, London SW1H 9NP, UNITED KINGDOM

TEL: +44(0)207 976 0660

INTERNET: [permsec@iacs.org.uk](mailto:permsec@iacs.org.uk) Web Site: [www.iacs.org.uk](http://www.iacs.org.uk)

---

Dec 2022

## History Files (HF) and Technical Background (TB) documents for URs concerning Mobile Offshore Drilling Units (UR D)

Res. No.	Title	Current Rev.	HF/TB?
UR D1	Requirement concerning offshore drilling units and other similar units	Rev.4 July 2004	No
UR D2	Definitions	Rev. 2 1996	No
UR D3	General design parameters	Rev.6 Nov 2018	HF
UR D4	Self-elevating drilling units	Rev.3 Jan 2012	HF
UR D5	Column stabilized drilling units	Rev. 3 1996	No
UR D6	Surface type drilling units	Rev.1 Jan 2012	HF
UR D7	Watertight integrity	Rev.3 Jan 2012	HF
UR D8	Hazardous areas	Rev.3 Feb 2021	HF
UR D9	Machinery	Rev.4 Feb 2021	HF
UR D10	Electrical installations	Del Dec 2018	No
UR D11	Safety features	Corr.1 Dec 2022	HF
UR D12	Surveys after construction (re-located to UR Z15 in 1999)	Deleted 2002	TB

## UR D3 “General design parameters”

### Summary

UR D3 requirements provide general design parameters applicable to mobile offshore drilling units contracted for construction on and after 1 January 2013. This revision has been developed as part of IACS effort to remove Member’s reservations.

### Part A. Revision History

Version no.	Approval date	Implementation date when applicable
Rev.6 (Nov 2018)	30 November 2018	1 January 2020
Rev.5 (Jan 2012)	13 January 2012	1 January 2013
Corr.2 (Oct 2007)	25 October 2007	-
Corr.1 (July 2001)	13 July 2001	-
Rev.4 (1996)	No Record	-
Rev.3 (1990)	No Record	-
Rev.2 (1989)	No Record	-
Rev.1 (1987)	No Record	-
New (1979)	No Record	-

- **Rev.6 (Nov 2018)**

.1 Origin for Change:

- Suggestion by IACS member

.2 Main Reason for Change:

In addition to the change described below a typo has been identified in the shear stress formulation under D3.5.1.

UR D3 was reviewed as part of IACS effort to remove Member’s reservations. During the revision process Members identified 1 paragraph duplicating a requirement in LL. This paragraph, UR D3.9.2, describes how to correct the freeboard for units with Moonpools. The calculation of freeboard is a statutory requirement and the content of UR D3.9.2 is covered by LL, UI LL48 and LL53, which interpret how correction for moonpools is to be calculated with respect to the requirements of Chapter III of the International Convention on Load Lines. The only item in sec 9.2 that is not strictly covered by these Unified Interpretations, are sec 9.2.2:

*“The procedure described in D3.9.2.1 should also apply in cases of small notches or relatively narrow cut-outs at the stern of the unit.”*

The correction of freeboard due to such notches are however very small and it is therefore concluded that the calculation of freeboard should be dealt with as a strictly statutory requirement, and members do not deem it necessary to keep a unified requirement covering the same.

**.3 List of non-IACS Member Classification Societies contributing through the TC Forum and/or participating in IACS Working Group:**

None.

**.4 History of Decisions Made:**

IACS Member verified the UR text in view of removing their reservations. It has been proposed to correct a typo in the shear stress formulation and to simplify the UR text removing paragraph D3.9.2.2

**.5 Other Resolutions Changes:**

None.

**.6 Dates:**

Original Proposal: 6 April 2018 (Ref: PH18009)  
Panel Approval: 13 November 2018 (Ref: PH18009)  
GPG Approval: 30 November 2018 (Ref: 18199\_IGb)

**• Rev.5 (Jan 2012)**

**.1 Origin for Change:**

- Based on IMO Regulation (2009 MODU CODE in the annex to IMO Resolution A.1023(26))
- Other (in order to fit in with the development of offshore safety technology and practice, some current UR D related stability and safety feature requirements are updated and some new requirements are added.)

**.2 Main Reason for Change:**

To revise UR D items related to safety feature requirements, in order to comply with 2009 MODU CODE in the annex to IMO Resolution A.1023(26) and meet the requirement of offshore technology development.

**.3 List of non-IACS Member classification societies contributing through the TC Forum and/or participating in IACS Working Group:**

None

**.4 History of Decisions Made:**

Action to create task decided at 10th statutory panel meeting. Task No.30 was initially assigned by statutory panel to this undertaking. The task was postponed to 2011 due to the constraint of 2010 budget of the statutory panel, and the task number was changed to No.34. A dedicated project team was created to execute this task.

Form A was approved by GPG on 26 May 2011. Preliminary versions of the proposed UR and technical background documents were circulated among the statutory members for review.

Final version of the revised UR and technical background documents approved by the Statutory Panel on 29th September 2011.

#### .5 Other Resolutions Changes

UR D4, 6, 7 & 11

#### .6 Dates:

Original proposal: February 2011 *Made by:* Statutory panel  
Panel Approval: 29 September 2011  
GPG Approval: 13 January 2011 (Ref. 11083\_IGi)

- **Corr. 2 (Oct 2007)**

Para. D.3.5.3 re-instated at Hull Panel Request. Subject No: 7684.

No TB document available.

- **Corr. 1 (July 2001)**

Para. D.3.5.3 re-instated at Hull Panel Request. Subject No: 7684.

No TB document available.

- **Rev.4 (1996)**

No TB document available.

- **Rev.3 (1990)**

No TB document available.

- **Rev.2 (1989)**

No TB document available.

- **Rev.1 (1987)**

No TB document available.

- **New (1979)**

No TB document available.

## Part B. Technical Background

List of Technical Background (TB) documents for UR D3:

Annex 1. TB for Rev.5 (Jan 2012)

See separate TB document in Annex 1.



Annex 2. TB for Rev.6 (Nov 2018)

See separate TB document in Annex 2.



**Note:**

*1) There are no separate Technical Background (TB) documents for UR D3 New (1979), Rev.1 (1987), Rev.2 (1989), Rev.3 (1990), Rev.4 (1996), Corr.1 (July 2001) and Corr.2 (Oct 2007).*

## Technical Background for UR D3 Rev.5, Jan 2012

### 1. Scope and objectives

This revision involves current stability requirements of UR D3.7, 3.8, 3.9, 4.4, 6.4 & 7 and safety requirements of UR D11. All these works are done to make the safety requirements in accordance with IMO 2009 MODU CODE and to serve the needs of offshore technology development.

### 2. Engineering background for technical basis and rationale

2009 MODU CODE in annex of IMO Resolution A.1023(26) was adopted on 2 December 2009. The stability and safety requirements of UR D3.7, 3.8, 3.9, 4.4, 6.4, 7 & 11 should comply with the applicable provision in 2009 MODU CODE, and some current requirements are modified for this purpose. Some current requirements in UR D are no longer applicable, such as the requirements of intermediate fire water tanks which are seldom use in the units. Base on investigations of actual design, these requirements have been replaced by more suitable and precise ones. Many safety systems, such as, combustible gas detection and alarm system, hydrogen sulphide detection and alarm system, respiratory protection equipment for hydrogen sulphide, are very important for the unit safety. But there are no requirements for these systems in the current UR D. So the requirements for these systems have been added.

### 3. Source/derivation of the proposed IACS Resolution

The source of the information was obtained through work performed by the dedicated project team and additional input from the statutory panel.

### 4. Summary of Changes intended for the revised Resolution:

#### 1. UR D3.7.3 (1)

With the damage region assumption set out in D4.4.1, D5.6.1 and D6.4.1, not only single compartment but also all the possible combinations of compartments should be considered damaged during the stability calculation and analysis.

The force and moment caused by the wind to make the floating unit to incline should be called 'wind heeling force' and 'wind heeling moment' for consistency with MODU Code 2009 from the beginning to the end.

#### 2. UR D3.7.3 (2))

'with the assumption of no wind' added here is to make a clear difference between the two damage stability requirements for column stabilized units specially, which are usually called 'light collision damage with wind' and 'remote flooding without wind'.

#### 3. UR D3.8.3 (1)

The modification is consistent with 3.4.1.2 of IMO MODU Code 2009.

#### 4. UR D3.8.3 (2) (b)



The weathertight border should end with the smaller of the second intercept angle or the smallest downflooding angle of all openings without watertight or weathertight protection.

5. UR D3.8.3 (2) (c)

The added is to be consistent with Fig 4.

6. UR D 3.8.3 (3) (b)

The added is to emphasize that the range of positive stability should end with the smaller of the second intercept of the righting moment curve and the horizontal coordinate axis or the smallest downflooding angle of all openings without watertight or weathertight protection.

7. UR D 3.9.2

The modification is consistent with 3.7.9 & 3.7.15 of IMO MODU Code 2009.

## **5. Points of discussions or possible discussions**

The UR was developed by the project team (PT) for Task No.34 Discussion on the draft documents prepared by the PT were reviewed and discussed within the Statutory Panel at panel meetings and via email correspondence.

One point that required additional discussion concerned the application of 3.6.5.1 and 3.6.5.2 of the MODU Code. Referring to the comparable text in the revised UR D, the Panel understands that D7.4.2(3)(i) applies to all doors that are used, regardless if they are (normally open or normally closed) as opposed to D7.4.2(3)(ii), which refers to doors or hatch covers in self-elevating units, or doors that are normally closed and located above the deepest draft in CSDU's which only need to be of the quick acting type. While the Panel noted that this revision to the MODU Code goes beyond that required in SOLAS for conventional ships engaged on international voyages which is understood to be cargo ships, all Members agreed that doors and hatch covers which are used during the operation of the unit while afloat, regardless if they are normally open or normally closed, are required to be remotely controlled.

## **6. Attachments if any**

None

## Technical Background (TB) document for UR D3 (Rev.6 Nov 2018)

### 1. Scope and objectives

UR D3 requirements provide general design parameters applicable to mobile offshore drilling units. This revision has been developed as part of IACS effort to remove Member's reservations.

### 2. Engineering background for technical basis and rationale

During the revision process Members identified 1 paragraphs which is covered by LL and UI LL48 and LL53. This paragraph D3.9.2 was removed to avoid duplication the statutory requirement in UR D3. In addition, A typo has been corrected.

### 3. Source/derivation of the proposed IACS Resolution

None.

### 4. Summary of Changes intended for the revised Resolution:

D3.5 Allowable stresses

$\tau_i^* = \eta \sigma_y$  for shear stress. The misprint was corrected

D3.9.2, was identified as covered by LL and UI LL48 and LL53 and deleted.

### 5. Points of discussions or possible discussions

None.

### 6. Attachments if any

None.

## UR D4 “Self-elevating drilling units”

### Part A. Revision History

Version no.	Approval date	Implementation date when applicable
Rev.3 (Jan 2012)	13 January 2012	1 January 2013
Rev.2 (1996)	<i>No Record</i>	-
Rev.1 (1990)	<i>No Record</i>	-
NEW (1979)	<i>No Record</i>	-

#### • Rev.3 (Jan 2012)

##### .1 Origin for Change:

- Based on IMO Regulation (2009 MODU CODE in the annex to IMO Resolution A.1023(26))
- Other (in order to fit in with the development of offshore safety technology and practice, some current UR D related stability and safety feature requirements are updated and some new requirements are added.)

##### .2 Main Reason for Change:

To revise UR D items related to safety feature requirements , in order to comply with 2009 MODU CODE in the annex to IMO Resolution A.1023(26) and meet the requirement of offshore technology development.

##### .3 List of non-IACS Member classification societies contributing through the TC Forum and/or participating in IACS Working Group:

None

##### .4 History of Decisions Made:

Action to create task decided at 10th statutory panel meeting. Task No.30 was initially assigned by statutory panel to this undertaking. The task was postponed to 2011 due to the constraint of 2010 budget of the statutory panel, and the task number was changed to No.34. A dedicated project team was created to execute this task.

Form A was approved by GPG on 26 May 2011. Preliminary versions of the proposed UR and technical background documents were circulated among the statutory members for review.

Final version of the revised UR and technical background documents approved by the Statutory Panel on 29th September 2011.

##### .5 Other Resolutions Changes

UR D3, 6, 7 & 11

**.6 Dates:**

Original proposal: February 2011 *Made by:* Statutory panel  
Panel Approval: 29 September 2011  
GPG Approval: 13 January 2011 (Ref. 11083\_IGi)

- **Rev.2 (1996)**

No TB document available.

- **Rev.1 (1990)**

No TB document available.

- **New (1979)**

No TB document available.

## Part B. Technical Background

List of Technical Background (TB) documents for UR D4:

Annex 1. **TB for Rev.3 (Jan 2012)**

See separate TB document in Annex 1.



**Note:**

*1) There are no separate Technical Background (TB) documents for UR D4 New (1979), Rev.1 (1990) and Rev.2 (1996).*

## **Technical Background for UR D4 Rev.3, Jan 2012**

### **1. Scope and objectives**

This revision involves current stability requirements of UR D3.7, 3.8, 3.9, 4.4, 6.4 & 7 and safety requirements of UR D11. All these works are done to make the safety requirements in accordance with IMO 2009 MODU CODE and to serve the needs of offshore technology development.

### **2. Engineering background for technical basis and rationale**

2009 MODU CODE in annex of IMO Resolution A.1023(26) was adopted on 2 December 2009. The stability and safety requirements of UR D3.7, 3.8, 3.9, 4.4, 6.4, 7 & 11 should comply with the applicable provision in 2009 MODU CODE, and some current requirements are modified for this purpose. Some current requirements in UR D are no longer applicable, such as the requirements of intermediate fire water tanks which are seldom use in the units. Base on investigations of actual design, these requirements have been replaced by more suitable and precise ones. Many safety systems, such as, combustible gas detection and alarm system, hydrogen sulphide detection and alarm system, respiratory protection equipment for hydrogen sulphide, are very important for the unit safety. But there are no requirements for these systems in the current UR D. So the requirements for these systems have been added.

### **3. Source/derivation of the proposed IACS Resolution**

The source of the information was obtained through work performed by the dedicated project team and additional input from the statutory panel.

### **4. Summary of Changes intended for the revised Resolution:**

UR D4.4.1 - The modification is consistent with 3.5.6 of IMO MODU Code 2009.

### **5. Points of discussions or possible discussions**

The UR was developed by the project team (PT) for Task No.34 Discussion on the draft documents prepared by the PT were reviewed and discussed within the Statutory Panel at panel meetings and via email correspondence.

One point that required additional discussion concerned the application of 3.6.5.1 and 3.6.5.2 of the MODU Code. Referring to the comparable text in the revised UR D, the Panel understands that D7.4.2(3)(i) applies to all doors that are used, regardless if they are (normally open or normally closed) as opposed to D7.4.2(3)(ii), which refers to doors or hatch covers in self-elevating units, or doors that are normally closed and located above the deepest draft in CSDU's which only need to be of the quick acting type. While the Panel noted that this revision to the MODU Code goes beyond that required in SOLAS for conventional ships engaged on international voyages which is understood to be cargo ships, all Members agreed that doors and hatch covers which are used during the operation of the unit while afloat, regardless if they are normally open or normally closed, are required to be remotely controlled.

### **6. Attachments if any - None**

## UR D6 “Surface type drilling units”

### Part A. Revision History

Version no.	Approval date	Implementation date when applicable
Rev.1 (Jan 2012)	13 January 2012	1 January 2013
NEW (1979)	<i>No Record</i>	-

#### • Rev.1 (Jan 2012)

##### .1 Origin for Change:

- Based on IMO Regulation (2009 MODU CODE in the annex to IMO Resolution A.1023(26))
- Other (in order to fit in with the development of offshore safety technology and practice, some current UR D related stability and safety feature requirements are updated and some new requirements are added.)

##### .2 Main Reason for Change:

To revise UR D items related to safety feature requirements , in order to comply with 2009 MODU CODE in the annex to IMO Resolution A.1023(26) and meet the requirement of offshore technology development.

##### .3 List of non-IACS Member classification societies contributing through the TC Forum and/or participating in IACS Working Group:

None

##### .4 History of Decisions Made:

Action to create task decided at 10th statutory panel meeting. Task No.30 was initially assigned by statutory panel to this undertaking. The task was postponed to 2011 due to the constraint of 2010 budget of the statutory panel, and the task number was changed to No.34. A dedicated project team was created to execute this task.

Form A was approved by GPG on 26 May 2011. Preliminary versions of the proposed UR and technical background documents were circulated among the statutory members for review.

Final version of the revised UR and technical background documents approved by the Statutory Panel on 29th September 2011.

##### .5 Other Resolutions Changes

UR D3, 4, 7 & 11

**.6 Dates:**

Original proposal: February 2011 *Made by:* Statutory panel  
Panel Approval: 29 September 2011  
GPG Approval: 13 January 2011 (Ref. 11083\_IGi)

- **New (1979)**

No TB document available.



## Part B. Technical Background

List of Technical Background (TB) documents for UR D6:

Annex 1. **TB for Rev.1 (Jan 2012)**

See separate TB document in Annex 1.



**Note:**

1) *There is no separate Technical Background (TB) documents for UR D6 New (1979).*

## **Technical Background for UR D6 Rev.1, Jan 2012**

### **1. Scope and objectives**

This revision involves current stability requirements of UR D3.7, 3.8, 3.9, 4.4, 6.4 & 7 and safety requirements of UR D11. All these works are done to make the safety requirements in accordance with IMO 2009 MODU CODE and to serve the needs of offshore technology development.

### **2. Engineering background for technical basis and rationale**

2009 MODU CODE in annex of IMO Resolution A.1023(26) was adopted on 2 December 2009. The stability and safety requirements of UR D3.7, 3.8, 3.9, 4.4, 6.4, 7 & 11 should comply with the applicable provision in 2009 MODU CODE, and some current requirements are modified for this purpose. Some current requirements in UR D are no longer applicable, such as the requirements of intermediate fire water tanks which are seldom use in the units. Base on investigations of actual design, these requirements have been replaced by more suitable and precise ones. Many safety systems, such as, combustible gas detection and alarm system, hydrogen sulphide detection and alarm system, respiratory protection equipment for hydrogen sulphide, are very important for the unit safety. But there are no requirements for these systems in the current UR D. So the requirements for these systems have been added.

### **3. Source/derivation of the proposed IACS Resolution**

The source of the information was obtained through work performed by the dedicated project team and additional input from the statutory panel.

### **4. Summary of Changes intended for the revised Resolution:**

UR D 6.4.1- The modification is consistent with 3.5.2 of IMO MODU Code 2009.

### **5. Points of discussions or possible discussions**

The UR was developed by the project team (PT) for Task No.34 Discussion on the draft documents prepared by the PT were reviewed and discussed within the Statutory Panel at panel meetings and via email correspondence.

One point that required additional discussion concerned the application of 3.6.5.1 and 3.6.5.2 of the MODU Code. Referring to the comparable text in the revised UR D, the Panel understands that D7.4.2(3)(i) applies to all doors that are used, regardless if they are (normally open or normally closed) as opposed to D7.4.2(3)(ii), which refers to doors or hatch covers in self-elevating units, or doors that are normally closed and located above the deepest draft in CSDU's which only need to be of the quick acting type. While the Panel noted that this revision to the MODU Code goes beyond that required in SOLAS for conventional ships engaged on international voyages which is understood to be cargo ships, all Members agreed that doors and hatch covers which are used during the operation of the unit while afloat, regardless if they are normally open or normally closed, are required to be remotely controlled.

### **6. Attachments if any - None**

## UR D7 “Watertight integrity”

### Part A. Revision History

Version no.	Approval date	Implementation date when applicable
Rev.3 (Jan 2012)	13 January 2012	1 January 2013
Rev.2 (1996)	<i>No Record</i>	-
Rev.1 (1990)	<i>No Record</i>	-
NEW (1979)	<i>No Record</i>	-

#### • Rev.3 (Jan 2012)

##### .1 Origin for Change:

- Based on IMO Regulation (2009 MODU CODE in the annex to IMO Resolution A.1023(26))
- Other (in order to fit in with the development of offshore safety technology and practice, some current UR D related stability and safety feature requirements are updated and some new requirements are added.)

##### .2 Main Reason for Change:

To revise UR D items related to safety feature requirements , in order to comply with 2009 MODU CODE in the annex to IMO Resolution A.1023(26) and meet the requirement of offshore technology development.

##### .3 List of non-IACS Member classification societies contributing through the TC Forum and/or participating in IACS Working Group:

None

##### .4 History of Decisions Made:

Action to create task decided at 10th statutory panel meeting. Task No.30 was initially assigned by statutory panel to this undertaking. The task was postponed to 2011 due to the constraint of 2010 budget of the statutory panel, and the task number was changed to No.34. A dedicated project team was created to execute this task.

Form A was approved by GPG on 26 May 2011. Preliminary versions of the proposed UR and technical background documents were circulated among the statutory members for review.

Final version of the revised UR and technical background documents approved by the Statutory Panel on 29th September 2011.

##### .5 Other Resolutions Changes

UR D3, 4, 6 & 11

**.6 Dates:**

Original proposal: February 2011 *Made by:* Statutory panel  
Panel Approval: 29 September 2011  
GPG Approval: 13 January 2011 (Ref. 11083\_IGi)

- **Rev.2 (1996)**

No TB document available.

- **Rev.1 (1990)**

No TB document available.

- **New (1979)**

No TB document available.

## Part B. Technical Background

List of Technical Background (TB) documents for UR D7:

Annex 1. **TB for Rev.3 (Jan 2012)**

See separate TB document in Annex 1.



**Note:**

*1) There are no separate Technical Background (TB) documents for UR D7 New (1979), Rev.1 (1990) and Rev.2 (1996).*

## **Technical Background for UR D7 Rev.3, Jan 2012**

### **1. Scope and objectives**

This revision involves current stability requirements of UR D3.7, 3.8, 3.9, 4.4, 6.4 & 7 and safety requirements of UR D11. All these works are done to make the safety requirements in accordance with IMO 2009 MODU CODE and to serve the needs of offshore technology development.

### **2. Engineering background for technical basis and rationale**

2009 MODU CODE in annex of IMO Resolution A.1023(26) was adopted on 2 December 2009. The stability and safety requirements of UR D3.7, 3.8, 3.9, 4.4, 6.4, 7 & 11 should comply with the applicable provision in 2009 MODU CODE, and some current requirements are modified for this purpose. Some current requirements in UR D are no longer applicable, such as the requirements of intermediate fire water tanks which are seldom use in the units. Base on investigations of actual design, these requirements have been replaced by more suitable and precise ones. Many safety systems, such as, combustible gas detection and alarm system, hydrogen sulphide detection and alarm system, respiratory protection equipment for hydrogen sulphide, are very important for the unit safety. But there are no requirements for these systems in the current UR D. So the requirements for these systems have been added.

### **3. Source/derivation of the proposed IACS Resolution**

The source of the information was obtained through work performed by the dedicated project team and additional input from the statutory panel.

### **4. Summary of Changes intended for the revised Resolution:**

#### **1. UR D7.4.2**

The modification is to eliminate the logical confusion and to be consistent with IMO MODU Code 2009.

#### **2. UR D7.4.3 (1)**

The modification is to eliminate the logical confusion and make a clear presentation.

#### **3. UR D7.4.3 (4)**

There is no D7.4.3(3), and whether it doesn't exist ever or there is something omitted should be clear. According to the content, the requirement of D7.4.2(3) (i) and (ii) should be complied with.

### **5. Points of discussions or possible discussions**

The UR was developed by the project team (PT) for Task No.34 Discussion on the draft documents prepared by the PT were reviewed and discussed within the Statutory Panel at panel meetings and via email correspondence.

One point that required additional discussion concerned the application of 3.6.5.1 and 3.6.5.2 of the MODU Code. Referring to the comparable text in the revised UR D, the Panel understands that D7.4.2(3)(i) applies to all doors that are used, regardless if

they are (normally open or normally closed) as opposed to D7.4.2(3)(ii), which refers to doors or hatch covers in self-elevating units, or doors that are normally closed and located above the deepest draft in CSDU's which only need to be of the quick acting type. While the Panel noted that this revision to the MODU Code goes beyond that required in SOLAS for conventional ships engaged on international voyages which is understood to be cargo ships, all Members agreed that doors and hatch covers which are used during the operation of the unit while afloat, regardless if they are normally open or normally closed, are required to be remotely controlled.

**6. Attachments if any**

None

## UR D8 'Hazardous areas'

### Summary

In Rev.3 of this Resolution, an amendment was made to reflect the latest IMO Resolution.

### Part A. Revision History

Version no.	Approval date	Implementation date when applicable
Rev.3 (Feb 2021)	24 February 2021	1 July 2022
Rev.2 (1996)	1996	-
Rev.1 (1990)	1990	Unknown
New (1979)	1979	Unknown

#### • Rev.3 (Feb 2021)

##### 1 Origin of Change:

- Other (Periodical review to reflect the latest IMO Resolutions)

##### 2 Main Reason for Change:

There was a need to update this UR to reflect the latest IMO Resolutions related to 2009 MODU Code.

##### 3 List of non-IACS Member classification societies contributing or participating in IACS Working Group:

None

##### 4 History of Decisions Made:

Some text of 2009 MODU Code (a non-mandatory IMO Code) are reflected in this UR so that those requirements can be uniformly applied among IACS members as mandatory class requirements.

##### 5 Other Resolutions Changes:

None

##### 6 Any hinderance to MASS, including any other new technologies:

None



## 7 Dates:

Original Proposal: 25 February 2019 (Ref: PM5901gIMh)  
Panel Approval: 9 November 2020 (Ref: PM20906\_IMf)  
GPG Approval: 24 February 2021 (Ref: 20206bIGc)

- **Rev.2 (1996)**

No history file or TB document available.

- **Rev.1 (1990)**

No history file or TB document available.

- **New (1979)**

No history file or TB document available.

\*\*\*\*\*

## Part B. Technical Background

List of Technical Background (TB) documents for UR D8:

Annex 1. **TB for Rev.3 (Feb 2021)**

See separate TB document in Annex 1.



**Note:** *There is no separate Technical Background (TB) document for New (1979), Rev.1 (1990) and Rev.2 (1996).*

## **Technical Background (TB) document for UR D8 (Rev 3 Feb 2021)**

### **1. Scope and objectives**

UR D8(Rev.2) does not reflect the latest IMO Resolutions related to 2009 MODU Code. Rev.3 has been developed to cover hazardous area requirements.

### **2. Engineering background for technical basis and rationale**

The Panel agreed unanimously to update the UR to align it with 2009 MODU Code amending the requirements for hazardous areas.

### **3. Source/derivation of the proposed IACS Resolution**

2009 MODU Code.

### **4. Summary of Changes intended for the revised Resolution:**

Sections D8.1 to D8.3 specifying hazardous areas requirements related to classifications of said areas and ventilation have been amended.

### **5. Points of discussions or possible discussions**

Sections 6.1 and 6.2, Paragraphs 6.3.1 and 6.3.2, the second sentence of Paragraph 6.4.1 as well as Paragraph 6.4.4 of 2009 MODU Code have been covered by this revision.

Also, history of decision made mentioned in para 4 of history file of Rev.3 be referred.

### **6. Attachments if any**

None

## UR D9 'Machinery'

### Summary

In Rev.4 of this Resolution, Paragraph D9.7.3 related to vent pipes protection has been added, taking into account Paragraph 4.8.5 of 2009 MODU Code.

### Part A. Revision History

Version no.	Approval date	Implementation date when applicable
Rev.4 (Feb 2021)	24 February 2021	1 July 2022
Rev.3 (1996)	1996	-
Rev.2 (1990)	1990	-
Rev.1 (1987)	1987	-
New (1979)	1979	-

- **Rev.4 (Feb 2021)**

#### 1 Origin of Change:

- Other (Periodical review to reflect the latest IMO Resolutions)

#### 2 Main Reason for Change:

There was a need to update this UR to reflect the latest IMO Resolutions related to 2009 MODU Code.

#### 3 List of non-IACS Member classification societies contributing or participating in IACS Working Group:

None

#### 4 History of Decisions Made:

Some text of 2009 MODU Code (a non-mandatory IMO Code) are reflected in this UR so that those requirements can be uniformly applied among IACS members as mandatory class requirements.

#### 5 Other Resolutions Changes:

None

#### 6 Any hinderance to MASS, including any other new technologies:

None

## 7 Dates:

Original Proposal: 28 October 2019 (Ref: PM18939IMd)  
Panel Approval: 9 November 2020 (Ref: PM20906\_IMf)  
GPG Approval: 24 February 2021 (Ref: 20206aIGd)

- **Rev.3 (1996)**

No history file or TB document available.

- **Rev.2 (1990)**

No history file or TB document available.

- **Rev.1 (1987)**

No history file or TB document available.

- **New (1977)**

No history file or TB document available.

\*\*\*\*\*

## Part B. Technical Background

List of Technical Background (TB) documents for UR D9:

Annex 1. **TB for Rev.4 (Feb 2021)**

See separate TB document in Annex 1.



**Note:** *There is no separate Technical Background (TB) document for Original version (1979), Rev.1 (1987), Rev.2(1990) and Rev.3 (1996).*

## **Technical Background (TB) document for UR D9 (Rev.4 Feb 2021)**

### **1. Scope and objectives**

UR D9(Rev.3) does not reflect the latest IMO Resolutions related to 2009 MODU Code. Rev.4 has been developed to cover vent pipes protection requirement.

### **2. Engineering background for technical basis and rationale**

The Panel agreed unanimously to update the UR to align it with 2009 MODU Code adding the requirement for vent pipes protection.

### **3. Source/derivation of the proposed IACS Resolution**

2009 MODU Code.

### **4. Summary of Changes intended for the revised Resolution:**

Paragraph D9.7.3 related to vent pipes protection has been added.

### **5. Points of discussions or possible discussions**

Paragraph 4.8.5 of 2009 MODU Code has been covered in Paragraph D9.7.3 of UR D9.

Also, history of decision made mentioned in para 4 of history file of Rev.4 be referred.

### **6. Attachments if any**

None

## UR D11 "Safety features"

### Summary

UR D11 is updated to provide clarity of "near other openings of accommodation spaces".

### Part A. Revision History

Version no.	Approval date	Implementation date when applicable
Corr.1 (Dec 2022)	14 December 2022	-
Rev.4 (Dec 2021)	24 December 2021	01 January 2023
Rev.3 (Jan 2012)	13 January 2012	01 January 2013
Rev.2 (1996)	1996	-
Rev.1 (1990)	1990	-
New (1979)	1979	-

#### • Corr.1 (Dec 2022)

##### 1 Origin for Change:

- Suggestion by an IACS member

##### 2 Main Reason for Change:

To remove the reference to "explosion proof" driller's cabins as the whole driller's cabin cannot be made explosion proof. This clarification was overlooked during the last revisions to UR D11.

##### 3 List of non-IACS Member classification societies contributing through the TC Forum and/or participating in IACS Working Group:

None

##### 4 History of Decisions Made:

UR D 11.7 was corrected to remove the words "explosion proof" from D11.7.1 c.

##### 5 Other Resolutions Changes

None

##### 6 Any hinderance to MASS, including any other new technologies:

None



## 7 Dates:

Original proposal : 18 October 2022 (Made by Safety Panel)  
Panel Approval : 29 November 2022 (Ref: PS17010fISzl)  
GPG Approval : 14 December 2022 (Ref: 21121\_IGh)

### • Rev.4 (Dec 2021)

#### 1 Origin for Change:

- Suggestion by an IACS member

#### 2 Main Reason for Change:

To clarify the phrase “*near other openings of accommodation spaces*” in UR D 11.7 with regard to the fitting of fixed automatic combustible gas detection and alarm system.

#### 3 List of non-IACS Member classification societies contributing through the TC Forum and/or participating in IACS Working Group:

None

#### 4 History of Decisions Made:

UR D 11.7 was revised to clarify where fixed automatic combustible gas detection and alarm system are required and not required to be fitted. The discussion prompted a revision of UR D 11 as detailed in annex 2.

#### 5 Other Resolutions Changes

None

#### 6 Any hinderance to MASS, including any other new technologies:

None

## 7 Dates:

Original proposal : 21 June 2021 (Made by Safety Panel)  
Panel Approval : 29 November 2021 (Ref: PS17010fISzi)  
GPG Approval : 24 December 2021 (Ref: 21121\_IGf)

### • Rev.3 (Jan 2012)

#### .1 Origin for Change:

- Based on IMO Regulation (2009 MODU CODE in the annex to IMO Resolution A.1023(26))
- Other (in order to fit in with the development of offshore safety technology and practice, some current UR D related stability and safety feature requirements are updated and some new requirements are added.)

## **.2 Main Reason for Change:**

To revise UR D items related to safety feature requirements, in order to comply with 2009 MODU CODE in the annex to IMO Resolution A.1023(26) and meet the requirement of offshore technology development.

## **.3 List of non-IACS Member classification societies contributing through the TC Forum and/or participating in IACS Working Group:**

None

## **.4 History of Decisions Made:**

Action to create task decided at 10th statutory panel meeting. Task No.30 was initially assigned by statutory panel to this undertaking. The task was postponed to 2011 due to the constraint of 2010 budget of the statutory panel, and the task number was changed to No.34. A dedicated project team was created to execute this task.

Form A was approved by GPG on 26 May 2011. Preliminary versions of the proposed UR and technical background documents were circulated among the statutory members for review.

Final version of the revised UR and technical background documents approved by the Statutory Panel on 29th September 2011.

## **.5 Other Resolutions Changes**

UR D3, 4, 6 & 7

## **.6 Dates:**

Original proposal	: February 2011	(Made by: Statutory panel)
Panel Approval	: 29 September 2011	
GPG Approval	: 13 January 2011	(Ref: 11083_IGi)

- **Rev.2 (1996)**

No HF/TB document available.

- **Rev.1 (1990)**

No HF/TB document available.

- **New (1979)**

No HF/TB document available.

## **Part B. Technical Background**

List of Technical Background (TB) documents for UR D11:

Annex 1. **TB for Rev.3 (Jan 2012)**

See separate TB document in Annex 1.

Annex 2. **TB for Rev.4 (Dec 2021)**

See separate TB document in Annex 2.

**Note:** *There are no separate Technical Background (TB) documents for UR D11 New (1979), Rev.1 (1990), Rev.2 (1996) and Corr.1 (Dec 2022).*

## **Technical Background for UR D11 Rev.3, Jan 2012**

### **1. Scope and objectives**

This revision involves current stability requirements of UR D3.7, 3.8, 3.9, 4.4, 6.4 & 7 and safety requirements of UR D11. All these works are done to make the safety requirements in accordance with IMO 2009 MODU CODE and to serve the needs of offshore technology development.

### **2. Engineering background for technical basis and rationale**

2009 MODU CODE in annex of IMO Resolution A.1023(26) was adopted on 2 December 2009. The stability and safety requirements of UR D3.7, 3.8, 3.9, 4.4, 6.4, 7 & 11 should comply with the applicable provision in 2009 MODU CODE, and some current requirements are modified for this purpose. Some current requirements in UR D are no longer applicable, such as the requirements of intermediate fire water tanks which are seldom use in the units. Base on investigations of actual design, these requirements have been replaced by more suitable and precise ones. Many safety systems, such as, combustible gas detection and alarm system, hydrogen sulphide detection and alarm system, respiratory protection equipment for hydrogen sulphide, are very important for the unit safety. But there are no requirements for these systems in the current UR D. So the requirements for these systems have been added.

### **3. Source/derivation of the proposed IACS Resolution**

The source of the information was obtained through work performed by the dedicated project team and additional input from the statutory panel.

### **4. Summary of Changes intended for the revised Resolution:**

#### 1. UR D11.1.1

Because drilling units are different from ships, additional items, such as, gas detection, hydrogen sulphide detection, emergency shutdown, BOP control positions etc., have been added on the basis of ship's fire control plan.

SOLAS II-2/15.2.4. and IMO.A.952 (23) has been referenced for developing this requirement.

#### 2. UR D11.2.4

In actual practice, the intermediate tank with replenishment pump is seldom installed in the MODU. For surface and column-stabilized and self-elevating units in floating conditions, the fire water normally come from more than one sea chest, and one sea chest supplying system failure can not put the other systems out of action.

For self-elevating units in non-floating conditions, the fire water is supply through following ways:

(a) While unit lifting or lowering, drilling water is normally supplied to fire fighting and engine cooling systems. This is a normal operation practice of some companies.

Alternatively, buffer tanks (or ballast tanks) also can supply water to fire fighting purpose.

(b) During unit is in the elevating positions fire fighting water is supplied from sea water main charged by more than one submersible pumps.

This new provision is developed based on above actual practice. Normally, the drilling water tank volume is far more than 40 m<sup>3</sup>. Water stored in tank of 40 m<sup>3</sup> can maintain two 19mm nozzle jetting for one hour. If 10 m<sup>3</sup> was specified it could be considered not enough.

### 3. UR D11.3.2

The new paragraph has been added because drilling and well test areas are really needed to protect. The existing units investigated by us are really protected with water spray system or fire monitors. ISO 13703, API RP 2030 and NFPA 15 have been referenced to make this new paragraph. Regarding the water application rate, 10 l/min•m<sup>2</sup> is specified by ISO and DNV, and 20.4 l/min•m<sup>2</sup> is required by API RP 2030. Water spray is not only for cooling purpose but also for diluting gas concentration to avoid explosion. Also considering blowout fire is more powerful, so rate of 20.4 l/min•m<sup>2</sup> is required.

### 4. UR D11.3.3

Now, oil base mud is often used in drilling operations. Foam is the best medium to extinguish oil pool fire. So foam system is required to protect mud processing area. Regarding the delivering rate 6.5 and 4.1 l/min•m<sup>2</sup>, the origin is from NFPA.11.

### 5. UR D 11.4.1 to 11.4.3

The revised requirements are applicable to helicopter facilities without considering with refuelling capabilities or with no refuelling capabilities. This revision is consistent with 2009 MODU Code. The delivering rate 6 l/min.m<sup>2</sup> is maintained in order to be consistent with MODU CODE and ICAO requirement.

### 6. UR D11.5.1

This revision makes the requirements clearer and precise. MODU CODE, CFR 46 Part 113, IMO A.1021 (26) and MSC/ Circ.887 have been referenced for making this revision.

### 7. UR D11.5.4

The public address requirements are consistent with SOLAS, LSA CODE 7.2.2 and 2009 MODU CODE 5.7.3.

### 8. UR D11.6

This paragraph has been deleted. There are no special emergency control stations on the existing unit. General alarm actuating location requirement is moved to D11.5.1. Emergency shutdown requirement is covered in D10.5.1.

### 9. UR D11.7

Based on the existing text, general requirement and specific requirements for protection of galleys, electrical rooms, drilling areas, mud processing areas and well test areas have been added to enable the whole system requirements more completeness and easily operable. SOLAS, MODU Code and other materials have been referenced for making this revised paragraph.

UR D11.8 (New section added)

During the drilling operation, if hydrogen sulphide gas is present it could be very dangerous to personnel. So it is very necessary to optimizing the arrangement of hydrogen sulphide detectors and ensuring the availability of the Hydrogen sulphide detection and alarm system. In this paragraph, the provision of Ch.9.12 of MODU Code has been incorporated into this new URD.

The requirement of two level alarms comes from API RP 49.

UR D11.9 (New section added)

To make the requirements for respiratory protection equipment for hydrogen sulphide more suitable for MODU, API RP 49 and 29 CFR 1910.134 have been referenced and actual conditions of MODU are considered for developing this new UR D.

## **5. Points of discussions or possible discussions**

The UR was developed by the project team (PT) for Task No.34 Discussion on the draft documents prepared by the PT were reviewed and discussed within the Statutory Panel at panel meetings and via email correspondence.

One point that required additional discussion concerned the application of 3.6.5.1 and 3.6.5.2 of the MODU Code. Referring to the comparable text in the revised UR D, the Panel understands that D7.4.2(3)(i) applies to all doors that are used, regardless if they are (normally open or normally closed) as opposed to D7.4.2(3)(ii), which refers to doors or hatch covers in self-elevating units, or doors that are normally closed and located above the deepest draft in CSDU's which only need to be of the quick acting type. While the Panel noted that this revision to the MODU Code goes beyond that required in SOLAS for conventional ships engaged on international voyages which is understood to be cargo ships, all Members agreed that doors and hatch covers which are used during the operation of the unit while afloat, regardless if they are normally open or normally closed, are required to be remotely controlled.

## **6. Attachments if any**

None

## **Technical Background (TB) document for UR D11 (Rev.4 Dec 2021)**

### **1. Scope and objectives**

An IACS member sought clarification of the phrase "*near other openings of accommodation spaces*" in UR D 11.7.1(g) with regard to the fitting of fixed automatic combustible gas detection and alarm system.

### **2. Engineering background for technical basis and rationale**

Fixed automatic combustible gas detection and alarm system should be provided to openings leading to the accommodations where the risk of gas entering into the accommodations is present.

### **3. Source/derivation of the proposed IACS Resolution**

1. The Panel considered the risk of ingress of combustible gas into the accommodation space relative to the effectiveness/reliability of the ventilation over-pressurization, the gas tight effectiveness of external door arrangements (self-closing, gas tight, airlock) and the location of doors and other openings with respect to the hazardous area.

2. It was noted that:

- UR D 11.7.1(g) appears to provide clarification of the MODU Code 9.11.1 which states, "*A fixed automatic gas detection and alarm system should be provided to the satisfaction of the Administration so arranged as to monitor continuously all enclosed areas of the unit in which an accumulation of flammable gas may be expected to occur and capable of indicating at the main control point by aural and visual means the presence and location of an accumulation.*"
- NORSOK S-001 "Technical Safety" and NMA MODU Fire Regulations do not require gas detectors in locations other than the ventilation intakes for accommodation spaces.

### **4. Summary of Changes intended for the revised Resolution:**

1. Fixed automatic combustible gas detection and alarm system is to be provided for:
  - *Ventilation intake of positive pressure explosion-proof driller's cabin.*
  - Ventilation intakes of accommodation spaces.
  - *Ventilation intakes of enclosed machinery spaces contiguous to hazardous areas and containing internal combustion engines, boilers; or non-explosion proof electrical equipment*
  - Air intakes to all combustion engines or machinery, including internal combustion engines, boilers, compressors or turbines, located outside of an enclosed machinery space
  - At each access door to accommodation spaces.
  - Near other openings, including emergency egress, of accommodation spaces, regardless if these openings are fitted with self-closing and gastight closing appliances.

2. Fixed automatic combustible gas detection and alarm systems are not required:

- Near access doors to accommodation spaces where these form part of an air-lock which is provided with a gas detection and alarm system between the two doors of the air-lock.
- [Near emergency egress doors which are fitted with a panic bar or similar mechanism to prevent use other than in an emergency].
- Near other openings which are provided with closing appliances of non-opening type, e.g. bolted closed maintenance ways etc.

## 5. Points of discussions or possible discussions

1. Initial discussions considered that "*near other openings*":

- excluded ventilation outlets - as they are not specifically mentioned and there is no known source of gas release from the accommodations given that air flow is exhausting from the ventilation outlet. However, some Members considered that ventilation outlets should be included in order to provide gas detectors to give warning of ingress of gas into the accommodations in the event the ventilation system shuts down;
- included exterior doors of the accommodations - because they are in use (opened and closed) as a normal operation and are not required to be gas tight;
- included emergency egress doors which are fitted with a panic bar or similar mechanism to prevent use other than in an emergency because it is desirable for those egressing the accommodations to know if combustible gas exists outside of the door
- excluded windows and sidescuttles of the non-opening type as there is no risk of ingress of combustible gas.

2. Views on the need for a fixed automatic combustible gas detection and alarm system "*near other openings*" of accommodation space were mixed due to different assumptions on:

- the effectiveness/reliability of the ventilation over-pressurization to control the movement of gases
- external door arrangement (self-closing, gas tight, airlock)
- location of doors and other openings with respect to the hazardous area.

3. During discussion, it was proposed to revise:

- UR D8.3 to require a minimum capacity (air changes per hour) in accordance with an agreed national or international standard (e.g., ISO15138) for the ventilation system for the accommodation space (It was subsequently determined that as ISO 15138 follows a goal and functional requirement approach and does not specify a figure for the number of changes required, it was not appropriate to refer to ISO 15138); and
- UR D11.7.1.g to require a fixed automatic combustible gas detection and alarm system to be provided for ventilation intakes and near other openings of accommodation spaces which face hazardous areas unless these other openings are defined emergency egress doors or are fitted with self-closing and gastight closing appliances or with an airlock (this was analogous to SOLAS II-2/4.5.2.1 which prohibits access doors, air



inlets and openings to accommodation spaces, service spaces, control stations and machinery spaces from facing the cargo area).

4. An alternative proposal considered that:

A combustible gas detection and alarm system need not be provided where the opening:

- is through an air lock; or
- is provided with a closing appliance of a non-opening type (e.g. bolted closed maintenance access way etc.); or
- is a defined emergency egress door as identified on the fire control plan or is marked as such in accordance with 2009 MODU Code 9.4.1.4.

Arrangements which meet ISO 13702 or NORSOK S-001 are considered to meet this requirement.

5. Different views existed as to the intent of providing fixed automatic combustible gas detection and alarm system to other openings:

- to ensure that all significant access points that gas could enter an accommodation space are fitted with gas detection; versus
- in the event of a gas release where a cloud could easily migrate to the access doors it is prudent to provide gas detection at the access doors (including self-closing gas-tight doors and emergency egress doors) in order to adequately notify the crew of the gaseous condition that exists outside of access door in order to facilitate a safe response to implement emergency shutdown procedures

6. As a possible compromise, it was proposed:

- The ventilation system for the accommodation spaces is to be capable of maintaining a positive pressure in relation to the outside atmosphere (refer to International standards e.g. IEC 60092-502:1999) appropriate for the safe use of the space, assuming all doors and windows are closed.
- A differential pressure monitoring device or a flow monitoring device, or both, shall be provided in the space for monitoring the satisfactory functioning of pressurization. An alarm is to be given at a normally manned station in case the overpressure is lost.
- As an alternative to pressure and/or flow monitoring and alarm requirement, a gas detector provided outside each access door with an alarm given at a normally manned station, may be accepted.

7. After re-focusing on the original question as to what constituted "*near other openings*", it was agreed that the proposal in paragraph 6, above, went beyond the original issue raised and agreed to a revision or D11.7 as summarized in item 4, above.

## **6. Attachments if any**

None

**Technical Background Document**  
**WP/SRC Task 1**  
**UR Z 15 – Proposed**

**Objective and Scope:**

To review existing UR D 12 and relocate it as a UR under UR Z.

**Source of Proposed Requirements:**

WP/SRC members discussed and reviewed the requirements contained in UR D 12 through correspondence and their meeting. Reservations against UR D 12 were also dealt with at this time as contained in the proposed draft.

**Points of Discussion:**

WP/SRC unanimously agreed to the proposed draft UR Z 15.

## Technical Background Document

### New UR Z 15 and deletion of D12 (Survey after Construction, MODUs)

#### Objective and Scope:

Re-locate the current MODU survey requirements from UR D12 to a new UR Z.

#### Source of Proposed Requirements:

WP/SRC Chairman reported in his annual progress report(March 1999, GPG 46) that WP/SRC Members had discussed and reviewed the requirements contained in UR D 12 through correspondence and at their last meeting and had relocated the text of D 12 to a new UR Z15.

The task was carried out as part of Annual review of Implementation of IACS Requirements.

#### Points of Discussion:

WP/SRC unanimously agreed to the proposed draft UR Z 15.

Council in May 1999 decided that the proposed draft paragraph 2.2.2 should be deleted since it would require Members to periodically check all CSDU's lightship characteristics as a condition of class in the event that it was not checked as a statutory requirement.

Paragraph 2.2.2, which has now been deleted, read as follows:

- 2.2.2 For Column Stabilized Units, a deadweight survey is to be conducted as part of classification surveys at interval not exceeding 5 years or at time of Special Surveys, or as part of statutory surveys at interval specified by the Flag Administrations. Where the deadweight survey indicates a change from the calculated light ship displacement in excess of 1% of the operating displacement, an inclining test is to be conducted.

#### Note:

Council Chairman announced approval of UR Z15(ex D12) on 15 May 1999 subject to the following conditions:

- Deletion of paragraph 2.2.2;
- Adoption of UR Z18(ex M20) for Z15.5.1 and Z15.6.1;
- Editorial corrections.

UR Z18 was finally approved on 23 November 2001(9056aIAe, 29/01/2002):

- M20 was deleted;
- Z18 "Periodical Survey of Machinery" created excluding tail shaft survey requirements;
- Z21 created for the tail shaft survey requirements.

ABS suggested to re-word Z15.5.1 to avoid the need for filing of reservations on Z15.5.1 simply because it invokes the requirements of Z21. Agreed.

\*\*\*\*\*

Date of submission: 14 August 2002  
By the Permanent Secretariat

# IACS

INTERNATIONAL ASSOCIATION OF CLASSIFICATION SOCIETIES LTD.

PERMANENT SECRETARIAT: 4 Matthew Parker Street

Westminster, London SW1H 9NP, UNITED KINGDOM

TEL: +44(0)207 976 0660

INTERNET: [permsec@iacs.org.uk](mailto:permsec@iacs.org.uk) Web Site: [www.iacs.org.uk](http://www.iacs.org.uk)

August 2024

## History Files (HF) and Technical Background (TB) documents for URs concerning Electrical and Electronic Installations (UR E)

Res. No.	Title	Current Rev.	HF/TB?
UR E1	Governing characteristics of generator prime movers	1975	No
UR E2		Deleted (Dec 1996)	No
UR E3		Deleted (Dec 1996)	No
UR E4	Earthing of non-current-carrying parts	Deleted (Jun 2000)	TB
UR E5	Voltage and frequency variations	Rev.1 Sept 2005	TB
UR E6		Deleted	No
UR E7	Cables	Rev.5 Feb 2021	HF
UR E8	Starting arrangements of internal combustion engines	Deleted (Dec 2003)	TB
UR E9	Earthing and bonding of cargo tanks/process plant/piping systems for the control of static electricity	Rev.1 Oct 2012	TB
UR E10	Test Specification for Type Approval	Rev.10 Aug 2024	HF
UR E11	Unified Requirements for systems with voltages above 1kV up to 15kV	Rev.4 Feb 2021	HF
UR E12	Electrical equipment allowed in paint stores and in the enclosed spaces leading to paint stores	Rev.2 Dec 2020	HF
UR E13	Test requirements for rotating machines	Corr.1 May 2022	HF
UR E14		Not adopted	No

<b>Res. No.</b>	<b>Title</b>	<b>Current Rev.</b>	<b>HF/TB?</b>
UR E15	Electrical services required to be operable under fire conditions and fire resistant cables	Rev.4 Dec 2020	HF
UR E16	Cable trays/protective casings made of plastic materials	June 2002	TB
UR E17	Generators and Generator systems, having the ship's propulsion machinery as their prime mover, not forming part of the ship's main source of electrical power	Rev.1 Feb 2021	HF
UR E18	Recording of the Type, Location and Maintenance Cycle of Batteries	Rev.1 Dec 2014	HF
UR E19	Ambient Temperatures for Electrical Equipment installed in environmentally controlled spaces	Rev.1 Sept 2005	TB
UR E20	Installation of electrical and electronic equipment in engine rooms protected by fixed water-based local application fire-fighting systems (FWBLAFFS)	Rev.1 Jun 2009	HF
UR E21	Requirements for uninterruptible power system (UPS) units	Rev.2 Feb 2024	HF
UR E22	Computer-based systems	Rev.3 June 2023	HF
UR E23	Selection of low voltage circuit breakers on the basis of their short circuit capacity and co-ordination in service	Deleted Mar 2011	TB
UR E24	Harmonic Distortion for Ship Electrical Distribution System including Harmonic Filters	Dec 2018	HF
UR E25	Failure detection and response of all types of steering control systems	Rev.2 Mar 2022	HF
UR E26	Cyber resilience of ships	Rev.1 Nov 2023	HF
UR E27	Cyber resilience of on-board systems and equipment	Rev.1 Sep 2023	HF

**IACS UR E4 (1978)**  
**Earthing of non-current-carrying parts**

**Technical Background Document**

**Objective and Scope:**

The objective was to review of UR E4 taking into account the relevant standard IEC60092-401.

The scope was to delete or correct UR E4 in accordance with IEC standard.

**Source of Proposed Requirements:**

The proposed requirements have been based on the present Rule requirements of the IACS members and standard IEC60092-401.

**Points of Discussion:**

WP/EL unanimously agreed to delete UR E4. This UR does not reflect practice as exemplified in IEC60092-401 'Electrical installation in ships. Part 401: Installation and test of completed installation' and does not answer the present status of affairs.

# Technical Background Document

## E5 (Rev.1, Sept. 2005)

### IACS WP/EL Task No.67

To specify the voltage tolerance for DC distribution systems in the Unified Requirement E5 “Voltage and frequency variations”

#### Objective and Scope:

The main aim of this Task is to add new requirement of the voltage variations for d.c. distribution system in UR E5 taking into consideration the relevant requirements and standards.

#### Background for the Proposed Revision:

The IEC60092-101 has been amended since 1995 and new paragraphs related with the characteristics of power supply systems have been added. It makes reference to the voltage and frequency variations for both a.c. and d.c. distribution systems. However, the existing UR E5 which was adopted in 1979 has not stated the voltage variations for d.c. distribution systems but also stated the voltage and frequency variations for a.c. distribution systems.

It is timely that the allowable voltage variations for d.c. distribution systems are stated in E5 taking account of the currently increasing number of the d.c. control and instrumentation equipment in ships.

#### Points of Discussion:

First, since the combination systems of battery and its charger are common as d.c. distribution systems in ships, NK proposed the new requirement of d.c. voltage variations for such systems as a standard model in ships taking account of the following statutory regulations and international standards. It was + 12% to – 22%, which overcomes the variation of  $\pm 10\%$  in the 3rd bullet.

-SOLAS II-1/42.3.2.1, 42.4, 43.3.3.1 and 43.4:

The allowable battery source quality is  $\pm 12\%$ .

-IEC60092-352 (1997) Clause 10:

The allowable voltage drop of the cable from a battery to a load is  $-10\%$ .

-IEC60092-101 amendment 1(1995-04) Clause 2.8.3:

The allowable voltage variation for d.c. electrical equipment is  $\pm 10\%$ .

After that, during the discussion, the following points were clarified.

- The requirement of E5 is intended for the voltage and frequency variations on the basis of designed rated value of the electrical equipment, i.e. the value is given at the consumer side.
- The new requirement should be developed based on the IEC60092-101 because the voltage variations specified in it are assumed to include the source quality and the voltage drop of the cable from a source to a consumer.
- Since the essential d.c. electrical equipment in ships are control and instrumentation equipment, the relevant requirement in UR E10 (Rev.4, May 2004), which are equivalent to IEC60092-504 (2001-03), should reflect to the new requirement.

Consequently, it was decided to approve the new requirement as a revision of E5 on the following concepts:

- (1) The d.c. distribution systems are divided into two categories. One of them is for components supplied by d.c. generators or converted by rectifiers, and the other is for components supplied by electrical batteries.
- (2) The allowable voltage variations are developed in each case of (1) above according to the value specified in IEC60092-101 amendment 1(1995-04) Clause 2.8.3 and IEC60092-504 (2001-03) Table1 item 4a.

Submitted by WP/EL Chairman  
31 Jan 2005



## UR E7 "Cables"

### Summary

In Rev.5 of this Resolution, the way to refer to instruments other than those specified by IACS was unified.

### Part A. Revision History

Version no.	Approval date	Implementation date when applicable
Rev.5 (Feb 2021)	12 February 2021	1 July 2022
Rev.4 (Apr 2016)	21 April 2016	1 July 2017
Rev.3 (May 2006)	16 May 2006	-
Rev.2 (June 2000)	15 June 2000	-
Rev.1 (1990)	1990	-
New (1975)	1975	-

#### • Rev.5 (Feb 2021)

##### 1 Origin of Change:

- Other (Update to comply with the required format when industry standards are referred to)

##### 2 Main Reason for Change:

There was a need to update this UR to comply with the following format when industry standards are referred to:

*[Standard Designation], [version/revision, if applicable], [year of publication] (examples: API Spec 2F, 6th Edition, 1997; ISO 4624, 2002), where [version/revision, if applicable] and/or [year of publication] are decided by IACS and are not necessarily to be the current/latest version.*

##### 3 List of non-IACS Member classification societies contributing or participating in IACS Working Group:

None

##### 4 History of Decisions Made:

None

##### 5 Other Resolutions Changes:

None

## 6 Any hinderance to MASS, including any other new technologies:

None

## 7 Dates:

Original Proposal: 28 October 2019 (Ref: PM18939\_IMd)  
Panel Approval: 9 November 2020 (Ref: PM20906\_IMf)  
GPG Approval: 12 February 2021 (Ref: 20206cIGb)

### • Rev.4 (April 2016)

#### .1 Origin of Change:

- Suggestion by IACS member (e-mail dated 27th January 2015)

#### .2 Main Reason for Change:

The withdrawal or replacement of several IEC standards mentioned in the current UR E7 (Rev.3) makes it necessary to revise the UR content accordingly. Moreover, further consideration should be given to cables not manufactured to the IEC publications identified in the UR.

#### .3 List of non-IACS Member Classification Societies contributing through the TC Forum and/or participating in IACS Working Group:

Form A was agreed at the 21st Panel Meeting (March 2015).  
The final text has been adopted by the Machinery Panel by correspondence in December 2015.

#### .4 History of Decisions Made:

None

#### .5 Other Resolutions Changes:

None

#### .6 Dates:

Original Proposal: 27 January 2015 made by Machinery Panel  
Panel Approval: 25 February 2016 (Ref: PM15401)  
GPG Approval: 21 April 2016 (Ref: 15045\_IGb)

### • Rev.3 (May 2006)

No history file available

### • Rev.2 (June 2000)

No history file or TB document available

- **Rev.1 (1990)**

No history file available

- **New (1975)**

No history file or TB document available

## Part B. Technical Background

List of Technical Background (TB) documents for UR E7:

Annex 1. **TB for Rev.1 (1990)**

See separate TB document in Annex 1.

Annex 2. **TB for Rev.3 (May 2006)**

See separate TB document in Annex 2.

Annex 3. **TB for Rev.4 (Feb 2016)**

See separate TB document in Annex 3.

Annex 4. **TB for Rev.5 (Feb 2021)**

See separate TB document in Annex 4.



**Note:** *There is no separate Technical Background (TB) document for the New (1975), nor for Rev.2 (June 2000).*

**IACS UR E7 (1975, Rev. 1 1990)**  
**Cables and insulated wires**

**Technical Background Document**

**Objective and Scope:**

The objective was to review of UR E7 taking into account the present Rule requirements of the IACS members.

The scope was to delete reference to “insulated wires” and amend reference to IEC92 series to read – IEC60092.

**Source of Proposed Requirements:**

The proposed requirements have been based on the present Rule requirements of the IACS members.

**Points of Discussion:**

WP/EL unanimously agreed to delete reference to “insulated wires”, as “insulated wires” are not to be of a type approved by the Classification Society in accordance with Rule requirements of the IACS members.

**IACS UR E7 (Rev. 3, May 2006)**  
**IACS Machinery Panel Task No.PM5407**

**Technical Background document**

**Objective and Scope:**

The aim of this Task is to revise UR E7 to ensure that valid and relevant standards are referred to.

**Background for the Proposed Revision:**

- IEC has withdrawn the referenced standard IEC 60092-3.
- The standard was replaced with a number of other standards, this is duly marked in documents found in the IEC database under the technical committee SC 18A (attached)
- The same committee which is responsible for developing standards for ship cables has developed further standards for special cables used onboard.
- It is therefore opportune to add these standards to UR E7 in order to make the list of cable standards complete.

**Permanent Secretariat Note:**

1. GPG agreed that no uniform implementation date was needed.
- 2.1 Machinery Panel Member proposed to modify para. 3 in order to give the UR its meaning. It was further improved by the GPG Chairman as follows:

MCH Panel's proposed para 3	Panel Member's proposed para.3 (further modified by the GPG Chairman, and 3/4 majority of GPG members agreed to)
<p><i>3. Cables manufactured to other standards than those specified in 2 are subject to special consideration by the Classification Society in each particular case."</i></p>	<p><i>3. Cables manufactured and tested to standards other than those specified in 2 will be accepted provided they are in accordance with an acceptable and relevant international or national standard.</i></p> <p><b>Reason:</b> <i>This is to take exception to the inclusion of "special consideration" in the UR and making the point, as has been made in the past, that the inclusion of "special consideration" within a UR, without specifying the requirements or criteria for how that "special consideration" is to be applied does not constitute a "unified</i></p>

	<p>requirement" since it leaves the determination of acceptability to each Society. Member therefore proposed a text it considered to constitute a "unified requirement" not relying on "special consideration."</p>
--	--

2.2 It was then challenged by another Panel Member telling that:

Member considers the phrase "acceptable and relevant international or national standard" too vague and reducing the responsibility of Class for this matter. Who knows whether "acceptable and relevant" national standards of one country will be applicable in other country?

The phrase "subject to special consideration by the Classification Society in each particular case" is more versatile and covers all cases not mentioned in items 1 and 2 of E7.

As a compromise we may add new item 4 to E7 (after item 3 proposed by IGb):

"4. Cables manufactured to other standards than those specified in 2 and 3 are subject to special consideration by the Classification Society in each particular case."

But the version of E7 proposed by the Machinery Panel seems better.

2.3 With detailed 'Reasons' provided in the table above, 3/4 majority support of GPG remained unchanged. GPG approved.

3. Panel Member

3.1 A member stated that it was opposed to the revision. This member maintained the position that it is not sure that national standards acceptable to one Society would be acceptable to all other Societies, so it does not consider that the new UR E7 revision will work. A Member advises that it prefers the text proposed by the Machinery Panel to GPG circulated with IGa, 10 March.

3.2 In that respect, Council Chairman pointed out that the text of item 3 of the UR:

3. Cables manufactured and tested to standards other than those specified in 2 will be accepted provided they are in accordance with an acceptable and relevant international or national standard.

leaves it to each Society to determine, for themselves, whether they consider a particular national or international standard to be acceptable and relevant or not.

3.3 This Member maintained its position.

Attached. 1. Comparison table

## Attachment to UR E7 Rev.3 Technical Background

Publications withdrawn	Year of withdrawal	TC/SC	Replaced by
IEC 60092-3-am6 Ed.2.0 (1984)	1996	18	IEC 60092-350 Ed.2.0 (2001)* IEC 60092-351 Ed.3.0 (2004)*
IEC 60092-3-am5 Ed.2.0 (1979)	1996	18	IEC 60092-351 Ed.3.0 (2004)*
IEC 60092-3-am6 Ed.2.0 (1984)	1996	18	IEC 60092-352 Ed.2.0 (1997) IEC 60092-353 Ed.2.0 (1995)* IEC 60092-359 Ed.1.0 (1987) IEC 60092-376 Ed.2.0 (2003)*
IEC 60092-3-am5 Ed.2.0 (1979)	1996	18	IEC 60092-352 Ed.2.0 (1997) IEC 60092-353 Ed.2.0 (1995)* IEC 60092-359 Ed.1.0 (1987) IEC 60092-376 Ed.2.0 (2003)* IEC 60092-350 Ed.2.0 (2001)*
IEC 60092-3-am4 Ed.2.0 (1974)	1996	18	60092-353 Ed.2.0 (1995)* IEC 60092-359 Ed.1.0 (1987) IEC 60092-376 Ed.2.0 (2003)* IEC 60092-350 Ed.2.0 (2001)* IEC 60092-351 Ed.3.0 (2004)*
IEC 60092-3-am3 Ed.2.0 (1973)	1996	18	60092-353 Ed.2.0 (1995)* IEC 60092-359 Ed.1.0 (1987) IEC 60092-376 Ed.2.0 (2003)* IEC 60092-350 Ed.2.0 (2001)* IEC 60092-351 Ed.3.0 (2004)*
IEC 60092-3-am2 Ed.2.0 (1971)	1996	18	60092-376 Ed.2.0 (2003)* IEC 60092-350 Ed.2.0 (2001)* IEC 60092-351 Ed.3.0 (2004)*
IEC 60092-3-am1 Ed.2.0 (1969)	1996	18	60092-353 Ed.2.0 (1995)* IEC 60092-359 Ed.1.0 (1987) IEC 60092-376 Ed.2.0 (2003)* IEC 60092-350 Ed.2.0 (2001)* IEC 60092-351 Ed.3.0 (2004)*
IEC 60092-3-am2 Ed.2.0 (1971)	1996	18	IEC 60092-352 Ed.2.0 (1997) IEC 60092-353 Ed.2.0 (1995)* IEC 60092-359 Ed.1.0 (1987)
IEC 60092-3-am1 Ed.2.0 (1969)	1996	18	IEC 60092-352 Ed.2.0 (1997)
IEC 60092-3 Ed.2.0 (1965)	1996	18	IEC 60092-352 Ed.2.0 (1997) IEC 60092-353 Ed.2.0 (1995)* IEC 60092-359 Ed.1.0 (1987) IEC 60092-376 Ed.2.0 (2003)* IEC 60092-350 Ed.2.0 (2001)* IEC 60092-351 Ed.3.0 (2004)*
IEC 60092-3-am4 Ed.2.0 (1974)	1996	18	IEC 60092-352 Ed.2.0 (1997)
IEC 60092-3-am3 Ed.2.0 (1973)	1996	18	IEC 60092-352 Ed.2.0 (1997)
IEC/TR 60092-390 Ed.1.0 (1997)	2005	18A	withdrawn
IEC 60092-505 Ed.3.0 (1984)	2002	18	IEC 61892-5 Ed.1.0 (2000)



## Technical Background (TB) document for UR E7 (Rev.4 Apr 2016)

### 1. Scope and objectives

The withdrawal or replacement of several IEC standards mentioned in the actual UR E7 makes it necessary to revise the UR content accordingly. Moreover, further consideration should be given to cables not manufactured to the IEC publications identified in the UR.

### 2. Engineering background for technical basis and rationale

The specific procedures for revision of UR E7 are as follows:

- a) Identify the standards mentioned in the UR that have been withdrawn or replaced by new ones.
- b) Consider approach for cables not manufactured to IEC standards identified in the UR
- c) Revise UR E7 accordingly.
- d) Specify the implementation date of the UR.

### 3. Source/derivation of the proposed IACS Resolution

N/A

### 4. Summary of Changes intended for the revised Resolution:

UR E7.2 has been updated on the basis of the following IEC standard equivalency Table:

IEC Publications in E7	Replaced by
60092-350	N/A
60092-351	IEC/TR 60092-360
60092-352	N/A
60092-353	N/A
60092-354	N/A
60092-359	IEC/TR 60092-360
60092-373	IEC/TR 60092-370
60092-374	IEC/TR 60092-370
60092-375	IEC/TR 60092-370
60092-376	N/A

### 5. Points of discussions or possible discussions

One member proposed to consider adding a wording to exempt communication cables for non-important consumers from the type approval requirement whereas another member considered it applicable to all cables.

All the member comments were in favor of considering an equivalency of "international or national standards" to IEC Standards listed in paragraph 2. The following amendment was proposed by the Chairman accordingly:

*“3. Cables manufactured and tested to standards other than those specified in 2 will be accepted provided they are of an equivalent or higher safety level than those listed in paragraph 2 in accordance with an acceptable and relevant international or national standard.”*

One member finally proposed the following text:

*“3. Cables manufactured and tested to standards other than those specified in 2 will be accepted provided they are in accordance with an acceptable and relevant international or national standard and are of an equivalent or higher safety level than those listed in paragraph 2.”*

One member suggested introducing the following relaxation of the requirement in paragraph 3 for those specific cables (e.g. flexible cables used for crane, etc.) which would be very hard to comply with the proposed amendment to paragraph 3. In this regard, following text was suggested to be added to the end of paragraph 3:

*“...However, cables such as flexible cable, fiber-optic cable, etc. used for special purposes may be accepted provided they are manufactured and tested in accordance with the relevant standards accepted by the Classification Society.”*

The following text was finally adopted by the Machinery Panel:

1. Cables are to be of a type approved by the Classification Society.
2. Cables manufactured in accordance with the relevant recommendations of IEC Publication 60092-350, ~~60092-351~~, 60092-352, 60092-353, 60092-354, ~~60092-359~~, ~~60092-360~~ ~~60092-373~~, ~~60092-374~~, ~~60092-375~~, ~~60092-370~~ and 60092-376 will be accepted by the Classification Society provided that they are tested to its satisfaction.
3. Cables manufactured and tested to standards other than those specified in 2 will be accepted provided they are in accordance with an acceptable and relevant international or national standard and are of an equivalent or higher safety level than those listed in paragraph 2. However, cables such as flexible cable, fiber-optic cable, etc. used for special purposes may be accepted provided they are manufactured and tested in accordance with the relevant standards accepted by the Classification Society.

## **6. Attachments if any**

N/A.

## Technical Background (TB) document for UR E7 (Rev. 5 Feb 2021)

### 1. Scope and objectives

UR E7(Rev.4) does not reflect the agreed format for referencing the IEC standards. Rev.5 has been developed to comply with the agreed format.

### 2. Engineering background for technical basis and rationale

#### Format for references to Industry standards

**Format:**

*[Standard Designation], [version/revision, if applicable], [year of publication]*  
*(examples: API Spec 2F, 6th Edition, 1997; ISO 4624, 2002), where*  
*[version/revision, if applicable] and/or [year of publication] are decided by IACS and*  
*are not necessarily to be the current/latest version.*

### 3. Source/derivation of the proposed IACS Resolution

None

### 4. Summary of Changes intended for the revised Resolution

UR E7 has been updated to specify the revision/version of the IEC standards as follows:

IEC standards	Replaced by
IEC 60092-350	IEC 60092-350:2020
IEC 60092-352	IEC 60092-352:2005
IEC 60092-353	IEC 60092-353:2016
IEC 60092-354	IEC 60092-354:2020
IEC 60092-360	IEC 60092-360:2014
IEC 60092-370	IEC 60092-370:2019
IEC 60092-376	IEC 60092-376:2017

### 5. Points of discussions or possible discussions

The investigation for the year of publication of the standards started beginning of 2019. At that time 60092-370:2009 was applicable; however as of November 2019, a new edition of the aforesaid standard has been published, therefore the 2019 edition is stated in the UR.

### 6. Attachments if any

None

## **Technical Background –**

**(New) UR M61 ‘Starting arrangements of internal combustion engines’**

**deletion of**

**UR M49 ‘Availability of machinery’ and**

**UR E8 ‘Starting arrangements of internal combustion engines’**

### **1. General**

There had been a long discussion in 1998-1999 with respect to the definitions of “deadship” and “blackout”. The main reason was that the SOLAS definitions of blackout and deadship condition were quite different from those given in UR M49 (Rev.1, 1996).

### **2. UR M 49**

At present, Rev.1 of M49 (1996) is effective.

In 1998, WP/MCH suggested that a footnote be added to UR M49.1 in order to make reference to SOLAS II-1/42.3.4 and 43.3.4. GPG 44 (1998) also considered that the existing UR M49.1 was to be isolated from M49.2, the latter together with UR E8 being relocated as new UR M61.

At the same time, GPG 44 decided that approval of Rev.2 of UR M49 be put in abeyance until the development of UI SC 124 was finalized.

UR M49 (Rev.2) and M61(New), so prepared by the Permanent Secretariat, were passed to WP/MCH for review. In particular, WP/MCH was to clarify the scope of application of M49 and M61 to non-SOLAS ships (part of WP/MCH Task 41).

WP/MCH reported to GPG 52 (March 2002) that M49 should apply to all ships subject to further debate. WP/MCH consequently suggested in March 2003 (GPG 54) that an application note should be added to UR M49 to the extent that M 49 applies to non-SOLAS vessels. The draft footnote read: *These requirements (M49) apply only to ships required to comply with SOLAS [and ships above 200 GRT].* WP/MCH Chairman later confirmed in consultation with experts that the square bracket be removed. However, Council did not approve it (June 2003).

### **3. UI SC 124**

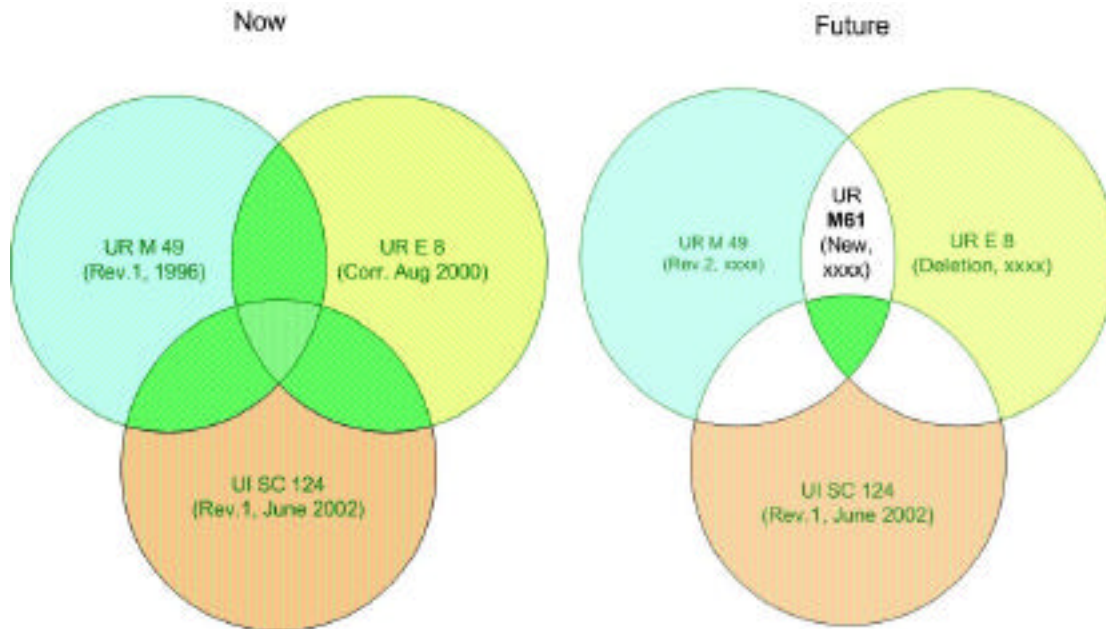
GPG 44 (1998) found that the draft text of SC 124 did not clarify the definition of “deadship” and “blackout”. UI SC 124 was then withdrawn and WP/MCH was tasked to develop an interpretation of the two terms with a view to elaborating a definition to be used in UR M49 and SC 124 and if necessary other resolutions. However, WP/MCH failed to reach a common understanding of the term “deadship condition” in 1998.

Hence, GPG 46 (1999) attempted to develop a generally agreeable definition.

*With assistance from the WP/MCH, GPG/Council finally approved UI SC 124 in*

May 1999. It was submitted to IMO DE (DE 43/Inf.5). Revised in June 2002 and submitted to IMO MSC 76.

### Status at this point



#### 4. Tasking of WP/MCH

In August 2003 GPG tasked WP/MCH to consider

M49:

- whether the text of UR M49.1(draft Rev.2, xxxx) should be amended in light of UI SC 124(Rev.1, June 2002) ;
- whether the wording [and ships above 200GRT] should be deleted from the note to UR M49(draft Rev.2, xxxx) or retained;

M61:

- whether the text of new draft UR M61 is appropriate, taking into account 7225\_NVc of 26 May 98 from the then GPG Chairman.

#### 5 WP/MCH submission

The WP concluded that text of UR M 61 is not adequate and changes suggested previously by GPG need to be introduced. However with the introduction of these changes M61.3 would become a word by word copy of SOLAS regulation II-1/44. Therefore WP did not see any need for this requirement as a class one and proposed to GPG to delete M61.3.

IMO has adopted MSC/Circ.736 (which is recommendatory) that interpreted SOLAS regulation II-1/44.1. There was a need to draft a UI that would simply reference the relevant paragraphs of this circular with respect to the regulation in question. This arrangement will create uniform application on behalf of the Flags in cases where a particular Flag is silent on circular application.

With the publication of the revised SC124 the need for UR M49 as it stands were now be brought into question. The origins of the UR M49 stem from SOLAS II-1/26.4 with the need to define what "dead ship" conditions entailed. In view of the latest SC124 it would now seem sensible to make a new UIs for SOLAS II-1/26.4 and HSC 9.1.5 and delete M49. In doing this it would make it clear that the requirements are only applicable to SOLAS/HSC vessels and obviate the discussions regarding the notes to M49. The definition of "dead ship" in the new UIs would be consistent with SC124.

With the above in mind WP/MCH:

- i) proposed to delete M61.3,
- ii) suggested to draft a UI that would reference relevant paragraphs of SOLAS Reg. II-1/44.1 and MSC/Circ.736,
- iii) sought approval for the deletion of UR M49 and drafting of UI for SOLAS II-1/26.4 and HSC 9.1.5.

GPG concurred and approved the subsequent drafts and deletion of UR M49 and UR E8 (as per 3097cIGf of 12 November 2003; tacit 19 November) .

\*\*\*\*\*

Permanent Secretariat 21 November 2003.

## UR E9 “Earthing and bonding of cargo tanks/ process plant/piping systems for the control of static electricity”

### Part A. Revision History

Version no.	Approval date	Implementation date when applicable
Rev.1 (October 2012)	29 October 2012	1 January 2014
NEW (1988)	<i>No record</i>	-

- **Rev.1 (October 2012)**

**.1 Origin for Change:**

Other (OCIMF)

**.2 Main Reason for Change:**

OCIMF highlighted cases of valve installations on board product carriers that were improperly bonded to the hull, and as a consequence, the resistance between the valve and the hull of the ship was higher than required by E9.1

It resulted that wafer-type valves were involved, and due to their design, the connecting bolts, unlike for other type of valves, did not provide a proper means of bonding the valve to the hull.

**.3 List of non-IACS Member classification societies contributing through the TC Forum and/or participating in IACS Working Group:**

None.

**.4 History of Decisions Made:**

Form A approved 11th April 2011.

**.5 Other Resolutions Changes**

None.

**.6 Dates:**

Original proposal: 30<sup>th</sup> June 2011 Made by: Machinery Panel

Panel Approval: 07 September 2011

GPG Approval: 29 October 2012 (Ref. 11075\_IGd)

- **NEW (1986)**

No TB document available.

## Part B. Technical Background

List of Technical Background (TB) documents for UR E9:

Annex 1. **TB for Rev.1 (October 2012)**

See separate TB document in Annex 1.



**Note:** *There are no separate Technical Background (TB) document for the original resolution (1988).*



## **Technical Background for UR E9 Rev.1, Oct 2012**

### **1. Scope and objectives**

OCIMF highlighted cases of valve installations on board product carriers that were improperly bonded to the hull, and as a consequence, the resistance between the valves and the hull of the ship was higher than required by E9.1.

The UR is to be modified to improve its clarity and avoid re-occurrence of the highlighted cases.

### **2. Engineering background for technical basis and rationale**

Normally valves are connected to the piping system by bolts; unless the valve or piping are applied with a heavy layer of paint before fitting the bolts, the bolts also electrically bond the valve to the piping, and the piping system is properly bonded to the hull structure, therefore it is not normally needed to have separate bonding straps connected to the valves.

An analysis of the case however revealed that wafer-type valves were involved; wafer type valves are not attached by bolts to the piping flange, but just squeezed in between two flanges, often with the additional use of a gasket and the bolts connect the two flanges without even touching the valve.

Therefore, unless the gaskets are electrically conductive, the valve body will be electrically isolated from the piping.

### **3. Source/derivation of the proposed IACS Resolution**

SOLAS Reg. II-2/4.5.3 Cargo Tank Venting

SOLAS Reg. II-2/11.6 Protection of cargo tank structure against pressure or vacuum in tankers.

### **4. Summary of Changes intended for the revised Resolution:**

- In order to better identify the cases which require a bonding strap and call the surveyor attention to wafer-style valve with non-conductive (e.g. PTFE) gaskets or seals.

- Instead of "earth" use the term "the hull of the ship".

### **5. Points of discussions or possible discussions**

The term "wafer-style valve" was subject to discussions, but it was agreed to keep this term in the document.

### **6. Attachments if any**

None

## UR E10 “Test Specification for Type Approval”

### Summary

Item 8 (inclination test) is revised for the part relevant to Gas Carriers and Chemical Carrier, in alignment with Note 3 to M46.2 which is updated accommodating the reference clause nos. of the IGC Code and the IBC Code that were previously specified in UI SC6 and UI SC290. In parallel, the reference standards are also updated as per the latest and valid version.

### Part A. Revision History

Version no.	Approval date	Implementation date when applicable
Rev.10 (August 2024)	26 August 2024	1 January 2026
Rev.9 (August 2023)	07 August 2023	1 July 2024
Corr.1 (Jan 2022)	16 January 2022	-
Rev.8 (Feb 2021)	12 February 2021	1 July 2022
Rev.7 (Oct 2018)	25 October 2018	1 January 2020
Rev.6 (Oct 2014)	31 October 2014	1 January 2016
Rev.5 (Dec 2006)	13 December 2006	1 January 2008
Rev.4 (May 2004)	31 May 2004	-
Corr.1 (July 2003)	16 July 2003	-
Rev.3 (May 2001)	17 May 2001	-
Rev.2.1 (July 1999)	28 July 1999	-
Rev.2 (1997)	12 May 1997	-
Rev.1 (1993)	1993	-
New (1991)	1991	-

#### • Rev.10 (August 2024)

##### 1 Origin of Change:

- Suggestion by IACS member

##### 2 Main Reason for Change:

Reference clause nos. of the IGC Code and the IBC Code which are the main part of interpretation in UI SC6 and UI SC290 have been transferred to UR M46 (Note 3 to M46.2). As there is similar sentence in item 8 of UR E10, the relevant part of item 8 is to be revisited for update.

Taking the opportunity, the latest edition of the reference standards are also checked and updated accordingly.

##### 3 List of non-IACS Member classification societies contributing or participating in IACS Working Group:

None.

#### **4 History of Decisions Made:**

The Panel considered the revision of UI SC6, UI SC290 and UR M46, and after deliberations decided to delete the redundant UIs (i.e. UI SC6 and UI SC290) and add reference clause nos. of the IGC Code and the IBC Code to UR M46 (Note 3 to M46.2).

In the course of discussion, it was found that similar requirements as Note 3 to M46.2 is present in item 8 of UR E10 (inclination test), and the Panel decided to update relevant part of UR E10 as well.

#### **5 Other Resolutions Changes:**

- UI SC6
- UI SC290
- UR M46

#### **6 Any hinderance to MASS, including any other new technologies:**

None.

#### **7 Dates:**

Original Proposal:	19 January 2024	(Ref: PM24002_RIa)
Panel Approval:	02 July 2024	(Ref: PM24002_IMf)
GPG Approval:	26 August 2024	(Ref: 24102bIGe)

#### **• Rev.9 (August 2023)**

##### **1 Origin of Change:**

- Suggestion by IACS member

##### **2 Main Reason for Change:**

The industry standards year of reference is indicated in the UR pursuant to IACS policy. The modification clarifies how to proceed when latest standard is different from the one indicated in the UR, especially when the latest is less demanding or with hardly comparable differences.

##### **3 List of non-IACS Member classification societies contributing or participating in IACS Working Group:**

None.

#### **4 History of Decisions Made:**

1. Members agree to the proposal, which is reflected in the Note of the table, made in PM20906kIMk that a later revision of the specified standard in the UR may be used if technical specifications are deemed equivalent by the Society.

2. In line 14, additionally to IEC 61000-4-3:2020, the previous version of the standard, IEC 61000-4-3:2006+AMD1:2007+AMD2:2010, was also added as proposed in PM20906kIMj and agreed by qualified majority of member.

3. In PM20906kIMk, implementation date has been chosen to be 1 July 2024, considering the time each member needs to amend their rules and considering clause C5.2.2-4 of IACS Procedures Volume 1.

Additionally, members agreed to avoid retroactively applying UR E10 to existing types of equipment which have already been approved.

## **5 Other Resolutions Changes:**

None.

## **6 Any hinderance to MASS, including any other new technologies:**

None.

## **7 Dates:**

Original Proposal	: 26 November 2021	(Ref: PM20906kIMg)
Panel Approval	: 14 April 2023	(Ref: PM20906kIMl)
GPG Approval	: 07 August 2023	(Ref: 20206iIGc)

## **• Corr.1 (Jan 2022)**

### **1 Origin of Change:**

- Suggestion by IACS member

### **2 Main Reason for Change:**

To correct uniform application statement No.4 in Note of Rev.8 so that it is simply to be applied based on the "application for type approval" date only.

This is to avoid confusions due to three types of implementation concept based on:

1) the date specified in the implementation statement (e.g. application statements No. 1 and 2) not referred to the dates in 2) and/or 3) below;

2) the date of "application for type approval" of the equipment (e.g. application statements No. 3 and 7); and

3) the date of "contract for construction" of the ship (e.g. application statement No.4)."

**3 List of non-IACS Member classification societies contributing or participating in IACS Working Group:**

None.

**4 History of Decisions Made:**

During the discussion, a need for flexibility of application of the technical criteria specified in UR E10 was considered, but it was agreed that such a need would not be necessary. This is to say that Rev.8 of this Resolution (including this corrigendum) is to be uniformly applied to equipment for which the date of "application for type approval" is dated on or after 1 July 2022.

**5 Other Resolutions Changes:**

None.

**6 Any hinderance to MASS, including any other new technologies:**

None.

**7 Dates:**

Original Proposal	: 27 April 2021	(Ref: PM20906kIMa)
Panel Approval	: 01 November 2021	(Ref: PM20906kIMe)
GPG Approval	: 16 January 2022	(Ref: 20206cIGf)

**• Rev.8 (Feb 2021)**

**1 Origin of Change:**

- Other (Update to comply with the required format when industry standards are referred to)

**2 Main Reason for Change:**

There was a need to update this UR to comply with the following format when industry standards are referred to:

*[Standard Designation], [version/revision, if applicable], [year of publication] (examples: API Spec 2F, 6th Edition, 1997; ISO 4624, 2002), where [version/revision, if applicable] and/or [year of publication] are decided by IACS and are not necessarily to be the current/latest version.*

**3 List of non-IACS Member classification societies contributing or participating in IACS Working Group:**

None.

**4 History of Decisions Made:**

None.

## 5 Other Resolutions Changes:

None.

## 6 Any hinderance to MASS, including any other new technologies:

None.

## 7 Dates:

Original Proposal	: 28 October 2019	(Ref: PM18939_IMd)
Panel Approval	: 09 November 2020	(Ref: PM20906_IMf)
GPG Approval	: 12 February 2021	(Ref: 20206cIGb)

### • Rev.7 (Sep 2018)

#### .1 Origin for Change:

- Suggestion by IACS member

#### .2 Main Reason for Change:

The main reason for revising the document was related to wireless applications, and what requirements that should apply to such equipment. Technology advancements and the use of wireless data communication links have increased electromagnetic frequencies, from 2 GHz to 6 GHz.

The electromagnetic compatibility (EMC) of these emissions at these higher frequencies on nearby equipment needs evaluation. UR E10 lists test requirements for electromagnetic and radiated emissions at frequencies up to 2 GHz depending on the maximum working frequency of the equipment under test in accordance with IEC 61000-4-3 and CISPR 16-2-1 and 16-2-3 respectively. Refer to test items nos. 14, 19 and 20 of UR E10 Rev.6. Accordingly, tests nos. 14 and 19 have been revised to address the increased electromagnetic frequencies. Moreover, test item 5 (dry heat) and the referenced Note 1 have been revised to align with Table 1/Item 7 and Note "d" of IEC60092-504:2016, respectively.

A change in the Notes of the Application statement was considered necessary following a query submitted by a member society after discussion at the 26<sup>th</sup> Panel meeting.

#### .3 List of non-IACS Member Classification Societies contributing through the TC Forum and/or participating in IACS Working Group:

None.

#### .4 History of Decisions Made:

The IACS Machinery Panel agreed to carry out the task by a Project Team. Forms A and 1 were agreed in the Panel on 23 April 2014. Forms A and 1 were approved by GPG on 9 May 2014.

PM17601 outcome (16 Jan. 2018) on the Notes of the implementation statement updated to address equipment type approval and installation on new constructed ships.

## **.5 Other Resolutions Changes**

UR E22

## **.6 Dates:**

Original Proposal: March 2014 Made by: Machinery Panel  
Panel Approval: September 2018 by Machinery Panel (Ref. 28<sup>th</sup> Panel meeting)  
GPG Approval: 25 October 2018 (Ref: 14062\_IGg)

## **• Rev.6 (Oct 2014)**

### **.1 Origin for Change:**

Suggestion by IACS member

### **.2 Main Reason for Change:**

The main reason for revising the document was related to wireless applications, and what requirements that should apply to such equipment. During the panels work, it was decided to isolate this as a separate task. The documents would also undergo a general review to decide possible needs for general improvements / clarifications.

### **.3 List of non-IACS Member Classification Societies contributing through the TC Forum and/or participating in IACS Working Group:**

None

### **.4 History of Decisions Made:**

The IACS Machinery Panel agreed to carry out the task by a Project Team.  
Form A & 1 were agreed in the Panel in Aug 2008.  
Forms were approved by GPG in September 2008.

## **.5 Other Resolutions Changes**

UR E22

## **.6 Dates:**

Original Proposal: August 2008 Made by: Machinery Panel  
Panel Approval: September 2014 by Machinery Panel (20<sup>th</sup> Panel meeting)  
GPG Approval: 31 October 2014 (Ref: 6206\_IGI)

## **• Rev.5 (Dec 2006)**

Refer to the TB document in Part B. No history file available.

- **Rev.4 (May 2004)**

Refer to the TB document in Part B. No history file available.

- **Corr.1 (July 2003)**

Refer to the UL History Section in the Blue Book. No history file or TB document available.

- **Rev.3 (May 2001)**

Refer to the TB document in Part B. No history file available.

- **Rev.2.1 (July 1999)**

Refer to the TB document in Part B. No history file available.

- **Rev.2 (1997)**

Editorial improvements including change of title. The rest requirements 4, 7, 9, 10, 11, 13, 14 & 15 are changed. New test requirements 16, 17, 18, 19, 20 & 21 are added.

No history file or TB document available.

- **Rev.1 (1993)**

No history file or TB document available.

- **New (1991)**

No history file or TB document available.



## Part B. Technical Background

List of Technical Background (TB) documents for UR E10:

- Annex 1. **TB for Rev.2.1 (July 1999)**  
See separate TB document in Annex 1.
- Annex 2. **TB for Rev.3 (May 2001)**  
See separate TB document in Annex 2.
- Annex 3. **TB for Rev.4 (May 2004)**  
See separate TB document in Annex 3.
- Annex 4. **TB for Rev.5 (Dec 2006)**  
See separate TB document in Annex 4.
- Annex 5. **TB for Rev.6 (Oct 2014)**  
See separate TB document in Annex 5.
- Annex 6. **TB for Rev.7 (Sep 2018)**  
See separate TB document in Annex 6.
- Annex 7. **TB for Rev.8 (Feb 2021)**  
See separate TB document in Annex 7
- Annex 8. **TB for Corr.1 (Jan 2022)**  
See separate TB document in Annex 8
- Annex 9. **TB for Rev.9 (Aug 2023)**  
See separate TB document in Annex 9
- Annex 10. **TB for Rev.10 (August 2024)**  
See separate TB document in Annex 10

**Note:** *There are no technical background (TB) documents exist for Original version (1991), Rev.1 (1993), Rev.2 (1997) and Corr.1 (July 2003).*

**Technical Background Document**  
**WP/EL Task 38 "To Review UR E10, Rev.2.1"**

**1. Objective and Scope:**

Correct an editorial nature error to test item 14 : "Radiated Radio Frequency" , i.e. replacing "80 kHz to 1 GHz" with "80 MHz to 1 GHz".

**2. Source of Proposed Requirements:**

The proposed correction was submitted by GPG correspondence (Mr.Kaji of NK message of 29 July 1998). IEC 1000-4-3 (1995) Standard.

**3. Points of Discussion:**

WP/EL unanimously agreed to correct test item 14 : "Radiated Radio Frequency" , i.e. replacing "80 kHz to 1 GHz" with "80 MHz to 1 GHz".

## **E 10 (Rev.3)**

### **Technical Background Document**

### **WP/EL Task 39 "Revision of IACS UR E10 Testing procedure for electrical, control and instrumentation equipment, computers and peripherals covered by classification"**

#### **Objective and Scope:**

To revise UR E10 in order to investigate the difference between IEC 60945, IEC60533 and to align with IEC Standards.

#### **Source of Proposed Requirements:**

IACS WP/EL 28th Progress Report  
IEC 60945, IEC 60533, IEC 60092-504 Standards

#### **Points of Discussion:**

The existing UR E10 had undergone an extensive review during the meeting. Test requirements are harmonized with IEC 60092-504 „Electrical Installations in Ships“ Part 504: Special features – Control and instrumentation“, IEC 60533 “Electrical and electronic installations in ships – Electromagnetic compatibility“ and IEC 60945 “Maritime navigation and radiocommunication equipment and systems. General requirements- Methods of testing and required test results“.

DNV proposed to add a new test concerning influence of mobile phones on electrical equipment. With some other changes the corrected draft of the UR agreed by WG was forwarded to GPG for consideration attached to the 30th WP/EL Progress Report

Submitted by WP/EL Chairman in January 2001

## Technical Background

### UR E10 (Rev.4)

**IACS WP/EL Task No.49** "To clarify the equipment to be covered by UR E10 "Type Test Specification" and to investigate the adequacy of the DC power supply tests in item 4 "Power supply variations" of the table in UR E10."

#### Objective and Scope:

1. To redefine more closely the equipment to which E10 is required to be applied.
2. To investigate if the test procedure for DC power supply voltage variation in item 4 a) of the Table "Type testing condition for equipment covered by E10.1" is adequate.

#### Source of Proposed Requirements:

IACS UR E10 (Rev. 3, May 2001)

Draft of AHG/COMP "Onboard Use and Application of Computers".

IEC Pub. 60092-504

#### Points of Discussion:

There appears to exist different interpretations among IACS member societies for the scope of applications of E10 for onboard equipment and systems, especially for onboard computer based systems and peripherals. At least, further breakdown of the listed equipment in E10.1 is necessary for uniform implementation of E10 among IACS member societies.

The existing UR E10 had undergone an extensive review during the meeting. ABS proposed to postpone this objective due to several reasons taking into account of the currently undergoing Tasks in IACS, e.g., L[5], AHG/COMP, AHG/EMC, etc.

However, during the discussion, it was decided that the scope of application in E10.1 was slimmed and the application of E10 was limited for "Type Approval".

NK submitted the investigation of the test procedure for DC power supply voltage variation in item 4 of the Table of E10. It appears that the duration time and the cycle period for "voltage cyclic variation" and "voltage ripple" are not specified for the test conditions of DC supply variation.

However having considered all *pro et contra* after discussion it was decided to stay tests without change as it is. Additionally it was proposed to investigate some suppositions in EMC/AHG.

It was decided to approve new Draft of UR E10 on following conditions:

- To change Type Test Specification in title and para.E10.1 of UR E10 to 'Test Specification for Type Approval'.
- To retain "monitoring, control protection and safety" and "interior communication" services and to delete all other services in the current E10.1.
- To stay 'voltage cycling variation' and 'voltage ripple' (para.4 of E10 Table) without change as it is.

With some other changes the corrected draft of the UR agreed by WG was forwarded to GPG for consideration attached to the 33rd WP/EL Progress Report.

**Technical Background Document  
UR E10 (Rev.5, Dec. 2006)**

**IACS Machinery Panel Task No. PM5603**

**Objective and Scope:**

The aim of this Task was to:

- 1) To align UR E10 with test requirements found in IEC 60068-2-6 test Fc
- 2) To examine UR E10 requirements on RMC/RFI in the light of the new edition of IEC 60945 and amend as found necessary
- 3) To unify low temperature test conditions between UR E10, UR M40 and other relevant industry standards (e.g. IEC 60945).

In addition minor alterations was introduced to enhance the quality of the test standard and to make it more up-to-date.

**Background for the Proposed Revision:**

Test number 3,

External power supply failure, special conditions for the test has been added if the equipment under test needs a longer time for start up, e.g. booting sequence and for equipment which requires booting.

**Points of Discussion:**

This has been added in order to ensure a uniform implementation of the test requirement.

Test number 7,

Vibration, last bullet in the comment field does not specify the limitations given in the IEC standard. A request from Siemens revealed the flaw in E10.

The limitations are of importance to ensure adequate stress level of the equipment under endurance test.

**Points of Discussion:**

When a resonance frequency is detected during vibration test, we have to ensure that no damage to the equipment is likely to occur at this frequency. This is done by performing an endurance test. In case several frequencies are detected the endurance test may be carried out as swipe test, but only within frequency limits specified.

This is agreed to be technically correct and introduced in E10.

Test number 15,

Conducted low Frequency, IEC 60945 has deleted the test Immunity to conducted low frequency interference.

**Points of Discussion:**

The test referred to in E10 was on the basis of IEC 60533, but the origin for IEC 60533 was IEC 60945.

We have therefore investigated whether this test is of relevance to ship installations. We have had confirmation from test laboratories performing the testing of equipment that it is, but that the test standard referred to is incorrect. We have therefore added a drawing to show an adequate test set-up which is suitable for performing this test.

This is agreed to be technically correct and introduced in E10.

Test number 21, flame retardant test where an alternative has been added.

**Points of Discussion:**

The test piece required for the test specified in IEC 60092-101 is very large and in many cases it is not available such large pieces for testing. IEC 60695-11-5 being a newer

standard does fulfil the intention of the IEC 60092-101 and may be used as an alternative. The evidence of flame retardation for cables is described sufficiently in IEC 60092-101.

Task number 3 was to unify low temperature test conditions between UR E10, UR M40 and other relevant industry standards (e.g. IEC 60945). This did not have any effect on the standard and is only enclosed as a reminder of the work being carried out.

### Points of Discussion:

In order to examine low temperature test standard an investigation of environmental conditions has been conducted.

Environmental conditions – elaboration of requirements in different standards:

#### M40

(1981)

### Ambient conditions – Temperatures

M40.1 The ambient conditions specified under M40.2 are to be applied to the layout, selection and arrangement of all shipboard machinery, equipment and appliances as to ensure proper operation.

#### M40.2 Temperatures

Air

Installations, components	Location, arrangement	Temperature range (°C)
Machinery and electrical installations <sup>1</sup>	In enclosed spaces	0 to +45
	On machinery components, boilers In spaces subject to higher and lower temperatures	According to specific local conditions
	On the open deck	-25 to +45

Water

Coolant	Temperature (°C)
Seawater	32
Charge air coolant inlet to charge air cooler	see UR M28

NOTES

1. Electronic appliances are to be suitable for proper operation even with an air temperature of +55°C.
2. The Classification Society may approve other temperatures in the case of ships not intended for unrestricted service.

### Conclusion:

Lower temperature in enclosed spaces is 0°C

### Low temperature test IEC 60945 (protected equipment)

-15 °C ± 3 °C

IEC 60945 states

(Equipment protected from the weather should not experience such low temperatures, and IEC 60721-3-6 gives +5 °C as the minimum temperature. However, since this standard deals with vital navigation and radiocommunication equipment which will be required to start operating in a dead ship, clause 8 calls for – 15 °C for protected equipment and –20 °C for portable (life saving) equipment.) IEC 60721-3-6 states: (IEC 60721-3-6 Classification of environmental conditions. Part 3: Classification of groups of environmental parameters and their severities. Ship environment, abstract: Classifies groups of environmental parameters and their severities to which a product is subjected when installed aboard a ship. Ships where products may be permanently or temporarily installed include ships propelled by mechanical means and ships not propelled by mechanical means.)

As we read IEC 60721-3-6 +5°C covers products installed in totally weather protected, heated and ventilated locations after warm-up, otherwise -25°C applies. This has been adopted by IEC 60945, but modified.

**E10**

IEC Publication 60068-2-1  
+5°C ± 3°C

**Overall conclusion:**

+5°C ± 3°C is correct for products installed in totally weather protected, heated and ventilated locations after warm-up. There may be equipment required to start operating in a dead ship condition which may need a lower temperature.

**Effect on E10.**

To keep the 5°C for the moment, but to return to the task when doing a total upgrade of the URs with respect to temperature limitations.

**Submitted by Machinery Panel Chair  
23 November 2006**

**Permanent Secretariat Note (December 2006):**

- Rev. 5 of UR E10 approved by GPG and Council, 13 December 2006 (6206\_IGc).
- Machinery Panel proposed implementation date of 1 January 2008 and this was agreed by GPG/Council.

## **Technical Background (TB) document for Rev.6 (Oct 2014)**

### **1 Scope and objectives**

- Adoption of tests for wireless applications used on board ships in response to queries from the industry.
- Proposal for a broad-band random vibration test according to IEC 60068-2-64 which is less dependent on the test-setup of the EUT than the test method according to IEC 60068-2-6 Test Fc.
- Proposal for a change of test parameters down to a temperature -5°C for the cold test. A temperature of +5 °C has absolutely no influence to the EUT.
- Adoption of revised international testing standards e.g. IEC 61000-4-4 (Burst).

### **2 Engineering background for technical basis and rationale**

Clarification of content necessary for test 2 (Performance test), test 5 (Dry heat), test 6 (Damp heat) alternative test for 7 (Vibration), test 12 salt mist , test 15 (Conducted low Frequency), test 17 (Burst), test 18 (Surge voltage) and test 19 (Radiated emission) .

### **3 Source/derivation of the proposed IACS Resolution**

Following queries from the industry and also changes, clarifications and updates of IEC test standards.

### **4 Summary of Changes intended for the revised Resolution**

General comment:

The term performance test used throughout the UR was clarified in note b) and distinguished from the performance test required in test 2.

Addition of procedure for Test No. 2 Performance Test Added for clarification that depending on the equipment under test (EUT) specific testing is necessary. E.g. IEC 60255 for protection relays Change of test parameter and addition under "other information" for Test No. 5 Dry Heat

Depending on the size of the EUT and climatic conditions 2 hours are often not sufficient to achieve stable conditions. It is therefore agreed that the next severity level specified in the source standard IEC 60068-2-2 is required. Under "Other information" a clause has been added for equipment which is to be proven to be suitable to be installed where higher ambient temperature is expected, e.g. exhaust manifolds which will require a higher test temperature.

Addition of other information for Test No. 6 Damp heat The stabilizing period before the start of the first cycle was added for clarification in "other information" column. This is in line with the requirement found in the source standard IEC 60068-2-30.

Addition of other information for Test No. 7 Vibration Practical experience shows that electronic fuel oil injection systems may be exposed to higher vibration levels. Such system was consequently included as example for equipment that may require test at increased vibration levels and frequency range. A general note has been added that the increased frequency range has to be agreed in each case. The example of increased values has been kept.

Remark to Test No.11 Cold

The international standard IEC 60945, 60092-504, 101 are not consistent and harmonized.

IACS UR M40 is also not harmonized with the UR E10. It is highly recommended to harmonize the standards. Therefore the requirements were not changed by the PT.



Other information to Test No. 12 Salt Mist Added for clarification to ensure that any deterioration or corrosion is superficial in nature.

Change of test parameters in test No. 14 Electromagnetic Field The frequency range was increased up to 6GHz to ensure that equipment which uses frequency band higher than 2 GHz is also tested.

The panel is of the opinion that the requirements to EMC at 6GHz as proposed by the PT would prohibit the use of wireless equipment onboard as they would radiate a signal with strength that is beyond the limit set.

The panel is therefore of the opinion that the technical solution proposed by the PT is not technically sound and have deleted this in the test specification.

Remark to Test No.15 Conducted low Frequency It is not required to exceed the power limit of 2W and hence it is acceptable to decrease the voltage applied during the test to keep within the power limit.

Clarification for Test 18, Surge Voltage:

The test description was inaccurate and contained incorrect symbols. This has been corrected according to the source standard. For practical purpose no change in the testing scope.

Change of Test No. 19 Radiated emissions

Quasi peak detection was defined only for frequencies up to 1 GHz and makes no sense for the protection of receiver / transmitter technology above 1 GHz (no AM or FM). Therefore the PT decreases the frequency range to 1GHz and added test no. 20.

Open point: The limits for 156-165MHz 24 dBuV/m to be checked for the general power distribution zone.

An editorial correction is being made to the table for equipment installed in the bridge and deck zone. For the frequency range 0.3 – 30 MHz, the limits are being editorially corrected from "50 – 34 dBmicroV/m" to "52 – 34 dBmicroV/m". It was determined the value indicated in Rev. 5 of UR E10 was incorrect. The corrected value is in agreement with IEC 60092-504 and IEC 60945.

The panel has deleted test 20 in lieu of not agreeing to 6 GHz. It has therefore been agreed to re-instate 2 GHz in test 19 in line with IEC 60945.

Addition of Test No. 20

With reference to CISPR 22 only the peak or average peak value shall be used for frequencies above 1GHz. Quasi peak detection was defined only for frequencies up to 1 GHz and makes no sense for the protection of receiver / transmitter technology above 1 GHz (no AM or FM). Category B of CISPR-22, to be used for living areas (PC, radio, television, communication) was chosen because the source and the sink of disturbances are close together similar as on ships. It should be taken into consideration that according to CISPR-22 the limits for radiated emissions above 1GHz depend on the maximum used frequency of the EUT.

The Machinery Panel has agreed to delete the proposed test.

## **5 Points of discussions or possible discussions**

Test E10.1 General

There was a comment of a member stated that E10 is not applied to all internal communication equipment as listed in 10.1. When this question was circulated a number of the societies quoted as applying the E10 to mandatory and/or essential internal communication. Based on this a society was tasked to provide their interpretation of "internal communication", i.e. to agree what is "mandatory/essential". A society states that UR E10 is a test specification for TA and not a source or reference document for defining "internal communication". It was proposed to expand the expression to "communication" thereby including data communication and wireless communication links as applicable areas of utilisation of the test requirements; however, there was not sufficient agreement. It was finally concluded that each society may choose to apply E10 to type approval of any communication systems in accordance to their own interpretation of the term.

Result in this draft version of E10: application changed to remove "internal communication".

#### Test No. 7 Vibration

There was a discussion within the PT regarding vibration tests for equipment mounted on Diesel engines. Additional testing on increased vibration levels and frequencies seems to be necessary for equipment mounted on electronic controlled Diesel engines. (Example: Pressure variations in the injection system for common rail engines appr. 230Hz, Turbocharger: 15000rpm angular frequency appr. 250Hz, medium or high speed engines e.g. MTU 20cyl. 1800rpm) Increasing the vibration test level up to 300Hz was not accepted by the PT in order to be harmonized with IEC 60092-504. A proposal by CIMAC for testing equipment mounted in close proximity to hydraulic valves, fuel boosters and exhaust valves in accordance with IEC 60068-2-64 (1993), Test Fh: Vibration, broadband random (digital control) was withdrawn and also not accepted by the majority of the PT.

Result in this draft version of E10: No changes

Proposal by the PT:

For future revisions of UR E10 it is recommended to observe the outcome of ISO/NP 20283-4 "Mechanical vibration — Measurement of vibration on ships — Part 4: Measurement and evaluation of vibration of the ship propulsion machinery".

In addition to it is recommended to make a note to ISO / IEC for further examination.

#### Test No. 11 Cold

The international standard IEC 60945, 60092-504, 101 are not consistent and harmonized.

IACS UR M40 is also not harmonized with the UR E10. A test with 5 deg. C has no influence on any equipment to be tested. Dead ship / cold iron condition were not taken into consideration.

Result in this draft version of E10: No changes

Proposal by the PT:

It is recommended by the PT to make a note to ISO / IEC to harmonize the testing standards.

#### Test No. 17 Burst

IEC recommends repetition rates of 100 kHz which are closer to reality. 5 kHz repetition rates are traditional; however. The test was not changed to be consistent with e.g. IEC 60945. The recommendation from IEC should be observed for further revisions.

Test No. 14,16, 19 and 20 Electromagnetic field, conducted and radiated Emission.

The upper test frequency in test no. 19 was in the PT agreed to be 6 GHz. When the PT's result was circulated in the panel it was agreed that no equipment communicating within the specified increased frequency range would be able to comply with the requirements to radiated emission. It was hence agreed to maintain the existing frequency limits (2GHz), and to solve this matter in a separate task.

After Machinery Panel discussion:

The panel is of the opinion that the requirements to EMC at 6GHz as proposed by the PT would prohibit the use of wireless equipment onboard as they would radiate a signal with strength that is beyond the limit set.

The panel is therefore of the opinion that the technical solution proposed by the PT is not technically sound and have deleted this in the standard.

Further study on developing criteria for EMC test up to 6 GHz is recommended.

10.1 The panel did agree to limit the test specification application scope.

**6 Attachments if any**

None

## **Technical Background (TB) document for UR E10 (Rev.7 Oct 2018)**

### **1 Scope and objectives**

Adoption of tests for wireless applications for use on board ships relating to queries from the industry. The revision considers the increase of the frequency range for electromagnetic emissions up to 6 GHz and the application a quasi-peak detection and average detection to test radiated emissions for below and above 1 GHz, respectively.

### **2 Engineering background for technical basis and rationale**

An evaluation of the effects of the higher frequency emissions (2 to 6 GHz) and the use of wireless data communication links on the function of nearby equipment and systems was considered necessary. The evaluation considered also testing radiated emissions within the limits of the maritime mobile VHF radio band for the general power distribution zone and the correctness of the testing method for radiated emissions within the limits of the maritime mobile VHF radio band (156 MHz to 165 MHz).

The wording of IEC 60092-504:2016 for dry heat test was used for alignment of test item 5 and the referenced Note 1.

A comparison between UR E10 test 14 and pertinent standards CISPR24, IEC61000-6-1, IEC 61000-6-2, 61000-4-3, IEC 60945, 60092-504, IEC 60533, ETSI EN 301 843-1 as well as between UR E10 test 19 and CISPR 22, CISPR 16-1-1, CISPR 16-1-4, CISPR 16-2-3, IEC 61000-6-3, IEC 61000-6-4, IEC 60945, IEC 60092-504, IEC 60533, ETSI EN 301 843-1 and ECMA-358 was undertaken by the Project Team.

### **3 Source/derivation of the proposed IACS Resolution**

Following queries from the industry and also changes, clarifications and updates of IEC test standards.

### **4 Summary of Changes intended for the revised Resolution**

- a. Change of Test No. 5 Dry Heat  
Following a proposal by a member society, the test has been aligned with Test no. 7 of Table 1 of IEC 60092-504:2016 to consider non-heat and heat dissipating equipment. The reference to Note 1 has been moved from Column "Test Parameters" to "Test".
- b. Change of test parameters in Test No. 14 Electromagnetic Field  
The frequency range was increased up to 6 GHz to ensure that equipment which uses frequency band higher than 2 GHz is also tested in accordance with test No.14 of the IEC Publication 60092-504:2016.

The test parameters other than "Frequency Range" have not been modified. A clarification for receivers/transmitters exclusion band from immunity tests has been added to "Other Information".

- c. Change of Test No. 19 Radiated Emissions

Quasi peak detection is defined for limits up to 1 GHz and average detection above 1 GHz. In this regard for limits below 1 GHz the previous 2000 MHz has been decreased to 1000 MHz.

It should be taken into consideration that according to CISPR 22 the limits for radiated emissions above 1GHz depend on the maximum used frequency of the EUT and such is addressed in the "other information" adding the wording "procedure in accordance with the standard". CISPR 22 has not been included as referenced standard, however the instruction that the procedure should be in accordance with the standard has been retained as the 3 m distance is the normal recommendation of standards such as IEC 60945:2002 and 60092-504:2016. The limits of 24 dB $\mu$ V/m for 156-165MHz has been maintained specifying that such a limit is applicable for the repeated measure with a receiver bandwidth of 9 kHz as per IEC Publication 60945.

Following a proposal by a member society, a note for exemption of radio equipment using wireless systems has been added.

- d. Change of Note 1 in the Table "Type testing condition for equipment covered by E10.1".

Following a proposal by a member society, the wording has been aligned with Table 1/Note d of IEC 60092-504:2016.

- e. Change of Notes in Implementation Statement

Following a query submitted by a member society during the 26<sup>th</sup> Panel meeting, the Panel agreed to review Footnote 2 of UR E10 Rev.6 to address the case of equipment, for which the manufacturers request a renewal of the type approval certificates without further testing to the new standards of Rev. 7, based on equipment satisfactory service history. The Panel reviewed the request under a separate task and decided to reflect its conclusion by updating the Notes in the application statement of UR E10 Rev.7.

## **5 Points of discussions or possible discussions**

- a. Test 19 Radiated Emission of IEC 60092-504:2016 was revised to cover frequency range up to 6 GHz, which was 2 GHz in IEC 60092-504:2001, but retained the same limit value of 54 dB $\mu$ V/m with no change. It was also noted that the limit value of 54 dB $\mu$ V/m for frequency range between 30 to 6000 MHz is different from the limit values for frequency range above 1 GHz stipulated in CISPR 22.

IACS contacted IEC TC18 regarding the technical background of the increment of frequency range up to 6 GHz while keeping the limit value at 54 dB $\mu$ V/m.

IEC TC 18 Chair's reply was as follows: *"...The frequency range has been increased to 6GHz to accommodate the increased use on ships of emerging W-LAN and Bluetooth technologies.*

*The proposal to splitting the frequency range further and using two limits (similar to EN 55022:2011) was also considered, but rejected because that would put the arrangements in conflict with IEC 60945 for Bridge mounted equipment.*

*The above rationale being driven by the fact that the bridge of a ship is a*

*particularly sensitive location due to its dense concentration of radionavigation, radiocommunication and marine control system equipment. Leading to the conclusion: that the requirement in Table 1 of the new IEC 60092-504:2016, should be maintained.*

*This conclusion is based on discussion within IEC TC 18/MT 2 who are responsible for IEC 60092-504. A recent meeting of the German EMC committee (16 February 2017), where this subject was raised, also agreed the current TC 18 conclusion.*

*Therefore, it would not be the intention of Chair or Secretary of TC 18 to recommend amendment of the standard at this time. However, a potential future revision of this standard can be conducted in cooperation with TC 80, where alignment to other applicable standards can be considered, as maybe applicable”.*

Following IEC TC 18 reply, the Panel agreed to proceed with alignment with the revised IEC 60092-504:2016 (the other proposals were to adopt an approach for test 19 based on CISPR22 and then bring the matter to the attention of TC18 or to deviate from IEC requirements and introduce new limits).

- b. IEC 60092-504:2016 does not distinguish between average and peak limits and leaves it open to which of these criteria the limit of 54 dB $\mu$ V/m applies. The agreed test 19 specifies the quasi-peak measuring receiver up to 1 GHz and the measuring receiver with average detector above 1 GHz.
- c. For Test n. 19, a member society proposed to add a clarification in the column “Other information” for the radio equipment used for wireless systems exclusion from the test which was agreed as follow:

“Equipment intended to transmit radio signals for the purpose of radio communication (e.g. wifi router, remote radio controller) may be exempted from limit, within its communication frequency range, subject to the provisions in UR E22.5.2.”

- d. A proposal by a member society to revise the recommendation for Q in test no. 7 (Vibration) to read that Q should not be higher than 5 without exceeding 10 has not been agreed.
- e. A proposal by a member society to replace 2 GHz by 6 GHz in test no. 14 and 2000 MHz by 6000 MHz in tests no. 19 of UR E10 Rev.6 has not been agreed.
- f. Regarding Test no. 14 a member society proposed to add a clarification in the column “Other information” for the receivers/transmitters exclusion from the immunity test which was agreed as follow:

“if an equipment is intended to receive radio signals for the purpose of radio communication (e.g. wifi router, remote radio controller), then the immunity limits at its communication frequency do not apply, subject to the provisions in UR E22.5.2.”

## **6 Attachments if any**

None

## Technical Background (TB) document for UR E10 (Rev.8 Feb 2021)

### 1. Scope and objectives

UR E10(Rev.7) does not reflect the agreed format for referencing the IEC and CISPR standards. Rev.8 has been developed to comply with the agreed format.

### 2. Engineering background for technical basis and rationale

#### Format for references to Industry standards

**Format:**

*[Standard Designation], [version/revision, if applicable], [year of publication]*  
*(examples: API Spec 2F, 6th Edition, 1997; ISO 4624, 2002), where [version/revision, if applicable] and/or [year of publication] are decided by IACS and are not necessarily to be the current/latest version.*

### 3. Source/derivation of the proposed IACS Resolution

None

### 4. Summary of Changes intended for the revised Resolution

UR E10 has been updated to specify the revision/version of the IEC and CISPR standards as follows:

<b>Publications in E10</b>	<b>Replaced by</b>
IEC 60092-504	IEC 60092-504:2016
IEC 60533	IEC 60533:2015
IEC 60068-2-2	IEC 60068-2-2:2007
IEC 60068-2-30	IEC 60068-2-30:2005
IEC 60068-2-6	IEC 60068-2-6:2007
IEC 60068-2-1	IEC 60068-2-1:2007
IEC 60068-2-52	IEC 60068-2-52:2017
IEC 61000-4-2	IEC 61000-4-2:2008
IEC 61000-4-3	IEC 61000-4-3:2020
IEC 61000-4-6	IEC 61000-4-6:2013
IEC 61000-4-4	IEC 61000-4-4:2012
IEC 61000-4-5	IEC 61000-4-5:2017
CISPR 16-2-3	CISPR 16-2-3:2016
IEC 60945	IEC 60945:2002
CISPR 16-2-1	CISPR 16-2-1:2017
IEC 60092-101	IEC 60092-101:2018
IEC 60695-11-5	IEC 60695-11-5:2016

### 5. Points of discussions or possible discussions

The year of publication indicates the year when the standard as consolidated edition or its latest amendment has been published. For CISPR 16-2-3:2016, for which Amendment 1 has been issued in 2019, the 2016 edition has been stated as 2020 is the review year of the standard.

### 6. Attachments if any

None

## **Technical Background (TB) document for UR E10 (Corr.1 Jan 2022)**

### **1. Scope and objectives**

To correct uniform application statement No. 4 in Note of Rev.8 so that it is simply to be applied based on the "application for type approval" date.

### **2. Engineering background for technical basis and rationale**

None

### **3. Source/derivation of the proposed IACS Resolution**

None

### **4. Summary of Changes intended for the revised Resolution:**

The change made to uniform application statement No. 4 in Note of Rev.8 is as follows:

*"4. Equipment intended to be installed on ships contracted for construction on or after 1 January 2022 is to comply with Rev.7 and ~~Rev.8~~ of this UR."*

### **5. Points of discussions or possible discussions**

None

### **6. Attachments if any**

None



## **Technical Background (TB) document for UR E10 (Rev.9 August 2023)**

### **1. Scope and objectives**

Rev. 9 of UR E10 has been developed to precise the way to proceed when latest standard is different from the one indicated in the UR.

### **2. Engineering background for technical basis and rationale**

None.

### **2a. Specification of the data utilised in the development/revision of the proposed IACS Resolution, if any**

N/A.

### **3. Source/derivation of the proposed IACS Resolution**

None.

### **4. Summary of Changes intended for the revised Resolution:**

Note of the table concerning the column "Procedure" has been modified by replacing indication to apply the latest edition of the normative reference by the possibility to use later versions or revisions of the standards specified if they are deemed equivalent to the technical specification of the UR.

In the specific case of line 14 for which IEC 61000-4-3:2020 and previous version IEC 61000-4-3:2006+AMD1:2007+AMD2:2010 are mentioned, it was noted that the test laboratories typically confirm compliance with the version of the standard that are covered by their accreditation and that many test laboratories are still accredited according to the previous version of the standard as the latest version of IEC 61000-4-3 introduces requirements for testing using multiple test signal, etc. that may require new expensive test equipment. Therefore, in this case, they cannot confirm compliance with the latest version under their current accreditation. It is acceptable considering test 14 in IACS UR E10 will be performed identically, no matter which version of the standard is applied.

### **5. Points of discussions or possible discussions**

None.

### **6. Attachments if any**

None.

## **Technical Background (TB) document for UR E10 (Rev.10 August 2024)**

### **1. Scope and objectives**

In the course of revision of Note 3 to M46.2, it was proposed to update item 8 (inclination) of UR E10 where similar requirements as Note 3 to M46.2 is present.

### **2. Engineering background for technical basis and rationale**

The inclination requirement for emergency source of electrical power on gas carriers and chemical tankers is addressed in UI SC6 and UI SC290. The two UIs are dealing with the same issue and the same contents, with the only difference of the reference clause nos. for IGC Code between old and new IGC Code, i.e. UI SC6 refers to 1983 IGC Code and UI SC290 mentions 2014 IGC Code.

The duplication of the UIs is thought to be originated from GPG instruction (ref. 18902\_IGe and PM5901fIMI: "creating UIs that will be published as "new" and also revising the old UIs by adding the references to the old IGC Code that will be published as Revisions").

This panel is of the view that the instruction would be applicable when specific requirement of old IGC Code has been revised or replaced by new IGC Code. However in this case, the requirement is same and the two UIs are just indicating the re-adjusted clause number of old & new IGC Code, thus not advisable.

In the meantime, it is observed that the same inclination requirement is already covered by UR M46 (Note 3 of M46.2).

Still, it was found that similar requirements as Note 3 to M46.2 is present in item 8 of UR E10 (inclination test).

#### **2a. Specification of the data utilised in the development/revision of the proposed IACS Resolution, if any**

None.

### **3. Source/derivation of the proposed IACS Resolution**

UI SC6, UI SC 290  
SOLAS II-1/Reg.43.6  
1983 IGC Code, clause 2.9.2.2  
2014 IGC Code, clause 2.7.2.2  
IBC Code, clause 2.9.3.2

### **4. Summary of Changes intended for the revised IACS Resolution:**

Note 3 to M46.2 has been updated, adding reference clause nos. of the IGC Code (both 1983 IGC Code and 2014 IGC Code) and the IBC Code. By the transfer of the reference clauses, UI SC6 and UI SC290 have been deleted. Likewise, UR E10 item 8 has been updated as per Note 3 to M46.2, adding reference clause nos. of the IGC Code (both 1983 IGC Code and 2014 IGC Code) and the IBC Code.

Taking the opportunity, the latest edition of the reference standards are also checked and updated accordingly.

**5. Points of discussions or possible discussions**

One member opined that the update of UR E10 could be addressed at a later stage.

**6. Attachments if any**

None.

## UR E11 “Unified requirements for systems with voltages above 1 kV up to 15 kV”

### Summary

In Rev.4 of this Resolution, the way to refer to instruments other than those specified by IACS was unified.

### Part A. Revision History

Version no.	Approval date	Implementation date when applicable
Rev.4 (Feb 2021)	12 February 2021	1 July 2022
Corr.1 (April 2018)	12 June 2018	-
Rev.3 (Feb 2015)	23 Feb 2015	1 July 2016
Rev.2 (July 2003)	16 July 2003	-
Rev.1 (May 2001)	17 May 2001	-
New (1991)	1991	-

#### • Rev.4 (Feb 2021)

##### 1 Origin of Change:

- Other (Update to comply with the required format when industry standards are referred to)

##### 2 Main Reason for Change:

There was a need to update this UR to comply with the following format when industry standards are referred to:

*[Standard Designation], [version/revision, if applicable], [year of publication]*  
*(examples: API Spec 2F, 6th Edition, 1997; ISO 4624, 2002), where*  
*[version/revision, if applicable] and/or [year of publication] are decided by IACS and*  
*are not necessarily to be the current/latest version.*

##### 3 List of non-IACS Member classification societies contributing or participating in IACS Working Group:

None

##### 4 History of Decisions Made:

None

##### 5 Other Resolutions Changes:

None

**6 Any hinderance to MASS, including any other new technologies:**

None

**7 Dates:**

Original Proposal: 28 October 2019 (Ref: PM18939\_IMd)  
Panel Approval: 9 November 2020 (Ref: PM20906\_IMf)  
GPG Approval: 12 February 2021 (Ref: 20206cIGb)

• **Corr.1 (June 2018)**

**.1 Origin for Change:**

Suggested by IACS member

**.2 Main Reasons for Change:**

The checking and updating of international standards that referenced by IACS resolutions has been carried out by Machinery panel. As a result, it is found that there is a need to update the international standards that referred in the IACS resolution UR E11.

**.3 List of non-IACS Member Classification Societies contributing through the TC Forum and/or participating in IACS Working Group:**

None

**.4 History of Decisions Made:**

Delete word "Publication" in the standards referenced;  
Delete word "Standard" in the standards referenced;

**.5 Other Resolutions Changes**

None

**.6 Dates:**

Original Proposal: 22nd May 2015, made by Machinery Panel  
Panel Approval: 11 May 2018 (Ref: PM5901)  
GPG Approval: 12 June 2018 (Ref: 18082\_IGc)

• **Rev.3 (Feb 2015)**

**.1 Origin for Change:**

Suggestion by an IACS member

**.2 Main Reason for Change:**

The test requirements in UR E11 do not reflect the corresponding requirements in the relevant IEC publications, in particular test requirements in UR E11 7.2.6 'Test after installation' need to be updated.

**.3 List of non-IACS Member Classification Societies contributing through the TC Forum and/or participating in IACS Working Group:**

None

**.4 History of Decisions Made:**

Form A agreed by Panel and submitted to GPG under 12163\_PMa.

**.5 Other Resolutions Changes**

None

**.6 Dates:**

Original Proposal: 14 September 2014 Made by: Machinery Panel

Panel Approval: 6 February 2015

GPG Approval: 23 February 2015 (Ref: 12163\_IGb)

- **Rev.2 (July 2003)**

Refer to the TB document in Part B. No history file available.

- **Rev.1 (May 2001)**

Refer to the TB document in Part B. No history file available.

- **New (1991)**

No history files or TB document available. No history file available.

## Part B. Technical Background

List of Technical Background (TB) documents for UR E11:

Annex 1. **TB for Rev.1 (May 2001)**

See separate TB document in Annex 1.

Annex 2. **TB for Rev.2 (July 2003)**

See separate TB document in Annex 2.

Annex 3. **TB for Rev. 3 (Feb 2015)**

See separate TB document in Annex 3.

Annex 4. **TB for Corr. 1 (June 2018)**

See separate TB document in Annex 4.

Annex 5. **TB for Rev.4 (Feb 2021)**

See separate TB document in Annex 5.



**Note:** *There are no Technical Background (TB) documents available for the New (1991).*

**Annex 1 Technical Background (TB) document for Rev.1 (May 2001)**

**Technical Background Document**

WP/EL Task 1A "Annual Review UR- Review UR E11"

**Objective and Scope:**

To correct UR E11 in order to eliminate existing reservations and to align with IEC Standards.

**Source of Proposed Requirements:**

The proposed requirements have been based on the present Rule requirements of IACS members and IEC Standards.

**Points of Discussion:**

During the XXI WP/EL Meeting it was decided that maximum application voltage should be increased to 15 kV to be in line with IEC 60092-503 and IEC 60092-508 new proposals but where necessary for special application, higher voltages may be accepted by the Society. The table 1.2 nominal voltages/frequencies was deleted because it was not a requirement. During discussion several paragraphs were deleted because they were not specific for HV systems. Added requirement for directly earthed neutral or other neutral earthed systems. Added a higher protection against tool penetration inside the enclosure. Included requirements for the acceptance of liquid cooled transformers.

Added installation requirements where high voltage cables of different voltage ratings are installed on the same cable tray. Number of other comments including editorial changes was made which are incorporated in the final draft.

The corrected draft of the UR agreed by WP was forwarded to GPG for consideration attached to the 30th WP/EL Progress Report.

Submitted by WP/EL Chairman in January 2001



## **Annex 2 Technical Background (TB) document for Rev.2 (July 2003)**

### **Technical Background Document**

WP/EL Task 1A "Annual Review UR- Review UR E11 (Rev.1, May 2001)"

#### **Objective and Scope:**

GPG at its 52nd meeting reviewed 31 Progress Report WP/EL and decided to ask WP/EL to consider ABS' comments on UR E11 and RINA reply with a view to clarifying requirements in para. 6.3.2, which pertains to the number of power sources for operating switches and circuit breakers.

#### **Source of Proposed Requirements:**

The proposed requirements have been based on the present Rule requirements of IACS members and IEC Standards.

#### **Points of Discussion:**

During the XXIV WP/EL Meeting it was decided that two external supply sources are necessary for auxiliary circuits.

Auxiliary circuits – circuits, which are necessary in the switchgear and control gear assemblies to ensure the safe operation of the HV power circuits. Such circuits include control, protection, measuring circuits and so on. In addition they are not derived from their power circuits but from external source(s) with external supply(ies).

Auxiliary circuits are not opposed to normal supply because normal supply is not used for HV installation: each consumer is not provided with its own auxiliary transformer. Only external supplies are used for control and protection purposes. In case of failure of external supply, the power system is not more protected (e.g. short circuit protection, overload protection, and all the other safety protections are not working) and the power supply is to be tripped.

Where the main switchboard is divided in two parts, having only one source of supply for each section, it means that half of the power is not more available due to a single failure of this source (half of the power in all the cases for HV installation is more than one generator). This is not acceptable.

Taking into account all above mentioned, two external supply sources are necessary for auxiliary circuits.

The corrected draft of the UR agreed by WG was forwarded to GPG for consideration attached to the 32nd WP/EL Progress Report.

## **Annex 3 Technical Background (TB) document for Rev. 3 (Feb 2015)**

### **1. Scope and objectives**

To update UR E11 in line with the latest versions of IEC standards, in particular IEC 60502-1 (2009) and IEC 60502-2 (2005) with respect to testing.

### **2. Engineering background for technical basis and rationale**

Update in accordance with IEC

### **3. Source/derivation of the proposed IACS Resolution**

IEC 60502-1 (2009)  
IEC 60502-2 (2005)  
IEC 60076-11 (2004)

### **4. Summary of Changes intended for the revised Resolution**

#### **2.3.2 Creepage distances**

It was considered that the phrase 'standard component' could be open to interpretation and further, associated electrical equipment may comprise non-standard components to which the requirements should still apply. It was therefore deemed appropriate to change the wording such that it is applicable to all parts described by the criteria within requirement. Further, it was considered appropriate to refer to the specified International Standard, which addresses creepage distances, rather than the more generic "relevant IEC Publications".

#### **4.1 Power Transformers, General**

IEC60726 has been replaced by IEC60076-11:2004, Power transformers - Part 11: Dry-type transformers.

#### **6.2.3 Shutters**

Additional wording: Shutters are to be clearly marked for incoming and outgoing circuits. This may be achieved with the use of colours or labels.

#### **6.2.5 Internal Arc Classification**

The standard allows IAC test in different combinations:  
Accessibility type A: Accessible by authorized personnel only.  
Accessibility type B: Accessible by general public.  
F- Front access  
L-Lateral access  
R-Rear access

This means a switchgear which has been tested IAC A FL must not be accessible from the rear (R) when energized, as this has not been tested.

### **7.1 Electrical equipment**

An adequate, unobstructed working space is to be left in the vicinity of high voltage equipment for preventing potential severe injuries to personal performing maintenance activities.

#### **7.2.6 Test after installation**

The test requirements did not reflect the corresponding requirements in the most recent relevant IEC publications. Therefore, 7.2.6 is updated in accordance with IEC 60502-1 (2009) and IEC 60502-2 (2005) with respect to testing.

## **5. Points of discussions or possible discussions**

Regarding creepage distances in 2.3.2, one member advised that the current values of 25 mm/kV and 16mm/kV are more stringent than that applied in the IEC 60092 series. The member's Rules are in line with these standards and it has hence currently a reservation in place.

One member proposed to introduce loss of service continuity categories for switchgears; however, this was not supported by the majority as maintaining service continuity is considered a system level issue that can be managed in a number of ways.

Regarding Internal Arc Classification (IAC), one member considered that switchgear and controlgear assemblies will be accessible from all sides and as such should always be tested as such. Following further consideration the Panel agreed to leave accessibility requirements installation and location dependent.

One member opined that requirements for arc flash/internal arc protection are covered by IEC 62271-200 and need not be addressed in UR E11, however, other members agreed to introducing the requirements in the current form.

## **6. Attachments if any**

N/A

**Technical Background (TB) document for UR E11 (Corr.1 June 2018)**

**1. Scope and objectives**

To make amendment to UR E11 in order to update the international standards that referenced in this IACS resolutions.

**2. Engineering background for technical basis and rationale**

None.

**3. Source/derivation of the proposed IACS Resolution**

The task of checking and updating of international standards that referenced by IACS resolutions carries out every five years. From 21st Meeting of IACS MP, the working scope extended from IEC standards referenced to all MP related international standards.

**4. Summary of Changes intended for the revised Resolution:**

None.

**5. Points of discussions or possible discussions**

None.

**6. Attachments if any**

None.

## Technical Background (TB) document for UR E11 (Rev.4 Feb 2021)

### 1. Scope and objectives

UR P4(Rev.3) does not reflect the agreed format for referencing the IEC standards. Rev.4 has been developed to comply with the agreed format.

### 2. Engineering background for technical basis and rationale

#### Format for references to Industry standards

**Format:**

*[Standard Designation], [version/revision, if applicable], [year of publication]*  
(examples: *API Spec 2F, 6th Edition, 1997; ISO 4624, 2002*), where *[version/revision, if applicable]* and/or *[year of publication]* are decided by IACS and are not necessarily to be the current/latest version.

### 3. Source/derivation of the proposed IACS Resolution

None

### 4. Summary of Changes intended for the revised Resolution

UR E11 has been updated to specify the revision/version of the IEC standards.

IEC standards	Replaced by
IEC 60092-201	IEC 60092-201:2019
IEC 60092-503	IEC 60092-503:2007
IEC 60034-15	IEC 60034-15:2009
IEC 60076-11	IEC 60076-11:2018
IEC 60092-353	IEC 60092-353:2016
IEC 60092-354	IEC 60092-354:2020
IEC 62271-200	IEC 62271-200:2011
IEC 62271-201	IEC 62271-201:2014
IEC 60076	applicable Parts of the IEC 60076 Series

### 5. Points of discussions or possible discussions

The investigation for the year of publication of the standards started beginning of 2019. At that time 60092-201:1994 was applicable; however as of mid 2019 a new edition of the aforesaid standard has been published, therefore the 2019 edition is stated in the UR.

Previous editions of the UR stated in 4.1 "Liquid cooled transformers have to comply with IEC 60076". As IEC 60076 is a series of standards, whose number exceeds 20, on power transformers, and not all parts are on liquid cooled transformers, the above sentence has been revised to read "Liquid cooled transformers have to comply with the applicable Parts of the IEC 60076 Series".

### 6. Attachments if any

None

## UR E12 “Electrical Equipment allowed in paint stores and in the enclosed spaces leading to paint stores”

### Summary

In Rev.2 of this Resolution, the way to refer to instruments other than those specified by IACS was unified.

### Part A. Revision History

Version no.	Approval date	Implementation date when applicable
Rev.2 (Dec 2020)	11 December 2020	1 January 2022
Rev.1 (May 2001)	May 2001	-
Corr.1 (1997)	1997	-
New (1994)	1994	-

- **Rev.2 (Dec 2020)**

#### 1 Origin of Change:

- Other (Update to comply with the required format when industry standards are referred to)

#### 2 Main Reason for Change:

There was a need to update this UR to comply with the following format when industry standards are referred to:

*[Standard Designation], [version/revision, if applicable], [year of publication]*  
 (examples: API Spec 2F, 6th Edition, 1997; ISO 4624, 2002), where  
 [version/revision, if applicable] and/or [year of publication] are decided by IACS  
 and are not necessarily to be the current/latest version.

#### 3 List of non-IACS Member classification societies contributing or participating in IACS Working Group:

None

#### 4 History of Decisions Made:

None

#### 5 Other Resolutions Changes:

None

**6 Any hinderance to MASS, including any other new technologies:**

None

**7 Dates:**

Original Proposal: 28 October 2019 (Ref: PM18939\_IMd)  
Panel Approval: 09 November 2020 (Ref: PM20906\_IMf)  
GPG Approval: 11 December 2020 (Ref: 20206\_IGb)

- **Rev.1 (May 2001)**

See TB in Part B. No history file available.

- **Corr.1 (1997)**

No history file or TB document available.

- **New (1994)**

No history file or TB document available.

## **Part B. Technical Background**

List of Technical Background (TB) documents for UR E12:

Annex 1.     **TB for Rev.1 (May 2001)**

See separate TB document in Annex 1.

Annex 2.     **TB for Rev.2 (Dec 2020)**

See separate TB document in Annex 2.



## **E 12 (Rev.1)**

### **Technical Background Document WP/EL Task 1A “Annual Review UR- Review UR E12”**

#### **Objective and Scope:**

To correct UR E12 in order to align with IEC Standard.

#### **Source of Proposed Requirements:**

The proposed requirements have been based on the revised IEC 60092-502 Standard.

#### **Points of Discussion:**

The text has been revised taking into account the IEC 60092-502. We have deleted the reference to IACS Recommendation No.22 and insert in lieu the IEC 60092-502.

The corrected draft of the UR agreed by WP was forwarded to GPG for consideration attached to the 30<sup>th</sup> WP/EL Progress Report.

Submitted by WP/EL Chairman

## Technical Background (TB) document for UR E12 (Rev.2 Dec 2020)

### 1. Scope and objectives

UR E12(Rev.1) does not reflect the agreed format for referencing the IEC standards. Rev.2 has been developed to comply with the agreed format.

### 2. Engineering background for technical basis and rationale

#### Format for references to Industry standards

*[Standard Designation], [version/revision, if applicable], [year of publication]*  
*(examples: API Spec 2F, 6th Edition, 1997; ISO 4624, 2002), where*  
*[version/revision, if applicable] and/or [year of publication] are decided by IACS and*  
*are not necessarily to be the current/latest version.*

### 3. Source/derivation of the proposed IACS Resolution

None

### 4. Summary of Changes intended for the revised Resolution:

UR E12 has been updated to specify the revision/version of the IEC standards as follows:

IEC standards	Replaced by
IEC 60092-502	IEC 60092-502:1999

### 5. Points of discussions or possible discussions

None

### 6. Attachments if any

None

## UR E13 “Test requirements for Rotating Machines”

### Summary

In Corr.1 of Rev.3 of this Resolution, the second sentence of paragraph 4.5 has been corrected.

### Part A. Revision History

Version no.	Approval date	Implementation date when applicable
Corr.1 (May 2022)	06 May 2022	-
Rev.3 (Dec 2020)	11 December 2020	1 January 2022
Corr.1 (June 2018)	12 June 2018	-
Rev.2 (Aug 2015)	July 2015	1 January 2017
Corr.1 (May 2004)	May 2004	-
Rev.1 (May 2001)	May 2001	-
New (1996)	1996	-

#### • Corr.1 (May 2022)

##### 1 Origin of Change:

- Suggestion by IACS member

##### 2 Main Reason for Change:

To correct the second sentence of paragraph 4.5 so that it is to be referred the tables of IEC 60034-1:2017. This is because the tables related to the limits of temperature rise in this IEC are not specified in Table 1, but in some other table.

##### 3 List of non-IACS Member classification societies contributing or participating in IACS Working Group:

None

##### 4 History of Decisions Made:

During the discussion, the following three options for corrections were proposed, Option 2 has been agreed by Machinery Panel.

Option 1: *The limits of temperature rise are those specified in Table ~~1~~ 8 of IEC 60034-1:2017 ...*

Option 2: *The limits of temperature rise are those specified in ~~Table 1~~ the relevant table of IEC 60034-1:2017 ...*

Option 3: *The limits of temperature rise are those specified in Table 1 of IEC 60034-1:2017 ...*

**5 Other Resolutions Changes:**

None

**6 Any hinderance to MASS, including any other new technologies:**

None

**7 Dates:**

Original Proposal	: 18 October 2021	(Ref: PM20906qIMa)
Panel Approval	: 08 March 2022	(Ref: PM20906qIMc)
GPG Approval	: 06 May 2022	(Ref: 20206_IGo)

• **Rev.3 (Dec 2020)**

**1 Origin of Change:**

- Other (Update to comply with the required format when industry standards are referred to)

**2 Main Reason for Change:**

There was a need to update this UR to comply with the following format when industry standards are referred to:

*[Standard Designation], [version/revision, if applicable], [year of publication] (examples: API Spec 2F, 6th Edition, 1997; ISO 4624, 2002), where [version/revision, if applicable] and/or [year of publication] are decided by IACS and are not necessarily to be the current/latest version.*

**3 List of non-IACS Member classification societies contributing or participating in IACS Working Group:**

None

**4 History of Decisions Made:**

None

**5 Other Resolutions Changes:**

None

**6 Any hinderance to MASS, including any other new technologies:**

None

## 7 Dates:

Original Proposal : 28 October 2019 (Ref: PM18939\_IMd)  
Panel Approval : 09 November 2020 (Ref: PM20906\_IMf)  
GPG Approval : 11 December 2020 (Ref: 20206\_IGb)

### • **Corr.1 (June 2018)**

#### 1 Origin for Change:

Suggested by IACS member

#### 2 Main Reasons for Change:

The checking and updating of international standards that referenced by IACS resolutions has been carried out by Machinery panel. As a result, it is found that there is a need to update the international standards that referred in the IACS resolution UR E13.

#### 3 List of non-IACS Member Classification Societies contributing through the TC Forum and/or participating in IACS Working Group:

None

#### 4 History of Decisions Made:

Delete word "Publication" in the IEC standards referenced;

#### 5 Other Resolutions Changes

None

#### 6 Dates:

Original Proposal: 22 May 2015, made by Machinery Panel  
Panel Approval: 11 May 2018 (Ref: PM5901)  
GPG Approval: 12 June 2018 (Ref: 18082\_IGc)

### • **Rev.2 (Aug 2015)**

#### 1 Origin for Change:

Suggestion by non-IACS entity (*ConverTeam, Rugby, UK*)

#### 2 Main Reason for Change:

Industry request for clarification of requirements in paragraph 4.7.

#### 3 List of non-IACS Member Classification Societies contributing through the TC Forum and/or participating in IACS Working Group:

None

#### **4 History of Decisions Made:**

- Task started under PM8401 with gathering of member's views on ConverTeam query
- Decision to develop Form A for new task under PM11401
- Final revised text agreed at the 21st Machinery Panel meeting in March 2015

#### **5 Other Resolutions Changes**

None

#### **6 Dates:**

Original Proposal: 6 June 2011 made by a Machinery Panel Member  
Panel Approval: 30 June 2015  
GPG Approval: 20 August 2015 (Ref: 11046\_IGj)

- **Corr.1 (May 2004)**

No history file or TB document available.

- **Rev.1 (May 2001)**

Refer to the TB document in Part B. No history file available.

- **New (1996)**

No history file or TB document available.

\*\*\*\*\*

## **Part B. Technical Background**

List of Technical Background (TB) documents for UR E13:

Annex 1. **TB for Rev.1 (May 2001)**

See separate TB document in Annex 1.

Annex 2. **TB for Rev.2 (July 2015)**

See separate TB document in Annex 2.

Annex 3. **TB for Corr.1 (June 2018)**

See separate TB document in Annex 3.

Annex 4. **TB for Rev.3 (Dec 2020)**

See separate TB document in Annex 4.

Annex 5. **TB for Corr.1 (May 2022)**

See separate TB document in Annex 5.

*Note: There are no Technical Background (TB) documents available for the New (1996) and Corr.1 (May 2004).*

**E 13 (Rev.1)**

**Technical Background Document**

**WP/EL Task 1A “Annual Review UR- Review UR E13”**

**Objective and Scope:**

To correct UR E13 in order to eliminate existing reservations and to align with IEC Standards.

**Source of Proposed Requirements:**

During XIX WP/EL Meeting it was claimed that in UR E13 there are editorial mistakes concerning overload/overcurrent and overspeed tests.

**Points of Discussion:**

It was discussed whether there is a practically justified need to carry out overload/overcurrent tests as a Routine tests for a.c. generators and motors? After much discussion most members expressed the opinion that overload/overcurrent tests as a Routine tests are applicable for machines of essential services rated above 100 kW/kVA.

The question of 50 or 100 kW was raised. It was decided that all machines of 100kW and over, intended for essential services, are to be surveyed by the Society during testing and, if appropriate, during manufacturing. As regards to overspeed test WP/EL members decided that one is not applicable for squirrel cage motors.

The new requirement regarding the shaft material for electric propulsion motors and for main engine driven generators where the shaft is part of the propulsion shafting is included to current UR.

The corrected draft of the UR agreed by WP was forwarded to GPG for consideration attached to the 30<sup>th</sup> Progress Report WP/EL.



## Technical Background document for UR E13 (Rev.2 Aug 2015)

### 1. Scope and objectives

Revise IACS UR E13/4.7 to ensure that the ability of the generator and its excitation system to maintain a short-circuit is reflected in the UR. Further reservations to the existing UR and possible editorial comments shall be corrected.

### 2. Engineering background for technical basis and rationale

#### Paragraph 4.4 (Verification of the voltage regulation system)

The sentence has been added to clarify that voltage regulation during transient conditions need not be tested during factory testing provided that calculated values based on earlier type test records are available.

#### Paragraph 4.7 (Verification of steady short-circuit conditions)

The paragraph has been updated, taking into account both the stationary short circuit current delivered by the generator, as well as the transient behaviour of this short circuit current.

The stationary short circuit current shall be verified by testing. The test criterion is that a current of at least three times the rated current for duration of at least 2 s is achieved without any damage to the generator. If precise data is available, the test criteria can be modified to fit duration of any time delay, which will be fitted in the tripping device for discrimination purposes.

The transient short circuit current, i.e. the decrement curve for the generator, shall be documented by the manufacturer. This documentation may be based on the manufacturer's simulation model for the generator and the voltage regulator. The simulation model may be used where it has been validated through previous type test on the same generator model. The influence of the automatic voltage regulator shall be taken into account, and the setting parameters for the voltage regulator shall be noted together with the decrement curve. Such a decrement curve shall be available when the setting of the distribution system's short-circuit protection is calculated.

### 3. Source/derivation of the proposed IACS Resolution

Field experience and manufacturers feedback.

### 4. Summary of Changes intended for the revised Resolution:

See paragraph 2.

### 5. Points of discussions or possible discussions

The changes to 4.4 and 4.7 were agreed by all members. There was some discussion about the appropriate wording for the last sentence of 4.7 and the current text ('... *where this has been validated through the previous type test on the same model*') was agreed as a compromise solution.

### 6. Attachments if any

None

## **Technical Background (TB) document for UR E13 (Corr.1 June 2018)**

### **1. Scope and objectives**

To make amendment to UR E13 in order to update the international standards that referenced in this IACS resolutions.

### **2. Engineering background for technical basis and rationale**

None.

### **3. Source/derivation of the proposed IACS Resolution**

The task of checking and updating of international standards that referenced by IACS resolutions carries out every five years. From 21st Meeting of IACS MP, the working scope extended from IEC standards referenced to all MP related international standards.

### **4. Summary of Changes intended for the revised Resolution:**

None.

### **5. Points of discussions or possible discussions**

None.

### **6. Attachments if any**

None.

## Technical Background (TB) document for UR E13 (Rev.3 Dec 2020)

### 1. Scope and objectives

UR E13(Rev.2) does not reflect the agreed format for referencing the IEC standards. Rev.3 has been developed to comply with the agreed format.

### 2. Engineering background for technical basis and rationale

#### Format for references to Industry standards

*[Standard Designation], [version/revision, if applicable], [year of publication]*  
 (examples: API Spec 2F, 6th Edition, 1997; ISO 4624, 2002), where  
*[version/revision, if applicable] and/or [year of publication] are decided by IACS and are not necessarily to be the current/latest version.*

### 3. Source/derivation of the proposed IACS Resolution

None

### 4. Summary of Changes intended for the revised Resolution:

UR E13 has been updated to specify the revision/version of the IEC standards as follows:

IEC standards	Replaced by
IEC 60092-301	IEC 60092-301:1980/AMD2:1995
IEC 60034-1	IEC 60034-1:2017
IEC 60034-5	IEC 60034-5:2000+AMD1:2006

### 5. Points of discussions or possible discussions

None

### 6. Attachments if any

None

\*\*\*\*\*

## **Technical Background (TB) document for UR E13 (Corr.1 May 2022)**

### **1. Scope and objectives**

To correct the second sentence of paragraph 4.5 so that it is to be referred the tables of IEC 60034-1:2017.

### **2. Engineering background for technical basis and rationale**

None

### **3. Source/derivation of the proposed IACS Resolution**

None

### **4. Summary of Changes intended for the revised Resolution:**

The change made to the second sentence of paragraph 4.5 of Rev.3 is as follows:

*The limits of temperature rise are those specified in ~~Table 1~~ the relevant table of IEC 60034-1:2017 adjusted as necessary for the ambient reference temperatures specified in UR M40.*

### **5. Points of discussions or possible discussions**

A member suggested that the IEC 60034-5 referred to in paragraph 4.11 should be amended as a new edition has been published. However, as this suggestion is a revision of the UR, Machinery Panel agreed to consider it as a separate item rather than as the correction of the UR in this time.

### **6. Attachments if any**

None

## UR E15 “Electrical Services Required to be Operable Under Fire Conditions and Fire Resistant Cables”

### Summary

In Rev.4 of this Resolution, the way to refer to instruments other than those specified by IACS was unified.

### Part A. Revision History

Version no.	Approval date	Implementation date when applicable
Rev.4 (Dec 2020)	11 December 2020	1 January 2022
Rev.3 (Dec 2014)	05 December 2014	1 January 2016
Rev.2 (Feb 2006)	07 February 2006	-
Rev.1 (May 2004)	31 May 2004	-
New (Nov 1999)	19 November 1999	-

#### • Rev.4 (Dec 2020)

##### 1 Origin of Change:

- Other (Update to comply with the required format when industry standards are referred to)

##### 2 Main Reason for Change:

There was a need to update this UR to comply with the following format when industry standards are referred to:

*[Standard Designation], [version/revision, if applicable], [year of publication]*  
 (examples: API Spec 2F, 6th Edition, 1997; ISO 4624, 2002), where  
*[version/revision, if applicable] and/or [year of publication] are decided by IACS and are not necessarily to be the current/latest version.*

To take this opportunity, references to IMO instruments have been specified in the following format based upon confirmation of amendments up to the latest one:

*In case where the number of amendments is large:*

*regulation/paragraph x.x.x of SOLAS Chapter X/MARPOL Annex X/the XXX Code, as amended by IMO resolutions up to MSC.xx(xx)/MEPC.xx(xx)*

*In case where the number of amendments is small:*

*regulation/paragraph x.x.x of SOLAS/MARPOL/the XXX Code, as amended by resolutions MSC/MEPC.xx(xx), (...) and MSC/MEPC.xx(xx)*

**3 List of non-IACS Member classification societies contributing or participating in IACS Working Group:**

None

**4 History of Decisions Made:**

None

**5 Other Resolutions Changes:**

None

**6 Any hinderance to MASS, including any other new technologies:**

None

**7 Dates:**

Original Proposal: 28 October 2019 (Ref: PM18939\_IMd)  
Panel Approval: 09 November 2020 (Ref: PM20906\_IMf)  
GPG Approval: 11 December 2020 (Ref: 20206\_IGb)

• **Rev.3 (Dec 2014)**

**1 Origin for Change:**

Suggestion by IACS member

**2 Main Reason for Change:**

In UR E15 (Rev.2), the definition for "high fire risk areas" includes machinery spaces as defined by Chap. II-2 / Reg. 3.30 of SOLAS. However, "machinery spaces as defined by Chap. II-2 / Reg. 3.30 of SOLAS" include spaces having little or no fire risk as defined by MSC/Circ.1120 like ventilation and air-conditioning rooms as well as stabilizer equipment rooms, etc.

Therefore, it is necessary to amend the definition for "high fire risk areas" specified by UR E15 (Rev.2) to make reference to MSC/Circ.1120.

The task was also triggered by an external party who raised the issue that IACS UI SC165 does not strictly align with MSC Circular 1120. Original Machinery Panel task PM9400 dealt with aspects of this task. Machinery Panel did not support the proposal to nominate a fire resistant duration. Instead, Machinery Panel was of the opinion that effort may be better directed be put into the routing, rather than the fire resistance properties, of the cable and considered this matter further with a view to considering updating of IACS UR E15 where necessary improvements were identified.

### **3 List of non-IACS Member classification societies contributing through the TC Forum and/or participating in IACS Working Group:**

None

### **4 History of Decisions Made:**

The issue was raised within the Machinery Panel. After some discussion it was agreed to draft an IACS UR E15 (Rev.3) and associated HF and TB and to withdraw UI SC165.

### **5 Other Resolutions Changes**

None

### **6 Dates:**

Original Proposal: March 2013 made by Machinery Panel

Panel Approval: September 2014 by Machinery Panel

GPG Approval: 05 December 2014 (Ref: 13087\_IGc )

- **Rev.2 (Feb 2006)**

See TB in Part B. No history file available.

- **Rev.1 (May 2004)**

See TB in Part B. No history file available.

- **New (Nov 1999)**

See TB in Part B. No history file available.

## **Part B. Technical Background**

List of Technical Background (TB) documents for UR E15:

- Annex 1.     **TB for New (Nov 1999)**  
              See separate TB document in Annex 1.
  
- Annex 2.     **TB for Rev.1 (May 2004)**  
              See separate TB document in Annex 2.
  
- Annex 3.     **TB for Rev.2 (Feb 2006)**  
              See separate TB document in Annex 3.
  
- Annex 4.     **TB for Rev.3 (Dec 2014)**  
              See separate TB document in Annex 4.
  
- Annex 5.     **TB for Rev.4 (Dec 2020)**  
              See separate TB document in Annex 5.



**Technical Background Document**  
**WP/EL Task 30 “Use of Fire Resisting Type Electrical Cables and for Electrical**  
**Services Required to be Operated under the Fire Conditions” UR E15 (New)**

**1. Objective and Scope:**

To identify constructional standards for fire resistant type electric cables and to develop unified requirements on their use for electrical services which are required to be operated under fire conditions.

**2. Source of Proposed Requirements:**

The proposed requirements were developed by WP/EL members through their experience in surveying of electrical services which are required to be operated under fire conditions. SOLAS-74 and IMO Code on Alarms and Indicators {A.686 (17)}, UI SC10 (Rev.1 1997), Class Rules, International and National Standards and Specifications for Cables.

**3. Points of Discussion:**

WP/EL unanimously agreed to the draft UR

-----

Date of submission: 13 May 1999  
By WP/EL Chairman

## Technical Background

### E 15(Rev.1, 2004)

**IACS WP/EL Task No.60** “To revisit the Unified Requirements E15 to facilitate uniform implementation, by further clarification of the intent of the requirements including development of the definition of “fire zone and deck”.

#### Objective and Scope:

To revisit the requirements and notes in UR E15 “Electrical Services Required to be Operable Under Fire Conditions and Fire Resistant Cables” taking into consideration the various arrangements and possibilities for maintaining electrical services under fire conditions. Particularly, to develop definitions, practicability of maintaining the functionality, etc., as may be necessary to further clarify the intent and improve the uniform application of E15 in the area as indicated under Work Specification.

#### Background for the Proposed Revision:

Since the adoption of UR E15 in May 1999, various shipbuilders sought (and are still seeking) clarifications as to the interpretation of UR E15 including the following issues:

- (a) A “fire zone” can mean anything between main vertical/horizontal zones in SOLAS Reg. II-2/2.2.1 and any single space listed in SOLAS Reg. II-2/2.3.3 or 2.4.2. Reference to “high fire risk area” earlier in E15.2.1 suggests the latter approach may be closer to the intent, which needs to be clarified. Reference to decks could be superfluous when fire zone is properly defined. It could be even misleading without reference to bulkhead, another element consisting the boundary of zone or area.
- (b) E15.3.1 suggests that services in E15.2.2 may not be supplied under local fire at an “apparatus”. This could contradict E15.2.2 when read literally.
- (c) There is room for further refinements, including but not limited to “duplicated system” in the second paragraph of E15.2.1 (PA system is a single system with duplicated elements so as to maintain functionality – see LSA Code 7.2.2.1, a system with supply from main and emergency sources is another example.), “apparatus” in E15.3.1 (undefined), etc.

#### Points of Discussion:

It is considered that the confusion has been caused by the terminologies of “deck and the undefined “fire zone” in E15 since there are various arrangements of cables for electrical services to be operable under fire conditions. Re-investigation was mainly made for the following points:

- (a) Correction to follow the latest IEC Standards for “fire resistant cables” in E15.1,
- (b) Requirement for distinguishing the fire resistant cable from flame retardant cables or other non-fire resistant cables in E15.1,
- (c) Clarification of the original intent in E15.2.1 taking into account of the practicable application,
- (d) Development of the definition for “high fire risk areas” in E15.2.1,
- (e) Revisiting the list of services in E15.2.2,
- (f) Refining E15.3.1 for further clarification of the original intent, and

(g) Several editorial corrections.

It was also investigated if Section 1 subclause 4 of IEC 60092-352 (1997) should be incorporated in E15, which states "In circuits used for fire alarm, detection, extinguishing services, remote stopping and similar control circuits, fire resistant cables shall be considered unless the systems are self-monitoring type or failing to safety or the systems are duplicated". However, it was concluded that the above statement is not included in E15 revision since it is not the intent of E15.2.1.

The wording "provided their functionality can be maintained " in the second paragraph of E15.2.1 was deleted since it is not considered practicable to maintain the functionality after the cables to these services are damaged. However, if the system failure is detected and alarmed under self-monitoring functions, the crew can recognize the failure and would establish the compensating routines or procedure.

Further, the system fails to a safe mode and duplicated with cable runs are also compensating such failure.

Note:

A GPG Member suggested that E15.1 should also refer to IEC 60331-21 for cables with diameter of less than 20 mm. E15.1 was so amended.

## **Technical Background UR E15 (Rev. 2, Feb 2006)**

### **IACS Machinery Panel Task PM5402:**

To modify the IACS UR E15 "Electrical Services Required to be Operable Under Fire Conditions and Fire Resistant Cables"

### **Scope and objectives**

Revisit E15 in order to clarify some requirements which are ambiguous and may cause misunderstandings.

At the same time, make E15 more to the point, i.e. shorter, and restructure it to make it more readable and to separate guidance information from requirements, and present it accordingly.

### **Points of discussion**

Rev. 2 is agreed unanimously by Machinery Panel Members.

Submitted by MCH Panel Chairman  
27 Dec 2005

### **Permsec's Note: GPG Discussion (s/n 6003, 24 Jan 2006)**

1. A GPG Member commented that in Figure 1 of the UR, the style of the lines connecting ESB with DB, DB with DB, and DB with "Electrical consumers" should be changed into the dashed line indicating "Flame retardant cable". MCH Panel Chairman confirmed that was what the Machinery Panel had intended. Hence, this proposal was accepted.

2. A MCH Panel Member also commented on the same cables mentioned by the GPG Member, but recommended that these cables should be "Fire resistant cables". MCH Panel Chairman confirmed that it would be meaningless to use the fire resistant type for these cables since any equipment located inside a high fire risk area should be considered not operable under fire conditions. Hence, this proposal was not accepted.

### **Implementation (6003\_ICa, 6 Feb 2006):**

The revised UR E15 was adopted on 6 Feb. 06. In accordance with IACS Procedures, IACS Societies are to incorporate the revised UR into their Rules and/or procedures within one year of adoption by IACS Council.

## **Technical Background UR E15 (Rev. 3, Dec 2014)**

### **1. Scope and objectives**

Amend the definition of “high fire risk areas” specified by UR E15 (Rev.2) to make reference to MSC/Circ.1120.

### **2. Engineering background for technical basis and rationale**

UR E15 (Rev.2) defines “high fire risk areas” to include machinery spaces such as those defined in Chap. II-2 / Reg. 3.30 of SOLAS. However, “machinery spaces as defined by Chap. II-2 / Reg. 3.30 of SOLAS” include some spaces which have little or no fire risk (as defined by MSC/Circ.1120) such as ventilation and air-conditioning rooms as well as stabilizer equipment rooms, etc.

There are some opinions that the current version of the UR goes too far because it requires that spaces which have little or no fire risk (as defined by MSC/ Circ.1120) be treated as high fire risk areas.

Therefore, it is necessary to amend the definition of “high fire risk areas” specified in UR E15 so that it makes reference to MSC/Circ.1120.

### **3. Source/derivation of the proposed IACS Resolution**

Interpretation of machinery spaces having little or no fire risk specified by MSC/Circ.1120.

IEC 60092-353:2011

IEC 60331-1

IEC 60331-2

IEC 60331-21

### **4. Summary of Changes intended for the revised Resolution:**

The definition for “high fire risk area” in note a) (i) was amended to exclude spaces defined by of SOLAS Chap. II-2 / Reg. 9.2.2.3.2.2 paragraphs (10) as “auxiliary machinery spaces having little or no fire risk”. This amendment specifies that spaces having little or no fire risk as defined by SOLAS and MSC/Circ.1120 (i.e., spaces containing generators and major electrical units; refrigerating, stabilizing, ventilation and air conditioning machinery; and trunk to such spaces, provided they are not handling or using flammable liquids) are not considered to be high fire risk areas.

Paragraph 2.a) was amended to reference updated IEC Standards.

Paragraph 3 was added to E15 concerning electrical cables for the emergency fire pump in agreement with the interpretation for SOLAS Reg. II-2/10.2.2.3.2.2 in MSC/Circ.1120; however, the reference to paragraph 1 of E15 was rectified to refer instead to paragraph 2 (a) as the IMO Circular reflects an earlier revision of the UR and paragraph 2 (a) is now applicable for the specification of fire rated cables.

**5. Points of discussions or possible discussions**

None.

**6. Attachments if any**

None.

## Technical Background (TB) document for UR E15 (Rev.4 Dec 2020)

### 1. Scope and objectives

UR E15(Rev.3) does not reflect the agreed format for referencing the IEC standards. Rev.4 has been developed to comply with the agreed format.

### 2. Engineering background for technical basis and rationale

#### A) Format for references to Industry standards

**Format:**

*[Standard Designation], [version/revision, if applicable], [year of publication]*  
*(examples: API Spec 2F, 6th Edition, 1997; ISO 4624, 2002), where [version/revision, if applicable] and/or [year of publication] are decided by IACS and are not necessarily to be the current/latest version.*

#### B1) Format for references to IMO instruments (where the number of amendments is large)

**Format:**

*regulation/paragraph x.x.x of SOLAS Chapter X/MARPOL Annex X/the XXX Code, as amended by IMO resolutions up to MSC.xx(xx)/MEPC.xx(xx)*

#### B2) Format for references to IMO instruments (where the number of amendments is small)

**Format:**

*regulation/paragraph x.x.x of SOLAS/MARPOL/the XXX Code, as amended by resolutions MSC/MEPC.xx(xx), (...) and MSC/MEPC.xx(xx)*

### 3. Source/derivation of the proposed IACS Resolution

None

### 4. Summary of Changes intended for the revised Resolution:

UR E15 has been updated to specify the revision/version of the IEC standards and MSC Circulars as follows:

<b>IEC standards</b>	<b>Replaced by</b>
IEC 60331-1	IEC 60331-1:2018
IEC 60331-21	IEC 60331-21:1999+AMD1:2009
IEC 60331-2	IEC 60331-2:2018
IEC 60331-23	IEC 60331-23:1999
IEC 60331-25	IEC 60331-25:1999
<b>MSC Circulars</b>	<b>Replaced by</b>
MSC/Circ.1120	MSC/Circ.1120 as amended by MSC.1/Circ.1436 and MSC.1/Circ.1510

### 5. Points of discussions or possible discussions

None

### 6. Attachments if any

None



## Technical Background UR E16 (June 2002, February 2007)

### **Objective and Scope:**

#### Original scope:

To develop a Unified Requirement for the use of GRP material in cable trays and protective casings onboard ships that will constitute equivalent level of safety as steel trays.

#### Additional scope 2006 (PM6401):

To explain the reason for the requirement of using electrically conductive trays/protective casings in gas dangerous zones.

### **Background:**

The reason for the development of UR E16 in 2002 was an increase in the application of Cable trays/protective casings made of plastics materials, and the challenges this created.

The UR addressed challenges related to blocking of escape routes, load on the trays, and degree of filling of protective casings.

In addition it was required that the cable trays/protective casings made of plastics materials should be type tested according to the type test procedure. The type test procedure was developed as well and issued as a recommendation.

### **Points of Discussion:**

The technical requirements in the UR were established based upon the experience gathered by the societies having been requested to approve cable trays/protective casings made of plastics materials in addition to the following:

- USCG requirements to Fibre Reinforced Plastic (FRP) Cable Trays.
- IEC 61537 draft standard.
- Resolution MSC.61(67) adoption of the international code for application of fire test procedures.

In addition the following caused serious technical concerns:

- No adequate test for UV light influence on plastic material.
- Are vibration tests required?
- Are the tests from IMO Fire Test Procedures Code (FTPC), Resolution MSC.61(67), Part 2 – Smoke and Toxicity Test, and meeting the criteria established for plastic pipes and electric cables sufficient on passenger vessels in the passenger area.

When developing the type test procedure all of the above documents were used to encompass all technical requirements of relevance.

### **Additional scope 2006 (PM6401):**

#### Postulate from client:

“Item 4.1 of the standard REC 73 is not able to validate the requirements of resistivity according to the standard IACS E16 or even other international technical standards such as the IEC standards. Thus, that item must be disregarded, because it shows big conceptual errors. It is up to IACS provide the revision of the Standard REC 73.”

### **Problem definition:**

In order to avoid the accumulation of static electricity which when discharged in an explosive atmosphere may give rise to an explosion; the tray made of plastics materials is required to be electrically conductive in hazardous areas and is to be earthed.

Some background information on this is described below:



### **Materials for controlling the generation and the safe dissipation of static electricity**

In many cases, the choice of material and its electrical properties is a key factor in controlling the generation and the safe dissipation of static electricity.

Conductive polymers are available which have properties suitable for a wide range of applications. Sometimes the use of more traditional materials may be the most suitable choice to avoid static problems.

The electrical properties of materials, such as resistivity and charge decay properties, are very important in the specification of materials when considering electrostatic probabilities. Often these must be measured according to recognised industry or national standards.

A good material will have electrical property measurement capability such as;

- material resistivity and resistance up to  $10^{15}$  ohms
- electric field and potential (Voltage) measurements from <100V to greater than 20kV
- charge decay time measurements from 30ms to  $10^2$  seconds or greater
- triboelectrification (charge generation) measurements
- dielectric permittivity and loss measurements
- breakdown voltage measurements

### **Avoiding electrostatic spark explosion hazards**

Most people are aware from their own experience that static electricity can cause sparks to occur unexpectedly. In some industries such sparks could cause the risk of fire or explosion, and it is important to avoid this by reducing static electricity build-up to safe levels.

The Minimum Ignition Energy (MIE) is used as an indicator of the possible spark ignition sensitivity of the fuel under a given set of test conditions. The risk of ignition of a flammable mixture is a complex function of the fuel ignition sensitivity and the igniting ability (incendivity) of the spark.

Electrostatic discharges occur in many forms, and this incendivity factor in itself is highly complex. The most hazardous type of ESD is one which occurs between metal objects. This has the highest incendivity. A discharge from an insulating surface is less incendive, but can easily ignite some sensitive fuel mixtures. Another type of discharge, the corona discharge, tends to occur from sharp edges of metals at high voltages. This is generally accepted as being not incendive under most circumstances. However, ignition is a possible risk if;

- a fuel is present and a potentially flammable atmosphere could arise (many dust clouds, solvent vapours and fuel mists commonly form sensitive flammable mixtures with air)
- there is air or another oxidising material which could react with the fuel
- there is the possibility of static electric build-up leading to an incendive spark

A good general guidance is given in BS5958-1:1991 *Code of practice for control of undesirable static electricity. General considerations* and BS5958-2:1991 *Code of practice for control of undesirable static electricity. Recommendations for particular industrial situations* are key UK standards dealing with electrostatic hazards, but no standard can adequately cover all possible situations.

Typical measures aimed at preventing ignition include

- preventing the occurrence of a flammable atmosphere, e.g. inerting with nitrogen
- preventing dangerous build-up of static charges by grounding metallic objects, and replacing insulating materials with static dissipating materials.

### **Review the reference documents**

- a) IEC 60093-0; Methods of test for volume resistivity and surface resistivity of solid electrical insulating materials is a reference document which provides test procedures and calculations for the determination of volume and surface resistivity. It establishes recommendations for values of voltage and time of application, nature and geometry of

electrodes temperature and humidity of atmosphere and test specimens and conditioning of test specimens

b) IEC 60079 series states in 6.4 Static electricity

In the design of electrical installations, steps shall be taken to reduce to a safe level the effects of static electricity.

NOTE – In the absence of IEC standards on protection against static electricity, national or other standards should be followed.

### **Identify the background for the requirement**

All problems related to static electricity derive from the:

- generation of electric charges
- accumulation of these charges on insulators or insulated conductors
- electric field produced by these charges, which in turn results in a force or a disruptive discharge.

Preventive measures seek to avoid the accumulation of electrostatic charges, and the strategy of choice is to avoid generating the electric charges in the first place. If this is not possible, measures designed to ground the charges should be implemented. Finally, if discharges are unavoidable, sensitive objects should be protected from the effects of the discharges.

### **Analyse the requirements in terms of technical soundness identifying hazards using the proposed solution.**

The first point to be reviewed is whether static electrical charges are likely to be created on a passive cable tray.

How can an electrical charge build-up?

The generation of electrostatic charge is intrinsic to many industrial operations. The rate of charge generation is notoriously difficult to predict, however, operations involving rapid and energetic movement and the contact and separation of surfaces will produce increased charging. Milling of powder, for example, will generate more charge than pouring. In industry charge generation mechanisms are as follows:

- contact and separation of solid surfaces such as moving webs over rollers.
- movement of personnel.
- flow/movement of liquids.
- production of mist or aerosols.
- flow or movement of powders.
- charging by induction in an electric field. (This implies that a cable tray may be charged by induction as it will be within an electrical field)

### **Conclusions:**

1. The suggestion that there are no requirements relating to the use of plastic materials in hazardous areas "in any technical literature about electrical plants in explosive atmospheres" made in the first part of the postulate is incorrect.

2. In at least two parts of the standard referred to (IEC 60079) address electrostatic charges on non-metallic materials e.g. Part 0 and Part 14. Several other national standards resulting out of the ATEX directive require the risks from electrostatic discharge to be addressed.

3. Based upon the forgoing, IACS does not recognise a technical reason for altering the requirements as formulated in E16 and Rec.73.

Submitted by Machinery Panel chairman

11 December 2007

*(Permanent Secretariat note: approved by GPG 15 January 2008, ref. 6097aIGf)*



DET NORSKE VERITAS AS  
Maritime Technology and  
Production Centre

Veritasveien 1  
1322 Høvik  
Norway  
Tel: +47 67 57 99 00  
Fax: +47 67 57 99 11  
http://www.dnv.com  
Org. No: NO 945 748 931 MVA

Petrobras/Engenharia/SL/NORTEC  
International Technical Standardization Coordinator  
Avenida Almirante Barroso, no 81,12 Andar  
Centro-Rio de Janeiro –RJ, CEP:2001-004  
Brazil

Your ref.:  
Oscar Felizzola Souza

Our ref.:  
MTPNO370/PEMA/260-J-14254

Date:  
2007-02-26

## IACS UR E16 and Rec. 79

Dear Sir

We refer to your undated letter to DNV expressing comments on IACS UR E16 and Rec 79 with a conclusion as follows:

"The item 4.1 of the standard REC 73 is not able to validate the requirements of resistivity according to the standard IACS E16 or even other international technical standards such as the IEC standards. Thus, that item must be disregarded, because it shows big conceptual errors. It is up to IACS provide the revision of the Standard REC 73."

The submittal has prompted an investigation by IACS. Below please find relevant material from the study from available literature regarding electrostatic discharge and the conclusions made by IACS from the study.

We would generally comment on the suggestion that there are no requirements relating to the use of plastic materials in hazardous areas "in any technical literature about electrical plants in explosive atmospheres" made in the first part of their submission is incorrect.

In at least two parts of the standard referred to (IEC 60079) address electrostatic charges on non-metallic materials e.g. Part 0 and Part 14. Several other national standards resulting out of the ATEX directive require the risks from electrostatic discharge to be addressed.

### Problem definition:

In order to avoid the accumulation of static electricity which when discharged in an explosive atmosphere may give rise to an explosion; the tray made of plastics materials is required to be electrically conductive in hazardous areas and is to be earthed.

Some background information on this are described below:

### Materials for controlling the generation and the safe dissipation of static electricity

In many cases, the choice of material and its electrical properties is a key factor in controlling the generation and the safe dissipation of static electricity.

Conductive polymers are available which have properties suitable for a wide range of applications. Sometimes the use of more traditional materials may be the most suitable choice to avoid static problems.

The electrical properties of materials, such as resistivity and charge decay properties, are very important in the specification of materials when considering electrostatic probabilities. Often these must be measured according to recognised industry or national standards.

A good material will have electrical property measurement capability such as;

- material resistivity and resistance up to  $10^{15}$  ohms
- electric field and potential (Voltage) measurements from <100V to greater than 20kV
- charge decay time measurements from 30ms to  $10^2$  seconds or greater
- triboelectrification (charge generation) measurements
- dielectric permittivity and loss measurements



- breakdown voltage measurements

### **Avoiding electrostatic spark explosion hazards**

Most people are aware from their own experience that static electricity can cause sparks to occur unexpectedly. In some industries such sparks could cause the risk of fire or explosion, and it is important to avoid this by reducing static electricity build-up to safe levels.

The Minimum Ignition Energy (MIE) is used as an indicator of the possible spark ignition sensitivity of the fuel under a given set of test conditions. The risk of ignition of a flammable mixture is a complex function of the fuel ignition sensitivity and the igniting ability (incendivity) of the spark.

Electrostatic discharges occur in many forms, and this incendivity factor in itself is highly complex. The most hazardous type of ESD is one which occurs between metal objects. This has the highest incendivity. A discharge from an insulating surface is less incendive, but can easily ignite some sensitive fuel mixtures. Another type of discharge, the corona discharge, tends to occur from sharp edges of metals at high voltages. This is generally accepted as being not incendive under most circumstances. However, ignition is a possible risk if;

- a fuel is present and a potentially flammable atmosphere could arise (many dust clouds, solvent vapours and fuel mists commonly form sensitive flammable mixtures with air)
- there is air or another oxidising material which could react with the fuel
- there is the possibility of static electric build-up leading to an incendive spark

A good general guidance is given in BS5958-1:1991 Code of practice for control of undesirable static electricity. General considerations and BS5958-2:1991 Code of practice for control of undesirable static electricity. Recommendations for particular industrial situations are key UK standards dealing with electrostatic hazards, but no standard can adequately cover all possible situations.

Typical measures aimed at preventing ignition include

- preventing the occurrence of a flammable atmosphere, e.g. inerting with nitrogen
- preventing dangerous build-up of static charges by grounding metallic objects, and replacing insulating materials with static dissipating materials.

### **Review the reference documents**

- IEC 60093-0; Methods of test for volume resistivity and surface resistivity of solid electrical insulating materials is a reference document which provides test procedures and calculations for the determination of volume and surface resistivity. It establishes recommendations for values of voltage and time of application, nature and geometry of electrodes temperature and humidity of atmosphere and test specimens and conditioning of test specimens
- IEC 60079 series states in 6.4 Static electricity  
In the design of electrical installations, steps shall be taken to reduce to a safe level the effects of static electricity.  
NOTE – In the absence of IEC standards on protection against static electricity, national or other standards should be followed.

### **Identify the background for the requirement**

All problems related to static electricity derive from the:

- generation of electric charges
- accumulation of these charges on insulators or insulated conductors
- electric field produced by these charges, which in turn results in a force or a disruptive discharge.

Preventive measures seek to avoid the accumulation of electrostatic charges, and the strategy of choice is to avoid generating the electric charges in the first place. If this is not possible, measures designed to ground the charges should be implemented. Finally, if discharges are unavoidable, sensitive objects should be protected from the effects of the discharges.

### **Analyse the requirements in terms of technical soundness identifying hazards using the proposed solution.**

The first point to be reviewed is whether static electrical charges are likely to be created on a passive cable tray.

**How can an electrical charge build-up?**

The generation of electrostatic charge is intrinsic to many industrial operations. The rate of charge generation is notoriously difficult to predict, however, operations involving rapid and energetic movement and the contact and separation of surfaces will produce increased charging. Milling of powder, for example, will generate more charge than pouring. In industry charge generation mechanisms are as follows:

- contact and separation of solid surfaces such as moving webs over rollers.
- movement of personnel.
- flow/movement of liquids.
- production of mist or aerosols.
- flow or movement of powders.
- charging by induction in an electric field. (This implies that a cable tray may be charged by induction as it will be within an electrical field)

Based upon the forgoing, IACS does not recognise a technical reason for altering the requirements as formulated in E16 and Rec.73.

Yours faithfully  
for DET NORSKE VERITAS AS

Gro Elisabeth Paulsrud  
Acting Head of Department  
Systems & Components

Per Martinsen  
DNV member of  
IACS Machinery Panel

CC. DNV Rio de Janeiro

# UR E17 “Generators and generator systems, having the ship’s propulsion machinery as their prime mover, not forming part of the ship’s main source of electrical power”

## Summary

In Rev.1 of this Resolution, the way to refer to instruments other than those specified by IACS was unified.

## Part A. Revision History

Version no.	Approval date	Implementation date when applicable
Rev.1 (Feb 2021)	12 February 2021	1 July 2022
New (June 2002)	June 2002	-

- **Rev.1 (Feb 2021)**

### 1 Origin of Change:

- Other (Update to comply with the required format when industry standards are referred to)

### 2 Main Reason for Change:

There was a need to update this UR to comply with the following format when industry standards are referred to:

*[Standard Designation], [version/revision, if applicable], [year of publication]*  
 (examples: *API Spec 2F, 6th Edition, 1997; ISO 4624, 2002*), where  
*[version/revision, if applicable] and/or [year of publication] are decided by IACS and are not necessarily to be the current/latest version.*

### 3 List of non-IACS Member classification societies contributing or participating in IACS Working Group:

None

### 4 History of Decisions Made:

None

### 5 Other Resolutions Changes:

None

**6 Any hinderance to MASS, including any other new technologies:**

None

**7 Dates:**

Original Proposal: 28 October 2019 (Ref: PM18939\_IMd)  
Panel Approval: 9 November 2020 (Ref: PM20906\_IMf)  
GPG Approval: 12 February 2021 (Ref: 20206cIGb)

• **New (June 2002)**

No history file or TB document available.

\*\*\*\*\*

## Part B. Technical Background

List of Technical Background (TB) documents for UR E17:

Annex 1. **TB for Rev.1 (Feb 2021)**

See separate TB document in Annex 1.



**Note:** *There is no separate Technical Background (TB) document for the original version (June 2002).*



## Technical Background (TB) document for UR E17 (Rev.1 Feb 2021)

### 1. Scope and objectives

UR E17 (Original version) does not reflect the agreed format for referencing the IEC standards. Rev.1 has been developed to comply with the agreed format.

### 2. Engineering background for technical basis and rationale

#### Format for references to Industry standards

**Format:**

*[Standard Designation], [version/revision, if applicable], [year of publication]*  
 (examples: *API Spec 2F, 6th Edition, 1997; ISO 4624, 2002*), where  
*[version/revision, if applicable] and/or [year of publication] are decided by IACS and are not necessarily to be the current/latest version.*

### 3. Source/derivation of the proposed IACS Resolution

None

### 4. Summary of Changes intended for the revised Resolution:

UR E17 has been updated to specify the revision/version of the IEC standards as follows:

IEC standards	Replaced by
60092-201	60092-201:2019
60092-301	60092-301:1980/AMD2:1995

### 5. Points of discussions or possible discussions

IEC 60092-201:1994 was replaced by the new edition of September 2019.

In the edition of 1994, paragraph 6.2.3 is as follow:

6.2.3 The arrangements of the ship's main source of electrical power shall be such that the services referred to in 6.1.1 can be maintained regardless of the speed and direction of rotation of the main propulsion machinery or shafting.

Generators driven from the propulsion plant may be accepted as generators forming the main source of electrical power if in all sailing and manoeuvring conditions, including the propeller being stopped, the arrangement is such that the generating capacity of these generators is sufficient to provide the electrical power to comply with 6.2.2 and fulfil all further requirements, especially those of 6.2.4. They shall be not less effective and reliable than the independent generating sets.

NOTE – Following the wording of Amendment 4 (1988) the word "ship" has been replaced by the word "propeller".

Generators driven from the propulsion plant which do not comply with this sub-clause may be used as additional source(s) of electrical power with respect to the power balance, but attention should be given to a quick restoration of electrical power to all auxiliaries necessary for maintaining the ship in operational and safe condition after an electrical power interruption, for example, due to a sudden stop of the propulsion plant. The time involved for restoring the above-mentioned services should be not longer than 45 s.

The edition of 2019 had been greatly changed. The similar provision as IEC 60092-201:1994 paragraph 6.2.3 should be paragraph 8.1.1 as follow:

A generator or generator system, having the ship's main propulsion machinery as its prime mover, may be accepted as main sources of electrical power, provided that it can be used in all operating modes for the propulsion plant, including standstill of the vessel (with the propeller stopped). When there are several main propulsion engines, each of these could be the driver of a main source of power. One propulsion engine can only be the driver of one main source of electric power.

## **6. Attachments if any**

None

## UR E18 “Recording of the Type, Location and Maintenance Cycle of Batteries”

### Part A. Revision History

Version no.	Approval date	Implementation date when applicable
Rev.1 (Dec 2014)	18 December 2014	1 January 2016
NEW (July 2003)	16 July 2003	-

- **Rev.1 (Dec 2014)**

**.1 Origin for Change:**

- Suggestion by IACS member

**.2 Main Reason for Change:**

Clarify when the review of the battery schedule is to be done.

**.3 List of non-IACS Member classification societies contributing through the TC Forum and/or participating in IACS Working Group:**

None

**.4 History of Decisions Made:**

Following a review of member’s current practice the Panel agreed on a Form A under PM14906\_IMf.

**.5 Other Resolutions Changes**

None

**.6 Dates:**

Original Proposal: 1 September 2014 made by Machinery Panel  
 Panel Approval: 19 November 2014  
 GPG Approval: 18 December 2014 (Ref: 14145\_IGb)

- **NEW (July 2003)**

Prepared by WP/EL in July 2003.

See TB in Part B.

## **Part B. Technical Background**

List of Technical Background (TB) documents for UR E18:

Annex 1. **TB for Original Resolution (July 2003)**

See separate TB document in Annex 1.

Annex 2. **TB for Rev.1 (Dec 2014)**

See separate TB document in Annex 2.



## **Technical Background (TB) document for UR E18 (New, July 2003)**

### **1 Scope and objectives**

To formulate IACS requirements for the recording of the type, location and maintenance cycle of batteries.

### **2 Engineering background for technical basis and rationale**

In view of the increasing use of electronic and computer based systems and electrical equipment that operate at low voltage, e.g. 12 or 24 volts d.c, there has been the associated increasing use of locally installed batteries around the ship. Examples of such batteries include those fitted within equipment for memory power supply back up, in the event of the failure of the normal electrical power supply and those for the transitional emergency supply for low location lighting systems and other emergency services. Failure of such batteries as the result of poor maintenance or ageing may cause the loss of essential or emergency services. Because of the quantity of such batteries and the variety of equipment and locations in which they may be installed it is considered necessary to require that a schedule of such batteries be compiled and kept.

### **3 Source/derivation of the proposed IACS Resolution**

In-house expertise

### **4 Summary of Changes intended for the revised Resolution**

N/A

### **5 Points of discussions or possible discussions**

An increasing number of items of SCADA (supervisory control and acquisition) equipment are now low power and voltage as the result of advanced technology. Because of the difficulty of providing such equipment with an alternative/emergency source of power, where required, at low voltage from a central source without prohibitive voltage loss, the use of UPS (uninterruptible power source) units has increased dramatically. The batteries in the UPS units require maintenance and also replacement after a specified lifetime. Failure of such batteries as the result of poor maintenance or ageing may cause the loss of essential or emergency services.

Most of the modern batteries fitted are of the valve- regulated sealed type<sup>1</sup> requiring reduced ventilation. Where vented type<sup>2</sup> batteries replace valve-regulated sealed types, it is to be ensured that there is adequate ventilation and that Society's requirements relevant to the location and installation of vented types batteries are complied with.

During discussion it was noted that developing a listing of batteries and keeping it on board each ship is supported, provided it is used during the subsequent class

surveys. This task is to ensure that the location of batteries is known and that they are safe and maintained in a correct manner. The full text of the UR agreed by WG was forwarded to GPG for consideration attached to the 32nd WP/EL Progress Report.

1 A valve-regulated battery is one in which cells are closed but have an arrangement (valve) that allows the escape of gas if the internal pressure exceeds a predetermined value.

2 A vented battery is one in which the cells have a cover provided with an opening through which products of electrolysis and evaporation are allowed to escape freely from the cells to the atmosphere.

## **6 Attachments if any**

N/A

## **Technical Background (TB) document for UR E18 (Rev. 1, Dec 2014)**

### **1 Scope and objectives**

Clarify when the review of the battery schedule is to be done, i.e. during plan approval and/or onboard survey.

### **2 Engineering background for technical basis and rationale**

A review of members' current practice revealed different approaches towards the review of the battery schedule. It is the intention of Rev. 1 to clarify the requirement.

### **3 Source/derivation of the proposed IACS Resolution**

Members' current practice and experience in the application.

### **4 Summary of Changes intended for the revised Resolution**

Adding clarification that the battery schedule is to be reviewed by the Society during plan approval or the new building survey.

### **5 Points of discussions or possible discussions**

The proposed clarification was agreed unanimously.

### **6 Attachments if any**

N/A

---

**Technical Background Document****E 19                      Ambient temperatures for electrical equipment  
(New, July 2003)        in areas other than machinery spaces.**

IACS WP/EL Task 54 “Ambient temperatures for electrical equipment in areas other than machinery spaces”

**1.        Objective and scope:**

To formulate an IACS requirements for ambient temperatures for electrical equipment in areas other than machinery spaces

**2.        Source of proposed requirements.**

WP/EL XXIII meeting, St.Petersburg 2001

**3.        Résumé:**

The current ambient temperatures specified for electrical equipment is the same as that for mechanical equipment as exemplified in UR M28, i.e. 45°C. Whilst this acceptable for electrical equipment located in machinery spaces and on open deck there is a considerable amount of electrical equipment, including cables, that is fitted in locations which never experience these elevated temperatures. Examples of these areas are machinery control rooms and switchboard rooms that are generally fitted with air conditioning units and passenger accommodation on passenger ships, which again have air conditioning.

Along with the increased generating capacity now installed is the associated increase in the capacity and size of the main switchboard and, for high voltage systems, the associated section-board(s). Switchboard manufacturers advise that for a 5°C reduction in ambient temperature can result in smaller frame sizes of circuit breakers and a reduction in the size of the switchboard(s)/section-board(s).

Electrical systems in passenger accommodation are now being designed using industrial practices except that heat producing equipment, such as fluorescent lights, are currently required to specially built for a 45°C ambient temperature which they are very unlikely to experience.

**5.        Points of discussion**

The current ambient temperatures specified for electrical equipment is the same as that for mechanical equipment as exemplified in UR M 28, i.e. 45°C. Whilst this acceptable for electrical equipment located in machinery spaces and on open deck there is a considerable amount of electrical equipment, including cables, that is fitted in locations which never experience these elevated temperatures. Examples of these areas are machinery control rooms and switchboard rooms that are generally fitted with air conditioning units and passenger accommodation on passenger ships, which again have air conditioning.

Along with the increased generating capacity now installed is the associated increase in the capacity and size of the main switchboard and, for high voltage systems, the associated section-



-----  
board(s). Switchboard manufacturers advise that for a 5°C reduction in ambient temperature can result in smaller frame sizes of circuit breakers and a reduction in the size of the switchboard(s)/ section-board(s).

Electrical systems in passenger accommodation are now being designed using industrial practices except that heat producing equipment, such as fluorescent lights, are currently required to specially built for a 45°C ambient temperature which they are very unlikely to experience.

The full text of the UR agreed by WG was forwarded to GPG for consideration attached to the 32nd WP/EL Progress Report.

# Technical Background Document

UR E19(Rev.1, August 2005)

**IACS WP/EL AOB 5.8** “To modify the UR E19 “Ambient Temperatures for Electrical Equipment in Areas other than Machinery Spaces” with regard to definition of machinery spaces.”

## **Objective and scope:**

To modify the UR E19 “Ambient Temperatures for Electrical Equipment in Areas other than Machinery Spaces” with regard to definition of machinery spaces.

## **Source of proposed requirements.**

UR E19 background.

## **Points of discussion**

According to SOLAS, Machinery Control Rooms are categorized as Machinery Spaces. Thus, the current UR E19 seems not to be applicable to the equipment installed in Machinery Control Rooms because of its title; however, the “Technical Background” of UR E19 allows such application.

Since the UR E19 and its technical background are discrepant each other the modifications of title of the UR E19 and para.1 of UR E19 were made.

Submitted by WP/EL Chairman  
31 Jan 2005

## UR E20 "Installation of electrical and electronic equipment in engine rooms protected by fixed water-based local application fire-fighting systems (FWBLAFFS)"

### Part A. Revision History

Version no.	Approval date	Implementation date when applicable
Rev.1 (June 2009)	22 June 2009	-
NEW (May 2004)	31 May 2004	-

- **Rev.1 (June 2009)**

See TB in Part B.

- **NEW (May 2004)**

See TB in Part B.

## **Part B. Technical Background**

List of Technical Background (TB) documents for UR E20:

Annex 1. **TB for Original Resolution(May 2004)**

See separate TB document in Annex 1.

Annex 2. **TB for Rev.1(June 2009)**

See separate TB document in Annex 2.



## Technical Background

### UR E 20 (New, 2004)

**IACS WP/EL Task 52** “Influence of fixed water-based local application fire-fighting systems (FWBLAFFS) in engine rooms to electrical equipment”

#### **Objective and scope:**

To develop UR for the electrical safety of electrical and electronic equipment within engine rooms, in areas protected by FWBLAFFS, and adjacent areas where water may extend.

#### **Source of proposed requirements.**

SOLAS Ch. II-2 / 10.5.6.2

MSC Circ. 913

MSC Circ. 1082

#### **Points of discussion**

Increasingly, water-based fire-fighting systems are being used in engine rooms, control rooms and other spaces, as well as for local application, which when activated may have an extremely destructive effect on electrical equipment.

In this context an essential requirements contained in IMO document MSC Circ. 913, clause 3.2, should be noted: “The activation of the fire-fighting systems should not result in loss of electrical power or reduction of the maneuverability of the ship”.

WG considered the possibility of damage to some electrical equipment due to the operation of FWBLAFFS. The potential for damage depends upon a number of factors, which include:

1. Various types of available FWBLAFFS and their potential effects on electrical equipment within their vicinity.
2. Requirements for the installation of FWBLAFFS in machinery spaces in respect to adjacent electrical equipment.
3. Degree of ingress protection for electrical equipment in these areas with regard to the type of FWBLAFFS used. (e.g. low and/or high pressure systems etc.)
4. Voltage at which the equipment operates (low voltage vs. high voltage systems).
5. Location of the electrical equipment and enclosure inlets relative to the water mist nozzles.
6. Mist droplet size and droplet density (which can vary substantially from manufacturer to manufacturer depending upon their particular nozzle design).

Each of the above items directly impact the potential for damage to electrical equipment, and it would therefore appear that all such items must be adequately quantified before establishing any reasonable conclusions regarding the potential damage to electrical equipment. Beyond the potential damage to electrical equipment, it would appear that the potential danger of shock would also be of significant concern.

During the XXV WP/EL Meeting it was decided to make some definitions concerning with areas protected by FWBLAFFS where electrical equipment are installed.

Taking into account the aforesaid WP/EL developed this Unified Requirement, which was agreed by WG and forwarded to GPG for consideration attached to the 33<sup>rd</sup> WP/EL Progress Report.

## Technical Background

### UR E20, Rev.1 (June 2009)

Machinery Panel Task PM5403 “Develop an alternative text for the Interpretation to Paragraph 3.2 in MSC/Circ. 1082 and review the need for the IP44 requirement in UR E20”

1. Clause 3.2 of the Annex to the MSC/Circ. 913 “Guidelines for the Approval of Fixed Water Based Local Application Fire-Fighting Systems for Use in Category-A Machinery Spaces” reads as follows.  
*“The activation of the fire-fighting systems should not result in the loss of electrical power or the reduction of maneuverability of the ship.”*
2. MSC/Circ.1082 gives an interpretation for the paragraph 3.2 of the MSC/Circ. 913 as follows.  
*“The activation of the system should not require engine shutdown, closing fuel oil tank outlet valves, evacuation of personnel and sealing of the space. Any of these actions would lead to loss of electrical power or reduction of maneuverability. Paragraph 3.2 is not intended to place requirements on electrical equipment.”*
3. While noting the above interpretation, the Machinery Panel concluded that the classification requirements of URE20 are necessary and appropriate to address the safety of ships and personnel in the event of FWBLAFFS activation.
4. Based on service experience since the introduction of SOLAS Ch II-2/C, Reg.10.5.6 and cases where the appropriateness of the UR E20 requirement for electrical and electronic equipment enclosures in protected or adjacent areas exposed to direct spray to have a degree of protection of at least IP44 has been challenged, Rev. 1 introduces the possibility of evidence of suitability for lower degrees of protection to be submitted for consideration by the Society.
5. This may involve adequate testing or submission of satisfactory test evidence and/or analysis that is relevant to the particular installation of FWBLAFFS (including nozzle type), equipment and machinery that is found on board a given ship. The use of enclosures with a lower degree of protection than IP 44 will be subject to the approval of the Society in each case.
6. Updating of the requirements of IEC 60092-201, *Electrical installations in ships – System design – General*, Section 7: *Degree of protection* will be considered when issued to assess whether there is any impact on UR E20.

Submitted by Machinery Panel Chairman  
27 May 2009

**Permanent Secretariat note (June 2009):**

Rev.1 of UR E20 was approved by GPG on 22 June 2009 (ref. 6014\_IGi).

## UR E21 “Requirements for uninterruptible power (UPS) units”

### Summary

In Rev.2 of this Resolution, the requirements for UPS are extended to other cases than alternative and transitional power, recognizing widely used practice and existing usage that UPS is often utilized for continuous and uninterruptible services in the application of essential services like DP control system, AMS, BMS, etc.

### Part A. Revision History

Version no.	Approval date	Implementation date when applicable
Rev.2 (Feb 2024)	23 February 2024	1 July 2025
Corr.1 (June 2022)	25 June 2022	-
Rev.1 (Feb 2021)	12 February 2021	1 July 2022
New (Aug 2005)	August 2005	-

#### • Rev.2 (Feb 2024)

##### 1 Origin for Change:

- Suggestion by IACS Member

##### 2 Main Reason for Change:

It was found that the requirements in UR E21 are now limited to alternative and/or transitional power to emergency services as defined in SOLAS II-1/42 and SOLAS II-1/43, although it is well recognized that UPS has been and will be commonly used as a means of continuous and uninterruptible power supply to essential services such as UPS for DP control system, AMS and BMS, etc.

It was also observed that the requirements in UR E21 were already reflected in the Rules of certain member Societies.

In order to resolve above findings, it is suggested to extend the applicability of UR E21 to other cases than alternative and transitional power, dividing the application whether mandatory or voluntary, specifying more in detail the requirement for location and service duration, also reflecting the latest edition of IEC standards.

##### 3 List of non-IACS Member classification societies contributing or participating in IACS Working Group:

None

#### **4 History of Decisions Made:**

The suggestion was discussed in 37<sup>th</sup> MP Meeting, and the majority shared the necessity and agreed to continue discussions in succeeding rounds of correspondence. The draft Rev.2 was presented to SuP before finalization. The SuP comments and MP responses were recorded for future reference.

#### **5 Other Resolutions Changes:**

None

#### **6 Any hinderance to MASS, including any other new technologies:**

None

#### **7 Dates:**

Original Proposal	: 02 February 2023	(Ref: PM20906tRIc)
Panel Approval	: 12 January 2024	(Ref: PM20906tIMj)
GPG Approval	: 23 February 2024	(Ref: 24012_IGb)

#### **• Corr.1 (June 2022)**

##### **1 Origin for Change:**

Suggestion by IACS Member

##### **2 Main Reason for Change:**

To delete or replace the term "cable", which is not related to the content of this UR, in Notes 1 and 3.

To take this opportunity, references to IMO instruments have been slightly modified, taking into account the latest Format according to IACS Procedures Volume 1 (Rev.16).

##### **3 List of non-IACS Member classification societies contributing or participating in IACS Working Group:**

None

#### **4 History of Decisions Made:**

Corr.1 of Rev.1 of UR E21 was discussed by correspondence and reached a unanimous agreement of Machinery Panel Members.

#### **5 Other Resolutions Changes:**

None



**6 Any hinderance to MASS, including any other new technologies:**

None

**7 Dates:**

Original Proposal : 15 July 2021 (Ref: PM20906mIMa)  
Panel Approval : 03 June 2022 (Ref: PM20906mIMf)  
GPG Approval : 25 June 2022 (Ref: 20206cIGh)

**• Rev.1 (Feb 2021)**

**1 Origin of Change:**

- Other (Update to comply with the required format when industry standards are referred to)

**2 Main Reason for Change:**

There was a need to update this UR to comply with the following format when industry standards are referred to:

*[Standard Designation], [version/revision, if applicable], [year of publication] (examples: API Spec 2F, 6th Edition, 1997; ISO 4624, 2002), where [version/revision, if applicable] and/or [year of publication] are decided by IACS and are not necessarily to be the current/latest version.*

To take this opportunity, references to IMO instruments have been specified in the following format based upon confirmation of amendments up to the latest one:

*regulation/paragraph x.x.x of SOLAS Chapter X/MARPOL Annex X/the XXX Code, as amended by IMO resolutions up to MSC.xx(xx)/MEPC.xx(xx)*

**3 List of non-IACS Member classification societies contributing or participating in IACS Working Group:**

None

**4 History of Decisions Made:**

None

**5 Other Resolutions Changes:**

None

**6 Any hinderance to MASS, including any other new technologies:**

None

**7 Dates:**

Original Proposal	: 28 October 2019	(Ref: PM18939_IMd)
Panel Approval	: 09 November 2020	(Ref: PM20906_IMf)
GPG Approval	: 12 February 2021	(Ref: 20206cIGb)

- **New (Aug 2005)**

No history file available

\*\*\*\*\*

## **Part B. Technical Background**

List of Technical Background (TB) documents for UR E21:

Annex 1. **TB for New (Aug 2005)**

See separate TB document in Annex 1.

Annex 2. **TB for Rev.1 (Feb 2021)**

See separate TB document in Annex 2.

Annex 3. **TB for Rev.2 (Feb 2024)**

See separate TB document in Annex 3.

*Note: There is no separate Technical Background (TB) document available for Corr.1 (June 2022).*

**Technical Background Document  
UR E21 (New, August 2005)**

**IACS WP/EL Task 53**

**Unified requirements for the use of Uninterruptible Power Supply (UPS) units as alternative and/or transitional sources of electrical power in lieu of centralized arrangements.**

**Objective and scope:**

To formulate an IACS requirement for the acceptance of the use of uninterruptible Power Supply (UPS) units as alternative and/or transitional sources of electrical power in lieu of centralized arrangements.

**Source of proposed requirements.**

SOLAS Ch. II-1 / 42 and 43

SOLAS Ch. II-1 / 42.2.3 or 43.2.4.

IEC 62040

**Points of discussion**

A increasing number of items of SCADA equipment and alike, are now low power and voltage as the result of advanced technology. Because of the difficulty of providing such equipment with an alternative/emergency source of power, where required, at low voltage from a central source without prohibitive voltage loss and because of the convenience and design advantages of using a UPS unit, the use UPS units has increased dramatically.

UPS units are also now being proposed, fitted and being accepted as an alternative to supplying emergency electrical equipment from the transitional source of electrical power as required by SOLAS. Whilst such arrangements do not meet the wording of SOLAS they meet and in some cases exceed the intent.

The purpose of the UR is to clarify the acceptable arrangements and to propose to IMO amendments considered necessary to the applicable SOLAS requirements

During the XXVI WP/EL Meeting it was decided to make some definitions concerning with UPS type and also:

To specify a minimum UPS capacity subjected to survey

To specify a battery charger capacity

To place the definitions given in the footnote up into beginning of the document

Taking into account the aforesaid WP/EL developed this Unified Requirement, which was agreed by WG and forwarded to GPG for consideration attached to the 34<sup>rd</sup> WP/EL Progress Report.

Submitted by WP/EL Chair  
31/01/2005

## Technical Background (TB) document for UR E21 (Rev.1 Feb 2021)

### 1. Scope and objectives

UR E21 (Original version) does not reflect the agreed format for referencing the IEC standards. Rev.1 has been developed to comply with the agreed format.

### 2. Engineering background for technical basis and rationale

#### A) Format for references to Industry standards

**Format:**

*[Standard Designation], [version/revision, if applicable], [year of publication]*  
 (examples: API Spec 2F, 6th Edition, 1997; ISO 4624, 2002), where  
*[version/revision, if applicable] and/or [year of publication] are decided by IACS and are not necessarily to be the current/latest version.*

#### B) Format for references to IMO instruments (where the number of amendments is large)

**Format:**

*regulation/paragraph x.x.x of SOLAS Chapter X/MARPOL Annex X/the XXX Code, as amended by IMO resolutions up to MSC.xx(xx)/MEPC.xx(xx)*

### 3. Source/derivation of the proposed IACS Resolution

N/A

### 4. Summary of Changes intended for the revised Resolution

UR E21 has been updated to specify the revision/version of the IEC standards as follows:

IEC standards	Replaced by
IEC 62040:1999	IEC 62040-3:2011
IEC 62040	IEC 62040-3:2011 (for definition)
IEC 62040	IEC 62040 IEC 62040-1:2017, IEC 62040-2:2016, IEC 62040-3:2011, IEC 62040-4:2013 and/or IEC 62040-5-3:2016, as applicable (for requirements)

### 5. Points of discussions or possible discussions

None

### 6. Attachments if any

None

## Technical Background (TB) document for UR E21 (Rev.2 Feb. 2024)

### 1. Scope and objectives

This revision revisits the application of UPS in services (mandatory or voluntary) and addresses the location and duration requirements depending on the services (e.g. emergency services, essential services) in consideration with the base standards (IEC 62040 series)

### 2. Engineering background for technical basis and rationale

The requirements for UPS need to be extended to other cases than alternative and transitional power for emergency services, taking into account that UPS has been widely used for continuous and uninterruptible services in the application of essential services like DP control system, AMS, BMS, etc.

#### 2a. Specification of the data utilised in the development/revision of the proposed IACS Resolution, if any

N/A.

### 3. Source/derivation of the proposed IACS Resolution

SOLAS II-1/42 and SOLAS II-1/43,  
FSS Code Chapter 9, 2.2.2 to 2.2.4,  
MSC.1/Circ.1580, 3.4.1.8,  
IACS UI SC134,  
IEC 62040 series.

### 4. Summary of Changes intended for the revised Resolution:

- A. **The subject of UR E21:** now that the requirements will also be applicable to other cases than emergency services, the phrase "as alternative and/or transitional power" has been deleted in wary of confusion or conflict.
- B. **Scope/Application:** the wording "Scope" is rephrased as "Application", in consideration of revision on applicability whether mandatory (1.1 strict application) or voluntary (1.2 case by case application at the discretion of Society). Essential services as per UI SC134 and FSS Code Ch. 9, 2.2.2 to 2.2.4 are added.
- C. **Definitions:** UPS definition and topologies, with supportive figures and associated terminologies, are updated in view of the latest IEC 62040-3.
- D. **External bypass:** requirements for external bypass are revisited and clarified.

### 5. Points of discussions or possible discussions

In the last item of para. 3.5 of UR E21 rev.2, "any other fault and abnormal conditions of the UPS unit" should indicates para. 4.2 of IEC 62040-1:2017.

However, para. 4.2 of IEC 62040-1:2017 refers to the withdrawn IEC62477-1:2012 which is a standard for power electric converters. In the light of above, it is understood that this requirement should be applied on a case-by-case basis, and it is agreed to add "as applicable" at the end of the requirement.

The duration of UPS performance is briefly mentioned in para. 5.1 which is only applicable to emergency services, and thus it was suggested to give guidance in the UR for other services. This suggestion got the simple majority support but did not achieve qualified majority. For the reference of readers, the proposed guidance is given here.

*5.1 The output power is to be maintained for the duration required for the connected equipment and in consideration of paragraph 1, as follows, for instance but not limited to:*

- .1 alternative power UPS: for a period of 36h or 18h as stated in SOLAS II-1/42 or SOLAS II-1/43,*
- .2 transitional power UPS: for half an hour (30minutes) as stated in SOLAS II-1/42 or SOLAS II-1/43,*
- .3 supplemental power UPS: for minimum 30minutes as stated in FSS Code Chapter 9, 2.2.4,*
- .4 DP control system UPS: for minimum 30minutes as stated in MSC.1/Circ.1580, paragraph 3.4.1.8, and*
- .5 essential services UPS: for minimum 30minutes when used for essential services as defined in IACS UI SC134.*

The SuP comments on Testing requirement of 6.2 was discussed among MP. While there was suggestion to further revise the testing requirement, but it was acknowledged that the comments are not included in the scope of this revision and it is impractical to thoroughly investigate the testing requirement and improve at this stage.

There was another comment from SuP on application of the UR whether mandatory or voluntary, and it was confirmed that voluntary means at the discretion of the Society, i.e. 1.1 is mandatory and 1.2 is up to the decision of each Society.

The SuP comments and MP responses are recorded as follow for future reference and possible update at the next revision process.

<b>Item 4</b>	<b>Survey Panel members comments</b>
4.1	<b>SuP XXX comment</b>
4.1.1	Section 3.5. Section is header is Design / Construction. Lends the reader to infer that the testing is only at the manufacturer. Consider clarifying if testing is also necessary at the initial and annual machinery surveys on only manufacture.
MP1	For the design and construction part, the wording is existing; in 3.5 the expression "normally attended location" has been replaced by the expression

	“continuously manned station(s)”. MP1 understands that part 3 relates to tests at the manufacturer, while the requirements of 3.5 can be verified during the initial survey
MP2	The proposed comments are acceptable to MP2
MP3	It's suggested to make it clear that functional tests will be carried out at preliminary inspection and annual survey, and other required tests are all product tests performed in the workshop or factory
MP4	MP4 is of the view that Section 3.5.(header is Design / Construction) is related to design requirement and not directly related to testing at the manufacturer
MP5	MP5 does not understand the comment as section 3.5 is not related to testing
MP6	MP6 can accept all three comments made.
MP7	MP7 has no objection to the SuP ABS comments.
MP8	MP8 understands that it is basically required for testing at the manufacturer, but as it is also part of “6. Testing and survey” (first bullet of paragraph 6.2 is updated as “functionality, including operation of alarms in paragraph 3.5”) and thus it is to be verified after installation on board.
Proposed Action	The comment is beyond the scope of this revision work and impractical to complete at the very final stage. Section 3.5 will be retained as is.
4.1.2	Section 6.1 Section is a bit ambiguous, suggest additional clarity as to surveyed at “manufacturing and testing”. Unclear which testing (manufacture only, initial onboard, annually).
MP1	MP1 suggests the following addition in underlined font: 6.1 UPS units of 50 kVA and over are to be surveyed by the Society during manufacturing and testing, <u>in accordance with 6.2.</u>
MP2	The proposed comments are acceptable to MP2
MP3	It's suggested to make it clear that functional tests will be carried out at preliminary inspection and annual survey, and other required tests are all product tests performed in the workshop or factory
MP4	MP4 share comment
MP5	MP5 agrees with the SuP comment
MP6	MP6 can accept all three comments made.
MP7	MP7 has no objection to the SuP comments.
MP8	MP8 understands that it is the requirement for witness of surveyor, i.e. in case of UPS of 50kVA and over, it is to be witnessed by the Surveyor.
Proposed Action	The comment is beyond the scope of this revision work and impractical to complete at the very final stage. 6.1 will be updated as suggested by MP1.
4.1.3	Section 6.2 Suggest that standards / criteria are noted for surveyors to apply during testing. Temperature rise (what is acceptable criteria) Ventilation (appropriate flow based on KVA?) Batter Capacity, not clear if this is discharging rate, etc..
MP1	With regard to temperature rise, MP1 notes that IEC 62040-1 refers to the temperature rise tests of IEC 62477-1 , which in 5.2.3.10 for type tests reads: The test is intended to ensure that parts and accessible surfaces of the PECS (power electronic converter systems) do not exceed the temperature limits specified in 4.6.4 and the component manufacturer’s temperature limits of safety-relevant parts. With regard to battery and ventilation rate, MP1 understands that section 5.4.2 “Battery” of IEC 62040-3 applies, which states in 5.4.2.1 reads A battery



	intended to serve as an energy storage device for a UPS complying with this document shall comply with the IEC 62040-1 requirements for location, ventilation, marking and protection of a battery (Annex CC of IEC 62040-1 contains guidance similar to that one of UR E18). In this regard MP1 understands that temperature rise type test and battery/ventilation may relate to design and construction and not to testing.
MP2	The proposed comments are acceptable to MP2
MP3	It's suggested to make it clear that functional tests will be carried out at preliminary inspection and annual survey, and other required tests are all product tests performed in the workshop or factory
MP4	MP4 share comment
MP5	MP5 agrees with the SuP comment and would suggest referring to relevant tests in IEC 62040-3. It may in this respect be necessary to reconsider the required tests
MP6	MP6 can accept all three comments made.
MP7	The SuP commented on the test items on 6.2 of draft UR E21. In this regard, MP7 suggests deleting all items that can be changeable depending on design and arrangement excluding the first item «Functionality, (...) in paragraph 3.5». MP7 has no objection to the other SuP comments on 6.3 of draft UR E21.
MP8	MP8 wishes to remind that the said items (temperature rise, ventilation rate, battery capacity) are not the scope of this revision, and it is understood that each Society has applied this requirement at its own right so far.
Proposed Action	Please note that the said items (temperature rise, ventilation rate, battery capacity) are not the scope of this revision, and it is understood that each Society has applied this requirement at its own right so far. Also it is impractical to thoroughly review the testing requirement and revise at this stage. 6.2 will be retained as is and HF&TB be updated describing the comment and discussion.
4.2	<b>SuP XXX comment</b> See attached file Att.3
MP1	In light of the above, MP1 agrees with the SuP member comment for removal of the three items under testing. The last two suggestions for the addition of tests are not considered necessary at this stage.
MP2	MP2 prefers the current wording of the UR.
MP3	it's suggested to identify type approval tests and factory acceptance tests following the way as in Table 1 of UR E13
MP4	MP4 share comments
MP5	MP5 agrees in general with the SuP comments and would suggest a review of the tests for alignment with, or reference to, the tests in IEC 62040-3, which also specifies whether the tests are type tests or routine tests.
MP6	MP6 does not accept the comments made within Att.3 and suggests that the UR remains as worded.
MP7	The SuP commented on the test items on 6.2 of draft UR E21. In this regard, MP7 suggests deleting all items that can be changeable depending on design and arrangement excluding the first item «Functionality, (...) in paragraph 3.5». MP7 has no objection to the other SuP comments on 6.3 of draft UR E21.
MP8	MP8 wishes to remind that the LR comments are not the scope of this revision, and it is understood that each Society has applied this requirement at its own right so far.
Proposed	See PA for 4.1.3

Action	
4.3	<b>SuP XXX comment</b>
4.3.1	It is our opinion that the title should not be amended as proposed; the UPS remains an alternative and or transitional source of power and the system to which the UPS is applied are expected to return to be feeded by the main or the emergency souce of power. In case the new paragraph 1.1.3 of UR E21 applies then the definition of Uninterruptible Power System (UPS) should not consider the failuire of the of the AC input power.
MP1	SuP member comment is not very clear to us. In this regard we can accept the revised title.
MP2	The proposed comment is not acceptable to MP2
MP3	MP3 does not agree to the comment, because UPS in this UR is an emergency source of power not a transitional one
MP4	MP4 does not share SuP comment
MP5	MP5 does not agree with the SuP comment. The terms “alternative” and “transitional” are used in relation to power supply requirements for emergency services in SOLAS regulations 42 and 43 and are not representative for power supplies to essential services required during a main power blackout condition.
MP6	MP6 does not accept comment made.
MP7	MP7 prefers the updated title.
MP8	MP8 does not share the SuP member opinion.
Proposed Action	The comment does not achieve support. Title is retained.
4.3.2	It is not clear the intention expressed under paragraph 2 of the HF “Main Reason for Change” that reads inter alia: <i>...Omissis....dividing the application whether mandatory or voluntary.... Omissis</i> Being an UR, it should be mandatory and voluntary application should be left to the policy of each individual Class Society as specified in UR E21 paragraph 1.2.; the latter could be deleted.
MP1	MP1 feels that the expression can be retained, however if the word “voluntary” creates confusion, then “optional” can be a replacement, while the expression “dividing the application whether” can be deleted together with the expression “strict application”.
MP2	The proposed comment is acceptable to MP2
MP3	MP3 agrees to the comment, and further suggests to delete Paragraph 1.2 of UR E21
MP4	MP4 share SuP comment
MP5	MP5 agrees with the SuP comment.
MP6	MP6 can accept the comment made.
MP7	MP7 agrees to the SuP comment for HF. And if accepted, part 1 of TB file will be updated too.
MP8	MP8 understands that each member can exercise its own discretion for voluntary items only which is already said in paragraph 1.2.
Proposed Action	Please note that UPS has been widely used for other services than 1.1 and each member can exercise its own discretion for voluntary items. HF&TB is updated as per MP7 pointed out and 1.2 will be retained as is.

As to the location of UPS units for other services than emergency supply, there was a proposal to further elaborate paragraph 4.1, such as "The UPS unit for other services may be installed near to the load equipment", "Location of UPS unit for other services is at the discretion of the Society", "The UPS unit for other services may be installed near to the load equipment, or in other locations at the discretion of the Society", but did not achieve the majority support.

Paragraph 1.1.4 was rephrased at the final moment. The intent of the paragraph is to describe the supplemental power supply which prevents momentary loss of power and permits the continued operation and is capable of operating all connected visual and audible fire alarm for a period of 30 minutes as required by FSS Code Chapter 9, 2.2.2 to 2.2.4.

## **6. Attachments if any**

None.

## UR E22 “Computer-based systems”

### Summary

This UR provides requirements for Computer-based Systems. This revision is intended to improve and clarify the requirements for computer-based system during design, construction, commissioning and maintenance, including better clarification of the system integrator. Objective of this revision is to ensure that UR E22 provides a minimum set of requirements to suppliers and system integrators of software-based automation that ensures that both individual systems and the total integrated functionality is of high quality and safe for use.

### Part A. Revision History

Version no.	Approval date	Implementation date when applicable
Rev.3 (June 2023)	13 June 2023	1 July 2024
Rev.2 (June 2016)	10 June 2016	1 July 2017
Rev.1 (Sept 2010)	02 Sept 2010	1 Jan 2012
Corr.1 (Oct 2007)	05 Oct 2007	-
New (Dec 2006)	17 Dec 2006	1 Jan 2008

- **Rev.3 (June 2023)**

#### 1 Origin for Change:

*Other (Specify: A general desire to update E22 to bring it in line with the current technologies and methods for development of computer-based systems. Concerns related to the role of the system integrator)*

#### 2 Main Reason for Change:

During the evaluation at the panel meeting (April 1<sup>st</sup>, 2020) of the current UR E22 in general, and with specific focus on DNV reservation to the current UR, all societies agreed that at an update of the UR is necessary.

- Focus on the activities required for development, installation and updates of cyber physical systems and clarify the requirements from this holistic view.
- Clarify the role division between the systems integrator and the supplier of the individual system.
- Consider best practices from other industries than the maritime industry and put emphasis on the different verification methods/steps (including use of simulators)
- Change management for the system (hardware, software and parameters)
- Survey requirements

### **3 List of non-IACS Member Classification Societies contributing through the TC Forum and/or participating in IACS Working Group:**

IACS Joint working group members that contributed with review comments:

### **4 History of Decisions Made:**

Forms A and 1 agreed by GPG under 20063aIGp dated 05 May 2023.

### **5 Other Resolutions Changes:**

- IACS UR E26 Cyber resilience of ships
- IACS UR E27 Cyber resilience of on-board systems and equipment

These two URs where development in parallel with the update to version 3, and they are referenced from E22 as normative standards.

### **6 Any hinderance to MASS, including any other new technologies:**

None.

### **7 Dates:**

Original Proposal:	14 June 2021	(Made by: Cyber Systems Panel)
Panel Approval:	22 May 2023	(Ref: PC20005_ICze)
GPG Approval:	13 June 2023	(Ref: 20063aIGr)

#### **• Rev.2 (June 2016)**

### **1 Origin for Change:**

*Other (Specify: Concerns related to the increasing complexity and fragmentation of on-board systems and man-machine interfaces were raised by Industry)*

### **2 Main Reason for Change:**

IACS council C69, Action Plan Item K-18 and EG/COSDI (Complex On-board Systems with Dependability Issues) propose the creation of a project team in order to modify IACS Unified requirement E22 focusing on:

- dedicated software dependent systems installed onboard ships like Power Management Systems, Steering Control, Safety systems
- service systems installed onboard specific ship types like dynamic positioning systems, lifting appliances
- minimum elements to be taken into account in risk analysis including software items during the whole life cycle of system. This analysis should also take into account security aspect involved in use of software and data links
- tests undertaken on software dependent systems during life cycle and intervention of different actors including Class Societies
- list of reference documents and standards likely to be selected for these activities

**3 List of non-IACS Member Classification Societies contributing through the TC Forum and/or participating in IACS Working Group:**

None.

**4 History of Decisions Made:**

Forms A and 1 agreed by GPG under 14119\_IGs dated 26 February 2015.

**5 Other Resolutions Changes:**

None.

**6 Dates:**

Original Proposal: 9 February 2015 Made by Machinery Panel Panel

Approval: 14 April 2015 (Ref: PM14917b)

GPG Approval: 10 June 2016 (Ref: 14119\_IGw)

- **Rev.1 (Sept 2010)**

**1 Origin of Change:**

Suggestion by an IACS member

**2 Main Reason for Change:**

Suppliers are proposing wireless communication links in safety related class installations, including that for propulsion and steering arrangements. There is a need to address the possible development of requirements for short range wireless communications, for example using Bluetooth, and IEEE 802.11 (WiFi) protocols.

**3 List of non-IACS Member classification societies contributing through the TC Forum and/or participating in IACS Working Group:**

None.

**4 History of Decisions Made:**

The project team attempted to follow a holistic approach to the development of requirements by conducting a safety assessment of potential wireless technologies used in classed safety related application.

Relevant best practices applied by Member Societies and related industries and existing standards were considered. A variety of industry stakeholders were consulted to provide feedback that was acted upon.

UR E22 defines system categories for programmable electronic systems that have been used to differentiate wireless technology in different applications.

## **5 Other Resolutions Changes:**

UR E10 (Rev.5 Dec 2006) "Test Specification for Type Approval" is under revision.

This revision will introduce additional requirements for the assessment of:

- a. Electromagnetic field for equipment within the transmission range of the wireless data communication devices.
- b. Radiated Emission of wireless data communication devices above 1GHz.

## **6 Dates:**

Original Proposal: *October 2008 Made by the Machinery Panel*

Panel Approval: *June 2010*

GPG Approval: *02 September 2010 (Ref: 8672\_IGe)*

- **Corr.1 (Oct 2007)**

Standard footnote for the explanation of the "contracted for construction" date added. (ref. 7546a)

No TB document available.

- **New (Dec 2006)**

Task No.31 of WP/EL.

See TB in Part B.

## **Part B. Technical Background**

List of Technical Background (TB) documents for UR E22:

Annex 1      **TB for New (Dec 2006)**

See separate TB document in Annex 1.

Annex 2      **TB for Rev.1 (Sept 2010)**

See separate TB document in Annex 2.

Annex 3      **TB for Rev.2 (June 2016)**

See separate TB document in Annex 3.

Annex 4      **TB for Rev.3 (June 2023)**

See separate TB document in Annex 4.

**Note:** *There is no separate Technical Background (TB) document available for Corr.1 (Oct 2007).*



## **UR E22 UNIFIED REQUIREMENTS FOR THE ON BOARD USE AND APPLICATION OF PROGRAMMABLE ELECTRONIC SYSTEMS**

### **Technical Background**

#### **1. Scope and objectives**

UR E22 complements the existing UR E10 for hardware test standards with requirements for software. Reliable operation of programmable electronic systems and consequently of the systems functionality and safety requires suitable software. The new requirements for the assessment of software relate to quality assurance, testing at module and system level, and to integration and failure simulation.

UR E22 relates to the "GUIDELINES FOR THE ONBOARD APPLICATION AND USE OF COMPUTERS" as prepared by IACS and the NMD at the request of IMO. At the 39th session of the Sub-Committee on Ship Design and Equipment Norway and IACS were invited to prepare "GUIDELINES FOR THE ONBOARD APPLICATION AND USE OF COMPUTERS". The IACS/NMD proposal was adopted as a MSC/Circ. 891 dated 21.12.1998. These Guidelines have been developed to provide an international standard for design, approval and testing of such systems and are additional to the regulation of the SOLAS Convention.

#### **2. Source/ derivation of requirements**

Related international standard: IEC 60092-504

## **Technical Background for UR E22 (Rev.1, Sept. 2010)**

### **1. Scope and objectives**

To consider the suitability of wireless technologies in Classed installations and to introduce suitable Unified Requirements that support an effective unified approach to the assessment of wireless technologies where permitted by Member Societies.

- To assess where wireless technologies are suitable for use in classed installations.
- To development a Unified Requirement that will allow a unified assessment approach to the use of wireless technology onboard ships that:
  - If necessary, states clearly any restriction of use for safety related applications with reasoning for restriction;
  - covers both performance, testing and assessment requirements;
  - addresses relevant hazards to contribute to overall safety;
  - reflects current technologies and best practice;
  - allows for application to future technology by considering the services affected; and
  - ensures consistency with UR E10, Test Specification for Type Approval.

### **2. Engineering background for technical basis and rationale**

There is a need to address the possible development of requirements for short range wireless communications typically using Bluetooth, and IEEE 802.11 (WiFi) protocols. This is becoming an issue as suppliers are providing such communication links as part of their products in classed installations.

### **3. Source/derivation of the proposed IACS Resolution**

Developed by IACS Project Team.

### **4. Summary of Changes intended for the revised Resolution:**

The following section of UR E22 has been updated to give consideration of wireless technologies.

Section 2. Requirements applicable to programmable electronic systems  
Section 3. Documents to be submitted  
Section 4. Tests and Evidence  
Appendix 1, Section 7. On-board tests

The following text has either been changed or added.

Rationale for new 2.1.2:

To provide for consideration of alternative design arrangements, potentially including the use of wireless data communications links, in safety critical applications which do not conventionally comply with the requirements of UR E22.

Rationale for new 2.3.6:

To make clear that data link communications are to be arranged to cause systems to 'fail to safe' upon loss of data communications.

Rationale for new 2.3.7:

To make clear that data link communications capacity should avoid the possible effects of data link congestion and provide adequate data transmission times as required by the application. This requirement aligns with IEC 60092-504, sub-Clause 10.6.3.

Rationale for new Subsection 2.4 Additional requirements for wireless data links: Additional requirements governing the use of wireless data links in applications covered by Classification are grouped together to assist users.

Rationale for new 2.4.1:

Through application of a holistic approach to the development of requirements, and use of the existing UR E22 categorising of programmable electronic systems based on the application, it was observed that:

- the likelihood of failure of a category III system leading to an accident with catastrophic severity needs to be minimised. As such, the use of unconventional technology for such applications will only be permitted exceptionally in cases where evidence can be presented that demonstrates acceptable system performance to the satisfaction of the Society;
- failure of a category II system may lead to accidents and Classification requirements are to be provided to assist in reducing the likelihood of failure as a consequence of design, construction or installation;
- the failure of category I systems may be tolerated by mitigation other than classification requirements. The requirements may optionally be used for category 1 systems.

Rationale for new 2.4.2:

Recognising that wireless technology may be subject to denial of service, either intentionally or unintentionally, an alternative means of control for essential services independent of a wireless data communication link is to be provided so that systems are designed and arranged such that essential services provision is not dependant on a wireless data communication link.

Rationale for new 2.4.3:

Requirements are introduced to address attributes considered to be specifically required for wireless data communication links in Category II system applications. It is considered appropriate to apply proven internationally recognised protocols to achieve compliance under most circumstances and it is recognised that application of alternative protocols will likely necessitate closer scrutiny of evidence provided to the Society to verify compliance.

Rationale for new 2.4.3(a):

Data integrity is considered essential for the reliability of Category II system applications.

Rationale for new 2.4.3(b):

To address security, systems designs are to be defined and limited in terms of the----- total planned devices (including planned devices that are not always present and/or connected, e.g. planned arrangements for manufacturer representative access). Device authentication is to be utilised to prevent connection of devices that that are not part of the system design.

Rationale for new 2.4.3(c) and (d):

Measures considered necessary to address security.

Rationale for new 2.4.4:

It is recognised that frequency spectrum usage and power levels should be restricted to that permitted internationally and, where such exist, the requirements of the Flag State to ensure the wireless data communication link operation will be allowed.

The note recognises that the actual operation and control of systems and the areas visited globally by a ship are not addressed by Classification, noting that different local restrictions globally could potentially prove difficult for ship operators in practice in cases. In such cases, ship operators are responsible for assessment in advance so that safe system operation is achieved, noting the requirements of 2.4.2.

Rationale for new 3.4:

Provision of evidence of compliance with UR E22 for systems incorporating wireless data communication.

Rationale for new Table III entry:

On board testing under operational conditions to demonstrate system operation as planned is considered necessary to verify compliance and safe operation.

Rationale for new Appendix I, 7.3:

Specification of testing to be conducted. This includes the need to consider different expected operating conditions onboard. It should be recognised that testing may need to be conducted to demonstrate that systems coexist without mutual interference under expected operating conditions

## **5. Points of discussions or possible discussions**

Short-range wireless data communication technologies for systems covered by Classification are not yet considered to have a significant record of service experience for reference.

Specifying of 'wired' back-ups for wireless data communication links is not considered a pragmatic option.

Wireless technology should be as safe as a 'wired' equivalent so far as is reasonable and practicable.

The introduction of wireless technology to applications covered by Classification introduces a number of concerns including the possibility of unauthorised access and manipulation of systems and 'jamming' as a deliberate act or as a

consequence of EM interference

Category III applications dependant on wireless data communication to operate should only be considered at this time if a body of evidence demonstrating acceptable performance to the satisfaction of the Society is prepared. This may exclude the use of wireless technology in an application due to cost and availability of technology.

Some countries and locations (e.g. ports) have different restrictions from those internationally agreed on frequency spectrum usage and transmission power levels. Some states may also enforce legislation related to accessibility of transmitted data for state security purposes. Ship operators should consider and adapt to these effects.

Classification approval will be based upon the whole system, including wireless technology, operating as presented.

It is recognised that the use of wireless systems in non-classed and category I systems may cause interference with other classed systems, immunity requirements have been introduced accordingly.

Mitigation of Safety, health and environmental risks is provided for with the use of internationally accepted power levels and frequencies.

## **6. Attachments if any**

None.

## **Technical Background (TB) document for UR E22 (Rev.2 June 2016)**

### **1. Scope and objectives**

Updating of UR E22 focused on introducing top down analysis of systems including programmable code and life cycle approach of these systems.

Several work items were considered in order to prepare drafting of modified UR E22:

#### **Work Item 1: Scope of requirement**

- definition of dedicated software dependent systems installed onboard ships which would need to be covered by mandatory requirements (like Power Management Systems, Steering Control, Safety systems .).
- definition of service systems installed onboard specific types of ships which would need to be covered by additional requirements (like dynamic positioning systems, lifting appliances .).

#### **Work Item 2: Risk analysis minimum requirements**

Definition of minimum elements to be taken into account in risk analysis including software items during the whole life cycle of system, including security aspect involved in use of software and data links.

#### **Work Item 3: Testing requirements**

Definition of minimum tests that shall be undertaken on software dependent systems during life cycle and intervention of different actors including Class Societies.

#### **Work item 4: External references list**

Definition of a list of external references that can be used for such activities.

### **2. Engineering background for technical basis and rationale**

Taking into account life cycle approach at the level of a system as described in various dedicated standards commonly used (as IEC 61508 "Functional safety of electrical/electronic/programmable electronic safety-related systems", IEC/ISO 31010 "Risk Management - Risk assessments techniques") in specification, design and verification of programmable systems seemed necessary in order to promote a global approach based on a risk analysis of programmable systems.

### **3. Source/derivation of the proposed IACS Resolution**

- IEC 61508: Functional safety of electrical/electronic/programmable electronic safety-related systems
- ISO/IEC 12207: Systems and software engineering - Software life cycle processes

- ISO 9001:2008 Quality Management Systems - Requirements
- ISO/IEC 90003: Software engineering - Guidelines for the application of ISO 9001:2008 to computer software
- IEC 60092-504: Electrical installations in ships - Part 504: Special features - Control and instrumentation
- ISO/IEC 25000 - Systems and software engineering - Systems and software Quality Requirements and Evaluation (SQuaRE) - Guide to SQuaRE
- ISO/IEC 25041 - Systems and software engineering - Systems and software Quality Requirements and Evaluation (SQuaRE) - Evaluation guide for developers, acquirers and independent evaluators
- IEC 61511: Functional safety - Safety instrumented systems for the process industry sector
- ISO/IEC 15288: Systems and software engineering - system life cycle process

#### **4. Summary of Changes intended for the revised Resolution:**

The following section of UR E22 will provide new requirements compared to previous revision of UR E22:

- Section 1.4 for references has been created and some standards dealing in particular with software lifecycle added.
- Section 2 has been created in order to provide definitions for stakeholders and system hierarchy.
- Section 2.3 is showing examples for category II and III systems.
- Section 2.4 is defining Simulation Tests.
- Section 3.1 is providing requirements for life cycle approach.
- Section 3.2 is providing requirements for limited approval of sub-systems and programmable devices not integrated yet into a system.
- Section 3.3 is dealing with modification during operation. The notion of software registry was introduced in order to track versions of software and security scans during software updating.
- Section 3.4 is providing minimum requirements for system security related to software.
- Section 4 is referring to UR E10 about requirements regarding environment.
- Section 5 is dealing with wireless data links minimum requirements. It is considered risk analysis will cover risks connected to data links inside computer-based systems.

#### **5. Points of discussions or possible discussions**

Paragraph 1.3 "References": Content of this paragraph was debated. It has been clearly mentioned that the use of these standards is not compulsory, but just given as a possibility. The extent of the list was also questioned: in some existing Class Rules dealing with software, the list of references is much more extensive. This list might be updated in the future, the texts listed now seemed to be a good compromise in order to cover the topics apprehended in this Unified Requirement and having together a limited list of references.

Paragraph 2.1 "Stakeholders": The definitions mentioned here have the ambition to be limited in number (Owner, System Integrator, and Supplier) and to define

what the stakeholders are doing. It was also included how these responsibilities could be modulated during the different phases of the project and according to the level(s) of integration required by the project.

Paragraph 3.1.2.1 "Risk assessment of system": reference text to be used regarding risk assessment was debated, it was agreed to introduce IEC/ISO 31010 in order to determine the method of risk management. Possibility of omission of this risk assessment was also debated and made possible in case of such following justifications for a computer-based system:

- How the risks are known
- The equivalence of the context of use of the current computer-based system and the computer-based system initially used to determine the risks
- The adequacy of existing control measures in the current context of use.

An opinion was expressed that a requirement for a risk assessment had the potential to be unclear in terms of the content, scope, level of detail, methodology etc. and thus a general requirement for a risk assessment without further guidance would be inappropriate. In particular, the following rationale was provided:

*"A risk assessment is in general not part of maritime new-building projects today, and when such assessment is not part of the general process/machinery/system design, a risk assessment of the control system may be considered a bit out of context. Further, if a risk assessment is required (both from system suppliers and system integrators), the method, scope/coverage and the criteria for the assessment must be defined clearly to enable a consistent practice in the industry. A risk assessment may be very relevant for certain systems in certain types of vessels, but for a traditional bulk carrier with proven-in-use systems, it may be unnecessary. As an alternative to the general requirement for a risk assessment, maybe a failure mode analysis for integrated systems could be a more achievable measure."*

Paragraphs 3.1.3 and 3.1.5: The way the "integration" issue was dealt with has been evolving during the elaboration of the modified UR E22. At the beginning, COSDI group outputs were mentioning the creation of an additional Unified Requirement dealing with integration. After GPG stated not to go through this achievement, it was decided to include what was integration of software inside the system in itself (Paragraph 3.1.3) and also a more global integration of the computer-based systems with other systems inside the ship (Paragraph 3.1.5).

Paragraph 3.2 "Limited approval": The situation of programmable devices not being specifically assigned to a computer-based system in particular but that could be tested on a limited scope was debated. It was decided to provide them with a "limited approval".

Paragraphs 3.3 and 3.4: "Security" aspects were included in UR E22 as it seemed to many Class Societies to be an important item to implement and that traceability was together a way to keep reliability and security present during the system life cycle.

This is why the "Software Registry" was introduced in order to keep the



records of software revision and security checks.

Paragraph 5.2 "Specific requirements for wireless data links": maintaining these requirements inside UR E22 about Computer-based systems about wireless data links was debated.

**6. Attachments if any**

None.

## **Technical Background (TB) document for UR E22 (Rev.3 June 2023)**

### **1. Scope and objectives**

Evolution of UR E22 focused on tidying up the requirements described in the document and to clarify the responsibilities of the different roles.

Several work items were considered to prepare drafting of modified UR E22:

#### **Work Item 1: Restructuring of the existing information (requirements)**

A detailed review of E22 V2 revealed that the document structure in some cases made it hard to distinguish between the different process steps and also some inconsistencies and contradictions. The document structure was updated to be based on a process structure with further breakdown into the responsibilities of the different roles. Also the class societies verification and survey activities have been made clearer by describing this per activity requirement.

#### **Work Item 2: The process of defining a system's category**

The initial plan was to make a specific mapping between different systems and their category, but after lengthy discussion both in the PT and the cyber panel (CP) it was decided that this is not possible, and that a system's category can only be correctly defined in the context of its application in a specific vessel.

#### **Work Item 3: Differentiation of the system categories (CAT I, CAT II, CAT III)**

The desire to make more distinct differentiation to the requirements for the different categories ended up with the clarification that there are no mandatory requirements on category 1 systems, and that the process requirements on category II and Category II systems should be identical because a system that is defined as category II on a specific vessel, may be defined as category III in another vessel. It was still opted to keep the category II and III separate, as there are technical requirements that differ between them.

#### **Work Item 4: The responsibilities of the systems integrator**

The role of the systems integrator has been clarified and strengthened by the addition of explicit requirements on activities and artifacts. As default of the Yard and the Owner shall take on the role of systems integrator unless another organization or person is explicitly appointed.

#### **Work item 5: Management of change**

Management of change is a process that spans throughout the whole lifecycle of a vessel and its systems, in order to reflect this without having to repeat a number of activity descriptions several times, the management of change has been described in a separate section in the UR (paragraph 6). The described management of change process is a simple high-level process inspired by several standards. It may be implemented using several specific standards, methods, and tools.

#### **Work item 6: Resolving member's reservations towards UR E22 V2**

Panel members had three reservations towards UR E22 Revision 2. In order to resolve these, the following steps were implemented:

- 1) The "quality plan" has changed from being mandatory to be submitted on request of the Class society. Alternatively, the quality plan may be inspected at a relevant test activity witnessed by the class society (FAT/SAT/SOST).
- 2) The "risk assessment" for each system has changed from being mandatory to be provided upon request of the class society.
- 3) The requirement on the owner to maintain a "software registry" during operation has been changed to require a change record to be kept up to date.

## **2. Engineering background for technical basis and rationale**

Having evaluated the current reference list in E22 the Project team (PT) found that the listed standards still are valid, and that only a few additions were needed for e.g. cyber security. The reference list has however been split into a normative and an informative section.

### **2a. Specification of the data utilised in the development/revision of the proposed IACS Resolution, if any**

None.

## **3. Source/derivation of the proposed IACS Resolution**

Developed by IACS Project Team.

## **4. Summary of Changes intended for the revised Resolution:**

### **Restructuring:**

The document has been restructured to better communicate the requirements of the different roles involved. Most of the requirements are connected to the process of creating a computer-based system while a few technical requirements are still present. These technical requirements have been organised into a separate paragraph.

The structure of the document is now as follows:

- Paragraph 1.3 for references has been divided into a normative and an informative part and some IACS URs dealing with cyber security have been added along with a standard for automatic reporting on software status.
- Paragraph 2 clarifies how systems and components are to be approved
- Paragraph 3 gives the definition of the system categories and some examples of typical systems for the different categories
- Paragraph 4 gives the requirements on the development and delivery of computer-based systems
- Paragraph 5 gives the requirements on the maintenance of computer-based systems
- Paragraph 6 gives an overview of the required management of change process
- Paragraph 7 gives the technical requirements in the systems

### **Mapping of paragraphs between revision 2 and revision 3:**

Below is a mapping of how revision 2 has transformed into revision 3.

<b>Revision 2 paragraph:</b>	<b>Revision 3 paragraph(s):</b>	<b>Comment:</b>
Title	Title	The title of the UR E22 has been changed from "On Board Use and Application of Computer-based systems" to "Computer-based systems" to better reflect its content and scope
<b>1. Introduction</b>	1 Introduction	The introduction paragraph now contains the "terms and abbreviations" along with a new paragraph (1.4) which describes the structure of the UR. This is done to improve the usability of the UR.
1.1 Scope	1.1 Scope	The scope description has been shortened by removing some wording about "focus on functionality of the software and hardware" as the focus of E22 is on the system- and software-lifecycle process.
1.2 Exclusion	1.2 Exclusion	The text has been updated to describe in more general terms which systems that are not in scope of the UR. The scope itself has not changed, and the old text from revision 2 which references different SOLAS chapters is kept as a guidance note.
1.3 References	1.3.1, 1.3.2	<ul style="list-style-type: none"> <li>- The reference list has been split into two: <ul style="list-style-type: none"> <li>1.3.1 Normative and</li> <li>1.3.2 Informative standards</li> </ul> </li> <li>- IACS URs for cyber security are added as Normative standards</li> <li>- The applicable revision has been added to each reference document</li> </ul>

<b>2. Definitions</b>	1.5 Definition of abbreviations and terminology	The definitions paragraph has been included in the "introduction" paragraph and restructured into a "terms" part and an "abbreviations" part. The entries are listed in alphabetical order to make it easier to find a specific term. Some definitions have been rewritten in order to avoid that actual requirements are included in the definition text. The definition of the three categories has been moved to a separate paragraph.
2.1 Stakeholders	Removed	-
2.1.1 Owner	Included in 1.5.2 Terminology	-
2.1.2 System integrator	Included in 1.5.2 Terminology	The term has been changed to "systems integrator" in order to put emphasis on that several systems are being integrated into a "system of systems"
2.1.3 Supplier	Included in 1.5.2 Terminology	-
2.2 Objects	Removed	This was only a grouping of some terms
2.2.1 Object definitions	Removed	This was only a grouping of some terms
2.2.1.x Each defined term is a separate paragraph	Included in 1.5.2 Terminology	-

2.3 System categories	3.1 System category definitions	<p>The definitions of category I and category II are unchanged.</p> <p>Category III has been slightly updated to also include systems which failure may cause "catastrophic situations".</p> <p>The introductory text and table heading have been updated to focus on that the is the effect of these system's failure which drives the classification.</p> <p>Also see the discussion in "paragraph 3.1 system category definitions" in part 4 below</p>
2.4 Other terminology	Removed	This was only a grouping of some terms
2.4.x Each defined term is a separate paragraph	Included in 1.5.2 Terminology	-
<b>3. requirements for software and supporting hardware</b>	4 requirements on development and certification of computer-based systems	Most of the content of paragraph 3 in revision 2 is included in paragraph 4 in revision 4, but technical requirements on the systems have been moved to a separate paragraph 7
3.1 Life cycle approach	4.1.1 Life cycle approach with appropriate standards	This heading and the text directly under it have been reformulated to a separate requirement

3.1.1 Quality system	4.1.2 Quality system	<p>In order to clarify requirements and make the document structure more consistent, the requirements on quality systems and the Society's follow-up of this has been consolidated into one paragraph.</p> <p>The requirements on the quality system have been made more explicit, better related to the activity requirements and are clearly defined in table-format.</p>
3.1.1.1 Relevant procedures regarding responsibilities, system documentation, configuration management and competent staff.	4.1.2 Quality system	The requirements on quality systems and the Society's follow-up of this has been consolidated into paragraph 4.1.2
3.1.1.2 Relevant procedures regarding software lifecycle and associated hardware:	4.1.2 Quality system	The requirements on quality systems and the Society's follow-up of this has been consolidated into paragraph 4.1.2
3.1.1.3 Minimum requirements for approval of Quality system:	4.1.2 Quality system	<p>The requirements on quality systems and the Society's follow-up of this has been consolidated into paragraph 4.1.2</p> <p>Because both the system supplier and the systems integrator are required to follow a defined quality system, this paragraph is now placed under paragraph 4.1 General requirements</p>
3.1.1.4 Quality Plan	4.2.1 and 4.3.2 Define and follow a quality plan	The paragraph has been split into two parts: one as a requirement on the system supplier, one on the systems integrator. The actual requirement to define and follow a quality plan has not changed

<p>3.1.2 Design phase</p>	<p>4.2 Requirements on the system supplier <i>and</i> 4.3 Requirements on the systems integrator</p>	<p>The content has in general been split in two parts; one where the system supplier is responsible, and one where the systems integrator is responsible. Changes to the individual sub paragraphs are described below, and in general the responsibilities of the systems integrator have been clarified and somewhat increased.</p>
<p>3.1.2.1 Risk assessment of system</p>	<p>4.3.4 Risk assessment of the system</p>	<p>The requirement to do a risk analysis of the system is now only applicable if requested by the Society.</p> <p>The responsibility now lies on the systems integrator, while it earlier could be done either by the systems integrator or the system supplier. The reason for this change is that a system's category must be decided in the context of the vessel in question.</p> <p>The part about submitting a justification for not doing a risk analysis if "the associated risks are well understood" has been removed, because it is superfluous when the risk analysis shall only be submitted when requested by the Society.</p>
<p>3.1.2.2 Code production and testing</p>	<p>4.2.5 Software code creation, parameterization, and testing</p>	<p>The revision 2 text only describes the documentation to be submitted and only indirectly put other requirements on the system supplier. The requirement is rewritten to explicitly require the system supplier to perform certain activities and to document this.</p>



<p>3.1.3 Integration testing before installation on board</p>	<p>4.2.6 Internal system testing before FAT and 4.2.7 Factory acceptance testing (FAT) before installation on board</p>	<p>The revision 2 text requires that intra-system integration shall be performed, and then goes on to describe documentation requirements for FAT. The requirement has been rewritten and split into two paragraphs to reflect that this is in fact two different activities; one where the system supplier performs an internal test of the system to be delivered, and one FAT event where the Society approves the test-program and witness the test execution.</p> <p>For the internal testing (4.2.6) it is now specified that this activity shall take place before the FAT, and there is a more explicit list of which aspects of the system that shall be tested. Use of simulators and other test-tools are encouraged and shall be documented. Documentation of the internal testing shall be made available to the Society during the FAT or submitted upon request.</p> <p>For the FAT (4.2.7) It is now specified that the expectation is that this test is performed "...with the project specific software operating on the actual hardware components to be installed on board...", and that other solutions must be agreed with the Society.</p> <p>There is now an explicit requirement that test records with pass/fail</p>
---	---	--

		<p>results and software versions are documented.</p> <p>Some of the documentation requirements for the system have been moved to the activity "System description" (4.2.3), but the overall documentation requirements are generally unchanged.</p>
3.1.4 Approval of programmable devices for Category II and III systems	2 Approval of systems and components	<p>This paragraph has been rewritten to clarify the difference between "vessel-specific certifications" and "type approval of computer-based systems" based on the current practice of Class Societies</p>
3.1.5 Final integration and on board testing	<p>4.3.6 System acceptance test (SAT) onboard the vessel <i>and</i> 4.3.7 Testing of integrated systems on vessel-level</p>	<p>Most of the requirements in this paragraph are now included in "System acceptance test (SAT) onboard the vessel". in addition it is now an explicit requirement that test records with pass/fail results and software versions are documented.</p> <p>In order to put more emphasis on the testing of whole functions across systems a separate "Testing of integrated systems on vessel-level" activity has been added.</p> <p>It is now explicitly stated that it is the systems integrator that is responsible for these tests.</p> <p>The requirement for the Society to approve test plans and witness the tests is mandatory for both test activities</p>

3.2 Limited approval	Removed	The reason for removal of this paragraph was that it was not clear what the "limited approval" constituted. Instead, the mechanisms for approval of computer-based systems are described in paragraph 2
3.3 Modifications during operation	5 Requirements on maintenance of computer-based systems	The content has in general been split in three parts in order to clarify the responsibilities of the different roles; one where the system supplier is responsible, and one where the systems integrator is responsible and one where the owner is responsible
3.3.1 Responsibilities	5.1.1 Responsibilities (partly)	<p>The requirement on the owner to define who shall act as systems integrator during operations is unchanged.</p> <p>The requirements regarding a software registry have been rewritten and moved to paragraph 6.11 because it describes one of many activities required by a defined "management of change" process</p>
3.3.2 Change management	6 Management of change and 4.2.8 and 4.3.8 and 5.2.1 and 5.3.1	The description and requirements regarding change management is substantially extended and a management of change process based on industry good practices is now expected to be followed. The requirements for the change management process are described in paragraph 6, and other paragraphs require the individual roles to follow relevant parts of the described management of change process

3.4 System security	Removed	Replaced by reference to IACS UR E26 and E27 as normative standards
<b>4. Requirements for hardware regarding environment</b>	4.2.4 Environmental compliance of hardware components	The requirement is basically unchanged, but there is now a clarification that it is the responsibility of the system supplier to provide this information, and that the "Reference to Type approval certificate or other evidence of type testing" shall be submitted "for information" (not for approval) for category II and category III systems
<b>5. Requirements for data links for Category II and III systems</b>	7.2 Data links	The requirements on datalinks have been grouped together with other technical system requirements in a new paragraph named "7. Technical requirements on computer-based systems"  The Society's verification of the technical requirements has been clarified
5.1 General requirements	7.2.1 General requirements for category II and III systems	-
5.1.x Each technical requirement is a described as a paragraph heading	7.2.1 bullet #1 through bullet #5	The requirements for datalinks are essentially unchanged except for a change to the requirement regarding "single failure" (rev. 2: 5.1.2) which has been spitted in two (rev. 3: 7.2.1 bullet#1 and 7.2.1 bullet#2) and reworded to focus on the "fail-to safe" principle and the need for local means to compensate for loss of remote control
5.2 Specific requirements for wireless data links	7.2.2 Specific requirements for wireless data links	The requirements regarding wireless data links have been slightly reorganized to achieve a better structure in the document, but the requirements have not changed.

5.2.1 Category III systems shall not use wireless data links unless specifically considered by the Class Society on the basis of an engineering analysis carried out in accordance with an International or National Standard acceptable to the Society.	7.2.2 bullet #1	-
5.2.2 Other categories of systems may use wireless data links with following requirements:	7.2.2 bullet #1	-
5.2.2.x Each technical requirement is a described as a paragraph heading	7.2.2 bullet #2 through bullet #5	-
<b>Annex: Documents for Class Society and test attendance</b>	Annex A, Annex B	<p>The information in the previous Annex has been divided into two lists: Annex A which summarizes the documentation to be submitted to the Class Society, and Annex B which lists the activities the Class Society will be witnessing.</p> <p>The Annexes does not introduce any requirements, they only serve as a quick overview and summary of the requirements defined in the main part of the UR.</p> <p>For each of the items in the annexes there is a reference to the paragraph in which the requirement is defined and detailed.</p>

### Deleted paragraphs:

Some items have been removed as a part of the restructuring. These include:

- Paragraph 3.1.2.1 Risk assessment of system (partly): The part about submitting a "justification for the omission" of the risk analysis has been removed.
- Paragraph 3.2, Limited approval. The reason for removal of this paragraph was that it was not clear what the "limited approval" constituted. Instead, the mechanisms for approval of computer-based

- systems are described in paragraph 2.
- Paragraph 3.4 system security. The IACS UR E26 Cyber resilience of ships and UR E27 Cyber resilience of on-board systems and equipment are both listed as Normative standards that shall be used for computer-based systems. The inclusion of these makes the description of system security in E22 superfluous, and it has thus been removed.

### Added requirements:

Some items have been added because of the restructuring and evolution of E22, most noticeably:

- 4.3.3 Determining the category of the system in question
- 4.3.5 Define the vessel's system-architecture
- 4.3.6 Testing of integrated systems on vessel-level
- 5. Requirements on maintenance of computer-based systems
- 7.1 Reporting of system and software identification and version

## 5. Points of discussions or possible discussions

**Paragraph 3.1 "System category definitions":** Despite hard work and long discussion, it was not possible for the PT to agree upon a definite mapping between a system name and a category. It turns out that the criticality of a specific system may differ from vessel to vessel, and that the determination of the category for a specific system thus must be done per vessel. Some may argue that this creates a challenge for suppliers that want to type approve their system before the vessel in question is known, but with the elimination of all requirements for CAT I systems and the fact that all process requirements are identical between CAT II and CAT III, this should not pose a big problem for the system suppliers.

**Paragraph 3.2 "Class societies' scope":** The lack of requirements on category I systems (except in special cases) lead to some discussions and review comments. It is however current practise for most class societies not to include these systems into the scope of the verification.

**Paragraph 3.3.3 " Determining the category of the system in question":** As a result of the discussion described in paragraph 3.1 above, the category of a system must be determined in the context of its installation onboard a specific vessel. In order to facilitate this, the categorization needs to be performed by the shipyard (which per default is the systems integrator during newbuilding) based on the category definitions in paragraph 3.1.

If the class society determines that there is a need to analyse or document the categorization, a documented risk-assessment may be requested (as described in paragraph 3.3.4).

**Paragraph 4.3.5 "Define the vessel's system-architecture":** There was some concerns that some yards may not easily be able to create the requested "system architecture" and that in some cases there might be some "buyer equipped systems" that are out of the control of the yard. The PT however thinks that even if the provided system-architecture is not complete or perfect, it will still be beneficial as a starting point for the scope and functionality discussions that must take place before the test plans for the "system of systems test" (SOTS) are created.

**Paragraph 4.3.5 “Testing of integrated systems on vessel-level (SOST)”:**

This activity is maybe the biggest change to E22 in this version. This activity represents the core of the strengthening the systems integrator role and requires the systems integrator to make sure that the different systems are working well together before the handover to the owner. There were some discussions regarding to what degree this kind of testing already takes place, but no clear patterns were discovered, and the current practice is most likely varying not only from yard to yard, but also from project to project.

**Paragraph 7.1.1 “System identification”:** There was some discussions regarding how hard the UR should “push” the concept of automated collection of the identity and revision of the onboard system software. We do think this will become standard in the future, but for now it is only a recommendation to follow ISO 24060 for a ship software logging system.

**Application of UR E22 to Maritime Autonomous Surface Ships (MASS):**

There was some discussions if the UR should be updated to address aspects of systems and software used for monitoring and controlling systems of autonomous ships. Such systems are expected to be especially reliant on computer and software, and typically also contain elements of machine learning, which requires quite specialized processes for development and verification. It was decided that the requirements for such computer-based systems were out of scope for this update. It is however evident that the focus on the processes and quality control that the UR provides will serve as a good basis also for computer-based systems used in context of autonomy and remote control.

### ❖ Impact on the different roles between revision 2 and revision 3

The table below provides a detailed mapping between revision 2 and revision 3 of IACS UR E22 and which of the defined roles that are impacted by the changes.

<b>IACS UR E22 Rev. 3 (paragraph and name)</b>		<b>Rev. 2 (paragraph)</b>	<b>Summary of changes</b>	<b>Reason for change</b>	<b>System supplier</b>	<b>Systems integrator</b>	<b>Owner</b>
General	Document structure	Document structure	Changed: Restructured the document to clarify the requirements on the different roles and to make the use of chapters and headings consistent	Improvement. To clarify the content and improve readability	X	X	X
General	Title	Title	Changed: new title: Computer-based systems	Improvement. To better reflect the scope and content of the UR	---	---	---
General	Class Societies verification activities	Class Societies verification activities	Changed and added: For each of the requirements, it is specified how the class society is going to follow-up the requirement	Clarification of the class society's verification activities	X	X	X
1.1	Scope	1.1	Equivalent	---	---	---	---



<b>IACS UR E22 Rev. 3 (paragraph and name)</b>		<b>Rev. 2 (paragraph)</b>	<b>Summary of changes</b>	<b>Reason for change</b>	<b>System supplier</b>	<b>Systems integrator</b>	<b>Owner</b>
1.2	Exclusion	1.2	Rewritten, but equivalent	A more general formulation is applied to potentially cover systems not explicitly mentioned	---	---	---
1.3.1	Normative standards	New	Added: UR E10, E26, E27	Improvement. To clarify which standards are mandatory and which are voluntary to follow	X	---	---
1.3.2	Informative standards	1.3	Added: ISO 90007 and ISO 24060	Improvement. To make the reference list consistent with the content of the rest of the document	X	X	---
1.4	Structure	New	Added: a description of the structure of E22	Improvement. To describe the structure of the E22	---	---	---
1.5.1	Abbreviations	New	Added: table with abbreviations	Improvement, it is normal to define abbreviations used in a document	---	---	---

<b>IACS UR E22 Rev. 3 (paragraph and name)</b>		<b>Rev. 2 (paragraph)</b>	<b>Summary of changes</b>	<b>Reason for change</b>	<b>System supplier</b>	<b>Systems integrator</b>	<b>Owner</b>
1.5.2	Terminology	2 (except for 2.3)	<p>Changed: owner, supplier, system, and systems integrator</p> <p>Added: 12 items</p> <p>Deleted: software module</p>	<ul style="list-style-type: none"> <li>- The system category definitions have been moved to a separate chapter in order to describe the context and examples better.</li> <li>- Owner, supplier and systems integrator definitions are shortened because all actual requirements on these roles are described elsewhere in the UR</li> <li>- Some terms are added because they are used in the more detailed descriptions of the requirements.</li> </ul>	X	X	X

<b>IACS UR E22 Rev. 3 (paragraph and name)</b>		<b>Rev. 2 (paragraph)</b>	<b>Summary of changes</b>	<b>Reason for change</b>	<b>System supplier</b>	<b>Systems integrator</b>	<b>Owner</b>
2.1	System certification	3.1.4	Rewritten, equivalent	A clear definition of that is needed for a ship-specific certification is described. The old text in 3.1.4 has been rewritten because it contained some strange formulations. The description has been moved to a separate paragraph (2) where it is put in context with the type approval of computer-based systems	X	X	---

<b>IACS UR E22 Rev. 3 (paragraph and name)</b>		<b>Rev. 2 (paragraph)</b>	<b>Summary of changes</b>	<b>Reason for change</b>	<b>System supplier</b>	<b>Systems integrator</b>	<b>Owner</b>
2.2	Type approval	3.1.4	Rewritten, but largely equivalent to current practice. The concept of "limited approval", described in old paragraph 3.2 has been removed because it was not being used.	A clear definition of that is needed for a type approval is described. The old text in 3.1.4 has been expanded upon in order to better define the concept of type approval. The description has been moved to a separate paragraph (2) where it is put in context with the ship-specific certification	X	---	---
3.1	System category definitions	2.3, Table 1	Category III now also includes systems which failure may lead to catastrophic situations. Slightly rephrased "typical system functionality"	Clarification about the importance of category III systems	X	X	X

<b>IACS UR E22 Rev. 3 (paragraph and name)</b>		<b>Rev. 2 (paragraph)</b>	<b>Summary of changes</b>	<b>Reason for change</b>	<b>System supplier</b>	<b>Systems integrator</b>	<b>Owner</b>
3.2	Class Societies' scope	NEW	Added: how to deal with category I systems	To clarify the Class societies' scope	X	X	X
3.3	System category examples	2.3, below Table 1	Changed: from typical ones to examples always to be evaluated in the context of a specific vessel Added: examples of category I systems	Categorization of systems may vary for each ship	X	X	X
4.1.1	Life cycle approach with appropriate standards	3.1	Clarification that hardware is also a part of a system.	Clarification	X	X	X
4.1.2 para 1	Quality system	3.1.1 para 1	Rewritten and amended. Added: information about the different expectations on the quality system of a systems integrator and a system supplier	Clarifications on the expected content of the quality system. Clearer connection between the requirements on the quality system and the detailed requirements in the UR	---	---	---

<b>IACS UR E22 Rev. 3 (paragraph and name)</b>		<b>Rev. 2 (paragraph)</b>	<b>Summary of changes</b>	<b>Reason for change</b>	<b>System supplier</b>	<b>Systems integrator</b>	<b>Owner</b>
4.1.2 para 2	Quality system	New	Added: Information that this is only valid for category II and III.	Clearer connection between the requirements on the quality system and the detailed requirements in the UR			
para 2 and Table 4	#1	3.1.1.1	Changed: indicated it is required for supplier and systems integrator	clarification	X	X	---
	#2	New	Added: complete life cycle	Consistency with detailed requirements in the UR	X	X	---
	#3	New	Added: procedures for unique identification	Consistency with detailed requirements in the UR	X	---	---
	#4	New	Added: system architecture	Consistency with detailed requirements in the UR	---	X	---

<b>IACS UR E22 Rev. 3 (paragraph and name)</b>		<b>Rev. 2 (paragraph)</b>	<b>Summary of changes</b>	<b>Reason for change</b>	<b>System supplier</b>	<b>Systems integrator</b>	<b>Owner</b>
	#5	3.1.1.2 1st bullet	Changed: indicated it is required for supplier and systems integrator	clarification	X	X	---
	#6	3.1.1.2 2nd bullet	changed: indicated it is required for supplier	clarification	X	---	---
	#7	3.1.1.2 3rd bullet	changed: indicated it is required for supplier	clarification	X	---	---
	#8	New	added: procedures for FAT and SAT	Consistency with detailed requirements in the UR	X	X	---
	#9	3.1.1.1	changed: indicated it is required for supplier	clarification	X	---	---
	#10	3.1.1.3 3rd bullet	added: yard changed: indicated it is required for supplier and systems integrator	Consistency with detailed requirements in the UR	X	X	---

<b>IACS UR E22 Rev. 3 (paragraph and name)</b>		<b>Rev. 2 (paragraph)</b>	<b>Summary of changes</b>	<b>Reason for change</b>	<b>System supplier</b>	<b>Systems integrator</b>	<b>Owner</b>
	#11	3.1.1.3 1st bullet	changed: indicated it is required for supplier	clarification	X	---	---
	#12	same to the above	Changed: indicated it is required for supplier and systems integrator	clarification	X	X	---
	#13	3.1.1.1	changed: indicated it is required for supplier	clarification	X	---	---
	#14	same to the above	changed: indicated it is required for supplier and systems integrator	clarification	X	X	---
	#15	3.1.1.3 2nd bullet	changed: indicated it is required for supplier and systems integrator	clarification	X	X	---
below Table 4	---	3.1.1 para 2	equivalent	---	---	---	---
(supplier) 4.2.1	Define and follow a quality plan	3.1.1.4	Rewritten, but equivalent. Split into 4.2.1 and 4.3.2	clarification	X	---	---



<b>IACS UR E22 Rev. 3 (paragraph and name)</b>		<b>Rev. 2 (paragraph)</b>	<b>Summary of changes</b>	<b>Reason for change</b>	<b>System supplier</b>	<b>Systems integrator</b>	<b>Owner</b>
4.2.2	Unique identification of systems and software	New	Added: method for unique identification of systems and software	This is a foundation needed for good management of change	X	---	---
4.2.3	System description	3.1.3 documentation	Changed: The requirement to describe the system has been moved to a separate paragraph equivalent	To clarify the requirements on system documentation	X	---	---
4.2.4	Environmental compliance of hardware components	4		---	---	---	---

<b>IACS UR E22 Rev. 3 (paragraph and name)</b>		<b>Rev. 2 (paragraph)</b>	<b>Summary of changes</b>	<b>Reason for change</b>	<b>System supplier</b>	<b>Systems integrator</b>	<b>Owner</b>
4.2.5	Software code creation, parameterization, and testing	3.1.1.2 2nd bullet	Changed: clarifications on the expected scope and extend of quality assurance of software code and parameters	As software is becoming a more and more critical and important part of systems, the quality assurance needs to follow suit. Quality assurance of individual software components before they are integrated into a larger system is considered a good practice	X	---	---
4.2.6	Internal system testing before FAT	3.1.1.2 3rd bullet	Changed: clarifications on the expected scope and extend of quality assurance of by the system supplier on the system	There is a need to verify as much as possible of the system before it is being installed onboard.	X	---	---

<b>IACS UR E22 Rev. 3 (paragraph and name)</b>		<b>Rev. 2 (paragraph)</b>	<b>Summary of changes</b>	<b>Reason for change</b>	<b>System supplier</b>	<b>Systems integrator</b>	<b>Owner</b>
4.2.7	Factory acceptance testing (FAT) before installation on board	3.1.3	Rewritten, but largely equivalent: clarifications on the expected scope and extend of the FAT	There was a need to position the FAT related to the internal system test and the system acceptance test	X	---	---
4.2.8	Secure and controlled software installation on the vessel	New	Added: requirement for the supplier and system's integrator to agree on a "management of change" procedure for onboard installations	Increased focus on the management of change for systems and software	X	X	---
(integrator) 4.3.1	Responsibilities	beginning of 2.1.2	Equivalent	---	---	---	---
4.3.2	Define and follow a quality plan	3.1.1.4	Rewritten, but equivalent: clarified that the systems integrator shall have a quality plan	clarification	---	X	---

<b>IACS UR E22 Rev. 3 (paragraph and name)</b>		<b>Rev. 2 (paragraph)</b>	<b>Summary of changes</b>	<b>Reason for change</b>	<b>System supplier</b>	<b>Systems integrator</b>	<b>Owner</b>
4.3.3	Determining the category of the system in question	New	Added: explicitly decide the category of a system in the context of the specific vessel in question	The category must be decided in the context of the vessel where the system is being installed	---	X	---
4.3.4	Risk assessment of the system	3.1.2.1 1st half	Added: Risk assessment is only required if requested by the class society. Rewritten, but equivalent when requested	Clarification that risk assessment is not always needed	---	X	---
4.3.5	Define the vessel's system-architecture	New	Added: system architecture	Needed in order for the systems integrator to be able to plan, prepare and execute the testing of integrated systems on vessel-level. It also gives the systems integrator a clearer role in the design of the system of systems	---	X	---

<b>IACS UR E22 Rev. 3 (paragraph and name)</b>		<b>Rev. 2 (paragraph)</b>	<b>Summary of changes</b>	<b>Reason for change</b>	<b>System supplier</b>	<b>Systems integrator</b>	<b>Owner</b>
4.3.6	System acceptance test (SAT) onboard the vessel	3.1.5	Rewritten, but equivalent: clarified the expectations on the system acceptance test	Aligning the system acceptance test with the FAT and the testing of integrated systems on vessel level	---	X	---
4.3.7	Testing of integrated systems on vessel-level (SOST)	New	Added: The systems integrator is responsible for performing a test of the integrated system of systems onboard the vessel	To ensure that the integrated systems are verified to work together, and to strengthen the role of the systems integrator	---	X	---
4.3.8	Change management	3.3.1	Rewritten, but largely equivalent: The responsibilities of the systems integrator have been mapped to the requirements in the new chapter on management of change	More focus on the management of change process to secure that changes are being managed in a good way	---	X	---

<b>IACS UR E22 Rev. 3 (paragraph and name)</b>		<b>Rev. 2 (paragraph)</b>	<b>Summary of changes</b>	<b>Reason for change</b>	<b>System supplier</b>	<b>Systems integrator</b>	<b>Owner</b>
(Owner) 5.1.1	Responsibilities	3.3.1	Rewritten, but largely equivalent: The owner is considered the systems integrator during operations if the role is not explicitly delegated	More focus on the management of change process in order to secure that changes are being managed in a good way	---	X	X
(Integrator) 5.2.1	Change management	3.3.1	Rewritten, but largely equivalent: The responsibilities of the systems integrator have been mapped to the requirements in the new chapter on management of change	More focus on the management of change process in order to secure that changes are being managed in a good way	---	X	---

<b>IACS UR E22 Rev. 3 (paragraph and name)</b>		<b>Rev. 2 (paragraph)</b>	<b>Summary of changes</b>	<b>Reason for change</b>	<b>System supplier</b>	<b>Systems integrator</b>	<b>Owner</b>
(Supplier) 5.3.1	Change management	New	Added: The responsibilities of the system supplier have been mapped to the requirements in the new chapter on management of change	More focus on the management of change process in order to secure that changes are being managed in a good way	X	---	---
5.3.2	Testing of changes before installation onboard	New	Added: requirement on the system supplier to perform inhouse tests of changes to a system before it is installed onboard	More focus on the management of change process to secure that changes are being managed in a good way	X	---	---
6	MANAGEMENT OF CHANGE	New / 3.3.2	Expanded and added: 11 requirements on different parts of the management of change process are added	More focus on the management of change process to secure that changes are being managed in a good way	X	X	X

<b>IACS UR E22 Rev. 3 (paragraph and name)</b>		<b>Rev. 2 (paragraph)</b>	<b>Summary of changes</b>	<b>Reason for change</b>	<b>System supplier</b>	<b>Systems integrator</b>	<b>Owner</b>
7 (para 1)	TECHNICAL REQUIREMENTS ON COMPUTER- BASED SYSTEMS	New / 5	restructured: The old paragraph 5 has been incorporated into a more generic paragraph which groups all technical requirements in the UR added: compliance to requirements to be documented and verified	Clarification	X	X	---
7.1.1	System identification	New	added: means to identify system and software. Recommendation to follow ISO 24060	This is a foundation needed for good management of change	X	---	---
7.2	Data links	5	Minor changes, see below	---	---	---	---
7.2.1 (para 1)	General requirements for category II and III systems	5.1.1	Equivalent: Loss of data link shall be part of a risk analysis/FMEA	---	---	---	---



<b>IACS UR E22 Rev. 3 (paragraph and name)</b>		<b>Rev. 2 (paragraph)</b>	<b>Summary of changes</b>	<b>Reason for change</b>	<b>System supplier</b>	<b>Systems integrator</b>	<b>Owner</b>
7.2.1 1	---	5.1.2	Changed: proper working to fail-to-safe and compensation Rewritten: split into two	It is not always possible to restore functionality as the previous version required	X	---	---
7.2.1 2	---	5.1.2 para 2	Changed: loss of remote control functionality shall be compensated for by local/manual control	It is not always possible to maintain functionality as the previous version required	X	---	---
7.2.1 3	---	5.1.3	equivalent	---	---	---	---
7.2.1 4	---	5.1.4 para 1	added: "or performance issues"	Data-link performance issues may influence the functionality negatively long before there is a 'failure' of the link	X	---	---
7.2.1 5	---	5.1.4 para 2	equivalent	---	---	---	---
7.2.2 1	Specific requirements for wireless data links	5.2.1	equivalent	---	---	---	---
just above 7.2.2 2	---	5.2.2	equivalent	---	---	---	---

<b>IACS UR E22 Rev. 3 (paragraph and name)</b>		<b>Rev. 2 (paragraph)</b>	<b>Summary of changes</b>	<b>Reason for change</b>	<b>System supplier</b>	<b>Systems integrator</b>	<b>Owner</b>
7.2.2 2	---	5.2.2.1	equivalent	---	---	---	---
7.2.2 3	---	5.2.2.2 para 1	equivalent	---	---	---	---
7.2.2 4	---	5.2.2.2 para 2	equivalent	---	---	---	---
7.2.2 5	---	5.2.2.3	equivalent	---	---	---	---
7.3	Verification of technical requirements by the Class Society	New	added: to be verified at designing, FAT and SAT	clarification	X	X	---
Annex A Table 5	Summary of documentation submitted by the supplier	Annex	Rewritten: the annex is split into three parts and inconsistencies corrected. The Annexes only summarizes requirements described elsewhere; no requirements are added here	clarification	X	---	---

<b>IACS UR E22 Rev. 3 (paragraph and name)</b>		<b>Rev. 2 (paragraph)</b>	<b>Summary of changes</b>	<b>Reason for change</b>	<b>System supplier</b>	<b>Systems integrator</b>	<b>Owner</b>
Annex A Table 6	Summary of documentation submitted by the systems integrator	Annex	Rewritten: the annex is split into three parts and inconsistencies corrected. The Annexes only summarizes requirements described elsewhere; no requirements are added here	clarification	---	X	---
Annex B Table 7	Summary of test witnessing and survey	Annex	Rewritten: the annex is split into three parts and inconsistencies corrected. The Annexes only summarizes requirements described elsewhere; no requirements are added here	clarification	X	X	---

**6. Attachments if any**

None.

# Technical Background (internal)

## UR E23 (NEW Feb 2007)

### *UR for the choice of circuit breakers (PM5405)*

#### **Objective and scope:**

To develop unified requirements for selection of low voltage circuit breakers with relation to point of installation, services fed, and short circuit conditions.

#### **Source of proposed requirements:**

The proposed requirements have been based on the present Rule requirements of IACS members and IEC Standard 60947 Low-voltage switchgear and controlgear.

#### **Background:**

As a consequence of feedback from switchboard makers indicating confusion about selection of circuit breakers due to different practise from the different societies, IACS established a project team with the aim to establish unified requirements for selection of low voltage circuit breakers restricted to consideration of short-circuit capacity and co-ordination in service. Other factors, i.e. environmental testing, location and construction of enclosures, are not covered here.

#### **Content:**

Based on definitions and test methods for breaker data laid down in IEC 60947, the UR establish requirement for choice of low voltage circuit breakers short-circuit capacity and co-ordination in service ensuring the safety and reliability of the electrical installation with a clear description of how breaker data should be evaluated for specific distribution systems on board ships.

#### **Points of discussion:**

The Project Team proposed to base requirements to breaking capacity on the short circuit current's value at the instant of contact separation, in line with IEC 61363 section 9.2 b). However, after discussions in the Machinery Panel, it has been decided to base the requirements to breaking capacity on the short circuit current's value after the first half cycle ( $t = T/2$ ) in order to keep today's practise, and in order to make the societies' verification more simple.

No decisions have been based on voting.

*Submitted by Machinery Panel Chair  
20 December 2006*

#### **Discussion at GPG level:**

RINA in 6214\_RIa suggested to replace the word 'after' with 'at', although only one member (DNV) supported this proposal at the first round discussion, considering the importance and it being a specific technical comment, GPG Chairman tasked the Machinery Panel to consider it. The Machinery Panel reported that they had no objections to replacing the word 'after' with 'at' in sections 3 and 4 of the new UR. CCS and RS only agreed this proposal to be taken in section 3 (excluding section 4). Further CCS and RINA provided more detailed technical comments to back their views respectively. As those

messages were received at late stage, unfortunately no other members' comments were available before the deadline.

Since those discussions between RINA and CCS are related to specific technical matter which is not appropriated to be discussed at GPG level, and CCS suggested to seek the opinions of the major circuit breakers manufacturers about the proposed changes to the draft UR (section 4) by RINA to make sure that there is no difficulty in the implementation of the UR, while RINA had no objection on this suggestion and RS supported it, in addition, RS suggested that Machinery Panel should be tasked to seek the opinions of manufacturers. In order to implement this new UR E23 unanimously, GPG Chairman suggested that Machinery Panel be tasked to select the major circuit breakers manufacturers to seek their opinions on this matter, and feedback the result as early as possible, so further rectified action may be taken if necessary.

All members agreed to extend the implementation date on 1st of July 2008 suggested by LR.

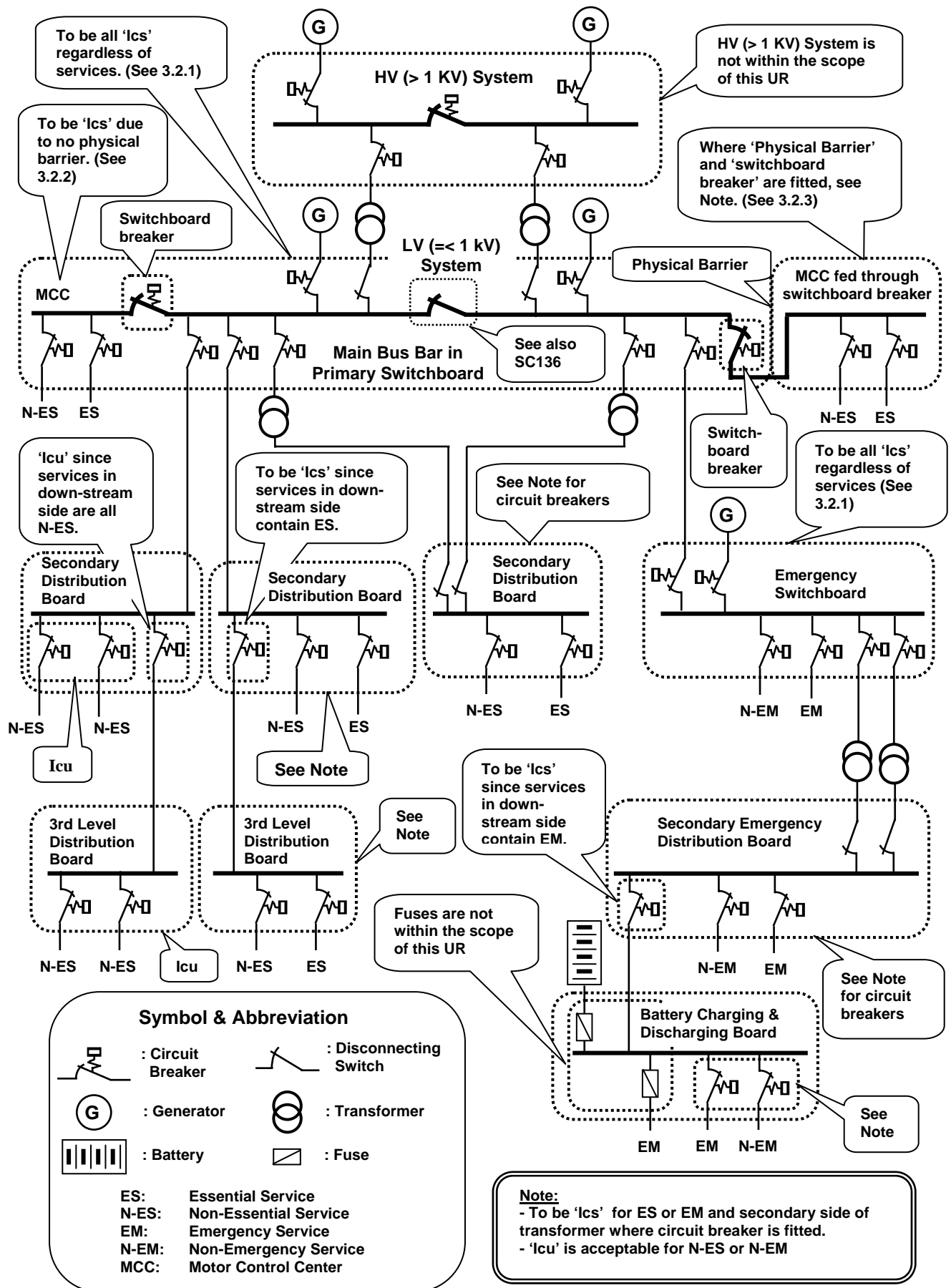
-----

## ***Appendix A:***

### **Supporting guidance for the application of IACS UR E23**

1. For definition of terms used in this UR, refer to IEC 60092 and IEC 60947.
2. Figure 1 below shows an example of the application of Clause 3 of UR E23 to a power distribution system.
3. Figure 2 below shows continuity of supply and continuity of service as referred to in Clauses 5 and 6 of UR E23.

**Figure 1**  
**Example of Power Distribution System and Requirements for 'Icu' or 'Ics'**



**Symbol & Abbreviation**

	: Circuit Breaker		: Disconnecting Switch
	: Generator		: Transformer
	: Battery		: Fuse

ES: Essential Service  
 N-ES: Non-Essential Service  
 EM: Emergency Service  
 N-EM: Non-Emergency Service  
 MCC: Motor Control Center

**Note:**  
 - To be 'Ics' for ES or EM and secondary side of transformer where circuit breaker is fitted.  
 - 'Icu' is acceptable for N-ES or N-EM

**Figure 2:  
Continuity of Supply & Continuity of Service**

	Before a fault	During a fault	After a fault
<b>Continuity of Supply</b>			
<b>Continuity of Service</b>			
<p><b>Definition for the above figures:</b></p> <p>(a) The continuity of supply is the condition for which during and after fault in a circuit, the supply to the healthy circuits (see circuit 3 the above figure) is permanently ensured.</p> <p>(b) The continuity of service is the condition for which after a fault circuit has been cleared, the supply to the healthy circuits (see circuit 3 in the above figure) is automatically re-established.</p>			

# Technical Background (external)

## UR E23 (NEW Feb 2007)

### *UR for the choice of circuit breakers (PM5405)*

#### **Objective and scope:**

To develop unified requirements for selection of low voltage circuit breakers with relation to point of installation, services fed, and short circuit conditions.

#### **Source of proposed requirements:**

The proposed requirements have been based on the present Rule requirements of IACS members and IEC Standard 60947 Low-voltage switchgear and controlgear.

#### **Background:**

As a consequence of feedback from switchboard makers indicating confusion about selection of circuit breakers due to different practise from the different societies, IACS established a project team with the aim to establish unified requirements for selection of low voltage circuit breakers restricted to consideration of short-circuit capacity and co-ordination in service. Other factors, i.e. environmental testing, location and construction of enclosures, are not covered here.

#### **Content:**

Based on definitions and test methods for breaker data laid down in IEC 60947, the UR establish requirement for choice of low voltage circuit breakers short-circuit capacity and co-ordination in service ensuring the safety and reliability of the electrical installation with a clear description of how breaker data should be evaluated for specific distribution systems on board ships.

*Submitted by Machinery Panel Chair  
20 December 2006*

-----

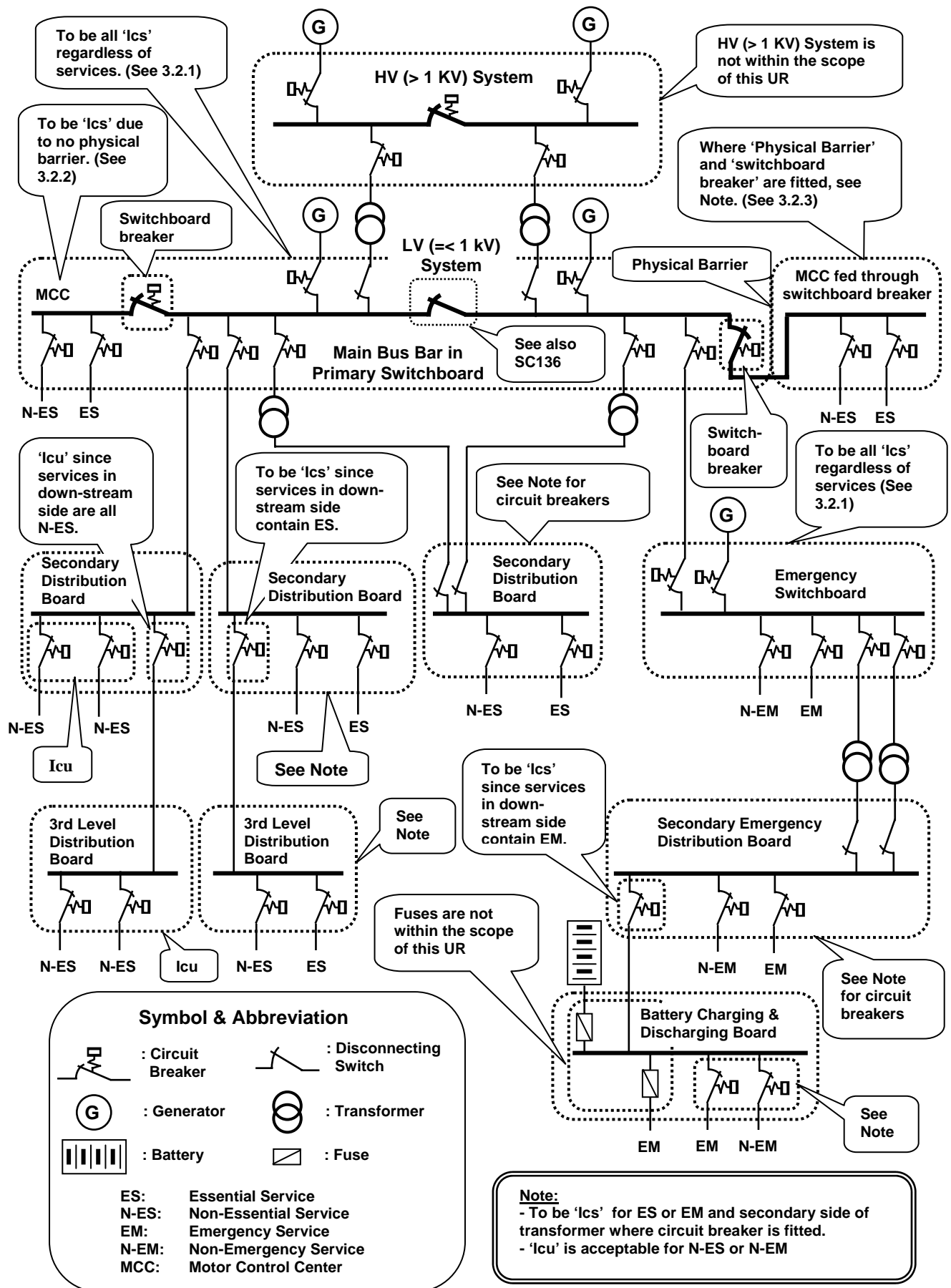
#### **Appendix A:**

##### **Supporting guidance for the application of IACS UR E23**

1. For definition of terms used in this UR, refer to IEC 60092 and IEC 60947.
2. Figure 1 below shows an example of the application of Clause 3 of UR E23 to a power distribution system.
3. Figure 2 below shows continuity of supply and continuity of service as referred to in Clauses 5 and 6 of UR E23.



**Figure 1**  
**Example of Power Distribution System and Requirements for 'Icu' or 'Ics'**



**Symbol & Abbreviation**

	: Circuit Breaker		: Disconnecting Switch
	: Generator		: Transformer
	: Battery		: Fuse

ES: Essential Service  
 N-ES: Non-Essential Service  
 EM: Emergency Service  
 N-EM: Non-Emergency Service  
 MCC: Motor Control Center

**Note:**  
 - To be 'Ics' for ES or EM and secondary side of transformer where circuit breaker is fitted.  
 - 'Icu' is acceptable for N-ES or N-EM

**Figure 2:  
Continuity of Supply & Continuity of Service**

	Before a fault	During a fault	After a fault
<b>Continuity of Supply</b>			
<b>Continuity of Service</b>			
<p><b>Definition for the above figures:</b></p> <p>(a) The continuity of supply is the condition for which during and after fault in a circuit, the supply to the healthy circuits (see circuit 3 the above figure) is permanently ensured.</p> <p>(b) The continuity of service is the condition for which after a fault circuit has been cleared, the supply to the healthy circuits (see circuit 3 in the above figure) is automatically re-established.</p>			

## Technical Background for UR E23 Delete, Mar 2011

Machinery panel reported to GPG70 that:

Panel had been tasked to review the UR E23 (Subject Number: PM5405 (6214a)) which had been withdrawn by IACS following the negative feedback from the industry. The Panel has since been trying to gather evidence from members' experience, which will help in justifying the need to review the UR further or may be for re-issuing it. However gathering evidence was proving difficult because once the fire had been extinguished, it was too difficult to find out whether the fire was initiated by the circuit breakers or not. Due to the lack of evidence the Panel decided to permanently delete UR E23. After agreement in GPG the Permanent Secretariat is kindly requested to publish/update the UR E23 from withdrawn to deleted.

On receiving the machinery panel report (10158bPMa), PermSec updated the status of UR E23 to 'Deleted'.

IACS PermSec  
19 May 2011

## UR E24 “Harmonic Distortion for Ship Electrical Distribution System including Harmonic Filters”

### Summary

This UR provides requirements for the monitoring of the harmonic distortion levels and the mitigation of the effects of harmonic filter failure.

### Part A. Revision History

Version no.	Approval date	Implementation date when applicable
Rev.1 (Dec 2018)	17 December 2018	1 January 2020
New (June 2016)	2 June 2016	1 July 2017

- **Rev 1 (Nov 2018)**

.1 Origin of Change:

- Suggestion by IACS member

.2 Main Reason for Change:

To introduce the scope of application of the current UR E24 in order to clarify that the requirements are applicable only to ships where harmonic filters are installed onboard. To compare the total harmonic distortion limits of current UR with those of international standards to verify if an update is necessary.

.3 List of non-IACS Member Classification Societies contributing through the TC Forum and/or participating in IACS Working Group:

None

.4 History of Decisions Made:

The matter was offered by a Machinery Panel Member and discussed at 27<sup>th</sup> Machinery Panel Meeting (27 Feb to 02 March 2018) and agreed by correspondence.

.5 Other Resolutions Changes

None

.6 Dates:

Original Proposal: February 2018  
 Panel Approval: 28 November 2018 (Ref:PM18908\_IMg)  
 GPG Approval: 17 December 2018 (Ref:18141\_IGe)

## New (June 2016)

### .1 Origin for Change:

- Other (Recommendation by MAIB)

### .2 Main Reason for Change:

Recommendation was made to introduce requirements for survey of harmonic filters and harmonic distortion levels by an MAIB investigation following the catastrophic failure of a harmonic filter installed on board a UK flag passenger vessel.

### .3 List of non-IACS Member Classification Societies contributing through the TC Forum and/or participating in IACS Working Group:

None

### .4 History of Decisions Made:

The Machinery Panel commented on proposed draft by correspondence and at regularly scheduled meetings. In the process of development, the draft UR approved by Machinery Panel was sent to Survey Panel for review and concurrence on the survey requirements in Section 2.

The form A was approved 05 October 2012.

### .5 Other Resolutions Changes

None

### .6 Dates:

Original Proposal: 2 March 2012 Made by a Member  
Panel Approval: 1 April 2016 (Ref: PM12405)  
GPG Approval: 2 June 2016 (Ref: 12165\_IGd)

## Part B. Technical Background

List of Technical Background (TB) documents for UR E24:

Annex 1. TB for New (June 2016)

See separate TB document in Annex 1.

Annex 2. TB for New (Dec 2018)

See separate TB document in Annex 2.



## Technical Background (TB) document for UR E24 (New June 2016)

### 1. Scope and objectives

In September 2010, while approaching Barcelona, the UK flag cruise vessel RMS Queen Mary 2 experienced a catastrophic failure of a harmonic filter installed as part of the high voltage electrical distribution system. This failure resulted in a blackout of the vessel. No one was injured and the vessel was able to resume passage following isolation of the harmonic filter and part of the main switchboard.

The subsequent investigation carried out by the Marine Accident Investigation Branch (MAIB) concluded that the failure occurred following deterioration over time of the capacitors within the harmonic filter.

In order to reduce the risk of a similar failure occurring in the future the report recommended that harmonic distortion levels on board vessels should be monitored in order to detect any deterioration of harmonic mitigation equipment at an early stage. The report further recommended that guidance should be available to ship's personnel to enable the operation of the ship while maintaining an acceptable level of harmonic distortion following degradation or failure of harmonic mitigation equipment.

The root cause of the failure that occurred on the Queen Mary 2 was not identified.

The intent of this Unified Requirement is to:

- Address the MAIB recommendations.
- Consider the need to require online monitoring of harmonic distortion.
- To mitigate against the issues of harmonic filter failure.

### 2. Engineering background for technical basis and rationale

#### **QM2 catastrophic failure of harmonic filter: MAIB Recommendations**

Improve the standards of protection that are required against harmonic distortion and component failure in vessels operating high voltage networks, to provide:

- a requirement in all new-build vessels that may be affected by harmonic distortion of current and voltage that:
  - In the event that all harmonic mitigation systems fail, information is provided on board to describe the maximum extent of harmonic distortion that can be expected.
  - Guidance is provided so that crew can take effective action to keep power and propulsion equipment operating (at an appropriate power output) if harmonic mitigation equipment degrades or fails.
  - On-line monitoring of harmonic distortion of voltage is required for new build vessels and, for existing vessels, there is periodic monitoring to detect change or degradation of harmonic distortion levels.
  - Specific requirements are developed to detect and mitigate against the failure of high-energy storage devices such as capacitors.

Review the requirements for the enclosure of high voltage systems to confirm that the degree of protection is consistent for all equipment where crew intervention could be required and the hazard from arc-flash exists.

Introduce a specific requirement specifying that where the failure of equipment or machinery may lead to serious damage to the vessel, or injury to personnel, its protection system is to be of a 'fail safe' type.

### 3. Source/derivation of the proposed IACS Resolution

The root cause of the QM2 harmonic filter failure catastrophe was not identified and therefore requirements were developed through IACS Machinery Panel discussion and required a panel majority for a Resolution to become realised. Requirements have been derived from the following sources:

- MAIB Report 28/2011 December 2011 – “Report on the investigation of the catastrophic failure of a capacitor in the aft harmonic filter room on board RMS Queen Mary 2 while approaching Barcelona 23 September 2010”.
- IEC60092-501: Special features – Electric propulsion plant, date: 22<sup>th</sup> October 2013.
- IACS Unified Requirements.
- Member classification society’s Rules.

### 4. Summary of Changes intended for the revised Resolution:

N/A

### 5. Points of discussions or possible discussions

Paragraph	Summarised comments from industry and other IACS Members
General comments	
	<p>C. The requirement for arc flash hazard calculations as part of the UR had been proposed.</p> <p>A. There is no substantial evidence that arc flash was the cause for the Queen Mary II incident, and any arc flash hazards should be more generally applied rather than for this specific case.</p>
Specific comments	
Section 1	<p>C. Concern that problems may occur regarding the application of the UR because Total Harmonic Distortion (THD) limits are different among each society. Therefore, it was proposed that it is necessary to specify THD limits in the UR.</p> <p>A. The 8% limit is used because it does not have any conflict with power quality in UR E5 as it only covers voltage and frequency.</p> <p>The UR makes exceptions to this limit in cases where all installed equipment and systems have been designed for higher THD levels.</p>



	<p>"harmonic distortion calculation report" was used to prove the system is designed to operate at higher THD levels, but validation testing is required.</p> <p>The 8% THD limit is already stated in member classification society's rules.</p>
Section 2	<p>C. What frequency should the harmonic distortion levels be measured on existing ships?</p> <p>A. Considering the specialist equipment and access to interiors of switchboards that may be required to perform the measurements on existing installations where the monitoring system is not provided, for high voltage installations in particular, it is impractical to require harmonic distortion measurements to be made more frequently than annually.</p>
	<p>C. It has been clarified that the guidance documentation produced should include permitted modes of operation following any combination of harmonic filter failures. It has further been clarified that the validity of the guidance documentation is to be verified by testing during sea trials.</p> <p>A. Reference to propulsion has not been made as harmonic filters may be included in systems containing other large electrical consumers, or even large numbers of small consumers fed by frequency converting equipment.</p> <p>It should be noted that full verification of the calculation or practical testing of the effect of failure could result in inducing high levels of harmonic distortion onto the system, albeit for a short period of time during testing, which should ideally be avoided. It is therefore proposed that the calculation should be carried out and then verified by testing up to a point where the harmonic distortion levels observed are moving beyond certain limits. The current wording leaves it to the interpretation of the individual classification society as to exactly how far the verification of the calculation by testing will need to be carried out.</p>
	<p>C. Should the UR be applied only for the ships which have the potential risks of harmonic distortion failure, such as electric propulsion ships having high capacity power electronics. Because, considering the experience that vessels complying with current Class requirements of 6-8% THD without the harmonic filters, a catastrophic failure does not happen. .</p> <p>A. Problems with harmonics on low voltage high powered vessels have been experienced, and therefore members proposed that the UR should not be restricted to high voltage filters but the same requirements applicable to low voltage ones too.</p> <p>Recently industry has seen increased numbers of variable speed drives connected to LV services, and consequently use of harmonic filters will increase.</p>
	<p>C. Should the UR require "Continuously monitor the levels of harmonic distortion" or would an "annual testing" be sufficient.</p>

	<p><u>A. New building ships</u></p> <p>The UR should require the harmonic distortion to be continuously monitored as it will provide early warning and also fault finding capabilities in event of a failure. Additionally following a failure or loss of equipment on board, the effect on harmonics can be immediately determined.</p> <p><u>B. Existing ships</u></p> <p>An annual testing of harmonic distortion level would be sufficient for monitoring of harmonic distortion on board.</p> <p>Assuming that the filter has been designed properly and its operation been verified during initial testing, and a failure in the harmonic filter is alarmed by its protection, then <u>annual testing should suffice.</u></p>
	<p>C. A suggestion to add in the Note that the UR also applies to new harmonic filters fitted to existing ships</p> <p>A. The phrase "Where the electrical distribution system on board a ship includes harmonic filters," is understood to cover new harmonic filters fitted to existing ships. Therefore, an additional note is not necessary.</p>
Section 3	<p>C. It is not acceptable determining the effect of a failure of a harmonic filter on the level of harmonic distortion on the basis of a calculation.</p> <p>A. Calculations are to be verified by tests during sea trials. However, it should be noted that full verification of the calculation or practical testing of the effect of failure could result in inducing high levels of harmonic distortion onto the system, albeit for a short period of time during testing, which should ideally be avoided. It is therefore proposed that the calculation should be carried out and then verified by testing up to a point where the harmonic distortion levels observed are moving beyond certain limits. The current wording leaves it to the interpretation of the individual classification society as to exactly how far the verification of the calculation by testing will need to be carried out.</p>
Section 4	<p>C. The explosion may have been a result of pressure build up within the hermetically sealed capacitors. A member proposed a requirement for pressure relief valves to be fitted on capacitors over 2 litres. Justification of the 2 litres threshold was requested.</p> <p>A. Based on the recommendation received from an independent Electrical and Electronic Manufacturer, the proposal for relief valves or overpressure disconnectors were rephrased. The wording also considers alternative cell protection technologies.</p>
Paragraph	Comments received from the Survey Panel
Section 2	Comment 1: for E.R. provided with automation systems (unmanned machinery spaces) the alert for level of harmonic distortion outside of acceptable limits should be recorded by the system together with that one for activation of the protection of a harmonic filter circuit (Exx4).

	Review of print out of automation system to be carried out at annual survey. For ship not fitted with automation system official records should be logged in the engine log book. Records shall be available to the surveyor.
Section 2	Comment 2: It should be specified that the annual measurement should be carried out close to the annual machinery survey.
Section 2	Comment 3: Acceptable limit should be clearly documented (harmonic distortion calculation report) based on system design calculation and/or trial; availability on board to be checked at annual survey. The operating conditions under which the test are to be clearly stated – with/without filters, all equipment running, etc.
Section 2	Comment 4: It would be better to specify that measurements are to be carried out with the filters connected to the net. The operating conditions under which the measurements are to be carried out needs to be clearly stated: e.g. with/without filters, all equipment running, etc.
Section 2	Comment 5: the seagoing conditions should also specify that the conditions should be those where the harmonic level is the higher.
Section 2	Comment 6: that the responsible party for Harmonic distortion levels measurements needs to be clarified: crews or authorized person of manufacture?
Section 3	Comment 7: it is proposed to add "by class surveyor" after word "verified".

## 6. Attachments if any

None

## Technical Background (TB) document for UR E24 (Rev.1 Dec 2018)

### 1 Scope and objectives

To introduce the scope of application of the current UR E24 in order to clarify that the requirements are applicable only to ships where harmonic filters are installed onboard.

To compare the total harmonic distortion (THD) limits of current UR with those of international standards to verify if an update is necessary.

### 2 Engineering background for technical basis and rationale

- The issue was triggered by an IACS Member having a reservation regarding the total harmonic distortion limits of the current UR E24 (June 2016).
- It was observed that the requirements of the current UR E24 (June 2016) may be misinterpreted as to be applicable to all the existing ships due to an absence of clear scope, even though the UR was developed to apply to ships where harmonic filters are installed onboard, as expressed in the title.
- It was also considered necessary to compare the total harmonic distortion limits required in the current UR E24 (June 2016) with those required by international standards (IEC60092-101 and IEC60092-501).

### 3 Source/derivation of the proposed IACS Resolution

None

### 4 Summary of Changes intended for the revised Resolution

- A new paragraph "1. **Scope**" was introduced and the existing paragraphs renumbered.
- In the existing paragraph 2.1 (renumbered as 3.1 in Rev.1) the first sentence "Where the electrical distribution system on board a ship includes harmonic filters, such" and the last sentence "However, harmonic filters installed for single application frequency drives such as pump motors may be excluded from these requirements, i.e. Sections 1 to 4." have been deleted as no more necessary given the clarifications in the new paragraph "1. **Scope**".
- The implementation statement has been updated

### 5 Points of discussions or possible discussions

The IACS Member having the reservation on the total harmonic distortion limits proposed to revise from 8% to 10% the THD limit specified in paragraph 1 "General" of the IACS UR E24 (June 2016) for the reason that the proposed value (i.e. 10%) correspond to that of the International Standard IEC 60092-501 "Electric Propulsion Plant"; the proposal was not accepted by the qualified majority of Machinery Panel Members.

As a compromise solution in order to solve the reservation the IACS Member propose to modify paragraph 1 "General" of the IACS UR E24 (June 2016) to read as follow:

"The total harmonic distortion (THD) of electrical distribution systems is not to exceed 8%. The THD value for the propulsion network not directly connected to the ship's network is not to exceed 10%.

Those limits may be exceeded where all installed equipment and systems have been designed for a higher specified limit and this relaxation on limits is documented (harmonic distortion calculation report) and made available on board as a reference for the surveyor at each periodical survey."

Also this compromise proposal was not accepted by the qualified majority of Machinery Panel Members sharing in general the opinion that the last part of the "General" paragraph already offers the possibility to derogate and accept a higher THD, when systems have been designed for this higher THD.

The IACS Member having the reservation also highlighted that the requirements of paragraph 2 in general and specifically those of sub-paragraph 2.2 of UR E24 (June 2016), the latter being provided for retrospective application to existing ships, are rather vague regarding the measurement procedure and proposed to establish a PT for the development of such procedures; the proposal was not accepted by the qualified majority of Machinery Panel Members.

**6 Attachments, if any**

None

## UR E25 “Failure detection and response of all types of steering control systems”

### Summary

Revision 2 of this UR adds an application statement as paragraph E25.1, deletes the item of “Hydraulic locking” from the failure list in paragraph E25.2.1 (renumbered) and provides amendment in paragraph E25.3.1 (renumbered) to clarify that the system response is not mandatory for mechanical failures.

### Part A. Revision History

Version no.	Approval date	Implementation date when applicable
Rev.2 (Mar 2022)	03 March 2022	1 July 2023
Rev.1 (Dec 2019)	7 December 2019	1 January 2021
New (June 2016)	21 June 2016	1 July 2017

**Note:** Added on 01 March 2023 (Ref: 22013\_IGm) Rev.2 of UR E25 was less stringent compared with Rev.1 because of deleting Hydraulic locking from list of failures in UR E25 Rev.1 and then accordingly Hydraulic locking removed from requirement of 2.1 in UR E25 Rev.1. Early implementation of UR E25 Rev.2 was agreed by GPG on case-by-case basis as per Par 2.1 of 22013\_IGh message dated 17 January 2023.

#### • Rev.2 (Mar 2022)

##### .1 Origin for Change:

- Suggestion by IACS Member

##### .2 Main Reason for Change:

To clarify that the system response is not mandatory for such as sticking valves, including hydraulic locking.

##### .3 List of non-IACS Member Classification Societies contributing through the TC Forum and/or participating in IACS Working Group:

None

##### .4 History of Decisions Made:

The Revision 2 was discussed by correspondence and agreed at the 34<sup>th</sup> Panel Meeting (from 31<sup>th</sup> August to 2<sup>th</sup> September 2021)

##### .5 Other Resolutions Changes

UR M42(Rev.6)

**.6 Any hinderance to MASS, including any other new technologies:**

None

**.7 Dates:**

Original Proposal : 11 May 2020 (Ref: PM20801\_IMa)  
Panel Approval : 20 January 2022 (Ref: PM20801\_IMI)  
GPG Approval : 03 March 2022 (Ref: 22013\_IGc)

• **Rev.1 (Dec 2019)**

**.1 Origin for Change:**

Suggestion by IACS Member

**.2 Main Reason for Change:**

To amend paragraph E25.2.1 in order to clarify the intention and the requirements of this paragraph.

**.3 List of non-IACS Member Classification Societies contributing through the TC Forum and/or participating in IACS Working Group:**

None

**.4 History of Decisions Made:**

The Revision 1 was discussed by correspondence and agreed at the 29<sup>th</sup> Panel Meeting (from 26<sup>th</sup> to 28<sup>th</sup> of March) and finally on 13/11/2019 (Ref: PM19801\_IMi)

**.5 Other Resolutions Changes**

None

**.6 Any hinderance to MASS, including any other new technologies:**

None

**.7 Dates:**

Original Proposal: 9 January 2019 (Ref: PM19801\_IMa)  
Panel Approval: 13 November 2019 (Ref: PM19801\_IMi)  
GPG Approval: 7 December 2019 (Ref: 19139\_IGe)

- **New (June 2016)**

**.1 Origin for Change:**

Suggestion by IACS member

**.2 Main Reason for Change:**

Section 4 in UI SC94 was introduced in revision 1. The Machinery Panel considered that the content is more suitable for a UR rather than a UI. It was hence agreed to review Section 4 of UI SC94 and move the contents to a new UR. Subsequently a new task was opened to revise UI SC94 accordingly.

**.3 List of non-IACS Member Classification Societies contributing through the TC Forum and/or participating in IACS Working Group:**

None

**.4 History of Decisions Made:**

Form A agreed in December 2012.  
Draft UR E25 agreed by Machinery Panel in June 2015.

**.5 Other Resolutions Changes**

UI SC94: Section 4 to be removed and document to be re-numbered in a new task

**.6 Dates:**

Original Proposal: 30 March 2012                      Made by a Machinery Panel Member  
Panel Approval: 12 May 2016 (Ref: PM11919) GPG  
Approval: 21 June 2016 (Ref: 12222\_IGf)



## **Part B. Technical Background**

List of Technical Background (TB) documents for UR E25:

Annex 1. **TB for New (June 2016)**

See separate TB document in Annex 1.

Annex 2. **TB for Rev.1 (Dec 2019)**

See separate TB document in Annex 2.

Annex 3. **TB for Rev.2 (Mar 2022)**

See separate TB document in Annex 3.

## **Technical Background (TB) document for UR E25 (New June 2016)**

### **1. Scope and objectives**

To clarify the requirements for failure detection in steering gear control and monitoring systems and what is considered an acceptable response to such. Develop a new UR with agreed requirements.

### **2. Engineering background for technical basis and rationale**

Rev.1 of UI SC94 describes under section 4 "failure detection and response of control systems". The need for unified requirements for steering gear control systems is acknowledged by all members, and that such should be made through a UR rather than a UI SC.

Failure in the steering gear control system shall be detected and provide the operator with sufficient information to decide what action is required for the different failure scenarios. The UR provides more details on which failures shall be alarmed.

### **3. Source/derivation of the proposed IACS Resolution**

Basis for the new UR is Section 4 of UI SC94 (Rev.1). This was developed further based on experience in the application of UI SC94 and on engineering judgment.

### **4. Summary of Changes intended for the revised Resolution:**

N/A

### **5. Points of discussions or possible discussions**

- Deviation alarm is now required, not as an alternative to, but in addition to basic failure detection. The deviation alarm is used to alarm in situations where the rudder does not reach its setpoint (SP) within a specified time after SP change. Mechanical block of the rudder blade and failure in the control valve are examples of failures resulting in a deviation. The Panel acknowledged that a deviation alarm is useful for notifying the operator of failures resulting in inability to actuate the rudder to the given command. However, as the alarm is on a very high level and does not indicate the cause of failure or which system is affected, the deviation alarm cannot substitute loop monitoring or any of the alarms referred to in 1.1. Moreover, it is noted that a deviation alarm is required by the USCG.
- Earth fault detection is required on AC and DC circuits. Earth fault detection is moved to a separate bullet point as the requirement is somewhat different in detection and rectification than a pure power supply failure and "on AC and DC circuits" is explicitly stated to remove ambiguity.
- Loop failure detection is required in closed loop systems, both command and feedback loops signals.
- Industry review was carried out to get feedback on the new UR E25 and two (2) SGCS manufacturers provided their interpretations and comments as follows, mostly concerning about the definition of the listed alarms.

Industry comments to UR E25	Proposed answers
<p><b>1. Failure detection</b></p> <p><i>1.1 The most probable failures that may cause reduced or erroneous system performance shall be automatically detected and at least the following failure scenarios shall be considered:</i></p> <p>Comment: Well noted in general</p>	
<p><i>a) Power supply failure</i></p> <p>Comment: Definition of <i>Power supply failure</i> is not clearly shown. We manufacturers need to refer to commonly defined standards and understand that the IEC requirements and test specifications covers this requirement. If IACS has any specific requirement to be applied, please inform us.</p> <p>* Refer to item 7 Power supply in IEC 60945 Maritime navigation and radio communication equipment and system - General requirements – Methods and required test results.</p>	<p>It is anticipated that a SGCS has passed the tests concerning power supply in UR E10 / IEC 60945. The “power supply failure” referred to in the draft UR concerns loss of power to any part of the SGCS as defined in SOLAS Regulation II-1/3.1.</p>
<p><i>(b) Earth fault on AC and DC circuits</i></p> <p>Comment: Definition of <i>Earth fault on AC and DC circuit</i> is not clearly shown. IEC60945 has no specific description or requirement on this Earth fault. If IACS or a classification society (hereinafter referred to as Class) has any specific requirement which covers the fault definition and conditions, please inform us.</p> <p>If such a test requirement requires covering all power supply of the systems which are connected to SGCS, the signal lines and other factors, it may be out of scope of SGCS performance. E.g. an earth failure in the other system which is connected to SGCS and its secondary earth failure if initiated in SGCS is quite difficult to monitor what is being failed in that system. It also should be defined to exclude the SGCS which has the own power supply system isolated from main power supply as well as the signal line earth failure.</p>	<p>Item (b) “Earth fault on AC and DC circuits” was included on the list of potential failure scenarios to ensure that it is considered for all designs, it was not expected that it would be applicable to all designs. The wording of the UR should be noted, the items listed under item 1.1 are to be “considered”. There is no intent to require all the items to be included in the control system if they are not applicable.</p> <p>For example: If the control system is an insulated supply fed via a transformer, we would need to know if that supply has an earth fault on one of the conductors. If it is fed direct from the main supply (which already has earth fault detection or is an earthed system) this would not be required.</p> <p>Any earth fault detection (if required) should result in an alarm to alert the crew and then the cause would be investigated, it would not be expected to have an immediate impact on the operation of the steering gear.</p>
<p><i>(c) Loop failures in closed loop systems, both command and feedback loops (normally short circuit, broken connections and earth faults)</i></p> <p>Comment: Definition of <i>closed loop systems</i> is not clearly shown. Title of this proposed UR says <b>Failure detection and response of all types of steering control systems.</b></p>	<p>The wording “all types” in the title of the proposed UR is intended to highlight that the requirements not only relate to traditional steering gear systems, but also to thruster arrangement, Voith Schneider etc. By “closed loop control” in the context of the UR, one considers mainly the closed loop</p>

Industry comments to UR E25	Proposed answers
<p>SGCS controls two types of steering gear hydraulic system e.g. one is like direct control of steering gear directional solenoid valves and it senses the actual rudder position for its servo loop control.</p> <p>Another is a control system to actuate a floating lever which mechanically controls the swash-plate of a steering gear pump. SGCS has a small control loop with its own pump units and performs actuator stroke control with the signal between the steering order and the repeatback signal from the actuator. Then it has NO direct feedback of the rudder position.</p> <p>SGCS for the latter system does not make a control loop with the rudder position or provide the main loop control alarm. Is this system excluded?</p>	<p>controller loop acting on the rudder.</p> <p>The requirements also apply to other closed loop control in a SG control system. If it is documented however (e.g. in an FMEA) that failures have no impact on the steering function, failure detection as specified in the UR may not be required.</p>
<p><i>(d) Data communication errors</i></p> <p>Comment: Definition of data communication coverage is not clearly shown. We understand that the data communication error in this section (d) is somewhere between SGCS and other equipment connected. Data communication errors inside SGCS are covered in (e) below as hardware or software failures.</p>	<p>Communication failure can occur between internal components in the SG control system, but also between the SG control system and external systems (such as the autopilot and alarm panel).</p>
<p><i>(e) Programmable system failures (Hardware and software failures)</i></p> <p>Comment: Well noted in general</p> <p>Tests for SGCS system has been carried out based upon IEC60945 and some Class environmental requirements like the vibration test up to 4G. Test procedure of this failure should be clearly defined for shop test or onboard test.</p>	<p>The SG control system shall comply with the environmental requirements in IACS UR E10. HW and SW failures in the context of this UR are not related to environmental compliance.</p> <p>The HW in a programmable system is often built up by a CPU module, power module, I/O modules, communication modules, etc.. Failure in such (e.g. failure in I/O module) shall initiate an alarm.</p> <p>SW failure is typically detected by check-sum and watch-dog. Failure is to initiate alarm.</p>
<p><i>(f) Hydraulic locking HLA :</i></p> <p>Comment: Hydraulic lock alarm is clearly defined as an alarm of steering gear itself in Classes rule. It is available to provide the hydraulic lock alarm in SGCS once such alarm information is supplied from a steering gear alarm managing system. Sensing the HLA condition is out of scope of SGCS.</p>	<p>The HY lock alarm (HLA) shall be in the same alarm panel as the other required SG alarms.</p>
<p><i>(g) Deviation between rudder order and feedback*</i></p> <p><i>* Deviation alarm shall be initiated if <u>the rudder's actual position</u> does not reach the set point within acceptable time limits. Deviation alarm may be caused by mechanical, hydraulic or electrical failures.</i></p> <p>Comment: Well noted in general but the definition of this alarm is not clearly shown. Please refer to the comment in (c) above. Some current</p>	<p><b>AA:</b> Applicable for closed loop rudder control.</p> <p><b>BB:</b> The deviation alarm required in this UR shall be through the alarm panel used for the other required SG alarms. It is acceptable to generate this alarm through the HW used in the SG controls system based on deviation between the command from the helm and the rudder feedback. The deviation alarm in this UR is</p>

Industry comments to UR E25	Proposed answers
<p>SGCS does not sense <u>the rudder's actual position</u> to satisfy this alarm requirement.</p> <p>UR E25(new 2015) HF&amp; TB mentioned as;          "it is noted that a deviation alarm is required by the USCG."          We understand that the deviation alarm by the USCG is referred to;          USA 46CFR 113.43 Steering Failure Alarm Systems (hereinafter referred to as SFA)          SFA defines very specific requirements. It has to be independent alarm system from the main steering gear control systems mechanically and electrically as much as practicable.          SFA requires an independent steering wheel turning censor, a separate alarm managing system and a rudder transmitter with separate wiring arrangements between a wheel house and steering gear room.          SFA works only at steering wheel control mode, not at other steering modes and it can cover all type steering gear control systems independently.          We supply the SFA system as an option for US vessels or with a specific purchase order.</p> <p>For this (g) alarm, followings should be defined.          AA: Application coverage of SGCS, all SGCS or specific SGCS control type          BB: Whether it must be independent from SGCS same as SFA or the embedded alarm as a standard feature.          CC: Whether operating steering mode is only at steering wheel mode, or it covers all follow-up steering modes</p>	<p>independent of the USCG requirements. Deviation alarm in line with USCG is considered complying with the requirements in this UR.</p> <p>Arrangements in line with the requirements in this UR may NOT comply with the USCG.  <b>CC:</b> Deviation alarm as required in this UR should apply to any position where the operator can perform closed loop steering control.</p>
<p><i>1.2 All failures detected shall initiate audible and individual visual alarm on the navigation bridge.</i></p> <p>Comment: Well noted in general</p>	
<p><b>2. System response upon failure</b>  <i>2.1 The failures (as defined but not limited to those in 1.1) likely to cause uncontrolled movements of rudder are to be clearly identified. In the event of detection of such failure, the rudder should stop in the current position. Alternatively the rudder can be set to return to the midship/neutral position in the event of a failure. This is subject to the discretion of each Classification Society.</i></p> <p>Comment: We do not understand how to control a steering gear by SGCS when providing steering gear vital alarms as HLA or Deviation alarm which is caused by steering gear main construction failures like hydraulic control line trouble or steering gear power supplies.          SGCS system response to the alarms as shown above must be conditional, not available in all alarm cases.          There has been much discussion in MSC or IEC related committees on which is better for safety ship control as to stop the rudder in the current position or to return to the</p>	<p>We fully acknowledge the comment concerning control of the rudder in case of deviation alarm and or HLA. Comparing these two alarms ("Hydraulic locking" and "deviation between rudder order and feedback") with the first five faults listed in the UR, (f) and (g) are <u>effects of failure</u> rather than failures.</p> <p>Please note the wording in the proposed UR: "<i>likely to cause uncontrolled movements of rudder...</i>"          The rationale for the requirement ("zero or freeze in case of failure") is to prevent uncontrolled movement of the rudder. Freeze, e.g. through stopping the power units, is considered the only realistic action during HLA.          One could imagine many different failures</p>

Industry comments to UR E25	Proposed answers
<p>midship/neutral position in the event of a failure.  At the moment, it is defined to stop the rudder in the current position as with the requirement of TCS performance standard.  Our SGCS stops or holds the rudder order from a steering stand to the steering gear control system in a steering gear room.</p>	<p>that could cause deviation alarm (f).  Deviation alarm should hence generate alarm only (no action), unless the system identifies the deviation as an uncontrolled movement of the rudder.</p>

**6. Attachments if any**

None

## Technical Background (TB) document for UR E25 (Rev.1 Dec 2019)

### 1. Scope and objectives

To develop amendments to UR E25.2.1 (June 2016) to clarify the intention and requirements.

### 2. Engineering background for technical basis and rationale

- Regarding the 2nd and 3rd sentence of UR E25.2.1 (June 2016): it was observed that the rudder is requested to be stopped in the current position or returned to the midship/neutral position when vessels face with uncontrolled movements by failures (as defined but not limited to those in the 1.1 of UR E25); however the expression "In the event of..., the rudder should stop ... . Alternatively the rudder can be set to return ... a failure." was evaluated to be unclear for the reasons that recommendatory wordings such as "should" or "can be", which are not appropriate for a mandatory IACS Resolution, are used and such expression do not clarify if an automatic response may be required to satisfy the requirement.
- Regarding the last sentence of UR E25.2.1 (June 2016) The wording ".This is subject to the discretion of each Classification Society" was evaluated to be unclear as it may be interpreted to apply to both the 2nd and 3rd sentence of the UR (i.e. the Classification Society may evaluate not to apply the requirements for rudder positioning as stated in the 2nd and 3rd sentence) or it may be interpreted that the Classification Society need to choose between stopping the rudder in the current position (as per the 2nd sentence) or returning the rudder to the midship/neutral position (as per the 3rd sentence).

After consideration of the above matters:

- 1) it was decided to modify the 2nd and 3rd sentence of UR E25.2.1 (June 2016) (as per paragraph 4. below) to make clear that the Classification Society need to choose between stopping the rudder in the current position or returning the rudder to the midship/neutral position.
- 2) the Panel discussed on the need to add the following sentence at the end of paragraph 2.1 in order to allow in case of failure, as an alternative, an automatic change-over to stand-by steering gear power unit and control system:

*Alternatively, an automatic change-over to stand-by steering gear power unit and control system may be considered"*

This proposal was however not supported by the qualified majority for the reason that, in case of failures (as defined but not limited to those in paragraph 1.1), there is the risk that the change over to stand-by power unit and control system might not impede further uncontrolled rudder movements; the change-over to stand by steering gear was therefore not considered an alternative to stop the rudder in the current position or return it to the midship/neutral position.

In this regard one Members Society proposed to modify the above sentence as follow for the reason that in their understanding a "stand-by control system" is required by SOLAS Regulation II-1 / 29.7.2 only for steering gears arranged in

accordance with SOLAS Regulation II-1 / 29.6.1:

"Alternatively, for steering gears arranged in accordance with SOLAS regulation II-1 / 29.6.1, an automatic change-over to stand-by steering gear power unit and control system may be considered."

The proposal was however not supported by the qualified majority

- 3) An IACS Members proposed to add the following note at the end of paragraph E25.2.1 for the reason that, with regards to the hydraulic locking failure (item (f) of the failure list in UR E25.1.1), in their understanding of UR M42.12.2 and 42.13, in case of hydraulic locking of a steering gear designed to operate with 2 power units running simultaneously, the steering control is to be regained by stopping each pump in turn; accordingly, rudder stop in the current position or return to the midship / neutral position is not deemed sufficient:

*"Note: For hydraulic locking failure, refer also to UR M42.12.2 and 42.13."*

The proposal was supported by the qualified majority

### **3. Source/derivation of the proposed IACS Resolution**

N/A

### **4. Summary of Changes intended for the revised Resolution:**

Paragraph 2.1 has been modified as follow:

~~"2.1 The failures (as defined but not limited to those in 1.1) likely to cause uncontrolled movements of rudder are to be clearly identified. In the event of detection of such failure, the rudder should stop in the current position. Alternatively the rudder can be set to return to the midship/neutral position in the event of a failure. This is subject to the discretion of each Classification Society rudder is to stop in the current position without manual intervention or, subject to the discretion of the Classification Society, is to return to the midship/neutral position.~~

Note: For hydraulic locking failure, refer also to UR M42.12.2 and 42.13."

### **5. Points of discussions or possible discussions**

The amendments to the UR have been agreed by correspondence.

Regarding paragraph 2.1 the following comments/proposals have been received:

- One Members Society requested the Panel Members confirmation regarding the following their understanding:

*"Regarding the requirement "the rudder is to stop in the current position without manual interventions", it only apply to control systems (that is, to be achieved by interrupting control over the rudder by a control system which has failed so as not*



to allow the rudder to move), and is not to be interpreted as a requirement for the provision of additional gears in order to actually physically prevent the rudder from moving.”

The above understanding was shared by the unanimity of Panel Members.

- One Members Society proposed to modify paragraph 2.1 as follow to improve the readability:

*“2.1 Failures (as defined but not limited to those in 1.1) likely to cause uncontrolled movements of rudder are to be clearly identified. In the event of the detection of such failure;*

*.1 the rudder is to stop in the current position without manual intervention; or,*

*.2 the rudder is subject to the discretion of the Classification Society, to return to the midship/neutral position; or,*

*.3 the steering gear is to automatically change-over to the stand-by steering gear power unit and control system.”*

The proposal was not supported by the qualified majority

## **6. Attachments if any**

None

## **Technical Background (TB) document for UR E25 (Rev.2 Mar 2022)**

### **1. Scope and objectives**

To clarify the necessity of a system response for mechanical failures, including hydraulic locking.

### **2. Engineering background for technical basis and rationale**

According to UR E25 (Rev.1), it is required to stop the rudder without manual operation in the event of detection of failure that is identified as likely to cause uncontrolled movements of the rudder (system response). Hydraulic locking is included in the failure list to be considered for alarm and system response. When hydraulic locking occurs, it may cause uncontrolled rudder. In addition, a failure of a sticking valve that is a cause of hydraulic locking can also lead to uncontrolled rudder movement on a case-by-case basis. Therefore, according to UR E25 (Rev.1), it is interpreted that even mechanical failures such as sticking valves, including hydraulic locking, are subject to the system response.

On the other hand, for electrical failures in the system (e.g., data communication errors), the rudder can be stopped simply by an electrical signal from the steering control system, but the above-mentioned failure due to sticking valve is kind of a mechanical failure and cannot be stopped by an electrical signal from the steering control system. As stated in the IACS "proposed answer" in terms of "2. System response upon failure" in the table of TB of URE25(NEW), the only practical way to stop the rudder when hydraulic locking occurs is to stop the power unit. However, since it is difficult to implement the stopping of the power unit without manual operation (e.g., automatically stopping the pumps), the necessity of system response in the event of mechanical failure including hydraulic locking was reconsidered.

In addition, the Panel discussed that hydraulic locking is overlapped with 'deviation between rudder order and feedback' in the list of failures in UR E25. Also, a hydraulic locking alarm is already required in UR M42.

Based on the above, hydraulic locking is deleted from the list of failures in UR E25, and an exemption is added to the effect that mechanical failures are not subject to the system response.

### **3. Source/derivation of the proposed IACS Resolution**

None

### **4. Summary of Changes intended for the revised Resolution:**

To clarify that the subject of UR E25 is for the steering gear control system defined in UR M42 Appendix 1, an application statement is added to paragraph 1. In addition, the title of the UR is changed to steering gear control system from steering control system.

Upon the 34th IACS Machinery Panel Meeting, the following updates to UR E25 were agreed by the Panel:

- i) removal of "Hydraulic locking" from Requirement 2.1;
- ii) making references to UR M42.13 in Requirement 3.1; and
- iii) modifications on the wording of the added last sentence of Requirement 3.1.

## 5. Points of discussions or possible discussions

During the discussion, a Panel Member proposed the following two issues about failure scenarios in the E25.1.1. Regarding these two issues, the qualified majority agreed and finally concluded to amend as specified in item 4 of this TB.

Deletion of «(f) Hydraulic locking» or «(g) Deviation between rudder order and feedback»

- a. The failure scenarios '(f) Hydraulic locking' is overlapped with '(g) Deviation between rudder order and feedback'. And Hydraulic locking(f) is detected by the (g) failure.
- b. According to the HF of UR E25, the requirements came from 4 of the Rev.1 of UI SC94. The «Hydraulic locking considering order given by steering wheel or lever» had been listed on a kind of failure in 4.1.1 of the Rev.1 of UI SC94.

Scope of mechanical failures stating on the asterisk note(\*) for '(g) Deviation between rudder order and feedback'

- a. Steering Gear Control System cannot take an actions against kinds of mechanical failures without manual intervention, even if the failures cause uncontrolled movements of rudder.
- b. In this regard, the current UR E25 may lead to excessive requirement for all vessels. As a similar requirement to system response in UR E25.2.1(renumbered to 3.1), automatic isolation is required to a tanker, chemical tanker, or gas carrier of 10,000 GT and upwards in accordance with SOLAS II-1/Reg.29.1.6.2.
- c. Therefore, it is suggested stating on the UR E25 that mechanical failures such as sticking valves and failure of static components(pipes, cylinders) can waive system response in UR E25.2.1 (renumbered to 3.1) .

## 6. Attachments if any

None

## UR E26 "Cyber resilience of ships"

### Summary

UR E26 aims to ensure the secure integration of both operational technology and information technology equipment into the vessel's network during the design, construction, commissioning, and operational life of the ship. This UR targets the ship as a collective entity for cyber resilience and covers five key aspects: equipment identification, protection, attack detection, response, and recovery. This revision includes requirements for the suppliers to demonstrate compliance with the requirements in this UR.

### Part A. Revision History

Version no.	Approval date	Implementation date when applicable
Rev.1 (Nov 2023)	15 November 2023	01 July 2024
New (Apr 2022)	11 April 2022	01 January 2024*

\*New UR E26 was withdrawn in September 2023 before coming into force on 1 January 2024 (Ref: 22094\_IGm)

#### • Rev.1 (Nov 2023)

##### 1 Origin of Change:

- Other (*12<sup>th</sup> IACS Cyber Systems Panel meeting*)

##### 2 Main Reason for Change:

Develop IACS unified requirements for verification and survey in newbuilding and operational phase of cyber physical systems and vessels to ensure compliance with IACS UR E26.

##### 3 List of non-IACS Member classification societies contributing or participating in IACS Working Group:

JWG/Cyber systems

##### 4 History of Decisions Made:

During the 12th meeting of the IACS Cyber Systems Panel held September 21-23, 2021, following former discussions and request from GPG, the Cyber Panel agreed to form PTPC07 to develop requirements for verification, survey and audit in newbuilding and operational phase of cyber physical systems and vessels to ensure compliance with IACS UR E26 and UR E27. Executive summary of the history, such as internal decisions made, meeting minutes, reference to Form A or Form 1.

The objectives for PTPC07 have been defined in Form A as follows: "Establish common requirements for verification activities to ensure a harmonized practice for compliance with UR E26 and UR E27."

Further, it was decided by the Cyber Systems Panel in January 2023 that PTPC07 shall propose resolution of industry feedback to UR E26 and UR E27 ("pilot phase comments").

## **5 Other Resolutions Changes:**

UR E22 and UR E27 may be impacted, for cross-reference purposes.

## **6 Any hinderance to MASS, including any other new technologies:**

In the development of this UR, consideration has been given so as not to hinder the development of new or improved technologies providing an equivalent or higher level of safety.

## **7 Dates:**

Original Proposal:	August 2022	(Made by: PT PC07)
Panel Approval:	30 October 2023	(Ref: PC21008_ICzu)
GPG Approval:	11 November 2023	(Ref: 22094_IGp)

- **New (Apr 2022)**

\*New UR E26 was withdrawn in September 2023 before coming into force on 1 January 2024 (Ref: 22094\_IGm)

**1 Origin for Change:**

Other

**2 Main Reason for Change:**

None

**3 List of non-IACS Member Classification Societies contributing or participating in IACS Working Group:**

None

**4 History of Decisions Made:**

During the 9th meeting of the IACS Cyber Systems Panel held in March 22-25, 2020, following former discussions and request from GPG, the Cyber Panel agreed to form a PT for the task of translating appropriate portions of Recommendation 166 on cyber resilience of ships into an IACS UR. Executive summary of the history, such as internal decisions made, meeting minutes, reference to Form A or Form 1.

The objectives for this PT have been defined in Form A as follows:

1. Starting from the experience and knowledge acquired in the development of Recommendation 166 on cyber resilience of ships, produce an UR with minimum goal-based requirements for cyber resilience of new ships. The focus will be set on OT systems and cyber incidents resulting from any type of offensive maneuver that targets such systems, excluding system failures. The extent of requirements will be limited to the most common and effective cyber security barriers, feasible for a smooth implementation on all new ships. Such requirements will be mandatory for OT systems that, if compromised, could immediately lead to dangerous situations for human safety, safety of the vessel and/or threat to the environment.
2. Organize the UR to make it possible to implement the requirements therein contained uniformly and smoothly by class societies and industry and make it applicable to all types of vessels, in such a way that the requirements enable a minimum level of security and apply to all classed vessels/units regardless of operational risks and complexity of OT-systems.
3. Organize the UR to encourage its evolution and improvement to continuously provide answers to industry expectations e.g. on systems connectivity,

digitalization and smart shipping, anticipating the needs of autonomous ships (MASS) and supporting the effort of national and international authorities on cyber risk management.

IACS officially released the unified requirements UR E26 "Cyber Resilience in Ships", and UR E27, "Cyber Resilience Equipment and Systems", in the month of April in the year 2022, with scheduled implementation date of 01 January 2024.

Given the relatively nascent nature of the subject matter in maritime sector, an imperative need to establish a standardized approach to survey requirements was envisaged and the aforementioned unified requirements underwent a meticulous revision, to incorporate survey requirements. Industry feedback on published URs were also suitably addressed in revised URs (now referred to as Rev1) slated to come into effect on 01 July 2024.

During the course of development of revised URs, considering the challenges in implementation of the new cyber requirements in smaller vessels, falling under IACS's scope of applicability as delineated in "IACS General Procedures Volume 1 Chapter A Introduction- para 2 IACS's scope of interest," the applicability of these unified requirements was bifurcated as mandatory compliance for one category of vessels and non mandatory compliance for another category, in accordance with reference GPG mail 18197b.

Recognizing the intrinsic interrelationship between IACS UR E27 and UR E26, the scope of applicability of both URs and to eliminate any potential confusion which could arise within the industry, due to availability of two versions of same UR with different implementation date a strategic decision was taken to withdraw the original (new) version of UR E26 and UR E27, as initially published in the year 2022 which requires mandatory application to all ships contracted for construction from 01 January 2024.

This strategic approach also eliminates any conceivable perplexity in Industry that might arise from having two distinct versions/revisions of the same URs, characterized by a six-month variance in their implementation dates, divergent scopes of applicability, and supplementary survey information available through the official IACS website.

## **5 Other Resolutions Changes**

UR E22 and UR E27 may be impacted, for cross-reference purposes.

## **6 Any hinderance to MASS, including any other new technologies:**

In the development of this UR, consideration has been given so as not to hinder the development of new or improved technologies providing an equivalent or higher level of safety.

## **7 Dates:**

Original Proposal:	December 2019
Panel Approval:	September 2021
GPG Approval:	11 April 2022 (Ref: 18197aIGz)

## **Part B. Technical Background**

List of Technical Background (TB) documents for UR E26:

Annex 1. **TB for New (Apr 2022)**

See separate TB document in Annex 1.

Annex 2. **TB for Rev.1 (Nov 2023) – Survey requirements**

See separate TB document in Annex 2.

Annex 3. **TB for Rev.1 (Nov 2023) – Pilot phase Comments**

See separate TB document in Annex 3.



## **Technical Background (TB) document for UR E26 (New Apr 2022)**

### **1. Scope and objectives**

The aim of this resolution is to provide a minimum set of requirements for cyber resilience of ships, with the purpose of providing technical means to stakeholders which would lead to cyber resilient ships.

This resolution targets the ship as a collective entity for cyber resilience and is intended as complementary to other URs and industry standards addressing cyber resilience of onboard systems, equipment and components.

IACS Recommendation 166 on Cyber Resilience is intended for ships contracted for construction after its publication and may be used as a reference for ships already in service prior to its publication. For ships to which this resolution applies as mandatory instrument, when both this resolution and Recommendation 166 are used, should any difference in requirements addressing the same topic be found between the two instruments, the requirements in this resolution shall prevail.

### **2. Engineering background for technical basis and rationale**

Interconnection of computer systems on ships, together with the widespread use onboard of commercial-off-the-shelf (COTS) products, open the possibility for attacks to affect personnel data, human safety, the safety of the ship, and threaten the marine environment.

Attackers may target any combination of people and technology to achieve their aim, wherever there is a network connection or any other interface between onboard systems and the external world. Safeguarding ships and shipping in general from current and emerging threats involves a range of measures that are continually evolving.

It is then necessary to establish a common set of minimum functional and performance criteria to deliver a ship that can indeed be described as cyber resilient.

IACS considers that minimum requirements applied consistently to the full threat surface using a goal-based approach are necessary to make cyber resilient ships.

### **3. Source/derivation of the proposed IACS Resolution**

The development of this resolution starts from the experience and knowledge acquired in the development of Recommendation 166 on cyber resilience of ships (IACS Recommendation 166), with the aim to produce an UR with minimum goal-based requirements for cyber resilience of new ships.

The focus is set on OT systems and cyber incidents resulting from any type of offensive manoeuvre that targets such systems, excluding system failures.

The extent of requirements is limited to the most common and effective cyber security barriers, feasible for a smooth implementation on all new ships. Such requirements will be mandatory for OT systems that, if compromised, could immediately lead to dangerous situations for human safety, safety of the vessel and/or threat to the environment.

Recommendation 166 will remain in force, whereas only some of the content in this document is lifted over to this resolution, which aims to be small and focus on the most important cyber security barriers.

This resolution is not concerned about hw/sw failures, but considers only cyber incidents, i.e. events like intentional or accidental unauthorized access, misuse, modification, destruction or improper disclosure of the information generated, archived or used in onboard computer-based systems of interest, or transported by the networks connecting such systems.

Taking into account the organization and layout of contents adopted in other authoritative and widely accepted guidelines (IMO MSC-FAL.1/Circ.3, BIMCO Guidelines...) the organization of contents is inspired by the so-called NIST Cybersecurity Framework, however maintaining a goal-based approach.

In order to evaluate the topics to be translated into this resolution from Recommendation 166, an excel sheets which contains the items extracted from the latest consolidated version of Recommendation 166 has been used. For each item, CS Panel Members and IACS Joint Working Group/Cyber Systems (JWG) Members have been asked to vote on the need for a translation into an UR.

An "experience-building phase" has also been considered to clarify and define the scope of Recommendation 166 to be made mandatory. Discussions have been carried out inside the Panel on how to implement the experience building phase in order to agree a common way adopted by all Members and collect feedback in a consistent format so as to ensure an effective experience capable of providing results concretely useful for the finalization of the UR.

At the time of discussion, there was very limited experience in Class Societies and their clients in the actual application of Rec. 166 and a more extensive experience on its application in the near future seemed not realistic.

It was also noted that a conventional EBP was not possible since Rec.166 is not established as mandatory requirements. Consequently, it was not possible to gain experience from its implementation. It was then agreed to start the drafting of a UR and seek to gather feedback from relevant parts of the industry in the process of making the UR (i.e. from IACS members and JWG).

The experience building phase relied strongly on JWG inputs, by way of regular meetings with JWG members to collect comments about the progression of the UR, comments sent by JWG members to the JWG Chairman through the dedicated email threads and specific expectations sent by members to the JWG Chairman.

This resolution has been designed to be open to future developments, to meet possible future evolution and improvements and continuously provide more and more appropriate answers to industry expectations e.g. on systems connectivity, digitalization and smart shipping, anticipating the needs of autonomous ships (MASS).

#### **4. Summary of Changes intended for the revised Resolution:**

None

#### **5. Points of discussions or possible discussions**

##### ***Organization of the UR:***

This resolution follows a goal-based approach and contains minimum goal-based requirements for cyber resilience of new ships.

The primary goal is to support safe and secure shipping, which is operationally resilient to cyber risks.

Whereas safe and secure shipping can be achieved through effective cyber risk management, to achieve the above, sub-goals for the management of cyber risk are defined for the five functional elements listed below:

1. Identify: Develop an organizational understanding to manage cybersecurity risk to onboard systems, people, assets, data, and capabilities.
2. Protect: Develop and implement appropriate safeguards to protect the ship against cyber incidents and maximize continuity of shipping operations.
3. Detect: Develop and implement appropriate measures to detect and identify the occurrence of a cyber incident onboard.
4. Respond: Develop and implement appropriate measures and activities to take action regarding a detected cyber incident onboard.
5. Recover: Develop and implement appropriate measures and activities to restore any capabilities or services necessary for shipping operations that were impaired due to a cyber incident

These sub-goals and relevant functional elements should be concurrent and considered as parts of a single comprehensive risk management framework.

Functional/technical requirements are given for the achievement of specific sub-goals of each functional element.

While it is generally recognized that in the cyber risk management operational aspects are fundamental elements to achieve the target goals and subsequently the sub-goals, it has been pointed out by the JWG that these elements should be ensured by other guidelines specifically directed for ship owners (BIMCO Guidelines etc.) and reference to the operational requirements should be avoided. This point of view has been taken in high consideration in this UR.

The requirements are intended to allow a uniform implementation by stakeholders and to make them applicable to all types of vessels, in such a way as to enable an acceptable level of resilience and apply to all classed vessels/units regardless of operational risks and complexity of OT systems.

For each requirement, a rationale is given.

A summary of actions to be carried out and documentation to be made available is also given for each phase of the ship's life and relevant stakeholders participating to such phase. Criteria for performance evaluation and testing are also given.

### ***Scope of application***

This resolution applies to:

- a) Operational Technology (OT) systems onboard ships, i.e. those computer-based systems (CBS) using data to control or monitor physical processes that can be vulnerable to cyber incidents and, if compromised, could lead to dangerous situations for human safety, safety of the vessel and/or threat to the environment. In addition, navigational systems required by statutory regulations and internal and external communication systems required by class rules and statutory regulations are included in the scope of applicability of this resolution,

and

- b) Any IP-based communication interface from CBSs in scope of this UR to other systems

The cyber incidents considered in this resolution are events resulting from any offensive manoeuvre that targets OT systems onboard ships.

Concerning inclusion of IT systems in the scope of applicability, a discussion has been carried out about the possibility to require a-priori segregation between IT and OT systems to avoid inclusion of IT systems in the scope of applicability.

Another approach to inclusion of IT systems in scope of applicability has been discussed, based on the impact of a possible impairment of an IT system on the safe operation of the ship, leading to a categorization of IT systems connected to OT systems essentially according to E22 Cat.I, II, III.

Both approaches have been considered as feasible, however none has been selected as exclusively applicable, also taking into account the variety of real-world cases.

IT systems connected to OT systems are not considered in the scope of applicability of this resolution, however the interface in-between is considered in scope and should be the same level of security as required to the CBS in scope.

The Scope of Applicability has been defined also taking into account the absence of a requirement for Risk Assessment and is intended to clarify which CBSs belong to which E22 Category.

Having a unique Scope of Applicability among all URs on cyber resilience, including E22 has been proposed, to be referenced by other URs. This unique scope of applicability should provide a sufficiently exhaustive and clear list of CBS and

criteria to assign CBS to Cat.I, II or III to novel technologies, new devices etc. To this purpose, the list provided in this resolution can be considered as a starting point.

### ***Risk Assessment***

An assumption of this resolution is that a preliminary risk assessment is already done by IACS, resulting in a defined minimum set of requirements and a defined set of computer-based systems (indicated in the Scope of Applicability) to be considered for the safety of the ship.

This assumption implies that an initial risk assessment to establish appropriate level of protection is not needed since this is implied by the pre-selected minimum goal-based requirements in this resolution.

However, there could be systems on board for which the cyber risk is negligible and may be exempted from some or all requirements. Criteria for such exemption are not precisely defined in this resolution, due to the possible variety of real-world cases.

To avoid diverging practice among shipyards and classification societies, it would be necessary to develop a more prescriptive methodology for such risk assessment and its acceptance criteria. It may be feasible to focus on attack surfaces such as network connections, physical access to the equipment, portable devices, software updates, etc.

This resolution allows for a system-oriented risk assessment in the design phase. The purpose of this would be to determine if any of the required systems are "so simple" that they by design represent low risk. The requirements to such systems could then be less. The system-oriented risk assessment in the design phase is aimed to establish if any requirements are not applicable for certain systems or vessels. E.g. requirement for secure remote access is not applicable if there is no system providing remote access.

Exclusion of a Computer Based System falling under the scope of applicability of this resolution from the application of relevant requirements needs to be duly justified and documented. Such exclusion can be accepted by the Classification Society only if evidence is given that the risk level associated to the operation of the CBS is under an acceptable threshold by means of specific risk assessment.

The risk assessment shall be based on available knowledge bases and experience on similar designs, if any, taking into account the CBS category and its connectivity. Cyber threat information from internal and external sources may be used to gain a better understanding of the likelihood and impact of cybersecurity events.

In the risk assessment, the following elements shall be considered:

1. Asset vulnerabilities;
2. Threats, both internal and external;

3. Potential impacts of cyber incidents affecting the asset on human safety, safety of the vessel and/or threat to the environment;
4. Possible effects related to integration of systems, or interfaces among systems, including systems not onboard (e.g. if remote access to onboard systems is provided).

The risk model may be developed using one of the well-established methods such as fault tree analyses, event tree analyses, Markov models, Bayesian networks, structural reliability analyses, etc.

There may be different approaches to approval of the risk assessment for exclusion of CBS from the application of requirements, depending on how challenging the proposed set of excluded requirements is for the CBS of interest.

One approach to the approval is to compare the safety performance of the CBS to existing designs to demonstrate that an equivalent level of safety is guaranteed. In order to demonstrate an equivalent level of safety, evaluation criteria should be established. Safety objectives and functional requirements should be taken into consideration when developing the evaluation criteria.

To allow verification of safety equivalence, the risk assessment shall be complemented with a test plan where specific tests addressing the excluded requirements are described and relevant results documented.

By means of execution of these tests, the CBS of interest is to demonstrate that it will perform its intended safety related functions in a manner that is equivalent to or better than the prescriptive requirement it is deviating from.

Upon positive verification of test results and analysis of the risk assessment documentation, the risk assessment can be approved.

### ***Verification activities by the classification societies***

In section 5 (Test plan for performance evaluation and testing) and in the appendix (Summary of actions and documents) E26 indicates expected activities to be carried out by the relevant stakeholders.

It is worth noting that Section 5 "Test plan for performance evaluation and Testing" is mainly about design, implementation, execution and maintenance of a Test Plan, which is the essential instrument intended to support and ground the verification of the effective implementation of measures adopted for the fulfilment of requirements. It does not indicate how to test or how to conduct surveys, rather it prescribes how the essential instrument intended to support and ground testing and verification (the Test Plan) shall be done: how it shall be designed, implemented and maintained in the different phases of the ship's life, also indicating responsibility related to these actions.

Definition of specific survey requirements is delegated to a different document in the Z series and is not in scope of this UR.

When the new Z-series document will be established, it will probably be necessary to revise section 5 of this resolution in order to align and harmonize the contents of the two documents. This revision will probably also affect the documentation to be provided to Class societies.

### ***Security Levels***

While ISA/IEC 62443 and other popular standards have a robust, articulated and target-based definition of security levels (SLs), using SLs in this resolution in the same way and based on the same principles appears to be not compatible as the UR is set to provide minimum requirements.

Form A states that minimum security requirements for all new vessels shall be defined: this implies that multiple security levels are not relevant for this resolution.

On the other hand, UR E22 already has a concept of SLs implied with the definition of Cat.I, II and III. So, having a common approach followed by this resolution and E22 has been considered more important and consistent.

Categories defined in E22 (Cat.I, II, III), even if based essentially on the impact or consequences of possible impairment of CBS functionality due to a cyber incident, are very familiar to most stakeholders (UR E22 has been in force for very long time) and provide a well-understood view of CBS's criticality.

Other subdivisions or categorizations such as 62443-like security levels have been avoided in this resolution.

For the sake of clarity, the word "category" has been reserved to E22 categories and not used anywhere else.

### ***Requirements to be fulfilled during the ship's operational life***

Requirements to be fulfilled during the ship's operational life have been considered in this resolution. This will be further addressed in the Z-series document that will be developed describing survey procedures and activities.

Based on feedback from JWG, it was decided to exclude verification activities by the classification societies during the operational phase of the vessel, except verification of required documentation. This conclusion should be considered a point for discussion since it is widely recognized that cyber security relies on continuous management of cyber risks, policies, procedures, roles and responsibilities, physical access control, awareness training, monitoring of cyber events, management of change, security patching, incident response, business continuity, etc.

E26 currently includes some requirements to the shipowner related to the operational phase, but no verification activities by the classification societies, except verification of required documentation.

### **6. Attachments if any**

None

## **Technical Background (TB) document for UR E26 (Rev.1 Nov 2023) - Survey requirements**

### **1. Scope and objectives**

Form A specified four work items, summarized as follows:

- a) Specify verification activities of cyber physical systems delivered by product suppliers.
- b) Specify verification activities of integration, architecture and implementation by shipyards or system integrators.
- c) Specify verification activities of cyber security management during operation.
- d) Establish guidance for acceptance criteria, compensating countermeasures, test methods and application of alternative standards.

### **2. Engineering background for technical basis and rationale**

Since UR E26 specifies requirements for the installation, integration and management of cyber physical systems onboard, it was decided that UR E26 Rev.1 should address item II, III and IV in Form A.

Furthermore, it was decided that UR E26 Rev.1 should specify requirements to how system integrators and shipowners shall demonstrate compliance with the requirements of UR E26. Hence, it should not specify how the classification societies shall carry out verification activities.

It was considered important to ensure the classification process specified in UR E26 is not in contradiction with UR E22.

Finally, it was considered important to rectify any faults or inconsistencies that may have been overlooked in the development of the original version of UR E26.

#### **2a. Specification of the data utilised in the development/revision of the proposed IACS Resolution, if any**

None

### **3. Source/derivation of the proposed IACS Resolution**

None

### **4. Summary of Changes intended for the revised Resolution:**

None

### **5. Points of discussions or possible discussions**

#### **5.1 Management of cyber security**

During development of UR E26 Rev.1 it was discussed how requirements in E26 related to management of cyber security may be demonstrated by the stakeholder and how these requirements may be verified by the classification



societies.

It was recognized that these requirements are generally not prescriptive, enabling verification by testing or conventional inspection/survey, but that they are goal-based and relies on processes implemented in the organization responsible for operation of the vessel.

It was also recognized that these requirements may be considered broadly addressed by IMO resolution MSC.428(98) and may be partly covered by the Flag's statutory requirements. E.g. "*Administrations to ensure that cyber risks are appropriately addressed in safety management systems*".

Since these requirements are considered important to ensure cyber resilience in the operational phase of the vessel, it was decided to keep the requirements in E26 and verify compliance by the following survey schemes:

- 1) Verify in the first annual survey that Shipowner's documented processes (i.e. policies, procedures, manuals, instructions, etc.) address the requirements in E26
- 2) Verify in subsequent annual surveys that Shipowner organization follows the documented processes that are submitted and verified in the implementation survey.
  - a) It was discussed if the verification to be carried out in the annual surveys is considered an "audit" activity and if such activities shall be required by classification societies.

Since the annual survey requirements in UR E26 are quite prescriptive, and refer to specific technical requirements in E26, it was found that these verification activities are to be considered "survey items". The classification surveyor shall verify that relevant records or other artifacts have been produced demonstrating that the required technical security countermeasures in UR E26 are maintained and demonstrating that the required processes/management activities in UR E26 are implemented on board.

- b) It was discussed if the scope of annual survey is the same as invoked by MSC.428(98) and IACS Procedural Requirements No.9 (*Procedural Requirements for ISM Code Certification*).

The security-related requirements invoked by MSC.428(98) are general and nonspecific. The ISM Audit is required by the Administration (not classification societies) and intends to verify that the objectives of the ISM Code are met (i.e., "*that SMS takes into account cyber risk management*" and "*that cyber risks are appropriately addressed in the SMS*"). Based on this, the ISM Audit cannot be considered to cover the prescribed requirements in UR E26.

The documented processes were summarized in Appendix I and Appendix II, and the survey items/acceptance criteria are specified in each subsection "Operation phase".

See also Definition of audit in UR E27 HF\_TB (Rev.1 Apr 2023) Annex 3 item 5.1.

## 5.2 Alignment of requirements with UR E27

During the development of the new unified requirements E26 and E27 in 2022, efforts were made to ensure that these two documents were aligned. This alignment was continued in the development of the revised E26 and E27 in 2023.

The objective was to ensure that CBSs approved in accordance with UR E27 would have all necessary security capabilities to meet the requirements of E26.

## 5.3 Content of documentation to be submitted by System integrator

Based on the process specified in UR E27 Rev.1, all CBSs in the scope of applicability shall be verified to meet all applicable requirements of UR E27 before delivery to the System integrator (shipyard).

If the System integrator supplies equipment in scope of applicability, the System integrator is considered a Supplier, and UR E27 applies also for the System integrator.

The process in UR E27 includes assessment of documentation and survey by the classification society with factory acceptance test. CBSs that are type approved in accordance with UR E27 may be subject to a lesser verification process.

Based on the above process, it was decided that E26 shall not require the System integrator to document the security capabilities required by UR E27 (since this is the responsibility of the Suppliers).

It was also decided that E26 shall not require testing of these security capabilities in the commissioning phase on board (since this is done in FATs or type approval testing).

Consequently, it was decided to focus requirements to the System integrator on issues related to integration (e.g. security zones, physical access controls, security zone boundaries, etc.)

The requirements for documentation by the System integrator are specified in section 5.1 and in each subsection "Design phase".

The requirements for testing during commissioning on board are specified in section 5.2 and in each subsection "Commissioning phase".

## 5.4 Scope of testing in the commissioning phase

The extent of required testing in the commissioning phase was subject to discussions during the development of UR E26 Rev.1.

It was concluded that the Ship cyber resilience test procedure shall include all tests specified in the subsections "Commissioning phase". This will ensure that the shipowner will receive a complete test procedure upon delivery of the ship.

However, since most of the requirements in UR E26 are fulfilled by security capabilities specified in UR E27 and since all CBSs in the scope of applicability are required to be certified in accordance with UR E27, it was agreed that some

tests may be omitted from the Commissioning phase (such tests are specifically identified in the respective subsection "Commissioning phase"). This concept is further justified as follows:

- Since the certification process in UR E27 includes, for each CBS and equipment in the scope of applicability, verification and testing of the required inherent security capabilities and configuration thereof, it will not add significant value to repeat the test onboard. Examples are the capability to respond safely to DoS events (section 4.2.2) and the capability to be restored in the event of cyber events (section 4.5.2).
- Tests associated with physical installation or integration of the CBSs onboard may not be omitted in the commissioning phase. Examples are Dos attacks from external networks (section 4.2.2) and physical access control (section 4.2.4).
- The surveyor's decision to allow for omitting the specified tests shall be based on the certification process of the respective CBS or equipment having been carried out without any comments, compensating countermeasures, or subsequent modifications of the CBS.
- In the decision of this concept, it was also recognised that the process of testing all requirements for each component in each CBS in the scope of applicability will normally take several weeks. It was therefore found feasible to credit the testing required by UR E27 as relevant and specified in the respective subsections.

## **6. Attachments if any**

None

**Technical Background (TB) document for UR E26  
(Rev.1 Nov 2023)- Pilot phase Comments**

**1. Scope and objectives**

When IACS UR E26 and UR E27 were published in April of 2022, it was decided that the period until mandatory implementation should be considered a "pilot phase" and consequently that feedback from the industry should be considered in a possible revision of the URs.

**2. Engineering background for technical basis and rationale**

To allow classification societies sufficient time for implementation of the revised UR E26 and UR E27 it was decided that cutoff date for considering feedback from the industry should be set to December 1st. 2022.

In the evaluation of the feedback from the industry it was decided to categorize the consolidated result of each comment as follows:

- Clarification (no change)
- Suggestion for improvement

**2a. Specification of the data utilised in the development/revision of the proposed IACS Resolution, if any**

None

**3. Source/derivation of the proposed IACS Resolution**

None

**4. Summary of Changes intended for the revised Resolution:**

None

**5. Points of discussions or possible discussions**

5.1 Applicability of UR E26 and E27 (vessel types)

UR E26 Rev.1 was updated to specify vessel types for which the URs apply considering the following:

- IMO resolution MSC.428(98) encouraging Administrations to ensure that cyber risks are appropriately addressed in safety management systems required by ISM Code which applies to ships and units specified by SOLAS I/3 and SOLAS IX/2.

Mandatory requirements for:

- a) Passenger ships (including passenger high-speed craft) engaged in international voyages

- b) Cargo ships of 500 GT and upwards engaged in international voyages
- c) High speed craft of 500 GT and upwards engaged in international voyage
- d) Mobile offshore drilling units of 500 GT and upwards
- e) Self-propelled mobile offshore units engaged in construction (ie wind turbine installation maintenance and repair, crane units, drilling tenders, accommodation, etc)

Non-mandatory guidance to:

- a) Ships of war and troopships
- b) Cargo ships less than 500 gross tonnage
- c) Vessels not propelled by mechanical means
- d) Wooden ships of primitive build
- e) Passenger yachts (passengers not more than 12).
- f) Pleasure yachts not engaged in trade
- g) Fishing vessels
- h) Site specific offshore installations (ie FPSOs, FSUs, etc)

## 5.2 Applicability of UR E26 and E27 (CBSs)

During the pilot phase, classification societies received many questions from shipyards and suppliers about the scope of applicability.

Suppliers were asking which CBSs will be required to have the security capabilities specified in UR E27.

Shipyards were asking which CBSs will be required grouped into security zones and meet the requirements in UR E26.

Consequently, it was decided to revise section 1.3 and specify more precisely the scope of applicability of UR E26 and E27.

## 5.3 Illustration of "Physical network segment" and "logical network segment"

"Physical network segment" and "logical network segment" defined in UR E26 are illustrated below to help the readers understand.

The examples below are arranged in accordance with section 4.2.1; the network in each security zone is a separate broadcast domain (separate network segment) and communication between the security zones is controlled by a

firewall.

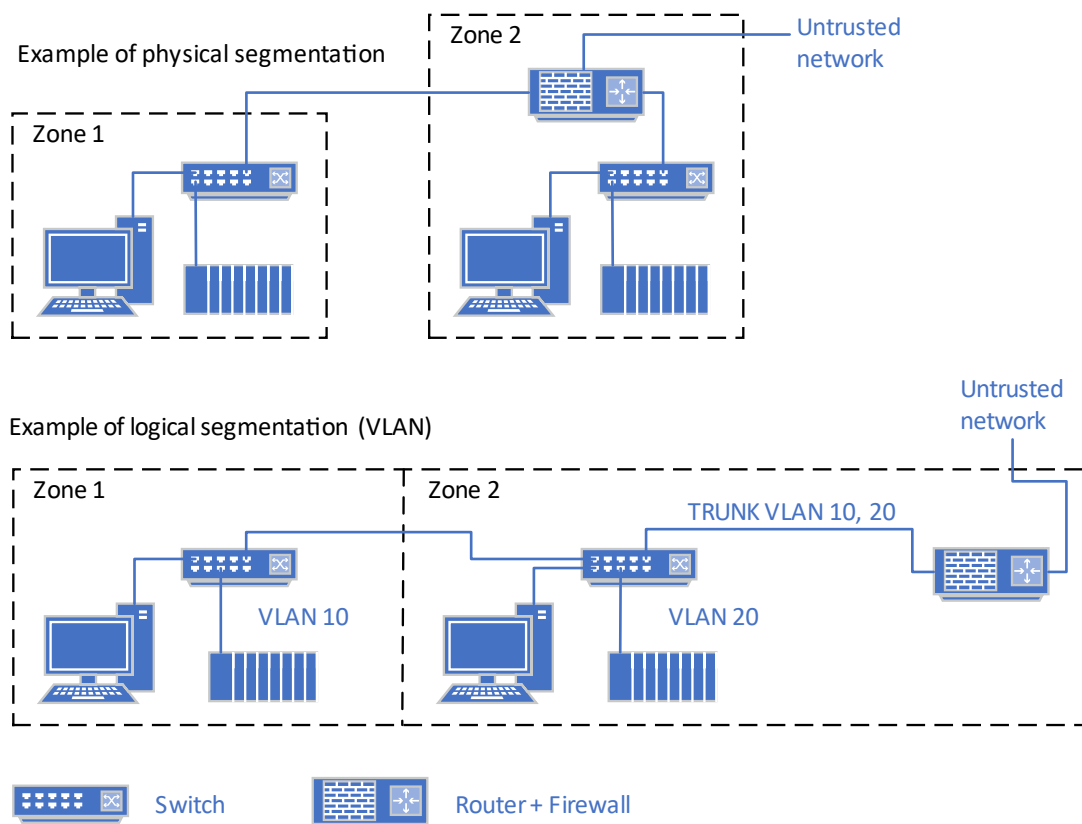
Required safety systems must be grouped in one or more dedicated security zones, and that these zones must be physically segmented from other zones.

Physical segmentation is also required if a CBS shall communicate with untrusted networks (outside scope of applicability).

Logical segmentation may be applied if other security zones shall communicate with each other (e.g., navigation systems and control systems).

The examples below are also arranged in accordance with section 4.4.3 (Network isolation), i.e., the connection between each zone may be disconnected in the event of a security incident.

Note that there may be multiple CBSs within a security zone. These CBSs may be isolated or connected to each other. Network segmentation and packet filtering (control of traffic) is not required for communication between CBSs within the same security zone.



#### 5.4 Interpretation of roll-back

The requirement in section 4.5.3 for CBSs to have the capability to roll-back was commented in the pilot phase. It was agreed to interpret "roll-back" in a similar way as "restore", i.e., that roll-back may be achieved by manual actions.

**6. Attachments if any**

None

# UR E27 “Cyber resilience of on-board systems and equipment”

## Summary

In this revision, UR E27 aims to ensure system integrity is secured and hardened by third-party equipment suppliers. This UR provides requirements for cyber resilience of onboard systems and equipment and provides additional requirements relating to the interface between users and computer-based systems onboard, as well as product design and development requirements for new devices before their implementation onboard ships. This revision includes requirements for the suppliers to demonstrate compliance with the requirements in this UR.

## Part A. Revision History

Version no.	Approval date	Implementation date when applicable
Rev.1 (Sep 2023)	18 September 2023	01 July 2024
New (Apr 2022)	11 April 2022	01 January 2024*

\*New UR E27 was withdrawn before coming into force on 1 January 2024 (Ref: 22094\_IGm)

### • Rev.1 (Sep 2023)

#### 1 Origin of Change:

- Other (12<sup>th</sup> IACS Cyber Systems Panel meeting)

#### 2 Main Reason for Change:

Develop IACS unified requirements for verification and survey of cyber physical systems to ensure compliance with IACS UR E27.

#### 3 List of non-IACS Member classification societies contributing or participating in IACS Working Group:

JWG/Cyber systems

#### 4 History of Decisions Made:

During the 12th meeting of the IACS Cyber Systems Panel held September 21-23, 2021, following former discussions and request from GPG, the Cyber Panel agreed to form PTPC07 to develop requirements for verification, survey and audit in newbuilding and operational phase of cyber physical systems and vessels to ensure compliance with IACS UR E26 and UR E27. Executive summary of the history, such as internal decisions made, meeting minutes, reference to Form A or Form 1.



The objectives for PTPC07 have been defined in Form A as follows: "Establish common requirements for verification activities to ensure a harmonized practice for compliance with UR E26 and UR E27."

Further, it was decided by the Cyber Systems Panel in January 2023 that PTPC07 shall propose resolution of industry feedback to UR E26 and UR E27 ("pilot phase comments").

IACS officially released the unified requirements UR E26 "Cyber Resilience in Ships", and UR E27, "Cyber Resilience Equipment and Systems", in the month of April in the year 2022, with scheduled implementation date of 01 January 2024.

Given the relatively nascent nature of the subject matter in maritime sector, an imperative need to establish a standardized approach to survey requirements was envisaged and the aforementioned unified requirements underwent a meticulous revision, to incorporate survey requirements. Industry feedback on URs were also suitably addressed in revised URs (now referred to as Rev1) slated to come into effect on 01 July 2024.

During the course of development of UR Rev1, considering the challenges in implementation of the new cyber requirements in smaller vessels, falling under IACS's scope of applicability as delineated in "IACS General Procedures Volume 1 Chapter A Introduction- para 2 IACS's scope of interest," the applicability of these unified requirements was bifurcated as mandatory compliance for one category of vessels and non mandatory compliance for another category, in accordance with reference GPG mail 18197b.

Recognizing the intrinsic interrelationship between IACS UR E27 and UR E26, the scope of applicability of both URs and to eliminate any potential confusion which could arise within the industry, due to availability of two versions of same UR with different implementation date a strategic decision was taken to withdraw the original (new) version of UR E26 and UR E27, as initially published in the year 2022 which requires mandatory application to all ships contracted for construction from 01 January 2024.

This strategic approach also eliminates any conceivable perplexity in Industry that might arise from having two distinct versions/revisions of the same URs, characterized by a six-month variance in their implementation dates, divergent scopes of applicability, and supplementary survey information available through the official IACS website.

## **5 Other Resolutions Changes:**

UR E26 may be impacted, for cross-reference purposes.

## **6 Any hinderance to MASS, including any other new technologies:**

In the development of this UR, consideration has been given so as not to hinder the development of new or improved technologies providing an equivalent or higher level of safety.

## **7 Dates:**

Original Proposal : Proposed by CS Panel  
Panel Approval : 8 August 2023 (Ref: PC21008\_ICzk)  
GPG Approval : 19 September 2023 (Ref: 22094\_IGm)

### **• New (Apr 2022)**

\*New UR E27 was withdrawn before coming into force on 1 January 2024 (Ref: 22094\_IGm)

#### **.1 Origin of Change:**

Other

#### **.2 Main Reason for Change:**

None

#### **.3 List of non-IACS Member Classification Societies contributing or participating in IACS Working Group:**

None

#### **.4 History of Decisions Made:**

During the 9th meeting of the IACS Cyber Systems Panel held in March 22-25, 2020, following former discussions and request from GPG, the Cyber Panel agreed to form a PT to develop Unified Requirement Cyber resilience of on-board systems and equipment. Executive summary of the history, such as internal decisions made, meeting minutes, reference to Form A or Form 1.

The objectives for this PT have been defined in Form A as follows:

“To establish cyber resilience unified requirements for on-board systems and equipment towards cyber security”

#### **.5 Other Resolutions Changes**

UR E22 and UR E26 may be impacted, for cross-reference purposes.

#### **.6 Any hinderance to MASS, including any other new technologies:**

In the development of this UR, consideration has been given so as not to hinder the development of new or improved technologies providing an equivalent or higher level of safety.

**.7 Dates:**

Original Proposal : December 2019

Panel Approval : September 2021

GPG Approval : 11 April 2022 (Ref: 18197aIGz, 20063bIGs)

## **Part B. Technical Background**

List of Technical Background (TB) documents for UR E27:

Annex 1. **TB for New (Apr 2022)**

See separate TB document in Annex 1.

Annex 2. **TB for Rev.1 (Sep 2023) – Survey requirements**

See separate TB document in Annex 2.

Annex 3. **TB for Rev.1 (Sep 2023) – Pilot phase Comments**

See separate TB document in Annex 3.

## **Technical Background (TB) document for UR E27 (New Apr 2022)**

### **1. Scope and objectives**

The aim of this resolution is to establish cyber resilience unified requirements for onboard systems and equipment. The requirements specified in this UR are applicable to computer-based systems as defined in IACS UR E26.

This UR does not cover environmental performance for the system hardware and the functionality of the software. In addition to this UR, following URs shall be applied:

- UR E10 for environmental performance for the system hardware
- UR E22 for safety of equipment for the functionality of the software

### **2. Engineering background for technical basis and rationale**

The evolving technology of surface vessels, container terminals, etc. and increased reliance upon Operational Technology (OT) and Information Technology (IT) convergence has created an increased possibility for attacks to affect personnel data, human safety, the safety of the ship, and to threaten the marine environment.

Attackers may target any combination of people and technology to achieve their aim, wherever there is a network connection or any other interface between onboard systems and the external world. Safeguarding shipping from current and emerging threats involves a range of measures that are continually evolving.

Currently the computer-based systems (CBS) are required to be tested according to UR E10 for Category II and Category III systems. However, as UR E10 specifies only environmental test requirements, the cyber security performance is not addressed.

It is then necessary to establish set requirements for cyber resilience of systems and equipment to be used on-board.

The cyber incidents considered in this resolution are events resulting from any offensive manoeuvre that targets OT systems onboard ships.

### **3. Source/derivation of the proposed IACS Resolution**

The development of this resolution starts from the experience and knowledge acquired in the development of Recommendation 166 on cyber resilience of ships (IACS Recommendation 166).

IEC 62443-3-3 and IEC 62443-4-2 standards have been referred for development of this UR. The 62443 series of standards aim to improve the safety, availability, integrity and confidentiality of systems or components used for industrial automation and control and to provide criteria for procuring and implementing

secure industrial automation and control systems.

IEC 62443-3-3 standard is part of IEC 62443 series to describe the System security requirements and security levels. The principal audience for this standard is intended to be asset owners, system integrators, product suppliers, service providers and, where appropriate, compliance authorities.

The requirements defined in this UR are derived from foundational requirements (FR) and subsequent system requirements (SR) described in IEC 62443-3-3 and IEC 62443-4-2 standards.

Whereas ISA/IEC 62443-3-3 standard have a robust, articulated and target-based definition of security levels (SLs), using SLs in this resolution in the same way and based on the same principles appear to be not compatible as the UR is set to provide minimum requirements. In this light, minimum set of requirements are extracted from IEC 62443-3-3 and defined in this UR. However, as the cyber attack surface has major impact on system/component cyber security, this aspect has been considered while identifying the requirements as detailed in this document. IACS UR E22 is referred for basic system categorization. It has been clarified that navigation and communication requirements will continue to follow existing IEC 61162-460 Standards.

This resolution has been designed to be open to future developments, to meet possible future evolution and improvements and continuously provide more and more appropriate answers to industry expectations e.g. on systems connectivity, digitalization and smart shipping.

#### **4. Summary of Changes intended for the revised Resolution:**

None

#### **5. Points of discussions or possible discussions**

None

#### **6. Attachments if any**

None

## **Technical Background (TB) document for UR E27 (Rev.1 Sep 2023)**

### **Survey requirements**

#### **1. Scope and objectives**

Form A specified four work items, summarized as follows:

- a) Specify verification activities of cyber physical systems delivered by product suppliers.
- b) Specify verification activities of integration, architecture and implementation by shipyards or system integrators.
- c) Specify verification activities of cyber security management during operation.
- d) Establish guidance for acceptance criteria, compensating countermeasures, test methods and application of alternative standards.

#### **2. Engineering background for technical basis and rationale**

Since UR E27 specifies requirements for cyber physical systems delivered by product suppliers, it was decided that UR E27 Rev.1 should address item I and IV in Form A.

Furthermore, it was decided that UR E27 Rev.1 should specify requirements to how product suppliers shall demonstrate compliance with the requirements of UR E27. Hence, it should not specify how the classification societies shall carry out verification activities.

It was considered important to ensure the classification process specified in UR E27 is not in contradiction with UR E22.

Finally, it was considered important to rectify any faults or inconsistencies that may have been overlooked in the development of the original version of UR E27.

#### **2a. Specification of the data utilised in the development/revision of the proposed IACS Resolution, if any**

None

#### **3. Source/derivation of the proposed IACS Resolution**

None

#### **4. Summary of Changes intended for the revised Resolution:**

None

## 5. Points of discussions or possible discussions

### 5.1 IEC 63154 as alternative standard for navigation and radiocommunication systems

The application of alternative standards in lieu of UR E27 was discussed. An inconsistency was found in that UR E26 referred to IEC 61162-460 or IEC 63154 as alternative standards, whereas UR E27 referred to only IEC 61162-460. During the development of UR E27 Rev.1 it was understood that IEC 63154 refers to IEC 61162-460 as a normative standard, and consequently it would have been more appropriate to specify both IEC 61162-460 and IEC 63154 as an alternative to UR E27. However, this was considered too excessive, and it was decided to not mention IEC 63154 as an alternative standard.

### 5.2 IEC 61162-460 as alternative standard for navigation and radiocommunication systems.

It was proposed by PTPC07 that UR E26/UR E27 should be "agnostic" with respect to application of alternative standards, and the following text was accepted by the CS Panel:

*"For navigation and radiocommunication systems, the application of other equivalent standards in lieu of the required security capabilities in UR E27 section 4 may be accepted by the Society, on the condition that requirements in UR E26 are complied with."*

However, it was then learned that IEC TC80 was in progress of updating IEC 61162-460 with the aim to meet the requirements of UR E26 chapter 4. To acknowledge this work, the following text was decided:

*"For navigation and radiocommunication systems, the application of IEC 61162-460 or other equivalent standards in lieu of the required security capabilities in UR E27 section 4 may be accepted by the Society, on the condition that requirements in IACS UR E26 are complied with."*

### 5.3 Additional security capabilities

The requirements in UR E27 section 4.2 applies for computer-based systems that will communicate with systems or networks outside the scope of UR E26 (untrusted networks).

Given that the technical requirements in UR E27 are derived from IEC 62443-3-3, it was questioned why UR E27 does not include relevant requirements in FR5 of IEC 62443-3-3 (segmentation of security zones and conduits traversing zone boundaries).

It was assumed that such requirements were omitted from UR E27 since these are specified in UR E26 section 4.2.1 and are primarily under the responsibility of the shipyard/system integrator.

However, for product suppliers delivering systems with e.g. remote support capabilities, UR E27 would not specify all required security capabilities. Therefore, it was decided to add the following sentence after the first paragraph of section 4.2:



*"CBSs with communication traversing the boundaries of security zones shall also meet requirements for network segmentation and zone boundary protection in UR E26 section 4.2.1 and 4.2.2."*

#### 5.4 Documentation requirements

The original version of UR E27 specified in section 3 the documents to be submitted by the supplier.

The revised UR E27 includes a more detailed description of this documentation. To minimize changes to the original version of UR E27, this detailed description was added in the new section 6.2 (Plan approval) and referred to section 3, for consistency.

It was commented that this cross referencing is difficult to read and therefore it was decided that the new detailed description is moved to- and merged with section 3.

#### **6. Attachments if any**

None

## **Technical Background (TB) document for UR E27 (Rev.1 Sep 2023)**

### **Pilot phase**

#### **1. Scope and objectives**

When IACS UR E26 and UR E27 were published in April of 2022, it was decided that the period until mandatory implementation should be considered a "pilot phase" and consequently that feedback from the industry should be considered in a possible revision of the URs.

#### **2. Engineering background for technical basis and rationale**

To allow classification societies sufficient time for implementation of the revised UR E26 and UR E27 it was decided that cutoff date for considering feedback from the industry should be set to December 1st. 2022.

In the evaluation of the feedback from the industry it was decided to categorize the consolidated result of each comment as follows:

- Clarification (no change)
- Suggestion for improvement

#### **2a. Specification of the data utilised in the development/revision of the proposed IACS Resolution, if any**

None

#### **3. Source/derivation of the proposed IACS Resolution**

None

#### **4. Summary of Changes intended for the revised Resolution:**

None

#### **5. Points of discussions or possible discussions**

##### **5.1 Definition of audit**

It was suggested to add definition of Audit in UR E27 to ensure the reader will understand that terms such as "audit records" and "auditable events" in UR E27 have different meaning than "audit" required by the ISM Code. It was decided to not add the definition in UR E27, but instead clarify possible uses of the term "audit" in this TB:

IACS Procedural Requirements for ISM Code Certification: "Audit" means a

process of systematic and independent verification, through the collection of objective evidence, to determine whether the SMS complies with the requirements of the ISM Code and whether the Safety Management System (SMS) is implemented effectively to achieve the Code's objectives.

IEC 62443-3-3:2013 "Auditable events": The purpose of this requirement is to record the occurrence of important events which need to be audited as significant and relevant to the security of the control system.

IEC 62443-4-1:2018 "audit log": event log that requires a higher level of integrity protection than provided by typical event logs.

IEC 62443-1-1: 2009 "security audit": independent review and examination of a system's records and activities to determine the adequacy of system controls, ensure compliance with established security policy and procedures, detect breaches in security services, and recommend any changes that are indicated for countermeasures [8].

## 5.2 Relationship with IEC 62443-3-3

It was decided in the 14<sup>th</sup> CS panel meeting that the relationship between the requirements in UR E27 section 4 should be clarified by applying one of the following options:

- Change the text in UR E27 to align with the text in IEC 62443-3-3
- Add a note in UR E27 to clarify the relationship

The second alternative was decided during the development and hearing process of UR E27, and it was decided to add the following note to section 4:

*"The requirements in this section are based on the selected requirements in IEC 62443-3-3. To determine the full content, rationale and relevant guidance for each requirement, the reader should consult the referenced standard."*

The classification societies may choose to enforce the requirement text as specified in UR E27 (taking into consideration the rationale in the IEC standard), or they may choose to follow the text in IEC 62443. This should make a significant difference. The following main differences were identified:

- Item 10 / SR 2.3: The note in UR E27 allows for compliance based only on physical port blockers. If the IEC 62443-3-3 is followed, the system itself should have capabilities to disable such ports, prevent use by unauthorized users, or prevent/restrict transfer of data to/from such devices. If these requirements cannot be met, it is fully possible to accept non-compliance based on compensating countermeasures such as physical port blockers. This should then be documented and informed to the Shipowner so that this can be incorporated into the policy and procedure for handling mobile and portable devices.

- Item 13 / SR 2.8: The following events are not listed in E27: request errors, control system events, potential reconnaissance events, audit log events. Also, E27 does not specify the content of the audit records (timestamp, source, category, type, event ID, event result.)
- Item 17 / SR 3.1: E27 includes "Note: Cryptographic mechanisms shall be employed for wireless networks". This is possibly quite OK since such encryption is believed to be part of "commonly accepted industry practices" in SR 2.2.
- Item 21 / SR 4.1: E27 includes "Note: Cryptographic mechanisms shall be employed for wireless networks". This is possibly quite OK since such encryption is believed to be part of "commonly accepted industry practices" in SR 2.2.

### 5.3 Secure development lifecycle (SDL) requirements

It was questioned how the classification societies would apply the SDL requirements for computer-based systems that are developed before the SDL requirements became mandatory.

Some of the requirements are not specifically related to the development process whereas other requirements may be enforced following a reasonable and practicable approach.

It may be noted that the seven SDL requirements in UR E27 are to some extent lacking the complete context since the majority of the requirements in IEC 62443-4-1 are not implemented in UR E27.

### 5.4 Definition of computer-based network

The definition of computer-based network was discussed in the 14th CS Panel meeting.

It was agreed to use the same definition in UR E26 and E27:

*"Computer Network: A connection between two or more computers for the purpose of communicating data electronically by means of agreed communication protocols."*

It was also proposed to add the following sentence:

*"Networks within a computer are not necessarily dealt with as computer network."*

The reason for the amended sentence was to allow for unmanaged network switches to be used within CBSs delivered by suppliers, even if such switches do not support many of the requirements in UR E26 and UR E27 (e.g. item 1 in Table 1).

It was decided in the 15th CS panel meeting that the amended sentence is not needed due to the following reasons:

- If a device in a CBS does not have human user interface, then the requirements related to human user interface is not applicable (e.g. item 1 in table 1), hence such requirements would not prevent the use of an unmanaged switch.

An unmanaged network switch cannot provide functionality to protect

- against excessive network traffic. Ref. UR E26 section 4.2.2.1/4.3.1.3 and UR E27 item 24. However, if such protection functions can be implemented in the endpoints of the network (e.g. in the PLCs and HMI-devices), then it would be acceptable to use unmanaged switch in a CBS.
- An unmanaged network switch cannot provide functionality to prevent connection of mobile/portable devices to the network. Ref. UR E26 section 4.2.7 and UR E27 item 10. However, this should be acceptable if the network switch and all its connected devices are installed in a locked cabinet and/or in an area with control of physical access. In addition, unused ports should be physically blocked.

## **6. Attachments if any**

None

# IACS

INTERNATIONAL ASSOCIATION OF CLASSIFICATION SOCIETIES LTD.

PERMANENT SECRETARIAT: 4 Matthew Parker Street

Westminster, London SW1H 9NP, UNITED KINGDOM

TEL: +44(0)207 976 0660

INTERNET: [permsec@iacs.org.uk](mailto:permsec@iacs.org.uk) Web Site: [www.iacs.org.uk](http://www.iacs.org.uk)

---

Nov 2023

## History Files (HF) and Technical Background (TB) documents for URs concerning Fire Protection (UR F)

Res. No.	Title	Current Rev.	HF/TB?
UR F1	Cathodic protection on oil tanker	Rev.1 Jun 2002	No
UR F2	Aluminium coating on board oil tankers and chemical tankers	Rev.2 Nov 2012	HF
UR F3	Tank cleaning openings	1971	No
UR F4		Deleted (1987)	No
UR F5	Pump room alarms	Rev.1 1973	No
UR F6	Standardization of Flash Points	Rev.1 1996	No
UR F7	Portable instruments for measuring oxygen and flammable vapour concentrations	Corr.1 Nov 2020	HF
UR F8	Pressurisation of cargo tanks	Rev.1 1989	No
UR F9	Lighting and sighting ports in pump room/engine room bulkheads	Deleted Dec 2013	No
UR F10		Deleted (1986)	No
UR F11		Deleted (1986)	No
UR F12		Deleted	No
UR F13	Gland seals in pump room bulkheads	Rev.1 1977	No
UR F14		Deleted (1996)	No
UR F15	Reinforced thickness of ballast and cargo oil piping	Rev.7 Sep 2023	HF

Res. No.	Title	Current Rev.	HF/TB?
UR F16	Bow and stern loading and unloading arrangements on oil tankers	Rev.1 Jun 2000	No
UR F17		Deleted (1996)	No
UR F18		Deleted (1997)	No
UR F19		Deleted (1998)	No
UR F20	Inert gas system	Rev.7 May 2015	HF
UR F21	Pump room ventilation	1974	No
UR F22	Direct loading pipes to oil tanker cargo tanks	1974	No
UR F23		Deleted (1996)	No
UR F24	Temperature of Steam and Heating Media within the Cargo Area	Rev.2 May 1998	No
UR F25		Deleted	No
UR F26	Safety aspects of double bottoms and duct keels under cargo oil tanks	Rev.3 May 2004	TB
UR F27	Cargo openings in the bottoms of topside tanks of ships carrying alternatively oil and grain	1978	No
UR F28		Deleted (1987)	No
UR F29	Non-sparking fans	Rev.6 Jun 2005	TB
UR F30	Emergency fire pumps in cargo ships	Deleted (Feb 2002)	TB
UR F31	Fire prevention for unattended machinery spaces	Deleted	No
UR F32	Fire detecting system for unattended machinery spaces	1976	No
UR F33	Prohibition of carriage in fore peak tanks of oil or other liquid substances which are flammable	1981	No
UR F34		Deleted July 2010	No
UR F35	Fire protection of machinery spaces	Rev.8 Jun 2005	TB
UR F36		Deleted (1989)	No
UR F37	CO2 and halon containers - testing and survey	Deleted (May 1998) <i>Re-categorised to Rec 53.1</i>	No
UR F38	Survey and testing of foam concentrates	Deleted (May 1998) <i>Re-categorised to Rec 53.2</i>	No
UR F39	Measures to prevent explosions in cargo pump rooms on oil tankers	Deleted (Jul 2002)	TB

<b>Res. No.</b>	<b>Title</b>	<b>Current Rev.</b>	<b>HF/TB?</b>
UR F40	Combined use of pumps for essential services of non-continuous nature in ships of 500 GRT and above	Deleted (1997)	No
UR F41	Sea intakes for fire pumps on ships with ICE class	1993	No
UR F42	Fire testing of flexible pipes	Deleted (Nov 2023)	HF
UR F43	Installation Requirements for analysing units for continuous monitoring of flammable vapours	Rev.2 Jun 2002	TB
UR F44	Fore peak ballast system on oil tankers	Rev.2 Oct 2010	HF
UR F45	Installation of BWMS on-board ships	New June 2021	HF
UR F46	Low pressure CO <sub>2</sub> piping system	New Aug 2021	HF



## UR F2 “Aluminium Coatings on Board Oil Tanker and Chemical Tankers”

### Part A. Revision History

Version no.	Approval date	Implementation date when applicable
Rev.2 (Nov 2012)	21 November 2012	1 January 2014
Corr.1 (March 1999)	04 March 2012	-
Rev.1 (May 1998)	28 May 1998	-
NEW (May 1971)	<i>No records</i>	-

#### • Rev.2 (Nov 2012)

##### .1 Origin for Change:

- Suggestion by IACS Member/ CSR PT2

##### .2 Main Reason for Change:

- To align UR F2 with CSR-DHOT, per KC695.

##### .3 List of non-IACS Member classification societies contributing through the TC Forum and/or participating in IACS Working Group:

None

##### .4 History of Decisions Made:

At 12<sup>th</sup> Hull Panel Meeting, it was agreed by the Hull Panel to amend UR F2 to align it with CSR-DHOT.

For Technical Background, see Annex 1.

##### .5 Other Resolutions Changes

None

##### .6 Dates:

Original proposal: 20 September 2011 Made by: Hull Panel Chair

Panel Approval: 01 October 2012 by: Hull Panel

GPG Approval: 21 November 2012 (12172\_IGc)

#### • Corr.1 (March 1999)

It was found that the text of UR F2 Rev.1 in clean version was not the same of the underlined version. As the UL version of UR F2 Rev.1 was adopted by Council the clean

version must have the same text. Therefore the clean version was corrected accordingly.

- **Rev.1 (May 1998)**

Addressed a use of aluminium pipes in hazardous areas on open deck, inerted cargo tanks and ballast tanks.

Adopted by C37.

- **NEW (1971)**

No history available.

## **Part B. Technical Background**

List of Technical Background (TB) documents for UR F2:

Annex 1. **TB for Rev.2 (Nov 2012)**

See separate TB document in Annex 1.



**Note:** *There are no Technical Background (TB) documents available for the original resolution (1971), Rev.1 (May 1998), or Corr.1 (March 1999).*

**TECHNICAL BACKGROUND DOCUMENT  
IACS UR F2 (REV.2, Nov 2012)**

**1. Scope and objective**

To align UR F2 with CSR-DHOT.

**2. Background**

Knowledge Center Item 695 was created to clarify the differences between CSR-DHOT and UR F2 regarding aluminum coatings. In June 2008, an answer was approved for KC 695, indicating that there was in fact inconsistency between the documents and that one or the other would be updated to ensure consistency. At the suggestion of the CSR PT2 at the 12<sup>th</sup> Hull Panel Meeting, the Hull Panel agreed that UR F2 should be amended to align with CSR-DHOT.

**3. Points of discussions or possible discussions**

- Aluminum limit and testing procedure
  - CSR-H DHOT allows for coatings with greater than 10% Al, if “it has been shown by appropriate tests that the paint to be used does not increase the incendiary sparking hazard.”
  - However, this clause was not included in this revision of UR F2 because the Hull Panel Members had limited experience with coatings with greater than 10% Al and the testing procedures for such coatings. In the absence of an Industry Standard test procedures, the Hull Panel preferred to set a strict upper limit of 10% Al limit.

**4. Source/derivation of proposed requirements**

- CSR-DHOT, Section 6 2.1.3.1

Submitted by Hull Panel Chairman  
[01 Oct 2012]

## UR F7 “Portable instruments for measuring oxygen and flammable vapour concentrations”

### Summary

UR F7 has been corrected to clarify the application statement so that it clearly only applies to new construction.

### Part A. Revision History

Version no.	Approval date	Implementation date when applicable
Corr.1 (Nov 2020)	20 November 2020	-
Rev.3 (June 2020)	13 June 2020	1 July 2021
Rev.2 (May 1999)	May 1999	-
Rev.1 (1989)	1989	-
New (1971)	1971	-

- **Corr.1 (Nov 2020)**

#### 1 Origin of Change:

- Suggestion by IACS member

#### 2 Main Reason for Change:

To clarify that there was no intention to retroactively apply the Rev.3 to existing ships.

#### 3 List of non-IACS Member classification societies contributing or participating in IACS Working Group:

None

#### 4 History of Decisions Made:

The application statement was updated to included the phrase “on ships contracted for construction on or after 1 July 2021”.

#### 5 Other Resolutions Changes:

None

#### 6 Any hinderance to MASS, including any other new technologies:

None

**7 Dates:**

Original Proposal: 04 August 2020  
Panel Approval: 09 November 2020 (Ref: 20080\_Psb)  
GPG Approval: 20 November 2020 (Ref: 20080\_IGf)

• **Rev.3 (June 2020)**

**1 Origin of Change:**

Suggestion by IACS member

**2 Main Reason for Change:**

To distinguish between portable gas detectors capable of measuring flammable vapour concentrations in air and it capable of flammable vapour concentrations in inerted atmosphere.

To incorporate the content of UI SC149.

**3 List of non-IACS Member classification societies contributing through the TC Forum and/or participating in IACS Working Group:**

None

**4 History of Decisions Made:**

More clear distinction between gas detectors described in UR F7 was proposed within the Safety Panel by a member. After some discussion it was agreed to revise the UR F7. It was also agreed to incorporate the content of UI SC149 into UR F7.

**5 Other Resolutions Changes:**

None

**6 Any hinderance to MASS, including any other new technologies:**

None

**7 Dates:**

Original Proposal: 2 August 2017  
Panel Approval: 7 May 2020 (Ref: 20080\_PSa (PS17010o))  
GPG Approval: 13 June 2020 (Ref: 20080\_IGc)

• **Rev.2 (May 1999)**

Refer to TB document in Part B Annex 1

- **Rev.1 (1989)**

No HF&TB document available

- **New (1971)**

No HF&TB document available

\*\*\*\*\*

## Part B. Technical Background

List of Technical Background (TB) documents:

Annex 1. **TB for Rev.2 (May 1999)**

See separate TB document in Annex 1.

Annex 2. **TB for Rev.3 (June 2020)**

See separate TB document in Annex 2.



*Note: There are no separate Technical Background (TB) documents available for New (1971), Rev.1 (1989) and Corr.1 (Nov 2020).*



## **UR F7 Rev. 2**

- ♦ Objective and scope

Upgrade this UR to adequately cover oil tankers with IGS.  
Take into account SOLAS 1996 amendments to Reg. II-2/59.

- ♦ Sources of proposed requirements

UR F7

Reg. II-2/59

- ♦ Unanimous agreement achieved.

## **Technical Background (TB) document for UR F7 (Rev.3 June 2020)**

### **1. Scope and objectives**

This revision is intended to make more clear distinction between portable gas detectors capable of measuring flammable vapour concentrations in air and it capable of flammable vapour concentrations in inerted atmosphere. This revision also intended to incorporate relevant IACS UI.

### **2. Engineering background for technical basis and rationale**

The main purpose of measuring flammable vapour concentrations in air is considered to determine what percentage of gas is present relative to lower explosive limit (LEL).

Regarding measuring flammable vapour concentrations in inerted atmosphere, determining % LEL rather than % gas by volume in an atmosphere without oxygen does not make sense.

### **3. Source/derivation of the proposed IACS Resolution**

UR F7 is related to SOLAS Reg. II-2/4.5.7.1.

#### **"5.7.1 Portable instrument**

Tankers shall be equipped with at least one portable instrument for measuring oxygen and one for measuring flammable vapour concentrations, together with a sufficient set of spares. Suitable means shall be provided for the calibration of such instruments."

### **4. Summary of Changes intended for the revised Resolution:**

More clear distinction between portable gas detectors capable of measuring flammable vapour concentrations in air and it capable of flammable vapour concentrations in inerted atmosphere has been made

Content of UI SC149 which is the interpretation for SOLAS Reg. II-2/4.5.7.1 has been incorporated

### **5. Points of discussions or possible discussions**

Regarding changes for distinction between portable gas detectors, see 2. above.

Members understand that the original intent of UI SC 149 is to make a link between UR F7 and SOLAS II-2/4.5.7.1. Thus, UR F7 has been revised to incorporate UI SC149.

### **6. Attachments if any**

None

**UR F15****“Reinforced thickness of ballast and cargo oil piping”****Summary**

In Rev.7, the words “not glands” is deleted and two definitions of “expansion bends” and “heavy flanges joints” are added so as to eliminate possible misunderstanding or confusion.

**Part A. Revision History**

<b>Version no.</b>	<b>Approval date</b>	<b>Implementation date when applicable</b>
Rev.7 (Sep 2023)	12 September 2023	01 January 2025
Corr.1 (Feb 2021)	07 February 2021	-
Rev.6 (Feb 2021)	15 February 2021	1 July 2022
Rev.5 (1996)	1996	-
Rev.4 (1989)	1989	-
Rev.3	No record	-
Rev.2	No record	-
Rev.1	No record	-
New (1982)	1982	-

- **Rev.7 (Sep 2023)**

**1 Origin of Change:**

- Suggestion by IACS Member

**2 Main Reason for Change:**

In F15.1.1, it reads “*Expansion bends only (not glands) are permitted in these lines within cargo tanks for serving the ballast tanks and within the ballast tanks for serving the cargo tanks.*”. But except for “shaft gland”, “stern gland”, “inboard gland” used in SOLAS and “gas-tight gland” in IACS UR M24.4, the word “gland” is not found in any other IMO documentations or IACS documentation. Also, in the above-mentioned circumstances in SOLAS and IACS UR M24, the word “gland” does not have the meaning of expansion. This situation has caused some misunderstanding and confusion.

During discussion, one IACS Member also suggested, and was agreed by other members, to provide definitions of “heavy flanged joints” and “expansion bends” used in this UR.

**3 List of non-IACS Member classification societies contributing or participating in IACS Working Group:**

None

**4 History of Decisions Made:**

None

**5 Other Resolutions Changes:**

None

**6 Any hinderance to MASS, including any other new technologies:**

None

**7 Dates:**

Original Proposal: 05 July 2022 (Ref: PM22302\_IMa)  
Panel Approval: 29 August 2023 (Ref: PM22302\_IME)  
GPG Approval: 12 September 2023 (Ref: 23158\_IGb)

• **Corr.1 (Feb 2021)**

**1 Origin of Change:**

Suggestion by IACS Member

**2 Main Reason for Change:**

References to the latest MARPOL Regulation needed corrections and unpreferable phrase "as amended by IMO resolutions up to MEPC.314(74)" needed removal as agreed by Machinery Panel.

**3 List of non-IACS Member classification societies contributing or participating in IACS Working Group:**

None

**4 History of Decisions Made:**

None

**5 Other Resolutions Changes:**

None

**6 Any hinderance to MASS, including any other new technologies:**

None

**7 Dates:**

Original Proposal: 5 October 2021 (Ref: PM20906oIMa)  
Panel Approval: 12 November 2021 (Ref: PM20906oIMb)  
GPG Approval: 07 February 2021 (Ref: 20206aIGf)

**• Rev.6 (Feb 2021)****1 Origin of Change:**

- Other (Periodical review to reflect the latest IMO Resolutions)

**2 Main Reason for Change:**

There was a need to update this UR to reflect the latest IMO Resolutions related to MARPOL Annex I.

To take this opportunity, references to IMO instruments have been specified in the following format based upon confirmation of amendments up to the latest one:

*regulation/paragraph x.x.x of SOLAS/MARPOL/the XXX Code, as amended by resolutions MSC/MEPC.xx(xx), (...) and MSC/MEPC.xx(xx)*

**3 List of non-IACS Member classification societies contributing or participating in IACS Working Group:**

None

**4 History of Decisions Made:**

None

**5 Other Resolutions Changes:**

None

**6 Any hinderance to MASS, including any other new technologies:**

None

**7 Dates:**

Original Proposal: 28 October 2019 (Ref: PM18939\_IMd)  
Panel Approval: 9 November 2020 (Ref: PM20906\_IMf)  
GPG Approval: 15 February 2021 (Ref: 20206aIGc)

- **Rev.5 (1996)**

No history file or TB document available.

- **Rev.4 (1989)**

No history file or TB document available.

- **Rev.3**

No history file or TB document available.

- **Rev.2**

No history file or TB document available.

- **Rev.1**

No history file or TB document available.

- **New (1982)**

No history file or TB document available.

\*\*\*\*\*

## Part B. Technical Background

List of Technical Background (TB) documents for UR F15:

Annex 1. **TB for Rev.6 (Feb 2021)**

See separate TB document in Annex 1.

Annex 2. **TB for Rev.6 Corr.1 (Feb 2022)**

See separate TB document in Annex 2.

Annex 3. **TB for Rev.7 (Sep 2023)**

See separate TB document in Annex 3.



**Note:** *There are no separate Technical Background (TB) documents for the New (1982), Rev.1, Rev.2, Rev.3, Rev.4 (1989) and Rev.5 (1996).*

## Technical Background (TB) document for UR F15 (Rev.6 Feb 2021)

### 1. Scope and objectives

UR F15 (Rev.5) does not reflect the latest IMO Resolutions related to MARPOL Annex I. Rev.6 has been developed to correct references to the regulation of MARPOL Annex I.

### 2. Engineering background for technical basis and rationale

**Format for references to IMO instruments** (where the number of amendments is large)

**Format:**

*regulation/paragraph x.x.x of SOLAS Chapter X/MARPOL Annex X/the XXX Code, as amended by IMO resolutions up to MSC.xx(xx)/MEPC.xx(xx)*

### The change of the title of UR F15

It was agreed that the title of UR F15 "Piping passing through dangerous zones" should be modified to "Reinforced thickness of ballast and cargo oil piping".

### 3. Source/derivation of the proposed IACS Resolution

None

### 4. Summary of Changes intended for the revised Resolution:

UR F15 has been updated to reflect the latest IMO Resolutions related to MARPOL Annex I as follows:

<b>Regulations of MARPOL Annex I before the amendment adopted by Resolution MEPC.117(52)</b>	<b>Replaced by regulations of MARPOL Annex I as amended by IMO resolutions up to MEPC.314(74)</b>
MARPOL Annex 1 Reg. 13F	Regulation 19.6.3.6 of MARPOL Annex I
Unified Interpretation to Regulation 1(17)	Unified Interpretation to Regulation 1.18

### 5. Points of discussions or possible discussions

None

### 6. Attachments if any

None



## Technical Background (TB) document for UR F15 (Corr.1 Feb 2022)

### 1. Scope and objectives

To correct an editorial error (reference to the latest MARPOL Regulation) and to remove an unpreferable phrase for references to IMO instruments.

### 2. Engineering background for technical basis and rationale

None

### 3. Source/derivation of the proposed IACS Resolution

None

### 4. Summary of Changes intended for the revised Resolution:

UR F15 has been corrected to fix the reference to MARPOL Regulation and to remove an unpreferable phrase "*as amended by Resolutions up to [...]*" as follows:

UR F15 Rev.6	UR F15 Rev.6 Corr.1
Regulation 19.6.3.6 of MARPOL Annex I as amended by IMO resolutions up to MEPC.314(74)	Regulation 19.3.6 of MARPOL Annex I
Unified Interpretation to Regulation 1.18 of MARPOL Annex I as amended by IMO resolutions up to MEPC.314(74)	Unified Interpretation to Regulation 1.18 of MARPOL Annex I

### 5. Points of discussions or possible discussions

None

### 6. Attachments if any

None

## Technical Background (TB) document for UR F15 (Rev.7 Sep 2023)

### 1. Scope and objectives

In Rev.7, the words "not glands" is deleted and two definitions of "expansion bends" and "heavy flanges joints" are added so as to eliminate possible mis-understanding or confusion.

### 2. Engineering background for technical basis and rationale

In F15.1.1, it reads "*Expansion bends only (not glands) are permitted in these lines within cargo tanks for serving the ballast tanks and within the ballast tanks for serving the cargo tanks.*". But except for "shaft gland", "stern gland", "inboard gland" used in SOLAS and "gas-tight gland" in IACS UR M24.4, the word "gland" is not found in any other IMO documentations or IACS documentation. Also, in the above mentioned circumstances in SOLAS and IACS UR M24, the word "gland" does not have the meaning of expansion. This situation has caused some mis-understanding and confusion.

During discussion, one IACS Member also suggested, and was agreed by other members, to provide definition of "heavy flanged joints" used in this UR.

### 3. Source/derivation of the proposed IACS Resolution

None

### 4. Summary of Changes intended for the revised Resolution:

UR F15.1.1 was modified as follows:

“

F15.1.1 The pipes are to be of heavy gauge steel of minimum wall thickness according to the table hereunder with welded or heavy flanged joints<sup>1</sup> the number of which is to be kept to a minimum.

Expansion bends<sup>2</sup> only are permitted in these lines within cargo tanks for serving the ballast tanks and within the ballast tanks for serving the cargo tanks.

Nominal diameter (mm)	Minimum wall thickness (mm)
50	6.3
100	8.6
125	9.5
150	11.0
200 and above	12.5

<sup>1</sup>Heavy flanges joints means welded flange joints rated at least PN10 or one pressure rating higher than required design pressure, whichever is greater.

<sup>2</sup>Expansion bends means expansion loops such as an omega bend ('Ω') in piping system to counteract excessive stresses or displacement caused by thermal expansion or hull deformation which could be fabricated from straight lengths of pipe.

“

### 5. Points of discussions or possible discussions

None

### 6. Attachments if any

None

## UR F20 "Inert Gas Systems"

### Part A. Revision History

Version no.	Approval date	Implementation date when applicable
Rev.7 (May 2015)	17 May 2015	1 January 2016
Rev.6 (May 2012)	12 May 2012	1 July 2013
Rev.5 (Nov 2005)	21 November 2005	-
Rev.4 (May 2004)	31 May 2004	-
Corr.1 (Sept 2001)	03 September 2001	-
Rev.3 (May 1998)	28 May 1998	-
Rev.2 (1987)	<i>No records</i>	-
Rev.1 (1983)	<i>No records</i>	-
New (1974)	<i>No records</i>	-

- **Rev.7 (May 2015)**

**.1 Origin for Change:**

- Base on IMO Resolution MSC.367(93)

**.2 Main Reason for Change:**

To harmonize the UR with the amended FSS Code as per MSC.367(93).

**.3 List of non-IACS Member classification societies contributing through the TC Forum and/or participating in IACS Working Group:**

None

**.4 History of Decisions Made:**

The amended FSS Code Chapter 15 as per MSC.367(93) is applied to tankers, including chemical tankers, constructed on or after 1 January 2016, therefore it was necessary to harmonize the UR with the amended FSS Code. Machinery Panel approved Rev.7 of the UR during its 21st Meeting in March 2015, and approved its technical background on 2 Apr 2015.

**.5 Other Resolutions Changes**

None

**.6 Dates:**

Original proposal: 15 December 2014 made by: Machinery Panel  
 Panel Approval: the 21st Meeting held from 3rd to 6th March 15 March 2015  
 by: Machinery Panel  
 GPG Approval: 17 May 2015 (Ref. 11043\_IGf)

- **Rev.6 (May 2012)**

**.1 Origin for Change:**

- Request by non-IACS entity (Wilhelmsen Technical Solutions)

**.2 Main Reason for Change:**

To clarify the term "safe location" in F20.4.10.

**.3 List of non-IACS Member classification societies contributing through the TC Forum and/or participating in IACS Working Group:**

None

**.4 History of Decisions Made:**

IACS Statutory Panel considered the query on IACS UR F20 forwarded by the IACS PermSec under the long-standing Task 8 "Maintenance of IACS Resolutions" and developed an IACS common understanding on the term "safe location" in F20.4.10. It was unanimously decided to revise IACS UR F20 as per the agreed IACS common understanding. Final version of the revised UR and technical background documents were approved by the Statutory Panel on 25<sup>th</sup> February 2012.

Rev.6 proposed by the Statutory Panel was supported by the Machinery Panel.

**.5 Other Resolutions Changes**

None

**.6 Dates:**

Original proposal: *25 August 2011 made by: Statutory Panel*  
Panel Approval: *15 April 2012 by: Statutory panel*  
GPG Approval: *12 May 2012 (Ref. 12064\_IGb)*

- **Rev.5 (Nov 2005)**

Ref: 5030e

See TB document in Annex 1.

- **Rev.4 (May 2004)**

Outcome of (WP/FP&S) Task 1. Submitted to GPG 56. Ref: 3002d

No TB document available.

- **Corr.1 (Sept 2001)**

A member suggested correcting F 20.4.2. In F20.4.2, there is a string of references under 19. The last entry should have been "21" meaning II-2/62.21.

No TB document available.

- **Rev.3 (May 1998)**

Extended to cover N2 generators. Adopted at C37.

No TB document available.

- **Rev.2 (1987)**

No TB document available.

- **Rev.1 (1983)**

No TB document available.

- **New (1974)**

No TB document available.

## Part B. Technical Background

List of Technical Background (TB) documents for UR F20:

Annex 1. **TB for Rev.5 (November 2005)**

See separate TB document in Annex 1.



Annex 2. **TB for Rev.6 (May 2012)**

See separate TB document in Annex 2.



*Note: There are no separate Technical Background (TB) documents for Original resolution (1974), Rev.1 (1983), Rev.2 (1987), Rev.3 (May 1998), Corr.1 (Sept 2001), Rev.4 (May 2004) and Rev.7 (May 2015).*

## **Technical background UR F20 (Rev.5, Nov 2005)**

The text of the existing paragraph F20.4.15, applicable to Nitrogen Generation Systems (NGS), contains a requirement for the number of oxygen recording devices that is more stringent than the correspondent requirement applicable to other kind of Inert Gas System (IGS) as explained in the following:

1. The requirements set out in both the Fire Safety System Code and UR F20 regarding the display and recording of the oxygen content of inert gas are equivalent for IGS based on boiler flue gas and oil fired inert gas generators, i.e. display in the Cargo Control Room (CCR) and Machinery Control Room (MCR) or Machinery Space (MS) while recording is only required in the CCR, where provided, or in a position easily accessible for the officer in charge of cargo operations;
2. Paragraph F20.4.15 requires display and recording of the oxygen content of the inert gas downstream of the NGS to be placed in the CCR and MCR or MS. This requirement implies that two records on paper are maintained onboard in two different locations.
3. It should be noted that the recording device mentioned in the above is fitted with the purpose of continuously recording the oxygen content in the Nitrogen flow. This is aimed to provide with an evidence for compliance with the requirements (maximum content of Oxygen: 5% as per paragraph F20.4.6) during the operation. The purpose to indicate continuously the Oxygen content in the Nitrogen flow to the crew is assured by the display devices, placed in both the CCR and MCR or MS.
4. There is no reason for such requiring the duplication of the recording of oxygen content for the NGS only; and, therefore, it was proposed that the text of paragraph F20.4.15 should be changed and put in line with the requirement of FSS Code Chapter 15, paragraph 2.4.2.2.

Submitted by Statutory Panel  
7 Nov 2005  
(s/n 5030e)

Note by Permsec:  
GPG/Council agreed that no implementation date was needed for this revision.

## Technical Background for UR F20 Rev.6, May 2012

### 1. Scope and objectives

This revision of UR F20 is done to clarify the term "safe location" in F20.4.10 for its uniform application as per the agreed IACS common understanding.

### 2. Engineering background for technical basis and rationale

Keeping in mind that the understanding/interpretation proposed by Wilhelmsen Technical Solutions has received no strong support from the Statutory Panel Member, it was decided to develop an IACS common understanding to clarify the term "safe location" in F20.4.10 based on Members' practical experience on application of UR F20.

### 3. Source/derivation of the proposed IACS Resolution

IACS Common understanding prepared in reply to Wilhelmsen Technical Solutions' query on IACS UR F20 forwarded by the IACS PermSec.

### 4. Summary of Changes intended for the revised Resolution:

The following footnote was added to clarify the term "safe location" in F20.4.10:

\*) "safe location" needs to address the two types of discharges separately:

1. oxygen-enriched air from the nitrogen generator - safe locations on the open deck are:

- outside of hazardous area;

- not within 3m of areas traversed by personnel; and

- not within 6m of air intakes for machinery (engines and boilers) and all ventilation inlets.

2. nitrogen-product enriched gas from the protective devices of the nitrogen receiver - safe locations on the open deck are:

- not within 3m of areas traversed by personnel; and

- not within 6m of air intakes for machinery (engines and boilers) and all ventilation inlets/outlets.

### 5. Points of discussions or possible discussions

The UR was reviewed and discussed within IACS Statutory and Machinery Panels via email correspondence.

### 6. Attachments if any

None



# Annex 1 :

## Technical background documents

### **UR F 16 - Bow and stern loading and unloading arrangements on oil tankers**

*- Scope and objectives*

To take into account MSC/Circ. 474 which also deals with this subject.

*- Points of discussion*

The title has been changed to be in line with the circular and be restricted to oil tankers, as chemical and gas tankers have detailed requirements in the codes.

The acceptable segregation requirements have been extended to include those of the circular.

The location of the segregation device has been harmonized with the circular.

To be noted : the UR deals with segregation, while the circular recommendations deal with many other aspects.

### **UR F 26 - Safety aspects of double bottoms and duct keels under cargo oil tanks**

*- Scope and objectives*

To link the UR with SOLAS Reg. II-2/56.9 which also deals with duct keels.

## **Technical Background Document**

**UR F29 (Rev.6 June 2005)**

### **Non sparking fans**

Protection screens are required to prevent the entrance of foreign objects into the fan housings. The largest probabilities of origin for these foreign objects are from the open areas and the UR is amended to reflect this.

Submitted by WP/FP&S Chair  
14/01/2005

Technical Background  
To

DELETION OF F 30

&

NEW UR M 62 (Feb. 2002)

In the WP/FP+S Progress Report No.34 (March 2001), the WP/FP+S proposed to transfer three parts of F30 as interpretations (three UI SCs) and to drop the rest, as they were adequately covered by SOLAS and other interpretations.

(Task No.31: To re-formulate F30, F34 and F35 into UIs or RECs as appropriate)

The following steps have been taken:

1. GPG agreed to completely delete F30 from the Blue Book at its 50<sup>th</sup> meeting (Tokyo, March 2001);
2. GPG approved the three UI SCs 162, 163, and 164, as proposed by WP/FP+S, which were not covered by the Convention;
3. After GPG 50, LR confirmed that the WP/MCH's proposed amendment to F30.2.7 (The rooms where the pump mover...) was not contained in the Convention, however, it was already contained in LR Rules. LR had no objection to it being a UR on Machinery. Finally, GPG agreed that the proposed amendment to F30.2.7 should be classified as UR M 62 "Rooms for em'cy fire pumps in cargo ships".

- **Outcome**

1. Deletion of F30.
2. Creation of new UR M62.
3. Creation of three UI SCs 162, 163, and 164.

- **Information**

GPG agreed that F30.4.1 should be formulated as a UI if it is not dealt with in the SOLAS text.

The text was prepared by WP/MCH with due consideration to practical difficulty for larger ships in meeting M 46 inclination requirements. However, having identified a need to define "lightest seagoing condition" in the draft UI SC zzz, GPG tasked WP/FP+S to consider Members' experience of plan approval work and performance test after installation of em'cy fire pump systems in consultation with CG/LSA (Refer to the outcome of WP/FP+S Task 39).

**UR F35 Rev. 6**

♦ Objective and scope

**Solve reservations on various paragraphs.**

**Take into account SOLAS 1994 amendments to Reg. II-2/15.**

♦ Sources of proposed requirements

**UR F35**

**Reg. II-2/15**

♦ Unanimous agreement achieved.

**Technical Background**  
**F 35 (Rev.7, July 2003)**

**1. Background**

WP/FP&S undertook Task 31 “to reformulate F35 into a UI or REC as appropriate”

**2. Points of discussion**

WP/FP+S submitted a draft UI for SOLAS II-2 concerning fire protection of machinery spaces. At the same time, WP submitted a revised Recommendation No.58 “Fire Protection of Machinery Spaces”.

GPG noted that the draft UI together with the revised REC 58 resulted in deletion of UR F35. However, GPG further noted that IMO has just adopted temporary measures pending adoption of SOLAS amendments at a later stage, referring directly to UR F35 and deletion of F35 from the IACS Blue Book would cause confusion.

Finally, the proposed UI was provisionally adopted as UR F35 (Rev.7) and retained as such IMO amends SOLAS.

ABS’ proposal to retain in F35 only reg.II-2/4.2.2.4 and issue all the remaining interpretations as UIs was not supported.

\*\*\*\*\*

**UR F39 Rev. 3**

♦ Objective and scope

Solve reservations.

Take into account WP/EL work.

♦ Sources of proposed requirements

WP/EL

♦ Unanimous agreement achieved

Footnote concerning item 2, which reads "the individual Society may introduce into their Rules only one of these two options, instead of both", to be noted.

Date of submission: 21 May 1999  
By BV

## **F 39 Measures to prevent explosion in cargo pump rooms on oil tankers**

(Rev.4 May 2001 + Deletion on 30 June 2002)

### **Technical Background**

#### **a) Objective/Scope**

The objective was to have F39 aligned with the SOLAS II-2/Reg.4.5.10.1 (Res MSC.99(73)).

#### **b) History**

1) AHG/FSA submitted the results of FSA case study for evaluation and effectiveness of F 39 to GPG 46 (March 1999). This study did not suggest any amendment to F 39 and indicated that there would be little improvement of safety to be gained by interlocking the pump room lighting with the ventilation.

However, WP/EL proposed an alternative approach for F 39.2, by adding "an alarm is given ...". This was further elaborated by WP/FP+S. Draft of Rev.3 F 39 was modified by GPG during GPG 46 with addition of the Note. Council approved it in July 1999.

2) After adoption of F 39(Rev.3), IACS communicated with OCIMF, Intertanko and ICS to explain them about the content of F 39.2(ii).

3) Having taken actions under GPG 47 FUA 40 & 41 (October 1999), GPG finally submitted a document to MSC 72 (MSC 72/8/1) on 1 February 2000, proposing an alternative to the draft amendment to SOLAS II-2/63.3, which will stand from 1 July 2002 as II-2/Reg.4.5.10.1.

4) MSC 72 Report (MSC 72/23, para. 8.3): The Committee noted IACS document MSC 72/8/1..... did not agree to the proposal by IACS. IACS Observer's Recommendation No.8 was to amend UR F 39 accordingly. The revised SOLAS Ch.II-2 was adopted at MSC 73 (5 December 2000) as Res. MSC.99(73). It will be brought into force from 1 July 2002.

#### **c) Points of Discussion**

GPG noted that F 39 would be covered by the SOLAS II-2/Reg.4.5.10.1, however, F39.2.(ii) would be contradictory to the aforesaid SOLAS II-2 requirement and the two sentences in F39.3 were not covered by SOLAS II-2. To overcome this discrepancy between F39 and SOLAS, GPG decided that F39 be deleted from Blue Book as of 1 July 2002 and WP/FP&S consider transforming the 3rd and 4<sup>th</sup> sentences in F39.3 into UIs, as appropriate. See UI SC 172(August 2002).

Decision/action were taken on 18 May 2001.

\* \* \* \* \*

## UR F42 “Fire testing of flexible pipes”

### Summary

This IACS Resolution addresses the fire testing of flexible pipes and specifies test requirements for the fire test. UR F42 has been deleted as all requirements are considered by UR P2 section 12 Flexible Hoses.

### Part A. Revision History

Version no.	Approval date	Implementation date when applicable
Del (Nov 2023)	24 November 2023	-
<i>Original version</i>	1995	-

- **Del (Nov 2023)**

**1 Origin of Change:**

- Based on IACS Requirement (*Periodic review of IACS Resolutions*)

**2 Main Reason for Change:**

UR P2 considers all requirements of UR F42.

**3 List of non-IACS Member classification societies contributing or participating in IACS Working Group:**

None

**4 History of Decisions Made:**

Discussed by correspondence in the Safety Panel.

Members compared the requirements of UR P2.12 and UR F42 and agreed that UR P2.12 covers all requirements of UR F42, e.g.

- P2.12.3.5 Flexible hose assemblies constructed of non-metallic materials intended for installation in piping systems for flammable media and sea water systems where failure may result in flooding, are to be of fire-resistant type [...]. Fire resistance is to be demonstrated by testing to ISO 15540 :2016 and ISO 15541 :2016.
- Comparison of relevant requirements summarised below



UR F42	UR P2.12/ISO 15540:2016
30 min fire test	duration 30 min
Flame temperature of 800°C	temperature of flame 800 ±50°C
Flowing water at maximum service pressure or at 5 bar and subsequent pressure test to twice the design pressure	pressure during test: at least (5 ±0.2) bar or the maximum allowable working pressure (M.A.W.P.) as identified on the product
Temperature of the water at the outlet > 80°C	temperature of flowing water in: 80 ±2°C; out: max 85°C
	pressure test after fire test: hose assemblies normally two times the M.A.W.P.; compensators 1.5 times the M.A.W.P.
No leak during or after the test	test is considered as passed when the test specimen remains tight when subjected to proof pressure after flame application

**5 Other Resolutions Changes:**

None

**6 Any hinderance to MASS, including any other new technologies:**

N/A.

**7 Dates:**

Original Proposal:	29 June 2023	(Made by: Safety Panel)
Panel Approval:	23 October 2023	(Ref: PS23036bISf)
GPG Approval:	24 November 2023	(Ref: 22183gIGb)

\*\*\*\*\*

## Part B. Technical Background

**Note:** *There is no separate Technical Background (TB) document available for Del (Nov 2023) and Original version.*

**UR F43 Rev. 1**

♦ Objective and cope

Remove the undefined expression "gas tight".

♦ Sources of proposed requirements

F43

Members' proposals.

♦ Unanimous agreement achieved.

Date of submission: 21 May 1999  
By BV

## UR F44 "Fore peak ballast system on oil tankers"

### Part A. Revision History

Version no.	Approval date	Implementation date when applicable
Rev.2 (Oct 2010)	28 Oct 2010	1 Jan 2012
Rev.1 (Aug 2008)	11 Aug 2008	-
New (June 2000)	15 June 2000	-

- **Rev.2 (Oct 2010)**

**.1 Origin of Change:**

- Suggestion by an IACS member

**.2 Main Reason for Change:**

To establish unified interpretations taking into the zoning concept of hazardous areas and eliminating vague expressions in the governing documents.

**.3 List of non-IACS Member classification societies contributing through the TC Forum and/or participating in IACS Working Group:**

None

**.4 History of Decisions Made:**

The Form A was agreed in the Machinery Panel and approved by the GPG. It was agreed to carry out the task by correspondence.

**.5 Other Resolutions Changes**

IACS UI SC70

**.6 Dates:**

Original Proposal: 16 January 2007 Made by the Machinery Panel  
 Panel Approval: 23 August 2010  
 GPG Approval: 28 October 2010 (Ref: 7518\_IGe)

- **Rev.1 (Aug 2008)**

Aim of the revision was to align UR F44 with SOLAS Reg. II-1/3.1. (ref. 8628\_)

- **New (June 2000)**

WP/FP&S submitted a new draft F 44 with its 1999 annual progress report.

## Part B. Technical Background

List of Technical Background (TB) documents:

Annex 1      **TB for New (June 2000)**

See separate TB document in Annex 1.



Annex 2      **TB for Rev.1 (Aug 2008)**

See separate TB document in Annex 2.



Annex 3      **TB for Rev.2 (Oct 2010)**

See separate TB document in Annex 3.



---

## **UR F44 (New) Fore peak ballast system on oil tankers**

### *- Scope and objectives*

To harmonize the practices of IACS Societies with respect to :

- connection of fore peak tanks to the ballast system of the cargo area
- access to fore peak tanks

### *- Points of discussion*

SOLAS does not deal with ballast systems of tankers nor with hazardous areas. It only deals with access to ballast tanks adjacent to cargo tanks. It was then agreed to draft a UR rather than a UI.

The WP also agreed to make this UR applicable only to oil tankers for the time being but agreed as a second step to advise the group MP-BC-GT to further consider it.

The main discussion was on the location of the access manhole in an enclosed space.

The UR as is proposed take into account the fact that, for fore peaks separated by a cofferdam from the cargo tanks, the risk to have it hazardous is remote and the opening of a bolted manhole is unfrequent. However that risk is there and means to take measurements and to gas free the peak through this manhole are included in the UR.

-----

## TECHNICAL BACKGROUND OF UR F44

### Fore peak ballast system on oil tankers

#### - *Scope and objectives*

To harmonize the practices of IACS Societies with respect to :

- connection of fore peak tanks to the ballast system of the cargo area
- access to fore peak tanks

#### - *Points of discussion – Rev.0 (June 2000)*

1. SOLAS does not deal with ballast systems of tankers nor with hazardous areas. It only deals with access to ballast tanks adjacent to cargo tanks. It was then agreed to draft a UR rather than a UI.
2. The WP also agreed to make this UR applicable only to oil tankers for the time being but agreed as a second step to advise the group MP-BC-GT to further consider it.
3. The main discussion was on the location of the access manhole in an enclosed space.
4. The UR as is proposed take into account the fact that, for fore peaks separated by a cofferdam from the cargo tanks, the risk to have it hazardous is remote and the opening of a bolted manhole is infrequent. However that risk is there and means to take measurements and to gas free the peak through this manhole are included in the UR.

#### - *Points of discussion – Rev.1 (Aug 2008)*

1. This revision takes into account the two scenarios where the FPT is adjacent to, or separated from, the cargo tanks as per the opening statement of Rev.0 which already qualifies the FPT as being hazardous since the ballast system serving other tanks within the cargo area is connected to the FPT.
2. The essential aspect of F44 is the entry to the FPT (which is hazardous regardless of its location relative to the cargo tanks) from an enclosed space which can be hazardous (if adjacent to the cargo tanks) or non-hazardous (if separated from the cargo tanks by a cofferdam).
3. "Other" has been introduced in the opening text to take into account that a FPT which is adjacent to a cargo tank is by definition part of the cargo area.

Submitted by Statutory Panel Chair

22 July 2008

#### **Permanent Secretariat note (August 2008):**

GPG approved UR F44 Rev.1 on 11 August 2008 (ref. 8628\_IGb).

## **Technical Background for UR F44 Rev.2, Oct 2010**

### **1. Scope and objectives**

To establish unified interpretations taking into the zoning concept for hazardous areas and eliminating vague expressions in the governing documents.

### **2. Engineering background for technical basis and rationale**

IACS has agreed to accept the IEC standard 60092-502 with regard to the installation of electrical equipment in tankers. The standard introduces a zoning concept for hazardous areas and has new requirements to the electrical installations in line with generic principles laid down in the IEC 60079-series of standards for electrical installations in hazardous areas.

It has been identified that there exists several differences between SOLAS and the IEC requirements especially with the introduction of hazardous area zoning and the location of vent pipes. The intention of Revision 2 was to align both the terminology and requirements between the two documents.

### **3. Source/derivation of the proposed IACS Resolution**

SOLAS  
IEC 60092-502

### **4. Summary of Changes intended for the revised Resolution:**

The term hazardous was replaced with hazardous area to align with the terminology used within the IEC document.

The distance between vent pipe openings and sources of ignition have now been referenced to the IEC 60092-502 standard so that the hazardous area zoning classification is completed as specified within this document.

### **5. Points of discussions or possible discussions**

There was discussion on removing the requirement altogether based on one member's consideration of the likelihood of significant fuel oil leakage from an adjacent tank. However, it was observed that the same piping may be used for a ballast tank within the cargo tank area and the fore peak tank and could contain significant quantities of oil and high levels of hazardous vapour and therefore the area around the vent outlet shall be considered hazardous for a distance specified within the IEC 60092-502.

### **6. Attachments if any**

None



## UR F45 “Installation of BWMS on-board ships”

### Summary

This UR details relevant safety measures for the installation of BWMS on-board ships. This UR comes as a complement to UR M74 and focuses on the fire safety and personnel protection issues.

### Part A. Revision History

Version no.	Approval date	Implementation date when applicable
New (June 2021)	08 June 2021	01 July 2022

- **New (June 2021)**

#### 1 Origin of Change:

- Based on IACS Requirement: UR M74
- Other: Need identified at IMO SSE4 and MSC 98

#### 2 Main Reason for Change:

Many ships are currently installing BWMS on-board in line with the requirements of the BWM Convention which has entered into force on 8 September 2017.

However, BWMS are not covered by SOLAS II-2 and the relevant fire safety measures for such systems have never been clarified, leading to non-uniform safety level on-board ships. The purpose of this UR is to detail the relevant fire safety and personnel protection measures for the installation of BWMS on-board ships, in order to ensure a uniform and satisfactory safety level on-board IACS ships equipped with BWMS.

#### 3 List of non-IACS Member classification societies contributing or participating in IACS Working Group:

None

#### 4 History of Decisions Made:

The need to consider the specific fire and toxicity risks associated with BWMS was identified during IMO SSE4 and MSC98. IACS Safety Panel subsequently tasked PT PS41/2018 to develop relevant fire safety requirements for BWMS, taking into account the preliminary risk analysis carried out by PT/PM42 which was in charge of the revision of UR M74 under IACS Machinery Panel.

The Project Team has carried out a detail risk assessment considering each available BWMS technology and focusing on fire safety and personnel protection.

As a result, the Project Team has identified the safety measures detailed in UR F45.

**5 Other Resolutions Changes:**

None

**6 Any hinderance to MASS, including any other new technologies**

None

**7 Dates:**

Original Proposal: September 2017 (During 8th Safety Panel Meeting)

Panel Approval: 10 December 2020 (Ref: PS17030aISzb)

GPG Approval: 08 June 2021 (Ref: 17162\_IGv)

\*\*\*\*\*

## **Part B. Technical Background**

List of Technical Background (TB) documents:

### **Annex 1. TB for New (June 2021)**

See separate TB document in Annex 1.



## Technical Background (TB) document for UR F45 (New June 2021)

### 1 Scope and objectives

#### 1.1 Context:

Many ships are currently installing BWMS on-board in line with the requirements of the BWM Convention which has entered into force on 8 September 2017.

However, BWMS are not covered by SOLAS II-2 and the relevant fire safety measures for such systems are therefore unclear in the currently available regulations. The purpose of this UR is to detail the relevant fire safety and personnel protection measures for the installation of BWMS on-board ships, in order to ensure a uniform and satisfactory safety level on-board IACS ships equipped with BWMS.

#### 1.2 Scope

This UR specifies fire safety and personnel protection measures for BWMS installations on-board all kinds of ships, i.e. existing ships and newbuilt ships, passenger ships, ro-ro ships, general cargo, tankers, dry bulk carriers etc.

NB: Ships not designed or constructed to carry ballast water or ships carrying permanent ballast water in sealed tanks that is not subject to discharge are not subject to the BWM Convention and will therefore fall out of the scope of this UR since no BWMS will be installed on board.

This UR comes as a complement to:

- IACS UR M74 which details piping and segregation measures for BWMS installed on-board ships, covering especially the case of tankers
- SOLAS II-2: For practical purposes, SOLAS II-2 applies to any BWMR / BWMS-related space, requiring fire-detection, active and passive fire protection in line with the fire category detailed in clause 2. This UR and especially clauses 3, 4, 5, 6, 7 and 8 are meant to detail only the relevant *additional* safety measures. It is to be noted that safety measures additional to minimum SOLAS requirements are not needed for all BWMS technologies.

#### 1.3 Methodology

An initial risk assessment has been carried out by PT PM42/2017 in order to revise IACS UR M74. A number of the risks that have been identified then are covered by UR M74, the remainder – understood to be related to fire safety and personnel protection - was transmitted to PT PS41/2018. This PT has then carried out a complementary risk analysis considering each kind of BWT technologies as outlined in Table 1 of the UR and focusing on fire safety and personnel protection.

In general, it was assumed that maximum one person would be present in the BWT room during normal operation while the system is running and that two to three persons could be present in the BWT room for maintenance purposes, i.e. when the system is not running.

#### 1.4 Definitions and abbreviations

BWMS	Ballast Water Management System
Cargo ship	Any ship which is not a passenger ship

FSS amended	IMO Code for Fire Safety Systems, IMO Resolution MSC.98(73) as amended
IMO	International Maritime organization
Passenger ship	Ship which carries more than twelve passengers
Tanker	Cargo ship constructed or adapted for the carriage in bulk of liquid cargoes of an inflammable nature
SOLAS	International Convention for the Safety Of Life At Sea

## 2 Engineering background for technical basis and rationale

### 2.1 Technology analysis

#### 2.1.1 Group 1 - In line UV

No active substance: expected problems are out of the scope of this PT, reliability (UV bulb reliability) rather than safety.

Identified risks:

- High power, to be shut down in case of fire and release of the fixed fire-extinguishing system.
- Citric Acid used to wash UV lamps: to be kept away from heat as per Safety Datasheet
- Ions that may be generated by this technology are very short-lived, no specific risk expected

#### 2.1.2 Group 2 – In-line flocculation

Known flocculants are triiron tetraoxide, PAC (PolyAluminium Chloride) and PASA (Poly Acrylamide Sodium Acrylate). MEPC 59/2/5 says "The chemicals used in this system are the same as those used in drinking water purification process, and have been extensively cited in literatures relating to human health and the environment (including World Health Organization (WHO) guidelines), so there is plenty of evidence to show that they are safe."

PAC is reckoned to be corrosive to metals => coatings needed

No risk of fire (ignitability or self-reaction) identified as per MEPC 59/2/5.

Note: IMO G9 report is taken as reference rather than general REACH datasheets that are produced for other purposes, considering that IMO G9 takes into account specific technology & actual quantities and concentrations.

All 3 substances are identified as irritating and possibly harmful to human health. Contact with eyes is the most dangerous aspect.

Note: MEPC 59/2/5 "The manufacturer is therefore requested to describe separately the potential human health risks associated with each major component of the system and to describe the measures necessary to prevent human exposure for each such component."

### 2.1.3 Group 3 – De-oxygenation

In general, these technologies include an inert gas generator or a nitrogen generator, which fall under SOLAS and FSS Code requirements for inert gas systems. As a consequence:

- BWMS room containing inert gas generators are cat.A machinery spaces as per SOLAS II-2/3.31
- The requirements of FSS Code Ch.15 are to be followed as relevant

### 2.1.4 Group 4 - In-line full flow electrolysis

Limited risk is associated with the electrolysis unit (no or very low emission of H<sub>2</sub>). Neutralizers such as sodium bisulfite, sodium thiosulfate are low hazard substances.

### 2.1.5 Group 5 – In-line side stream electrolysis (Electro chlorinization)

Risk of H<sub>2</sub> build-up is to be really considered for this system, since higher intensity is needed for side-stream electrolysis, thus leading to higher H<sub>2</sub> generation.

UR M74 defines hazardous areas in §3.2.1 (reference is made to IEC 60092-502 and IACS UI SC274).

### 2.1.6 Group 6 – Chemical injection

Actual hazards will depend on the concerned chemicals, to be determined on a case-by-case basis. Consider:

- Stored chemicals & neutralizers
- Active substances that may be produced on-demand (risk is different because these substances will not be stored in significant quantity)

Expected risks to be checked (based on MSDS and adequate risk analysis):

- Toxicity (gas / irritation through breathing system)
- Toxicity (liquid / irritation through skin or eye contact)
- Toxicity through ingestion
- Fire (combustible material)
- Chemical reaction with water => possible hazard for the ship & crew
- Chemical ageing => possible hazard for the ship & crew
- Chemical reaction when exposed to high temperature => possible hazard for the ship & crew
- Reaction between several chemicals stored on board => possible hazard for the ship & crew
- Impact of chemical on steel
- ....

### 2.1.7 Group 7 – In-line side-stream ozone injection

#### 2.1.7.1 Ozone destruction

Investigated risks associated with technologies used for ozone destruction (apart from ozone leakage)

Ozone destruction can be either catalytic or thermal oxidation, i.e. degradation of ozone into oxygen. In general, no specific risk is associated with ozone destruction, except for one (not very much used) solution based on catalytic destruction of ozone through activated carbon, in case of high ozone concentration : this situation is associated with an increased risk of fire

Ozone itself being already associated with an increased risk of fire, this is already taken into account in the analysis.

#### 2.1.7.2 Ozone

The presence of Ozone is the main risk associated with those technologies as ozone is toxic and will increase the risk of fire

Ozone itself is not flammable but it may accelerate or initiate combustion (very strong oxidant)

Sodium thiosulfate is used as a neutralizer. It is a liquid chemical with limited hazard, which is also used for electrolysis technologies.

#### 2.1.8 Group 8 – In-tank pasteurization and de-oxygenation with N2 generator

In addition to N2 injection, it is noted that this system includes heat exchangers / heaters, intended to raise the temperature of the ballast water to 72°C for 75s for pasteurization purposes. The heat exchangers themselves are not considered a significant fire risk, however, the heat source (e.g. boiler or steam generator) is a significant fire risk and is to be located in a cat.A machinery space. Assumption is that the heat source (to be adequate to meet the heating capacity requirements) is another/existing ship equipment, already covered by SOLAS / FSS Code.

It is understood that, if installed in a non-dedicated machinery space (e.g. engine room), the hot piping will be shielded from fuel projection etc. Similarly, thermal insulation of hot surfaces (for crew safety) is already required on a standard basis.

### 2.2 Risk assessment – Outcome of expert workshop

The outcome of the risk assessment performed during the expert workshop is detailed in Table 1 below. For ease of reading:

- Grey background refers to safety measures that are already properly specified in SOLAS, FSS Code or UR M74 and which, as a consequence, are not repeated in the present UR F
- Note (1) means “depending on the analysis of the chemicals”

In addition to the safety measures specific for each BWMS technology, the following general principles have been identified:

- In case a foam or gas fixed fire extinguishing system is installed, it must be compatible with seawater (in case of leakage in the ballast water piping, sea water will enter the compartment)
- Automatic BWMS shutdown upon release of the fire extinguishing system (any requirement for cooldown necessary for safe shutdown to be considered in the shutdown sequence).
- In case the BWMS is located in a space covered by a fixed gas fire-extinguishing system, air or O2 storage is to be included in the gas capacity calculation.

Table 1: Outcome of the expert workshop

BWMS's Technology category →	1	2.1	2.2	3a	3b	3c	4	5	6.1	6.2	7a	7b	8
Identification of specific hazards ↓	In-line UV including UV + Advanced Oxidation Technology (AOT) or UV + TiO2 or UV + Plasma	In-line Flocculation (ex. ClearBallast™) <b>BWT machinery</b>	In-line Flocculation (ex. ClearBallast™) <b>BWT polymer storage</b>	In-line membrane separation and de-oxygenation (injection of N2 from a N2 Generator) ex. Ni-Ballast™	In-line de-oxygenation (injection of Inert Gas from Inert Gas Generator) ex. VOS™	In-tank de-oxygenation with Inert Gas Generator ex. GLD™	In-line full flow electrolysis (ex. ElectroClean™)	In-line side stream electrolysis (ex. HiBallast™)	In-line (stored) chemical injection (ex. JFE BallastAce® with NeoChlor Marine® or TG Ballast Cleaner®) : <b>BWT machinery</b>	In-line (stored) chemical injection (ex. JFE BallastAce® with NeoChlor Marine® or TG Ballast Cleaner®) : <b>BWT chemical storage</b>	In-line side-stream ozone injection without gas/liquid separation tank and without Discharge treatment tank (ex. NK-O3 BlueBallast)	In-line side-stream ozone injection with gas/liquid separation tank and Discharge water treatment tank (ex. FineBallast®OZ)	In-tank pasteurization and de-oxygenation with N2 Generator ex. BAWAT™
Fire growth potential: acceptable spaces outside cargo area for the location of the BWMS (accommodation spaces, service spaces, control stations, machinery spaces of category A, other machinery spaces, Ro-Ro spaces, etc)	No restriction	Not to be located in accommodation area, if identified as toxic or flammable as per IMO G9 report		No restriction						Depending on the chemicals (i.e. toxic or flammable products): Not to be located in the accommodation area Depending on the chemicals, minimum distance from the accommodation to be defined	Separate / dedicated compartment with gastight boundaries Room-in-room (=only one access through ER + ER alarm repeated in the BWMR) in ER could be OK (airlock required)	No restriction	
Containment of fire: fire categorization of the BWMS room and fire integrity of the boundaries with adjacent spaces	Auxiliary machinery space having little or no fire risk on PAX >36 Other machinery space on other kinds of ships	To be considered as a store-room (category will then depend on whether they contain flammable liquids and on the size of the space)		Auxiliary machinery space having little or no fire risk on PAX >36 Other machinery space on other kinds of ships	Cat.A machinery space			Auxiliary machinery space having little or no fire risk on PAX >36 Other machinery space on other kinds of ships	Auxiliary machinery space having little or no fire risk on PAX >36 Other machinery space on other kinds of ships	To be considered as a store-room (category will then depend on whether they contain flammable liquids and on the size of the space)	Auxiliary machinery space having little or no fire risk on PAX >36 Other machinery space on other kinds of ships	Auxiliary machinery space having little or no fire risk on PAX >36 Other machinery space on other kinds of ships	
Fire categorization and fire integrity when located in the cargo area of tankers	Cat. (8)		Not allowed			Cat. (8) NB: This equipment would have to be certified safe			Cat. (8) Cat. (8) if allowed in the cargo area (For products are covered by the IBC Code, check compatibility and possible interactions with the cargo)		Not allowed		Cat.(8)
Prevention against fire: Fire detection	Not required		As per SOLAS	Not required	In line with FSS Code Ch.9 Smoke and flame or smoke and heat			Not required		As per SOLAS	Fire detection Combined smoke and flame or smoke and heat	Not required	
Fire fighting: fixed fire fighting system in the BWMS room	Not required		Required by SOLAS	Not required	Fixed fire ext. system for Cat.A machinery space			Not required		As per SOLAS	Require a fixed fire-extinguishing system (manual)	Not required	
Fire fighting: portable fire fighting equipment in the BWMS room	Portable fire extinguisher suitable for electrical fire	Nothing specific	Required by SOLAS	Nothing specific	Portable foam applicator 2 portable foam extinguishers Sand box			Nothing specific		As per SOLAS	Nothing specific (We don't want to send somebody inside in case of a fire)	Nothing specific	
Contamination from BWMS room to other enclosed spaces: direct access to other enclosed spaces	Nothing specific			No direct access to service space, accommodation space or control station Access from the open deck if a nitrogen receiver is fitted in a dedicated compartment. Independent mechanical ventilation, extraction type	No direct access to service space, accommodation space or control station			No specific requirement		See first line of the table		Access through an airlock, except in case of access from the open deck Ozone detection in the space giving access to the BWM room Ozone detection repeater close to the entrance & out of the room + proper instruction on the door to prevent people from entering a room where ozone has leaked	No direct access to service space, accommodation space or control station Access from the open deck if a nitrogen receiver is fitted in a dedicated compartment. Independent mechanical ventilation, the extraction type



BWMS's Technology category	1	2.1	2.2	3a	3b	3c	4	5	6.1	6.2	7a	7b	8
Contamination from BWMS room to other enclosed spaces: gas-tight and self-closing door	Not required	Gastight and self-closing door		- (Not really relevant because access only from the open deck in case of N2 storage)	Gastight and self-closing door		Gastight and self-closing door, depending on the chemicals		Gastight and self-closing door		Gastight and self-closing door Gas tight boundaries		- (Not really relevant because access only from the open deck in case of N2 storage)
Contamination from BWMS room to other spaces: Independent ventilation + outlet arranged at a safe location on the open deck (refer to the definitions proposed UR M74 2.7)	Nothing specific	Independent ventilation, except that the machinery and storage room can be ventilated together (Irritation and toxicity) (1)		X The oxygen-enriched air from the nitrogen generator and the nitrogen-product enriched gas from the protective devices of the nitrogen receiver are to be discharged to a safe location (See UR M74) on the open deck. Independent ventilation with automatic fire dampers Low level exhaust in the BWMR	X		X Independent ventilation with exhaust located so as to take out any toxic gas	X Independent ventilation with exhaust located so as to take out hydrogen	X Independent ventilation required if toxic chemicals or if toxic gas may be generated	Independent ventilation required if toxic gas may be generated (storage and BWT machinery room may be ventilated together)	X Independent ventilation with reinforced thickness exhaust ducts (in order to ensure exhaust availability after a fire for atmosphere purging purposes)		X The oxygen-enriched air from the nitrogen generator and the nitrogen-product enriched gas from the protective devices of the nitrogen receiver are to be discharged to a safe location* on the open deck. [Covered by UR M74] Independent ventilation with automatic fire dampers Low level exhaust in the BWMR
Ventilation of the BWMS room: minimum air changes per hour, mechanical extraction type, etc.	Nothing specific	Min. 6	Stay with 6 air changes per hour by default since PAC is not identified as a specific risk as per G9 analysis	Min. 6 (extraction type) The compartment shall be fitted with an independent mechanical extraction ventilation system providing six air changes per hour. If a nitrogen receiver is fitted in a dedicated compartment, independent mechanical ventilation, of the extraction type shall be provided	Min. 6 (positive pressure type)		Min. 6	Min 20 (risk of H <sub>2</sub> )	Min. 6 To be adjusted depending on the gases that may be generated (toxic gases, explosive gases)		Interlock btw BWMS & ventilation of the BWM room and space providing access (system to shutdown / no start without ventilation) Alarm in case of loss of ventilation Min. 20 air changes per hour+ alarm + shutdown		Min. 6 (extraction type) The compartment shall be fitted with an independent mechanical extraction ventilation system providing six air changes per hour. If a nitrogen receiver is fitted in a dedicated compartment, independent mechanical ventilation, of the extraction type shall be provided
Chemical reactivity: potential reactivity with the performance of the type of the foam in case the BWMS is located in a space protected by a fixed foam fire extinguishing system	-	-	-	-	-	-	(1)	(1)	(1)	(1)	-	-	-

BWMS's Technology category	1	2.1	2.2	3a	3b	3c	4	5	6.1	6.2	7a	7b	8
Chemical or physical reactivity with water: potential reactivity with water spraying system (example exothermic reactivity from Sulfuric acid tank of Ecochlor)	-	-	-	-			- (The electrolysis reactor is to be provided with a pressure relief valve. Vent of this valve to be led to a safe location on the open deck => Risk of reaction btw hot water and free radicals in case of hot water)		(1)	(1)			-
O <sub>3</sub> leakage inside the BWMS room: air breathing apparatus	NA								EEBD to be provided depending on the specific risk assessment for the chemicals		EEBD to be provided		
Chemical leakage inside the BWMS room : Emergency eye wash, shower	NA	X	X	NA			X	NA	(1)		NA		
Routing of piping (To be discussed whether it is really worth mentioning, or whether there will be no piping out of the BWMS room)	NA	-	-	Inert gas piping systems shall not pass through accommodation, service and control station spaces			(Already covered in UR M74 rev.2 3.3.2.5)		Minimum pipe length (Already covered in UR M74 rev.2 3.3.2.2)		O <sub>3</sub> piping shall not pass through accommodation, service spaces or control stations, unless fully welded & reinforced thickness (same as CO <sub>2</sub> pipes)		Inert gas piping systems shall not pass through accommodation, service and control station spaces
Means of escape	As per SOLAS II-2/13 for auxiliary machinery spaces				As per SOLAS II-2/13 for cat.A machinery spaces		As per SOLAS II-2/13 for auxiliary machinery spaces		Crew training taking into account the risks of the chemicals as laid down by the manufacturer safety sheet Safety instructions to be displayed in the room Correct PPE (as defined by manufacturer or MSDS) As per SOLAS II-2/13 for auxiliary machinery spaces		As per SOLAS II-2/13 for auxiliary machinery spaces		

### 3 Source/derivation of the proposed IACS Resolution

N/A

### 4 Summary of Changes intended for the revised Resolution:

N/A

### 5 Points of discussions or possible discussions

#### 5.1 Application of the UR

1.1.2 – Application conditions are the same as UR M74 for general coherence of IACS requirements.

During development work, it has been considered whether the present UR should be merged with UR M74. This was finally declined because of the amount of work involved, which was expected to significantly delay the publication of both UR M74 rev.2 and this UR while the industry is actually installing ballast water treatment systems.

#### 5.2 Fire categories BWMR

2.1 and 2.2 – The following fire categories are to be applied to BWMR for the purpose of applying SOLAS II-2, in line with the outcome of the discussion at IMO SSE4:

- As a general rule, BWMR are considered to be similar to auxiliary machinery spaces, hence assimilated to "other machinery spaces", i.e. cat.(7) on passenger ships carrying not more than 36 passengers or cargo ships, or cat.(10) or (11) on passenger ships carrying more than 36 passengers
- BWMR containing oil-fired inert gas generators, however, are reckoned to represent a significant fire risk and fall under SOLAS definition II-2/3.31 of machinery spaces of category A. Therefore such spaces are to be considered as machinery spaces of category A
- BWMR located in the cargo area of tankers are to be categorised (8) – Cargo pump-rooms. When allowed in the cargo area, BWMR are considered similar to ballast pump room and therefore categorized (8), in line with the principles given in SOLAS II-2/4.5.1 and IGC §3.1 to 3.5. It is to be noted that not all ballast water management technologies are allowed in the cargo area of a tanker, those technologies that create a significant fire or explosion risk are not allowed in the cargo area as per UR M74 rev.2.

#### 5.3 3m distance

The 3m distance mentioned in 3.1.1 was chosen by reference to:

- the 3 m distance specified in SOLAS Reg II-2/5.2.1
- the definition of "Gas-dangerous space or zone" , which is defined in IGC Code as: "a zone on the open deck, or semi-enclosed space on the open deck, within 3 m of any cargo tank outlet, gas or vapour outlet, cargo pipe flange or cargo valve or of entrances and ventilation openings to cargo pump rooms and cargo compressor rooms"

#### *5.4 Fire categories for storage spaces for chemicals used by the BWMS*

2.3 – The spaces where the storage of liquid or solid chemicals or additives for BWMS is intended are categorized similarly to any other store-room onboard – although complementary safety requirements are then provided in the UR. Then, depending on whether they contain flammable chemicals, those storage spaces will be considered as standard store-rooms or as store-rooms that may contain flammable liquids.

In case this storage space is located in the cargo area of a tanker, the philosophy explained above for the BWMR applies and this room is to be categorised (8).

#### *5.5 Ventilation arrangement for BWMS using chemical substances*

3.1 - The 3m distance between ventilation outlets or other openings from the BWMR and openings to the accommodation spaces was chosen by reference to:

- the 3 m distance specified in SOLAS Reg II-2/5.2.1
- the definition of "Gas-dangerous space or zone" , which is defined in IGC Code as: "a zone on the open deck, or semi-enclosed space on the open deck, within 3 m of any cargo tank outlet, gas or vapour outlet, cargo pipe flange or cargo valve or of entrances and ventilation openings to cargo pump rooms and cargo compressor rooms"

#### *5.6 Ventilation arrangement for ozone-based BWMS*

6.1.4 – The requirement for reinforced thickness steel duct is applicable when ventilation ducts serving a BWMR containing an ozone-based BWMS cross other spaces. It was discussed whether "The part of the ducts located outside of the BWMR shall be made of steel" should be changed as "The part of the ducts located outside of the BWMR, where passing through other compartments/spaces, shall be made of steel", and finally decided that the indication "where passing through other compartments/spaces" need not be included, and the following points were made:

- SOLAS II-2/9.7.1.1 requires ventilation ducts to be of steel or equivalent material
- the purpose of the subject sentence is to request the construction of ducts, when crossing other spaces, in reinforced thickness steel, not merely steel ducts, thus not contradicting SOLAS requirements.

#### *5.7 In-tank pasteurization and de-oxygenation*

It was decided not to include any specific requirement regarding the space containing type 8 BWMS i.e. in-tank pasteurization and de-oxygenation because:

- Compartment with no direct access to service space, accommodation space or control station is already required by FSS Code §2.4.1.4
- Requirement for a gastight boundary was not deemed relevant during risk assessment, because FSS Code will allow only access from the open deck in case there is N2 storage

#### *5.8 Ventilation in case the BWMS is located in the engine room*

In case of BWMS installed in E/R and provided no division, the E/R has to be considered as BWMR. In that case, taking into account of current arrangement of E/R,

it is deemed difficult to satisfy 3.1, therefore engine rooms have been excluded from this requirement.

However, it is noted that:

- 7.1.1 remains applicable: According to the requirements of SOLAS II-2/9.7.2.1, it is understood that the ventilation system for the engine room is already separated from the ventilation system for any other spaces. Therefore, this requirement is not considered particularly stringent for engine rooms.
- 7.2.3 also remains applicable: Ventilation in engine rooms is expected to provide more than 20 air changes per hour, so that this requirement is not understood to be a constraint for engine rooms.

## **6 Attachments if any**

None

## UR F46 “Low pressure CO<sub>2</sub> piping system”

### Summary

This UR provides requirement for the minimum pressure at the nozzles for low pressure CO<sub>2</sub> systems.

### Part A. Revision History

Version no.	Approval date	Implementation date when applicable
New (Aug 2021)	02 August 2021	01 July 2022

#### • New (Aug 2021)

##### 1 Origin of Change:

- Based on IACS Requirement

##### 2 Main Reason for Change:

To address the remaining requirement from UI SC170 about minimum pressure requirement at the nozzles for CO<sub>2</sub> systems which has not been included in the amendments to the FSS Code MSC.206(81).

##### 3 List of non-IACS Member classification societies contributing or participating in IACS Working Group:

None

##### 4 History of Decisions Made:

During the maintenance of IACS Resolutions which have not been updated for the last ten years, the Safety Panel, after asking Machinery panel's view, agreed to develop a new UR in order to maintain the requirement of the minimum CO<sub>2</sub> pressure at the nozzles initially requested in UI SC170.

##### 5 Other Resolutions Changes:

UI SC170 should be deleted after this UR Takes effect because the only requirement not incorporated in amendments of FSS code Ch.5.2.2. (Res.MSC.206(81)) has been included in this UR.

##### 6 Any hinderance to MASS, including any other new technologies

None

## **7 Dates:**

Original Proposal: June 2021 (Made by Safety Panel)  
Panel Approval: 29 June 2021 (Ref: PS19002o)  
GPG Approval: 02 August 2021 (Ref: 21114\_IGd)

\*\*\*\*\*

## **Part B. Technical Background**

List of Technical Background (TB) documents:

### **Annex 1. TB for New (Aug 2021)**

See separate TB document in Annex 1.





## **Technical Background (TB) document for UR F46 (New Aug 2021)**

### **1. Scope and objectives**

The purpose of this UR is to include a requirement for the minimum pressure at the nozzles for low pressure CO<sub>2</sub> systems.

### **2. Engineering background for technical basis and rationale**

After asking Machinery panel's view, the Panel majority agreed that the requirement about minimum pressure at nozzles for low pressure CO<sub>2</sub> systems initially described in UI SC170 is to be kept and transferred in a unified requirement.

### **3. Source/derivation of the proposed IACS Resolution**

IACS UI SC170

### **4. Summary of Changes intended for the revised Resolution:**

None

### **5. Points of discussions or possible discussions**

None

### **6. Attachments if any**

None

# IACS

INTERNATIONAL ASSOCIATION OF CLASSIFICATION SOCIETIES LTD.  
PERMANENT SECRETARIAT: 36 BROADWAY, LONDON, SW1H 0BH, UNITED  
KINGDOM

TEL: +44(0)207 976 0660 FAX: +44(0)207 808 1100  
INTERNET: [permsec@iacs.org.uk](mailto:permsec@iacs.org.uk) Web Site: [www.iacs.org.uk](http://www.iacs.org.uk)

---

Oct 2023

## History Files (HF) and Technical Background (TB) documents for URs concerning Gas Tankers (UR G)

Res. No.	Title	Current Rev.	HF/TB?
UR G1	Vessels with cargo containment system for liquefied gas	Corr.3 Sep 2023	HF
UR G2	Liquefied gas cargo tanks and process pressure vessels	Rev.3 May 2023	HF
UR G3	Liquefied gas cargo and process piping	Rev.8 Oct 2023	HF
UR G4	Periodical surveys of cargo installations on ships carrying on liquefied gases in bulk	Deleted (Jun 1999) <i>Re-categorised as Z16</i>	TB
UR G5	Fail-close action of Emergency Shut Down (ESD) valve	New (Dec 2022)	HF

## UR G1 "Vessels with cargo containment system for liquefied gas"

### Summary

Rev.3 Corr.3 of UR G1 is made in order to modify editorial errors on formulas in Table 1 and appendix 1.

### Part A. Revision History

Version no.	Approval date	Implementation date when applicable
Corr.3 (Sep 2023)	05 September 2023	-
Corr.2 (Oct 2021)	18 October 2021	-
Corr.1 (May 2018)	30 May 2018	-
Rev.3 (June 2016)	21 June 2016	1 July 2016
Corr.1 (Sept 2003)	05 September 2003	-
Rev.2 (1997)	12 May 1997	-
Rev.1 (1979)	No record	-
New (1974)	No record	-

#### • Corr.3 (Sep 2023)

##### 1 Origin for Change:

Suggestion by HP Members

##### 2 Main Reason for Change:

Editorial errors are identified by HP Members with respect to "tb > -55°C, -10°C < tb ≥ -55°C, tb > -10°C" in Table 1 as well as "L < 50m" in appendix 1.

##### 3 List of non-IACS Member Classification Societies contributing or participating in IACS Working Group:

None

##### 4 History of Decisions Made:

Editorial errors are checked in comparison with the corresponding requirements of IGC Code (4.5 & 4.28.2) and modified into the correct formulas of "tb < -55°C, -55°C ≤ tb < -10°C, tb ≥ -10°C" in Table 1 as well as "L > 50m" in appendix 1.

##### 5 Other Resolutions Changes

None

**6 Any hinderance to MASS, including any other new technologies:**

None

**7 Dates:**

Original Proposal:	19 June 2023	(Ref: PH17013_IHbi)
Panel Approval:	21 August 2023	(Ref: PH17013_IHbn)
GPG Approval:	05 September 2023	(Ref: 21086_IGi)

• **Corr.2 (Oct 2021)**

**1 Origin for Change:**

Suggestion by HP Chair

**2 Main Reason for Change:**

Due to the revised UR W1 (UR W1 Rev.4 Mar 2021) an update of the references to UR W1 was necessary.

**3 List of non-IACS Member Classification Societies contributing through the TC Forum and/or participating in IACS Working Group:**

None

**4 History of Decisions Made:**

Following GPG message 19083\_IGc HP Chair reviewed G1 and proposed an update of the references. Proposal was discussed and agreed by the Panel and forwarded to GPG for final approval. The title of this UR has been updated in order to better reflect the scope of these requirements, i.e. unified requirements for vessels which the IGC code is not mandatory.

**5 Other Resolutions Changes**

None

**6 Any hinderance to MASS, including any other new technologies:**

None

**7 Dates:**

Original Proposal	: 07 May 2021	
Panel Approval	: 07 September 2021	(Ref: PH21009_IHf)
GPG Approval	: 18 October 2021	(Ref: 21086_IGg)

- **Corr.1 (May 2018)**

**.1 Origin for Change:**

- Suggestion by IACS member

**.2 Main Reason for Change:**

UR updated to correct inconsistency found.

**.3 List of non-IACS Member Classification Societies contributing through the TC Forum and/or participating in IACS Working Group:**

None

**.4 History of Decisions Made:**

IACS Members identified an inconsistency in the requirement of integral tanks presented in UR G1 paragraph 1.2.1 and in IGC Code (ref 4.2.1.2). Indeed, the design vapour pressure  $P_0$  should be taken less than  $0.07 \text{ N/mm}^2$  as integral tanks, like membrane, semi-membrane, independent tanks (type A/B) primarily constructed of plane surfaces (gravity tanks) etc., are not regarded as pressure tanks.

The corrected text for G1.2.1 should be as follows:

"If, however, the hull scantlings are increased accordingly,  $P_0$  may be increased to a higher value but not less than  $0,07 \text{ N/mm}^2$  (0.7 bar)."

**.5 Other Resolutions Changes**

None

**.6 Dates:**

Original Proposal: 26 March 2018

Panel Approval: 09 May 2018 (Ref: PH14029)

GPG Approval: 30 May 2018 (Ref: 15042\_IGx)

- **Rev.3 (June 2016)**

**.1 Origin for Change:**

- Suggestion by IACS member

**.2 Main Reason for Change:**

The IMO International Code for the Construction and Equipment of Ships Carrying Liquefied Gases in Bulk has been updated to include the content of the UR and as a result the UR is not applicable to ships which will comply with the new Gas Code.

**.3 List of non-IACS Member Classification Societies contributing through the TC Forum and/or participating in IACS Working Group:**

None

**.4 History of Decisions Made:**

The Hull Panel carried out a review of the updates to the Gas Code in order to determine what changes needed to be made to UR G1. It was concluded that the entire content of UR G1 has been included in the amendments made to the Gas Code. Hence, UR G1 is only applicable to vessels which do not have to comply with the requirements of the new Gas Code.

**.5 Other Resolutions Changes**

None

**.6 Dates:**

Original Proposal: 8 September 2015 Made by: An IACS Member  
Panel Approval: January 2016 (Ref: PH14029)  
GPG Approval: 21 June 2016 (Ref: 15042\_IGo)

• **Corr.1 (2003)**

**.1 Origin for Change:**

Suggestion by IACS member

**.2 Main Reason for Change:**

UR updated to correct errors found.

**.3 List of non-IACS Member Classification Societies contributing through the TC Forum and/or participating in IACS Working Group:**

None

**.4 History of Decisions Made:**

None

**.5 Other Resolutions Changes**

None

**.6 Dates:**

No records available.

- **Rev.2 (1997)**

**.1 Origin for Change:**

- Suggestion by IACS member

**.2 Main Reason for Change:**

UR updated to include cover latest developments in cargo containment system technology.

**.3 List of non-IACS Member Classification Societies contributing through the TC Forum and/or participating in IACS Working Group:**

None

**.4 History of Decisions Made:**

None

**.5 Other Resolutions Changes**

None

**.6 Dates:**

No records available.

- **Rev.1 (1979)**

**.1 Origin for Change:**

- Suggestion by IACS member

**.2 Main Reason for Change:**

UR updated to include cover latest developments in cargo containment system technology.

**.3 List of non-IACS Member Classification Societies contributing through the TC Forum and/or participating in IACS Working Group:**

None

**.4 History of Decisions Made:**

None

**.5 Other Resolutions Changes**

None

**.6 Dates:**

No records available.

• **New (1986)**

**.1 Origin for Change:**

- Suggestion by IACS member

**.2 Main Reason for Change:**

The IMO International Code for the Construction and Equipment of Ships Carrying Liquefied Gases in Bulk does not include complete requirements for the cargo containment systems of gas carriers. The purpose of this UR is to ensure that all IACS Members apply certain minimum standards when assessing such systems.

**.3 List of non-IACS Member Classification Societies contributing through the TC Forum and/or participating in IACS Working Group:**

None

**.4 History of Decisions Made:**

None

**.5 Other Resolutions Changes**

None

**.6 Dates:**

No records available.



## Part B. Technical Background

List of Technical Background (TB) documents for UR G1:

Annex 1. **TB for Rev.3 (June 2016)**

See separate TB document in Annex 1.



**Note:** *There are no separate Technical Background (TB) documents available for New (1986), Rev.1 (1979), Rev.2 (1997), Corr.1 (Sept 2003), Corr.1 (May 2018), Corr.2 (Oct 2021) and Corr.3 (Sep 2023).*

## **Technical Background (TB) document for UR G1 (Rev.3 June 2016)**

### **1. Scope and objectives**

The purpose of this revision to the UR is to align it with the latest version of the Gas Code.

### **2. Engineering background for technical basis and rationale**

The content of the UR has been included in the amendments to the Gas Code and so it is not necessary to apply the UR to vessels which will be complying with the requirements of the new Gas Code.

### **3. Source/derivation of the proposed IACS Resolution**

IMO International Code for the Construction and Equipment of Ships Carrying Liquefied Gases in Bulk.

### **4. Summary of Changes intended for the revised Resolution:**

An application statement has been included which states the following:

*"This UR does not apply to vessels which must comply with the requirements of IMO Resolution MSC.370(93) Amendments to the International Code for the Construction and Equipment of Ships Carrying Liquefied Gases in Bulk (IGC Code)."*

The reason the contracted for construction date is not used (as is typical of IACS URs) is because the Gas Code has fairly convoluted criteria. Namely, the amendments apply to the following vessels:

*"1.1.1 The Code applies to ships regardless of their size, including those of less than 500 gross tonnage, engaged in the carriage of liquefied gases having a vapour pressure exceeding 0.28 MPa absolute at a temperature of 37.8°C and other products, as shown in chapter 19, when carried in bulk.*

*1.1.2.1 Unless expressly provided otherwise, the Code applies to ships whose keels are laid, or which are at a similar stage of construction where:*

*.1 construction identifiable with the ship begins; and*

*.2 assembly of that ship has commenced, comprising at least 50 tonnes or 1% of the estimated mass of all structural material, whichever is less, on or after 1 July 2016.*

*1.1.2.2 For the purpose of the Code, the expression "ships constructed" means ships the keels of which are laid or which are at a similar stage of construction."*

Hence, it is simpler to apply the UR to vessels where it has already been established that the amendments to the Gas Code are applicable.

### **5. Points of discussions or possible discussions**

None

**6. Attachments if any**

None

## UR G2 “Liquefied gas cargo tanks and process pressure vessels”

### Summary

The Rev.3 of UR G2 provides requirements regarding the new IGC Code (MSC 370(93) Corr.1 and Revised UR W1.

### Part A. Revision History

Version no.	Approval date	Implementation date when applicable
Rev.3 (May 2023)	7 May 2023	1 July 2024
Rev.2 (Dec 2018)	21 December 2018	1 January 2020
Rev.1 (1979)	No records	-
New (1974)	No records	-

#### • Rev 3 (May 2023)

##### 1 Origin of Change:

- Suggestion by GPG and IACS Hull Panel

##### 2 Main Reason for Change:

The IMO International Code for the Construction and Equipment of Ships Carrying Liquefied Gases in Bulk has been updated to include the content of the UR G2 and as a result the UR G2 (Rev.2, 2018) is not applicable to ships which will comply with the new IGC Code (Res.MSC.370(93) Corr.1 and W1 as amended).

##### 3 List of non-IACS Member Classification Societies contributing through the TC Forum and/or participating in IACS Working Group:

None

##### 4 History of Decisions Made:

The Machinery Panel carried out a review of the updates to the Gas Code in order to determine what changes needed to be made to UR G2. It was decided to review the UR G2 (Rev.2, 2018) in order to make it applicable to ships complying with the new IGC (Res.MSC.370(93) Corr.1 and W1 as amended).

##### 5 Other Resolutions Changes

UR G3

## 6 Dates:

Original Proposal:	May 2021	(GPG 19083_IGe)
Panel Approval:	April 2023	(via PM20304kIMd)
GPG Approval:	07 May 2023	(Ref: 19083_IGh)

- **Rev 2 (Dec 2018)**

### 1 Origin of Change:

Suggestion by IACS member

### 2 Main Reason for Change:

The IMO International Code for the Construction and Equipment of Ships Carrying Liquefied Gases in Bulk has been updated to include the content of the UR G2 and as a result the UR G2 (Rev.1, 1979) is not applicable to ships which will comply with the new IGC Code (Res.MSC.370(93) as amended).

### 3 List of non-IACS Member Classification Societies contributing through the TC Forum and/or participating in IACS Working Group:

None

### 4 History of Decisions Made:

The Machinery Panel carried out a review of the updates to the Gas Code in order to determine what changes needed to be made to UR G2. It was decided to review the UR G2 (Rev.1, 1979) in order to make it applicable to ships complying with the new IGC (Res.MSC.370(93) as amended).

### 5 Other Resolutions Changes

UR G3

## 6 Dates:

Original Proposal:	September 2015 (22 <sup>nd</sup> Machinery Panel Meeting)
Panel Approval:	September 2018 (28 <sup>th</sup> Machinery panel meeting)
GPG Approval:	21 December 2018 (Ref: 15042_IGzd)

- **Rev.1 (1979)**

No records available.

- **New (1974)**

No records available.

## **Part B. Technical Background**

List of Technical Background (TB) documents for UR G2:

Annex 1. **TB for Rev.2 (Dec 2018)**

See separate TB document in Annex 1.

Annex 2. **TB for Rev.3 (May 2023)**

See separate TB document in Annex 2.

*Note: There are no Technical Background (TB) documents available for New (1974) and Rev.1 (1979).*

## **Technical Background (TB) document for UR G2 (Rev.2 Dec 2018)**

### **1. Scope and objectives**

The purpose is to revise UR G2 (Rev.1 1979), applicable to ships complying with the old IGC Code (pre-2016 editions), in order to make it applicable to ships complying with the new IGC Code (Res.MSC.370(93) as amended).

### **2. Engineering background for technical basis and rationale**

The requirements of UR G2 (Rev.1 1979) correspond to the requirements of the old IGC code (pre-2016 editions); in the revision process those requirements of UR G2 which were found different to those of the new IGC Code have been modified to conform to the requirements of the new IGC code and these modifications are reflected in the Rev.2 of the UR G2.

### **3. Source/derivation of the proposed IACS Resolution**

IMO International Code for the Construction and Equipment of Ships Carrying Liquefied Gases in Bulk, Res.MSC.370(93) as amended.

### **4. Summary of Changes intended for the revised Resolution**

The Rev.2 of the UR G2 was developed to apply to ships for which the new IGC Code is applicable.

### **5. Points of discussions or possible discussions**

Direct references to the IGC Code are made in some parts of the UR instead of repeating the Code text.

### **6. Attachments if any**

None

## **Technical Background (TB) document for UR G2 (Rev.3 May 2023)**

### **1. Scope and objectives**

The purpose is to revise UR G2 (Rev.2 2018), applicable to ships complying with the old IGC Code (2016 editions), in order to make it applicable to ships complying with the new IGC Code (Res.MSC.370(93) Corr.1 and UR W1 as amended).

### **2. Engineering background for technical basis and rationale**

The requirements of UR G2 (Rev.2 2018) correspond to the requirements of the old IGC code (2016 editions); in the revision process those requirements of UR G2 which were found different to those of the new IGC Code have been modified to conform to the requirements of the new IGC code and these modifications are reflected in the Rev.3 of the UR G2.

### **3. Source/derivation of the proposed IACS Resolution**

IMO International Code for the Construction and Equipment of Ships Carrying Liquefied Gases in Bulk, Res.MSC.370(93) Corr.1 as amended.

### **4. Summary of Changes intended for the revised Resolution**

The Rev.3 of the UR G2 was developed to apply to ships for which the new IGC Code is applicable.

### **5. Points of discussions or possible discussions**

Direct references to the IGC Code are made in some parts of the UR instead of repeating the Code text.

Note that detailed welding requirements are no longer within UR W1.

UR W1 is only applicable to material for thickness from 40-50mm (which are currently beyond the Code's requirements).

For NDT techniques and requirement, G2.9 referred to recognized standards acceptable to the Classification Societies.

Reference on UR W1 mentioned in G2.2 for the material of process pressure vessel (when thickness is beyond the Code).

### **6. Attachments if any**

None



## UR G3 “Liquefied gas cargo and process piping”

### Summary

Revision 8 of UR G3 provides revised requirements for cargo pumps and gas/reliquefaction/refrigeration compressors as regards design assessment, material testing, prototype testing, unit production and installation testing.

### Part A. Revision History

Version no.	Approval date	Implementation date when applicable
Rev.8 (Oct 2023)	15 October 2023	1 January 2025
Rev.7 (Dec 2019)	13 December 2019	1 January 2021
Rev.6 (Jan 2016)	29 January 2016	1 January 2017
Rev.5 (Jan 2013)	17 January 2013	1 January 2014
Rev.4 (Mar 2011)	20 March 2011	1 January 2012
Withdrawal of Rev.3 and Rev.3, Corr.1 (Jun 2010)	14 June 2010	-
Rev.3, Corr.1 (Dec 2009)	11 December 2009	1 July 2010
Rev.3 (Dec 2008)	19 December 2008	1 January 2010
Rev.2 (1997)	12 May 1997	-
Rev.1 (1979)	No record	-
NEW (1974)	No record	-

#### • Rev.8 (Oct 2023)

##### .1 Origin for Change:

Suggestion by IACS member

##### .2 Main Reason for Change:

Regarding various discussions for alignment of IGC Code with IGF Code A-1, it was agreed that UR G3 needs revision to expand G3.6.3 to address liquefied gas carrier gas/liquefaction/refrigeration compressors in addition to cargo pumps.

##### .3 List of non-IACS Member Classification Societies contributing through the TC Forum and/or participating in IACS Working Group:

None

##### .4 History of Decisions Made:

With reference to SOLAS Reg. II-1 26.6: Main propulsion machinery and all auxiliary machinery essential to the propulsion and the safety of the ship shall, as fitted in the ship, be designed to operate when the ship is upright and when inclined at any angle

of list up to and including 15° either way under static conditions and 22.5° under dynamic conditions (rolling) either way and simultaneously inclined dynamically (pitching) 7.5° by bow or stern. The Administration may permit deviation from these angles, taking into consideration the type, size, and service conditions of the ship.

and to IGF Code in A-1, 9.9.2: Compressors and pumps shall be suitable for their intended purpose. All equipment and machinery should be adequately tested to ensure suitability for use within a marine environment. Such items to be considered would include, but not be limited to .1 environmental; .2 shipboard vibrations and accelerations; .3 effects of pitch, heave, and roll motions, etc.; and .4 gas composition.

it was decided to revise UR G3 (in conjunction with a revision of UR M46) to ensure clarity that cargo pumps and gas/reliquefaction/refrigeration compressors are expected to demonstrate compliance with criteria set for design assessment and testing or prior satisfactory service experience.

### **.5 Other Resolutions Changes**

UR M46

### **.6 Any hinderance to MASS, including any other new technologies:**

None

### **.7 Dates:**

Original Proposal:	January 2021	(PM11923aIMf)
Panel Approval:	29 September 2023	(Ref. PM19923aIMp)
GPG Approval:	15 October 2023	(Ref: 21036_Igh)

## **• Rev.7 (Dec 2019)**

### **.1 Origin for Change:**

Suggestion by IACS member

### **.2 Main Reason for Change:**

The IMO International Code for the Construction and Equipment of Ships Carrying Liquefied Gases in Bulk (IGC Code) has been updated to include the content of the UR G3 and as a result the UR G3 (Rev.6, Jan 2016) is not applicable to ships which will comply with the new IGC Code (Res.MSC.370(93) as amended).

### **.3 List of non-IACS Member Classification Societies contributing through the TC Forum and/or participating in IACS Working Group:**

None

### **.4 History of Decisions Made:**

The Machinery Panel carried out a review of the updates to the IGC Code in order to

determine what changes needed to be made to UR G3. It was decided to review the UR G3 (Rev.6, Jan 2016) in order to make it applicable to ships complying with the new IGC (Res.MSC.370(93) as amended).

## **.5 Other Resolutions Changes**

UR G2

## **.6 Any hinderance to MASS, including any other new technologies:**

None

## **.7 Dates:**

Original Proposal: September 2015 (22nd Machinery Panel Meeting)

Panel Approval: September 2019 (30th Machinery Panel Meeting) and  
30 October 2019 (Ref. PM5901eIMt)

GPG Approval: 13 December 2019 (Ref: 15042\_IGzm)

## **• Rev.6 (Jan 2016)**

### **.1 Origin for Change:**

Based on the proposal of an IACS Member

### **.2 Main Reason for Change:**

To reconsider the prototype testing and the unit production testing for valves used for isolation of instruments.

### **.3 List of non-IACS Member classification societies contributing through the TC Forum and/or participating in IACS Working Group:**

None

### **.4 History of Decisions Made:**

Survey Panel discussed under the task PSU15008 the proposal of the Member for reconsidering the test procedures of valves used for isolating instruments in piping having diameter not greater than 25 mm.

The proposal was supported by the consideration that valves in instrumentation piping, which only serve to isolate a gauge or other instrumentation, are usually left open.

Therefore it has been evaluated that the prototype test and unit production test of these valves can be deemed acceptable as follows:

- Prototype testing: it may be witnessed by an Independent Certification Body
- Unit production testing: the witnessing by part of the surveyor may be dispensed.

- In both cases records of the testing activities are to be available for review.

Panel at the 21<sup>st</sup> Meeting concurred with the proposal and agreed to the modification of the paragraphs G3.6.1.1 and G3.6.1.2 of Unified Requirement G3.

The draft of revision 6 was subsequently submitted to the examination of the Machinery Panel which is the responsible of the UR.

Machinery Panel Members provided their comments on the proposal: these have been dealt with by the Survey Panel Members during the 22<sup>nd</sup> meeting. As outcome of the discussion Panel concluded that the proposed modification of the paragraph G3.6.1.1 does not need to be applied since the presence of the Classification Society surveyor at the prototype tests of the cryogenic valves having diameter less than 25 mm is necessary.

In the light of above Panel decided to finalize the revision 6 of the UR by modifying only the paragraph G3.6.1.2

Technical Background, recording the Machinery Panel advice and the Survey Panel technical justifications, is provided in Annex 4.

## **.5 Other Resolutions Changes**

None

## **.6 Dates:**

Original proposal: 22 January 2015 by IACS Member  
Panel Approval: December 2015 by Survey Panel (Ref: PSU15008) GPG Approval: 29 January 2016 (Ref: 15204\_IGb)

## **• Rev.5 (Jan 2013)**

### **.1 Origin for Change:**

- Request by non-IACS entity (LESER)

### **.2 Main Reason for Change:**

To reflect the test procedures for prototype and production tests of safety valves intended to be used at a working temperature lower than -55°C.

### **.3 List of non-IACS Member classification societies contributing through the TC Forum and/or participating in IACS Working Group:**

None

### **.4 History of Decisions Made:**

Survey Panel discussed the proposal of LESER for reconsidering the test procedures of safety valves. The panel discussed and revised the provisions of test procedure for

safety valves required by Para G3.6.1.1 and G3.6.1.2. Conclusion of Survey Panel was further reviewed and supported by Machinery Panel.

#### **.5 Other Resolutions Changes**

None

#### **.6 Dates:**

Original proposal: 29 September 2011 by non-IACS entity (LESER)  
Panel Approval: 8 March 2012 (15<sup>th</sup> Panel Meeting) By: Survey Panel  
25 September 2012 By: Machinery Panel  
GPG Approval: 17 January 2013 (Subject No: 12219\_IGb)

#### **• Rev.4 (Mar 2011)**

##### **.1 Origin for Change:**

Request by non-IACS entity (Hamworthy)

##### **.2 Main Reason for Change:**

To reflect the common survey practices of the Members on testing of cargo pumps and adding in test requirements for pumps intended to be used at a working temperature not lower than -55°C and for new LNG and LPG pumps.

##### **.3 List of non-IACS Member classification societies contributing through the TC Forum and/or participating in IACS Working Group:**

None

##### **.4 History of Decisions Made:**

8 February 2010 – Form 1 approved by GPG authorizing Survey Panel Project Team  
17 February 2010 – Survey Panel Project Team Meeting  
4 March 2010 – Project Team Manager presents recommendations to Survey Panel

#### **.5 Other Resolutions Changes**

None

#### **.6 Dates:**

Original proposal: June 2009 Made by: Survey Panel PT for Task 57  
Panel Approval: 15 October 2010 Made By: Survey Panel  
GPG Approval: 20 March 2011 (Ref. 8508bIGo)

- **Withdrawal of Rev.3 and Rev.3, Corr.1 (Jun 2010)**

On 14 June 2010 GPG agreed to the withdrawal of UR G3 Rev.3 and Rev.3 Corr.1 pending further review by the Survey Panel (ref. 8508bIGj).

- **Rev.3, Corr.1 (Dec 2009)**

Postponement of implementation date for Rev.3 from 1 January 2010 to 1 July 2010. Approved by GPG 11 December 2009 (ref. 8508bIGc).

No TB document available.

- **Rev.3 (Dec 2008)**

Changes to section G3.6 - see TB document in Part B.

- **Rev.2 (1997)**

Consequential change further to adoption at MSC67 of MSC.58(67) for IBC Code and MSC.59(67) for IGC Code concerning avoidance of "vague expressions in the IBC and IGC codes".

No TB document available.

- **Rev.1 (1979)**

No TB document available.

- **New (1974)**

No TB document available.

## **Part B. Technical Background**

List of Technical Background (TB) documents for UR G3:

Annex 1. **TB for Rev.3 (Dec 2008)**

See separate TB document in Annex 1.

Annex 2. **TB for Rev.4 (Mar 2011)**

See separate TB document in Annex 2.

Annex 3. **TB for Rev.5 (Jan 2013)**

See separate TB document in Annex 3.

Annex 4. **TB for Rev.6 (Jan 2016)**

See separate TB document in Annex 4.

Annex 5. **TB for Rev.7 (Dec 2019)**

See separate TB document in Annex 5.

Annex 6. **TB for Rev.8 (Oct 2023)**

See separate TB document in Annex 6.



**Note:** There are no separate Technical Background (TB) documents for the original resolution (1974), Rev.1 (1979), Rev.2 (1997) and Rev.3, Corr.1 (Dec 2009).

## Technical Background

### UR G3 (Rev.3, Dec 2008)

**Survey Panel Task 57:** Consider amending UR G 3 “Liquefied gas cargo and process piping” to reflect the common survey practices of the Members on testing of cryogenic valves and adding in test requirements for valves intended to be used at a working temperature not lower than -55°C and for new LNG and LPG pumps.

#### 1. Objective

Consider amending the present survey tightness test requirements contained in UR G3, section 3.6.1, which is only each size and each type of valve intended to be used at a working temperature below -55°C to take into account the present best practices of the members. Also consider adding in new sections containing survey test requirements based on best practices of Members for valves intended to be used at a working temperature not lower than -55°C and new LNG and LPG cargo pumps as presently there are no requirements.

#### 2. Background

ABS Panel member initially requested clarification on testing of cryogenic valves and requirements for testing of new LNG pumps based on email correspondence dated 28 Nov 2007. NK Panel member requested that survey requirements for valves intended to be used at a working temperature not lower than -55°C be considered based on email dated 14 Dec 2007.

#### 3. Methodology of Work

The Survey Panel has progressed its work through meetings as well as a Survey Panel Project Team consisting of ABS (Chair), BV, DNV, KR and NK. The proposed scope of work as well as the draft recommendation by the Project Team was circulated to all Members for comment and agreement.

#### 4. Discussion

- **Valves**

The Project Team first discussed the survey practices of the members on testing of cryogenic valves for temperatures lower than -55°C. The use of the term “type testing” caused considerable confusion due to current type approval programs offered by the societies. After lengthy discussion, in order to eliminate confusion, the members decided to use the terms “prototype” testing and “unit production” testing.

All members stated that prototype testing was carried out for each type and size of valve and that surveyor attendance was required during these tests. However, for unit certification, the practices differed. The members also reported that it was common practice to carry out cryogenic testing of 10 percent of the valves.

For prototype testing, all members agreed that the required minimum tests in the presence of a surveyor include hydrostatic test of the valve body at a pressure equal to 1.5 times the design pressure, seat and stem leakage test at a pressure equal to 1.1 times the design pressure, and cryogenic testing consisting of valve operation and leakage verification. They also agreed that testing is to be carried out at the minimum



design temperature or lower and to a pressure not lower than the maximum design pressure foreseen for the valves.

For unit production testing, the members agreed there should be two options for testing of the valves based on current practices. The first option required surveyor attendance for all valve testing. The second option allowed the manufacturer to carry out the testing if they had a recognized quality system which had been assessed by the society and is subject to periodic audits.

All members agreed that the required minimum tests for both options include hydrostatic test of the valve body at a pressure equal to 1.5 times the design pressure, seat and stem leakage test at a pressure equal to 1.1 times the design pressure. It was also decided to include the industry standard of requiring cryogenic testing consisting of valve operation and leakage verification for a minimum of 10% of each type and size of valve for valves intended to be used at a working temperature below  $-55^{\circ}\text{C}$ . The cryogenic tests are to be carried out in the presence of a surveyor for both of the above options.

The members then discussed the requirements for valves intended to be used at a working temperatures above  $-55^{\circ}\text{C}$ . Based upon service experience, and that there is no testing medium for  $-55^{\circ}\text{C}$ , it was decided that prototype testing was not required for these valves.

- **Cargo Pumps**

The members decided to use the same methodology for cargo pumps as was used for valves. All members reported their procedures followed the prototype and unit production testing similar to valves.

Again, the members decided that surveyor attendance was required for prototype testing and that two options be available for unit production testing. The first option required surveyor attendance for all pump testing. The second option allowed the manufacturer to carry out the testing if they had a recognized quality system which had been assessed by the society and is subject to periodic audits.

For prototype and unit production testing, all members agreed the required minimum tests include hydrostatic test of the pump body equal to 1.5 times the design pressure and a capacity test. For pumps intended to be used at a working temperature below  $-55^{\circ}\text{C}$ , the capacity test is to be carried out at the minimum working temperature. After completion of tests, the pump is to be opened out for examination. Based upon service experience, and that there is no testing medium for  $-55^{\circ}\text{C}$ , it was decided pumps intended to be used at temperatures above  $-55^{\circ}\text{C}$ , could be tested at ambient temperature.

- **IACS UR G3**

The members also decided to change the title of G3.6 to indicate these tests were to be carried out prior to installation onboard and differentiate it from G3.8. It was also decided to revise the title of G3.8 to "Test onboard".

In order to differentiate between prototype testing and type testing, the members also recommend the proposed change to G3.6.2. It is further recommended that this section be revised to incorporate the same methodology used for the valves and pumps. Since this was not included in the task, the project team took no action at this time.

During the discussions on the task, the team noted that UR G3 may require updating to reflect current practices. This is probably due to the fact that UR G3 was written in 1974 and revised in 1979 and 1997.

Submitted by Survey Panel Chairman

12 November 2008

**Permanent Secretariat note (January 2009):**

UR G3 (Rev.3) was approved by GPG on 19 December 2008 (ref. 8508alGd) with the following implementation statement:

*“The requirements of G3.6 Rev.3 are to be uniformly implemented by IACS Societies for piping components and pumps:*

- i) when an application for testing is dated on or after 1 January 2010; or*
- ii) which are installed in new ships for which the date of contract for construction is on or after 1 January 2010.”*

## Technical Background for UR G3, Rev.4 (Mar 2011)

### 1. Scope and objectives

Consider amending the present prototype test and unit production test requirements contained in UR G3, section G.3.6.3.1 and G.3.6.3.2, for pumps intended to be used at a working temperature below  $-55^{\circ}\text{C}$  to take into account the present best practices of the members and the comments from the Industry. Also consider adding in new sections containing survey test requirements based on best practices of Members for pumps intended to be used at a working temperature not lower than  $-55^{\circ}\text{C}$  and new LNG and LPG cargo pumps as presently there are no requirements.

### 2. Engineering background for technical basis and rationale

For prototype testing, all members agreed the required minimum tests include hydrostatic test of the pump body equal to 1.5 times the design pressure and a capacity test. Although capacity tests are not safety related, this test demonstrates the overall performance of the pump prior to being installed onboard.

Since this is a new requirement and there are pumps currently in service which have years of satisfactory service, an option was provided to allow the manufacturer to submit data proving the in-service experience rather than requiring them to carry out the prototype test which would be required for a new design of pump.

For submerged electric motor driven pumps the capacity test is to be carried out in the design medium or below minimum working temperature. The reason two conditions was added is that some manufacturers may test with LNG and others may use liquid nitrogen which has a temperature of  $-196^{\circ}\text{C}$ . When testing with the design medium, LNG, it is difficult to keep the temperature constant and there is a possibility that air may be introduced. Therefore, the test is usually carried out between  $-160$  and  $-150^{\circ}\text{C}$  in order to keep the suction line a little above atmospheric pressure.

The shaft driven deep well pumps are now being used on gas vessels that are capable of pumping LPG, Ethylene and LNG. Since it is not practical and could be dangerous to perform a capacity test of shaft driven deep well pumps at the minimum working temperature, this test may be carried out with water. However, in order to prove the pump will be able to operate at the minimum working temperature, a spin test to demonstrate satisfactory operation of bearing clearances, wear rings and sealing arrangements should be carried out prior to the pump being installed onboard. This test would most likely be done using liquid nitrogen so the pump would have to be designed for the lower temperature.

After completion of tests, the pump is to be opened out for examination.

### 3. Source/derivation of the proposed IACS Resolution

Current industry practice.

## 4. Summary of Changes intended for the revised Resolution:

### G3.6.3 Cargo Pumps

#### G3.6.3.1 Prototype Testing

Each size and type of pump is to be approved through design assessment and prototype testing. Prototype testing is to be witnessed in the presence of the Society's representative. In lieu of prototype testing, satisfactory in-service experience, of an existing pump design approved by a Society, submitted by the manufacturer may be considered.

Prototype testing is to include a hydrostatic test of the pump body equal to 1.5 times the design pressure and a capacity test. For submerged electric motor driven pumps, the capacity test is to be carried out with the design medium or with a medium below the minimum working temperature. For shaft driven deep well pumps, the capacity test may be carried out with water. In addition, for shaft driven deep well pumps, a spin test to demonstrate satisfactory operation of bearing clearances, wear rings and sealing arrangements is to be carried out at the minimum design temperature. The full length of shafting is not required for the spin test, but must be of sufficient length to include at least one bearing and sealing arrangements. After completion of tests, the pump is to be opened out for examination.

#### G3.6.3.2 Unit Production Testing

All pumps are to be tested at the plant of manufacturer in the presence of the Society's representative. Testing is to include hydrostatic test of the pump body equal to 1.5 times the design pressure and a capacity test. For submerged electric motor driven pumps, the capacity test is to be carried out with the design medium or with a medium below the minimum working temperature. For shaft driven deep well pumps, the capacity test may be carried out with water.

As an alternative to the above, if so requested by the relevant Manufacturer, the certification of a pump may be issued subject to the following:

- The pump has been ~~prototype tested~~ approved as required by 3.6.3.1, and
- The manufacturer has a recognized quality system that has been assessed and certified by the Society subject to periodic audits, and
- The quality control plan contains a provision to subject each pump to a hydrostatic test of the pump body equal to 1.5 times the design pressure and a capacity test. The manufacturer is to maintain records of such tests.

## 5. Points of discussions or possible discussions

### G3.6.3.1 Prototype Testing

In lieu of prototype testing, satisfactory in-service experience, of an existing pump design approved by a Society, submitted by the manufacturer may be considered.

Since this is a new requirement and there are pumps currently in service which have years of satisfactory service, an option was provided to allow the manufacturer to submit data proving the in-service experience rather than requiring them to carry out the prototype test which would be required for a new design of pump.

...For submerged electric motor driven pumps, the capacity test is to be carried out with the design medium or with a medium below the minimum working temperature. For shaft driven deep well pumps, the capacity test may be carried out with water. In addition, for shaft driven deep well pumps, a spin test to demonstrate satisfactory operation of bearing clearances, wear rings and sealing arrangements is to be carried out at the minimum design temperature. The full length of shafting is not required for the spin test, but must be of sufficient length to include at least one bearing and sealing arrangements.

For submerged electric motor driven pumps the capacity test is to be carried out in the design medium or below minimum working temperature. The reason two conditions was added is that some manufacturers may test with LNG and others may use liquid nitrogen which has a temperature of -196 C. When testing with the design medium, LNG, it is difficult to keep the temperature constant and there is a possibility that air may be introduced. Therefore, the test is usually carried out between -160 and -150 C in order to keep the suction line a little above atmospheric pressure.

The shaft driven deep well pumps are now being used on gas vessels that are capable of pumping LPG, Ethylene and LNG. Since it is not practical and could be dangerous to perform a capacity test of shaft driven deep well pumps at the minimum working temperature, this test may be carried out with water. However, in order to prove the pump will be able to operate at the minimum working temperature, a spin test to demonstrate satisfactory operation of bearing clearances, wear rings and sealing arrangements should be carried out prior to the pump being installed onboard. This test would most likely be done using liquid nitrogen so the pump would have to be designed for the lower temperature.

#### G3.6.3.2 Unit Production Testing

.... For submerged electric motor driven pumps, the capacity test is to be carried out with the design medium or with a medium below the minimum working temperature. For shaft driven deep well pumps, the capacity test may be carried out with water.

Same reasoning as prototype testing.

- The pump has been ~~prototype tested~~ approved as required by 3.6.3.1, and

To clarify that all the requirements of 3.6.3.1 must be completed and not just the testing.

#### **6. Attachments if any**

None

## Technical Background for UR G3 Rev.5 Jan 2013

### 1. Scope and objectives

To consider the comments and proposals submitted by non-IACS entity (LESER) for revision of the requirements regarding prototype and production tests of safety valves intended to be used at a working temperature lower than -55°C.

### 2. Engineering background for technical basis and rationale

- Survey Panel reviewed the comment of a non-IACS entity that the requirements of UR G3 Para G3.6.1.1 and G3.6.1.2 are not possible to satisfy for safety valves because of the different design from shut off valves.
- Panel discussed the above issue and revised the requirements of UR G3 for prototype and production tests of safety valves.

### 3. Source/derivation of the proposed IACS Resolution

None

### 4. Summary of Changes intended for the revised Resolution

#### G3.6.1.1 Prototype Testing

Each size and type of valve intended to be used at a working temperature below -55°C is to be approved through design assessment and prototype testing. Prototype testing to the minimum design temperature or lower and to a pressure not lower than the maximum design pressure foreseen for the valves is to be witnessed in the presence of the Society's representative. Prototype testing for all valves, is to include hydrostatic test of the valve body at a pressure equal to 1.5 times the design pressure, and cryogenic testing consisting of valve operation or safety valve set pressure, and leakage verification. In addition, for valves other than safety valves, a seat and stem leakage test at a pressure equal to 1.1 times the design pressure.

For valves intended to be used at a working temperature above -55°C, prototype testing is not required.

#### G3.6.1.2 Unit Production Testing

All valves are to be tested at the plant of manufacturer in the presence of the Society's representative. Testing is to include hydrostatic test of the valve body at a pressure equal to 1.5 times the design pressure for all valves, and seat and stem leakage test at a pressure equal to 1.1 times the design pressure for valves other than safety valves. In addition, cryogenic testing consisting of valve operation and leakage verification for a minimum of 10% of each type and size of valve for valves other than safety valves intended to be used at a working temperature below -55°C. The set pressure of safety valves is to be tested at ambient temperature.

As an alternative to the above, if so requested by the relevant Manufacturer, the certification of a valve may be issued subject to the following:

- The valve has been approved as required by 3.6.1.1 for valves intended to be used at a working temperature below -55°C, and
- The manufacturer has a recognized quality system that has been assessed and certified by the Society subject to periodic audits, and
- The quality control plan contains a provision to subject each valve to a hydrostatic test of the valve body at a pressure equal to 1.5 times the design pressure for all valves and seat and stem leakage test at a pressure equal to 1.1 times the design pressure for valves other than safety valves. The set pressure of safety valves is to be tested at ambient temperature. The manufacturer is to maintain records of such tests, and
- Cryogenic testing consisting of valve operation and leakage verification for a minimum of 10% of each type and size of valve, for valves other than safety valves, intended to be used at a working temperature below -55°C in the presence of the Society's representative.

### G3.8.3 Functional tests

All piping systems including all valves, fittings and associated equipment for handling cargo or vapours are to be tested under normal operating conditions not later than at the first loading operation.

## **5. Points of discussions or possible discussions**

Prototype and production tests of safety valves

## **6. Attachments if any**

None

## Technical Background (TB) document for UR G3 (Rev.6 Jan 2016)

### 1. Scope and objectives

Analyse the Machinery Panel comments to the draft revision 6 of UR G3 and verify the possibility to address them.

### 2. Engineering background for technical basis and rationale

With the revision 6 of UR G3 it has been scheduled to introduce new requirements relevant the witnessing, by part of the Classification Society, of the prototype and production testing for the valves used for insulation of instrumentation piping not greater than 25 mm (outside diameter).

### 3. Source/derivation of the proposed IACS Resolution

Survey Panel Member

### 4. Summary of Changes intended for the revised Resolution:

Revision of the criteria to apply to the prototype and production testing of the valves to be fitted on pipes having outside diameter of 25mm and used in order to isolate the instrumentations. Paragraphs to be modified inside the UR: G3.6.1.1 and G3.6.1.2

### 5. Points of discussions or possible discussions

The draft revision 6 of UR G3 as agreed by Survey Panel during the 21<sup>st</sup> meeting has been sent to the Machinery Panel, who is the responsible for the captioned UR, for review and possible advices.

The Machinery Panel provided the following comments:

Paragraph	Text	Machinery Panel Comments
<b>G3.6.1.2</b>	“For valves used for isolation of instrumentation in piping not greater than 25mm, unit production testing need not be witnessed by the surveyor. Records of testing are to be available for review.”	<b>Comment 1:</b> Member society considers further that cryogenic testing for production units is impractical, costly and of limited value and should be deleted. Hydraulic testing of individual valves including tightness testing to 1.1 design pressure at ambient conditions is regarded an appropriate measure to reveal production deficiencies.



Paragraph	Text	Machinery Panel Comments
<p><b>G3.6.1.1</b> <b>G3.6.1.2</b></p>	<p>“For valves used for isolation of instrumentation in piping not greater than 25mm, prototype testing may be witnessed by an independent certification body. Records of testing are to be submitted for review.”</p> <p>“For valves used for isolation of instrumentation in piping not greater than 25mm, unit production testing need not be witnessed by the surveyor. Records of testing are to be available for review.”</p>	<p><b>Comment 2:</b> Member society thinks that the modifications should not apply to valves used for the isolation of instrumentation directly connected to type C cargo vessel at pressure above 4 bar, which should be tested using the same procedure applied to valves having diameter greater than 25 mm.</p>
<p><b>G3.6.1.1</b> <b>G3.6.1.2</b></p>	<p>“For valves used for isolation of instrumentation in piping not greater than 25mm, prototype testing may be witnessed by an independent certification body. Records of testing are to be submitted for review.”</p> <p>“For valves used for isolation of instrumentation in piping not greater than 25mm, unit production testing need not be witnessed by the surveyor. Records of testing are to be available for review.”</p>	<p><b>Comment 3:</b> The proposed revisions to IACS G3 have been noted and the following observations are offered:</p> <ul style="list-style-type: none"> <li>a. It is noted that the relaxations are only to allow; prototype testing witnessed by an independent certification body and, production testing need not be witnessed by a surveyor, it does not negate the need for the valves to be prototype and production tested.</li> <li>b. The relaxation will only be applicable when the valves are below 25 mm diameter and be installed for instrumentation applications.</li> <li>c. The relaxations would be acceptable provided: <ul style="list-style-type: none"> <li>i. The lines served by these valves are fitted with orifices in order to restrict the flow as required by Chapter 5, paragraph 5.5.5 of the Revised IGC Code, and</li> <li>ii. A more detailed technical and safety justification is provided in the HF&amp;TB for the relaxation.</li> </ul> </li> <li>d. If these relaxations are to be allowed then the wording used in; G3.6.1.1 Prototype Testing and G3.6.1.2 Unit Production Testing also needs to be amended because they currently refer to all valves.</li> <li>e. As SIGTTO have produced a document titled; ‘The Selection and Testing of Valves for LNG Applications’ it is proposed that they might be consulted on this proposed relaxation to allow their document to be updated.</li> <li>f. It is noted that the items proposed for amendment originally raised in prior message and then with the survey panel are to be separately addressed when UR G3 is revised to align with the new IGC Code.</li> </ul>
<p><b>HF&amp;TB</b></p>		<p><b>Editorial comment:</b> It is understood that the sub-header of Part A of the HF “Rev.5 (Jan 2013)” will be modified to read “Rev.6 (xxx 2015)”.</p>

During the 22<sup>nd</sup> Survey Panel meeting the comments to revision 6 have been examined and technically dealt with as follows:

- For what concern the comment 1, Panel Members concurred that a modification of the testing criteria of the cryogenic valves (working at temperature below -55°C) does not need to be modified by relaxing them. Moreover, since the current practice is not subject any critics or complaints by part of the industry, Panel consider the actual requirements feasible and accepted by the interested parties.
  - Paragraph G3.6.1.1 – following the revisions of the comments no. 2 and no. 3d, the Panel Members re-examined the proposal and concurred that since the prototype test is carried out only (at the time that a new product is submitted to the type approval procedure) the witnessing of the Classification Society Surveyor is a fundamental part of the process. Thus Panel reviewed its previous decision and concurred that the proposed modification to paragraph G3.6.1.1 has not to be considered.
  - Paragraph G3.6.1.2 - following the revisions of the comments no. 2 and no. 3c, the Members agreed that the modification introduced does not have the scope to avoid the testing of valves but rather, to allows an alternative scheme of testing. Therefore any valve will be always tested (by the manufacturer at least) and records of the testing will be available.
  - Comment no. 3e: Panel Members noted that IACS requirements already have differences; however IACS may notify this last modification to UR G3 to SIGTTO.
- Comment on HF/TB: the clerical error has been corrected.

## **6. Attachments if any**

N/A.

## **Technical Background (TB) document for UR G3 (Rev.7 Dec 2019)**

### **1. Scope and objectives**

The purpose is to revise the UR G3 (Rev.6, Jan 2016), applicable to ships complying with the old IGC Code (pre-2016 editions), in order to make it applicable to ships complying with the new IGC Code (Res.MSC.370(93) as amended.

### **2. Engineering background for technical basis and rationale**

The requirements of UR G3 (Rev.6, Jan 2016) correspond to the requirements of the old IGC Code. In the revision process those requirements of UR G3 which were found different to those of the new IGC Code have been modified to conform to the requirements of the new IGC Code and these modifications are reflected in the Revision 7 of the UR G3.

### **3. Source/derivation of the proposed IACS Resolution**

- IMO International Code for the Construction and Equipment of Ships Carrying Liquefied Gases in Bulk, Res.MSC.370(93) as amended.

### **4. Summary of Changes intended for the revised Resolution:**

The Revision 7 of the UR G3 was developed to apply to ships for which the new IGC Code is applicable.

### **5. Points of discussions or possible discussions**

- Direct references to the IGC Code are made in some parts of the UR instead of repeating the Code text.

### **6. Attachments if any**

None

## **Technical Background (TB) document for UR G3 (Rev.8 Oct 2023)**

### **1. Scope and objectives**

The purpose is to develop or revise requirements for cargo pumps and gas/liquefaction/refrigeration compressors in conjunction with a parallel revision of UR M46.

### **2. Engineering background for technical basis and rationale**

- The IGF Code in A-1, 9.9.2 reads: Compressors and pumps shall be suitable for their intended purpose. All equipment and machinery should be adequately tested to ensure suitability for use within a marine environment. Such items to be considered would include, but not be limited to .1 environmental .2 shipboard vibrations and accelerations .3 effects of pitch, heave, and roll motions, etc. and .4 gas composition.
- The IGC Code does not contain a similar requirement.
- Due to vibration problems on piston rods of piston type BOG compressor units on LNG ships during navigation at heavy sea conditions, a proposal was made for a revision of the UR to address vibration issues in the design and prototype testing of cargo pumps and gas/liquefaction/refrigeration compressors.
- Additional items such as satisfactory service history and boundary components needed further discussion.

### **3. Source/derivation of the proposed IACS Resolution**

- IMO International Code for the Construction and Equipment of Ships Carrying Liquefied Gases in Bulk, Res.MSC.370(93) as amended.
- IMO International Code of Safety for Ships Using Gases or Other Low-Flashpoint Fuels, Res. MSC.391(95) as amended.
- UR M46 Rev. 3 (Draft) Ambient conditions – Inclinations and Ship Motions (PM19923)

### **4. Summary of Changes intended for the revised Resolution:**

- A new paragraph G3.1.3 has been introduced referring to the IGC Code, thus any reference in the previous text to "Resolution MSC.370(93)" has been removed.
- Previous section 3.6.3 "Cargo Pumps" has been revised to address "Cargo Pumps and Gas/Reliquefaction/Refrigeration Compressors". The section has been restructured to include separate subsections for Cargo pumps and Gas/Reliquefaction/Refrigeration Compressors with subparagraphs on material testing, prototype testing, unit production testing and installation testing.

- In the prototype testing sections, subparagraphs containing vibration criteria have been introduced.
- The satisfactory in-service experience as an alternative to design assessment and prototype testing has been revisited, and qualified majority agreed to remove from new revision of UR.
- Notes for the expression “boundary components” for Cargo Pumps (G3.6.3.1(a)) and Gas/Reliquefaction/Refrigeration Compressors (G3.6.3.2(a)) have been added for guidance purposes only.
- The reference to UR W1 in G3.7.6 has been replaced by a reference to the IGC Code and to the society’s requirements.
- A list of standards has been inserted at the end of the document for reference.

## **5. Points of discussions or possible discussions**

- A discussion was held on whether a detailed listing of boundary components needed to be inserted in the UR or such components are subject to the society’s decision. The listing has been retained for guidance purposes.
- The origin of the listed vibration criteria has been discussed.
  - A specific vibration numerical limit of 12 mm/s overall RMS was initially proposed for the pump prototype test section, based on Internationally recognized standards such as VDI3836 and ISO 10816-1, however this was not finally agreed for insertion in the UR.
  - The numerical limit of 25 mm/s overall RMS, quoted in G3.6.3.2(b) is based on ISO 10816 -6, while the limit of 11.2 mm/s overall RMS in same subsection is based on ISO 10816-1, (ISO 20816-1:2016) Table B.1 (table C.1). As the relevant standards do not quote a single “value” as a limit due to the various power variations, installation requirements (e.g., rigid, flexible), etc., it has been suggested that the most representative of these limits are stated, based on typical such machinery units installed onboard such typical vessels, in terms of power and installation arrangements.
- Regarding the vibration limits, it has been clarified that the wording in the UR indicates that the proposed limits apply only in the absence of any applicable recognized standards by the maker or pertinent fatigue calculations,
  - For reciprocating machinery to be used for continuous operation, the vibration in all directions is to be less than 25 mm/sec overall RMS vibrational velocity on the machinery casing or on the structure in the area of bearings, from 4 to 200 Hz.
  - For rotating machinery to be used for continuous operation, the vibration in all directions is to be less than 11.2 mm/sec overall RMS vibrational velocity on the machinery casing or on the structure in the area of bearings, from 1 to 1000 Hz.

but further discussed in the Panel that;

about whether the limits of vibration criteria such as 25 mm/s and 11.2 mm/s are 'based on' ISO 10816-6 and ISO 10816-1 respectively. Regarding reciprocating machinery, the frequency range in i.e. 4 to 200 Hz, is different from ISO 10816-6 as 2 to 1000 Hz and there is no limitation in ISO 10816-6.

Regarding rotating machinery, perhaps 9.3 mm/s (RMS) is more suitable for vibration criterion.

Therefore, the panel decided to delete criteria and replace it with the text "justification is to be submitted for criteria used as reference in terms of overall root mean square (RMS) vibrational velocity value for normal operation conditions".

- Suggestions for the removal of the option of satisfactory in-service history (as an alternative to design assessment and testing) discussed within the panel did reach the qualified majority. The thought and reason behind are as LNG-Gas fuel system will be more and more trend to use in maritime shipping then IACS MP aim is encouraging manufactures to obtain approval (design approval and witnessing tests) from societies for such crucial equipment. It's understood that some IACS members may have confidence on certain reputable manufactures & product but having such sentence in UR will open door for other manufactures to claim for obtain acceptance without necessary intervention from class societies (design approval and witnessing tests) while in other hand IACS don't has unified criteria about proven in service satisfactory experience.
- One member raised the point that above may impose the cost of type approval on existing products of reputable manufacturer that their products already are in service with satisfactory.
- The various suggestions have not been reflected in the UR.
- A detailed procedure for the leak test of G3.6.3.2(d), suggested by a member (leak test procedure under operating condition at 20%, 40%, 60%, 80% and 95% of design pressure with holding time of minimum 10 minutes), did not receive the qualified majority's acceptance.
- On a query for the conditions for the performance testing of compressors whether they should correspond to the actual & design temperature of compressor (medium) or not required when not specified in the relevant standards, although there was no uniform approach as regards the test temperature (operating or design temperature), no society expressed support for the option "not required when not specified in the relevant standards". The various replies are stated below for reference:
  - ...compressors performance tests to be performed, as a minimum, at full load, rated pressure, temperature, and speed.
  - ...performance testing of compressor should be carried out under the operating conditions for which they are designed.

- ...performance testing conditions to match the design temperature, alternative medium that is like the actual medium is acceptable. Test parameters normally are specified (For example, air compressors).
- ...performance testing of compressors should correspond to the actual & design temperature of compressor (medium).
- ...performance testing should be performed under design temperature.
- ...performance test for intended service is necessary in operating pressure and temperature conditions.
- ... in cases where the test medium and temperature are not specified in the standard, the test medium does not necessarily have to be the same as the actual cargo, however the test temperature should be the lowest design temperature.

**6. Attachments if any**

None

## UR G5 “Fail-close action of Emergency Shut Down (ESD) valve”

### Summary

This UR provides requirements to ensure fail-close action of the emergency shutdown valve.

### Part A. Revision History

Version no.	Approval date	Implementation date when applicable
New (Dec 2022)	28 December 2022	1 January 2024

- **New (Dec 2022)**

#### 1 Origin of Change:

- Suggestion by IACS Member

#### 2 Main Reason for Change:

To ensure the fail-close action of ESD valve, by giving specific requirements for the actuating system as well as alarm systems.

#### 3 List of non-IACS Member classification societies contributing or participating in IACS Working Group:

None

#### 4 History of Decisions Made:

Developed by correspondence

#### 5 Other Resolutions Changes:

None

#### 6 Any hinderance to MASS, including any other new technologies:

None

#### 7 Dates:

Original Proposal	: 06 August 2022	(Ref: PM20304cIMc)
Panel Approval	: 25 November 2022	(Ref: PM20304cIMo)
GPG Approval	: 28 December 2022	(Ref: 22060_IGd)



## **Part B. Technical Background**

List of Technical Background (TB) documents for UR G5:

Annex 1. **TB for New (Dec 2022)**

See separate TB document in Annex 1.

## **Technical Background (TB) document for UR G5 (New Dec 2022)**

### **1. Scope and objectives**

The objective is to provide requirements to ensure the fail-close action of ESD valve for the actuating system as well as alarm systems in association with the requirement in 18.10.2.1.2 of the IGC Code, as amended by IMO Resolutions MSC.370(93), MSC.411(97) and MSC.441(99).

### **2. Engineering background for technical basis and rationale**

It was found that there are various requirements and arrangements for fail-close action of emergency shutdown valves (ESD valve, ref. IGC code 18.10.2), especially when such valves are actuated by hydraulic or pneumatic system. And the Machinery Panel decided to develop a Unified Requirements to ensure the fail-close action of ESD valve, setting out provisions for the actuating system and alarm systems.

### **3. Source/derivation of the proposed IACS Resolution**

This UR was initially proposed and discussed by correspondence among Members. After the development of the draft UR, it was further reviewed and confirmed by SIGTTO (a representative of industry).

### **4. Summary of Changes intended for the revised Resolution:**

None

### **5. Points of discussions or possible discussions**

There were two opinions with respect to requirements for alarm in 2.1 of the UR G5 as follows in square bracket:

*Audible and visible alarm shall be given [in any of both the events of loss of pressure or activation of fail-close action]/[in the event of loss of pressure that causes activation of fail-close action]. The alarm shall be provided in a normally manned control station (e.g. Cargo Control Room and/or the navigation bridge, etc.).*

Now that both options are a matter of expression on the same requirement, it was agreed to include the issue in the Industry Hearing (SIGTTO) and it has been decided to adopt the second option taking into account the Industry Response:

*We are content with the proposed recommendation and suggest the second option in paragraph 2.1.1 would be most appropriate i.e. alarm on loss of pressure*

### **6. Attachments if any**

None

# IACS

INTERNATIONAL ASSOCIATION OF CLASSIFICATION SOCIETIES LTD.  
PERMANENT SECRETARIAT: 36 BROADWAY, LONDON, SW1H 0BH, UNITED  
KINGDOM

TEL: +44(0)207 976 0660 FAX: +44(0)207 808 1100  
INTERNET: [permsec@iacs.org.uk](mailto:permsec@iacs.org.uk) Web Site: [www.iacs.org.uk](http://www.iacs.org.uk)

---

Jan 2024

## **History Files (HF) and Technical Background (TB) documents for URs concerning new fuels and other energy sources (UR H)**

<b>Res. No.</b>	<b>Title</b>	<b>Current Rev.</b>	<b>HF/TB?</b>
UR H1	Control of Ammonia releases in Ammonia fuelled vessels	New Jan 2024	HF

# UR H1 "Control of Ammonia releases in Ammonia fuelled vessels"

## Summary

This UR provides requirements for releases of ammonia from the onboard systems for bunkering, storing, preparing and using ammonia as fuel. It addresses normal operation as well as abnormal and emergency scenarios.

## Part A. Revision History

Version no.	Approval date	Implementation date when applicable
New (Jan 2024)	16 January 2024	01 January 2025

### • New (Jan 2024)

#### 1 Origin of Change:

- Request by non-IACS entity
- Suggestion by IACS member

#### 2 Main Reason for Change:

Considering the variety of exposure threshold levels related to the toxicity of Ammonia, there is a need for IACS to unify exposure levels on board ships, and establish basic safety principles relevant to releases of ammonia.

#### 3 List of non-IACS Member classification societies contributing or participating in IACS Working Group:

None

#### 4 History of Decisions Made:

It was considered that different condition/scenarios (normal/abnormal/emergency) are to be addressed by separate requirements.

#### 5 Other Resolutions Changes:

None

#### 6 Any hinderance to MASS, including any other new technologies:

The basic principles relating to MASS have been taken into account while developing new and revised IACS Resolutions; reconsideration of some requirements may be needed in case of fully automated and unmanned ships, because the risk of ammonia

toxicity on such ships is to be mitigated by the absence of people, but special consideration is to be given to specific operational scenarios (e.g. ammonia bunkering, maintenance) where personnel might be present even on a fully autonomous ship.

**7 Dates:**

Original Proposal:	25 October 2022	(Made by: Machinery Panel)
Panel Approval:	20 December 2023	(Ref: PD22019_IDo)
GPG Approval:	16 January 2024	(Ref: 22044aIGq)

\*\*\*\*\*

## **Part B. Technical Background**

List of Technical Background (TB) documents for UR H1:

Annex 1. **TB for New (Jan 2024)**

See separate TB document in Annex 1.

## **Technical Background (TB) document for UR H1 (New, Jan 2024)**

### **1. Scope and objectives**

Considering the variety of exposure threshold levels related to the toxicity of Ammonia, there is a need for IACS to propose unified exposure levels on board ships, and establish basic safety principles relevant to releases of ammonia.

The term "ammonia" means anhydrous or nearly anhydrous ammonia, having suitable composition and quality to be stored and used onboard as marine fuel.

### **2. Engineering background for technical basis and rationale**

- 2.1 Ammonia is recognised as being toxic to human life and to aquatic life. Therefore, in normal conditions, contact with ammonia, exposure to ammonia vapours and discharge of ammonia-containing effluents is to be avoided. The best method to mitigate risks is to require that the systems for its containment are designed such that they do not release ammonia, at least in normal conditions.
- 2.2 Acknowledging that even in normal conditions there are special cases where ammonia cannot be fully contained (e.g. small amounts of ammonia vapours trapped in the coupling could be released when disconnecting bunkering hoses), it is considered necessary to identify these cases in a risk assessment and arrange the systems so that released ammonia getting to spaces where people normally have access will have a concentration below a specific threshold level. With reference to normal operations, the concentration threshold was selected as a concentration which may be tolerated for long periods (25 ppm corresponding to the NIOSH REL-TWA (Recommended Exposure Level – Time Weighted Average)).
- 2.3 Considering that it is presently not possible to establish the actual behaviour of an ammonia vapour plume (also depending on the quantity of the ammonia being released and boundary conditions such as wind speed and obstructions in the area), it was agreed that the expected concentration of ammonia in way of spaces where people normally have access is to be demonstrated by gas dispersion analysis, however IACS acknowledges that when more experience will be gained, typical separation distances might be applied instead of gas dispersion analysis for each case; when the need and opportunity arises, this will be accommodated by a revision of the UR.
- 2.4 Taking into account that ammonia will be stored in a liquefied phase, obtained either by refrigeration or compression or a combination of both, it was acknowledged that there could be both abnormal scenarios (e.g. in case of malfunction of equipment or off-design conditions), and emergency scenarios (e.g. collision, fire) in which ammonia cannot be contained (either for impossibility or for safety concerns like excessive pressure) and is to/will be released. Such cases are to be identified in a risk assessment and a gas dispersion analysis is to be carried out. Depending on the results of these analyses, necessary measures are to be taken to prevent all persons onboard being exposed to hazardous ammonia concentrations (in the context of

abnormal/emergency scenarios, dangerous ammonia concentration for short term exposure is defined as a concentration of 300 ppm or more).

The necessary actions or mitigation measures are not established by the UR, and a variety of them depending on the specific scenario may be considered (e.g. availability or use of specific PPE when entering specific spaces or areas, installation of ammonia treatment systems, arranging of spaces on the ship as "safe heavens" with special life support arrangements).

- 2.5 In order to warn the people on board of possible hazards, the points at which ammonia is typically released (vent mast) are to be equipped with gas detectors giving audible and visual alarms when ammonia is released at a concentration exceeding 300 ppm, so that people may readily avoid/abandon the resulting toxic area and take refuge.
- 2.6 Spaces which have reasonably foreseeable ammonia leak points (secondary enclosure, fuel preparation room), are required to be equipped with gas detection, monitoring and alarm system. These are typically not manned spaces and the systems should be capable of preventing release, but in order to prevent escalation, when the concentration reaches 300 ppm the safety action of shutting down the source of release is to be taken (e.g. by closing the tank valve or, depending on the location of the detected leak, the master valve).

## **2a. Specification of the data utilised in the development/revision of the proposed IACS Resolution, if any**

Ammonia boiling point at atmospheric pressure (100 kPa) : -32 °C

Ammonia vapour saturation pressure at 25°C : 1003 kPa

Ammonia vapour saturation pressure at 45°C : 1781 kPa

IMO CCC9-3-2 (Republic of Korea): "Study on Safety Assessment of Ammonia Toxicity"

## **3. Source/derivation of the proposed IACS Resolution**

IMO CCC9-3-1 (ITF and Republic of Korea): "Proposal for Safety Principles and Draft Safety Provision against Toxicity for Development of Guidelines for Ships Using Ammonia as Fuel"

## **4. Summary of Changes intended for the revised Resolution:**

NEW

## **5. Points of discussions or possible discussions**

- 5.1 There was discussion about definitions of normal operation, abnormal scenario and emergency scenario; the agreed definitions are based on the assumption that:
  - abnormal scenario is a predictable condition where systems are operating outside of the intended condition, but due to the predictability of the condition and the countermeasures taken the scenario does not present hazard(s)



- an emergency scenario is a condition which is not predictable and/or there are not available sufficient countermeasures to mitigate the hazard(s).
- 5.2 there was a proposal to add "condition" beside the wording "scenario" in Para. 3.1, 3.2, and 4.3.2, but this was dropped due to the wording "scenario" was used to give the idea of a wider picture, in which the condition of some systems or equipment is only one part, therefore the addition of "condition" beside the wording "scenario" was considered not suitable.
- 5.3 There was discussion about possibility of requiring specific separation distance between point of release and spaces where people are normally present (instead or requiring gas dispersion analysis), but it was finally agreed that there is not enough experience so far to establish the correct figure, and that these may depend on many factors; also the option of introducing a compromise text referring to "equivalent method" to gas dispersion analysis, thus opening to future experience-based alternatives was considered, but finally dropped in consideration of the need of clarity and uniformity of application
- 5.4 There was discussion about inclusion in 4.3.1 of additional examples of cases of normal operations where release of ammonia is unavoidable (and that are to be identified in the risk assessment):
- "during storage"
  - "fuel preparation"
  - "Ventilation out of Fuel preparation Room and TCS"
  - "purging, venting and bleeding of fuel supply piping"

These were finally not accepted because:

- "during storage" is unclear in its meaning during bunkering or during idle periods or all cases that ammonia is kept stored in the tank, and also gives the idea that releases from storage tank are unavoidable, but this should not be the case.
  - "fuel preparation" is unclear, in that "fuel preparation" is a specific action that is carried out for using the fuel but does not identify a specific condition; also, releases during fuel processing should be avoided, as required in Paragraph 4.1 of the UR
  - "Ventilation out of Fuel preparation Room and TCS" is not a condition that implies release of ammonia, unless ammonia is leaking, but this case qualifies as an abnormal scenario
  - "purging, venting and bleeding of fuel supply piping" gives the idea that these are normal operations implying unavoidable release of ammonia, which instead should be avoided by design, as required in Paragraph 4.1 of the UR.
- 5.5 There was discussion about inclusion in 4.3.2 of additional examples of cases of abnormal scenarios where possible releases of ammonia could occur (and that are to be identified in the risk assessment):

- "Gas purging after gas detection at annular space or other process room"
- "PRV open to protect BOG compressor or fuel pump"
- "Forced ventilation from FPR after ammonia release"

The outcome of the discussion was that:

- "Gas purging after gas detection at annular space or other process room" was included because it describes a scenario where a leak occurred and was collected in the double piping or other process room and there is the need of purging.
- "PRV open to protect BOG compressor or fuel pump" was not accepted because in case a PRV fitted downstream of a BOG Compressor, releasing ammonia to atmosphere may be avoided by ducting the PRV outlet to the intake of the Compressor or pump.
- "Forced ventilation from FPR after ammonia release" was combined with the case of "Gas purging after gas detection at annular space or other process room", thus reading "Gas purging or ventilation after gas detection at annular space or other process room".

## **6. Attachments if any**

None

# IACS

INTERNATIONAL ASSOCIATION OF CLASSIFICATION SOCIETIES LTD.  
PERMANENT SECRETARIAT: 36 BROADWAY, LONDON, SW1H 0BH, UNITED  
KINGDOM

TEL: +44(0)207 976 0660 FAX: +44(0)207 808 1100

INTERNET: [permsec@iacs.org.uk](mailto:permsec@iacs.org.uk) Web Site: [www.iacs.org.uk](http://www.iacs.org.uk)

---

Jan 2023

## History Files (HF) and Technical Background (TB) documents for URs concerning Polar Class (UR I)

Res. No.	Title	Current Rev.	HF/TB?
UR I1	Polar Class Descriptions and Application	Rev.2 Apr 2016	HF
UR I2	Structural Requirements for Polar Class Ships	Rev.4 Dec 2019	HF
UR I3	Machinery Requirements for Polar Class Ships	Rev.2 Jan 2023	HF

## UR I1 “Polar Class Description and Application”

### Part A. Revision History

Version no.	Approval date	Implementation date when applicable
Rev.2 (Apr 2016)	22 April 2016	1 July 2017
Corr.1 (Oct 2007)	5 October 2007	-
Rev.1 (Jan 2007)	18 January 2007	1 March 2008
New (Aug 2006)	22 August 2006	1 July 2007

- **Rev.2 (Apr 2016)**

**.1 Origin for Change:**

- Other (*Updated as a consequence of the revision of UR12*)

**.2 Main Reason for Change:**

The UR I1 was updated as a consequence of the revision of UR I2. This concerns the introduction of specific requirements for the notation Icebreaker, as well as proposed requirements and assumptions with regard to hull form, performance, and operational limitations.

See TB document in Part B.

**.3 List of non-IACS Member Classification Societies contributing through the TC Forum and/or participating in IACS Working Group:**

None

**.4 History of Decisions Made:**

See TB document in Part B.

**.5 Other Resolutions Changes**

None

**.6 Dates:**

Panel Approval: 15 March 2016 (Ref: 6023a)  
GPG Approval: 22 April 2016 (Ref: 12187\_IGh)

- **Corr.1 (Oct 2007)**

No records available.

- **Rev.1 (Jan 2007)**

Council agreed to revise the application date of the UR for the purpose of uniform application by IACS Societies.

- **New (Aug 2006)**

No records available.

## Part B. Technical Background

List of Technical Background (TB) documents for UR I1:

Annex 1. **TB for New (Aug 2006)**

See separate TB document in Annex 1.



Annex 2. **TB for Rev.2 (Apr 2016)**

See separate TB document in Annex 2.



**Note:** *There are no Technical Background (TB) documents available for Rev.1 (Jan 2007) and Corr.1 (Oct 2007).*

**IACS AHG/PSR****IACS UR I1 - Polar Class Descriptions and Application****- Technical Background -****1.0 Historical Development**

An international effort has been made in the development of a uniquely integrated package of measures aimed at protecting life, property and the environment in polar waters. This so-called “harmonisation” process began when several nations recognised the benefits of aligning existing safety and pollution control standards for marine operations in polar waters, and of giving these more general applicability. Germany and Russia made proposals to IMO in the early 1990’s, and these resulted in discussions amongst various interested governments who formed a working group to develop an appropriate approach. This Outside Working Group (OWG) reported its formation and aims to IMO in 1993, and was subsequently expanded to include members from industry, academic and research communities and representatives from classification societies. The efforts of the OWG culminated in the development of the IMO *Guidelines for Ships Operating in Arctic Ice-Covered Waters*, which was promulgated in December 2002 as a joint MSC/MEPC circular (MSC/Circ.1056, MEPC/Circ.399).

The structure and format of the IMO *Guidelines* are divided into construction, equipment, operational and environmental protection sections, although the *Guidelines* themselves include only a minimal set of direct technical requirements for construction. Instead, they outline performance standards and reference compliance with IACS Unified Requirements for Polar Ships as demonstrating adequate performance. Accordingly, in May of 1996, IACS GPG established a “non-permanent” Ad-Hoc Group to establish Unified Requirements for Polar Ships (AHG/PSR), with one working group for structural requirements and one for machinery requirements. Notably, the AHG/PSR also includes non-IACS working members who have expertise and knowledge to assist in the development of requirements for this specialised subject. The efforts of AHG/PSR have resulted in three sets of unified requirements for Polar Ships; UR I1 (Polar Class Descriptions and Application); UR I2 (Structural Requirements for Polar Class Ships); UR I3 (Machinery Requirements for Polar Class Ships).

**2.0 Scope and Objectives**

The scope of UR I1 includes neither structural nor machinery requirements. The objective of UR I1 is simply to specify the application of the structural and machinery requirements for polar ships (UR I2 and UR I3), and to provide descriptions of the various polar classes used throughout these requirements to convey differences with respect to operational capability and strength.

**3.0 Points of Discussions or Possible Discussions****3.1 Application**

The unified requirements for polar ships are to be applied to any ships constructed of steel and navigating in ice-infested polar waters, except for icebreakers. Icebreakers are defined as any ship (1) having an operational profile that includes escort or ice management functions, (2) having powering and dimensions that allow it to undertake aggressive operations in ice-covered waters, and (3) having a class certificate endorsed with this notation.

**3.2 Polar Classes**

A total of seven polar classes are described in UR I1 in terms of nominal ice conditions based on WMO sea ice nomenclature. It should be noted that these descriptions are very general, due to the

## IACS AHG/PSR

### IACS UR I1 - Polar Class Descriptions and Application

#### - Technical Background -

considerable variability of ice conditions in polar waters. The overall intent in defining the technical requirements for each class has been to provide a relatively smooth increase in requirements (and cost) to assist owners in matching the requirements for the ship with its intended voyage or service. It will still be possible to damage any polar class ship by careless operation, accounting for the emphasis placed on operational issues in the IMO *Guidelines* which, of course, have the same polar class descriptions.

One possible point of future discussion concerns the two lowest IACS polar classes PC6 and PC7. These classes are recognised in the IMO Guidelines as nominally equivalent to the Finnish-Swedish ice classes 1AS and 1A. To minimise the cost and design efforts required for ships that are to operate in the Baltic Sea during the winter season and in Arctic waters during the summer season, official recognition of these equivalencies by the Finnish and Swedish Maritime Administrations has been obtained. Due to future rule development on both sides, co-ordination between IACS and the Baltic Administrations are required to maintain these equivalencies.

#### 4.0 Source/Derivation of Proposed Requirements

As noted in the foregoing, UR I1 is a consequence of the international effort to harmonise standards for marine operations in polar waters, and is directly connected with the IMO *Guidelines for Ships Operating in Arctic Ice-Covered Waters* (MSC/Circ.1056, MEPC/Circ.399).

#### 5.0 Appendices

For further background information concerning UR I1, reference is made to:

IMO *Guidelines for Ships Operating in Arctic Ice-Covered Waters* (MSC/Circ.1056, MEPC/Circ.399).



## **Technical Background (TB) document for UR I1 (Rev.2 Apr 2016)**

### **1. Scope and objectives**

The UR I1 was updated as a consequence of the revision of URI2. This concerns the introduction of specific requirements for the notation Icebreaker, as well as proposed requirements and assumptions with regard to hull form, performance, and operational limitations.

### **2. Engineering background for technical basis and rationale**

See attachment.

### **3. Source/derivation of the proposed IACS Resolution**

None.

### **4. Summary of Changes intended for the revised Resolution:**

See attachment.

### **5. Points of discussions or possible discussions**

See attachment.

### **6. Attachments if any**

Attachment: *PT 49 – Technical background to UR I1 and UR I2 revision proposals.*

# PT 49 – Technical background to UR I1 and UR I2 revision proposals

IACS Hull Panel Project team 49

03 March 2016

## Introduction

This document describes the rationale and background for the Rule proposal developed by PT 49 on the revision of IACS Unified Requirements for Polar Class Ships, UR I2.

The proposal covers the following aspects:

- Design loads for non-icebreaking bows
- Requirements for icebreaker notation
- Strength evaluation of web frames and stringers

The proposal includes changes in I1 which are related to the introduction of the specific icebreaker requirements. As a consequence of specifying the application of blunt and bulbous bows, some requirements or assumptions to the hull form, performance, and operational limitations are included as well. This is discussed in more detail below.

A proposal originating from the I3 working group related to propeller submergence has been included in I1.

In the original scope of work, design requirements for rudders as well as evaluation of ice compression loads were included. Due to time and budgetary constraints, these tasks have not been prioritized at this stage. These items should be reassessed in the next revision phase.

Some proposals developed as part of this revision work did not reach agreement within the group, and are hence been left out from the final UR I revision proposal. Some references to these proposals are however included and discussed for possible use in later revisions.

General acceptance criteria for direct calculations for web frames and girders have been included in the rule proposal, and it is opened up for both linear and non-linear calculation methods. However, detailed procedures for how these structures are to be evaluated is not included, and it is considered crucial that a common approach is developed to ensure consistent practice and interpretation among the classification societies. Hence, it is advised that that a separate group is tasked to develop a detailed guidance describing suitable evaluation procedures for web frames and stringers.

A general clean-up of the rule text has been carried out to correct typos, inconsistencies etc.

## Task 1 – Design loads for non-icebreaking bows

### Introduction

The rule design load formulation for dimensioning of the bow structure is according to IACS UR12 only valid for vessels with icebreaking forms. The definition of *icebreaking form* is however non-existent, but it is reasonable to assume that the term excludes vessels with bulbous bows, or vessels with extreme blunt or vertical bow forms. The aim of the current revision has been to clarify the applicability of the existing load formulation, and specify alternative methods, or limitations, for other bow forms not covered by the existing formulation. In addition, other relevant requirements which depend on the bow form are addressed, including longitudinal strength requirements and design accelerations as given in I3.

### Background and summary of the new rule proposal

The Polar Class requirements do not give any explicit limitations with regard to hull form for any ice class. It is however evident that the rule requirements are developed with traditional icebreaking designs in mind, on which also most of the operational experience and validations have been based. The rules are seen to be less applicable for unconventional designs, with one of the most apparent deficiencies being the definitions of the design loads.

In the new revision proposal, the text in I1 is amended to emphasize that the Polar Class notations are developed for ships intended for independent operation in ice-infested polar waters. This has clearly been the basis for the development, and should be stated explicitly stated in the Rules.

Although intended for independent operation and customized for traditional icebreaking forms, the Polar Class notations have been applied on vessels with alternative designs. These include traditional commercial vessels with hull shapes optimized for open water, for which the (two) lower Polar Classes are considered to be a possible alternative to the (two) highest Baltic classes. In addition, ship-shaped offshore units have been assigned higher Polar Class notations without being designed for independent operation in ice. Increased focus on energy efficiency and multi-functional vessels calls for innovative solutions which will not necessary be covered by the hull families considered during the initial development of the rules. Hence, in the new revision proposal, design procedures for alternative designs have been addressed.

The load formulation which is basis for the Polar Class strength requirements is based on a set of ship/ice interaction scenarios, which are considered to be the most demanding design cases for “standard” polar class vessels. During the development of the Rules, dozens of different ship/ice interaction scenarios were identified and considered potentially relevant for structural design. Preferably the governing design scenario for any part of the hull should be chosen from a “library” of relevant scenarios, depending on ship size, type, shape, class etc. However, in the current rules, two selected scenarios are considered to be governing, namely:

- Ramming scenario
- Glancing impact scenario

The ramming scenario is considered to be governing for the longitudinal strength, while the glancing impact scenario is considered to be dimensioning for the structural design of the bow (and used as basis for the remaining part of the hull structure). During the development of the rules, the ice compression scenario was also considered as potentially governing for the transverse strength of the midship structure, but have until now not been addressed explicitly in the Rules.

The reasons for imposing limitations with regard to bow form to the original design load formulation are not explicitly explained in the available background documentation. One reason may be the fact that alternative designs were not considered during the development of the rules, and that the limitation is a simple consequence of insufficient validation and verification. In any case it is reasonable to assume that possible limitations are related to the validity of the assumption that the glancing impact actually is the governing scenario, and/or the validity of the derivation of the load formulation itself. These will be discussed in more detail below.

When it comes to the derivation of the load formulation, several assumptions which potentially could limit the applicability of the formulation are discussed below. Extremities lie typically within this category, and are often not covered by any validation or calibration against available full scale and model test data. As mentioned above, the main focus during the development was on traditional icebreaking bows, and other bow shapes including bulbous bows were not part of the evaluation. Consequently, no validations or calibrations of such hull shapes are found. However, if the applicability of the load formulation should be limited to the bow forms considered during the development of the Rules, many bow forms which easily can be classified as “icebreaking” will be excluded. Other aspects limiting the applicability are discussed below, including approximations introduced by the simplified hull shape coefficient  $f_a$ , the limitations introduced with regard to the patch aspect ratio, and the relevancy of the assumed shape of the ice footprint area.

In the current Rule proposal, the term *icebreaking form* has been removed. Instead, the validity of the existing load formulation has been defined by introducing limitations on bow angles.

Certain limitations to the hull form have been introduced for ice classes PC1-PC5. These vessels are normally purpose-built for operation in difficult ice conditions, and bow forms which are not considered effective for ice operation should generally be avoided. For the higher ice classes, bows with vertical sides and bulbous bows are examples which are not considered effective.

A paragraph addressing the expectation that Polar Class vessels should be able to operate independently in ice conditions representative for the ice class have been added in I1. However, requirements to hull form and performance should not restrict the application of new, innovative or other purpose-built designs which do not fit directly into the formulations, but these should be subject to special consideration by each Society.

For PC6 and PC7, open water bows including bows with vertical sides and bulbous bows may be accepted, and alternative load formulations have been developed for these cases. In general, bulbs should be treated as a structural appendage, i.e. the own structural requirements should not drive those of the overall structure.

The longitudinal strength requirements and the design accelerations given in URI3.6 are derived based on the vertical force component in the bow obtained from a ramming impact scenario. In the

current proposal, a paragraph is added to emphasize that the basis for the requirements is the ramming scenario. This is consistent with I2.3.1 (i) for bow design loads.

Intentional ramming is not considered to be a relevant operational scenario in design ice conditions for bows with vertical sides or bulbous bows (PC6 and PC7). Hence, the longitudinal strength requirement, as well as the design accelerations based on the ramming, and the requirements will hence not be relevant for these vessels. In the rules, it is stated that this should be specified in the Class certificate or equivalent.

### Application of design load formulation for dimensioning of bow structure

For the glancing impact scenario, on which the derivation of the design load for dimensioning of the bow structure is based, the ship is assumed to strike an ice edge of infinite mass with the bow shoulder as shown in Figure 1. During the collision, the ship will penetrate the ice until the normal velocity is zero, and the ship rebounds away. The footprint for a given penetration depth  $\delta$  will take form of a triangle and is limited by the width  $W$  and height  $H$ .

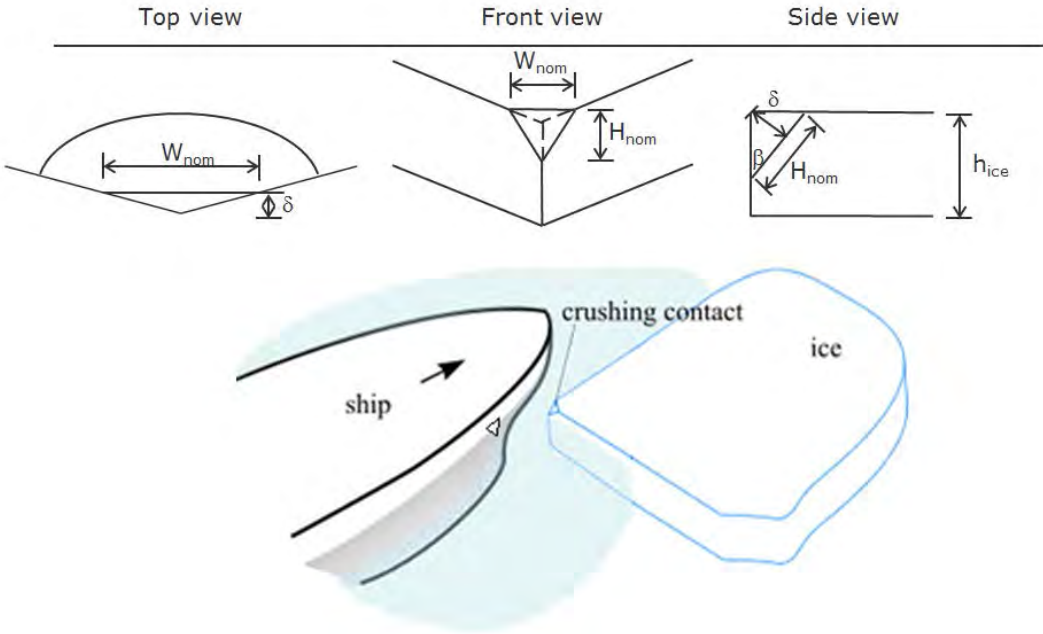


Figure 1 Design scenario for the general glancing impact collision, indicating the nominal contact geometry

The design force is found by assuming that all the initial normal kinetic energy is transformed into crushing energy of the ice. Given the initial geometry of the ice, the resulting triangular footprint is determined from the shape of the bow based on the final penetration depth. Hence, the derivation of the design load and the corresponding footprint area is a result of a simple geometry consideration as long as the vertical extent of the footprint does not exceed the assumed thickness of the ice floe.

As discussed above, the following aspects may impose limitations on the rule formulation:

- Relevancy of the glancing impact scenario for a given hull form

- Accuracy of derived load formulation

Based on available background documentation and evaluations carried out during the revision work, it has not been possible to justify the use of other scenarios than the glancing impact as governing design scenario for any specific bow form. Hence it is proposed to continue using the glancing impact scenario as basis for the dimensioning of the bow.

Regarding the derivation of the load formulation itself, aspects which potentially could justify limitations on the applicability of the load formulation are discussed below.

In the present bow design load formulation, the bow form dependency is represented by the shape coefficient  $fa$ , where the smaller of the crushing or flexural strength shape coefficient is used. For most conventional icebreaking bow forms, the crushing strength is normally governing, and is hence focused on below. Due to a complex equation for the crushing strength, a simplified expression has been used in the Rules. In Figure 2 (extracted from the background document for ice impact loads) the exact vs. the rule  $fa$ -factor is compared for four bow forms, and it is seen that the simplified expression may generate conservative high forces compared with the exact expression for certain bow forms (e.g. landing craft bows), and a cut-off value of 0.6 is introduced to avoid extreme values. Consequently, the upper limit of the  $fa$ -factor is for these cases considered more related to the introduction of the simplified rule expression than to represent a limitation on the general load scenario or formulation itself.

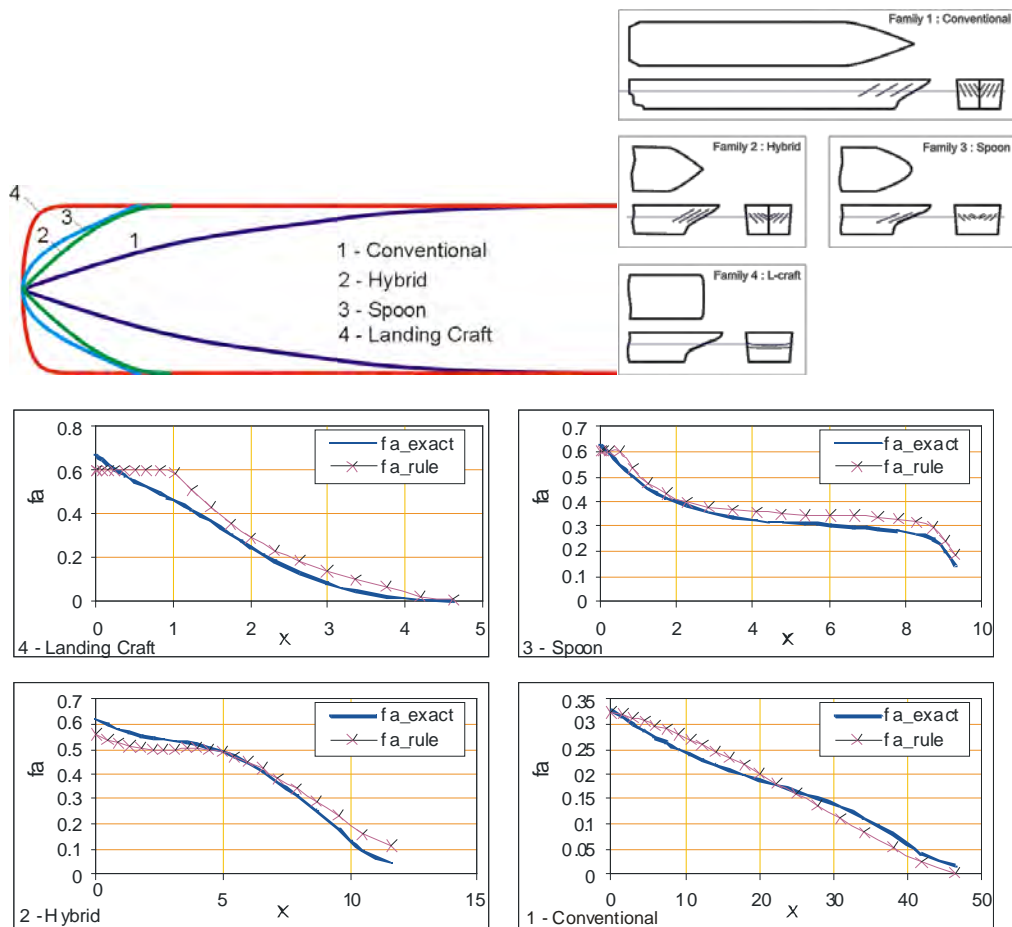


Figure 2 Comparison of exact and rule  $fa$ -coefficient for considered hull forms (I2 Background Notes)

The bow forms shown in Figure 2 have different waterplane shapes ranging from conventional to landing craft bows. When introducing the upper limit of the fa-coefficient, it is reasonable to conclude that all these bow forms lie within the application range of the load formulation. Hence, it is difficult to see that this will cause any limitations with regard to waterline angles alone.

A second aspect is related to the limitations introduced in connection with the evaluation of the corresponding contact patch area. The size of the contact area is determined based on the ratio between the calculated width and height of the triangular footprint area obtained from the collision impact scenario. To avoid that the aspect ratio approaches zero, a lower limit of 1.3 has been introduced, which corresponds to a normal frame angle of  $10^\circ$ . The existence of such a lower limit may indicate that frame angles at least down to  $10^\circ$  can lie within the validity range of the formulation.

The third aspect is related to the validity of the assumption that the crushed volume of the ice is shaped like a triangular pyramid. This is in general valid as long as the vertical projection of the contact area is less than the assumed thickness of the ice floe. This assumption may be expressed by the following form:

$$H_{vert} = 0.366 \cdot F_n^{0.556} \cdot P_0^{-0.556} \cdot \sin(\beta')^{-0.5} \cdot \cos(\beta') \leq h_{ice}$$

Although somewhat complicated, it is possible to evaluate the combination of waterline angles  $\alpha$  and normal frame angles  $\beta'$  which violates the assumption, depending on the ice class and displacement of the vessel. Some initial evaluations indicate that this may be relevant for frame angles up to  $10$ - $15^\circ$  for larger vessels with the lowest ice classes PC6 and PC7.

It is worth mentioning that the possible limitation discussed above is only relevant as long as the defined ice thickness  $h_{ice}$  is assumed to have a physical meaning for the crushing impact scenario, and not only a “scale” parameter defining the flexural strength of the ice.

Considering the aspects above, it is very difficult to define hull angles where it is obvious that the existing load formulation is not valid. It is however reasonable to consider the formulation less applicable for vessels with small normal frame angles  $\beta'$ , particularly in combination with larger water plate angles  $\alpha$  (i.e. blunt or “shoe-box” shaped bow forms).

In the rule proposal, it is suggested to consider the existing load formulation valid for bow forms where the buttock angle,  $\gamma$ , at the stem is positive and less than  $80^\circ$ , and where the normal frame angle  $\beta'$  at the centre of the foremost sub-region of the bow is equal to or larger than  $10$  degrees. A limit of  $10^\circ$  is, beyond what have been discussed above, considered to be a practical compromise, which ensures that most traditional designs are covered by the formulation. Such a limit will at the same time exclude most of the unconventional designs. However, bearing in mind the original “icebreaking bow” statement, the proposal will now cover bow forms which easily can be classified as “non-icebreaking”.

For bows with vertical sides not fulfilling the bow angle criteria proposed for the existing load formulation above, an alternative formulation has been developed based on the same glancing impact scenario. When the normal frame angle approaches zero, the vertical projection of the nominal contact area becomes equal to the assumed thickness of the ice, and may be defined as shown in Figure 3. The derivation of the impact forces generated from such a scenario is seen to be

somewhat complicated and not well suited for rule application unless a simplified expression is introduced. However, a formulation for the special case where the normal frame angle is  $0^\circ$  (vertical sides), as shown in Figure 4, may be a feasible alternative for such designs. The load formulation is presented in Appendix B.

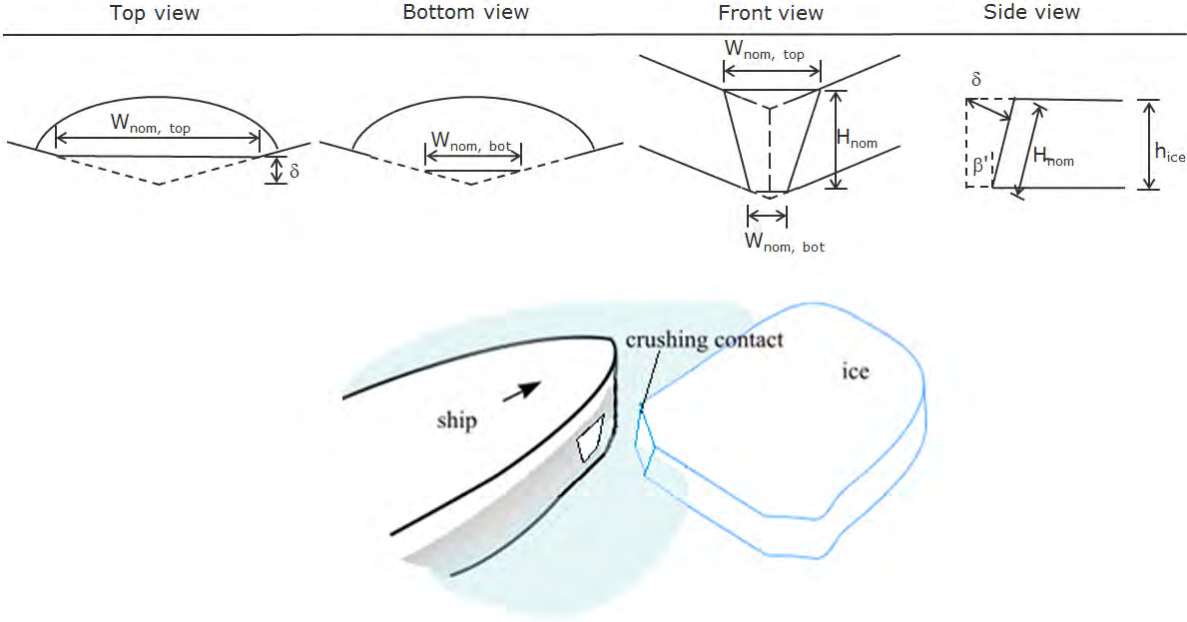


Figure 3 Glancing impact collision where the vertical projection of the contact area equals the ice thickness

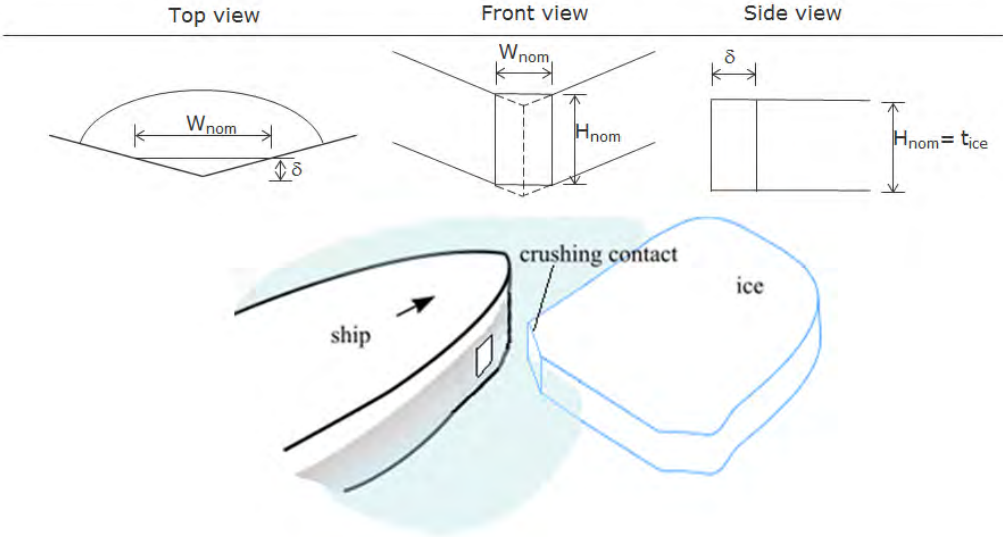


Figure 4 Glancing impact collision for a bow with vertical sides ( $\beta=0^\circ$ )

For the case where the normal frame angle is  $0^\circ$  (vertical sides), the design force  $F$ , line load  $Q$ , and pressure  $P$  become:

$$F_n = f_a \cdot P_0^{0.526} \cdot V_{ship}^{0.947} \cdot h_{ice}^{0.474} \cdot \Delta_{ship}^{0.474}$$



$$Q = F_n^{0.222} \cdot P_0^{0.778} \cdot h_{ice}^{0.7}$$

$$P = F_n^{0.555} \cdot P_0^{0.445} \cdot h_{ice}^{-0.6}$$

As for the existing load formulation, the terms  $P_0$ ,  $V_{ship}$ , and  $h_{ice}$ , may be represented by class factors. Assuming that:

$$CF_{CV} = P_0^{0.526} \cdot V_{ship}^{0.947} \cdot h_{ice}^{0.474}$$

$$CF_{DV} = P_0^{0.778} \cdot h_{ice}^{0.7}$$

$$CF_{PV} = P_0^{0.445} \cdot h_{ice}^{-0.6}$$

the parameters read:

$$F_n = f_a \cdot CF_{CV} \cdot \Delta_{ship}^{0.474}$$

$$Q = F_n^{0.222} \cdot CF_{QV}$$

$$P = F_n^{0.555} \cdot CF_{PV}$$

The class factor  $CF_{C,vert}$  may be given as follows for the different ice classes:

Ice class	$CF_{CV}$	$CF_{QV}$	$CF_{PV}$
PC 6	3.43	2.82	0.65
PC 7	2.60	2.33	0.65

The  $f_a$ -factor is proposed to be:

$$f_a = \frac{\alpha}{30}$$

The alternative load formulation presented above is suggested to be used for bows with vertical-like sides, where the normal frame angle  $\beta'$  is between 0-10° at the centre of the foremost sub-region of the bow. In Table 1 to Table 4, a comparison between the new vertical bow formulation and the existing formulation (with frame angle  $\beta' = 10^\circ$ ) is presented for a range of ship sizes and waterplane angles.

**Table 1 Comparison of design force – existing formulation vs. proposed blunt/vertical bow formulation – PC7**

Waterplane angle $\alpha$	Design force - PC7							
	$\Delta = 10$ kt		$\Delta = 25$ kt		$\Delta = 50$ kt		$\Delta = 100$ kt	
	Existing formulation ( $\beta' = 10^\circ$ ) [MN]	Blunt bow formulation [MN]	Existing formulation ( $\beta' = 10^\circ$ ) [MN]	Blunt bow formulation [MN]	Existing formulation ( $\beta' = 10^\circ$ ) [MN]	Blunt bow formulation [MN]	Existing formulation ( $\beta' = 10^\circ$ ) [MN]	Blunt bow formulation [MN]
20	4.1	5.1	7.3	7.9	11.4	10.9	17.7	15.1
25	4.7	6.4	8.5	9.8	13.2	13.6	20.6	18.9
30	4.7	7.7	8.5	11.8	13.2	16.3	20.6	22.6
35	4.7	9.0	8.5	13.8	13.2	19.1	20.6	26.4
40	4.7	10.2	8.5	15.7	13.2	21.8	20.6	30.2
45	4.7	11.5	8.5	17.7	13.2	24.5	20.6	34.0

Table 2 Comparison of design force – existing formulation vs. proposed blunt/vertical bow formulation – PC6

Waterplane angle $\alpha$	Design force - PC6							
	$\Delta= 10$ kt		$\Delta= 25$ kt		$\Delta= 50$ kt		$\Delta= 100$ kt	
	Existing formulation ( $\beta'=10^\circ$ ) [MN]	Blunt bow formulation [MN]	Existing formulation ( $\beta'=10^\circ$ ) [MN]	Blunt bow formulation [MN]	Existing formulation ( $\beta'=10^\circ$ ) [MN]	Blunt bow formulation [MN]	Existing formulation ( $\beta'=10^\circ$ ) [MN]	Blunt bow formulation [MN]
20	5.4	6.7	9.7	10.4	15.2	14.4	23.6	19.9
25	6.3	8.4	11.3	13.0	17.6	18.0	27.4	24.9
30	6.3	10.1	11.3	15.6	17.6	21.6	27.4	29.9
35	6.3	11.8	11.3	18.2	17.6	25.2	27.4	34.9
40	6.3	13.5	11.3	20.8	17.6	28.8	27.4	39.8
45	6.3	15.2	11.3	23.4	17.6	32.4	27.4	44.8

Table 3 Comparison of design pressure – existing formulation vs. proposed blunt/vertical bow formulation – PC7

Waterplane angle $\alpha$	Design pressure - PC7							
	$\Delta= 10$ kt		$\Delta= 25$ kt		$\Delta= 50$ kt		$\Delta= 100$ kt	
	Existing formulation ( $\beta'=10^\circ$ ) [MPa]	Blunt bow formulation [MPa]	Existing formulation ( $\beta'=10^\circ$ ) [MPa]	Blunt bow formulation [MPa]	Existing formulation ( $\beta'=10^\circ$ ) [MPa]	Blunt bow formulation [MPa]	Existing formulation ( $\beta'=10^\circ$ ) [MPa]	Blunt bow formulation [MPa]
20	1.8	1.6	2.1	2.1	2.3	2.5	2.5	3.0
25	1.9	1.8	2.1	2.3	2.4	2.8	2.6	3.4
30	1.9	2.0	2.1	2.6	2.4	3.1	2.6	3.7
35	1.9	2.2	2.1	2.8	2.4	3.4	2.6	4.1
40	1.9	2.4	2.1	3.0	2.4	3.7	2.6	4.4
45	1.9	2.6	2.1	3.2	2.4	3.9	2.6	4.7

Table 4 Comparison of design pressure – existing formulation vs. proposed blunt/vertical bow formulation – PC6

Waterplane angle $\alpha$	Design pressure - PC6							
	$\Delta= 10$ kt		$\Delta= 25$ kt		$\Delta= 50$ kt		$\Delta= 100$ kt	
	Existing formulation ( $\beta'=10^\circ$ ) [MPa]	Blunt bow formulation [MPa]	Existing formulation ( $\beta'=10^\circ$ ) [MPa]	Blunt bow formulation [MPa]	Existing formulation ( $\beta'=10^\circ$ ) [MPa]	Blunt bow formulation [MPa]	Existing formulation ( $\beta'=10^\circ$ ) [MPa]	Blunt bow formulation [MPa]
20	2.1	1.9	2.4	2.4	2.7	2.9	3.0	3.5
25	2.2	2.1	2.5	2.7	2.8	3.3	3.1	3.9
30	2.2	2.4	2.5	3.0	2.8	3.6	3.1	4.4
35	2.2	2.6	2.5	3.3	2.8	4.0	3.1	4.7
40	2.2	2.8	2.5	3.6	2.8	4.3	3.1	5.1
45	2.2	3.0	2.5	3.8	2.8	4.6	3.1	5.5

The comparison shows that the two formulations produce similar design forces and pressures (in average depending on ship size) for smaller to moderate waterplane angles. The consequences for the scantlings may be relatively stronger transverse frames due to increased height of the design load patch. The new formulation for blunt/vertical bows will however give higher forces and pressures for larger waterplane angles, which is considered reasonable. For larger waterplane angles, the simplified  $f_a$ -coefficient is seen to be conservative compared with the “exact” solution, and is considered as an acceptable consequence of the proposed formulation.

When it comes to the loads on the bulb, it should first be mentioned that the bulb should be considered as an appendage, i.e. that their own structural requirements should not drive those of the overall bow structure. However, while the the blunt/vertical bow side formulation is based on a direct derivation of the glancing impact scenario, the development of a formulation for a similar relevant scenario for bulbs has proven to be difficult. For convenience, it has been proposed to use the existing and new proposed load formulation as reference. Although further revisions should continue to look into the possibility of deriving explicit formulations for all types of hull forms, including bulbs, the current proposal is considered sufficient at this stage.

Bow forms which are not covered by the above should be specially considered by each member society.

## **Performance/hull shape criteria for Polar Class ships**

The introduction of performance hull shape criteria was not part of the original scope for this revision work. The powering requirements have been discussed in length during the development of the rules, and the exclusion of such criteria was based on a decision taken in 1997 during the 8<sup>th</sup> semi-annual harmonisation meeting of the IMO Outside Working Group which developed the Draft Code of Polar Navigation. Nevertheless, the debate has continued whether the IACS requirements should include performance requirements for reasons of safety. During the work with the load formulations and the icebreaker requirements, it was found that there is a need for a general performance requirement for all Polar Class vessels to ensure that the vessel can operate safely in the anticipated ice conditions as described by the ice class. The requirements are deliberately formulated somewhat generic, and the intention is to raise the flag and to ensure agreement between designer and owner with regard to the capabilities of the ship. Detailed guidance describing applicable procedures and detailed criteria should be developed separately. Please note that the term “representative ice conditions” does not necessarily refer to the most severe ice condition as described by the ice class, but may be linked to a typical ice condition and operational mode which is representative for the intended voyage profile.

Please note that this requirement should not exclude vessels or unit types which are explicitly not designed to operate independently in ice (e.g. drill ship escorted by icebreakers, barges, etc), but such assumptions or limitations should be explicitly stated in the Class certificate or equivalent for transparency.

## Task 2 – Develop criteria for icebreakers

### Introduction

In the current IACS UR I it is explicitly stated that the requirements are not applicable for *Icebreakers*. By introducing *Icebreakers* in the new revision of the Rules, there is a need for providing clear directions on how ships that are to receive the additional *Icebreaker* notation should be handled. The intention with this work is to clarify the applicability of the *Icebreaker* notation (I1), include relevant structural requirements in I2, and coordinate relevant requirements in I3.

### Background for rule proposal

Although not covering *Icebreakers*, the rules state that vessels which are assigned an *Icebreaker* notation may have additional requirements and are to receive special consideration. In the rules, an *Icebreaker* is referred to as a “ship having an operational profile that includes escort or ice management functions, having powering and dimensions that allow it to undertake aggressive operations in ice-covered waters, and having a class certificate endorsed with this notation.”

Before discussing the detailed requirements which should be associated with the specific notation, it might be worth discussing the applicability of the notation, and the features which typically differentiate these vessels from other vessels without the additional notation. Noting the definition of *Icebreakers* above, there are clearly expectations and assumptions associated with the notation which are related to type of operations and performance including manoeuvrability and powering.

Higher polar class ships are expected to spend more of their lives in ice-infested waters, and consequently experience more and higher ice impact loads. The actual distributions of loads will therefore have a probabilistic character, which implicitly are reflected in the choice of ice class. An *icebreaker* will similarly, due to the operational profile, expect to experience more frequent and severe ice impacts relative to a commercial vessel of same parent ice class, and this may be reflected in the determination of design loads.

From a structural strength and performance point of view, the following aspects may be considered as (potential) differentiators compared to a general icebreaking vessel covered by the current Rules:

- Sufficient performance to undertake more aggressive operations in design ice conditions
  - o Hull form and maneuverability
  - o Propulsion power
- Sufficient strength to withstand additional loads due to more aggressive operations in design ice conditions:
  - o Higher frequency of impacts during lifetime - increased probability of extreme loads
  - o More available power/higher impact speeds – potentially increased extreme loads
  - o Increased local loading on other parts of hull and appendages, e.g. outside defined icebelt, shoulders, bottom and stern, as well as rudders, due to increased maneuverability and aggressive operation
  - o Higher global loads and accelerations due to more aggressive ramming operations

To address the expectations associated with the rule definition of an *Icebreaker*, it is reasonable to introduce additional requirements to the hull form and the propulsion power. However, in the current proposal, the general performance requirement proposed in I1 (and discussed above) is

considered to sufficiently cover *Icebreakers* as well. Relevant ice conditions and acceptance criteria applicable for the type of operation should however be considered.

For the design loads which are used for dimensioning of the bow structure, one may argue that the general loading should be increased due to a more aggressive operational profile. The same applies to the horizontal and vertical extensions of the defined hull areas. However, in the current proposal, the dimensioning level in the bow is retained, but some general minimum level of strengthening in the non-bow areas have been proposed as well as increased strengthening of the stern.

During the development of the original rule proposal, a separate longitudinal strength criterion for *Icebreakers* was included. Since *Icebreakers* were excluded from the original rule proposal, this specific requirement was removed. In the current rule proposal, it is suggested to re-introduce this requirement.

## **Applicability of Icebreaker notation**

The additional *Icebreaker* notation is considered applicable for all Polar Class notations.

## **Hull area factors and regions**

As mentioned above, it might be reasonable to keep the existing design loads for dimensioning of the bow structure, based on among others the assumption that the calibration of the design loads to a large extent has been made based on experience with icebreakers. However, increased manoeuvrability, power, and more aggressive operation might increase the loading on the other parts of the vessel, particularly for the lower ice class vessels. In general, the area factor for the stern ice belt and the stern lower has been increased by approximately 25%, and all non-bow area factors should not less than the area factor determined for PC3.

The proposal is a simple percentage-increase compared to the standard area factors and is based on a review of existing ice class rules (e.g. DNV Rules for vessels intended for Arctic and icebreaking service, ABS ice class rules, etc). In the DNV Rules, the design loads in the stern icebelt is for icebreakers 80% of the bow load (same as proposed for PC3-PC7 Icebreaker), an increase of 33% compared with a ship without icebreaker notation. Similar relations may be found for the other hull areas.

The proposal was originally introduced in the DNV Rules for Polar Class ships in 2008. The intention with the requirement is to keep a minimum level of strengthening in the non-bow areas, particularly for the lower ice classes.

For *Icebreakers* it is suggested that the fore boundary of the stern region should at least be 0.04 L fore of WL angle = 0 degrees at UIWL, i.e. stern shoulder to be included in stern region. This is in accordance with common requirements given for icebreakers in existing ice class rules.

## **Loading on rudders, nozzles, azimuthing propulsion units etc**

For appendages, it is stated that the design loads should be representative for the location of their attachment to the hull structure or their position within a hull area. Hence, it is reasonable to link

this to the hull area factor (AF). Assuming that the hull area factor is increased for *Icebreakers*, the design loads for the appendages should be increased accordingly. However, as there are no explicit requirements for the appendages in the rules, the rule text has not been changed.

### **Requirements to longitudinal strength**

It is suggested to re-introduce the original utilization factor to determine allowable stresses for icebreakers. A utilization factor of  $n=0.6$  was originally introduced for icebreakers ( $n=0.8$  for other ship types) to take into account more aggressive operations assumed to be associated with icebreakers. The requirement was later removed, as it was agreed that the Rules should not cover icebreakers.

### **Requirements related to machinery section I3**

In the current draft revision proposal for I3, additional requirements associated with the *Icebreaker* notation are to be determined by each member society.

The only reference to *Icebreaker* is a requirement to a fast torque relief arrangement are to be fitted in order to provide effective protection of the rudder actuator in case of the rudder being pushed hard over against the stops.

## Task 5 – Procedures for web frames and stringers

### Introduction

The current requirements for web frames and stringers given in IACS URI2 provide little guidance for design. There is hence a need for consistency in the treatment of conventional web frames and stringers, as well as general grillage systems, in order to avoid different interpretations and design criteria among the IACS member societies.

### Background for rule proposal

The Polar Class requirements are generally derived using plastic design philosophy. This is based on the consideration that some minor deformations (e.g. local denting) could be an acceptable consequence of ice operation, provided that this does not compromise the overall strength or watertight integrity of the ship.

The design criteria for plastic design are normally evaluated against loss of stiffness (stiffness change), permanent deformations or plastic strains. As opposed to elastic design, where the limit state could be a stress criterion related to first yield, plastic design has in general many possible limit states ranging from yield to final rupture.

For the plating and local frame requirements, the limit states defined in the PC rules are based on a plastic collapse mechanism. As the collapse model ignores the effect of membrane stresses, strain hardening and in principle the possible redistribution of loads to adjacent members, the structure has substantial reserve resistance beyond the design condition. This is particularly true for the local plating members, which can carry significantly higher loads while undergoing deformations several times the plate thickness before rupture. For individual ice frames, the reserve resistance is however less significant, and there are uncertainties both with regard to (the combinations of) failure modes as well as the ability to mobilize the assumed plastic resistance of the cross section and any membrane action in the member. For higher level components like web frames and stringers, the ability to mobilize additional reserve resistance may be even less apparent. Stability of web plates and flanges will have to be checked separately.

Limit states used as basis for design should reflect the potential consequences of structural failure. Assuming that the ice patch is limited in height and width, a rupture of a single plate member may not be considered very critical for the survivability of the vessel, while a structural failure of a primary member may ultimately compromise the vessel's structural integrity.

Hence, a higher utilization of the plating compared to primary members may be rationalised from a risk evaluation point of view. This type of hierarchy strength principle is also described in the background documents of the current rules, where a system of relaxed plate and stricter ice frame requirements is adopted.

In addition to the potential reserve resistance or consequences of structural failure discussed above, the selection of appropriate limit states should reflect the probability level of the design load applied on the different members. The design loads which have been derived for the Polar Classes may be considered as extreme loads, and may be considered conservative, both with regard to the

derivation of the load scenario, as well as the ice class factors used as basis for the assessment. However, there are no explicit references to a formal probability level or return period for an actual trading vessel. The governing design load for all structural members, ranging from the local plating to the grillage system including bulkheads and decks, is based on a glancing impact scenario, where the impact force is represented by an average pressure over a patch area with defined height and length. For small areas, a peak pressure factor (PPF) is introduced to take into account the possible existence of higher pressure zones within the defined patch area. In addition, the PPF is used to increase the general pressure level for certain structural elements. However, both the PPF formulation and its application on the various members have been questioned, and compared to other rule formulations, the PC loads appear to be more conservative for individual members carrying larger fractions of the defined patch load. It too must be understood that the structural response in the Rules allows for limited plasticity and is thus a higher level than other Rules sets that use elastic response principles. Hence, the use of the relatively extreme Polar Class design loads may imply that an implicit (relative) safety factor could be embedded into the load formulation, at least for web frames and stringers with larger spans, depending upon the response criteria selected.

When the limit state is defined, the corresponding acceptance criteria must reflect the analysis method used and the response parameters considered in the assessment. For the assessment of individual primary members and grillage systems, several methods may be applicable:

- Analytical elastic or plastic methods
- Beam analysis
- Linear or non-linear finite element analysis

Analytical methods are generally simple in format and may be a preferred tool for simple strength checks of individual members, e.g. for establishing initial dimensions. The advantage is obviously that the necessary scantlings can be determined by well-defined formulas without the use of advanced computational tools. The drawback is however the difficulty in representing the actual response pattern, the possible complex geometry and support conditions, as well as the difficulties in properly taking into account the effect of the members being part of a grillage system, particularly in the plastic regime.

Evaluation of the structural response by use of finite element methods allows for a much more accurate representation of the actual (variations in) geometry, as well as the interaction between the different members considered. Finite element analysis requires however generally much more resources than analytical methods, and require also special competence which may not be easily accessible for all parties. Using non-linear finite element methods as basis for documenting structures to meet the reliability level of a specific code will require an in-depth understanding of the inherent safety requirements of the governing code as well, and there is definitely a need for a detailed guidance to ensure reliable and consistent results.

During the development of the original Rules, an analytical procedure for evaluating grillage systems was proposed based on the Russian rules. The formulas for web frames and stringers were based on a plastic approach and incorporated the presence of lower level strength members, taking into account their supporting and load distributing effects. Due to lack of agreement, the proposal was however excluded from the first official rules.



As part of the work related to the current rule revision, a basis for evaluating stringers and web frames both with analytical and direct calculations has been developed. Both the analytical formulations and the procedures for direct calculations were based on earlier work done by DNV-GL. During the development of the analytical formulations, it was however acknowledged that it is difficult to develop generic analytical formulations for grillage systems which can represent the actual response with sufficient degree of accuracy, taking into account the actual (variations in) geometry, boundary conditions, interactions between the different strength members. Based on the outcome from the verification of the formulations, as well as response from the first hull panel hearing phase, the accuracy of the proposed formulations were not found to meet the desired level of accuracy, and it was decided not to include the proposal formulation in the current revision proposal. In addition, concern was raised with respect to scantling outcomes for PC7 and PC6 ships in comparison to Baltic IA and IA Super scantlings, suggesting that further validation and development is needed. The derived formulations are however documented in Appendix A and may be used as reference in later revisions.

It is unfortunate that this revision work have not lead to the introduction of analytical formulations for web frames and stringers, and there is obviously a need for such formulations, particularly for determination of initial dimensions. However, as a result of the above, each member society should preferably come up with guidance for initial design.

However, for web frames and stringers being part of grillage systems, the new rule proposal assumes in any case the use of direct calculations. Direct calculations tend to become a natural and basic part of the strength documentation in ship design, and will now be expected for final documentation of grillage systems.

The rule proposal for direct calculation is intentionally left quite generic, and the specific procedure has to be developed by each member society. However, the assumptions and requirements to the execution of the analysis and evaluation of results should reflect the acceptance criteria and considerations below in order to ensure that the proposed design points are treated consistently. This includes modelling issues, mesh density, etc. as well as treatment of lower level members, connection area, stability requirements etc. In general the following criteria and considerations are included in the proposal:

Linear elastic stress analysis (beam or FE analysis):

- Web plates and flange elements in compression and shear to fulfil relevant buckling criteria
- Effective shear stress in member web plates to be less than  $\sigma_y/\sqrt{3}$
- von Mises stresses in member flanges to be less than  $1.15 \times \sigma_y$ . (assuming party fixed boundary conditions)

Non-linear stress analysis:

- The analysis shall reliably capture buckling and plastic deformation of the structure
- Detailed acceptance criteria to be decided by each member society. The acceptance criteria shall ensure a suitable margin against fracture and major buckling and yielding causing significant loss of stiffness.
- Permanent lateral and out-of plane deformation of considered member should be minor relative to the relevant structural dimensions.

The von Mises acceptance criteria for linear analysis have been discussed back and forth within the group, and it is acknowledged that throughout validation of different grillage configurations has not been carried out. Based on the discussion above, it was however from the beginning the clear opinion of the group that the acceptance criteria should incorporate a moderate degree of plasticity in the members, which means that nominal elastic normal stresses may exceed yield.

The structural capacity of the grillage depends largely on the actual structural configuration and dimensions. From the validation work carried out as part of this revision, a series of relevant grillage configurations were considered. However, the typical governing failure modes for these structures are related to shear yield and buckling stability, which means that the bending failure mode becomes less relevant.

In Figure 5, examples of relative load-deflection curves for two typical continuous girders being part of a grillage system are shown. The girder denoted T-profile consists of a plate flange and a stiffener flange, while the I-profile represents a double hull member consisting of two (inner and outer shell) plate flanges. Both the load and deflections are normalized with regard to first yield in the member flange(s). From the analyses, it is evident that the members can carry significantly larger loads than the level initiating first yield in the member without experiencing large permanent deformations, and based on an overall evaluation, a factor of 1.15 is proposed and found to be reasonable taking into account the combined ability to develop plastic moment and redistribution of stresses, in combination with a moderate fixation against rotations at the member supports. The alignment of acceptance criteria for different analysis methods should preferably be part of a detailed procedure which should be developed for direct calculations.

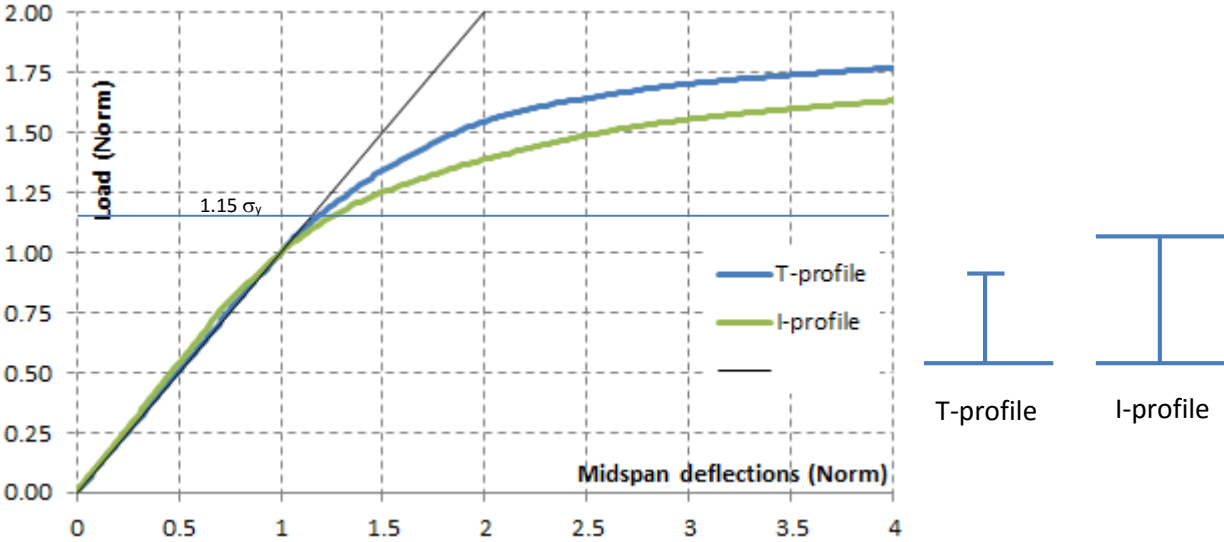


Figure 5 Typical load deflection curves for typical girder members being part of a grillage system

### Editorial amendments of rule text

General editorial amendments have been proposed and the rule text has been updated accordingly. The rationale for the amendments is mainly to ease readability and to avoid misunderstandings.

Some items are found to be inconsistent or superfluous, and have consequently been removed from the proposal. This applies among others to Paragraph I2.12.5, including the table for steel grades for inboard members attached to weather exposed plating, which is found to be inconsistent with the material classes described in I2.12.2.

From the hull panel hearing process, it was observed that there was some confusion regarding the existing framing requirements for bottom structures. Hence, the text is updated to clarify the intention of the rules. When calculating the minimum shear and section modulus requirements for the bottom structure, the requirements in I2.6 should be applied irrespective of the actual framing direction. In the bottom is it considered reasonable to assume that the ice patch orientation relative to the frame direction is random, and hence it is not relevant to distinguish between the transverse and longitudinal frame configurations. In lack of a specific scenario-based formulation for the bottom structure, an ice load patch applied in a direction normal to the frame direction is considered reasonable.

The patch load application on transversely and longitudinally framed bottom structures are given in Figure 6 and Figure 7, respectively. Please note that the same philosophy applies for the plate thickness requirements

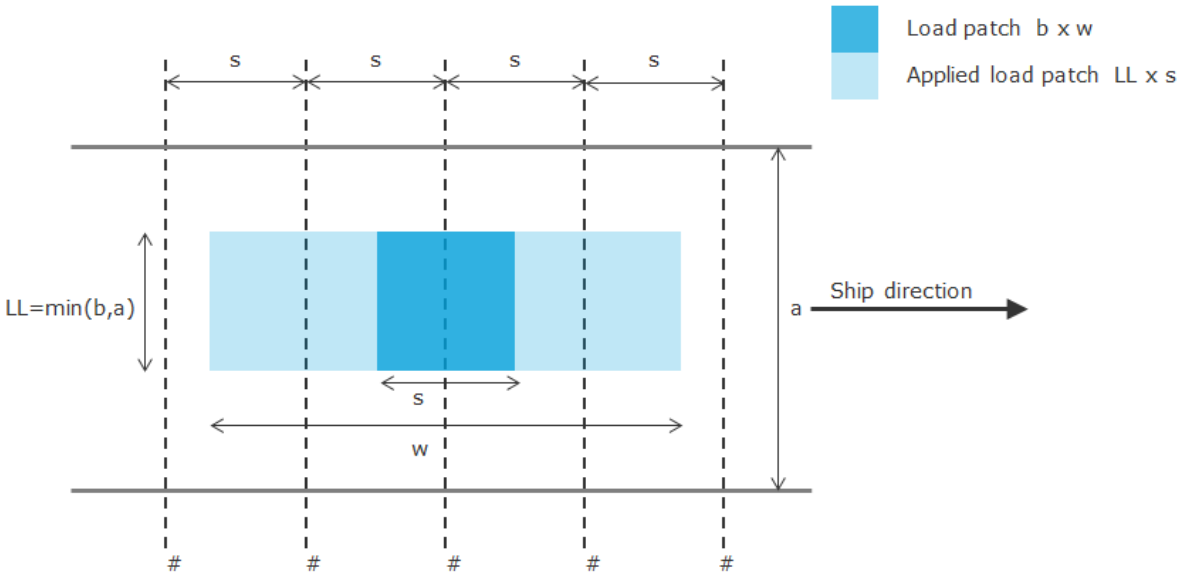


Figure 6 Application of ice load patch on transversely framed bottom structure according to paragraph I2.6

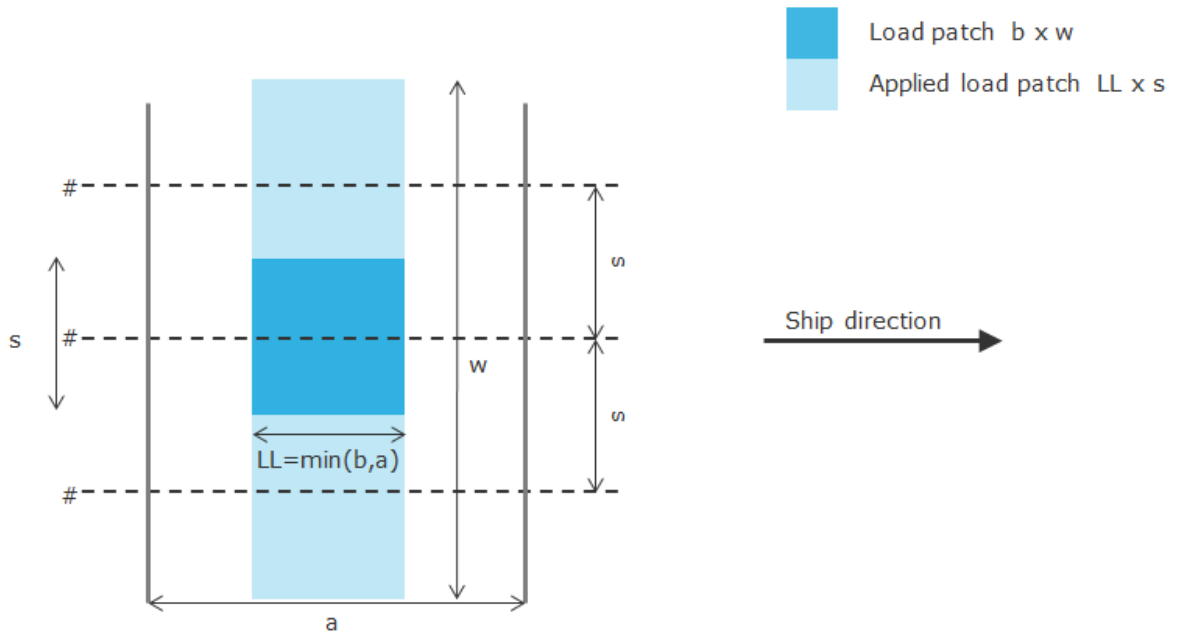


Figure 7 Application of ice load patch on longitudinally framed bottom structure according to paragraph I2.6

Other amendments include:

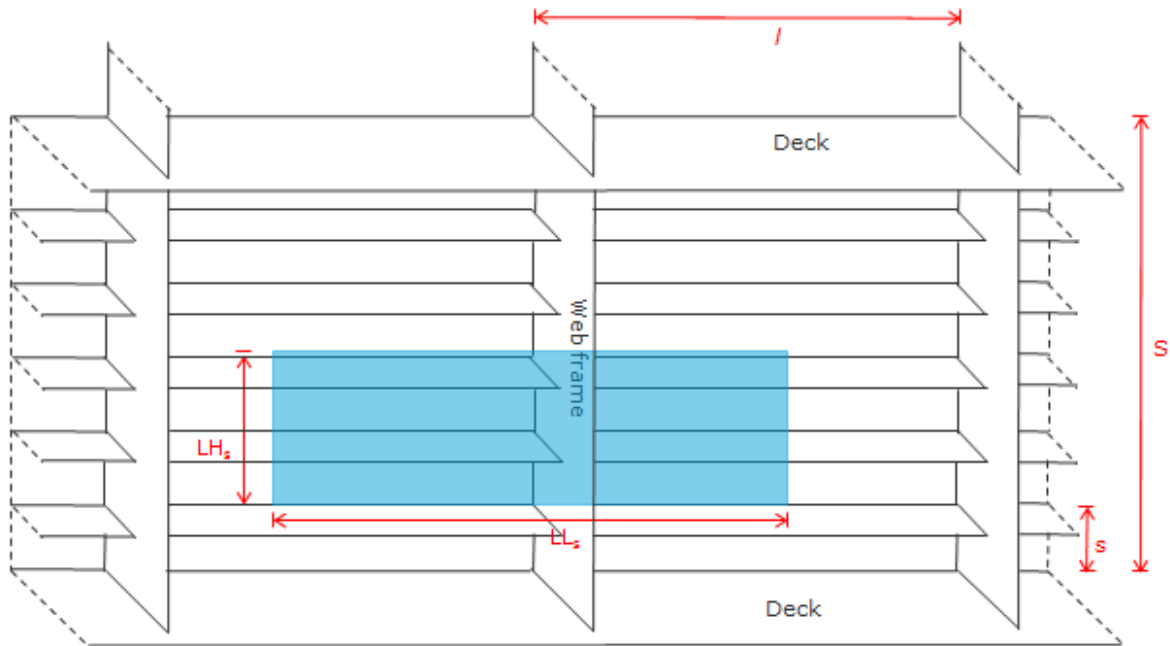
- The PPF for bottom framing should not be independent of patch area or structural dimensions. Consequently the peak pressure factor has been set to 1.0.
- The equation numbers have been removed as it is found that only a few are referred to in the text. Reference to paragraph numbers has been included as relevant.

## Appendix A

### Analytical formulations for web frames and stringers

#### Shear area requirements for simple web frames supporting longitudinal local frames

The general design load case for evaluating the shear strength of a simple web frame supporting longitudinal local frames is suggested to be as shown in Figure 1.



**Figure 1 – Proposed design condition for the shear area requirement for simple web frames supporting longitudinal local frames**

The effective shear area requirement for this condition is suggested to be as follows:

$$A_{wf} = \frac{100^2 (AF PPF_s P_{avg}) LH_s LL_s K_s}{0.577 \sigma_F \eta \sin \phi_w}$$

$A_{wf}$  = Effective net web area of web frame supporting longitudinal local frames [cm<sup>2</sup>]

AF = Hull Area factor from Table 3

PPF<sub>s</sub> = Peak Pressure Factor from Table 2

P<sub>avg</sub> = Average pressure within load patch according to Equation 15 [MPa]

LH<sub>s</sub> = effective load height with respect to shear response of web frame [m]

$$= \min(b, (S - s))$$

- b = Height of design ice load patch from Equation 12 or 14 [m]
- S = Design span of considered web frame with regard to shear response [m]
- s = Spacing of longitudinal frames [m]
- LL<sub>s</sub> = effective load length with respect to shear response of web frame [m]
- $$= w \frac{\left(l - \frac{w}{4}\right)}{l}$$
- w = Width of design load patch from Equation 11 or 13 [m], but is not to be taken larger than 2 l
- l = Spacing of web frames [m], measured along the shell plate
- K<sub>s</sub> = shear force factor [-]
- $$= \frac{S-h}{S}, \text{ minimum } 0.55$$
- h =  $\frac{LH_s + s}{2}$  [m], if one of the web frame supports lies within considered hull area
- $$= \frac{LH_s}{2} + h_1$$
- [m], if both of the web frame supports lies outside considered hull area
- h<sub>1</sub> = Smallest distance from web frame support to hull area boundary
- η = usage factor = 1.0
- φ<sub>w</sub> = smallest angle between shell plate and the web of the web frame, measured at middle of span [deg]. The angle φ<sub>w</sub> may be taken as 90 degrees provided the smallest angle is not less than 75 degrees.

In the proposal presented above, it is assumed that a portion of the design patch, as defined in the Rules by the height b and length w, is transferred directly to the structure supporting the web frame (e.g. a deck) and/or carried by the longitudinal local frames to the adjacent web frames. The magnitude of the force transferred to adjacent structure depends on the size of the patch load relative to the distance to the adjacent members. The effective patch area of the load carried by the considered web frame is defined by the height LH<sub>s</sub> and length LL<sub>s</sub>.

The effective patch load height LH<sub>s</sub> is generally taken as the general height b, as defined in the Rules, but limited by the span of the web frame.

The load length LL<sub>s</sub> is based on the assumption that part of the loading is carried by the longitudinals directly to the adjacent web frames. If the patch length w is equal to the web frame spacing S, it is assumed that 75% is taken by the considered frame, and the remaining 25% is taken by the adjacent frames. If the patch length w is more than twice the web frame spacing S, the effective patch length is limited by the web frame spacing.

For the shear factor K<sub>s</sub>, it is assumed that the edge of the patch load is placed a distance equal to the frame spacing from one of the supports. The shear factor represents the portion of the load taken as shear in the most loaded support assuming that both supports have the same boundary conditions. A

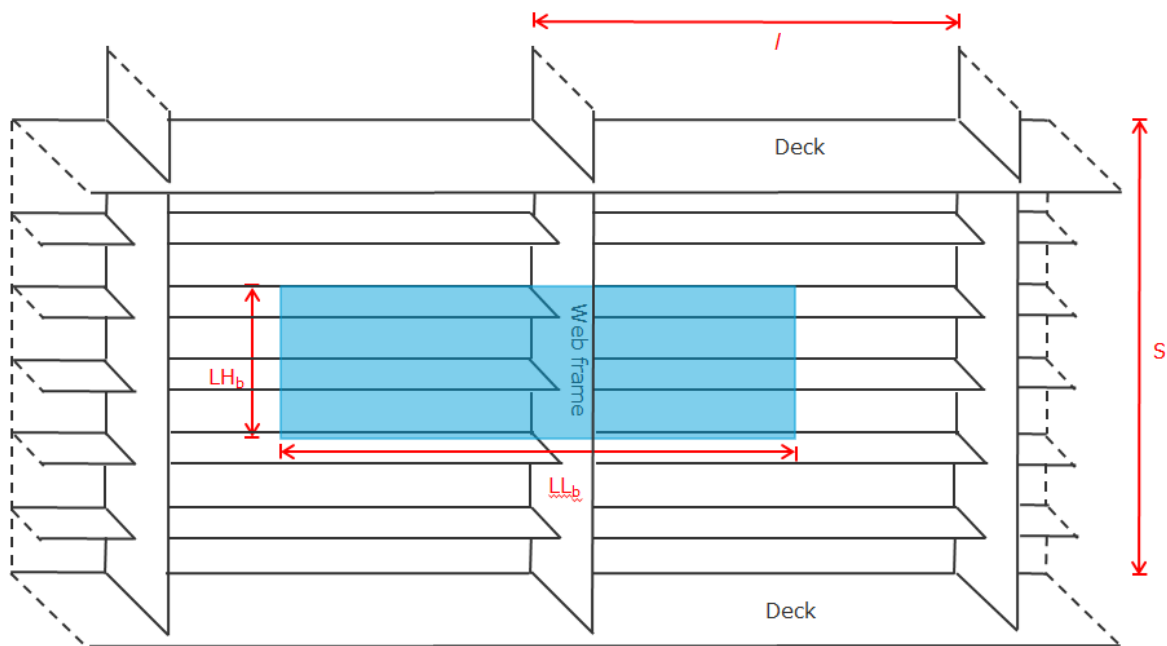
correction is included to cover the case where the web frame spans over the whole considered hull area, i.e. it is assumed that the patch load is placed at the boundary of the hull area.

The formula assumes shear yield over the whole effective height of the web plate.

It is suggested that the general usage factor is taken as 1.0.

### Section modulus requirements for simple web frames supporting longitudinal local frames

The general design load case for evaluating the bending strength of a simple web frame supporting longitudinal local frames is suggested to be as shown in Figure 2.



**Figure 2 – Proposed design condition for the section modulus requirement for simple web frames supporting longitudinal local frames**

The net elastic section modulus of the web frame is suggested to be as follows:

$$Z_{wf} = \frac{100^3 (AF PPF_s P_{avg}) LH_b LL_b \left( S - \frac{LH_b}{2} \right)}{4 \sigma_F \sin \varphi_w k_f}$$

$A_{wf}$  = Net elastic section modulus of web frame supporting longitudinal local frames [cm<sup>3</sup>]

$LH_b$  = effective load height with respect to bending response of web frame [m]

$$= \min(b, S)$$

$LL_b$  = effective load length with respect to bending response of web frame [m]

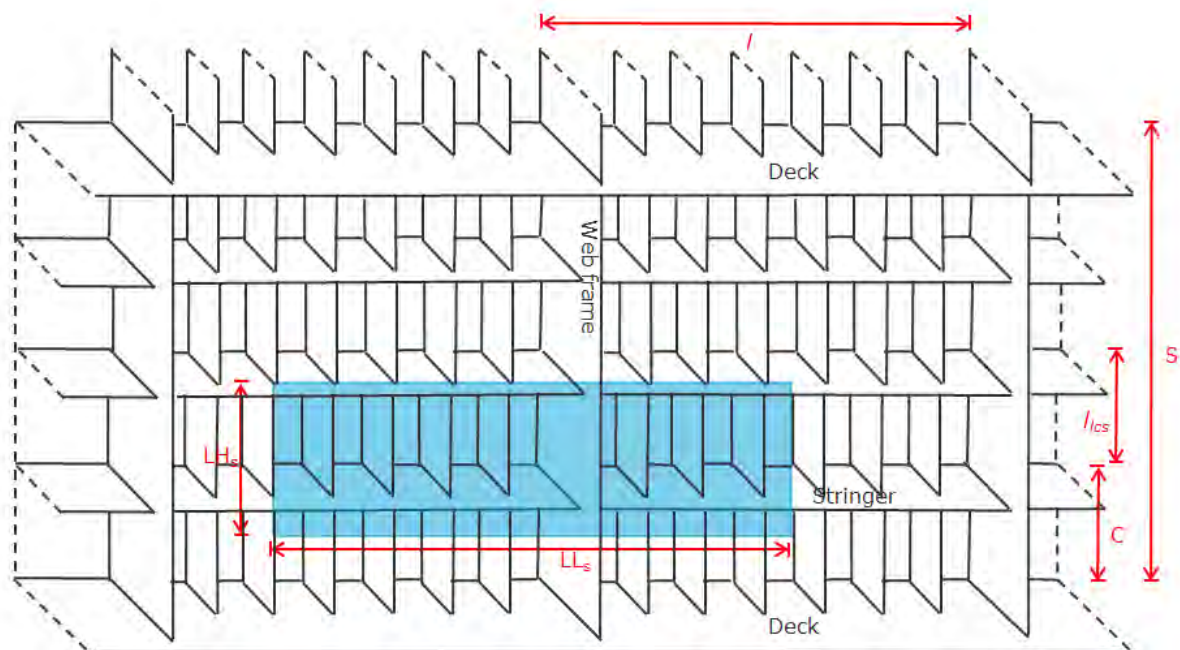
$$= w \frac{\left( l - \frac{w}{4} \right)}{l}$$

- $k_f$  = end fixity parameter for the web frame [-]
- = 2.0 when both end supports are fixed
- = 1.5 when one end support is fixed
- = 1.0 when both end supports are simply supported

The section modulus requirement is derived based on a semi-plastic approach, where the plastic moment obtained from a simple plastic 3-hinge mechanism (in case of restrained ends) is used as basis for determining the capacity of the member. The capacity is however evaluated against the elastic section modulus of the profile. Using the plastic bending moment as basis for the capacity assessment will for the clamped end case increase the defined capacity by 33% compared with a pure elastic approach based on first yield.

### Shear area requirement for simple web frames supporting load carrying stringers

The general design load case for evaluating the shear strength of a simple web frame supporting load carrying stringers is suggested to be as shown in Figure 3.



**Figure 3 – Proposed design condition for the shear area requirement for simple web frames supporting load carrying stringers**

The effective shear area requirement for this condition is suggested to be as follows:

$$A_{wf} = \frac{100^2 (AF PPF_s P_{avg}) LL_s LH_s K_s}{0.577 \sigma_F \eta \sin \phi_w}$$

$A_{wf}$  = Effective net web area of web frame supporting load carrying stringers [cm<sup>2</sup>]



$LH_s$  = load height with respect to shear response of web frame [m]

$$= b \left( \frac{l - \frac{b}{4}}{l} \right)$$

$LL_s$  = load length with respect to shear response of web frame [m]

$$= w \frac{\left( l_{LCS} - \frac{w}{4} \right)}{l_{LCS}}$$

$l$  = Spacing of web frames [m], measured along the shell plate

$l_{LCS}$  = Distance to adjacent load carrying stringer or longitudinal support member, as applicable, [m], measured along the shell plate

$K_s$  = shear force factor [-]

$$= \frac{S - C}{S}$$

$\eta$  = usage factor

$\varphi_w$  = smallest angle between shell plate and the web of the web frame

In the proposal presented above, it is assumed that the design patch is located at a stringer level, and is acting as a point load on the web frame. As for the requirement for web frames supporting longitudinal local frames, a portion of the design load is assumed carried by the adjacent members, and hence the design patch on the web frame is defined by the effective height  $LH_s$  and length  $LL_s$ .

Similarly is the shear factor  $K_s$  taking into account the position of the considered load carrying stringer relative to the web frame supports.

Depending on the framing arrangement, several load carrying stringers along the web frame span should be considered.

It is suggested that the general usage factor is taken as 1.0

### **Section modulus requirement for simple web frames supporting load carrying stringers**

The general design load case for evaluating the bending strength of a simple web frame supporting load carrying stringers is considered to be the same as for the shear strength requirement, see Figure 3.

The net elastic section modulus of the web frame is suggested to be as follows:

$$Z_{wf} = \frac{100^3 (AF PPF_s P_{avg}) LL_s LH_s C (S - C)}{2 \sigma_F \sin \varphi_w k_f S}$$

$LH_b$  = load height with respect to bending response of web frame [m]

$$= b \left( \frac{l - \frac{b}{4}}{l} \right)$$

LL<sub>b</sub> = load length with respect to bending response of web frame [m]

$$= w \frac{\left( l_{LCS} - \frac{w}{4} \right)}{l_{LCS}}$$

C = Smallest distance from considered load carrying stringer to web frame support [m]

kf = end fixity parameter for the web frame [-]

= 2.0 when both end supports are fixed

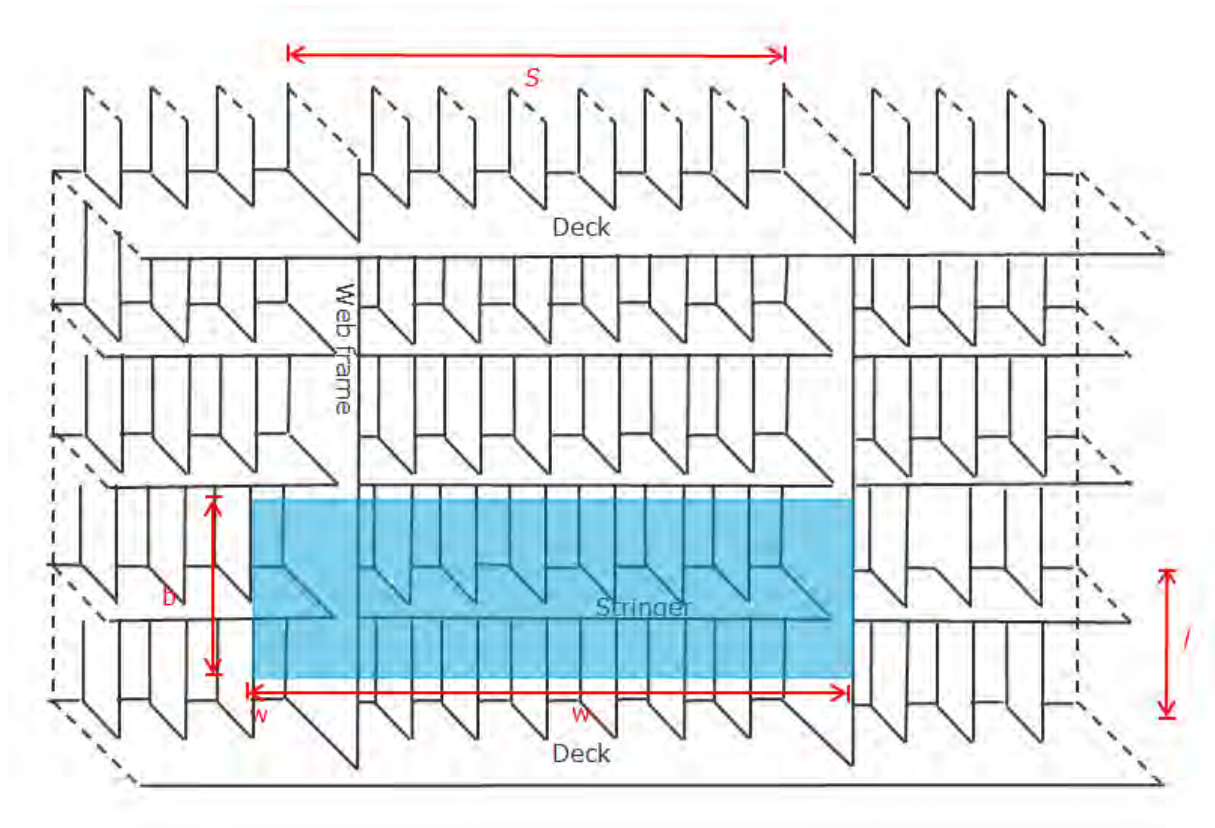
= 1.5 when one end support is fixed

= 1.0 when both end supports are simply supported

As for the shear area requirement, the section modulus requirement assumes that the patch load is represented as a point load at the stringer location. The same effective patch load is considered as well. The formulation is based on the plastic capacity of the member, but evaluated against the elastic section modulus.

### **Shear area requirement for load carrying stringers**

The general design load case for evaluating the shear strength of a simple load carrying stringer is suggested to be as shown in Figure 4.



**Figure 4 – Proposed design condition for the shear area requirement for load carrying stringers**

The effective shear area requirement for this condition is suggested to be as follows:

$$A_{lcs} = \frac{100^2 (AF PPF_s P_{avg}) LH_s LL_s K_s}{0.577 \sigma_F \eta \sin \phi_w}$$

$LH_s$  = effective load height with respect to shear response of stringer [m]

$$= b \frac{(l - \frac{b}{4})}{l}$$

$LL_s$  = effective load length with respect to shear response of stringer [m]

$$= \min(w, (S - s))$$

$K_s$  = shear force factor [-]

$$= 0.5 \text{ if } w \geq S$$

$$= \frac{S - \frac{LL_s + s}{2}}{S}$$

$\eta$  = usage factor = 1.0

$\phi_w$  = smallest angle between shell plate and the web of the web frame

### Section modulus requirement for simple load carrying stringers

The general design load case for evaluating the bending strength of a load carrying stringer is considered to be the same as for the shear strength requirement, see Figure 4.

The net elastic section modulus of the load carrying stringer is suggested to be as follows:

$$Z_{lcs} = \frac{100^3 (AF PPF_s P_{avg}) LH_b LL_b \left(S - \frac{W}{2}\right)}{4 \sigma_F \sin \varphi_w k_f}$$

$LH_b$  = effective load height with respect to bending response of stringer [m]

$$= b \frac{\left(l - \frac{b}{4}\right)}{l}$$

$LL_b$  = effective load length with respect to bending response of web frame [m]

$$= \min(w, S)$$

$k_f$  = end fixity parameter for load carrying stringer

= 2.0 when both end supports are fixed

= 1.5 when one end support is fixed

= 1.0 when both end supports are simply supported

$\varphi_w$  = smallest angle between shell plate and the web of the web frame

## Appendix B

### Derivation of the oblique collision force with a vertical bows

The force is found by equating the normal kinetic energy with the ice crushing energy,

$$KE_n = E_{crush} \quad (a1)$$

The crushing energy is found by integrating the normal force over the penetration depth

$$E_{crush} = \int_0^{\delta} F_n(\delta) d\delta \quad (a2)$$

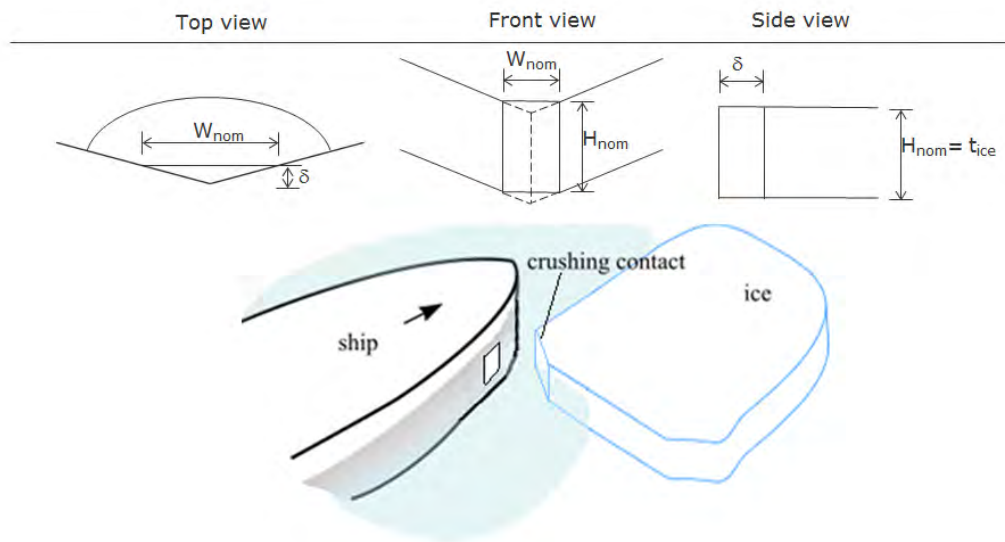
The normal kinetic energy combines the normal velocity with the effective mass at the collision point

$$KE_n = \frac{1}{2} M_e \cdot V_n^2 \quad (a3)$$

Combining the two terms gives

$$\frac{1}{2} M_e \cdot V_n^2 = \int_0^{\delta_m} F_n(\delta) d\delta \quad (a4)$$

The ice penetration geometry together with the pressure-area relationship is the basis of finding the force. The nominal area is found for a penetration  $\delta$



The nominal contact area is

$$A = W_{nom} \cdot H_{nom} \quad (a5)$$

The width of the  $W_{nom}$  of the nominal contact area can be determined by the nominal penetration depth  $\delta$  and the ice edge angle  $\phi$ .

$$\tan \frac{\phi}{2} = \frac{W_{nom}}{2\delta}$$

$$W_{nom} = 2\delta \cdot \tan \frac{\phi}{2} \quad (\text{a6})$$

The height  $H_{nom}$  of the nominal contact area is fixed by the design ice thickness for each polar class

$$H_{nom} = h_{ice} \quad (\text{a7})$$

Hence the area is

$$A = W_{nom} \cdot H_{nom} = 2h_{ice}\delta \cdot \tan \frac{\phi}{2} \quad (\text{a8})$$

The average pressure is found from the pressure area relationship

$$P = P_0 \cdot A^{ex} \quad (\text{a9})$$

The nominal force is

$$F_n(\delta) = P \cdot A = P_0 \cdot A^{1+ex} \quad (\text{a10})$$

Substituting the expression for area (4) gives

$$F_n(\delta) = P_0 \left( 2h_{ice}\delta \cdot \tan \left( \frac{\phi}{2} \right) \right)^{1+ex} \quad (\text{a11})$$

$$F_n(\delta) = C \cdot P_0 \cdot \delta^{1+ex} \cdot h^{1+ex} \quad (\text{a12})$$

where we collect known quantities into the factor C

$$C = \left( 2 \cdot \tan \left( \frac{\phi}{2} \right) \right)^{1+ex} \quad (\text{a13})$$

We can now solve the energy balance equation ((a12) into (a4)) to find the maximum penetration

$$\frac{1}{2} M_e \cdot V_n^2 = C \cdot P_0 \cdot h^{1+ex} \cdot \int_0^{\delta_m} \delta^{1+ex} d\delta \quad (\text{a14})$$

Accordingly we can extract the maximum penetration

$$\frac{1}{2} M_e \cdot V_n^2 = C \cdot P_0 \cdot h^{1+ex} \cdot \left| \frac{\delta_m^{2+ex}}{2+ex} \right|_0^{\delta_m}$$

$$\frac{1}{2} M_e \cdot V_n^2 = C \cdot P_0 \cdot h^{1+ex} \cdot \frac{\delta_m^{2+ex}}{2+ex}$$

$$\delta_m = \left( \frac{(2+ex) \cdot \frac{1}{2} M_e \cdot V_n^2}{C \cdot P_0 \cdot h^{1+ex}} \right)^{\frac{1}{2+ex}} \quad (\text{a15})$$

This is substituted into the expression for force (a12), to give

$$F_n = C \cdot P_0 \cdot h^{1+ex} \cdot \left( \frac{(2+ex) \cdot \frac{1}{2} M_e \cdot V_n^2}{C \cdot P_0 \cdot h^{1+ex}} \right)^{\frac{1+ex}{2+ex}} \quad (a16)$$

This can be substituted to give

$$F_n = C^{\frac{1}{2+ex}} \cdot P_0^{\frac{1}{2+ex}} \cdot \left( (2+ex) \cdot \frac{1}{2} M_e \cdot V_n^2 \cdot h_{ice} \right)^{\frac{1+ex}{2+ex}} \quad (a17)$$

Substituting for  $M_e$  and  $V_n$ , we get

$$F_n = C^{\frac{1}{2+ex}} \cdot P_0^{\frac{1}{2+ex}} \cdot \left( \frac{l^2}{2C_0} \right)^{\frac{1+ex}{2+ex}} \cdot \left( (2+ex) \cdot M_{ship} \cdot V_{ship}^2 \cdot h_{ice} \right)^{\frac{1+ex}{2+ex}} \quad (a18)$$

We can collect all shape related terms (comprising C and the terms with  $C_0$  and  $l$ ) into a simple terms  $f_a$ ,

$$f_a = (2+ex)^{\frac{1+ex}{2+ex}} \cdot \left( 2 \tan \frac{\varphi}{2} \right)^{\frac{1+ex}{2+ex}} \cdot \left( \frac{l^2}{2C_0} \right)^{\frac{1+ex}{2+ex}} \quad (a19)$$

With  $f_a$ , we can write the force equation as

$$F_n = f_a \cdot P_0^{\frac{1}{2+ex}} \cdot V_{ship}^{\frac{2+2 \cdot ex}{2+ex}} \cdot M_{ship}^{\frac{1+ex}{2+ex}} \cdot h_{ice}^{\frac{1+ex}{2+ex}} \quad (a20)$$

Which for  $ex=-0.1$  gives

$$F_n = f_a \cdot P_0^{0.526} \cdot V_{ship}^{0.947} \cdot M_{ship}^{0.474} \cdot h_{ice}^{0.474} \quad (a21)$$

This value of  $f_a$  collects all form related terms (and constants) into a single factor for crushing. Equation (a21) represents only the crushing force. However the flexural design force need not be included in the design force of a blunt bow.

The ice load patch is found from  $F_n$ . Using (a20) and (a10), we can solve for the nominal contact area,

$$A = \left( \frac{F_n}{P_0} \right)^{\frac{1}{1+ex}} \quad (a22)$$

Unlike the case for an icebreaking bow form, there is no need to introduce a change in load patch shape (it is already rectangular). Accordingly, the aspect ratio is

$$AR = \frac{W_{nom}}{H_{nom}} = \frac{W_{nom}}{h_{ice}} \quad (a23)$$

$$A = h_{ice}^2 \cdot AR \quad (a24)$$

Therefore, we can write

$$H_{nom} = h_{ice} \quad (a25)$$

And from (a8) and (a22)

$$W_{nom} = \frac{\left(\frac{F_n}{P_o}\right)^{\frac{1}{1+ex}}}{h_{ice}} \quad (a26)$$

At this point we introduce a reduction in the size of the load patch (force is unchanged, so design pressure rises, correspondingly). This reduction is conservative and is done to account for the typical concentration of force that takes place as ice edges spall off. The rule (or design) patch length is

$$w = W_{nom}^{wex} = \left(\frac{F_n}{P_o}\right)^{\frac{wex}{1+ex}} \cdot h_{ice}^{-wex} \quad (a27)$$

Where with  $wex = 0.7$ , we have

$$w = F_n^{0.778} \cdot P_o^{-0.778} \cdot h_{ice}^{-0.7} \quad (a28)$$

The design load height is

$$b = \frac{w}{AR} \quad (a29)$$

Using (a23) and (a26)

$$b = F_n^{-0.333} \cdot P_o^{0.333} \cdot h_{ice}^{1.3} \quad (a30)$$

The nominal and design load patches have the same aspect ratio. The load quantities used in the scantling calculations include the line load,

$$Q = \frac{F_n}{w} \quad (a31)$$

And the pressure

$$P = \frac{Q}{b} \quad (a32)$$

Solving for Q and P

$$Q = \frac{F_n}{w} = \frac{F_n}{F_n^{0.778} \cdot P_o^{-0.778} \cdot h_{ice}^{-0.7}} \quad (a33)$$

$$P = \frac{Q}{b} = \frac{F_n^{0.222} \cdot P_o^{0.778} \cdot h_{ice}^{0.7}}{F_n^{-0.333} \cdot P_o^{0.333} \cdot h_{ice}^{1.3}} \quad (a34)$$

For the rule formula

$$Q = F_n^{0.222} \cdot P_o^{0.778} \cdot h_{ice}^{0.7} \quad (a35)$$

$$P = F_n^{0.555} \cdot P_o^{0.445} \cdot h_{ice}^{-0.6} \quad (a36)$$

The design force given in (a21) may be expressed as follows in terms of class-dependent ship and ice class factors



$$F_n = f_a \cdot CF_{CV} \cdot \Delta_{ship}^{0.474}$$

Where

$$CF_{CV} = P_0^{0.526} \cdot V_{ship}^{0.947} \cdot h_{ice}^{0.474}$$

The class factor  $CF_{CV}$  may be given as follows for the different ice classes:

Ice class	$CF_{CV}$
PC6	3.43
PC7	2.60

### Shape factor

From (a19) the shape factor can be written as

$$f_a = \left( 1.90 \cdot \frac{l^2}{c_0} \cdot \tan \frac{\varphi}{2} \right)^{0.474}$$

Due to the complexity of  $C_0$ , the following simplified equation is suggested

$$f_a = \frac{\alpha}{30}$$

## UR I2 “Structural Requirements for Polar Class Ships”

### Summary

This revision introduces the definitions for the ship length ( $L_{UI}$ ), moulded breadth ( $B_{UI}$ ) and the displacement ( $D_{UI}$ ) measured at the upper ice waterline (UIWL). Additionally the table 8 has been updated in accordance with UR W11.

### Part A. Revision History

Version no.	Approval date	Implementation date when applicable
Rev.4 (Dec 2019)	17 December 2019	1 January 2021
Rev.3 (Apr 2016)	22 April 2016	1 July 2017
Rev.2 (Nov 2010)	07 November 2010	1 Jan 2012
Corr.1 (Oct 2007)	-	-
Rev.1 (Jan 2007)	-	-
New (August 2006)	-	1 March 2008

#### • Rev.4 (Dec 2019)

##### 1 Origin of Change:

- Suggestion by IACS member

##### 2 Main Reasons for Change:

###### 2.1 - Ship length L

In Rev.3, the parameter L was defined in I2.3.2.1(e) and I2.13.4.1, as follows: *ship length as defined in UR S2.1, but measured on the upper ice waterline (UIWL).*

In UR S2.1, the definition of ship length is the following one: *The length of L is the distance, in metres, on the summer load waterline from the fore side of the stem to the after side of the rudder post, or the centre of the rudder stock if there is no rudder post. L is not to be less than 96%, and need not be greater than 97%, of the extreme length on the summer load waterline. In ships with unusual stern and bow arrangement the length L will be specially considered.*

Therefore the length L to be used in I2 is as follows: *Distance, in metres, on the upper ice waterline (UIWL) from the fore side of the stem to the after side of the rudder post, or the centre of the rudder stock if there is no rudder post. L is not to be less than 96%, and need not be greater than 97%, of the extreme length on the upper ice waterline (UIWL). In ships with unusual stern and bow arrangement the length L will be specially considered.*

This correct definition is inserted in I2 and, as this parameter is different to the rule length "L" (as defined in UR S2.1), it is named "L<sub>UI</sub>". In addition, the relevant references to "L" in I2 are updated to make reference to "L<sub>UI</sub>".

## 2.2 - Design vertical ice force/moment

In Rev.3, the force  $F_{IB}$  defined in I2.13.2.1 is maximised by considering the ship displacement  $D$  at the upper ice waterline (UIWL), which is the maximum value of the displacement.

Therefore a definition of the displacement is added specifying that it is the displacement at the upper ice waterline (UIWL) and, as this parameter is different to the usual displacement "D", it is named "D<sub>UI</sub>". In addition, the relevant references to "D" in I2 are updated to make reference to "D<sub>UI</sub>".

In the same way, the force  $F_{IB}$  is maximised by considering the ship waterplane area  $A_{WP}$  at the upper ice waterline (UIWL). Therefore it is specified that the ship waterplane area to be used is the one corresponding to the upper ice waterline (UIWL).

In addition, the paragraph "*Where applicable, draught dependent quantities are to be determined at the waterline corresponding to the loading condition under consideration*" is deleted both in I2.13.2.1 and I2.13.4.1 because the said "draught dependant quantities" (i.e. displacement and waterplane area) are now determined at the upper ice waterline (UIWL).

And for transparency, it is specified in I2.13.4.1 that the still water bending moment to be used for strength calculations is the permissible still water bending moment and not the bending moment for a specific loading condition.

## 2.3 - Ship moulded breadth B

In Rev.3, the ship moulded breadth  $B$  is defined on Figure 7 in I2.13.2.1. As the ice waterline indicated on this figure is the upper ice waterline,  $B$  is the moulded breadth corresponding to the upper ice waterline.

As this parameter is different to the usual "B", it is named it "B<sub>UI</sub>", and the definition specifies that it is to be measured at the upper ice waterline (UIWL). In addition, the relevant references to "B" in I2 are updated to make reference to "B<sub>UI</sub>".

## 2.4 – Steel grades for weather exposed plating

In Rev.3, I2.12.4 Table 8, a symbol "F" is indicated as steel grade of mild steel for Material class III. However, steel grade "F" for mild steel is not appeared in UR W11. Therefore the symbol "F" in Table 8 is deleted and replaced by "not applicable", in line with Table 9 "Material Grade Requirements for Classes I, II and III at Low Temperatures" in UR S6.

## **3 List of non-IACS Member classification societies contributing through the TC Forum and/or participating in IACS Working Group:**

None

## **4 History of Decisions Made:**

Member original proposal was submitted in December 2016. Hull Panel agrees with the proposals from the member in January 2017, with some additional comments. Following comments, a revised text was submitted in February 2017. The final Hull Panel approval has been given in October 2019.

## 5 Other Resolutions Changes

None

## 6 Any hindrance to MASS, including any other new technologies:

None

## 7 Dates:

Original Proposal: December 2016                      Made by: Hull Panel  
Panel Approval: 13 November 2019 (Ref: 19233\_PHa)  
GPG Approval: 17 December 2019 (Ref: 19233\_IGc)

### • **Rev.3 (Apr 2016)**

#### .1 Origin of Change:

- Suggestion by IACS member

#### .2 Main Reason for Change:

Following the approval of the 2010 revision of I2, the previous Hull Panel PT49 instructed to identify a smaller number of items which should be prioritized in the next revision phase. As basis for the new Hull Panel PT49, the following five priority items were selected:

- Design loads for non-icebreaking bow forms
- Criteria for icebreakers
- Compression design loads (not covered by this work)
- Rudder design loads (not covered by this work)
- Web frames and stringers

For details, see TB document in Part B.

#### .3 List of non-IACS Member classification societies contributing through the TC Forum and/or participating in IACS Working Group:

None

#### .4 History of Decisions Made:

The Hull Panel PT49 submitted the first proposal to Hull Panel in March 2015. Following comments from the first hearing, a revised proposal was submitted in Sept.2015. A final proposal was submitted to Hull panel in January 2016.

#### .5 Other Resolutions Changes

None

**.6 Dates:**

Panel Approval: 15 March 2016 (Ref: 6023a)  
GPG Approval: 22 April 2016 (Ref: 12187\_IGh)

- **Rev.2 (Jan 2011)**

**.1 Origin of Change:**

- Request by Hull panel (PT49)

**.2 Main Reason for Change:**

To correct the known errors and ambiguities as well as to correct minor format issues in UR I2.

**.3 List of non-IACS Member classification societies contributing through the TC Forum and/or participating in IACS Working Group:**

None

**.4 History of Decisions Made:**

The Hull Panel PT49 created the proposed modifications to correct the known errors and ambiguities as well as to correct minor format issues in UR I2. The Hull Panel approved these changes during the Hull Panel meeting in October 2010. GPG decided to treat the modifications as a revision rather than a correction and the effective date of implementation of the revised UR as 1 January 2012.

**.5 Other Resolutions Changes**

None

**.6 Dates:**

Original Proposal: 13 *October 2010 Made by Hull Panel*  
Panel Approval: *October 2010*  
GPG Approval: 07 *November 2010 (Ref: 7592\_IGd)*

- **Corr.1 (Oct 2007)**

No TB document available.

- **Rev.1 (Jan 2007)**

Council agreed to revise the application date of the UR for the purpose of uniform application by IACS Societies.

- **New (August 2006)**

See TB in Part B.

## Part B. Technical Background

List of Technical Background (TB) documents for UR I2:

Annex 1     **TB for New (August 2006)**

See separate TB document in Annex 1.



Annex 2     **TB for Rev. 2 (Jan 2011)**

See separate TB document in Annex 2.



Annex 3     **TB for Rev. 3 (Apr 2016)**

See separate TB document in Annex 3.



*Note: There are no separate Technical Background (TB) documents available for Rev. 1 (Jan 2007), Corr.1 (Oct 2007) and Rev. 4 (Dec 2019).*

## IACS AHG/PSR

### IACS UR I2 – Structural Requirements for Polar Class Ships

#### - Technical Background -

#### 1.0 Historical Development

An international effort has been made in the development of a uniquely integrated package of measures aimed at protecting life, property and the environment in polar waters. This so-called “harmonisation” process began when several nations recognised the benefits of aligning existing safety and pollution control standards for marine operations in polar waters, and of giving these more general applicability. Germany and Russia made proposals to IMO in the early 1990’s, and these resulted in discussions amongst various interested governments who formed a working group to develop an appropriate approach. This Outside Working Group (OWG) reported its formation and aims to IMO in 1993, and was subsequently expanded to include members from industry, academic and research communities and representatives from classification societies. The efforts of the OWG culminated in the development of the IMO *Guidelines for Ships Operating in Arctic Ice-Covered Waters*, which was promulgated in December 2002 as a joint MSC/MEPC circular (MSC/Circ.1056, MEPC/Circ.399).

The structure and format of the IMO *Guidelines* are divided into construction, equipment, operational and environmental protection sections, although the *Guidelines* themselves include only a minimal set of direct technical requirements for construction. Instead, they outline performance standards and reference compliance with IACS Unified Requirements for Polar Ships as demonstrating adequate performance. Accordingly, in May of 1996, IACS GPG established a “non-permanent” Ad-Hoc Group to establish Unified Requirements for Polar Ships (AHG/PSR), with one working group for structural requirements and one for machinery requirements. Notably, the AHG/PSR also includes non-IACS working members who have expertise and knowledge to assist in the development of requirements for this specialised subject. The efforts of AHG/PSR have resulted in three sets of unified requirements for Polar Ships; UR I1 (Polar Class Descriptions and Application); UR I2 (Structural Requirements for Polar Class Ships); UR I3 (Machinery Requirements for Polar Class Ships).

#### 2.0 Scope and Objectives

The scope of UR I2 includes ice load definition as well as specific strength requirements for plating, framing (including web frames and load-carrying stringers), plated structures (such as decks and bulkheads), and the hull girder. The scope of UR I2 also includes material requirements, as well as corrosion/abrasion allowances. General strength requirements for hull appendages, stem and stern frames, as well as some provisions for local details, direct calculations and welding, are also included. The objective of UR I2 is to provide a unified set of structural requirements to enable polar class ships to withstand the effects of global and local ice loads, as well as temperatures, characteristic of their polar class.

#### 3.0 Points of Discussions or Possible Discussions

##### 3.1 Application

The unified requirements for polar ships are to be applied to any ships constructed of steel and navigating in ice-infested polar waters, except for icebreakers, as specified in UR I1.1.

IACS UR I2 – Structural Requirements for Polar Class Ships

- Technical Background -

### 3.2 Hull Areas

In all existing polar class rule systems, hull area factors are used to relate the calculated bow area loads to the anticipated loads on other parts of the ship. Although it is envisioned that future rule formulations will be based on an envelope of loads derived from various interaction scenarios, the first edition of the IACS unified requirements for polar ships will only provide explicit calculations of bow glancing and ramming loads. Loads are applied to other areas of the ship by means of a hull area factor system. Because the net effect of bow form on loads elsewhere is unclear and controversial, the hull area factors used in the unified requirement are independent of hull angles and based on a nominal load for a ship of given size and class.

### 3.3 Design Ice Loads

The design ice load has been developed to enable each member of the hull structure to resist a single ship/ice interaction event that, although rare, has a nominal expectation of occurring once per year in polar water operations. Although any polar class ship will experience a complex mix of ship-ice interactions during its operational life, the glancing impact scenario has been selected as the basis for the scantling requirements, due to the availability of a relatively mature model describing this type of interaction. Accordingly, the maximum expected bow load associated with a glancing impact is calculated within the accuracy required to yield a sufficiently safe and robust vessel. Loads on areas of the hull other than the bow are estimated by assuming them to be a percentage of the bow load, corrected to remove bow form dependencies (see 3.2 above). Having established the magnitude of the loads for the different hull areas, the average pressure is obtained by transforming the apparent contact area into a reduced rectangular load patch.

### 3.4 Shell Plating and Framing Requirements

The requirements proposed for the scantlings of plating and framing are based on a loading event that begins with ship/ice edge contact over a small area, and continues with growing contact area until the entire structural grillage is loaded to its design condition. Under the design load condition, and with the selected structural response criteria, a certain level of permanent set in the plating and framing should be expected. The scantlings of all framing members are, in general, based on plastic collapse limit state formulae. To calculate the dimensions of the plating and framing, it is first necessary to determine the pressure to be used in the scantling formulae. Since it is generally acknowledged that ice loads are not uniformly distributed over the instantaneous contact area, a load concentration factor (linked to the horizontal dimension of the load patch) is applied to the average pressure. Having calculated the design pressures for the plating and main frames, it is possible to directly calculate, in conjunction with stability checks, the required scantlings of each. The design of load-carrying stringers and web frames are to be based on an analysis of the entire grillage and are to be dimensioned such that the combined effects of shear and bending do not exceed the limit state(s) defined by each member society.

### 3.5 Corrosion/Abrasion Additions and Steel Renewal

The proposed structural design criteria for polar class ships result in the minimum scantlings,  $t_{net}$ , required to resist the design ice loads according to various response criteria. Accordingly, abrasion/corrosion allowances,  $t_s$ , are needed to ensure that the structure can deliver the expected performance at all times between surveys. These margins are linked to anticipated wastage rates,



**IACS UR I2 – Structural Requirements for Polar Class Ships**

**- Technical Background -**

which in turn are related to three factors; hull area, polar class, and the presence/absence of an effective coating system.

**3.6 Material Requirements**

In the proposed requirements for longitudinal strength, plating and framing, there is an implicit assumption that brittle fracture of structural members will not occur. To ensure that this is the case, minimum grades of steel to be used for various structural members are specified. The basic criteria for steel grade selection includes four factors; polar class, material class, thickness of the structural member, and location above or below the waterline.

**3.7 Longitudinal Strength Requirements**

The longitudinal strength requirements assume that ice loads resulting from head-on ramming are not occurring simultaneously with substantial wave loads. The equation to determine the ice force due to ramming is based on an analytical solution, which has been modified on the basis of energy methods and numerical results, and validated against available full-scale data. Substituting ship and class-based design values into this equation yields the maximum ice force. The maximum ice bending moment is subsequently calculated. Distributions of the shear forces and bending moments along the ship have been produced from the analytical model. Bending and shear strength requirements are then evaluated using existing longitudinal strength requirements S5, S7 and S11, with slightly revised permissible stresses because of the relative infrequency of ice loads compared with those arising from waves. Since these permissible stresses are independent of longitudinal position, buckling strength is to be verified over the entire length of the ship.

**4.0 Source/Derivation of Proposed Requirements**

As noted in the foregoing, UR I2 is a consequence of the international effort to harmonise standards for marine operations in polar waters, and is directly connected with the IMO *Guidelines for Ships Operating in Arctic Ice-Covered Waters* (MSC/Circ.1056, MEPC/Circ.399).

## **Technical Background for UR I2 Rev.2, Nov 2010**

### **1. Scope and objectives**

To correct the known typographical errors and ambiguities as well as to correct minor format issues in UR I2.

### **2. Engineering background for technical basis and rationale**

See the attachment "Summary of proposed corrections to UR I2"

### **3. Source/derivation of the proposed IACS Resolution**

Proposal by Hull Panel PT49. See the attachment "Summary of proposed corrections to UR I2"

### **4. Summary of Changes intended for the revised Resolution:**

See the attachment "Summary of proposed corrections to UR I2"

### **5. Points of discussions or possible discussions**

The Hull Panel PT49 created the proposed modifications to correct the known typographical errors and ambiguities as well as to correct minor format issues in UR I2. The Hull Panel approved these changes during the Hull Panel meeting in October 2010. GPG decided to treat the modifications as a revision rather than a correction and the effective date of implementation of the revised UR as 1 January 2012.

### **6. Attachments if any**

"Summary of proposed corrections to UR I2"

## Summary of Proposed Corrections to UR I2 (Corr. 1, Oct 2007)

### Correction 1 - Body plan nomenclature (I2.3.2.1 (i))

The Hull Panel agreed to replace the phrase “body plan A-A” in Figure 2 with “transverse section A-A”.

### Correction 2 - Definition of ship length L (I2.3.2.1 (iii) (a))

To clarify the measurement of  $L$ , the Hull Panel agreed to replace the definition “ $L =$  ship length measured at the upper ice waterline (UIWL) [m]” with “ $L =$  ship length as defined in UR S2.1, but measured on the upper ice waterline (UIWL) [m]”.

### Correction 3 – Equation 19 (I2.5.8)

In Equation 19, the existing definition of  $A_{pn}$  specifies that the cross-sectional area of the attached plate flange is not to be taken greater than the cross-sectional area of the local frame. However, I2.5.8 only applies to cases where the cross-sectional area of the attached plate flange exceeds the cross-sectional area of the local frame. Therefore, the definition of  $A_{pn}$  should be replaced by “ $A_{pn} =$  net cross-sectional area of the local frame [cm<sup>2</sup>]”.

### Correction 4 – Equation 21 (I2.5.8)

Since the plastic neutral axis is located at the edge of the attached shell plate and not its neutral axis, the first term in Equation 21, “ $t_{pn} s z_{na} \sin\phi_w$ ”, should be replaced by “ $t_{pn} \cdot s \cdot (z_{na} + t_{pn}/2) \cdot \sin\phi_w$ ”.

### Correction 5 – Equation 26 (I2.9.2)

Equation 26 is missing a square root sign.

$$t_{wn} = 2.63 \times 10^{-3} \cdot c_1 \sqrt{\sigma_y / (5.34 + 4 \cdot (c_1 / c_2)^2)} \quad [mm]$$

See derivation at the end of this document.

### Correction 6 - Web crippling requirement (I2.9.3)

The existing definition of the yield stress “ $\sigma_y =$  minimum upper yield stress of the material [N/mm<sup>2</sup>]” should be replaced by “ $\sigma_y =$  minimum upper yield stress of the shell plate in way of the framing member [N/mm<sup>2</sup>]”. Furthermore, the definition of  $t_{pn}$  should read “in way of lf”.

### Correction 7 – Other Areas (I2.11.2)

Since all hull areas are covered by the first 3 rows of Table 4, the last row “Other Areas” can be removed.

### Correction 8 – Steel grades for Material Class III (I2.12.1)

Steel grades for Material Class III are defined in Table 6, however no Material Class III structural member is defined in Table 5. Since the only Class III materials are those defined in UR S6.1, the Hull Panel agreed to replace "the Polar ice class notation assigned to the ship and the Material Class of structural members given in Table 5" with "the Polar ice class notation assigned to the ship and the Material Class of structural members according to I2.12.2."

## **Technical Background (TB) document for UR I2 (Rev.3 Apr 2016)**

### **1. Scope and objectives**

Following the approval of the 2010 revision of I2, the previous Hull Panel PT49 instructed to identify a smaller number of items which should be prioritized in the next revision phase. As basis for the new Hull Panel PT49, the following five priority items were selected:

- Design loads for non-icebreaking bow forms
- Criteria for icebreakers
- Compression design loads (not covered by this work)
- Rudder design loads (not covered by this work)
- Web frames and stringers

### **2. Engineering background for technical basis and rationale**

See attachment.

### **3. Source/derivation of the proposed IACS Resolution**

None.

### **4. Summary of Changes intended for the revised Resolution:**

See attachment.

### **5. Points of discussions or possible discussions**

See attachment.

### **6. Attachments if any**

Attachment: *PT 49 – Technical background to UR I1 and UR I2 revision proposals.*

# PT 49 – Technical background to UR I1 and UR I2 revision proposals

IACS Hull Panel Project team 49

03 March 2016

## Introduction

This document describes the rationale and background for the Rule proposal developed by PT 49 on the revision of IACS Unified Requirements for Polar Class Ships, UR I2.

The proposal covers the following aspects:

- Design loads for non-icebreaking bows
- Requirements for icebreaker notation
- Strength evaluation of web frames and stringers

The proposal includes changes in I1 which are related to the introduction of the specific icebreaker requirements. As a consequence of specifying the application of blunt and bulbous bows, some requirements or assumptions to the hull form, performance, and operational limitations are included as well. This is discussed in more detail below.

A proposal originating from the I3 working group related to propeller submergence has been included in I1.

In the original scope of work, design requirements for rudders as well as evaluation of ice compression loads were included. Due to time and budgetary constraints, these tasks have not been prioritized at this stage. These items should be reassessed in the next revision phase.

Some proposals developed as part of this revision work did not reach agreement within the group, and are hence been left out from the final UR I revision proposal. Some references to these proposals are however included and discussed for possible use in later revisions.

General acceptance criteria for direct calculations for web frames and girders have been included in the rule proposal, and it is opened up for both linear and non-linear calculation methods. However, detailed procedures for how these structures are to be evaluated is not included, and it is considered crucial that a common approach is developed to ensure consistent practice and interpretation among the classification societies. Hence, it is advised that that a separate group is tasked to develop a detailed guidance describing suitable evaluation procedures for web frames and stringers.

A general clean-up of the rule text has been carried out to correct typos, inconsistencies etc.

## Task 1 – Design loads for non-icebreaking bows

### Introduction

The rule design load formulation for dimensioning of the bow structure is according to IACS UR12 only valid for vessels with icebreaking forms. The definition of *icebreaking form* is however non-existent, but it is reasonable to assume that the term excludes vessels with bulbous bows, or vessels with extreme blunt or vertical bow forms. The aim of the current revision has been to clarify the applicability of the existing load formulation, and specify alternative methods, or limitations, for other bow forms not covered by the existing formulation. In addition, other relevant requirements which depend on the bow form are addressed, including longitudinal strength requirements and design accelerations as given in I3.

### Background and summary of the new rule proposal

The Polar Class requirements do not give any explicit limitations with regard to hull form for any ice class. It is however evident that the rule requirements are developed with traditional icebreaking designs in mind, on which also most of the operational experience and validations have been based. The rules are seen to be less applicable for unconventional designs, with one of the most apparent deficiencies being the definitions of the design loads.

In the new revision proposal, the text in I1 is amended to emphasize that the Polar Class notations are developed for ships intended for independent operation in ice-infested polar waters. This has clearly been the basis for the development, and should be stated explicitly stated in the Rules.

Although intended for independent operation and customized for traditional icebreaking forms, the Polar Class notations have been applied on vessels with alternative designs. These include traditional commercial vessels with hull shapes optimized for open water, for which the (two) lower Polar Classes are considered to be a possible alternative to the (two) highest Baltic classes. In addition, ship-shaped offshore units have been assigned higher Polar Class notations without being designed for independent operation in ice. Increased focus on energy efficiency and multi-functional vessels calls for innovative solutions which will not necessary be covered by the hull families considered during the initial development of the rules. Hence, in the new revision proposal, design procedures for alternative designs have been addressed.

The load formulation which is basis for the Polar Class strength requirements is based on a set of ship/ice interaction scenarios, which are considered to be the most demanding design cases for “standard” polar class vessels. During the development of the Rules, dozens of different ship/ice interaction scenarios were identified and considered potentially relevant for structural design. Preferably the governing design scenario for any part of the hull should be chosen from a “library” of relevant scenarios, depending on ship size, type, shape, class etc. However, in the current rules, two selected scenarios are considered to be governing, namely:

- Ramming scenario
- Glancing impact scenario

The ramming scenario is considered to be governing for the longitudinal strength, while the glancing impact scenario is considered to be dimensioning for the structural design of the bow (and used as basis for the remaining part of the hull structure). During the development of the rules, the ice compression scenario was also considered as potentially governing for the transverse strength of the midship structure, but have until now not been addressed explicitly in the Rules.

The reasons for imposing limitations with regard to bow form to the original design load formulation are not explicitly explained in the available background documentation. One reason may be the fact that alternative designs were not considered during the development of the rules, and that the limitation is a simple consequence of insufficient validation and verification. In any case it is reasonable to assume that possible limitations are related to the validity of the assumption that the glancing impact actually is the governing scenario, and/or the validity of the derivation of the load formulation itself. These will be discussed in more detail below.

When it comes to the derivation of the load formulation, several assumptions which potentially could limit the applicability of the formulation are discussed below. Extremities lie typically within this category, and are often not covered by any validation or calibration against available full scale and model test data. As mentioned above, the main focus during the development was on traditional icebreaking bows, and other bow shapes including bulbous bows were not part of the evaluation. Consequently, no validations or calibrations of such hull shapes are found. However, if the applicability of the load formulation should be limited to the bow forms considered during the development of the Rules, many bow forms which easily can be classified as “icebreaking” will be excluded. Other aspects limiting the applicability are discussed below, including approximations introduced by the simplified hull shape coefficient  $f_a$ , the limitations introduced with regard to the patch aspect ratio, and the relevancy of the assumed shape of the ice footprint area.

In the current Rule proposal, the term *icebreaking form* has been removed. Instead, the validity of the existing load formulation has been defined by introducing limitations on bow angles.

Certain limitations to the hull form have been introduced for ice classes PC1-PC5. These vessels are normally purpose-built for operation in difficult ice conditions, and bow forms which are not considered effective for ice operation should generally be avoided. For the higher ice classes, bows with vertical sides and bulbous bows are examples which are not considered effective.

A paragraph addressing the expectation that Polar Class vessels should be able to operate independently in ice conditions representative for the ice class have been added in I1. However, requirements to hull form and performance should not restrict the application of new, innovative or other purpose-built designs which do not fit directly into the formulations, but these should be subject to special consideration by each Society.

For PC6 and PC7, open water bows including bows with vertical sides and bulbous bows may be accepted, and alternative load formulations have been developed for these cases. In general, bulbs should be treated as a structural appendage, i.e. the own structural requirements should not drive those of the overall structure.

The longitudinal strength requirements and the design accelerations given in URI3.6 are derived based on the vertical force component in the bow obtained from a ramming impact scenario. In the

current proposal, a paragraph is added to emphasize that the basis for the requirements is the ramming scenario. This is consistent with I2.3.1 (i) for bow design loads.

Intentional ramming is not considered to be a relevant operational scenario in design ice conditions for bows with vertical sides or bulbous bows (PC6 and PC7). Hence, the longitudinal strength requirement, as well as the design accelerations based on the ramming, and the requirements will hence not be relevant for these vessels. In the rules, it is stated that this should be specified in the Class certificate or equivalent.

### Application of design load formulation for dimensioning of bow structure

For the glancing impact scenario, on which the derivation of the design load for dimensioning of the bow structure is based, the ship is assumed to strike an ice edge of infinite mass with the bow shoulder as shown in Figure 1. During the collision, the ship will penetrate the ice until the normal velocity is zero, and the ship rebounds away. The footprint for a given penetration depth  $\delta$  will take form of a triangle and is limited by the width  $W$  and height  $H$ .

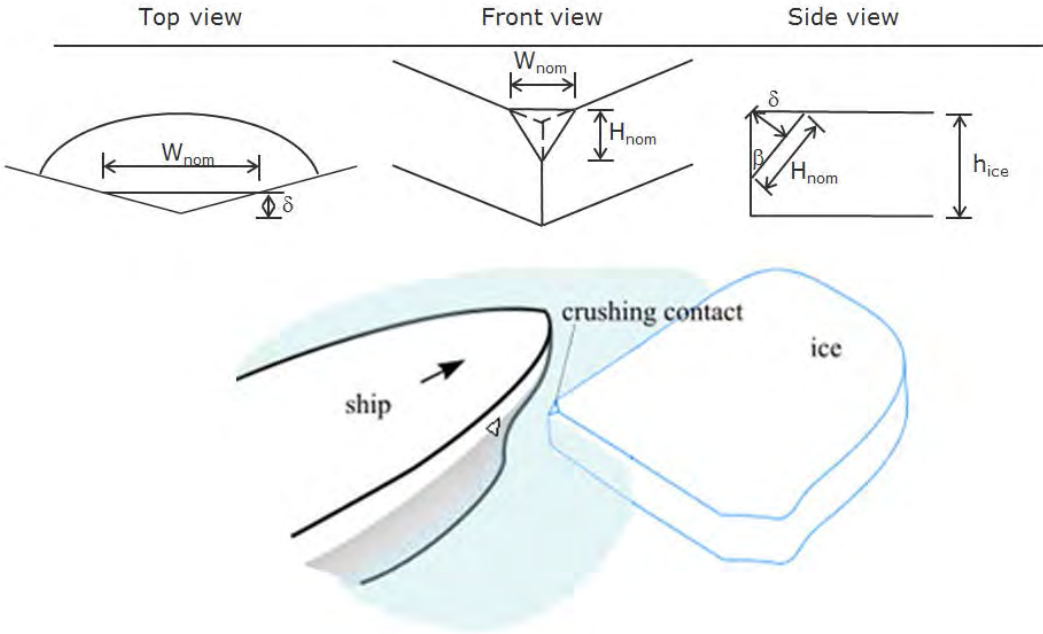


Figure 1 Design scenario for the general glancing impact collision, indicating the nominal contact geometry

The design force is found by assuming that all the initial normal kinetic energy is transformed into crushing energy of the ice. Given the initial geometry of the ice, the resulting triangular footprint is determined from the shape of the bow based on the final penetration depth. Hence, the derivation of the design load and the corresponding footprint area is a result of a simple geometry consideration as long as the vertical extent of the footprint does not exceed the assumed thickness of the ice floe.

As discussed above, the following aspects may impose limitations on the rule formulation:

- Relevancy of the glancing impact scenario for a given hull form



- Accuracy of derived load formulation

Based on available background documentation and evaluations carried out during the revision work, it has not been possible to justify the use of other scenarios than the glancing impact as governing design scenario for any specific bow form. Hence it is proposed to continue using the glancing impact scenario as basis for the dimensioning of the bow.

Regarding the derivation of the load formulation itself, aspects which potentially could justify limitations on the applicability of the load formulation are discussed below.

In the present bow design load formulation, the bow form dependency is represented by the shape coefficient  $fa$ , where the smaller of the crushing or flexural strength shape coefficient is used. For most conventional icebreaking bow forms, the crushing strength is normally governing, and is hence focused on below. Due to a complex equation for the crushing strength, a simplified expression has been used in the Rules. In Figure 2 (extracted from the background document for ice impact loads) the exact vs. the rule  $fa$ -factor is compared for four bow forms, and it is seen that the simplified expression may generate conservative high forces compared with the exact expression for certain bow forms (e.g. landing craft bows), and a cut-off value of 0.6 is introduced to avoid extreme values. Consequently, the upper limit of the  $fa$ -factor is for these cases considered more related to the introduction of the simplified rule expression than to represent a limitation on the general load scenario or formulation itself.

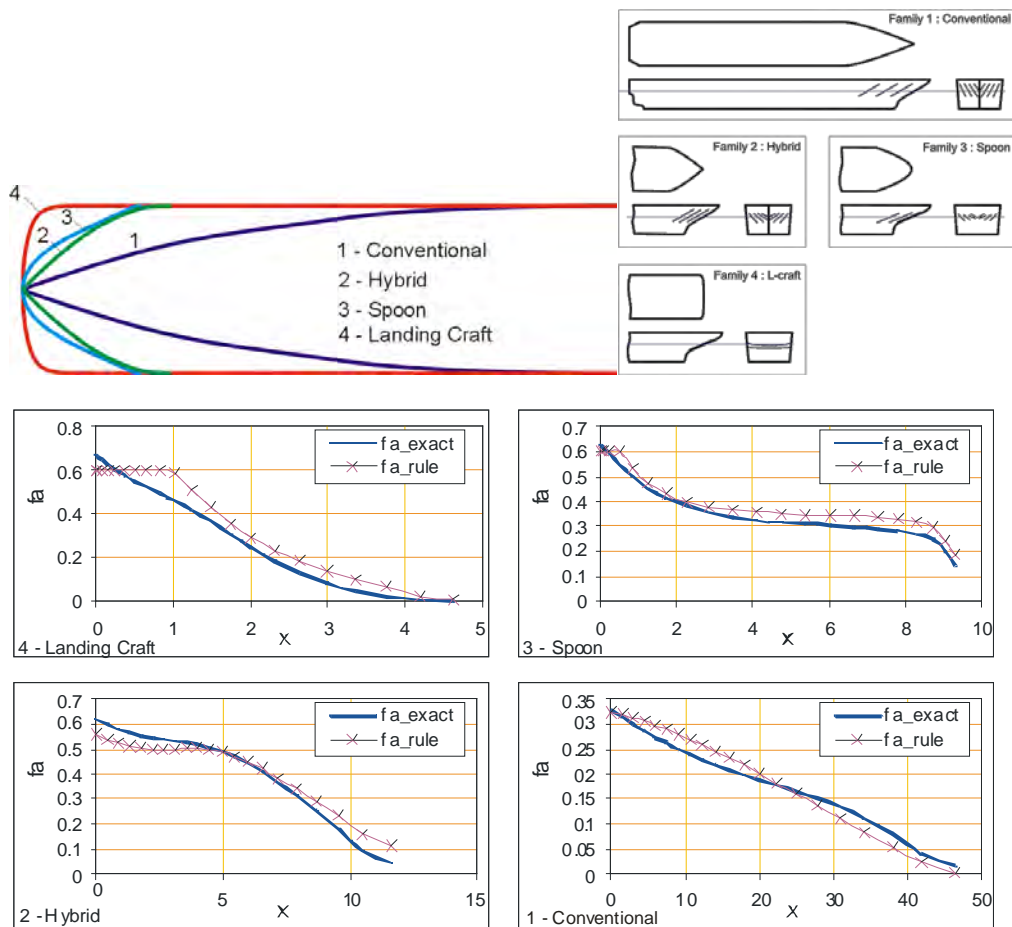


Figure 2 Comparison of exact and rule  $fa$ -coefficient for considered hull forms (I2 Background Notes)

The bow forms shown in Figure 2 have different waterplane shapes ranging from conventional to landing craft bows. When introducing the upper limit of the fa-coefficient, it is reasonable to conclude that all these bow forms lie within the application range of the load formulation. Hence, it is difficult to see that this will cause any limitations with regard to waterline angles alone.

A second aspect is related to the limitations introduced in connection with the evaluation of the corresponding contact patch area. The size of the contact area is determined based on the ratio between the calculated width and height of the triangular footprint area obtained from the collision impact scenario. To avoid that the aspect ratio approaches zero, a lower limit of 1.3 has been introduced, which corresponds to a normal frame angle of  $10^{\circ}$ . The existence of such a lower limit may indicate that frame angles at least down to  $10^{\circ}$  can lie within the validity range of the formulation.

The third aspect is related to the validity of the assumption that the crushed volume of the ice is shaped like a triangular pyramid. This is in general valid as long as the vertical projection of the contact area is less than the assumed thickness of the ice floe. This assumption may be expressed by the following form:

$$H_{vert} = 0.366 \cdot F_n^{0.556} \cdot P_0^{-0.556} \cdot \sin(\beta')^{-0.5} \cdot \cos(\beta') \leq h_{ice}$$

Although somewhat complicated, it is possible to evaluate the combination of waterline angles  $\alpha$  and normal frame angles  $\beta'$  which violates the assumption, depending on the ice class and displacement of the vessel. Some initial evaluations indicate that this may be relevant for frame angles up to  $10$ - $15^{\circ}$  for larger vessels with the lowest ice classes PC6 and PC7.

It is worth mentioning that the possible limitation discussed above is only relevant as long as the defined ice thickness  $h_{ice}$  is assumed to have a physical meaning for the crushing impact scenario, and not only a “scale” parameter defining the flexural strength of the ice.

Considering the aspects above, it is very difficult to define hull angles where it is obvious that the existing load formulation is not valid. It is however reasonable to consider the formulation less applicable for vessels with small normal frame angles  $\beta'$ , particularly in combination with larger water plate angles  $\alpha$  (i.e. blunt or “shoe-box” shaped bow forms).

In the rule proposal, it is suggested to consider the existing load formulation valid for bow forms where the buttock angle,  $\gamma$ , at the stem is positive and less than  $80^{\circ}$ , and where the normal frame angle  $\beta'$  at the centre of the foremost sub-region of the bow is equal to or larger than  $10$  degrees. A limit of  $10^{\circ}$  is, beyond what have been discussed above, considered to be a practical compromise, which ensures that most traditional designs are covered by the formulation. Such a limit will at the same time exclude most of the unconventional designs. However, bearing in mind the original “icebreaking bow” statement, the proposal will now cover bow forms which easily can be classified as “non-icebreaking”.

For bows with vertical sides not fulfilling the bow angle criteria proposed for the existing load formulation above, an alternative formulation has been developed based on the same glancing impact scenario. When the normal frame angle approaches zero, the vertical projection of the nominal contact area becomes equal to the assumed thickness of the ice, and may be defined as shown in Figure 3. The derivation of the impact forces generated from such a scenario is seen to be

somewhat complicated and not well suited for rule application unless a simplified expression is introduced. However, a formulation for the special case where the normal frame angle is  $0^\circ$  (vertical sides), as shown in Figure 4, may be a feasible alternative for such designs. The load formulation is presented in Appendix B.

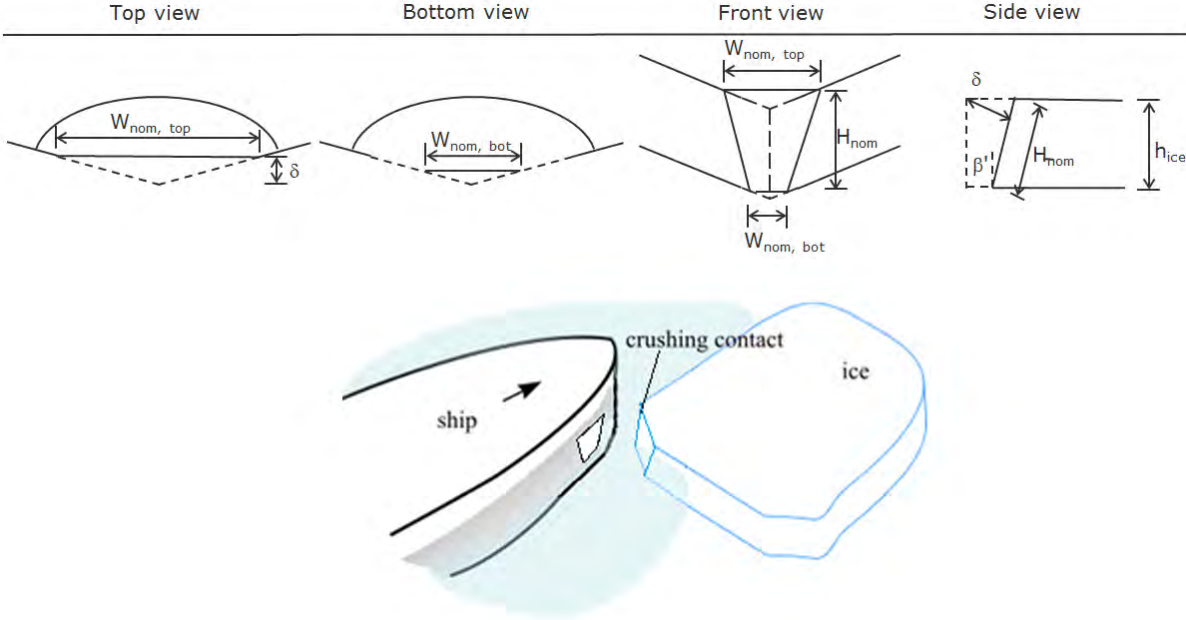


Figure 3 Glancing impact collision where the vertical projection of the contact area equals the ice thickness

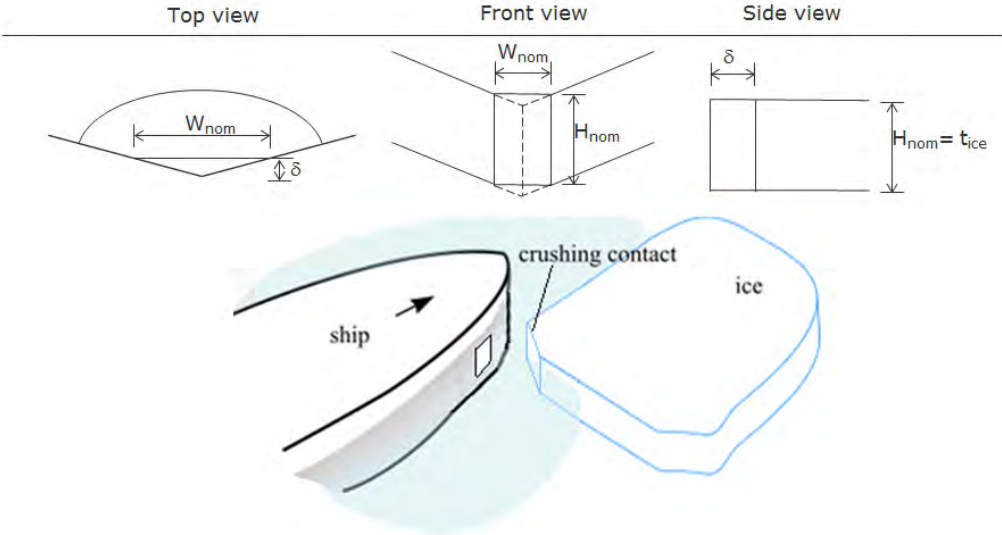


Figure 4 Glancing impact collision for a bow with vertical sides ( $\beta=0^\circ$ )

For the case where the normal frame angle is  $0^\circ$  (vertical sides), the design force  $F$ , line load  $Q$ , and pressure  $P$  become:

$$F_n = f_a \cdot P_0^{0.526} \cdot V_{ship}^{0.947} \cdot h_{ice}^{0.474} \cdot \Delta_{ship}^{0.474}$$

$$Q = F_n^{0.222} \cdot P_0^{0.778} \cdot h_{ice}^{0.7}$$

$$P = F_n^{0.555} \cdot P_0^{0.445} \cdot h_{ice}^{-0.6}$$

As for the existing load formulation, the terms  $P_0$ ,  $V_{ship}$ , and  $h_{ice}$ , may be represented by class factors. Assuming that:

$$CF_{CV} = P_0^{0.526} \cdot V_{ship}^{0.947} \cdot h_{ice}^{0.474}$$

$$CF_{DV} = P_0^{0.778} \cdot h_{ice}^{0.7}$$

$$CF_{PV} = P_0^{0.445} \cdot h_{ice}^{-0.6}$$

the parameters read:

$$F_n = f_a \cdot CF_{CV} \cdot \Delta_{ship}^{0.474}$$

$$Q = F_n^{0.222} \cdot CF_{QV}$$

$$P = F_n^{0.555} \cdot CF_{PV}$$

The class factor  $CF_{C,vert}$  may be given as follows for the different ice classes:

Ice class	$CF_{CV}$	$CF_{QV}$	$CF_{PV}$
PC 6	3.43	2.82	0.65
PC 7	2.60	2.33	0.65

The  $f_a$ -factor is proposed to be:

$$f_a = \frac{\alpha}{30}$$

The alternative load formulation presented above is suggested to be used for bows with vertical-like sides, where the normal frame angle  $\beta'$  is between 0-10° at the centre of the foremost sub-region of the bow. In Table 1 to Table 4, a comparison between the new vertical bow formulation and the existing formulation (with frame angle  $\beta' = 10^\circ$ ) is presented for a range of ship sizes and waterplane angles.

**Table 1 Comparison of design force – existing formulation vs. proposed blunt/vertical bow formulation – PC7**

Waterplane angle $\alpha$	Design force - PC7							
	$\Delta = 10$ kt		$\Delta = 25$ kt		$\Delta = 50$ kt		$\Delta = 100$ kt	
	Existing formulation ( $\beta' = 10^\circ$ ) [MN]	Blunt bow formulation [MN]	Existing formulation ( $\beta' = 10^\circ$ ) [MN]	Blunt bow formulation [MN]	Existing formulation ( $\beta' = 10^\circ$ ) [MN]	Blunt bow formulation [MN]	Existing formulation ( $\beta' = 10^\circ$ ) [MN]	Blunt bow formulation [MN]
20	4.1	5.1	7.3	7.9	11.4	10.9	17.7	15.1
25	4.7	6.4	8.5	9.8	13.2	13.6	20.6	18.9
30	4.7	7.7	8.5	11.8	13.2	16.3	20.6	22.6
35	4.7	9.0	8.5	13.8	13.2	19.1	20.6	26.4
40	4.7	10.2	8.5	15.7	13.2	21.8	20.6	30.2
45	4.7	11.5	8.5	17.7	13.2	24.5	20.6	34.0

Table 2 Comparison of design force – existing formulation vs. proposed blunt/vertical bow formulation – PC6

Waterplane angle $\alpha$	Design force - PC6							
	$\Delta= 10$ kt		$\Delta= 25$ kt		$\Delta= 50$ kt		$\Delta= 100$ kt	
	Existing formulation ( $\beta'=10^0$ ) [MN]	Blunt bow formulation [MN]	Existing formulation ( $\beta'=10^0$ ) [MN]	Blunt bow formulation [MN]	Existing formulation ( $\beta'=10^0$ ) [MN]	Blunt bow formulation [MN]	Existing formulation ( $\beta'=10^0$ ) [MN]	Blunt bow formulation [MN]
20	5.4	6.7	9.7	10.4	15.2	14.4	23.6	19.9
25	6.3	8.4	11.3	13.0	17.6	18.0	27.4	24.9
30	6.3	10.1	11.3	15.6	17.6	21.6	27.4	29.9
35	6.3	11.8	11.3	18.2	17.6	25.2	27.4	34.9
40	6.3	13.5	11.3	20.8	17.6	28.8	27.4	39.8
45	6.3	15.2	11.3	23.4	17.6	32.4	27.4	44.8

Table 3 Comparison of design pressure – existing formulation vs. proposed blunt/vertical bow formulation – PC7

Waterplane angle $\alpha$	Design pressure - PC7							
	$\Delta= 10$ kt		$\Delta= 25$ kt		$\Delta= 50$ kt		$\Delta= 100$ kt	
	Existing formulation ( $\beta'=10^0$ ) [MPa]	Blunt bow formulation [MPa]	Existing formulation ( $\beta'=10^0$ ) [MPa]	Blunt bow formulation [MPa]	Existing formulation ( $\beta'=10^0$ ) [MPa]	Blunt bow formulation [MPa]	Existing formulation ( $\beta'=10^0$ ) [MPa]	Blunt bow formulation [MPa]
20	1.8	1.6	2.1	2.1	2.3	2.5	2.5	3.0
25	1.9	1.8	2.1	2.3	2.4	2.8	2.6	3.4
30	1.9	2.0	2.1	2.6	2.4	3.1	2.6	3.7
35	1.9	2.2	2.1	2.8	2.4	3.4	2.6	4.1
40	1.9	2.4	2.1	3.0	2.4	3.7	2.6	4.4
45	1.9	2.6	2.1	3.2	2.4	3.9	2.6	4.7

Table 4 Comparison of design pressure – existing formulation vs. proposed blunt/vertical bow formulation – PC6

Waterplane angle $\alpha$	Design pressure - PC6							
	$\Delta= 10$ kt		$\Delta= 25$ kt		$\Delta= 50$ kt		$\Delta= 100$ kt	
	Existing formulation ( $\beta'=10^0$ ) [MPa]	Blunt bow formulation [MPa]	Existing formulation ( $\beta'=10^0$ ) [MPa]	Blunt bow formulation [MPa]	Existing formulation ( $\beta'=10^0$ ) [MPa]	Blunt bow formulation [MPa]	Existing formulation ( $\beta'=10^0$ ) [MPa]	Blunt bow formulation [MPa]
20	2.1	1.9	2.4	2.4	2.7	2.9	3.0	3.5
25	2.2	2.1	2.5	2.7	2.8	3.3	3.1	3.9
30	2.2	2.4	2.5	3.0	2.8	3.6	3.1	4.4
35	2.2	2.6	2.5	3.3	2.8	4.0	3.1	4.7
40	2.2	2.8	2.5	3.6	2.8	4.3	3.1	5.1
45	2.2	3.0	2.5	3.8	2.8	4.6	3.1	5.5

The comparison shows that the two formulations produce similar design forces and pressures (in average depending on ship size) for smaller to moderate waterplane angles. The consequences for the scantlings may be relatively stronger transverse frames due to increased height of the design load patch. The new formulation for blunt/vertical bows will however give higher forces and pressures for larger waterplane angles, which is considered reasonable. For larger waterplane angles, the simplified  $f_a$ -coefficient is seen to be conservative compared with the “exact” solution, and is considered as an acceptable consequence of the proposed formulation.

When it comes to the loads on the bulb, it should first be mentioned that the bulb should be considered as an appendage, i.e. that their own structural requirements should not drive those of the overall bow structure. However, while the the blunt/vertical bow side formulation is based on a direct derivation of the glancing impact scenario, the development of a formulation for a similar relevant scenario for bulbs has proven to be difficult. For convenience, it has been proposed to use the existing and new proposed load formulation as reference. Although further revisions should continue to look into the possibility of deriving explicit formulations for all types of hull forms, including bulbs, the current proposal is considered sufficient at this stage.

Bow forms which are not covered by the above should be specially considered by each member society.

## **Performance/hull shape criteria for Polar Class ships**

The introduction of performance hull shape criteria was not part of the original scope for this revision work. The powering requirements have been discussed in length during the development of the rules, and the exclusion of such criteria was based on a decision taken in 1997 during the 8<sup>th</sup> semi-annual harmonisation meeting of the IMO Outside Working Group which developed the Draft Code of Polar Navigation. Nevertheless, the debate has continued whether the IACS requirements should include performance requirements for reasons of safety. During the work with the load formulations and the icebreaker requirements, it was found that there is a need for a general performance requirement for all Polar Class vessels to ensure that the vessel can operate safely in the anticipated ice conditions as described by the ice class. The requirements are deliberately formulated somewhat generic, and the intention is to raise the flag and to ensure agreement between designer and owner with regard to the capabilities of the ship. Detailed guidance describing applicable procedures and detailed criteria should be developed separately. Please note that the term “representative ice conditions” does not necessarily refer to the most severe ice condition as described by the ice class, but may be linked to a typical ice condition and operational mode which is representative for the intended voyage profile.

Please note that this requirement should not exclude vessels or unit types which are explicitly not designed to operate independently in ice (e.g. drill ship escorted by icebreakers, barges, etc), but such assumptions or limitations should be explicitly stated in the Class certificate or equivalent for transparency.

## Task 2 – Develop criteria for icebreakers

### Introduction

In the current IACS UR I it is explicitly stated that the requirements are not applicable for *Icebreakers*. By introducing *Icebreakers* in the new revision of the Rules, there is a need for providing clear directions on how ships that are to receive the additional *Icebreaker* notation should be handled. The intention with this work is to clarify the applicability of the *Icebreaker* notation (I1), include relevant structural requirements in I2, and coordinate relevant requirements in I3.

### Background for rule proposal

Although not covering *Icebreakers*, the rules state that vessels which are assigned an *Icebreaker* notation may have additional requirements and are to receive special consideration. In the rules, an *Icebreaker* is referred to as a “ship having an operational profile that includes escort or ice management functions, having powering and dimensions that allow it to undertake aggressive operations in ice-covered waters, and having a class certificate endorsed with this notation.”

Before discussing the detailed requirements which should be associated with the specific notation, it might be worth discussing the applicability of the notation, and the features which typically differentiate these vessels from other vessels without the additional notation. Noting the definition of *Icebreakers* above, there are clearly expectations and assumptions associated with the notation which are related to type of operations and performance including manoeuvrability and powering.

Higher polar class ships are expected to spend more of their lives in ice-infested waters, and consequently experience more and higher ice impact loads. The actual distributions of loads will therefore have a probabilistic character, which implicitly are reflected in the choice of ice class. An *icebreaker* will similarly, due to the operational profile, expect to experience more frequent and severe ice impacts relative to a commercial vessel of same parent ice class, and this may be reflected in the determination of design loads.

From a structural strength and performance point of view, the following aspects may be considered as (potential) differentiators compared to a general icebreaking vessel covered by the current Rules:

- Sufficient performance to undertake more aggressive operations in design ice conditions
  - o Hull form and maneuverability
  - o Propulsion power
- Sufficient strength to withstand additional loads due to more aggressive operations in design ice conditions:
  - o Higher frequency of impacts during lifetime - increased probability of extreme loads
  - o More available power/higher impact speeds – potentially increased extreme loads
  - o Increased local loading on other parts of hull and appendages, e.g. outside defined icebelt, shoulders, bottom and stern, as well as rudders, due to increased maneuverability and aggressive operation
  - o Higher global loads and accelerations due to more aggressive ramming operations

To address the expectations associated with the rule definition of an *Icebreaker*, it is reasonable to introduce additional requirements to the hull form and the propulsion power. However, in the current proposal, the general performance requirement proposed in I1 (and discussed above) is

considered to sufficiently cover *Icebreakers* as well. Relevant ice conditions and acceptance criteria applicable for the type of operation should however be considered.

For the design loads which are used for dimensioning of the bow structure, one may argue that the general loading should be increased due to a more aggressive operational profile. The same applies to the horizontal and vertical extensions of the defined hull areas. However, in the current proposal, the dimensioning level in the bow is retained, but some general minimum level of strengthening in the non-bow areas have been proposed as well as increased strengthening of the stern.

During the development of the original rule proposal, a separate longitudinal strength criterion for *Icebreakers* was included. Since *Icebreakers* were excluded from the original rule proposal, this specific requirement was removed. In the current rule proposal, it is suggested to re-introduce this requirement.

## **Applicability of Icebreaker notation**

The additional *Icebreaker* notation is considered applicable for all Polar Class notations.

## **Hull area factors and regions**

As mentioned above, it might be reasonable to keep the existing design loads for dimensioning of the bow structure, based on among others the assumption that the calibration of the design loads to a large extent has been made based on experience with icebreakers. However, increased manoeuvrability, power, and more aggressive operation might increase the loading on the other parts of the vessel, particularly for the lower ice class vessels. In general, the area factor for the stern ice belt and the stern lower has been increased by approximately 25%, and all non-bow area factors should not less than the area factor determined for PC3.

The proposal is a simple percentage-increase compared to the standard area factors and is based on a review of existing ice class rules (e.g. DNV Rules for vessels intended for Arctic and icebreaking service, ABS ice class rules, etc). In the DNV Rules, the design loads in the stern icebelt is for icebreakers 80% of the bow load (same as proposed for PC3-PC7 Icebreaker), an increase of 33% compared with a ship without icebreaker notation. Similar relations may be found for the other hull areas.

The proposal was originally introduced in the DNV Rules for Polar Class ships in 2008. The intention with the requirement is to keep a minimum level of strengthening in the non-bow areas, particularly for the lower ice classes.

For *Icebreakers* it is suggested that the fore boundary of the stern region should at least be 0.04 L fore of WL angle = 0 degrees at UIWL, i.e. stern shoulder to be included in stern region. This is in accordance with common requirements given for icebreakers in existing ice class rules.

## **Loading on rudders, nozzles, azimuthing propulsion units etc**

For appendages, it is stated that the design loads should be representative for the location of their attachment to the hull structure or their position within a hull area. Hence, it is reasonable to link



this to the hull area factor (AF). Assuming that the hull area factor is increased for *Icebreakers*, the design loads for the appendages should be increased accordingly. However, as there are no explicit requirements for the appendages in the rules, the rule text has not been changed.

### **Requirements to longitudinal strength**

It is suggested to re-introduce the original utilization factor to determine allowable stresses for icebreakers. A utilization factor of  $n=0.6$  was originally introduced for icebreakers ( $n=0.8$  for other ship types) to take into account more aggressive operations assumed to be associated with icebreakers. The requirement was later removed, as it was agreed that the Rules should not cover icebreakers.

### **Requirements related to machinery section I3**

In the current draft revision proposal for I3, additional requirements associated with the *Icebreaker* notation are to be determined by each member society.

The only reference to *Icebreaker* is a requirement to a fast torque relief arrangement are to be fitted in order to provide effective protection of the rudder actuator in case of the rudder being pushed hard over against the stops.

## Task 5 – Procedures for web frames and stringers

### Introduction

The current requirements for web frames and stringers given in IACS URI2 provide little guidance for design. There is hence a need for consistency in the treatment of conventional web frames and stringers, as well as general grillage systems, in order to avoid different interpretations and design criteria among the IACS member societies.

### Background for rule proposal

The Polar Class requirements are generally derived using plastic design philosophy. This is based on the consideration that some minor deformations (e.g. local denting) could be an acceptable consequence of ice operation, provided that this does not compromise the overall strength or watertight integrity of the ship.

The design criteria for plastic design are normally evaluated against loss of stiffness (stiffness change), permanent deformations or plastic strains. As opposed to elastic design, where the limit state could be a stress criterion related to first yield, plastic design has in general many possible limit states ranging from yield to final rupture.

For the plating and local frame requirements, the limit states defined in the PC rules are based on a plastic collapse mechanism. As the collapse model ignores the effect of membrane stresses, strain hardening and in principle the possible redistribution of loads to adjacent members, the structure has substantial reserve resistance beyond the design condition. This is particularly true for the local plating members, which can carry significantly higher loads while undergoing deformations several times the plate thickness before rupture. For individual ice frames, the reserve resistance is however less significant, and there are uncertainties both with regard to (the combinations of) failure modes as well as the ability to mobilize the assumed plastic resistance of the cross section and any membrane action in the member. For higher level components like web frames and stringers, the ability to mobilize additional reserve resistance may be even less apparent. Stability of web plates and flanges will have to be checked separately.

Limit states used as basis for design should reflect the potential consequences of structural failure. Assuming that the ice patch is limited in height and width, a rupture of a single plate member may not be considered very critical for the survivability of the vessel, while a structural failure of a primary member may ultimately compromise the vessel's structural integrity.

Hence, a higher utilization of the plating compared to primary members may be rationalised from a risk evaluation point of view. This type of hierarchy strength principle is also described in the background documents of the current rules, where a system of relaxed plate and stricter ice frame requirements is adopted.

In addition to the potential reserve resistance or consequences of structural failure discussed above, the selection of appropriate limit states should reflect the probability level of the design load applied on the different members. The design loads which have been derived for the Polar Classes may be considered as extreme loads, and may be considered conservative, both with regard to the

derivation of the load scenario, as well as the ice class factors used as basis for the assessment. However, there are no explicit references to a formal probability level or return period for an actual trading vessel. The governing design load for all structural members, ranging from the local plating to the grillage system including bulkheads and decks, is based on a glancing impact scenario, where the impact force is represented by an average pressure over a patch area with defined height and length. For small areas, a peak pressure factor (PPF) is introduced to take into account the possible existence of higher pressure zones within the defined patch area. In addition, the PPF is used to increase the general pressure level for certain structural elements. However, both the PPF formulation and its application on the various members have been questioned, and compared to other rule formulations, the PC loads appear to be more conservative for individual members carrying larger fractions of the defined patch load. It too must be understood that the structural response in the Rules allows for limited plasticity and is thus a higher level than other Rules sets that use elastic response principles. Hence, the use of the relatively extreme Polar Class design loads may imply that an implicit (relative) safety factor could be embedded into the load formulation, at least for web frames and stringers with larger spans, depending upon the response criteria selected.

When the limit state is defined, the corresponding acceptance criteria must reflect the analysis method used and the response parameters considered in the assessment. For the assessment of individual primary members and grillage systems, several methods may be applicable:

- Analytical elastic or plastic methods
- Beam analysis
- Linear or non-linear finite element analysis

Analytical methods are generally simple in format and may be a preferred tool for simple strength checks of individual members, e.g. for establishing initial dimensions. The advantage is obviously that the necessary scantlings can be determined by well-defined formulas without the use of advanced computational tools. The drawback is however the difficulty in representing the actual response pattern, the possible complex geometry and support conditions, as well as the difficulties in properly taking into account the effect of the members being part of a grillage system, particularly in the plastic regime.

Evaluation of the structural response by use of finite element methods allows for a much more accurate representation of the actual (variations in) geometry, as well as the interaction between the different members considered. Finite element analysis requires however generally much more resources than analytical methods, and require also special competence which may not be easily accessible for all parties. Using non-linear finite element methods as basis for documenting structures to meet the reliability level of a specific code will require an in-depth understanding of the inherent safety requirements of the governing code as well, and there is definitely a need for a detailed guidance to ensure reliable and consistent results.

During the development of the original Rules, an analytical procedure for evaluating grillage systems was proposed based on the Russian rules. The formulas for web frames and stringers were based on a plastic approach and incorporated the presence of lower level strength members, taking into account their supporting and load distributing effects. Due to lack of agreement, the proposal was however excluded from the first official rules.

As part of the work related to the current rule revision, a basis for evaluating stringers and web frames both with analytical and direct calculations has been developed. Both the analytical formulations and the procedures for direct calculations were based on earlier work done by DNV-GL. During the development of the analytical formulations, it was however acknowledged that it is difficult to develop generic analytical formulations for grillage systems which can represent the actual response with sufficient degree of accuracy, taking into account the actual (variations in) geometry, boundary conditions, interactions between the different strength members. Based on the outcome from the verification of the formulations, as well as response from the first hull panel hearing phase, the accuracy of the proposed formulations were not found to meet the desired level of accuracy, and it was decided not to include the proposal formulation in the current revision proposal. In addition, concern was raised with respect to scantling outcomes for PC7 and PC6 ships in comparison to Baltic IA and IA Super scantlings, suggesting that further validation and development is needed. The derived formulations are however documented in Appendix A and may be used as reference in later revisions.

It is unfortunate that this revision work have not lead to the introduction of analytical formulations for web frames and stringers, and there is obviously a need for such formulations, particularly for determination of initial dimensions. However, as a result of the above, each member society should preferably come up with guidance for initial design.

However, for web frames and stringers being part of grillage systems, the new rule proposal assumes in any case the use of direct calculations. Direct calculations tend to become a natural and basic part of the strength documentation in ship design, and will now be expected for final documentation of grillage systems.

The rule proposal for direct calculation is intentionally left quite generic, and the specific procedure has to be developed by each member society. However, the assumptions and requirements to the execution of the analysis and evaluation of results should reflect the acceptance criteria and considerations below in order to ensure that the proposed design points are treated consistently. This includes modelling issues, mesh density, etc. as well as treatment of lower level members, connection area, stability requirements etc. In general the following criteria and considerations are included in the proposal:

Linear elastic stress analysis (beam or FE analysis):

- Web plates and flange elements in compression and shear to fulfil relevant buckling criteria
- Effective shear stress in member web plates to be less than  $\sigma_y/\sqrt{3}$
- von Mises stresses in member flanges to be less than  $1.15 \times \sigma_y$ . (assuming party fixed boundary conditions)

Non-linear stress analysis:

- The analysis shall reliably capture buckling and plastic deformation of the structure
- Detailed acceptance criteria to be decided by each member society. The acceptance criteria shall ensure a suitable margin against fracture and major buckling and yielding causing significant loss of stiffness.
- Permanent lateral and out-of plane deformation of considered member should be minor relative to the relevant structural dimensions.

The von Mises acceptance criteria for linear analysis have been discussed back and forth within the group, and it is acknowledged that throughout validation of different grillage configurations has not been carried out. Based on the discussion above, it was however from the beginning the clear opinion of the group that the acceptance criteria should incorporate a moderate degree of plasticity in the members, which means that nominal elastic normal stresses may exceed yield.

The structural capacity of the grillage depends largely on the actual structural configuration and dimensions. From the validation work carried out as part of this revision, a series of relevant grillage configurations were considered. However, the typical governing failure modes for these structures are related to shear yield and buckling stability, which means that the bending failure mode becomes less relevant.

In Figure 5, examples of relative load-deflection curves for two typical continuous girders being part of a grillage system are shown. The girder denoted T-profile consists of a plate flange and a stiffener flange, while the I-profile represents a double hull member consisting of two (inner and outer shell) plate flanges. Both the load and deflections are normalized with regard to first yield in the member flange(s). From the analyses, it is evident that the members can carry significantly larger loads than the level initiating first yield in the member without experiencing large permanent deformations, and based on an overall evaluation, a factor of 1.15 is proposed and found to be reasonable taking into account the combined ability to develop plastic moment and redistribution of stresses, in combination with a moderate fixation against rotations at the member supports. The alignment of acceptance criteria for different analysis methods should preferably be part of a detailed procedure which should be developed for direct calculations.

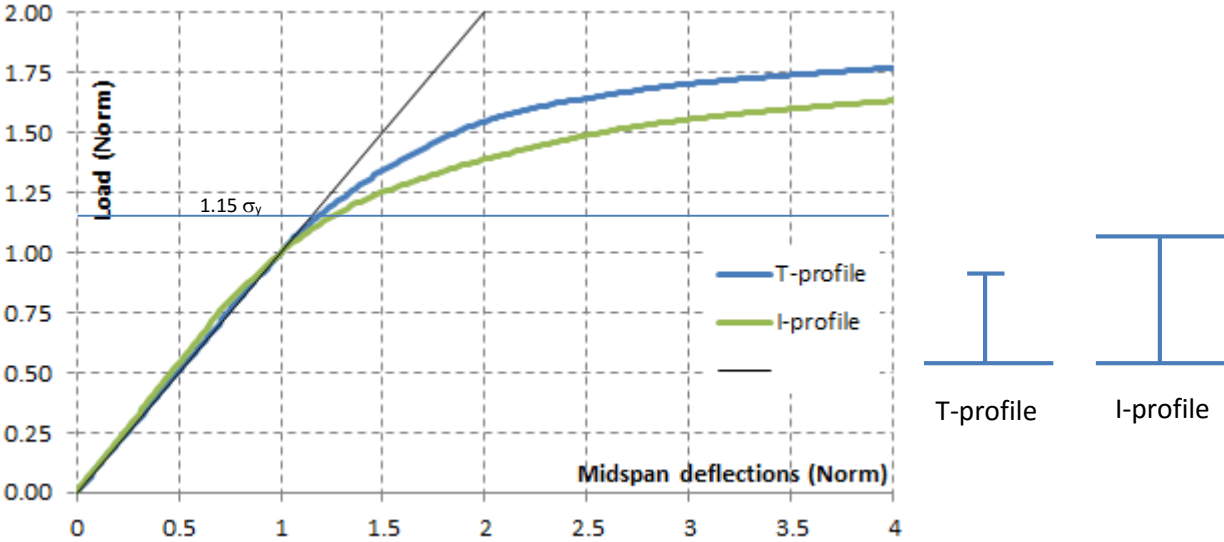


Figure 5 Typical load deflection curves for typical girder members being part of a grillage system

### Editorial amendments of rule text

General editorial amendments have been proposed and the rule text has been updated accordingly. The rationale for the amendments is mainly to ease readability and to avoid misunderstandings.

Some items are found to be inconsistent or superfluous, and have consequently been removed from the proposal. This applies among others to Paragraph I2.12.5, including the table for steel grades for inboard members attached to weather exposed plating, which is found to be inconsistent with the material classes described in I2.12.2.

From the hull panel hearing process, it was observed that there was some confusion regarding the existing framing requirements for bottom structures. Hence, the text is updated to clarify the intention of the rules. When calculating the minimum shear and section modulus requirements for the bottom structure, the requirements in I2.6 should be applied irrespective of the actual framing direction. In the bottom is it considered reasonable to assume that the ice patch orientation relative to the frame direction is random, and hence it is not relevant to distinguish between the transverse and longitudinal frame configurations. In lack of a specific scenario-based formulation for the bottom structure, an ice load patch applied in a direction normal to the frame direction is considered reasonable.

The patch load application on transversely and longitudinally framed bottom structures are given in Figure 6 and Figure 7, respectively. Please note that the same philosophy applies for the plate thickness requirements

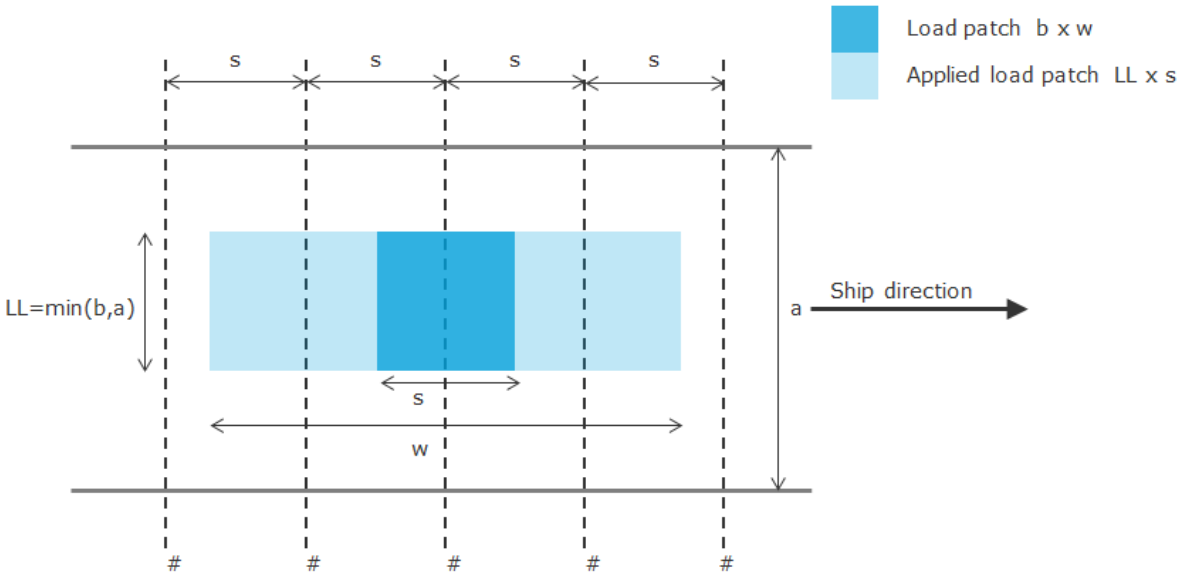


Figure 6 Application of ice load patch on transversely framed bottom structure according to paragraph I2.6

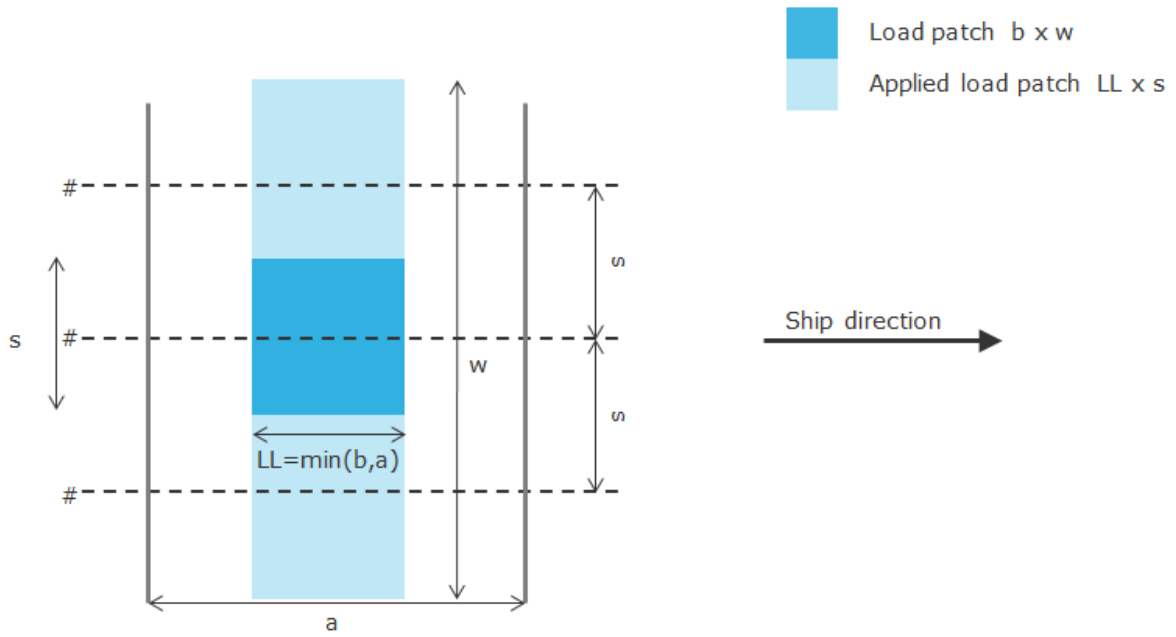


Figure 7 Application of ice load patch on longitudinally framed bottom structure according to paragraph I2.6

Other amendments include:

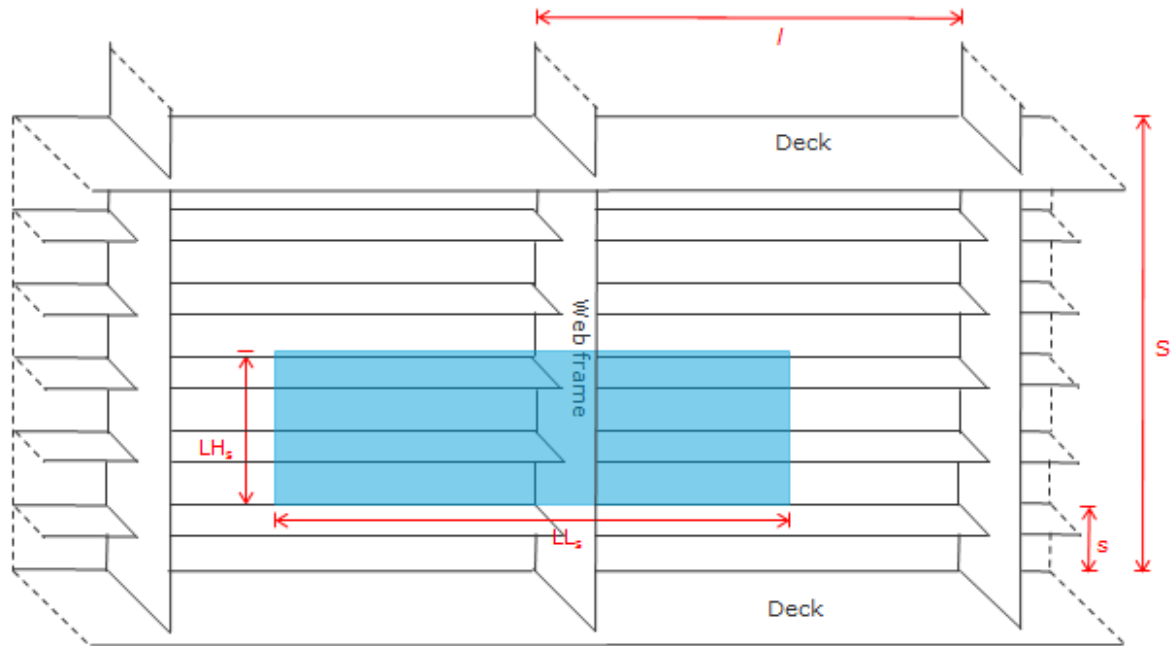
- The PPF for bottom framing should not be independent of patch area or structural dimensions. Consequently the peak pressure factor has been set to 1.0.
- The equation numbers have been removed as it is found that only a few are referred to in the text. Reference to paragraph numbers has been included as relevant.

## Appendix A

### Analytical formulations for web frames and stringers

#### Shear area requirements for simple web frames supporting longitudinal local frames

The general design load case for evaluating the shear strength of a simple web frame supporting longitudinal local frames is suggested to be as shown in Figure 1.



**Figure 1 – Proposed design condition for the shear area requirement for simple web frames supporting longitudinal local frames**

The effective shear area requirement for this condition is suggested to be as follows:

$$A_{wf} = \frac{100^2 (AF PPF_s P_{avg}) LH_s LL_s K_s}{0.577 \sigma_F \eta \sin \phi_w}$$

$A_{wf}$  = Effective net web area of web frame supporting longitudinal local frames [cm<sup>2</sup>]

AF = Hull Area factor from Table 3

PPF<sub>s</sub> = Peak Pressure Factor from Table 2

P<sub>avg</sub> = Average pressure within load patch according to Equation 15 [MPa]

LH<sub>s</sub> = effective load height with respect to shear response of web frame [m]

$$= \min(b, (S - s))$$



- b = Height of design ice load patch from Equation 12 or 14 [m]
- S = Design span of considered web frame with regard to shear response [m]
- s = Spacing of longitudinal frames [m]
- LL<sub>s</sub> = effective load length with respect to shear response of web frame [m]
- $$= w \frac{\left(l - \frac{w}{4}\right)}{l}$$
- w = Width of design load patch from Equation 11 or 13 [m], but is not to be taken larger than 2 l
- l = Spacing of web frames [m], measured along the shell plate
- K<sub>s</sub> = shear force factor [-]
- $$= \frac{S-h}{S}, \text{ minimum } 0.55$$
- h =  $\frac{LH_s + s}{2}$  [m], if one of the web frame supports lies within considered hull area
- $$= \frac{LH_s}{2} + h_1$$
- [m], if both of the web frame supports lies outside considered hull area
- h<sub>1</sub> = Smallest distance from web frame support to hull area boundary
- η = usage factor = 1.0
- φ<sub>w</sub> = smallest angle between shell plate and the web of the web frame, measured at middle of span [deg]. The angle φ<sub>w</sub> may be taken as 90 degrees provided the smallest angle is not less than 75 degrees.

In the proposal presented above, it is assumed that a portion of the design patch, as defined in the Rules by the height b and length w, is transferred directly to the structure supporting the web frame (e.g. a deck) and/or carried by the longitudinal local frames to the adjacent web frames. The magnitude of the force transferred to adjacent structure depends on the size of the patch load relative to the distance to the adjacent members. The effective patch area of the load carried by the considered web frame is defined by the height LH<sub>s</sub> and length LL<sub>s</sub>.

The effective patch load height LH<sub>s</sub> is generally taken as the general height b, as defined in the Rules, but limited by the span of the web frame.

The load length LL<sub>s</sub> is based on the assumption that part of the loading is carried by the longitudinals directly to the adjacent web frames. If the patch length w is equal to the web frame spacing S, it is assumed that 75% is taken by the considered frame, and the remaining 25% is taken by the adjacent frames. If the patch length w is more than twice the web frame spacing S, the effective patch length is limited by the web frame spacing.

For the shear factor K<sub>s</sub>, it is assumed that the edge of the patch load is placed a distance equal to the frame spacing from one of the supports. The shear factor represents the portion of the load taken as shear in the most loaded support assuming that both supports have the same boundary conditions. A

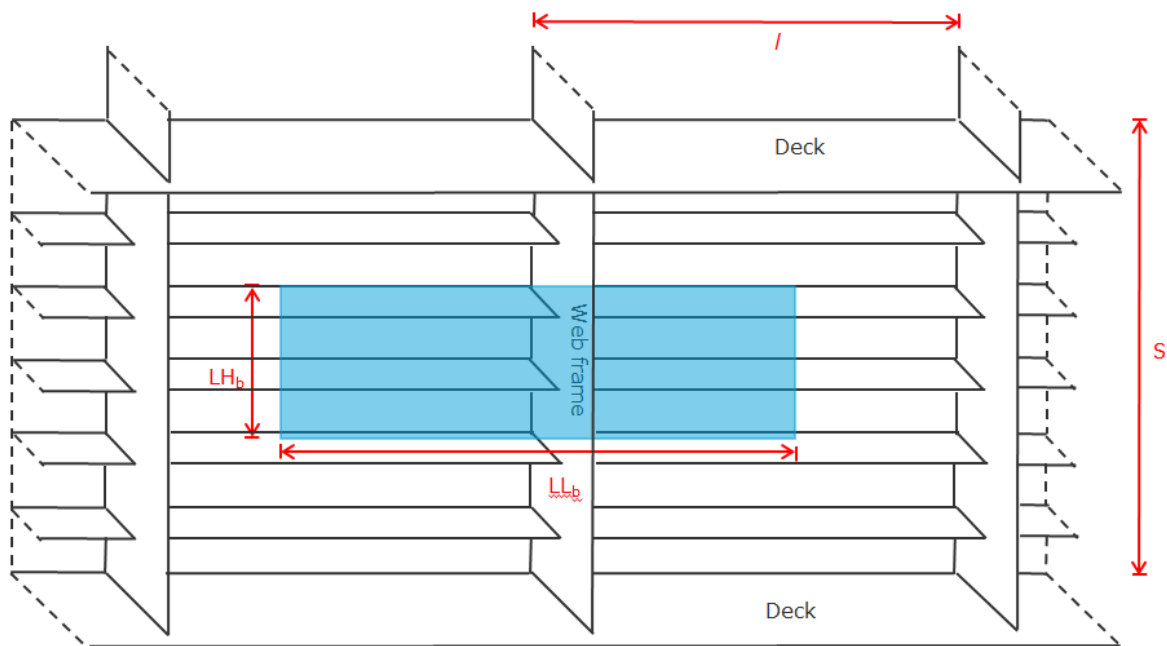
correction is included to cover the case where the web frame spans over the whole considered hull area, i.e. it is assumed that the patch load is placed at the boundary of the hull area.

The formula assumes shear yield over the whole effective height of the web plate.

It is suggested that the general usage factor is taken as 1.0.

### Section modulus requirements for simple web frames supporting longitudinal local frames

The general design load case for evaluating the bending strength of a simple web frame supporting longitudinal local frames is suggested to be as shown in Figure 2.



**Figure 2 – Proposed design condition for the section modulus requirement for simple web frames supporting longitudinal local frames**

The net elastic section modulus of the web frame is suggested to be as follows:

$$Z_{wf} = \frac{100^3 (AF PPF_s P_{avg}) LH_b LL_b \left( S - \frac{LH_b}{2} \right)}{4 \sigma_F \sin \varphi_w k_f}$$

$A_{wf}$  = Net elastic section modulus of web frame supporting longitudinal local frames [cm<sup>3</sup>]

$LH_b$  = effective load height with respect to bending response of web frame [m]

$$= \min(b, S)$$

$LL_b$  = effective load length with respect to bending response of web frame [m]

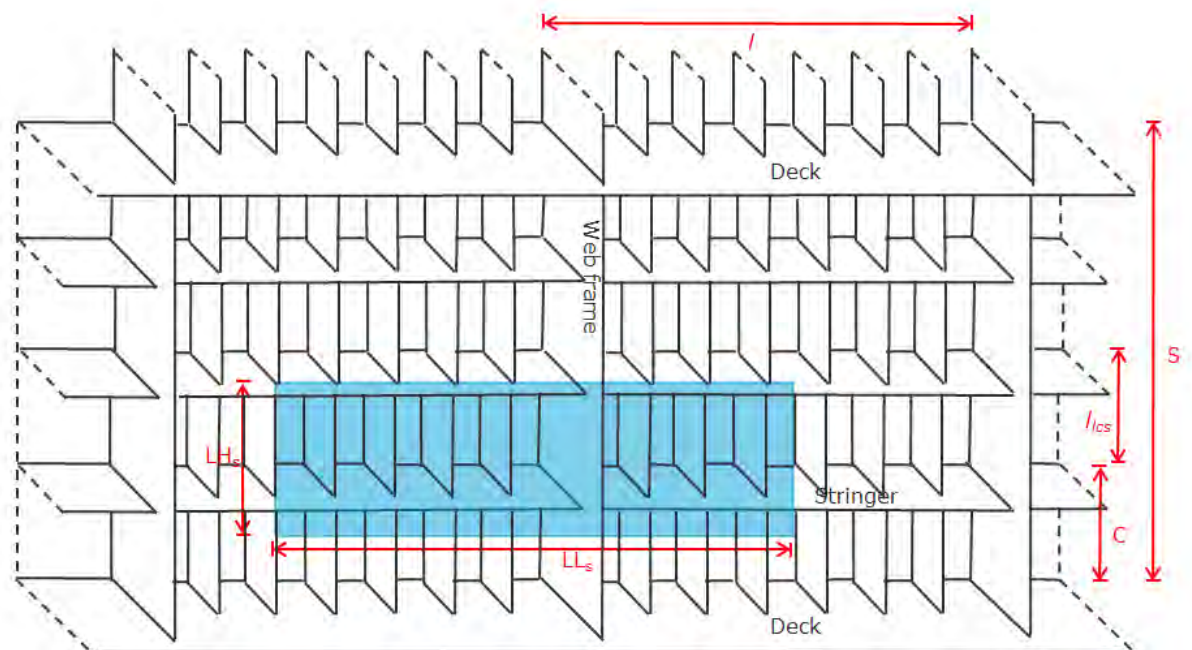
$$= w \frac{\left( l - \frac{w}{4} \right)}{l}$$

- $k_f$  = end fixity parameter for the web frame [-]
- = 2.0 when both end supports are fixed
- = 1.5 when one end support is fixed
- = 1.0 when both end supports are simply supported

The section modulus requirement is derived based on a semi-plastic approach, where the plastic moment obtained from a simple plastic 3-hinge mechanism (in case of restrained ends) is used as basis for determining the capacity of the member. The capacity is however evaluated against the elastic section modulus of the profile. Using the plastic bending moment as basis for the capacity assessment will for the clamped end case increase the defined capacity by 33% compared with a pure elastic approach based on first yield.

### Shear area requirement for simple web frames supporting load carrying stringers

The general design load case for evaluating the shear strength of a simple web frame supporting load carrying stringers is suggested to be as shown in Figure 3.



**Figure 3 – Proposed design condition for the shear area requirement for simple web frames supporting load carrying stringers**

The effective shear area requirement for this condition is suggested to be as follows:

$$A_{wf} = \frac{100^2 (AF PPF_s P_{avg}) LL_s LH_s K_s}{0.577 \sigma_F \eta \sin \phi_w}$$

$A_{wf}$  = Effective net web area of web frame supporting load carrying stringers [cm<sup>2</sup>]

$LH_s$  = load height with respect to shear response of web frame [m]

$$= b \left( \frac{l - \frac{b}{4}}{l} \right)$$

$LL_s$  = load length with respect to shear response of web frame [m]

$$= w \frac{(l_{LCS} - \frac{w}{4})}{l_{LCS}}$$

$l$  = Spacing of web frames [m], measured along the shell plate

$l_{LCS}$  = Distance to adjacent load carrying stringer or longitudinal support member, as applicable, [m], measured along the shell plate

$K_s$  = shear force factor [-]

$$= \frac{S - C}{S}$$

$\eta$  = usage factor

$\varphi_w$  = smallest angle between shell plate and the web of the web frame

In the proposal presented above, it is assumed that the design patch is located at a stringer level, and is acting as a point load on the web frame. As for the requirement for web frames supporting longitudinal local frames, a portion of the design load is assumed carried by the adjacent members, and hence the design patch on the web frame is defined by the effective height  $LH_s$  and length  $LL_s$ .

Similarly is the shear factor  $K_s$  taking into account the position of the considered load carrying stringer relative to the web frame supports.

Depending on the framing arrangement, several load carrying stringers along the web frame span should be considered.

It is suggested that the general usage factor is taken as 1.0

### **Section modulus requirement for simple web frames supporting load carrying stringers**

The general design load case for evaluating the bending strength of a simple web frame supporting load carrying stringers is considered to be the same as for the shear strength requirement, see Figure 3.

The net elastic section modulus of the web frame is suggested to be as follows:

$$Z_{wf} = \frac{100^3 (AF PPF_s P_{avg}) LL_s LH_s C (S - C)}{2 \sigma_F \sin \varphi_w k_f S}$$

$LH_b$  = load height with respect to bending response of web frame [m]

$$= b \left( \frac{l - \frac{b}{4}}{l} \right)$$

LL<sub>b</sub> = load length with respect to bending response of web frame [m]

$$= w \frac{\left( l_{LCS} - \frac{w}{4} \right)}{l_{LCS}}$$

C = Smallest distance from considered load carrying stringer to web frame support [m]

kf = end fixity parameter for the web frame [-]

= 2.0 when both end supports are fixed

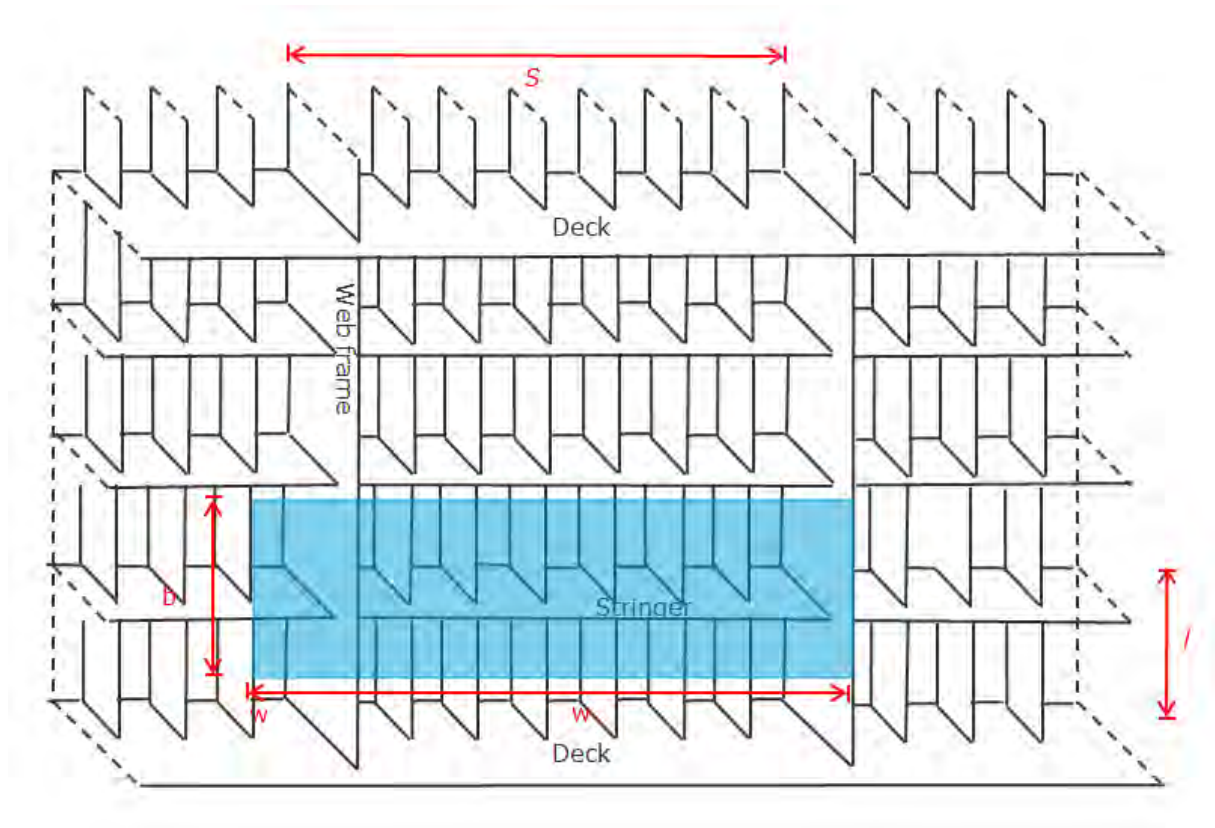
= 1.5 when one end support is fixed

= 1.0 when both end supports are simply supported

As for the shear area requirement, the section modulus requirement assumes that the patch load is represented as a point load at the stringer location. The same effective patch load is considered as well. The formulation is based on the plastic capacity of the member, but evaluated against the elastic section modulus.

### **Shear area requirement for load carrying stringers**

The general design load case for evaluating the shear strength of a simple load carrying stringer is suggested to be as shown in Figure 4.



**Figure 4 – Proposed design condition for the shear area requirement for load carrying stringers**

The effective shear area requirement for this condition is suggested to be as follows:

$$A_{lcs} = \frac{100^2 (AF PPF_s P_{avg}) LH_s LL_s K_s}{0.577 \sigma_F \eta \sin \phi_w}$$

$LH_s$  = effective load height with respect to shear response of stringer [m]

$$= b \frac{(l - \frac{b}{4})}{l}$$

$LL_s$  = effective load length with respect to shear response of stringer [m]

$$= \min(w, (S - s))$$

$K_s$  = shear force factor [-]

$$= 0.5 \text{ if } w \geq S$$

$$= \frac{S - \frac{LL_s + s}{2}}{S}$$

$\eta$  = usage factor = 1.0

$\phi_w$  = smallest angle between shell plate and the web of the web frame

### Section modulus requirement for simple load carrying stringers

The general design load case for evaluating the bending strength of a load carrying stringer is considered to be the same as for the shear strength requirement, see Figure 4.

The net elastic section modulus of the load carrying stringer is suggested to be as follows:

$$Z_{lcs} = \frac{100^3 (AF PPF_s P_{avg}) LH_b LL_b \left(S - \frac{W}{2}\right)}{4 \sigma_F \sin \varphi_w k_f}$$

$LH_b$  = effective load height with respect to bending response of stringer [m]

$$= b \frac{\left(l - \frac{b}{4}\right)}{l}$$

$LL_b$  = effective load length with respect to bending response of web frame [m]

$$= \min(w, S)$$

$k_f$  = end fixity parameter for load carrying stringer

= 2.0 when both end supports are fixed

= 1.5 when one end support is fixed

= 1.0 when both end supports are simply supported

$\varphi_w$  = smallest angle between shell plate and the web of the web frame

## Appendix B

### Derivation of the oblique collision force with a vertical bows

The force is found by equating the normal kinetic energy with the ice crushing energy,

$$KE_n = E_{crush} \quad (a1)$$

The crushing energy is found by integrating the normal force over the penetration depth

$$E_{crush} = \int_0^{\delta} F_n(\delta) d\delta \quad (a2)$$

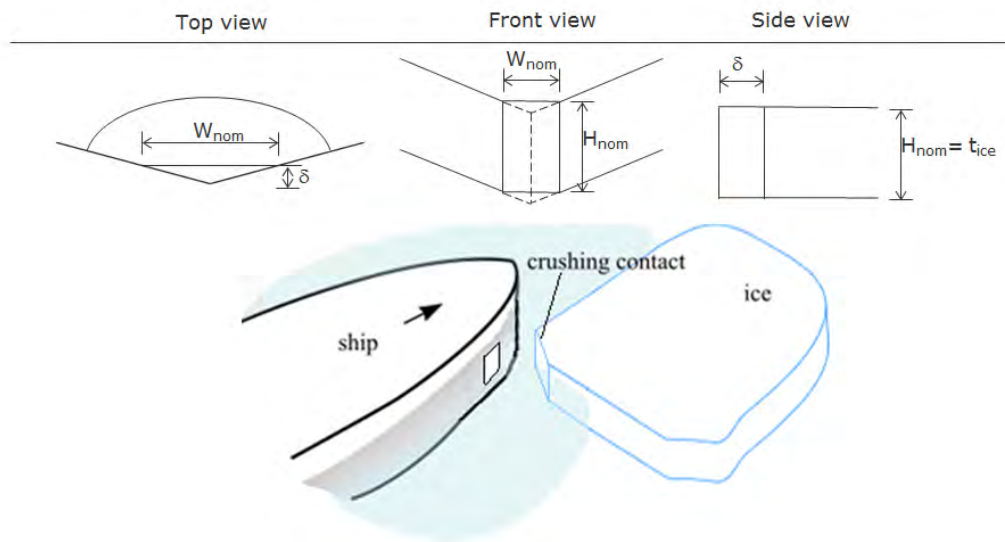
The normal kinetic energy combines the normal velocity with the effective mass at the collision point

$$KE_n = \frac{1}{2} M_e \cdot V_n^2 \quad (a3)$$

Combining the two terms gives

$$\frac{1}{2} M_e \cdot V_n^2 = \int_0^{\delta_m} F_n(\delta) d\delta \quad (a4)$$

The ice penetration geometry together with the pressure-area relationship is the basis of finding the force. The nominal area is found for a penetration  $\delta$



The nominal contact area is

$$A = W_{nom} \cdot H_{nom} \quad (a5)$$



The width of the  $W_{nom}$  of the nominal contact area can be determined by the nominal penetration depth  $\delta$  and the ice edge angle  $\phi$ .

$$\tan \frac{\phi}{2} = \frac{W_{nom}}{2\delta}$$

$$W_{nom} = 2\delta \cdot \tan \frac{\phi}{2} \quad (\text{a6})$$

The height  $H_{nom}$  of the nominal contact area is fixed by the design ice thickness for each polar class

$$H_{nom} = h_{ice} \quad (\text{a7})$$

Hence the area is

$$A = W_{nom} \cdot H_{nom} = 2h_{ice}\delta \cdot \tan \frac{\phi}{2} \quad (\text{a8})$$

The average pressure is found from the pressure area relationship

$$P = P_0 \cdot A^{ex} \quad (\text{a9})$$

The nominal force is

$$F_n(\delta) = P \cdot A = P_0 \cdot A^{1+ex} \quad (\text{a10})$$

Substituting the expression for area (4) gives

$$F_n(\delta) = P_0 \left( 2h_{ice}\delta \cdot \tan \left( \frac{\phi}{2} \right) \right)^{1+ex} \quad (\text{a11})$$

$$F_n(\delta) = C \cdot P_0 \cdot \delta^{1+ex} \cdot h^{1+ex} \quad (\text{a12})$$

where we collect known quantities into the factor C

$$C = \left( 2 \cdot \tan \left( \frac{\phi}{2} \right) \right)^{1+ex} \quad (\text{a13})$$

We can now solve the energy balance equation ((a12) into (a4)) to find the maximum penetration

$$\frac{1}{2} M_e \cdot V_n^2 = C \cdot P_0 \cdot h^{1+ex} \cdot \int_0^{\delta_m} \delta^{1+ex} d\delta \quad (\text{a14})$$

Accordingly we can extract the maximum penetration

$$\frac{1}{2} M_e \cdot V_n^2 = C \cdot P_0 \cdot h^{1+ex} \cdot \left| \frac{\delta_m^{2+ex}}{2+ex} \right|_0^{\delta_m}$$

$$\frac{1}{2} M_e \cdot V_n^2 = C \cdot P_0 \cdot h^{1+ex} \cdot \frac{\delta_m^{2+ex}}{2+ex}$$

$$\delta_m = \left( \frac{(2+ex) \cdot \frac{1}{2} M_e \cdot V_n^2}{C \cdot P_0 \cdot h^{1+ex}} \right)^{\frac{1}{2+ex}} \quad (\text{a15})$$

This is substituted into the expression for force (a12), to give

$$F_n = C \cdot P_0 \cdot h^{1+ex} \cdot \left( \frac{(2+ex) \cdot \frac{1}{2} M_e \cdot V_n^2}{C \cdot P_0 \cdot h^{1+ex}} \right)^{\frac{1+ex}{2+ex}} \quad (a16)$$

This can be substituted to give

$$F_n = C^{\frac{1}{2+ex}} \cdot P_0^{\frac{1}{2+ex}} \cdot \left( (2+ex) \cdot \frac{1}{2} M_e \cdot V_n^2 \cdot h_{ice} \right)^{\frac{1+ex}{2+ex}} \quad (a17)$$

Substituting for  $M_e$  and  $V_n$ , we get

$$F_n = C^{\frac{1}{2+ex}} \cdot P_0^{\frac{1}{2+ex}} \cdot \left( \frac{l^2}{2C_0} \right)^{\frac{1+ex}{2+ex}} \cdot \left( (2+ex) \cdot M_{ship} \cdot V_{ship}^2 \cdot h_{ice} \right)^{\frac{1+ex}{2+ex}} \quad (a18)$$

We can collect all shape related terms (comprising C and the terms with  $C_0$  and  $l$ ) into a simple terms  $f_a$ ,

$$f_a = (2+ex)^{\frac{1+ex}{2+ex}} \cdot \left( 2 \tan \frac{\varphi}{2} \right)^{\frac{1+ex}{2+ex}} \cdot \left( \frac{l^2}{2C_0} \right)^{\frac{1+ex}{2+ex}} \quad (a19)$$

With  $f_a$ , we can write the force equation as

$$F_n = f_a \cdot P_0^{\frac{1}{2+ex}} \cdot V_{ship}^{\frac{2+2 \cdot ex}{2+ex}} \cdot M_{ship}^{\frac{1+ex}{2+ex}} \cdot h_{ice}^{\frac{1+ex}{2+ex}} \quad (a20)$$

Which for  $ex=-0.1$  gives

$$F_n = f_a \cdot P_0^{0.526} \cdot V_{ship}^{0.947} \cdot M_{ship}^{0.474} \cdot h_{ice}^{0.474} \quad (a21)$$

This value of  $f_a$  collects all form related terms (and constants) into a single factor for crushing. Equation (a21) represents only the crushing force. However the flexural design force need not be included in the design force of a blunt bow.

The ice load patch is found from  $F_n$ . Using (a20) and (a10), we can solve for the nominal contact area,

$$A = \left( \frac{F_n}{P_0} \right)^{\frac{1}{1+ex}} \quad (a22)$$

Unlike the case for an icebreaking bow form, there is no need to introduce a change in load patch shape (it is already rectangular). Accordingly, the aspect ratio is

$$AR = \frac{W_{nom}}{H_{nom}} = \frac{W_{nom}}{h_{ice}} \quad (a23)$$

$$A = h_{ice}^2 \cdot AR \quad (a24)$$

Therefore, we can write

$$H_{nom} = h_{ice} \quad (a25)$$

And from (a8) and (a22)

$$W_{nom} = \frac{\left(\frac{F_n}{P_o}\right)^{\frac{1}{1+ex}}}{h_{ice}} \quad (a26)$$

At this point we introduce a reduction in the size of the load patch (force is unchanged, so design pressure rises, correspondingly). This reduction is conservative and is done to account for the typical concentration of force that takes place as ice edges spall off. The rule (or design) patch length is

$$w = W_{nom}^{wex} = \left(\frac{F_n}{P_o}\right)^{\frac{wex}{1+ex}} \cdot h_{ice}^{-wex} \quad (a27)$$

Where with  $wex = 0.7$ , we have

$$w = F_n^{0.778} \cdot P_o^{-0.778} \cdot h_{ice}^{-0.7} \quad (a28)$$

The design load height is

$$b = \frac{w}{AR} \quad (a29)$$

Using (a23) and (a26)

$$b = F_n^{-0.333} \cdot P_o^{0.333} \cdot h_{ice}^{1.3} \quad (a30)$$

The nominal and design load patches have the same aspect ratio. The load quantities used in the scantling calculations include the line load,

$$Q = \frac{F_n}{w} \quad (a31)$$

And the pressure

$$P = \frac{Q}{b} \quad (a32)$$

Solving for Q and P

$$Q = \frac{F_n}{w} = \frac{F_n}{F_n^{0.778} \cdot P_o^{-0.778} \cdot h_{ice}^{-0.7}} \quad (a33)$$

$$P = \frac{Q}{b} = \frac{F_n^{0.222} \cdot P_o^{0.778} \cdot h_{ice}^{0.7}}{F_n^{-0.333} \cdot P_o^{0.333} \cdot h_{ice}^{1.3}} \quad (a34)$$

For the rule formula

$$Q = F_n^{0.222} \cdot P_o^{0.778} \cdot h_{ice}^{0.7} \quad (a35)$$

$$P = F_n^{0.555} \cdot P_o^{0.445} \cdot h_{ice}^{-0.6} \quad (a36)$$

The design force given in (a21) may be expressed as follows in terms of class-dependent ship and ice class factors

$$F_n = f_a \cdot CF_{CV} \cdot \Delta_{ship}^{0.474}$$

Where

$$CF_{CV} = P_0^{0.526} \cdot V_{ship}^{0.947} \cdot h_{ice}^{0.474}$$

The class factor  $CF_{CV}$  may be given as follows for the different ice classes:

Ice class	$CF_{CV}$
PC6	3.43
PC7	2.60

### Shape factor

From (a19) the shape factor can be written as

$$f_a = \left( 1.90 \cdot \frac{l^2}{c_0} \cdot \tan \frac{\varphi}{2} \right)^{0.474}$$

Due to the complexity of  $C_0$ , the following simplified equation is suggested

$$f_a = \frac{\alpha}{30}$$

## Machinery Requirements for Polar Class Ships

### Summary

In Rev.2 of this Resolution, comprehensive amendments, including introduction of requirements for icebreaker vessels, have been made.

### Part A. Revision History

Version no.	Approval date	Implementation date when applicable
Rev.2 (Jan 2023)	20 January 2023	1 July 2024
Corr.1 (Oct 2007)	Oct 2007	-
Rev.1 (Jan 2007)	Jan 2007	1 March 2008
New (Aug 2006)	Aug 2006	1 July 2007

#### • Rev.2 (Jan 2023)

##### 1 Origin of Change:

- Suggestion by IACS member

##### 2 Main Reason for Change:

- General Update of this UR

Rev.1 of UR I3 (including Corr.1) contained a number of reserved paragraphs and two different versions of blade fatigue assessment methods. This prevents a clear and unambiguous interpretation of I3, yielding different results for the same case. This was resolved in a first step.

The main technical reason for the additional review and amendment was an insufficient validation of rule requirements/calculations and reserved paragraphs, which contradict a smooth application of I3. Additionally, a need for simple formula and some amendments resulting from an Industry Hearing in 2007 was noticed.

- Introduction of Requirements for Icebreaker Vessels

It was found that UR I1 and I2 contained requirements for icebreaker vessels, whereas UR I3 did not. In order to obtain a complete rule set for icebreaker vessels it was decided that the UR I3 draft would be extended to also include icebreaker requirements.

### **3 List of non-IACS Member classification societies contributing or participating in IACS Working Group:**

- General Update of this UR

None.

- Introduction of Requirements for Icebreaker Vessels

None.

### **4 History of Decisions Made:**

- General Update of this UR

Members' practices and experiences on Polar/Ice Class ships have been reflected, taking into account inputs from two experts from VTT as representative of TRAFI and the result of Industry Hearing (held in 2007 and 2014).

- Introduction of Requirements for Icebreaker Vessels

The following sub-tasks have been addressed.

- a) Re-analyse existing full-scale measurements (as far as available/accessible) and derive/adapt load formulae for Icebreakers, duly covering off-design load cases as well.

It was quickly discovered that measurement results from icebreakers are no longer available for analysis. As a consequence of this, estimation of load levels has been based on information given in earlier TB documents,

- b) Review icebreaker requirements of IACS members and other sources, TB notes and early I3 proposals in order to find ice breaker equivalent load formulae.

Earlier TB notes and individual Societies' class rules have been looked into and used in the PT's work. Earlier TB notes formed the basis for load increase for icebreakers, as measurements used to obtain blade loads for merchant vessels originally were done on icebreakers, and then scaled down to match merchant vessel load levels.

- c) Further develop UR I3 to include paragraphs for Icebreaker load calculation, additional load cases and further requirements, specific for Icebreakers.

Based on earlier TB notes, blade loads for icebreakers have been included. Further, the amount of load cycles for fatigue evaluation has been increased, and the wording on steering systems has been revised. Details can be found in TB notes in Annex 1 to this document.

## 5 Other Resolutions Changes:

- General Update of this UR

None.

- Introduction of Requirements for Icebreaker Vessels

None.

## 6 Any hinderance to MASS, including any other new technologies:

None.

## 7 Dates:

Original Proposal	: 23 November 2011	(Ref: PM11914_IMa)
Panel Approval	: 02 December 2022	(Ref: PM11914aIMzi)
GPG Approval	: 20 January 2023	(Ref: 11166_IGm)

- **Corr.1 (Oct 2007)**

No records are available.

- **Rev.1 (Jan 2007)**

No records are available.

- **New (Aug 2006)**

Refer to Part B Annex 1 for TB file.

## **Part B. Technical Background**

List of Technical Background (TB) documents for UR I3:

Annex 1. **TB for New (Aug 2006)**

See separate TB document in Annex 1.

Annex 2. **TB for Rev.2 (Jan 2023)**

See separate TB document in Annex 1.

*Note: There are no separate Technical Background (TB) documents available for Rev.1 (Jan 2007) and Corr.1 (Oct 2007).*



TB for UR I3  
(August 2006)

1. Background Notes - Propeller Ice Loads (16 pages)
2. Background Notes - Machinery Fastening Loading Accelerations (10 pages)
3. Background Notes - Blade design (11 pages)

**IACS Unified Requirements for Polar Ships**  
**Background Notes to**

***“Propeller Ice Interaction Loads”***

by Robin Browne and Lasse Norhamo

**IACS UR I3**  
**Technical Background**  
**Propeller Ice Interaction Loads**

---

**PROPELLER ICE INTERACTION LOADS**

**1 SCOPE AND OBJECTIVES**

The propeller design ice loads given in I3(Section I3.4 of the Machinery Requirements for Polar Ship), are the result of extensive research and development by circumpolar nations over the past 25 years. The R&D has included analysis of service history of propeller damages, propeller and shaft load measurements on full scale trials, laboratory investigations and numerical simulation of propeller and ice interaction.

The decision was taken at the start of the project that the most modern ice interaction models and information would be used in the process of developing new regulations and to be consistent with the FMA requirements

The manner, in which the Requirements have been developed from this material, and their detailed explanation, is given below in Section 3.

**2. BACKGROUND**

The mid 1970's to late 1980's was a time of great activity in the Arctic Marine field in North America, Russia and Scandinavia, with a large number of new buildings of icebreakers and ice class cargo vessels and supply vessels. These supported the offshore oil drilling activity and mineral transport in the Canadian Arctic, transportation on the Russian Northern Sea Route and in the Baltic, and U.S. scientific and strategic interests in Antarctica and Alaska. Arctic Marine R&D, including studies of ice loading on propellers and machinery systems, grew in step with this commercial activity.

In North America, machinery ice loading studies generally took the form of data acquisition, and subsequent analysis, on full scale trials of the many new builds. Information recorded was generally shaft thrust and torque relative to ship and propeller operating conditions and the encountered ice conditions.

In Scandinavia, principally Finland, the objective was a more fundamental understanding of propeller ice loading, based on detailed trials of a few, generally small vessels. Blade ice loads were measured directly, underwater video was added to the recordings, and some long term trials were conducted. The blade load measurement technology was also transferred to Canada and Russia for two trials on the Canadian Arctic Supply Vessel "Robert Lemeur" and Russian Arctic Icebreaker "Arctika".

Russia carried out some shaft and blade load measurements. Moreover, with by far the largest Arctic fleet, Russia benefited from the statistical analysis of machinery performance and damages.

During this period, it became increasingly evident that existing machinery protection regulations were not adequate to the task, and had in many areas become irrelevant. For example, blade scantlings in the Baltic and Canadian rules were dependent upon a design ice torque, rather than a direct expression of the out-of-plane blade bending moment, which can cause major blade deformation and breakage.

Experienced designers and manufacturers were using their own improved understanding and practices, especially with regard to propeller design.

In Russia, the detailed analysis of blade failures on high ice class icebreakers led to greatly improved designs in stainless steel, with emphasis on material properties and quality of the castings.

At the end of the 1980's, both the Canadian and Baltic marine authorities had decided to update their respective machinery protection regulations. In order to share expertise and resources, a joint

**IACS UR I3**  
**Technical Background**  
**Propeller Ice Interaction Loads**

research project arrangement ( JRPA#6 ) on the important matter of blade design ice loads, was entered into between Canada and Finland.

Finland would develop a numerical simulation model of propeller and ice interaction during the ice milling operation, which would incorporate a Finnish model for contact load components and a Canadian model for non-contact load components. A number of associated research programmes provided additional information, such as ice properties at interaction velocities, and analysis of available full scale data.

The ice block impact condition on the back of a blade, such as occurs when a propeller is dragged through ice, can generate extreme loads. This condition is avoided by masters as imprudent operation, and is not a design condition.

The lack of directly measured blade loads on a large propeller in Arctic conditions also gave impetus to a joint Canadian-American project for propeller ice load trials on USCGC "Polar Star" in the early 1990's.

The JRPA#6 three-dimensional numerical simulation model was developed by the mid-1990's, and was used to determine parametric influences upon propeller and ice interaction loads. These loads applied to open propellers and included backward blade bending moment, blade spindle torque, propeller torque and shaft thrust.

Included in the load formulae was the parameter of blade attack angle. The exact value of this parameter is not known at the time of maximum load and it was therefore necessary to make a final calibration of the formulae using all available full scale data. A design interaction blade attack angle of + 4 degrees was adopted.

The dependencies in the load formulae, with some modifications based on Russian R&D results, find their way into the load formulae in the IACS unified design requirements.

The numerical simulation model did not address the ducted propeller directly, nor maximum forward blade loads. However, it was possible to determine working formulations based on available full scale data.

### **3. Points of Discussion**

#### **13.4.3 Design Ice Loads for Open Propeller**

##### **13.4.3.1 Maximum Backward Blade Force**

The formula for the maximum backward blade ice force on a propeller blade, derived from the JRPA#6 numerical simulation model, is given in Reference 8 as:

$$F_{bl} = -93.0 \times [\sigma \times EAR/Z]^{0.287} \times [H_i/D]^{1.36} \times e^{(-0.183\alpha)} \times (nD)^{0.712} \times D^{2.02} \quad \text{kN}$$

where:

D = propeller diameter in metres  
Z = number of blades  
EAR = expanded blade area ratio

**IACS UR I3**  
**Technical Background**  
**Propeller Ice Interaction Loads**

---

n	=	propeller rotational speed rps
H <sub>i</sub>	=	ice thickness in metres
α	=	apparent angle of attack
	=	φ- arctan ( V/(0.7πnD))
φ	=	pitch angle at 0.7R
σ	=	uniaxial unconfined compressive strength of ice in MPa

The blade force does not increase indefinitely, with increase in the ratio of ice thickness/propeller diameter. This is due to two factors:

- As ice thickness and block size and inertia increase, the interaction moves towards the infinite ice block case, and the loads move asymptotically to a limiting value.
- As ice thickness increases to be greater than blade length, the interaction geometry becomes more asymmetric, and the ice block tends to rotate on contact away from the blade, thereby releasing or limiting the load.

It was found that this limiting effect is as follows:

when  $H_i/D > 0.65$ , the value of  $H_i/D = 0.65$

This blade force is known from full scale observations and measurements [ 10, 12,13, 16 ] and laboratory tests [ 4 ], to be distributed radially in a strip close to the blade leading edge, with an equivalent point location for blade root stress calculation at 0.8R and approximately 0.2 of chord back from the leading edge.

This load formula was modified for use as a Regulatory model by the substitution of:

- H<sub>ice</sub> for H<sub>i</sub>. Each PC ice class has a design ice thickness, as given in the Regulation Table 3.1. These values are used for the appropriate class in the formula calculations.
- A coefficient S<sub>ice</sub> to account for the ice strength influence. The ice strength influence is an increase of approximately 20% in ice load for a doubling of ice strength, as would be the case in going from first year to multi-year ice. Full scale data in [15] support this. In Table 3.2, S<sub>ice</sub> is given as 1.2 for ice classes which may interact with multi-year ice. For ice classes PC5 to PC2 S<sub>ice</sub> has been selected as an intermediate value of 1.1 in order to adjust backward ice force F<sub>bl</sub> to full scale validation data.
- The use of a single decimal place in the exponent values for simplicity. Higher accuracy cannot be justified.
- The adoption of an angle of attack of + 4 degrees. The angle of attack at the time of maximum backward blade load is known to be small, but the exact value is not known. Its practical measurement is beyond current possibility. The value of + 4 degrees was selected as the value which brings the formula and full scale data into agreement. For fixed pitch propellers, maximum backward ice load does not occur at “heavy ice condition ship speeds”, because propeller speeds will be low, but in a condition of lower ice concentration/thickness where ship speed and propeller speed are higher. In this situation the propeller can hit a large ice block at a low attack angle and experience a large load. Therefore 0,85 of nominal speed has been selected for practical use.

As a result of the above measures, the formulae for maximum backward blade force in the regulation section I3.4.3.1 become:

$$D_{limit} = 0.85 \times (H_{ice})^{1.4}$$

When  $D < D_{limit}$

$$F_b = -27 \times S_{ice} \times (nD)^{0.7} \times [EAR/Z]^{0.3} \times D^2 \quad \text{kN}$$

When  $D > D_{limit}$

$$F_b = -23 \times S_{ice} \times (nD)^{0.7} \times [EAR/Z]^{0.3} \times (H_{ice})^{1.4} \times D \quad \text{kN}$$

# IACS UR I3

## Technical Background

### Propeller Ice Interaction Loads

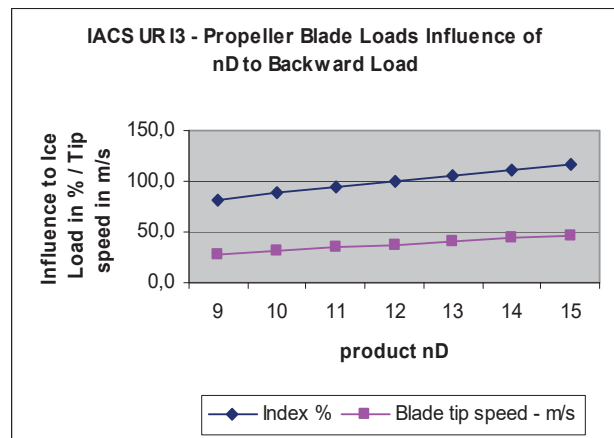
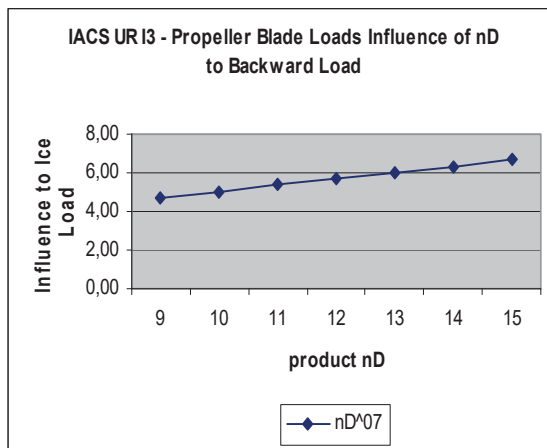
Ice Class	$H_{ice}$ [m]	$S_{ice}$ [-]	$S_{qice}$ [-]
PC1	4.0	1.2	1.15
PC2	3.5	1.1	1.15
PC3	3.0	1.1	1.15
PC4	2.5	1.1	1.15
PC5	2.0	1.1	1.15
PC6	1.75	1	1
PC7	1.5	1	1

$H_{ice}$  Ice thickness for machinery strength design

$S_{ice}$  Ice strength index for blade ice force

$S_{qice}$  Ice strength index for blade ice torque

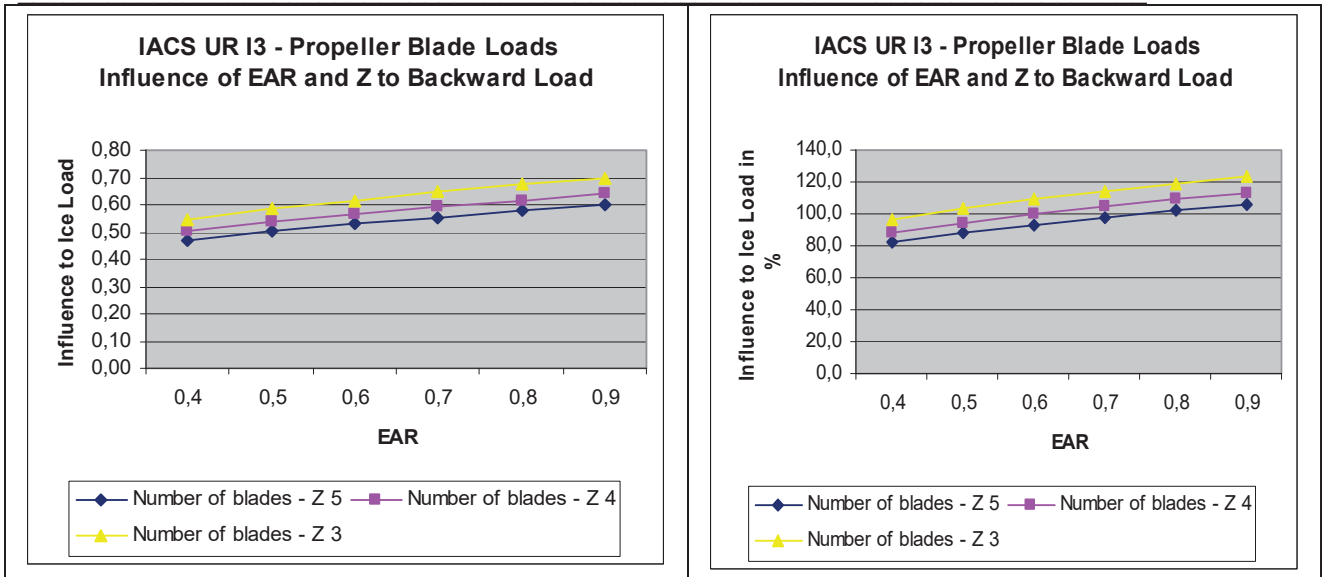
The most significant parameters are generally Ice Class, giving rise to  $H_{ice}$  and  $S_{ice}$ , and propeller diameter. The product  $nD$  normally varies little in practical designs (an upper limit normally exists for the avoidance of blade tip cavitation), and EAR/Z does not normally vary very much.



# IACS UR I3

## Technical Background

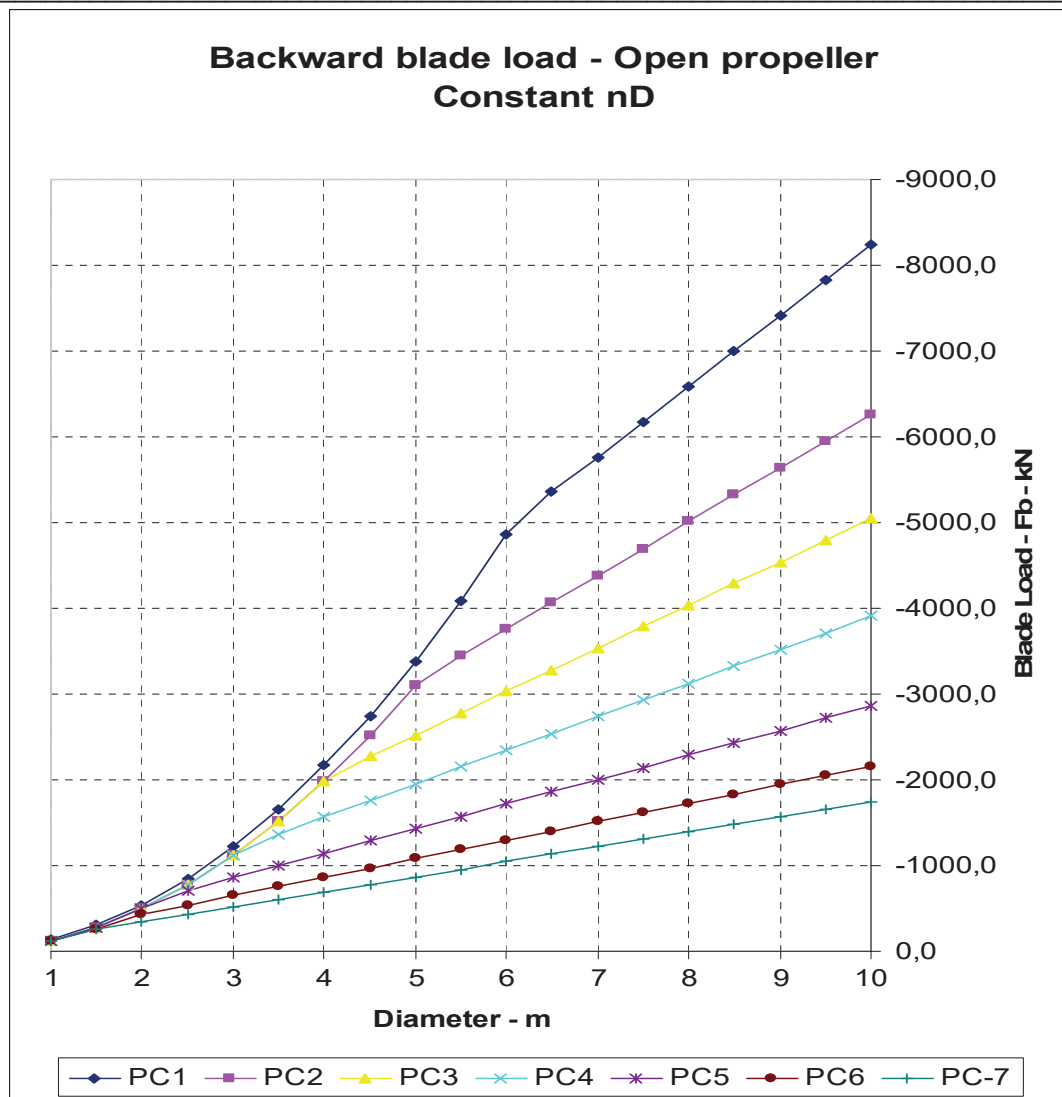
### Propeller Ice Interaction Loads



The above formulae show that for any given ice class, and accompanying design ice thickness, the design ice load for small propellers increases with the square of diameter, until  $D_{limit}$  is reached. Above  $D_{limit}$ , design ice load increases linearly with increase in diameter. Both statements are valid provided that  $nD$  is kept constant and  $EAR/Z$  is same.

The graphical presentation of the loads for PC1 to PC7,  $D = 1$  to  $8m$ ,  $nD = 12$ ,  $EAR = 0.7$  and  $Z=4$  is given below [ 16 ].

**IACS UR I3**  
**Technical Background**  
**Propeller Ice Interaction Loads**



The maximum directly measured blade loads for the vessels “Gudingen” - PC7 equivalent (PC6 questioned) – and “Polar Star” – PC3 equivalent demonstrate the overall validity of the load model in the proper manner. These ships are plotted in the next diagram, which was drawn before final adjustment of constants (10% reduction) and new  $S_{ice}$  values (1.1 instead of 1.2) for PC2 to PC5 and is therefore presented in purpose of entirety. These adjustments were considered reasonable based on validations carried out and acknowledging that the PC1 ice class is the only one intended “year round operation in all Polar areas”.

Shaft measured thrust loads on some icebreakers have also been corrected to propeller loads by taking shaft dynamics into account [15]. The resulting propeller loads, relative to propeller diameter and ice thickness are of the same order of magnitude as given in the above Regulatory Load Figure.

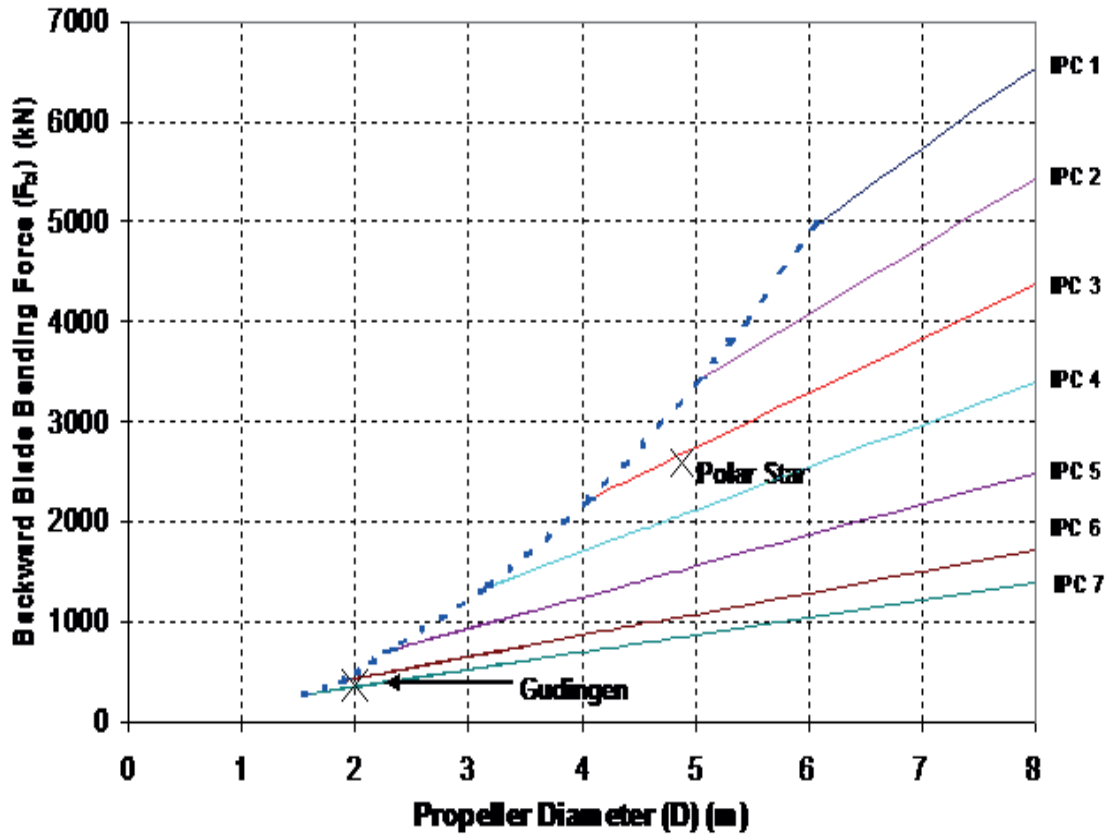
For blade scantlings design, the maximum backward blade load is to be applied as shown in the regulations Table 1, load case 1 for the full milling condition and Load case 2, the tip milling condition for skewed CP-propellers in particular. Although the blade load is not in practice of uniform intensity [4], this simplification over the specified area, has an equivalent effect.

Load case 5 in the same table is intended for blade trailing edge loading for reversible (rotational direction) propellers. This is developed based on observed ice damages (bent blade tips at trailing



**IACS UR I3**  
**Technical Background**  
**Propeller Ice Interaction Loads**

edge side) and shall take care of skewed blade form. Thus there is no need for any limitation of skew angle.



**13.43.2 Maximum Forward Blade Force**

The forward blade load on the open propeller is a non-contact load occurring due to the very close proximity of an ice block and propeller blade. These loads have been measured directly [9], but the exact mechanism of their generation and the shape of the load distribution on the blade are not fully understood. The formulae in regulation section 13.4.3.2, model the available full scale information.

$$D_{limit} = 2/[1-d/D] \times H_{ice} \text{ m}$$

When  $D < D_{limit}$

$$F_f = 250 \times [EAR/Z] \times D^2 \quad \text{kN}$$

When  $D > D_{limit}$

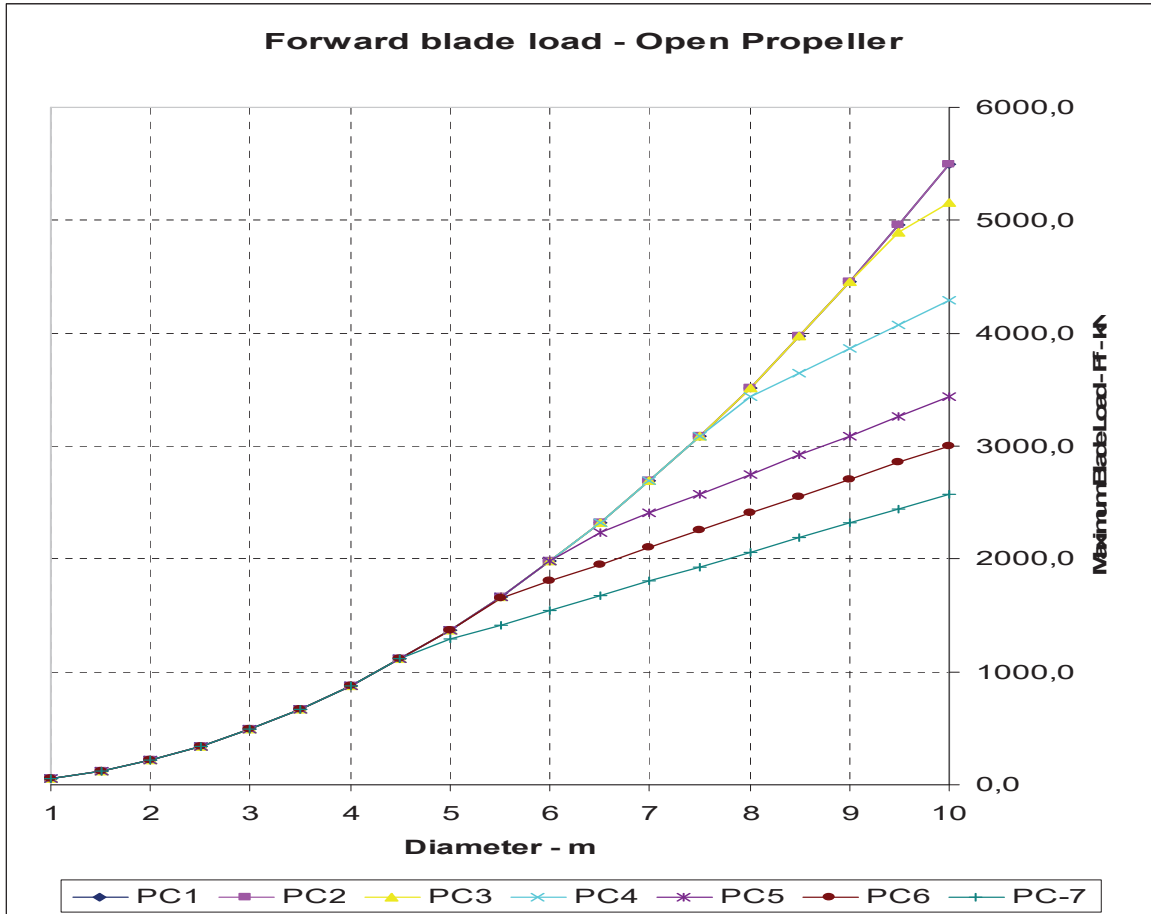
$$F_f = 500 \times (1/[1-d/D]) \times H_{ice} \times [EAR/Z] \times D \quad \text{kN}$$

At any given propeller diameter, the forward blade load increases with ice thickness, until ice thickness equals blade length and one whole blade at any time can be shielded by the ice block.

These loads are to be applied following the same scheme as for the full milling backward blade loads, except that the loads are applied to the face ( pressure ) side of the blade.

**IACS UR I3**  
**Technical Background**  
**Propeller Ice Interaction Loads**

The graphical presentation of the loads for PC1 to PC7, D = 1 to 10m, d/D = 0.36, nD = 12, EAR = 0.7 and Z=4 is given below.



**13.4.3.4 Maximum Propeller Ice Torque**

The formula for maximum propeller ice torque ( ice torque or polar moment applied to the shaft by the propeller at the propeller location ), derived from the JRPA#6 numerical simulation model, is given in Reference 8 as:

$$Q_{max} = 234 \times (1-d/D) \times \sigma^{0.195} \times (H_i/D)^{1.07} \times (-0.902 \times J^2 + J + 0.438) \times (P/D)^{0.162} \times (t/D)^{0.605} \times (nD)^{0.173} \times D^{3.04} \quad \text{kNm}$$

Where:

- J = V/nD
- t/D = blade thickness/diameter ratio

When  $H_i/D > 0.55$ ,  $H_i/D$  should be taken as 0.55

It is noted that for geometrically and dynamically similar interaction conditions, propeller ice torque varies with the cube of propeller diameter, as opposed to the square of propeller diameter for ice force in I3.4.3.1 and I3.4.3.2.

**IACS UR I3**  
**Technical Background**  
**Propeller Ice Interaction Loads**

---

This load formula was modified for use as a Regulatory model by the substitution of:

- $H_{ice}$  for  $H_i$ .
- A coefficient  $S_{qice}$  to account for the ice strength influence. The ice strength influence is an increase of approximately 15% in ice load for a doubling of ice strength, as would be the case in going from first year to multi-year ice. In Table 3.2,  $S_{qice}$  is given as 1.15 for ice classes which may interact with multi-year ice.
- The use of two decimal places in the exponent values for simplicity. Higher accuracy cannot be justified.
- The adoption of a J value of 0.5, which provides the maximum value for the J term expression in brackets.
- Pitch and blade thickness are taken at 0.7 radius in m. Pitch shall correspond to MCR at zero speed of ship. For CP propeller this can be taken as 70% of the design pitch at maximum ship speed in open water at maximum continuous rating of the engine.
- Rotational speed - n – shall be corresponding zero speed of ship

As a result of the above measures, the formulae for maximum propeller ice torque in the regulation section I3.4.3.4 become:

$$D_{limit} = 1.81 \times H_{ice}$$

When  $D < D_{limit}$

$$Q_{max} = 105 \times (1-d/D) \times S_{qice} \times (P_{0.7}/D)^{0.16} \times (t_{0.7}/D)^{0.6} \times (nD)^{0.17} \times D^3 \quad \text{kNm}$$

When  $D > D_{limit}$

$$Q_{max} = 202 \times (1-d/D) \times S_{qice} \times H_{ice}^{1.1} \times (P_{0.7}/D)^{0.16} \times (t_{0.7}/D)^{0.6} \times (nD)^{0.17} \times D^{1.9} \quad \text{kNm}$$

Shaft measured ice torque loads on some icebreakers have also been corrected to propeller torques by taking shaft dynamics into account [15]. The resulting propeller torques, relative to propeller diameter and ice thickness are of the same order of magnitude as given in the above formulae.

### **I3.4.3.5 Maximum Propeller Ice Thrust**

When the propeller blade in-plane and out-of-plane ice loads were resolved in the shaft axial direction, the maximum ice thrust was found to be approximately 1.1 times the out-of-plane blade load,  $F_b$  or  $F_f$ .

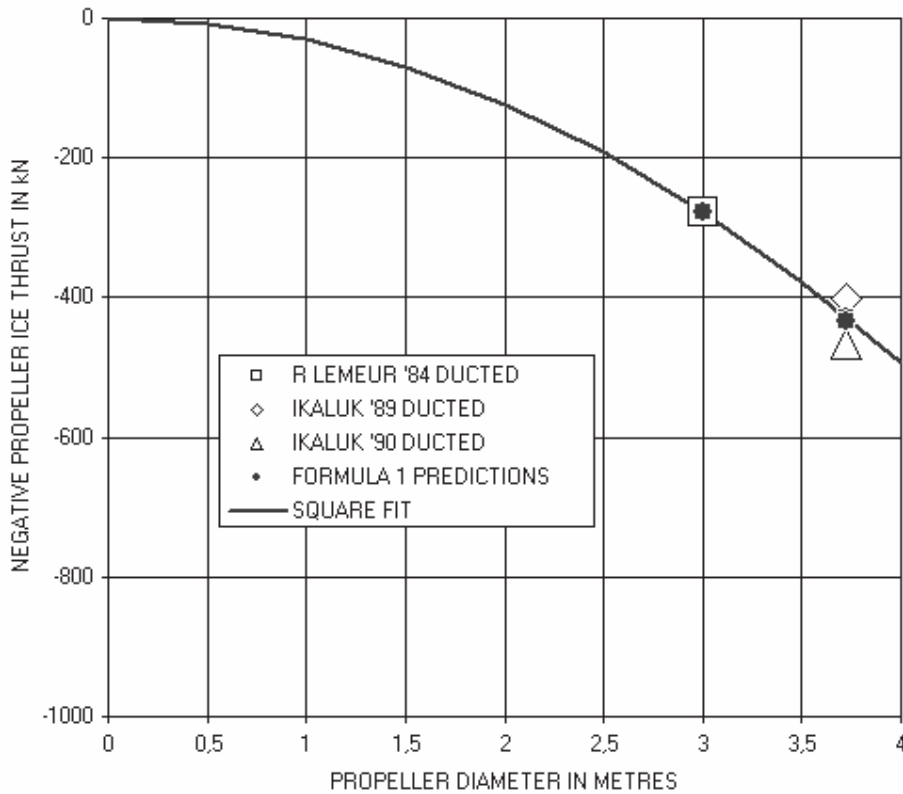
In the figure below, long term negative propeller ice thrust predictions from trials data [15] for “Ikaluk” and “Robert Lemeur” are compared with the above formulae. The propeller thrust predictions are derived from shaft measured data using shaft dynamic response characteristics. The expected value in 500 hours of operation is used, and the regulatory formula values for blade load are multiplied by 1.1 in order to represent shaft thrust.

It is noted that the full scale data match the regulatory formulae very well. This also provides additional validation for the diameter squared influence upon backward propeller blade ice forces.

Load pattern location on the blades are given in the Table 2 , load cases 1 and 5.

**IACS UR I3**  
**Technical Background**  
**Propeller Ice Interaction Loads**

NEGATIVE PROPELLER ICE THRUST PREDICTIONS FROM TRIALS DATA  
AND COMPARISON WITH REGULATORY FORMULA



### **13.4.4 Design Ice Loads for Ducted Propeller**

#### **13.4.4.1 Maximum Backward Blade Force**

For ducted propellers, the backward blade ice force increases with increase in ice thickness until ice thickness equals about 25% of propeller diameter or about 70% of blade length. This is shown very clearly by shaft thrust data for “Nathaniel Palmer” [14] in level ice of increasing thickness.

Ice of thickness 70% blade length can include the largest ice blocks which can enter a ducted propeller without impacting the duct. Therefore, the open propeller model should model the ducted propeller for backward blade force, within this ice thickness range.

Following this reasoning, the formulae for maximum backward blade ice force become:

$$D_{\text{limit}} = 4 \times H_{\text{ice}}$$

When  $D < D_{\text{limit}}$

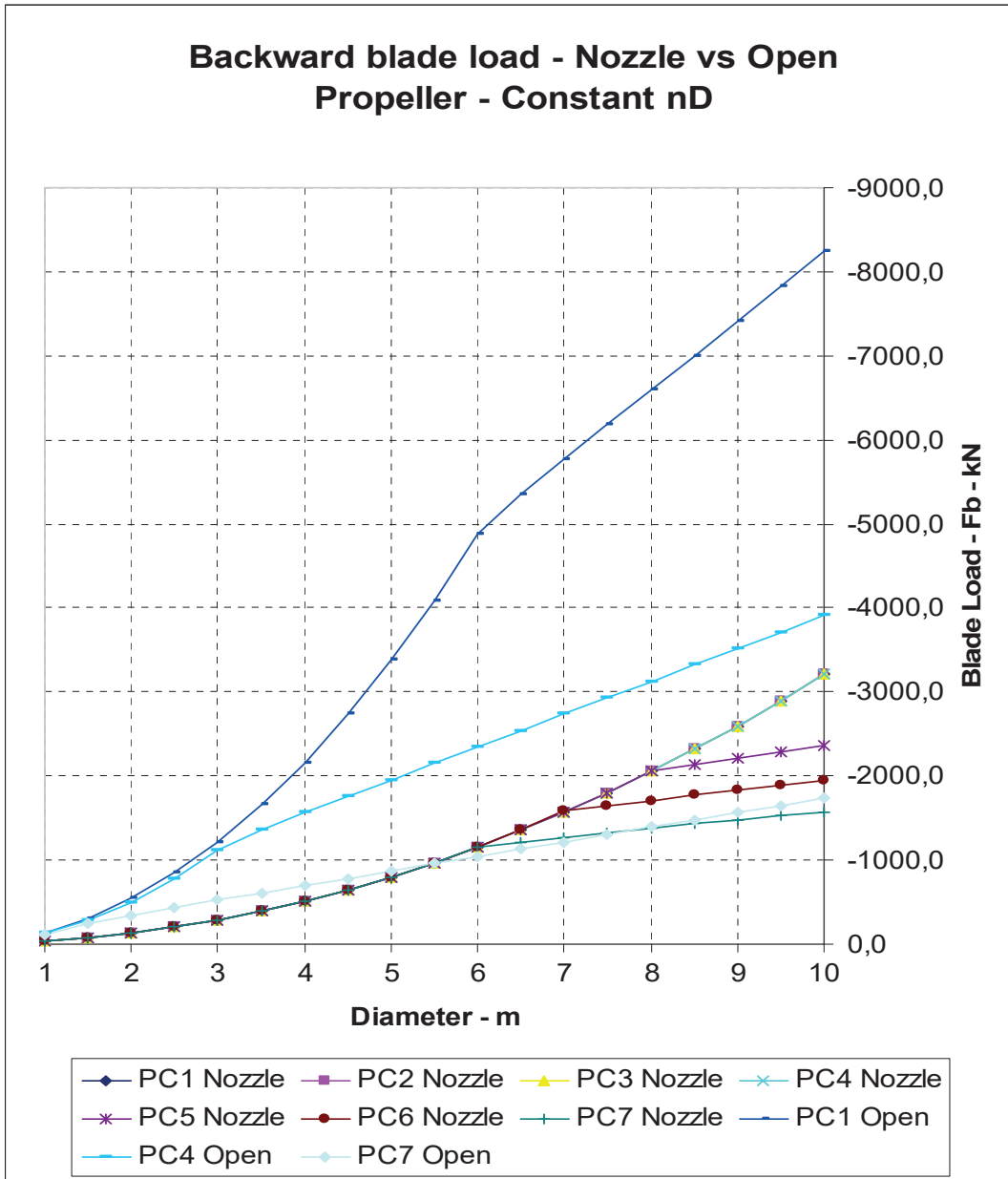
$$F_b = -9.5 \times S_{\text{ice}} \times (nD)^{0.7} \times [EAR/Z]^{0.3} \times D^2 \quad \text{kN}$$

When  $D > D_{\text{limit}}$

$$F_b = -66 \times S_{\text{ice}} \times (nD)^{0.7} \times [EAR/Z]^{0.3} \times (H_{\text{ice}})^{1.4} \times D^{0.6} \quad \text{kN}$$

**IACS UR I3**  
**Technical Background**  
**Propeller Ice Interaction Loads**

Following diagram show backward bending load for ducted propeller with same constants as for open propeller. PC1, PC4 and PC7 open propellers are presented in the same diagram for comparison purpose.



**13.4.4.2 Maximum Forward Blade Force**

The maximum forward blade force is close to the maximum forward blade force on an open propeller of the same diameter.

**IACS UR I3**  
**Technical Background**  
**Propeller Ice Interaction Loads**

This is indicated from full scale Baltic data [9]. Additionally, the maximum directly measured forward blade force on the “Robert Lemeur” agrees with this formulation.

Load patterns location on the blades are given in the Table 2, load cases 2 and 5. Note that forward bending load covers half of the blade width on leading edge side.

**13.4.4.3 Maximum Propeller Ice Torque**

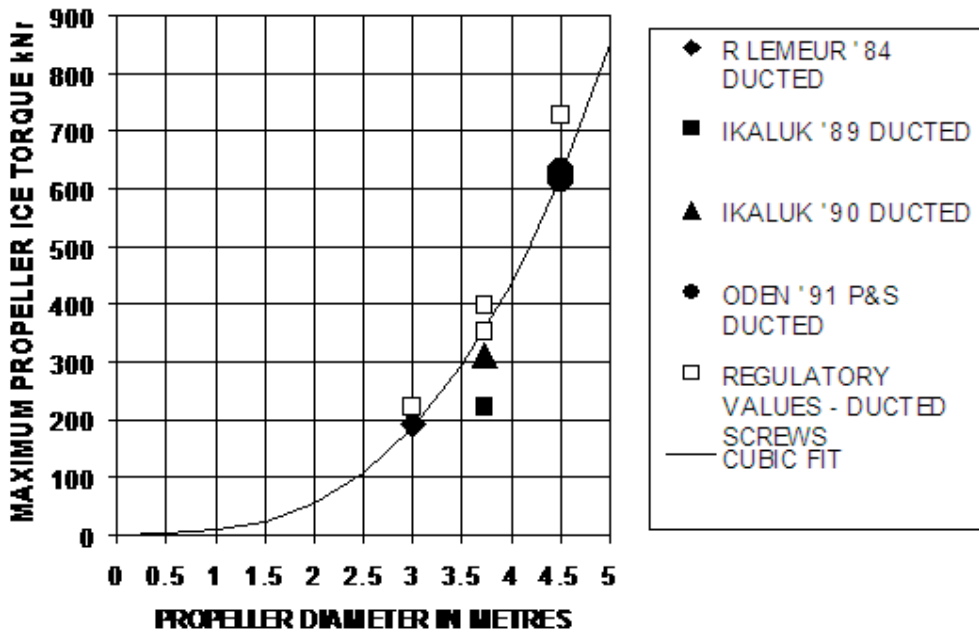
The maximum propeller ice torque is to be taken as 70% of the torque on an open propeller of the same diameter.

In the figure below, long term maximum propeller ice torque predictions from trials data [15] for “Ikaluk”, “Robert Lemeur” and “Oden” are compared with the regulatory requirement. The propeller ice torque predictions are derived from shaft measured data using shaft dynamic response characteristics. The expected value in 500 hours of operation is used. The expected value in 500 hours of operation is used.

A cubic fit is put through the full scale data, which provides support for the propeller diameter parametric relationship developed from the numerical simulation model.

It is noted that the regulatory requirement is set just slightly higher than the full scale data long term predictions.

**MAXIMUM PROPELLER ICE TORQUE PREDICTIONS FROM  
TRIALS DATA AND COMPARISON WITH THE  
REGULATORY MODEL**



**IACS UR I3**  
**Technical Background**  
**Propeller Ice Interaction Loads**

---

**13.4.4.5 Maximum Propeller Ice Thrust**

When the propeller blade in-plane and out-of-plane ice loads were resolved in the shaft axial direction, the maximum ice thrust was found to be approximately 1.1 times the out-of-plane blade load,  $F_b$  or  $F_f$ .

**IACS UR I3  
Technical Background  
Propeller Ice Interaction Loads**

---

**4 REFERENCES AND OTHER SOURCES OF INFORMATION**

**JRPA#6 CANADA/FINLAND JOINT RESEARCH PROJECT ARRANGEMENT**

- 1 “Propeller-ice Interaction – Joint Research Project Arrangement #6, Joint Conclusion report”. H. Soininen, B. Veitch. Technical Research Centre of Finland Research Notes 1762. 1996.

**STATE OF THE ART REVIEW OF ICE/PROPELLER INTERACTION MODELS**

- 2 “Interaction between ice and propeller”. Matti Jussila, Harry Soininen. Technical Research Centre of Finland, Research Notes 1281. September 1991.

**CONTACT LOAD COMPONENT MODEL DEVELOPMENT**

- 3 “Propeller Ice Contact Load Model”. Harri Soininen. VTT Manufacturing Technology Technical Report VALB89. December 1995.
- 4 “Laboratory tests of propeller blade profile pressure distribution under ice contact”. H. Soininen et al. VTT Research Notes 1664. August 1995.
- 5 “High Speed Uniaxial Compression tests On Ice”. J. Sweeney, S. Jones. NRC/IMD Report LM-1994-17. November 1994.

**NON-CONTACT COMPONENT MODEL DEVELOPMENT**

- 6 “JRPA#6 Propeller/Ice Interaction Development of Semi-Empirical Models”. R. P. Browne for NRC/IMD. Report CR-1996-12. September 1996



**IACS UR I3  
TECHNICAL BACKGROUND  
MACHINERY FASTENING LOADING ACCELERATIONS**

---

**IACS Unified Requirements for Polar Ships  
Background Notes and Verification**

**for**

***“Machinery Fastening Loading Accelerations”***

**by Robin Browne**

**IACS UR I3**  
**TECHNICAL BACKGROUND**  
**MACHINERY FASTENING LOADING ACCELERATIONS**

---

**1. SCOPE AND OBJECTIVES**

Accelerations imposed upon machinery due to ice impact/ramming are required in order that the integrity of holding down arrangements of essential machinery is maintained.

Machinery Fastening Loading Accelerations are specified in the Machinery Requirements URI3.6. The formulae in URI3.6 defining these accelerations, require in turn, additional information on bow vertical ice force and bow side ice force magnitudes from the Structural Requirements URI2 (latest version December 2004).

Using the latest versions of URI2 and URI3, an Excel spreadsheet program has been written to calculate the machinery fastening global accelerations corresponding to ship conditions where full scale trials data of global ship accelerations have been measured.

**2. POINTS OF DISCUSSION**

There is a paucity of data for global ship accelerations. However, the data that exist have been extracted from reports of full scale icebreaker tests and trials, and reported in Ref 1, from which the acceleration formulae in UR I3.6 are taken.

**COMPARISON OF FULL SCALE DATA WITH UR REQUIREMENTS**

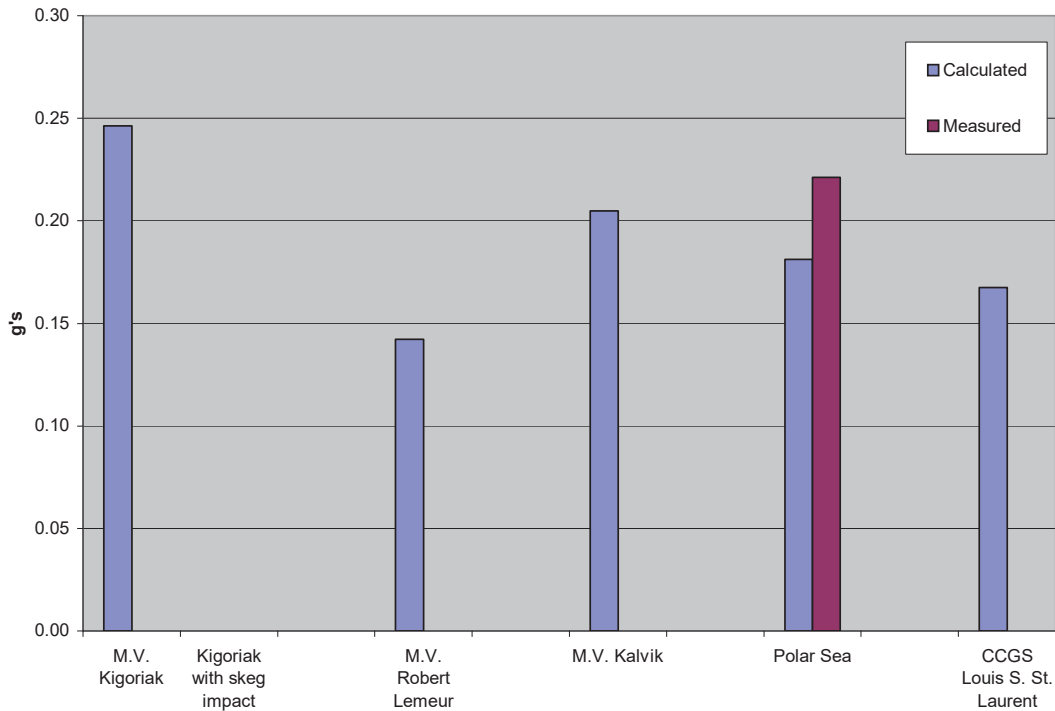
The calculated UR requirements are based on assumptions/standards for the ramming or ice interaction speeds of vessels of any given Polar Class. The full scale data were not necessarily recorded at these ramming speeds, and, for the purposes of comparison, have therefore been adjusted linearly to the standard values.

**IACS UR I3**  
**TECHNICAL BACKGROUND**  
**MACHINERY FASTENING LOADING ACCELERATIONS**

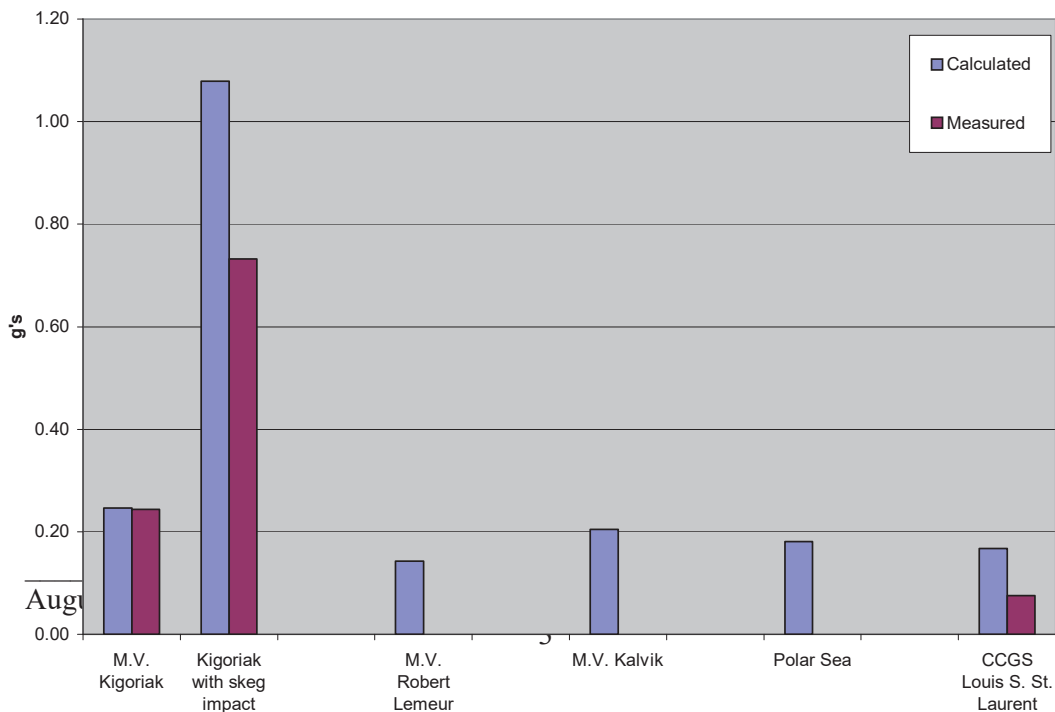
---

**13 6.2 LONGITUDINAL ACCELERATION COMPARISONS**

LONGITUDINAL ACCELERATION AT BOW IN ICE



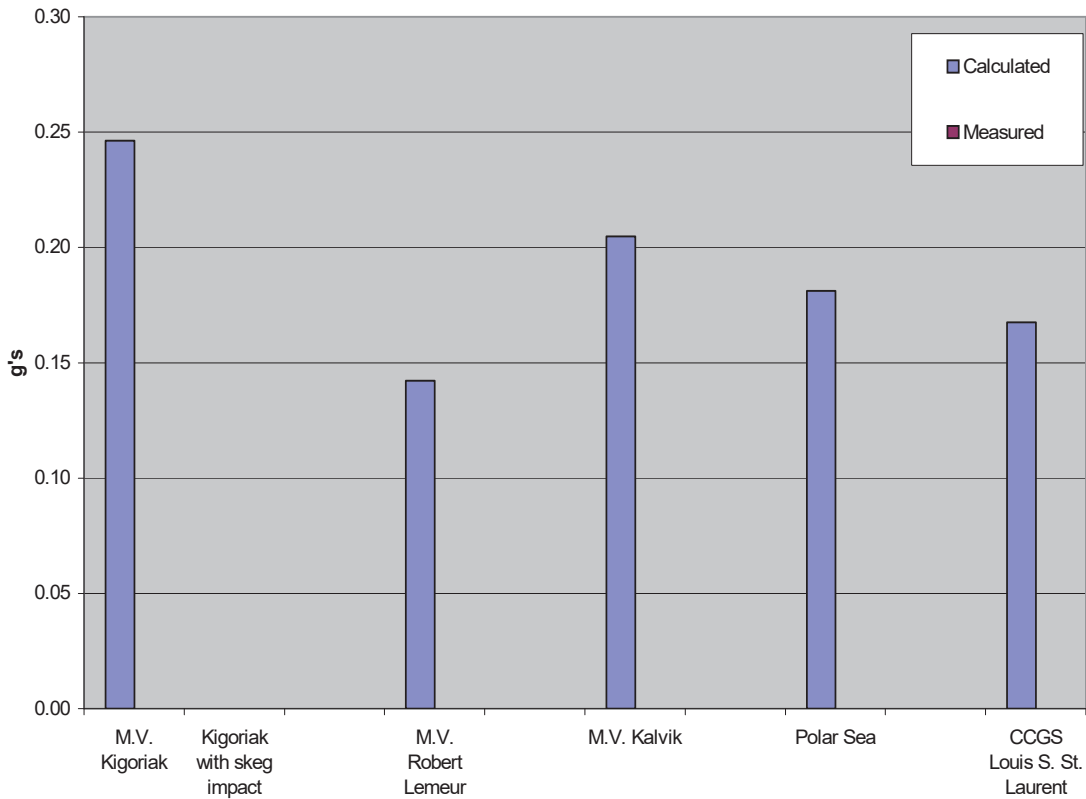
LONGITUDINAL ACCELERATION AT MIDSHIPS IN ICE



**IACS UR I3**  
**TECHNICAL BACKGROUND**  
**MACHINERY FASTENING LOADING ACCELERATIONS**

---

**LONGITUDINAL ACCELERATION AT STERN IN ICE**



The UR required vertical accelerations show a generally good agreement with actual measured values from icebreakers in operating conditions. There are, however, many fewer data. There is just one comparison for the bow (Polar Sea), three for midships (Kigoriak with and without skag contact and Louis St Laurent), and none for the stern. It is of course clear that there should be negligible difference in accelerations measured simultaneously at these three locations on a vessel. The four records should therefore be seen as agreement for four cases at all locations. These were all directly measured accelerations at the noted locations.

**IACS UR I3**  
**TECHNICAL BACKGROUND**  
**MACHINERY FASTENING LOADING ACCELERATIONS**

---

**I3 6.3      VERTICAL ACCELERATION COMPARISONS**

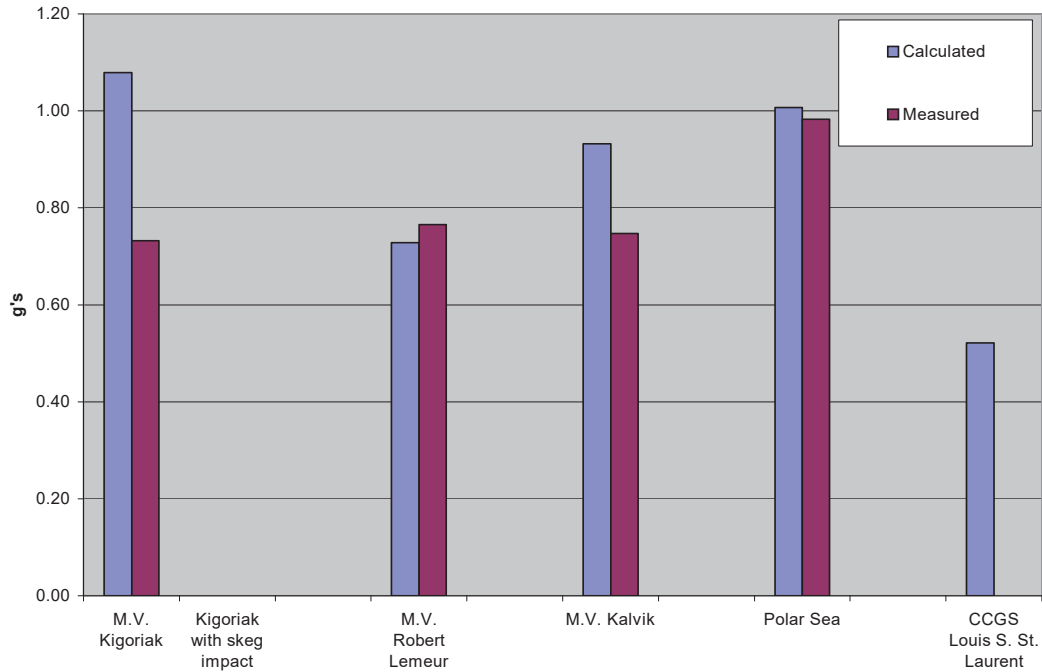
# IACS UR I3

## TECHNICAL BACKGROUND

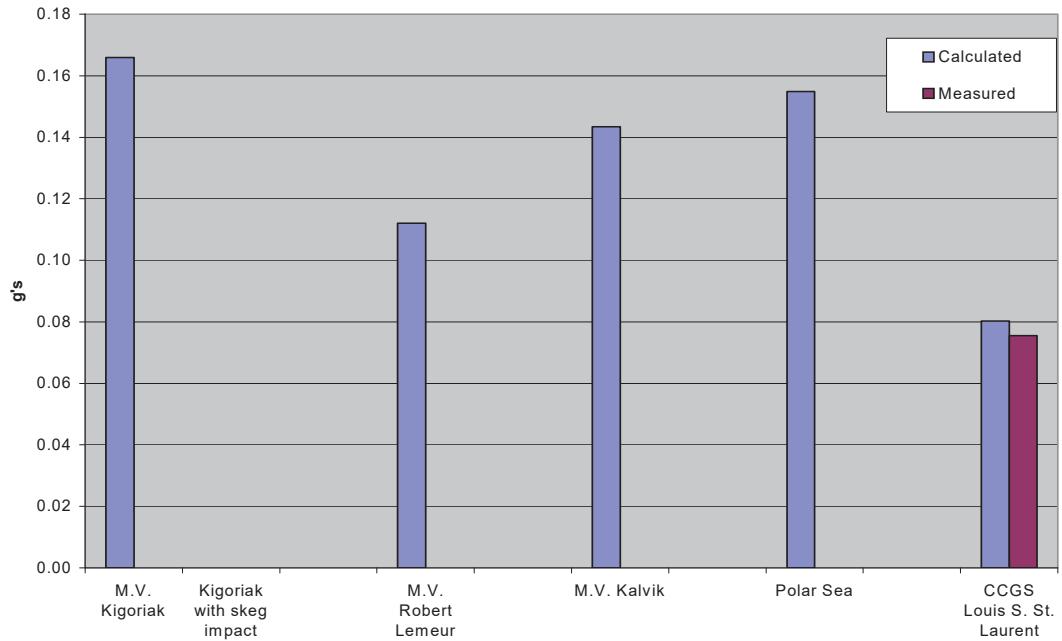
### MACHINERY FASTENING LOADING ACCELERATIONS

---

**VERTICAL ACCELERATION AT BOW IN ICE**



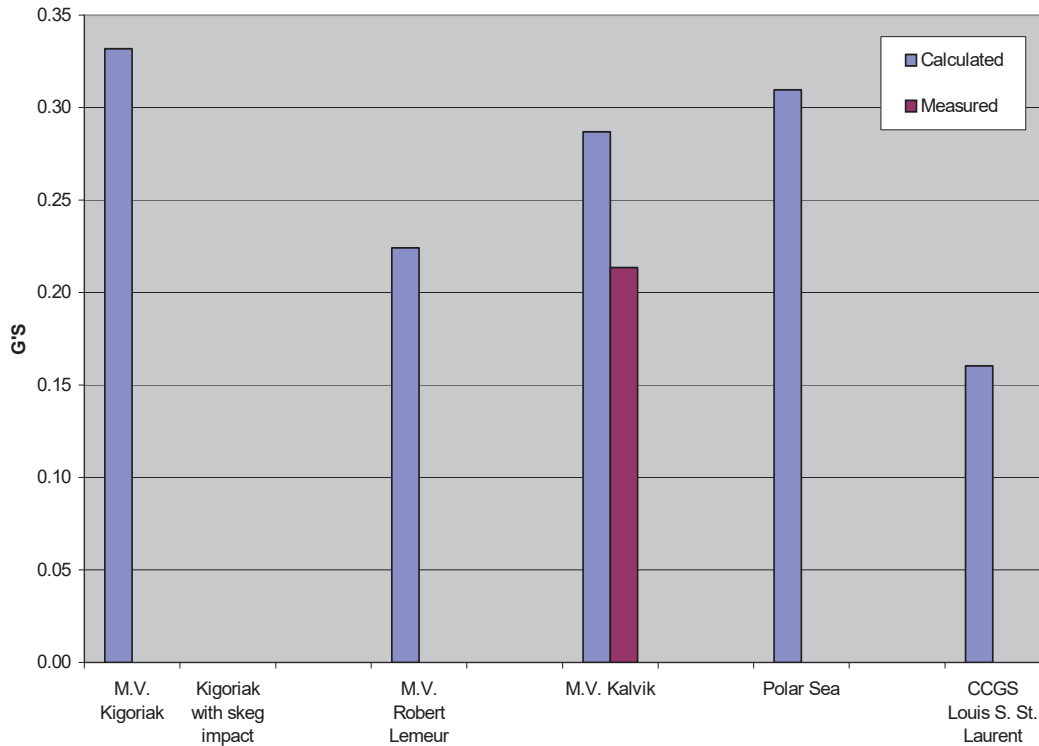
**VERTICAL ACCELERATION AT MIDSHIPS IN ICE**



**IACS UR I3**  
**TECHNICAL BACKGROUND**  
**MACHINERY FASTENING LOADING ACCELERATIONS**

---

**VERTICAL ACCELERATION AT STERN IN ICE**



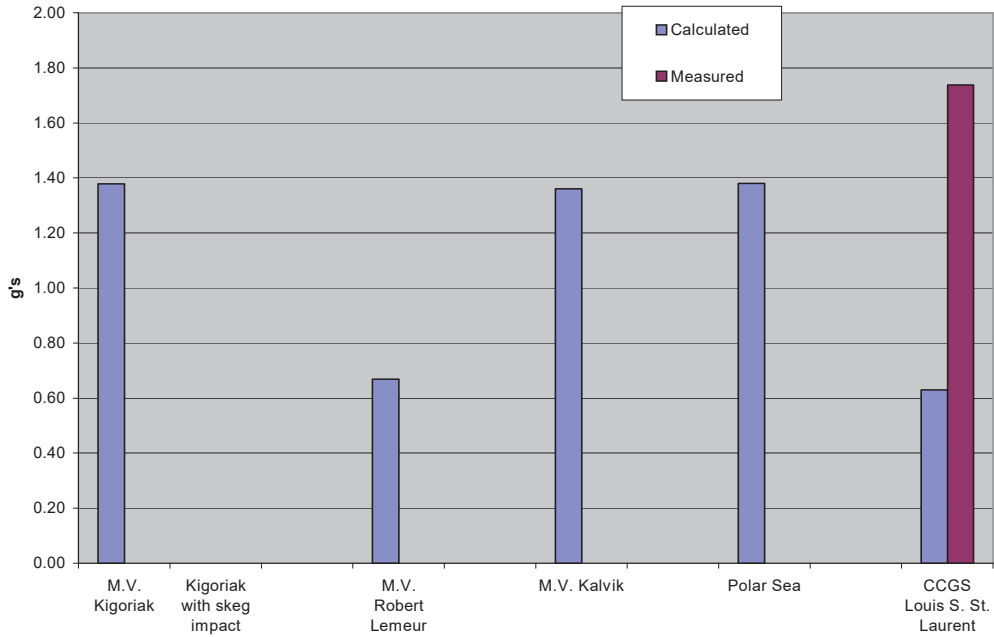
The UR required vertical accelerations show a generally good agreement with actual measured values from icebreakers in operating conditions. There are four comparisons for the bow (Kigoriak, Robert Lemeur, Kalvik, and Polar Sea), and one each for midships (Louis St Laurent) and the stern (Kalvik). These were all directly measured accelerations at the noted locations.

**IACS UR I3  
TECHNICAL BACKGROUND  
MACHINERY FASTENING LOADING ACCELERATIONS**

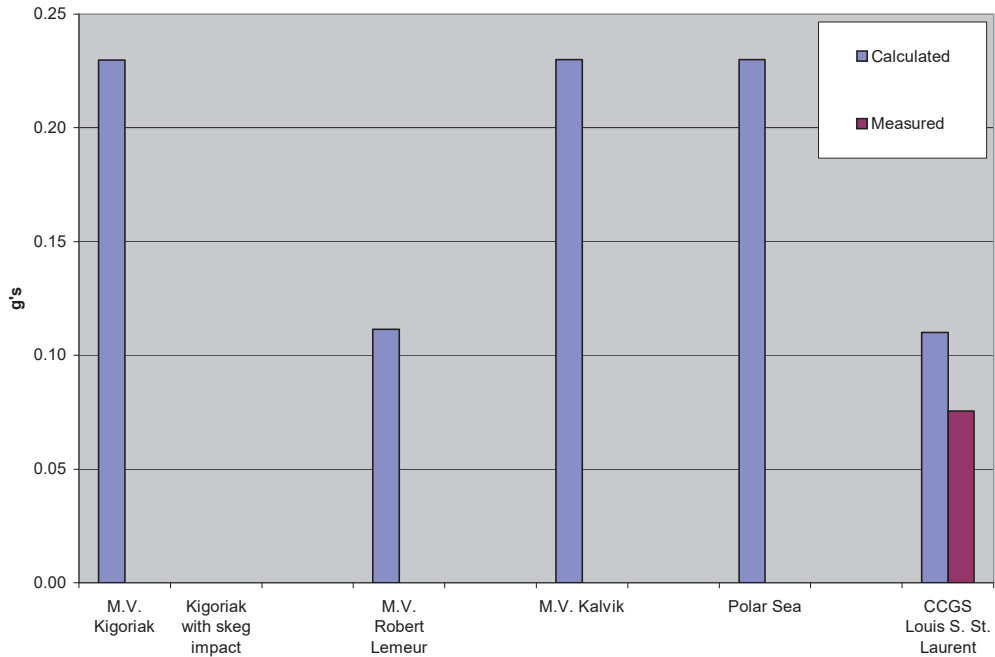
---

**13 6.4 TRANSVERSE ACCELERATION COMPARISONS**

**TRANSVERSE ACCELERATION AT BOW IN ICE**



**TRANSVERSE ACCELERATION AT MIDSHIPS IN ICE**

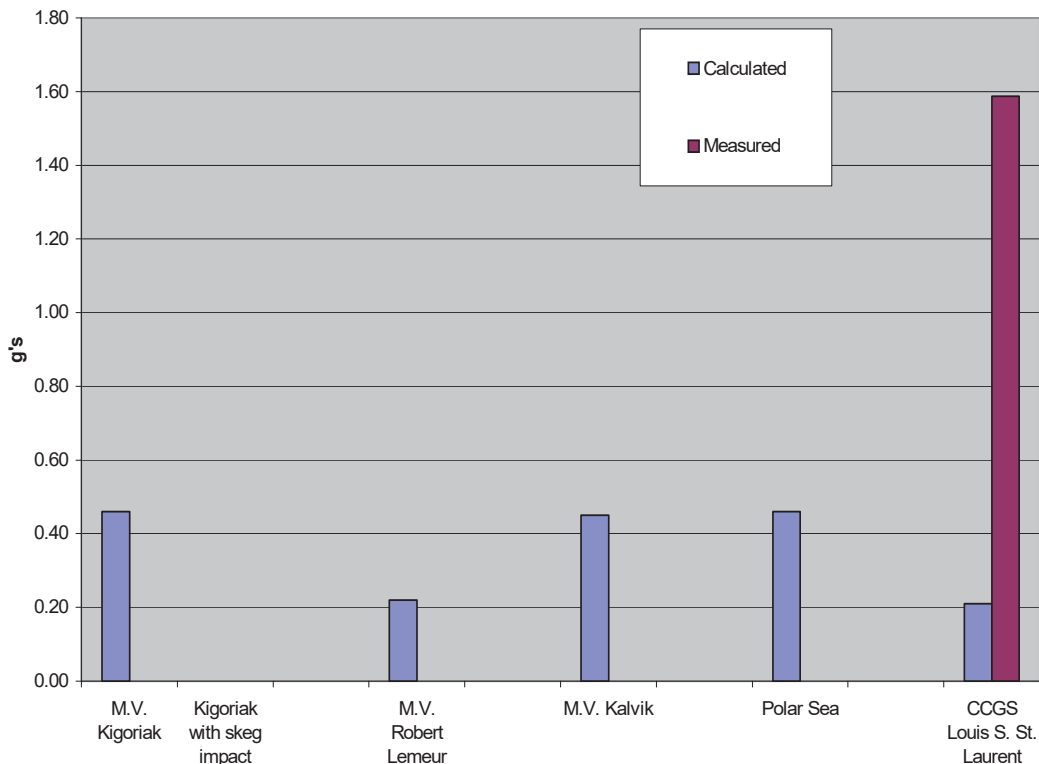




**IACS UR I3  
TECHNICAL BACKGROUND  
MACHINERY FASTENING LOADING ACCELERATIONS**

---

**TRANSVERSE ACCELERATION AT STERN IN ICE**



Transverse accelerations are only available for one vessel, Louis St Laurent. The measurements were made at midships, using a gyro-stabilised linear and angular acceleration array. The direct measurement of transverse acceleration at midships shows reasonable agreement with the UR requirements. However, those at bow and stern are very high relative to the UR requirements.

It is suspected that resolution of the bow and stern accelerations from the recorded linear and angular accelerations has been faulty. However, these trials were conducted in the late '70s and there is no means of verifying this statement. It is, however, technically reasonable to expect the transverse accelerations at any location to be reasonably similar to the vertical accelerations. The calculated values are such. The published transverse accelerations at bow and stern for Louis St Laurent are therefore rejected as incorrect.

### **SUMMARY**

All available, and considered reliable, measured full scale global accelerations of icebreakers, show generally good agreement with the Machinery URI3 requirements. These requirements are considered sufficiently accurate as they stand.

**IACS UR I3**  
**TECHNICAL BACKGROUND**  
**MACHINERY FASTENING LOADING ACCELERATIONS**

---

**3. REFERENCES**

- 1 Harmonisation of Polar Ship Rules, Development of Polar Rules for Machinery: Holding Down Loading Factors ( Global Ship Accelerations)  
Fleet Technology Ltd. 4643A3.DF, 27 February 1997.

**IACS Unified Requirements for Polar Ships**

**Background Notes to**

***“Blade design” version 2.0***

by Pekka Koskinen, Robin Browne and Lasse Norhamo

**IACS UR I3**  
**Technical Background**  
**Propeller Blade design**

---

## **1 SCOPE AND OBJECTIVES**

It was a requirement that the use of modern analytical tools be considered to replace the current blade strength requirements. The design of blades and their skews have altered considerably in the recent years, noting that some failures could not have been predicted by the rules and requirements currently in place.

This document gives information on how the requirements for propeller design given in IACS UR I3 (Section 5 of the Machinery Requirements for Polar Ship) have been developed. Direct citations from the Unified Requirements are written in *Italics*, and comments on the paragraph in question are written in normal text.

## **2 POINTS OF DISCUSSION**

### **I3.5.1 Design Principle**

The propeller design has to fulfil the maximum load design criteria. The maximum load design criterion is based on estimation of the maximum load expected once during the ship's service life. This load should not cause any significant damage to the blade that could put the ship's safety at risk. However, local yielding on the blade may occur.

This maximum load is based on normal prudent vessel operation in ice, relative to the vessel design, ice class and the ice conditions. Even higher ice loads can be generated by "off-design" operating conditions, such as might occur if a propeller blade were to strike an ice feature, when the propeller was stopped and the vessel was moving.

A requirement therefore exists, to protect the machinery system from such "off-design" loads – called "Blade failure load –  $F_{ex}$ " and is used as one design criteria for blade attachment, hub strength, CP-mechanism and propeller shaft, as well as for thrust bearing..

The strength of the propulsion line components are, subsequently, to be designed according to the "selective strength principle". This means that the first damage should be to a component that is relatively easy to repair, and whose damage does not cause any remarkable risk to the ship's safety. Damages to other shaft line components are then avoided. For most designs, the propeller blade is likely to be the selected "sacrificial" component.

The selective strength principle is quite similar to the "pyramid of strength" principle. However, a true pyramid of strength, where the strength requirement increases stepwise from the propeller along the shaft line, is impractical, and would cause overly high strength requirements for some shaftline components. This is why the "selective strength criteria" can be applied in the new requirements and "pyramid strength principle" is limited to propeller and propeller shaft.

### **I3.5.3 Blade Design**

#### **I3.5.3.1 Maximum Blade Stresses**

Blade stresses are determined on the basis of estimated maximum loads, which act on realistic areas of the blade, and bend the blade in both the forward and backward directions. Blade stress data are required in both bending directions for fatigue loading calculations.

# IACS UR I3

## Technical Background

### Propeller Blade design

---

For an open propeller, the main load case is generally where the propeller is milling an ice block, and the ice pressure load acts on the leading edge of the forward side (suction side of blade with vessel going forwards) of the blade (Figure 1a). This load bends the blade backwards.

Full-scale experience indicates that loads acting over the tip area (Figure 1b), also occur (Koskinen & Jussila 1991, and DNV damage investigations 1983-1990). Again, these loads bend the blade backwards when the vessel is going ahead. These loads may occur for example when a ship is turning, and an ice block enters the propeller in the radial direction. This tip load case is often the most critical one for highly skewed propellers.

Forward blade bending loads also occur. Whereas their magnitude is reasonably well defined, their nature and exact location are not as well understood as for the backward bending loads. The same load distribution as for the ice block milling condition (Figure 1a) is used, as a worst case scenario.

The same load case distributions are used for ducted propellers. However, the relative magnitudes of the loads are different, with the forward bending case generally being the most important.

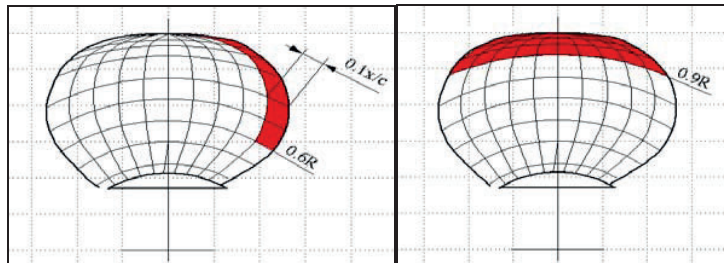


Figure 1. Location of the load on the blade with original load pattern 10% of section length

In order to determine the methodology to be used for calculating blade stresses, three alternate procedures have been studied.

The traditional procedure, on which the present ice class rules are based, gives bending stresses that are caused by a point load on the blade. It is assumed that the blade is a cantilever beam, and the stresses due to spindle torque are neglected.

Another methodology, proposed by the Russian register (Katsman & Andryushin 1997), takes into account the additional stresses (constraint torsion) due to the spindle torque.

The third methodology is based on FE-analysis, in which loads are applied on the blade as shown in Figure 1.

These methods have been compared by the Machinery Working Group. FE-analysis for propeller blades were carried out by each classification society, and the results were compared with those obtained by the other methods. The comparison was carried out by Lloyds Register in the form of an Excel Workbook. The comparison showed that the simplified methods could not predict the blade stresses with reasonable accuracy. In general it is not acceptable that an advanced method, in this case FE-analysis ended up in considerably higher stresses in a blade. In addition, the measured stresses from the icebreaker Polar Star, showed good agreement with the stresses obtained with FE-analysis (Browne 1998). On other hand, calculated stresses for “Gudingen” propeller indicate that blades should have been destroyed, if the estimated loads had been acting in true case. Gudingen propeller has been made to comply 1A Super, when as the ship it self has 1A ice class. This ship has been operated 20 years in occasionally difficult ice conditions without visible damage on the propeller blades.

# IACS UR I3

## Technical Background

### Propeller Blade design

---

Based on these studies it was decided to use FE-analysis in the rules for stress calculation. However, there was a significant scatter in the stresses calculated by different classification societies using FE-analysis. This emphasises a need of guidelines for FE-analysis in the new UR.

Ice load contact patterns for  $F_b$  and  $F_f$  were increased from 10% to 20% of the chord length. See Fig. 2

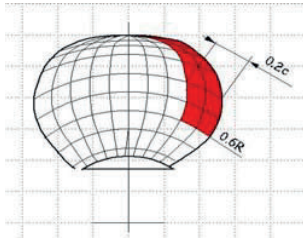
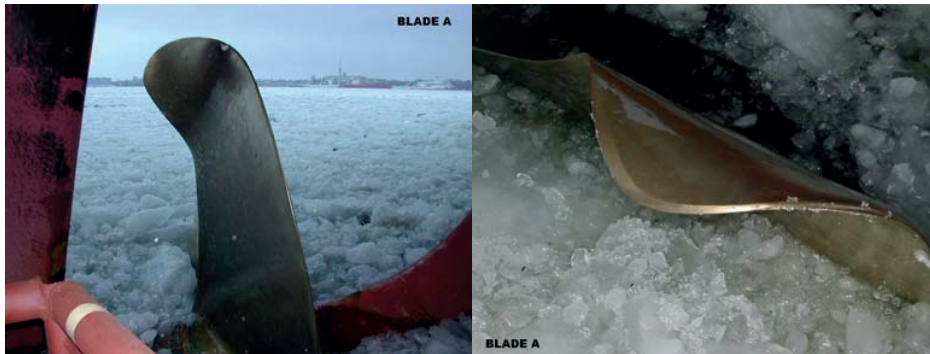


Fig. 2 Ice load contact area for  $F_b$  and  $F_f$

During winter 2003 DNV experienced several propeller damages caused by propeller – ice interaction during reversed operation in ice condition. The blade tips on the trailing edge side have most likely been bent by ice during reversing of propellers.

Even if these damages may be considered as minor, engine load may be seriously affected requiring immediate temporary repair (cutting off the bent blade tip and opposite one for balancing).



1. Bent blade tip on the trailing edge side

2. Detail of the same

Propeller facts:

- Fixed pitch;
- Skew angle 24°;
- Diameter 5.8 m;
- Engine power about 9500 kW.
- Ice Class ICE-1B.

In the In the areas where damages have been experienced the ice conditions were severe for ice class ICE-1B ships, in fact ice thickness in excess of 60-70 cm.

Considering that the damaged propellers did satisfy the current ICE-1B rules (in fact the tip thickness is 50% above the requirement) DNV has carried out several FEM analyses both in order to estimate blade stresses caused by ice loads and effect of possible modifications of blade shape and thickness profiles. Several propellers having skew angles close to 25° would fulfil the I3 criteria as drafted and nevertheless be vulnerable to above type damages.

DNV carried out number of FE-calculations in order to determine proper criteria for skewed fixed pitch propellers. See examples of stress plots below.

**IACS UR I3**  
**Technical Background**  
**Propeller Blade design**

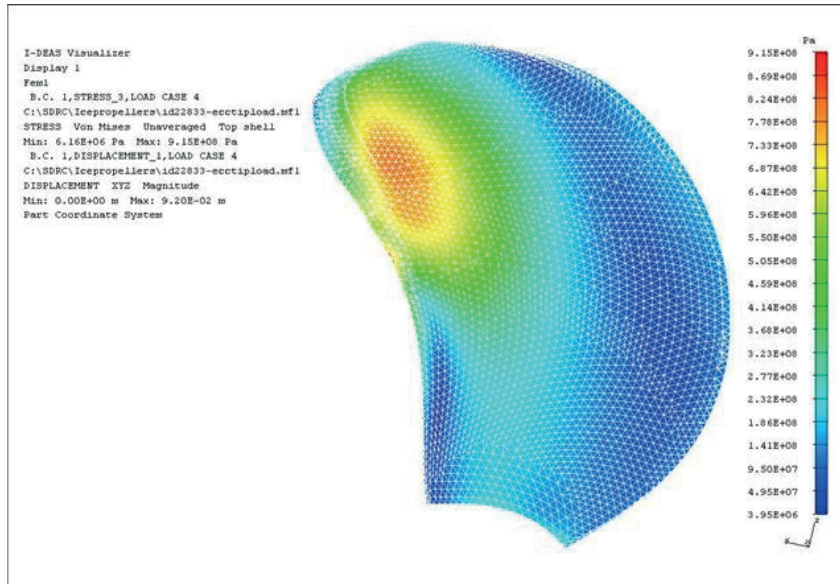


Fig. 3 Von-Mises stresses – load from 0.6R to 1.0R on trailing edge - Suction side

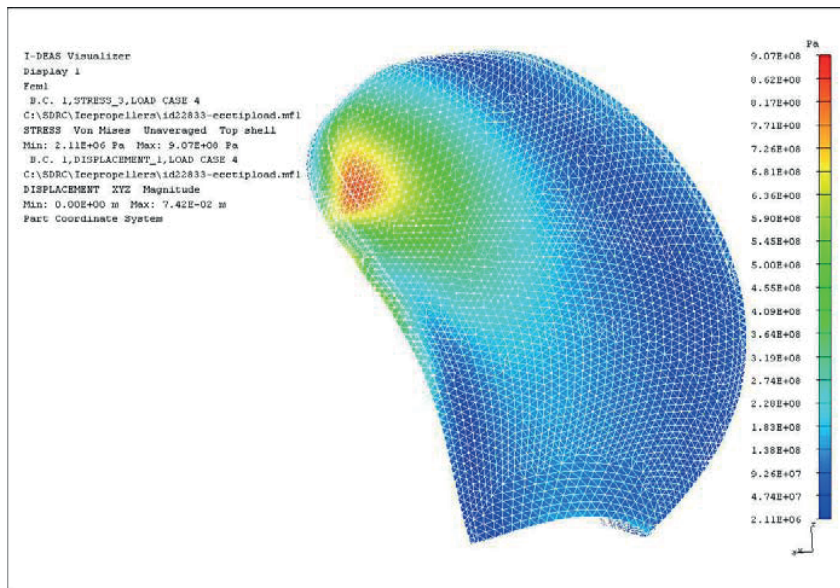


Fig. 4 Von-Mises stresses – load from 0.8R to 1.0R on trailing edge - Suction side

This resulted in an additional ice load case – trailing edge load – that provides proper trailing edge strength for reversible rotation propellers, and eliminates need for any skew angle limitation for which the I3 is valid.

Trailing edge load case – (load case 5 for open and ducted propellers):

- 60 % of  $F_f$  or  $F_b$  which one is greater
- Uniform pressure applied on propeller face (pressure side) to an area from 0.6R to the tip and from the trailing edge to 0.2 times the chord length



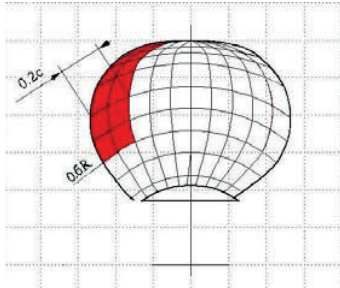


Fig. 5 Trailing edge load case for reversible propellers

Forward bending load -  $F_f$  - for ducted propellers did not have same type load pattern as open propellers. Based on validation of 4 ducted propellers and re-assessment of measurement results, following load pattern was selected – Load case 3:

- Uniform pressure applied on the blade face (pressure side) to an area from 0.6R to the tip and from the leading edge to 0.5 times the chord length.

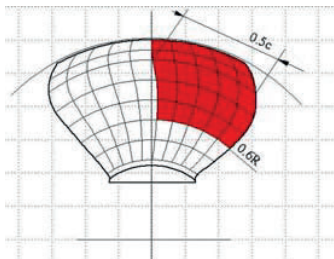


Fig . 6 Ducted propeller – Forward load

### 13.53.1 Maximum blade stresses

Calculated blade stress for maximum ice loads shall have sufficient safety margin (1,5) to the material reference stress in order to avoid harmful distortion of the blade considering consequences for maintenance of propulsion capacity.

Permissible static stress can thus be defined as :

$$\sigma_{ref} : / S$$

$\sigma_{ref}$  is reference stress, defined as:

$$\sigma_{ref} = 0.7 \cdot \sigma_u \text{ or}$$

$$\sigma_{ref} = 0.6 \cdot \sigma_{0.2} + 0.4 \cdot \sigma_u \text{ which ever is lesser}$$

Where  $\sigma_u$  and  $\sigma_{0.2}$  are representative values for the blade material at considered section.

A reference stress has originally been developed to reflect the real capability of the blade to carry loads aimed to in particular for extreme loads, i.e. plastic bending of the blade. This has been used in definition of the Blade failure load –  $F_{ex}$ . The formula for  $\sigma_{ref}$  takes into account, for example, the increase in strength of the blade due to work hardening of the material. The reference stress is a combination of the 0.2-proof stress and ultimate tensile strength ( $\sigma_{ref} = 0.6 \cdot \sigma_{0.2} + 0.4 \cdot \sigma_u$ ). The development of the formulae is



**IACS UR I3**  
**Technical Background**  
**Propeller Blade design**

---

based on a test series carried out by VTT where cantilever beams made of blade materials were bent. The cross-section of the beam was 6\*20 mm and three bronze and two stainless steel materials were tested. The development of the reference strength formula was carried out in close co-operation with Det Norske Veritas.

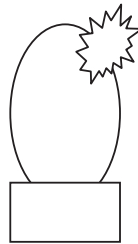
During the work of the MWG, a concern arose that the reference strength equation might overestimate the strength of high tensile strength steels. Therefore, the reference strength was limited to 0.7 times the ultimate strength of the blade material.

**I3. 5.3.2 Blade Edge Thicknes**

Analytic method to derive formula for required tip / edge thickness is explained below.

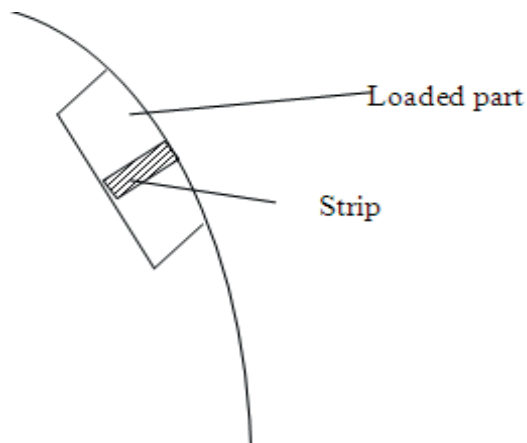
**Basic principle:**

Propeller tip or edges shall not be subject to permanent deflections when exposed to an extreme, local ice pressure of 16 N/mm<sup>2</sup>.



**Assumption:**

The local loading will cause high stresses just inside the loaded area. It is assumed that for a narrow strip within the loaded area, the stresses may be calculated by cantilever beam theory.



**Load prediction**

If the breadth, B of the strip is set to unity, the resulting load will be:

$$F_{edge} = pA = 16 \cdot 1 \cdot X$$

**IACS UR I3**  
**Technical Background**  
**Propeller Blade design**

---

Where X equals the length of the strip, i.e. the distance from the contour to the ending of the loaded area.

Assuming constant pressure, bending moment arm may be taken as half the length of the strip.

I.e.:

$$M_{edge} = F_{edge} \cdot arm = 16X \cdot 0.5X = 8X^2$$

**Stress calculation:**

Further, the section modulus for calculation of stresses at the innermost part of the strip is:

$$w_{strip} = \frac{B \cdot t^2}{6} = \frac{1 \cdot t^2}{6}$$

Stresses at the innermost part of the strip is found as:

$$\sigma_{edge} = \frac{M_{edge}}{w_{strip}} = \frac{8X^2}{\frac{t^2}{6}} = \frac{48X^2}{t^2}$$

Stresses up to yield strength are allowed. This prevents permanent deflections and takes into account current experience that steel blades are less exposed to edge damages than bronze blades (existing edge criterion refers to tensile strength). Hence, edge thickness must not be less than:

$$t \approx \frac{7X}{\sqrt{\sigma_y}}$$

Where  $\sigma_y$  is yield strength of material

*In this respect, no safety factor is included. In case safety factor is taken as 1.5, 2.0 or 3.0, the figure in front of X would be 8.5, 10 or 12, respectively (instead of 7).*

2.5% of the chord length (0.025C) is a relevant reference for calculating maximum stresses due to extreme local ice pressures at the propeller blade edges - figures for this location is normally given in the section table. However, for large chord lengths (in particular towards the tip), the reference to 0.025C will read to unreasonably large edge dimensions. Hence, the considered distance from the contour to the considered location of the blade should be limited. 50 mm seems to be a reasonable limitation. In the same way a minimum limitation should be applied. 20 mm is suggested.

Including a safety factor of 2.0 with respect to yielding, the following is found:

$$t_{contour} = \frac{10X}{\sqrt{\sigma_y}} \text{ [mm]}$$

For the tip thickness requirement (maximum profile thickness towards tip), chord length is not relevant as reference, and should instead include the propeller diameter, as today (take into account that a minimum value should apply). For instance:

**IACS UR I3**  
**Technical Background**  
**Propeller Blade design**

---

$$t_{tip} = \frac{50(D+10)}{\sqrt{\sigma_y}}$$

Where D is propeller diameter [m]

This ensures that the length of the "calculation strip", X is never taken less than 50mm, even for a small propeller.

For simplicity, this thickness should refer to a fixed radial point, but because the propeller tip is normally rounded, and to avoid conflict with the edge requirement, it should not apply directly to the 1.0R. A better reference is 0.95R. I.e.:

$$t_{0.95R} = \frac{50(D+10)}{\sqrt{\sigma_y}} \text{ [mm]}$$

**Including Ice class dependency:**

In case a dependency of ice class is wanted, this could easily be done introducing a ice class dependency for the extreme ice pressure. This could be tabulated changing the factors used in the formulae above. Assuming that 16 N/mm<sup>2</sup> represents the extreme ice pressure relevant for PC1 (and PC2), the following is suggested:

$$t_{contour} = 2.5X \sqrt{\frac{p_{ext}}{\sigma_y}} \text{ [mm]}$$

X is location for measuring contour thickness [mm], to be taken as 0.025C, but not larger than 50 mm nor less than 20 mm.

and

$$t_{0.95R} = 12.5(D+10) \sqrt{\frac{p_{ext}}{\sigma_y}}$$

Where  $p_{ext}$  is the maximum local ice pressure. and selected based on the measured maximum local ice pressure.


Based on validation exercise and consequent use of permissible stress following has been selected:

$$t_{edge} = x S S_{ice} \sqrt{\frac{P_{ice}}{\sigma_{ref}}}$$

- x = is distance from the blade edge measured perpendicularly to the edge and shall be 2,5% of chord length, minimum 2,5% of 0.975R section length, however need not be taken greater than 45 mm
- S = safety factor

**IACS UR I3**  
**Technical Background**  
**Propeller Blade design**

---

= 2,5 for trailing edges  
= 3,5 for leading edges  
= 5 for tip  
 $S_{ice}$  = according to Section I3.4.4.2  
 $p_{ice}$  = ice pressure  
= 16 Mpa  
 as defined in 5.3.1

Edge thickness is for leading edge and trailing edge for reversible rotation open propellers. Tip thickness refers to the **max thickness** of the cylindrical section at 0,975R.

### 3 REFERENCES

- Browne R. 1998 "Polar Star Antarctic Trials 1995 - Propeller Blade Von Mises Stress Levels", 4 November 1998
- Cowper, B. & Koskinen, P. 1993. Joint Canadian/Finnish Conclusions from Full-Scale Data Review. Ontario, Canada: Fleet Technology Limited Report No. 3657A. 26 p.
- Katsman, F.M. & Andryushin, A.V. 1997. Draft requirements for propeller strength standards of icebreakers and ice-strengthened ship of  $\mathbb{I}7$ - $\mathbb{I}9$  ice categories. St. Petersburg: Russian Maritime Register of Shipping 57 p.
- Koskinen, P. & Jussila, M. 1991. Potkurin lavan jääkuormien pitkäaikaismittaus m/s Gudingenilla [Long Term Measurements of Ice Loads on Propeller Blade of M/S Gudingen]. Espoo: Technical Research Centre of Finland, Research Notes 1260. 46 p. + app. 118 p. (In Finnish.)
- Marquis, G. Koski, K. Koskinen, P. 2000. Development of fatigue design methodology for propellers operating in ice
- Wenshot, P. 1986. The Properties of Ni-Al Bronze Sand Cast Ship Propellers in Relation to the Section Thickness, Naval Engineers Journal, September 1986, pp. 58 - 69

## **Technical Background (TB) document for UR I3 Rev.2 (Jan 2023)**

### **1. Scope and objectives**

- General Update of this UR  
Existing requirements have been comprehensively reviewed.
- Introduction of Requirements for Icebreaker Vessels  
The extension of Rev.2 was initiated to incorporate requirements for Icebreakers into UR I3. The main reason for this was that URs I1 and I2 contains such requirements, and in order to obtain a more complete rule set UR I3 should be amended with such requirements.

### **2. Engineering background for technical basis and rationale**

- General Update of this UR  
Members' practices and experiences on Polar/Ice Class ships.
- Introduction of Requirements for Icebreaker Vessels  
*See 4. Summary of Changes intended for the revised Resolution.*

### **3. Source/derivation of the proposed IACS Resolution**

- General Update of this UR  
None
- Introduction of Requirements for Icebreaker Vessels  
None

### **4. Summary of Changes intended for the revised Resolution:**

- General Update of this UR
  - 4.1 Comprehensive revision of existing Sections I3.4 to I3.6 was carried out based upon the following:
    - a) The two blade fatigue methods have been compared. The intention with the IACS method was to have a more transparent method compared to the Finnish-Swedish method. The reason for this was to facilitate easier control by the user on the calculations when the results are not as expected. Both methods are based on the Miner summarize method for variable amplitude loading, and both methods are using the Weibull load distribution. The IACS method divides the load into load blocks and direct summing up the damage caused by each load block. The accuracy increases with increasing number of load blocks. Within the validity range and given accuracy of the Finnish-Swedish method gives corresponding results.

According to the VTT R-00717-08 the formula for  $r$  (eq. 9 and 11) gives an error less than 10% over the specified interval 5 million to 100 million cycles for  $N_{ice}$ . Within this range the IACS method Miner sum varies from approximately 0.4 to 1.0.

The formulae validity is limited to  $N_{ice} < 100$  million which means ice class with  $N_{ice} > 100$  million are outside the validity rang.

- b) Reserved paragraphs have been discussed and PT members agreed on the wording. Simple formulae for different components have been introduced, as it was requested by industry, and used during the validation.
- c) The problem of determination of spindle torque based on blade failure load has been raised by Industry as being too conservative. In order to base a new approach on measurements, a JIP was introduced to accommodate full scale measurements and incorporating CPP makers in the development and validation process. As a result, a new simple formula was developed as well as application of advanced calculation methods enabled. Measured blade geometries and deformation results have been provided for the adaptation of individual advanced calculation methods.
- d) Blade tip requirement was deleted, because there was no connection to the blade tip load cases (to be dealt with by FEA) and requirements are not adjusted. Additionally, it was found that all example cases fulfil the requirement by far.
- e) Torsional loads: Based on findings from validation (a big CP propeller case, calculation and full-scale measurements) an excitation case with a shorter excitation phase ( $45^\circ$ ) was introduced as excitation case 4. This case improves the situation of differences between simulation and full-scale measurement; however, the gap could not be closed, especially for the speed drop. In order to reduce the scope of torsional simulation investigations, it was agreed to require a simulation only at bollard pull condition with maximum attainable rpm and torque.

It was noted that the torsional simulation in time domain reveals reasonable results with respect to calculated torque (to be used further for dimensional check) but showed also a speed drop, which exceeds measurements by far. This speed drop moves the excited high torsional peak downwards to lower speeds and partly into open water resonances or even barred speed ranges. This causes problems for plants having such behaviour. Especially vulnerable are direct drives with FPP and low cylinder number two stroke engines. Although such plants with PC (or equivalent) ice classes are not in service, the PT did consider this problem due to the comparable calculation methods for the Baltic Ice Classes and the probable chance to get a criterion for powering. As a result, the PT included the alternative determination of the peak torque by a frequency domain analysis, if a first blade order exists. The alternative needs to consider the static torque, vibratory part of open water excitation and vibratory part of ice excitation.

- f) Flexible couplings: Based on the discussion with flexible coupling makers and their providers for torsional simulations (mainly engine makers), we have agreed that a fatigue curve for flexible couplings cannot provided and therefore a fatigue strength check has to be performed at certain load numbers, where the makers provide guaranteed minimum torque capacities. Nomenclature of makers has been introduced for an easier reference.

- g) Some material issues have been discussed and decided:
- Equivalency of Charpy V value according investigation report of VTT for nodular cast iron
  - keeping Charpy V values (steel) for the sake of equivalency to Baltic Ice Rules and Canadian ASPPR (Arctic Shipping Pollution Prevention Regulations), but referring to UR W7 and W27, if they require higher values for the considered component
- h) Industry Hearing result contains a number of small but helpful hints for more detailed and clear wording. The main part concentrates on the spindle torque load due to blade failure load and the dynamic torque analysis. The spindle torque problem was dealt with in the BlaFex JIP. The discussion about torsional loads was very extended and a separate meeting was held with the engine maker WinGD – formerly Wärtsilä Switzerland and MAN Copenhagen. The presented proposal for an alternative calculation based on frequency domain analysis was discussed. A number of influencing parameters for the time domain analysis have been investigated and the high chance to get different results based on the same rule was demonstrated. As a result of the Industry Hearing a number of amendments for better wording have been introduced, clarifications but also alternative calculation methods introduced, e.g., a table with Fourier coefficients for a range of different blade numbers to enable a simple determination of the ice excitation in a Frequency domain calculation.
- i) In an extension of PM11914\_, the simplified calculation procedure proposed by industry was investigated and documented in Part B of validation report (see e above). It turned out that the method is not always conservative and loads can be highly over estimated. The PT proposed not to introduce this procedure.
- j) It turned out that there is a complete lack of full-scale measurements for directly coupled two stroke propulsion plants. Those plants are in service with Baltic Ice Class Notations but may be expected in the two lowest Polar Classes in the future. IACS could go ahead, e.g., with CIMAC and organize a JIP to gain sufficient full-scale data. This could be aligned with the outstanding power requirement.
- k) It turned out that blade material fatigue data, especially for steel grades, are rarely available. It is recommended to solve this problem with the relevant industry.
- l) The Panel considered the PT's recommendation to approve the Rev.2 of this UR prepared by the PT under PM11914a in order to gain experience on a wide community based upon the understanding that, after a necessary time period, e.g., five years, IACS may revisit critical points as described above and in a separate document.

#### 4.2 Change in text regarding ventilation requirements

The requirements to ventilation given in I3.12 has been opened up for alternative arrangements. The industry reported difficulties with fulfilling the



absolute requirement of having ventilation openings on both sides of the ship, particularly for passenger vessels. An alternative text was proposed and circulated in the Machinery Panel. The decision was to open up for manual de-icing and anti-icing arrangements as alternatives to having openings on both sides of the ship. Further, the absolute requirement to heating of the inlet air has been replaced with a requirement that temperature of inlet air shall be suitable for safe operation of machinery and accommodation.

#### 4.3 Figures with new plots including excitation case 4

New Figures made by the PT under PM11914a were added. The new plots are taken from the one Member's implementation of the Finnish Swedish Ice Class Rules (FSICR) for *Ice(1A)* which corresponds to PC7.

### • Introduction of Requirements for Icebreaker Vessels

#### 4.5 Increase in blade loads

Backward blade force  $F_b$  has been increased by 10% for Icebreakers in line with earlier TB note for blade loads, wherein it is described that original blade loads measured on actual Icebreakers (which formed the basis for blade loads in UR I3) were decreased by approx. 10% to fit merchant vessels. The backward bending load is a direct contact load between ice and blade. The forward blade bending force  $F_f$  is assumed not be affected by the increase as this load originates from vacuum between blade and ice pulling the blade forward.

#### 4.6 Increase in load cycles for fatigue evaluation

The assumed operational profile of Icebreakers means they will operate more often, and more vigorously in heavy ice conditions compared to merchant vessels. Following this rationale, the number of ice impacts on the propellers during the ship's service life would be higher, and a factor of 3 has been chosen as it aligns with the increase in blade loads from a statistical point of view. See reasoning for this in Attachment 1.

#### 4.7 Change in text for clarification of steering gear requirements

The text in I3.13.4 contains a new requirement for additional torque relief arrangements for Icebreakers, which was modified by the PT to clarify when said arrangements should be triggered. In addition, a piece of text has been added to accommodate alternative steering systems, e.g., electric steering gear. This is because the original text was clearly written with hydraulic steering systems in mind, but the market showed an increasing trend of electric steering gear, particularly on azimuth units.

## 5. Points of discussions or possible discussions

- General Update of this UR
  - a) Wording in paragraph I3.12 has been changed in line with discussions among Machinery Panel members and comments from some Members. It is no longer an absolute requirement to have ventilation openings on both sides of the ship.
  - b) Figures initially prepared by the PT were replaced by new figures covering all 4 load cases.
  - c) Some minor editorial changes have been implemented, mainly wrt. wording.
  - d) With regard to a query on the application of this UR to transverse thrusters, it has been explained by the PT that the scope of UR I3 is main propulsion machinery, and the requirement I3.5.1 quoted by a Machinery Panel member is not aimed at tunnel thrusters (or any other auxiliary thrusters for that matter), but rather on main propulsion propellers mounted in the bow region, such as forward facing shaft lines or bow mounted main propulsion thrusters. Therefore, it has been confirmed that a failed tunnel thruster is normally not a safety concern, and it is not within the scope of UR I3.
  - e) For the gap between UR I3 and FSICR pointed out by a Member, the following course of action has been agreed by this Panel: *Rev.2 of this UR would be finalised without further developing requirements on rudder equipment (which has traditionally been regarded as hull appendages), but this Panel should inform GPG of the need for Hull Panel and Machinery Panel to simultaneously review IACS URs I2 and I3 (according to the following responsibilities (Hull Panel for UR I2 and Machinery Panel for UR I3), at a later stage, to solve the gap between I series URs and FSICR.*

As given in item 4.2 above, a discussion was held within the Machinery Panel wrt the requirements to ventilation in I3.12. The conclusion from this discussion was implemented in the UR.

- Introduction of Requirements for Icebreaker Vessels

A philosophy document was drafted by the PT after brainstorming in the first PT workshop. This was to identify focus areas where Icebreakers should receive special attention wrt. merchant vessels. This philosophy document was circulated within the PT for comments, and the PT concluded on the way forward based on comment replies.

The document together with comments and conclusions is included in Attachment 2.

## **6. Attachments if any**

- General Update of this UR

None.

- Introduction of Requirements for Icebreaker Vessels

Attachment 1: Supplementary notes to selection of ice loads and No. of cycles for ice going vessels with class notation "Icebreaker"

Attachment 2: IACS UR I3 Icebreaker extension – Suggested approach

Attachment 1 Supplementary notes to selection of ice loads and No. of cycles for ice going vessels  
with class notation "Icebreaker"

---

In the following, a brief background is presented aiming to substantiate what is a reasonable increase in ice loads as well as number of ice impacts for a propulsion system in an icebreaker vs. those of a commercial vessel. Quite much of the background material, such as ice loads measurement reports etc. is not available anymore, and hence the reasoning is based on a limited amount of references as well as fractions of remaining historical documents. Technical background documents available for the IACS UR I3 do not fully explain the transformation process from measurements and simulations to the selected ice loads and their associated No. of cycles. Further, the rationale for and details related to subsequent modifications and adjustments are not fully given.

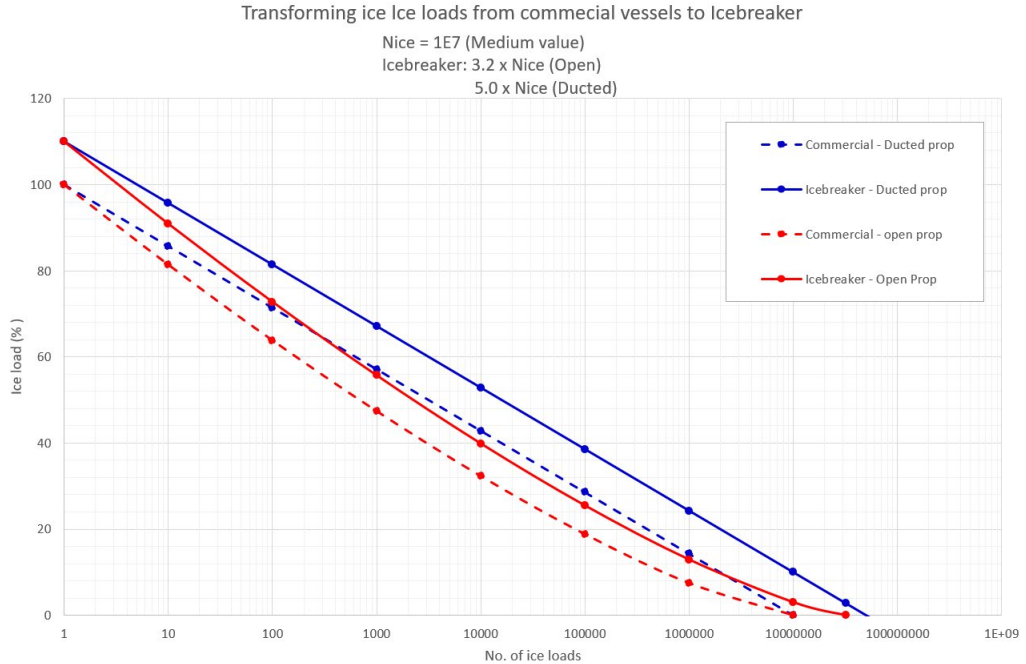
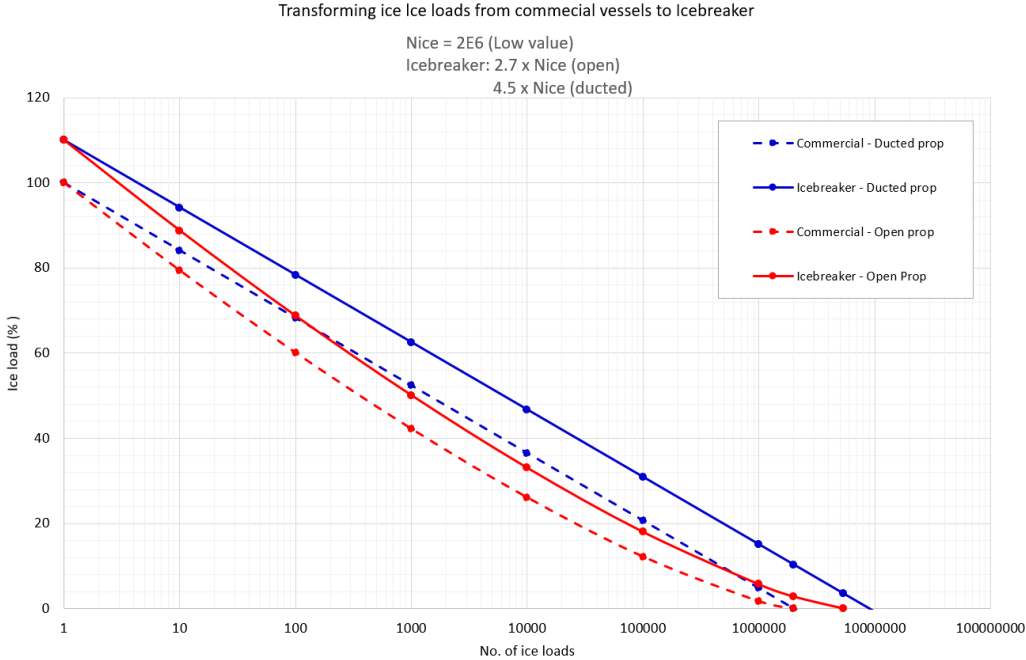
Some basic assumptions and considerations

- The ice load levels and their associated No. of cycles described in IACS UR I3 are relevant for cargo vessels operating in ice
- In the technical background for propeller ice interaction loads, it is mentioned that prior to final publication of ice loads, the general level for backward bending ice load was reduced with 10%. Further, we interpret statements in this document so that this reduction originates from validation studies related load levels on icebreakers vs. cargo vessels, i.e. for icebreakers a 10% higher load level must be expected than formulated in existing rules.
- In the proposal for new icebreaker rules, it has been assumed that the main reason for the difference in backward blade bending loads between cargo vessels and ice breaker is the higher ice exposure for the latter – since ice breakers operate more in ice, there will be more ice impacts at all ice load levels. Due to the statistical distribution of ice loads, this means implicitly that also the maximum load level (which is described in the rules) will increase as a consequence.
- No. of load cycles for forward blade bending ice loads is stated to be higher than the backwards bending loads. However, taking all uncertainties into account this difference is not included in the rules. Hence, No. of ice loads for forward load is the taken same as for backward load.
- The forward blade bending ice load is mainly caused by a suction force occurring when a blade passes near an ice block. Even if also this load in the rules is specified to have a statistical distribution, a similar reduction in load level was not made in the calibration process presenting the final ice loads for cargo vessels. Although this may appear inconsistent, it may be explained by limitations related to low pressure (will not be less than vacuum), and that the current statistical distribution therefore represents a simplification. Hence, an upscaling of forward blade bending loads from cargo vessels to ice breakers is not seen relevant.

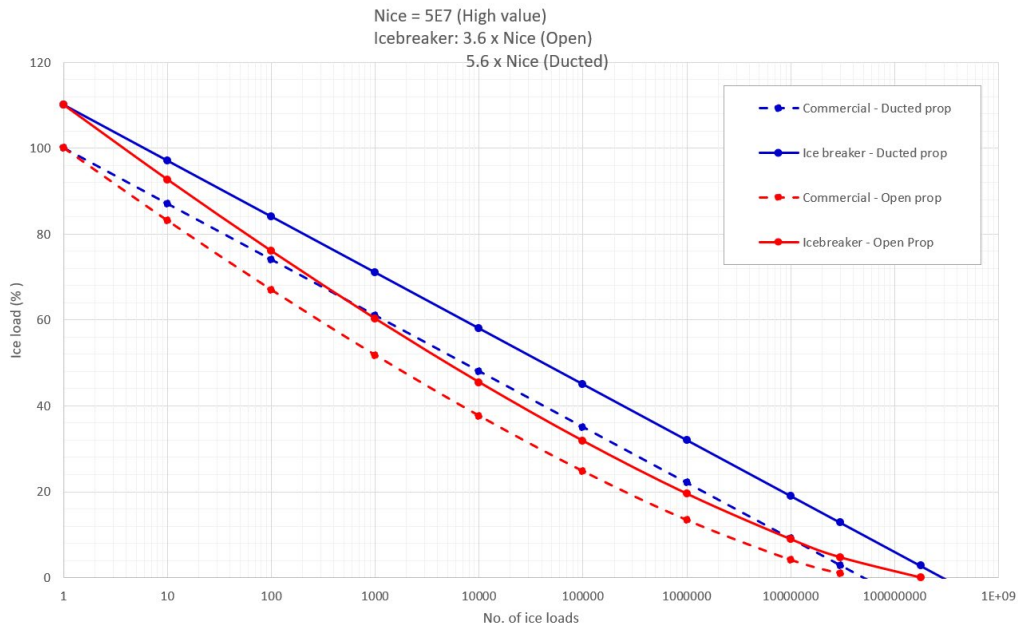
Relevant statistical correction of No. of cycles when maximum load level is increased with 10%

In the following, we have considered the necessary increase in number of ice loads,  $N_{ice}$  that will follow in case the maximum load level is increased with 10% due to higher degree of ice exposure. Hence, number of ice impacts are increased with the same factor at all load levels in the statistical

distribution. This is done for three example cases, assumed to represent a realistic range of load cycles ( $N_{ice}$ ), given the possible variation in ice classes and design parameters.



### Transforming ice Ice loads from commecial vessels to Icebreaker



From the above, it is seen that when number of ice impacts are increased at all load levels in order to increase the maximum forward bending ice load with 10%, the number of ice loads for cargo vessels must be multiplied with a factor in the range of 2.7 to 5.6 within a relevant range of ice loads, considering both open and ducted propellers.

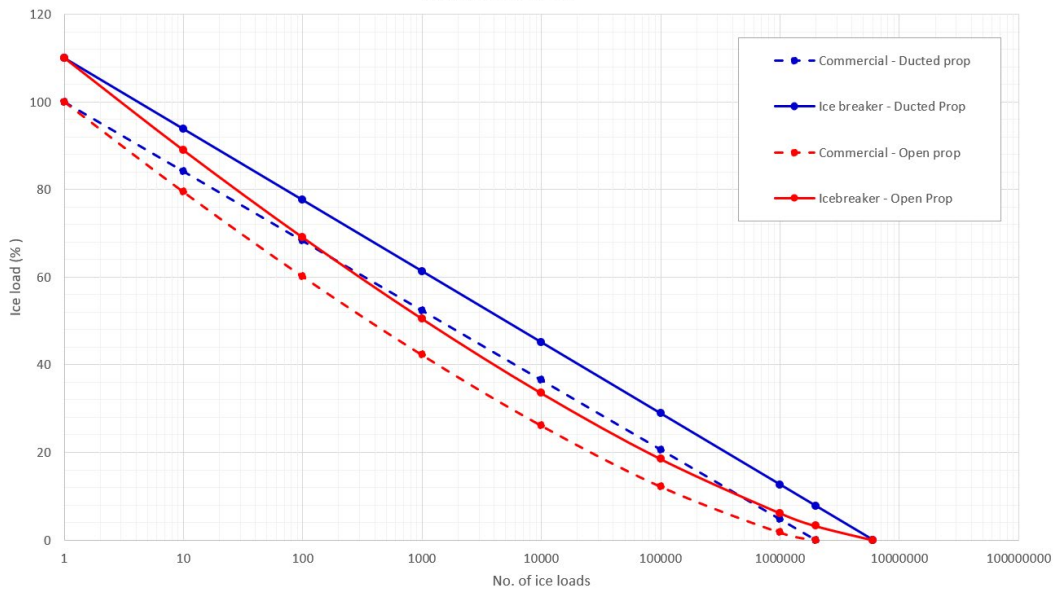
It is seen as reasonable that an ice breaker experiences substantially more ice impact loads on the propulsion system than a commercial (cargo) vessel. It should however, be kept in mind that apparently the No. of ice impacts used for cargo vessels in current ice rules, have not been reduced when calibrating / validating the results. Therefore a limited increase in No. of ice loads may be used when updating the ice rules to be valid for ice breakers – as the base value (for commercial / cargo ships) may have been conservatively chosen. A common multiplication factor of 3.0 on number of ice loads for all ice breakers is a simple approach and seems sufficient, taking the above into account. Further, this is perceived also as a reasonable value describing the increase of ice exposure for icebreakers vs. cargo vessels, given the limited documentation available on this topic.

### Simplified statistical correction of No. of cycles when maximum load level is increased with 10%

In the following, we have evaluated the consequences if increasing number of ice loads, Nice with a factor of 3.0 for icebreakers vs. commercial / cargo vessels. Maximum load level is at the same time increased with 10%. This is done for three example cases – same as previously described.

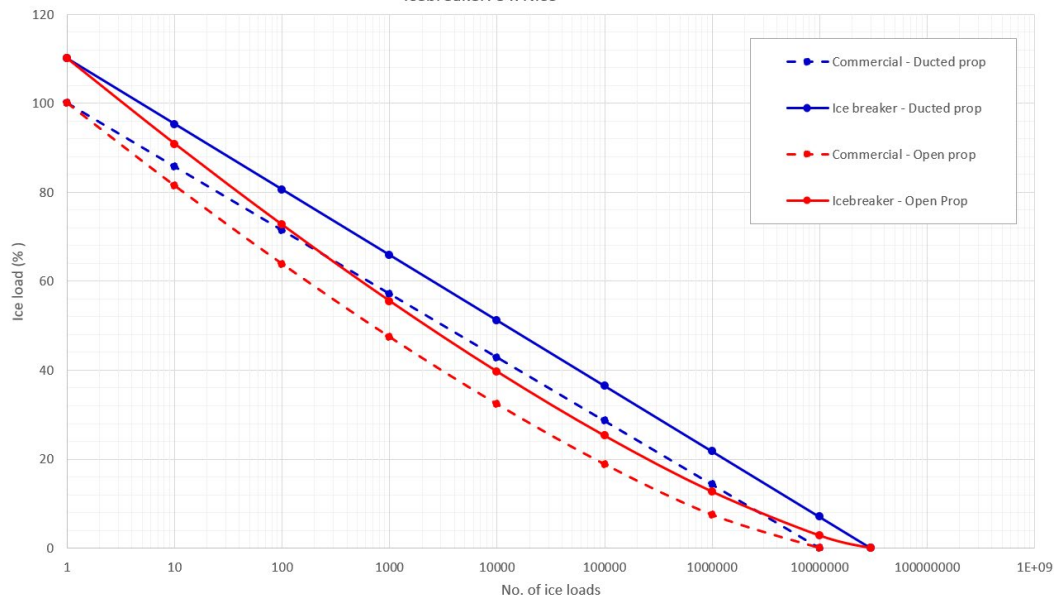
### Transforming ice loads from commercial vessels to Icebreaker

Nice = 2E6 (Low value)  
Icebreaker: 3 x Nice



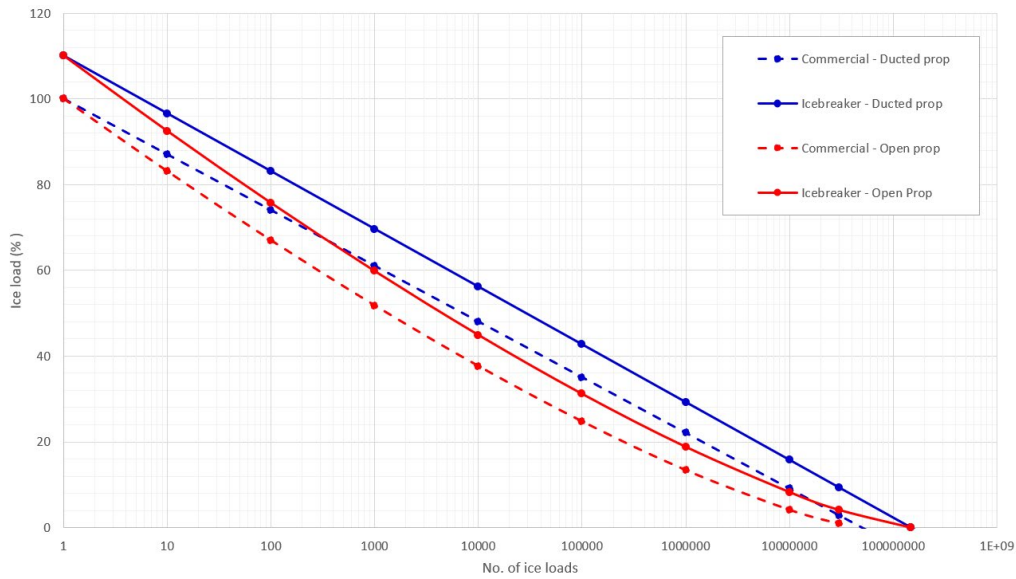
### Transforming ice loads from commercial vessels to Icebreaker

Nice = 1E7 (Medium value)  
Icebreaker: 3 x Nice



## Transforming ice loads from commercial vessels to Icebreaker

Nice = 5E7 (High value)



The above figures show that with this simplified approach a reasonably consistent increase in number of loads is seen on all load levels.

### Conclusive remark

Based on the documentation available a 10% increase in forward blade bending ice load can be justified for icebreakers. As a simplified approach, it seems reasonable to increase number of corresponding ice loads with a factor of 3.



## 1 Background

The Project Team has been tasked with extending the current draft of IACS UR I3 to incorporate requirements also for Icebreakers. An effort has been made to identify which parts of propulsion plants that need addressing.

## 2 Suggested changes and considerations to rule requirements

### 2.1 Blade loads

#### 2.1.1

Blade loads are assumed to be higher for icebreakers, and the original loads forming basis for the  $F_f$  and  $F_b$  loads in UR I3 were taken from full scale measurements on Icebreakers. These loads were then scaled down to fit merchant vessels. Unfortunately, the original measurement data from the icebreakers are no longer available, meaning another way to scale the loads back up may be needed. There is however information in the Technical Background Document 'Propeller ice loads' indicating that the reduction in ice loads is around 10% from the original icebreaker loads. It is suggested to increase the loads for icebreakers by 20%. Half of this is justified by the above mentioned original reduction. The rest is to account for statistical variations in that an increase in load cycles (see 2.2 below) also increases the statistical probability that the peak load experienced during the vessel's lifetime will be higher.

**Feedback from the PT members:** two members have agreed to 20%, and one member has agreed to the initial 10% subject to further increase if detailed justification can be made.

**Conclusion of the PT:** It is concluded that a preliminary increase of 10% is agreed. Further effort will be put into justifying additional increase.

#### 2.1.2

The two blade loads  $F_f$  and  $F_b$  are assumed to originate from two different phenomena;  $F_b$  from ice bending the blade backwards and  $F_f$  from a vacuum forming between blade and ice, bending/pulling the blade forward. As the load originating from vacuum is assumed to not be affected by the change of the vessel's service,  $F_f$  will not be increased for icebreakers.  $F_b$  is however assumed to be affected, as this is a direct contact load between ice and blade.

**Feedback from the PT members:** all members have agreed.

**Conclusion of the PT:** It is agreed that only backward blade load is increased for icebreakers.

#### 2.1.3

The next question would be to determine if this increase in blade loads should apply to both open and ducted propellers. According to the technical background document for propeller ice loads, the backward blade loads for ducted propellers increase as for open propellers up to an ice thickness corresponding to about 25% of propeller diameter. For this reason, the limit diameter for ducted propellers is set to  $4 \cdot H_{ice}$  (giving  $H_{ice} = D/4$ ). Considering this, it would make sense to increase the icebreaker backward blade load for ducted propellers as for open propellers for  $D < D_{limit}$ . Considering that  $H_{ice}$  for PC vessels ranges from 1.5 to 4 m,  $D_{limit}$  for a PC(7) vessel is already at 6 m and  $D_{limit}$  for a PC(4) vessel is 10 m. Consequently, there are very few PC vessels for which the actual propeller diameter will exceed  $D_{limit}$ . For this reason, one could conclude that there is no reason to distinguish

between blade loads for propellers above or below  $D_{limit}$ , and thus increase the load by the same factor regardless of diameter.

**Feedback from the PT members:** no objections have been raised to the understanding that blade loads for both ducted and open propellers shall be affected, but one PT member has disagreed to disregarding ducted propellers exceeding  $D_{limit}$ .

**Conclusion of the PT:** The PT seems to agree that blade loads for both open and ducted propellers shall be increased for icebreakers. Disregarding the (assumably very small number of) vessels with ducted propellers above  $D_{limit}$  was only intended as an effort to simplify the rule text, and as there is not a consensus within the PT, this will not be done. Increase in blade load will also affect propellers above  $D_{limit}$ .

#### 2.1.4

It should be considered if the ice strength index should be increased for ice classes PC(2) and PC(3) to a level corresponding to PC(1). The reasoning being that all ice classes PC(1) - PC(3) are intended for operation in multi-year ice, and hence the strength index should possibly be the same ( $S_{ice} = 1.2$ ). On the other hand, it may be difficult to argue that this would be different for icebreakers compared to merchant vessels.

**Feedback from the PT members:** two members have disagreed to changing  $S_{ice}$  for icebreakers, while one member has agreed. The latter member has also suggested that the procedure of alternative design may be applied if project specific ice strength shall be used.

**Conclusion of the PT:** It is concluded that ice strength index is not to be affected by vessel service, and consequently  $S_{ice}$  will remain unchanged for icebreakers. Perhaps a future update of UR I3 could consider the plausibility of this factor with respect to intended operational areas for vessels vs. typical ice strength.

## 2.2 Loads and no. of cycles

### 2.2.1 Load cycles

It is assumed that icebreakers will operate more often, and more vigorously in ice compared to merchant vessels. Following this assumption, they will accumulate a higher number of load cycles on the propulsion machinery during their lifetime than merchant vessels with the same ice class. Consequently, the parameter  $N_{ice}$  may need to be increased for icebreakers, and a factor of 2 or 3 is suggested.

**Feedback from the PT members:** two members have agreed in principle while another member has, agreeing to the increase, tried to include a detailed approach.

**Discussion by the PT:** It is established that a higher number of load cycles is very relevant but that finding a proper technical justification is challenging. In this situation, a possible way forward is to increase the number of cycles by a moderate factor. Another way is to find alternative justification the suggested approach (See below).

*The difference in  $N_{ice}$  for neighboring PC classes of merchant vessels is about 25-30%, and for icebreaker's classes the same difference may be kept, I suppose.*

*If we will be able to appreciate even one correspondence between operational conditions of any PC class of merchant vessel and any PC class of icebreaker it will be easy to complete the full table for  $N_{ice}$ , like table below which is prepared in assumption that number of cycles of icebreaker of PC7 category will be close to merchant vessel of PC3 class one.*

	<i>merchant</i>	<i>approximate difference</i>	<i>icebreaker</i>	
<i>PC1</i>	$21 \times 10^6$	$123\%PC2$	$55 \times 10^6$	<i>previous value is increased for coefficient from 3-rd column</i>
<i>PC2</i>	$17 \times 10^6$	$115\%*PC3$	$45 \times 10^6$	
<i>PC3</i>	$15 \times 10^6$	$115\%*PC4$	$39 \times 10^6$	
<i>PC4</i>	$13 \times 10^6$	$120\%*PC5$	$34 \times 10^6$	
<i>PC5</i>	$11 \times 10^6$	$125\%*PC6$	$28 \times 10^6$	
<i>PC6</i>	$9 \times 10^6$	$150\%*PC7$	$22 \times 10^6$	
<i>PC7</i>	$6 \times 10^6$		$15 \times 10^6$	<i>same as merchant PC3</i>

**Conclusion of the PT:** A consensus was not obtained on how to link a PC class to the corresponding icebreaker PC class, although this would be a possible way forward. Instead an approach of linking increase in load cycles to increase in blade load using statistical methods was investigated. The approach is explained in document “Ice load  $F_b$  - increase in no of cycles for icebreakers”.

### 2.2.2 Weibull factor for ice load spectrum

Another consideration is that the magnitude of the less frequent load cycles experienced by icebreakers may in general be higher, arguing that perhaps the Weibull shape parameter should be different for this type of vessels (currently, shape factor is  $k=0.75$  for open propellers and  $k=1.0$  for ducted propellers). There is however currently no concrete suggestion for what this new parameter should be.

**Feedback from the PT members:** two members have acknowledged relevance of k-factor but have expressed their view that it is challenging.

**Conclusion of the PT:** Technical background for selection of k-factors seems not to be available, and unless any of the PT members have experience with this type of studies it is deemed a too complicated matter to solve with the limited resources available to the PT. If both the maximum load and the number of cycles are increased this will lift the S-N curve and thereby account for some additional higher loads with low occurrence. Changing the Weibull k-factor will therefore not be considered further.

## 2.3 Shafting

### 2.3.1 Torsional loads

Ice induced torsional loads for shaft lines follows a formula which is independent of blade loads ( $F_b$ ,  $F_i$ ), e.g.:

$$10.9 \cdot \left(1 - \frac{d}{D}\right) \cdot \left(\frac{P_{0.7}}{D}\right)^{0.16} \cdot (n \cdot D)^{0.17} \cdot D^3 \text{ [kNm]}$$

The rule torsional loads will hence not be affected by icebreaker duty, unless the formulas for  $Q_{\max}$  are changed. One could also consider to increase the ice milling duration ( $N_Q = 2 \cdot H_{\text{ice}}$ ) to reflect the assumed operational conditions for icebreakers.

**Feedback from the PT members:** one PT member has disagreed to differentiating between icebreaker and merchant ships, and another member has, while agreeing in principle to the logic of increasing duration of ice milling, expressed its view that the technical justification may be a challenging process.

**Conclusion of the PT:** Most of the measurement data used in the development of UR I3 has been done on icebreakers, and there is no evidence in the TB documents that a downscaling of the shaft

loads has been done to better fit merchant vessels. It is therefore thought that the formulas may be applicable also to icebreakers in their current form.

2.3.2 Thrust loads

In the current rules, and similarly in the FSICR, design ice thrust loads are derived directly from the blade loads. As the blade loads are likely to be increased for icebreakers, the thrust loads will follow. Suggested approach is to let the thrust loads remain unchanged for icebreakers.

**Feedback from the PT members:** all members have agreed.

**Conclusion of the PT:** It is concluded that thrust loads will remain unchanged for icebreakers

2.4 Steering gear

Requirements for steering gear turning speeds for icebreakers are already included in UR I3.13.4. These requirements seem to have been made having conventional rudders in mind. Would the same requirements be applicable to azimuthing propulsors?

**Feedback from the PT members:** reference to UI SC242 has been suggested by two members.

**Discussion by the PT:** The turning speeds in question refer to when the rudder is forced to the side by a large external force (in this context; primarily by going astern into an ice ridge), and the torque relief arrangements needed to protect the steering gear and rudder stock. The current draft UR I3 already specifies additional requirements for icebreakers, wherein a secondary, high capacity relief arrangement is required. The requirement seems to be written for conventional rudders with hydraulic steering gears, and the question remains if this should also be addressed for azimuthing propulsors, which these days are frequently delivered with electric steering gears? The rule text can also remain as it is, leaving the interpretation for electric steering gears to each Society.

I3.13.4 Additionally, for ice breakers fast acting torque relief arrangements (acting at 15% higher pressure than set pressure of safety valves) are to be fitted in order to provide effective protection of the rudder actuator in case of the rudder being pushed rapidly hard over against the stops. The turning speeds to be assumed for each ice class are shown in Table 18 below.

The arrangement is to be designed such that steering capacity can be speedily regained.

Ice Class	PC1-2	PC3-5	PC6 – 7
Turning speeds [deg/s]	40	20	15

Table 18: Steering gear turning speeds for ice breakers

**Conclusion of the PT:** The text in I1.13.4 will be updated to clarify the intention behind the additional torque relief arrangement. Additionally, text will be added to address non-hydraulic steering gear. Azimuth units will not receive special attention, as it is assumed they will be turned by the ice in the same manner as rudders.

# IACS

INTERNATIONAL ASSOCIATION OF CLASSIFICATION SOCIETIES LTD.  
PERMANENT SECRETARIAT: 36 BROADWAY, LONDON, SW1H 0BH, UNITED  
KINGDOM

TEL: +44(0)207 976 0660 FAX: +44(0)207 808 1100  
INTERNET: [permsec@iacs.org.uk](mailto:permsec@iacs.org.uk) Web Site: [www.iacs.org.uk](http://www.iacs.org.uk)

---

July 2009

## History Files (HF) and Technical Background (TB) documents for URs concerning Propellers (UR K)

Res. No.	Title	Current Rev.	HF/TB?
UR K1		Deleted <i>Superseded by W24</i>	No
UR K2		Deleted <i>Superseded by W24</i>	No
UR K3	Keyless Fitting of Propellers without Ice Strengthening	Corr.2 June 1998	No

# IACS

INTERNATIONAL ASSOCIATION OF CLASSIFICATION SOCIETIES LTD.

PERMANENT SECRETARIAT: 4 Matthew Parker Street

Westminster, London SW1H 9NP, UNITED KINGDOM

TEL: +44(0)207 976 0660

INTERNET: [permsec@iacs.org.uk](mailto:permsec@iacs.org.uk) Web Site: [www.iacs.org.uk](http://www.iacs.org.uk)

---

Nov 2023

## History Files (HF) and Technical Background (TB) documents for URs concerning Subdivision, Stability and Load Line (UR L)

Res. No.	Title	Current Rev.	HF/TB?
UR L1		Deleted	No
UR L2	Intact stability – Matter of class	Rev.3 Nov 2023	HF
UR L3	Intact stability of tankers during liquid transfer operations	Deleted (May 2001) <i>Re-categorised as Rec.60</i>	TB
UR L4	Closure of Chain Lockers	Corr.2 Feb 2022	HF
UR L5	Computer Software for Onboard Stability Calculations	Rev.4 June 2020	HF

## UR L2 “Intact stability – matter of class”

### Summary

UR L2 requires that class will only be assigned to ships with a length of 24 m and above after demonstrating adequate intact stability. This revision considers the amendments to Resolution MSC.267(85), Intact Stability Code, since revision 2.

### Part A. Revision History

Version no.	Approval date	Implementation date when applicable
Rev.3 (Nov 2023)	24 November 2023	1 January 2025
Rev.2 (Apr 2013)	18 April 2013	1 July 2014
Rev.1 (June 2000)	15 June 2000	-
NEW (1988)	<i>No records</i>	-

#### • Rev.3 (Nov 2023)

##### 1 Origin:

- Based on IACS Requirement (Periodic review of IACS Resolutions)

##### 2 Main Reason for Change:

Since 2013 IMO approved several amendments to the 2008 Intact Stability Code (MSC 267(85)).

##### 3 List of non-IACS Member classification societies contributing through the TC Forum and/or participating in IACS Working Group:

None

##### 4 History of Decisions Made:

The Unified Requirements L2 of 2013 was updated with respect to the amendments made to 2008 INTACT Stability Code. Safety Panel agreed that it would be premature to consider Interim Guidelines on the 2<sup>nd</sup> Generation Intact Stability Criteria.

Discussed by correspondence in the Safety Panel.

##### 5 Other Resolutions Changes

IACS Recommendation 24 Intact Stability was updated with respect to the amendments to the 2008 Intact Stability Code (MSC 267(85)) approved in the last decade.

## **6 Any hinderance to MASS, including any other new technologies:**

None

## **7 Dates:**

Panel Approval:	09 November 2023	(Ref: PS23036cISf)
GPG Approval:	24 November 2023	(Ref: 22183hIGb)

### **• Rev.2 (Apr 2013)**

#### **.1 Origin for Change:**

Suggestion by IACS member

#### **.2 Main Reason for Change:**

Entry into force of the INTERNATIONAL CODE ON INTACT STABILITY, 2008 (2008 IS CODE), IMO RES. Msc.267(85).

#### **.3 List of non-IACS Member classification societies contributing through the TC Forum and/or participating in IACS Working Group:**

None

#### **.4 History of Decisions Made:**

The Form A was approved by the GPG on 9 November 2011.

#### **.5 Other Resolutions Changes**

IACS Recommendation 99 (Recommendations for the Safety of Cargo Vessels of less than Convention Size)

#### **.6 Dates:**

Original proposal: *10 October 2011 Made by: Statutory panel*  
Panel Approval: *14 March 2013 (Statutory panel)*  
GPG Approval: *18 April 2013 (Ref. 11160\_IGf)*

### **• Rev.1 (June 2000)**

WP/SSLL submitted a draft Rev.1 UR L 2 to GPG 48 for approval with its progress report on 14/1/2000. The revision was approved by GPG 48.  
See TB document in Part B.

### **• NEW (1988)**

No TB document available.



## Part B. Technical Background

List of Technical Background (TB) documents for UR L2:

Annex 1. **TB for Rev.1 (June 2000)**

See separate TB document in Annex 1.



Annex 2. **TB for Rev.2 (April 2013)**

See separate TB document in Annex 2.



Annex 3. **TB for Rev.3 (Nov 2023)**

See separate TB document in Annex 3.



## Technical Background for Rev.1 UR L2

### 1. Objective and Scope

The objective for this revision of UR L2 had been to update the reference to the IMO resolution pertaining to intact stability standards which is revised and amended since the last update of this UR.

### 2. Source of Proposed Requirements

The requirements pertaining to intact stability for types of ships covered by IMO instruments are contained in IMO Resolution A. 749(18) amended by Resolution MSC.75(69).

### 3. Points of Discussion

During the 35<sup>th</sup> meeting the question was raised within WP/SSLL whether in the context of UR L2 the existing reference to superseded IMO Res. A.167 should be updated to refer to IMO Res. A.749 instead. Members agreed not to increase the class requirements on intact stability and consequently decided to make reference to only those chapters of Res. A.749 which had already been part of Res. A.167.

\* \* \* \* \*

Technical Background UR L2.doc/10/5/00 by WP/SSLL Chairman

## Technical Background for UR L2 Rev.2, Apr 2013

### 1. Scope and objectives

IACS Unified Requirement L2 requires all new ships with a length of 24 m and above to be assigned class only after it has been demonstrated that their intact stability is adequate for the service intended.

### 2. Engineering background for technical basis and rationale

The discussion among PT members dealt with the possible applicability to ships having a length of less than 24 m, and all members have the same opinion that this UR should apply to vessel having a length of 24 m or greater. In case of classified vessel having a length of less than 24 m, flag requirements should be applied. Where there are no flag requirement IACS may apply class requirement where specified, 2008 IS Code or other recognized industry standard.

### 3. Source/derivation of the proposed IACS Resolution

The requirements for Intact Stability are covered in depth by the INTERNATIONAL CODE ON INTACT STABILITY, 2008 (2008 IS CODE), IMO RES. Msc.267(85) entered into force on 1 July 2010.

The mandatory requirements included in Unified Requirement L2 are those pertaining PART A of the IMO RES. Msc.267(85).

### 4. Summary of Changes intended for the revised Resolution:

#### Removals

1. Reference to IMO Resolution A.749(18), chapters 3.1, 3.2 and 4.1 as amended by MSC Resolution 75(69) has been removed.

#### Additions

1. Reference to Part A of IMO Resolution MSC.267(85) has been included

2 The sentence "**Where other criteria are accepted by the Administration concerned, these criteria may be used for the purpose of classification.**" has been added in order to allow IACS to use criteria included in Part B of the 2008 IS Code or other standards as an alternative to the requirements of Part A if accepted by the Flag Administration.

### 5. Points of discussions or possible discussions

See Para 2.

### 6. Attachments if any

None

## **L 3 Intact stability of tankers during liquid transfer Operations**

(Deletion in May 2001)

### **Technical Background**

#### **a) Objective/Scope**

The objective was to deal with different level of implementation of L 3 by Members.

#### **b) Points of Discussion**

Experience has shown that tankers with wide tanks can have severe intact stability problems during loading and unloading procedures (lolling effects). To prevent pollution from such effects, MARPOL I/Reg.25A requests oil tankers of 5000 DWT and above to meet minimum intact stability requirements in port.

Noting this as a hazard to all kinds of tankers but not only oil tankers, WP/SSLL was tasked to develop a corresponding UR. To ensure sufficient intact stability during loading and unloading L 3 requires a minimum GM of 0.15 m in harbour conditions, to be ensured by design only or by detailed instructions for planning of loading and unloading. L 3 Rev.1 was applicable to all tankers not subject to MARPOL I/Reg.25A.

However, LR did not accept L 3 as there was no mechanism within their Society to make a UR concerning stability part of LR Rules until IMO makes it a statutory requirement.

#### **c) GPG discussion**

- 1) GPG Chairman instructed WP/SSLL to review L 3 implementation status on 7 October 1998.

WP/SSLL reported back to GPG 45 (October 1998) that :

- (i) Group 1: either implemented L 3 to a large extent or completely;
- (ii) Group 2: not implemented or not intending to implement L 3 to a larger extent than was covered by MARPOL I/25A.
- (iii) Group 3: fully implemented L 3 or intending to implement L 3.

- 2) Though GPG agreed to downgrade L 3 to REC 60, it has been put aside to discuss how to apply para.6.2 of Internal Information No. 15 – indication of Members who were implementing L3 and those not.

- 3) Finally, GPG/Council agreed that L3 be downgraded to Recommendation 60 on 18 May 2001.

\* \* \* \* \*

## **Technical Background (TB) document for UR L2 (Rev.3 Nov 2023)**

### **1. Scope and objectives**

Refer to Rev.2

### **2. Engineering background for technical basis and rationale**

Refer to Rev.2

### **2a. Specification of the data utilised in the development/revision of the proposed IACS Resolution, if any**

None

### **3. Source/derivation of the proposed IACS Resolution**

None

### **4. Summary of Changes intended for the revised Resolution:**

The 2008 INTACT Stability Code has been amended in the last decade and UR L2 has been amended with references to these.

### **5. Points of discussions or possible discussions**

The consideration of the Interim Guidelines on the 2<sup>nd</sup> Generation Intact Stability Criteria was discussed (MSC.1/Circ.1627). It was agreed that it is premature to consider this IMO instrument for the time being and further experience should be gained first.

### **6. Attachments if any**

No attachment

## UR L4 “Closure of Chain Lockers”

### Summary

Following the 10<sup>th</sup> Anniversary review, Corr.2 has been prepared to update the standards which are referenced in the UR.

### Part A. Revision History

Version no.	Approval date	Implementation date when applicable
Corr.2 (Feb 2022)	17 February 2022	-
Corr.1 (Aug 2011)	23 August 2011	-
Rev.3 (Mar 2011)	22 March 2011	1 January 2012
Rev.2 (Nov 2005)	2 November 2005	-
Rev.1 (July 2003)	29 July 2003	-
NEW (Nov 2002)	14 November 2002	1 July 2003

#### • Corr.2 (Feb 2022)

##### 1 Origin of Change:

- Other: 10<sup>th</sup> Anniversary Review

##### 2 Main Reason for Change:

During the 10<sup>th</sup> Anniversary review it was noted that some of the standards referenced in the UR were out of date.

##### 3 List of non-IACS Member classification societies contributing or participating in IACS Working Group:

None

##### 4 History of Decisions Made:

The Safety Panel discussed the UR by correspondence. Some debate was made about the use of butterfly nuts for a protection cover of a quick release mechanism of an anchor, which was finally not agreed by the panel for safety reasons. It was only concluded to update the referenced outdated standards or indicate their version information in the UI.

##### 5 Other Resolutions Changes:

None

##### 6 Any hinderance to MASS, including any other new technologies:

None

## 7 Dates:

Original Proposal : 22 October 2021 (Made by IACS member)  
Panel Approval : 31 January 2022 (Ref: PS21015bISg)  
GPG Approval : 17 February 2022 (Ref: 21197\_IGd)

### • **Corr.1 (Aug 2011)**

#### **.1 Origin for Change:**

- Suggestion by an IACS member

#### **.2 Main Reason for Change:**

To reinstate the examples of acceptable closing arrangements of spurling pipes, which was inadvertently deleted during the last revision.

#### **.3 List of non-IACS Member classification societies contributing through the TC Forum and/or participating in IACS Working Group:**

None

#### **.4 History of Decisions Made:**

The correction was originally initiated by an IACS member and drafted by PermSec.

#### **.5 Other Resolutions Changes**

None

#### **.6 Dates:**

Original proposal: 5 August 2011 Made by: An IACS member  
GPG Approval: 23 August 2011 (Ref.11137\_IGb)

### • **Rev.3 (Mar 2011)**

#### **.1 Origin for Change:**

- Other (Based on Vessel Incident: Port state inspections found some instances where access openings on chain lockers could not be demonstrated as being watertight)

#### **.2 Main Reason for Change:**

To clarify requirements for access openings below the weather deck on spurling pipes and chain lockers.

**.3 List of non-IACS Member classification societies contributing through the TC Forum and/or participating in IACS Working Group:**

None

**.4 History of Decisions Made:**

The revision was originally initiated by an IACS member and drafted through discussions and email correspondence within the Hull Panel. Version approved by the Hull Panel was sent to the Statutory Panel for review and concurrence. Final version drafted by the Statutory Panel after discussions and further revisions by the Statutory Panel.

**.5 Other Resolutions Changes**

None

**.6 Dates:**

Original proposal: 1 July 2010 Made by: An IACS member  
Panel Approval: 11 August 2010 (Hull Panel); 18 Feb 2011 (Statutory panel)  
GPG Approval: 22 March 2011 (Ref. 11047\_IGc)

- **Rev.2 (Nov 2005)**

Refer to TB document in Part B Annex 3

- **Rev.1 (July 2003)**

Refer to TB document in Part B Annex 2

- **New (Nov 2002)**

Refer to TB document in Part B Annex 1



## **Part B. Technical Background**

List of Technical Background (TB) documents for UR L4:

Annex 1. **TB for New (Nov 2002)**

See separate TB document in Annex 1.

Annex 2. **TB for Rev.1 (July 2003)**

See separate TB document in Annex 2.

Annex 3. **TB for Rev.2 (Nov 2005)**

See separate TB document in Annex 3.

Annex 4. **TB for Rev.3 (March 2011)**

See separate TB document in Annex 4.

Annex 5. **TB for Corr.2 (Feb 2022)**

See separate TB document in Annex 5.

*Note: There is no separate Technical Background (TB) document for Corr.1 (Aug 2011).*

**Technical Background Document**  
**WP/SSLL**  
**UR L4, New 2002**

The Working Party on subdivision, stability and load lines has been tasked to develop a UR to ensure watertightness of chain lockers. At the same time the IMO subcommittee SLF introduced such a requirement in the revised annex for the 1988 Load Line Protocol.

The WP agreed unanimously that this requirement meets all criteria considered necessary by the WP in their previous deliberations on this issue as there are the pressure height to be assumed and the closure of access opening to the chain locker by means of a cover secured by closely spaced bolts, as also advised by GPG in the actual Work Programme of the WP/SSLL.

However, due to the situation that not all new-build ships are built under the provisions of the 1988 Protocol a UR covering the remaining ships remains necessary. The WP agreed to use the same wording used in the IMO text amended by a respective application paragraph.

Date of Submission: 25 Sept 2002  
Permanent Secretariat

### **UR L4 Rev.1 Closure of chain lockers**

ABS raised the question of clarification of acceptable means of closure, having been presented with arrangements that vary from canvas hoods with tie-downs to split steel plates that cover the spurling pipe while accommodating the presence of the chain to minimize the ingress of water to the chain locker.

GPG concurred that a footnote should be added and approved the text as follows:

"(\*) examples of acceptable arrangements are such as:

- i.) steel plates with cutouts to accommodate chain links or
- ii.) canvas hoods with a lashing arrangement that maintains the cover in the secured position".

Permanent Secretariat 17 July 2003

## UR L4 (Rev.2, Nov 2005)

### Technical background

#### TB

The text of existing UR L4 (rev. 1) cannot be read otherwise than the separation of the cable (chain) lockers should be watertight. The approval practice that is established for supply vessels is not in accordance with this UR. Therefore, it was proposed that the text should be changed so it would be clear that only the cable (chain) locker as a whole is to be made watertight, and that common boundary between, or separating, adjacent cable (chain) lockers need not be watertight.

Submitted by Statutory Panel Chairman  
14 Sept 2005

#### **Permsec's Note** (Implementation Date)

The Statutory Panel Chairman proposed that if GPG would consider it necessary to indicate an implementation date, considering the practice in place and that the modifications carried out do not modify its technical essence, the UR might be applied uniformly as soon as it is adopted by the Council.

GPG decided that an implementation date for this revision is not needed.

Council approved UR L4(Rev.2) on 1 Nov 2005 (5030dICa).

## **Technical Background for UR L4 Rev.3, Mar 2011**

### **1. Scope and objectives**

To clarify watertight standard applicable to access openings situated below the weather deck on spurling pipes and chain lockers.

### **2. Engineering background for technical basis and rationale**

Access openings situated below the weather deck on spurling pipes and chain lockers are to be watertight. There have been instances of inspections of the chain locker by port state authorities where the access cover and its fittings on the chain locker could not be demonstrated as being watertight.

The text of the UR is therefore being modified to explicitly state requirements for access openings below the weather deck.

### **3. Source/derivation of the proposed IACS Resolution**

The source of the information was obtained through input from the Hull Panel and Statutory Panel.

### **4. Summary of Changes intended for the revised Resolution:**

New text covering requirements in 2. above have been introduced in this revision.

### **5. Points of discussions or possible discussions**

The revisions were made through discussions and email correspondence separately within the Hull Panel and Statutory Panel, which involved incorporating individual comments and accepting the consolidated text.

### **6. Attachments if any**

None

## **Technical Background (TB) document for UR L4 (Corr.2 Feb 2022)**

### **1. Scope and objectives**

UR L4 reached its 10<sup>th</sup> Anniversary and needed to be reviewed to ensure its continued applicability.

### **2. Engineering background for technical basis and rationale**

Reference was made to ISO 24059(2021) during discussion.

### **3. Source/derivation of the proposed IACS Resolution**

See section 5 "Points of discussions or possible discussions"

### **4. Summary of Changes intended for the revised Resolution:**

Only the referenced standards were updated.

### **5. Points of discussions or possible discussions**

During the review one Safety Panel members questioned whether butterfly nuts could be accepted to secure the cover to the anchor quick release in accordance with ISO 24059 (2021).

The Panel discussed the possibility and the risk mitigation measures which might be used – additional damage stability calculations and/or alarm to warn when the cover was not properly secured. Neither of these risk mitigation measures was supported.

Concerns were raised that permitting butterfly nuts on the cover of the anchor quick release would not be in accordance with the existing text of the UR.

In addition ILLC 1966 + 1988 Protocol as amended, Regulation 22-2 states that "Where means of access are provided, they shall be closed by a substantial cover and secured by closely spaced bolts." Although this could be taken to only refer to access for personnel, it would be potentially confusing to permit butterfly nuts for one opening and not for the other.

A majority of the Safety Panel decided that butterfly nuts would not be acceptable to secure the cover to the anchor quick release mechanism.

The Safety Panel concluded that no changes to the text would be made other than for the updates to the standards.

### **6. Attachments if any**

None

## UR L5 “Computer Software for Onboard Stability Calculations”

### Summary

There was uncertainty about the need to model both sides of a ship in a Type 3 program. This has now been clearly included in paragraph 4.1.3 of the UR.

### Part A. Revision History

Version no.	Approval date	Implementation date when applicable
Rev.4 (June 2020)	24 June 2020	1 July 2021
Rev.3 (June 2017)	27 June 2017	1 July 2018
Corr.1 (Nov 2006)	November 2006	-
Rev.2 (Sept 2006)	September 2006	January 2007
Rev. 1 (Feb 2005)	February 2005	1 July 2005
New (May 2004)	May 2004	1 July 2005

- **Rev. 4 (June 2020)**

**.1 Origin of Change:**

- Suggestion by IACS member

**.2 Main Reason for Change:**

- To clarify that the pre-defined relevant damage cases of a Type 3 software shall contemplate both sides of the ship.

**3 List of non-IACS Member classification societies contributing through the TC Forum and/or participating in IACS Working Group:**

None

**4 History of Decisions Made:**

One Panel Member asked the Panel views regarding pre-programmed damage cases of Type 3 software. The Member pointed out that for Type 3 software pre-programmed damage cases may be provided for only one side of the ship assuming that the Master can confirm compliance with damage stability requirements by carrying out the calculation twice to assess, for instance, unsymmetrical loading condition on the other side of the ship.

The Member considered that IACS UR L5 does not require damage cases to be pre-programmed for both sides of the ship and international conventions do not require mandatory application of MSC.1/Circ.1461.

The above understanding was not supported by the Panel. The qualified majority agreed that since vessels can have asymmetric compartmentation, an initial list in loaded conditions, or asymmetric loading, it is necessary that Type 3 software be pre-programmed with damages on both sides of the ship. Members also agreed that this understanding can be clearly read in MSC.1/Circ.1461. An additional clear reference was found in the UK MCA Marine Guidance Note (MGN) 611 (M) "Damage Stability: Alternative verification method for tankers" where previously the Panel had completed a review task upon UK MCA request.

Based on the above, the Panel decided to introduce a clarification into § 4.1.3 to avoid misinterpretations of the requirement.

## **5 Other Resolutions Changes:**

None

## **6 Any hinderance to MASS, including any other new technologies:**

None

## **7 Dates:**

Original Proposal:	3 February 2020 made by Safety Panel Member
Panel Approval:	3 June 2020 (Ref: PS20007_Isi)
GPG Approval:	24 June 2020 (Ref: 20096_IGb)

## **• Rev.3 (June 2017)**

### **.1 Origin of Change:**

- Suggestion by IACS member
- Based on IMO Regulation

### **.2 Main Reason for Change:**

- To eliminate the vague expressions to prevent different applications by Societies (Task 36)
- To amend the UR L5 with the definition and technical specification of a new Type 4 for SRtP software (Task 37)

### **.3 List of non-IACS Member Classification Societies contributing through the TC Forum and/or participating in IACS Working Group:**

None



#### **.4 History of Decisions Made:**

##### Task 36:

The discussion within the panel was started on the uniform applicability of UR L5; it dealt with several aspects of such UR. In particular it was agreed by the majority that the following actions were necessary:

- to achieve a common understanding on the wording "1%/50cm max"; and
- to review UR L5 in order to eliminate the vague expressions to prevent different applications by Societies.

Following to the outcome of SLF 53, as per the PA in Rec.3.1 of IACS Observer Report, the Statutory Panel has been requested to specify the output data to be provided by Type 3 software for SRtP, taking into account the suggested output as per IACS UR L5 and the proposal amendments to SOLAS Regulation II-1/8-1. This issue has been included in the task relevant to the revision of the UR L5.

##### Task 37:

The task comes out from the discussion within the Statutory Panel with the aim of amending the UR L5 with the definition and technical specification of a new Type 4 for SRtP software on the basis of the discussion comments carried out within SP.

#### **.5 Other Resolutions Changes**

None

#### **.6 Dates:**

Original Proposal: 05 June 2012      Made by Safety Panel Chairman  
Panel Approval: 14 April 2017 (Ref: SP13015h)  
GPG Approval: 27 June 2017 (Ref 11160\_IGo)

- **Corr.1 (Nov 2006)**

Refer to Annex 4 in Part B.

- **Rev.2 (Sept 2006)**

Refer to Annex 3 in Part B.

- **Rev.1 (Feb 2005)**

Refer to Annex 2 in Part B.

- **New (May 2004)**

Refer to Annex 1 in Part B.

\*\*\*\*\*

## Part B. Technical Background

List of Technical Background (TB) documents:

Annex 1. **TB for New (May 2004)**

See separate TB document in Annex 1.



Annex 2. **TB for Rev.1 (Feb 2005)**

See separate TB document in Annex 2.



Annex 3. **TB for Rev.2 (Sep 2006)**

See separate TB document in Annex 3.



Annex 4. **TB for Corr.1 (Sep 2006)**

See separate TB document in Annex 4.



Annex 5. **TB for Rev.3 (June 2017)**

See separate TB document in Annex 5.



Annex 6. **TB for Rev.4 (June 2020)**

See separate TB document in Annex 6.



## TECHNICAL BACKGROUND

### UR L 5 (New, 2004)

#### 1. Objective and Scope

UR L5 is an IACS Unified Requirement addressing minimum requirements for the approval of onboard software and hardware used for stability calculations.

Basing on the analysis of the of existing IACS Resolutions and other guidelines containing requirements for onboard computers, this UR provides minimum requirements for software and hardware used for stability calculations onboard of a ship.

The UR is applicable to new installations and covers passive systems and the off-line operation mode of active systems only. Requirements related to on-line interface for active systems, for instance remote tank sounding or draught reading, are not covered by this UR. The use of automatic data input by means of e.g. automatic draft reading systems is explicitly exempted from this UR. Systems taking any kind of active control are also exempted.

#### 2. Source of Proposed Requirements

<b>Onboard Computer for Stability Calculation</b>	
<b>Paragraph</b>	<b>Source</b>
1. General Item 2	- Similar to Rec. 48 Paragraph 1.3 - Res. MSC.75(69) Amendments to Res. A.749(18) Paragraph 2.2.1
Item 3	- Res. MSC.75(69) Amendments to Res. A.749(18) Paragraph 2.2.2
Item 6	- UR S1 Paragraph S1.2.3
6. Approval Procedure 6.1 General Approval 6.2 Specific Approval	- UR S1 Paragraph S1.2.3 - Rec. 48 Paragraph 2.2.3 - Rec. 48 Paragraph 2.1.1 thru 2.1.6
7. Operation Manual Item 2, 3, 7,	- Res. MSC.75(69) Amendments to Res. A.749(18) Paragraph 2.2.3 - MSC/Circ.891 Paragraph 5.1.3
9. Periodical Testing	- Res. MSC.75(69) Amendments to Res. A.749(18) Paragraph 2.2.4 - UR S1 Paragraph S1.1.3
10. Other Requirements	- MSC/Circ.891 Paragraph 3.1.6 - MSC/Circ.891 Paragraph 4.3.2

#### 3. Points of Discussion

- Experience has shown, that results of several onboard stability calculation programs are different from those documented in the stability booklet. Usually those differences are caused by simplified input data e.g. due to disregarding trim. Therefore great importance should be placed on the question of accuracy.
- The discussion about damage stability calculation concentrated on the question whether an onboard stability calculation program should calculate individual damage calculations for each loading condition or use a limit curve for the

assessment of permissible stability according to requirements of damage stability. It was agreed, that in accordance with SOLAS II-1/Reg. 25-8, damage stability has to be established by using one limit curve without consideration of effects of e.g. differences in trim for a special loading condition.

- Members agreed that the information given by a computer should comprise the information requested by all applicable stability requirements.
- A further important issue covered was the definition of active vs. passive systems and, as a result, the judgement of stability software to be regarded as "safety related" or "safety critical". Members current practice in this concern seems to be differing: some members classify a system using online input data as safety critical, others assess a system safety critical that actively controls or initiates actions (i.e. loading or tank filling/ discharging operations).
- The question of performing rigorous damage stability calculation was raised. It was proposed to distinguish two software kinds: a) systems calculating directly and b) systems verifying damage stability requirements by means of a KG/GM limit curve. The latter might be treated as a variation of those covering intact stability calculating only.
- A discussion was held on *Hardware* and the question whether a system of two nominated computers and the approved software can be considered as acceptable in view of the amendments to the IS Code, requesting approved hard and software. The WP confirmed the view that both, a system meeting the requirements to have two nominated computers available or one approved computer, can be considered as an "approved system" according to the amended IS Code.

#### 4. Decision by Voting

NK proposed to introduce a paragraph stating that;

*"damage stability calculation software is not required for ships with arrangement given small possibilities for variation in the distribution of cargoes and ballast, and ships on regular and fixed trading pattern where the approved Damage Stability Booklet gives sufficient guidance."*

After a thorough discussion of pro's and con's, a majority of 8 vs 2 Members preferred not to introduce such a paragraph as there were seen different possibilities to cope with the applicable damage stability requirements of such ships within a stability software in a quite simple manner.

\* \* \* \* \*

With the Work Programme 2003-2004 GPG redirected this task to the Working Group calling for clarifications of the following issues.

- WP/SSLL is to complete the work to address "hardware approval" in direct communication with WP/EL and finalize UR L[5], utilizing the latest version of UR L[5]. The responsibility of finalizing the draft UR L[5] rests with the WP/SSLL.
- The two Chairmen are to review the draft L[5] together before submission to GPG for approval.
- WP/SSLL and WP/EL are to also utilize the draft Inf. Inf. prepared by AHG/COMP in finalizing UR L[5] and incorporate directly or by reference the relevant aspects and requirements for the AHG/COMP's draft Int. Inf.

WP/EL XXV and ADH/COMP's last meeting outcomes have been considered by the WP/SSLL.

It was unanimously agreed that WP should not take any action on correction UR L[5] from stability's point of view. As no specific proposals on hardware approval have been received from WP/EL and bearing in mind that existing IACS UR S1 and UR S1A do not contain any requirements on hardware approval WP/SSLL, taking into account the result of informal discussion on this issue between WP/SSLL and WP/EL Chairmen, unanimously agreed to remove UR L[5] chapter "Hardware approval" and advise GPG accordingly. Draft Int. Inf. elaborated by AHG/COMP should not be taken into account when preparing the latest version of UR L[5] because the Section "Scope" of Draft Int. Inf. contains the following instruction: "For guidance on testing of loading instrument/stability computer software and hardware, refer to REC.No.48".

proposed Implementation date: 1 January 2005

**Technical Background  
for  
IACS UR L5 (Rev.1)**

**1. Objective**

To achieve uniformity among IACS Members in implementing UR L5.

**2. Background**

On 18/09/2004, ABS questioned whether Members intended to apply UR L5 to “software installed after 1 July 2005” as written in L5(version: May 2004). This would effectively mean that L5 apply to software installed after 1 July 2005 on existing ships, ships in construction or future new construction.

**3. Discussion**

**3.1** In response to the ABS enquiry, NK informed as follows (3007bNKd, 21/09/2004):

NK, however, will implement the UR L5 only for new ships the keels of which are laid on or after 1 January 2005 due to following impracticable and unreasonable reasons.

.1 Existing ships

Since stability computer is not required to be onboard up to now, it is much difficult to identify whether ships has the stability computer onboard, when the stability computer was/will be provided on ships and when the software was/will be up-dated.

.2 Ships under construction

There are many ships, which were already initiated to construct before the date of adoption of the UR L5. Many shipbuilders have already purchased/contracted the software not to comply with the new UR L5 for installation after 1 July 2005 on these ships. This implementation scheme will cause such an unreasonable situation to impose replacement of the purchased software by the new type software.

NK, therefore, decided the UR L5 does not apply to stability software on ships constructed before 1 January 2005 with a view to avoiding confusions.

**3.2** In the meantime, WP/SSLL had discussed the same topic and provided the following advice to GPG on 14/10/2004.

1) WP/SSLL agreed by majority that UR L5 shall apply to existing ships as well as new builds. NK representative is of the position that it shall apply only to new builds. Although ABS was not represented at the meeting its position has already been indicated by the ABS GPG Member.

2) It was also agreed by majority that the implementation date shall be the date of shipowner's/software developer's application to the Society for software approval.

3) It was decided that the UR L5 should be applied as it is. The UR can be further reconsidered after the compilation of some practical experiences on its application.

**3.3** This matter was taken up at GPG 57th meeting (Oct 2004) where BV also indicated its intention to make reservation to L5, stating that:

- BV considers that we should not have requirements which cannot be identified/verified by our surveyors.
- BV believes that it is the responsibility of the owners/masters to have an up-to-date equipment.

GPG 57 decided to further consider, in prospect of the IMO Intact Stability Code becoming partly mandatory, how to achieve uniform implementation of UR L5.

**3.4** GL and RS were of the view that UR L5 (May 2004) apply to new *software* only and regulate the approval of the new software, and no serious difficulties in applying L5 to existing *ships* were envisaged.

#### **4. Decision**

Having observed other Members likely to follow NK and BV, GPG finally decided that the application statement of L5 should be amended with a view to achieving uniform implementation by all IACS Societies.

The preamble of L5 was amended to the effect that L5 apply to stability software on ships contracted for construction on or after 1 July 2005.

Submitted by the Permanent Secretariat  
3 Feb 2005

## **UR L5 rev. 2 – Technical Background**

The 1st paragraph of the Preamble of Rev. 1 of UR L5 read “The use of onboard computers for stability calculations is not a requirement of class. However, a stability software installed onboard shall cover all stability requirements applicable to the ship. This UR, which requires both software approval and either hardware approval or the provision of at least two nominated computers, applies to onboard computers which are provided with software capable of performing stability calculations for the vessel.”

The Statutory Panel noted that the requirements applicable to the hardware requirements, which were included in the text of this UR prepared by the former WP/SSLL, had been deleted by GPG56.

The Panel considered that other parts of the UR needed to be editorially revised to remove references to hardware approval in order to eliminate any ambiguity on this aspect.

Editorial modifications have been also introduced in Table 1.

### **GPG discussion**

Approved GPG, without further amendment, 6077cIGb, 1 August 2006.



## Technical Background

### UR L5 (Rev. 2, Corr. 1, Nov 2006) – Onboard Computers for Stability Calculations

- 1) UR L5 (Rev. 2) was adopted by Council in September 2006, however NK in 6077cNKc (attached as Annex 1) raised some concerns that they had received from industry with respect to the implementation of UR L5 (Rev. 2).
- 2) In their email NK proposed amending the last paragraph under the ‘Application’ section to be in line with the previous version of UR L5 and including the implementation statement as a footnote.
- 3) Other options including posting more than one version of the UR on the website were considered by GPG but in the end 8 members agreed to the proposed corrigenda to UR L5 (Rev. 2) and Corrigenda 1 to UR L5 (Rev.2) was therefore adopted by GPG and Council on 17 November 2006.
- 4) Specific comments from members can be seen in the GPG Chairman’s concluding email, 6077cIGd (attached as Annex 2).
- 5) To avoid similar confusion in the future, ABS proposed, and were supported by other members, that it would be preferable to include the application statement for a UR in its "implementation statement" rather than in the text of the UR itself. This information has been forwarded to the Panel Chairmen for their reference.

Prepared by Permanent Secretariat  
23 November 2006

Attached:

Annex 1 – NK message (6077cNKc)

Annex 2 – GPG Chair’s message (6077cIGd)

## **Annex 1**

Date: 30 October 2006

To: Mr. Mo Jianhui, Chairman of GPG

Cc: All GPG Members

Cc: Permanent Secretary

Subject: 6077cNKc: Maintenance of IACS Resolution - UR L5 (SP6011fPCf)

Dear Chairman,

1. Reference is made to UR L5 (rev.2) adopted in September 2006 circulated with IAb of 27 September 2006.
2. I have to apologize for raising this when UR L5 (rev.2) has been adopted, however NK believes that GPG should consider our proposal to resolve misunderstanding of industries.
3. Recently NK has received questions from our clients with respect to the implementation of UR L5 (rev.2). The questions are as to whether onboard stability software in compliance with UR L5 shall be installed on ships contracted for construction on or after "1 July 2005" or "1 January 2007".
4. As far as communication with our clients is concerned, their confusion is caused by the application statement "The requirements in this UR apply to stability software on ships contracted for construction on or after 1 January 2007.", which was changed from "1 July 2005" to "1 January 2007" in the revision of UR L5.
5. They are convinced that UR L5 requires to install onboard stability software on ships contracted for construction on or after "1 July 2005" by our explanations. However, NK has still concerns that our clients who not contact us would continue to have misunderstanding of this issue unless the application statement of UR L5 (rev.2) is revised.
6. Therefore, NK would propose the corrigenda with a view to eliminating possible misunderstanding. The text is attached for your easy reference.

Best regards,

Tetsuya Kinoshita  
NK IACS GPG Member

## **Annex 2**

TO: IACS GPG Members  
CC: Mr. R. Leslie, IACS Perm. Sec.  
Our Ref: G061052

**Subject: 6077cIGd : Maintenance of IACS Resolution - UR L5 (SP6011fPCf)**

1. All members replied to my IGc, with their Council Members; concurrence.
2. 8 members agreed to the UR L5(Corr. 1, xx 2006) as proposed in NKc, while
  - 2.1 GL, in GLb, had no objection to the NK;s proposal, and proposed to keep former versions of revisions on the website to provide easy access to URs applicable to ships built/ or contracted at various dates.
  - 2.2 CCS, in CCc, proposed to post both version of L5 or new version with underline version on the website to avoid the confusion.
  - 2.3 ABS, in ABc, further commented that there is no need to maintain multiple revisions of URs available on the IACS website. However, it would be preferable to include the application statement for a UR in its "implementation statement" rather than in the text of the UR itself and we should keep this in mind going forward. NK and other members have similar position.
3. Having reviewed members; comment on the issue, this is a typical example on how we include the ;implementation statement;± to avoid the mis-interpreted by industry of installation requirement and technical requirement. I do agree ABS comment that we can only post our updated resolution on the Website. However, we should bear in mind that the revision of resolution should not amend the installation requirement if the resolution is only an improvement on technical requirement.
4. I, therefore, conclude that
  - 4.1 the UR L5(Corr. 1, xx 2006), as attached which I incorporated NK proposal into approved Rev.2 of UR L5, is adopted
  - 4.2 Permsec is requested to
    - 4.2.1 typeset the resolution and post it on the Website and circulate to member for implementation and record
    - 4.2.2 prepare the Technical Background document reflecting the discussion at GPG
    - 4.2.3 inform this example to all Panel chairmen for their reference.

Regards,

Mo Jianhui  
IACS GPG Chairman

## Technical Background (TB) document for UR L5 (Rev.3 June 2017)

### 1. Scope and objectives

The use of onboard computers for stability calculations is not a requirement of class.

In passenger ships constructed on or after 1st January 2014, Type 4 stability software is to be provided onboard, in case of not providing shore-based support for safe return to port (SRtP).

However, a stability software installed onboard shall cover all stability requirements applicable to the ship. This UR, which requires only software approval, applies to onboard computers which are provided with software capable of performing stability calculations for the vessel.

### 2. Engineering background for technical basis and rationale

None.

### 3. Source / derivation of the proposed IACS Resolution

The Rev.3 of URL5 was deemed necessary within Statutory Panel in order to solve questions raised on the uniform application within IACS Societies. Furthermore, amendments to SOLAS included in MSC Res.325(90), Ch II-1 Reg 8-1 3) require:

*“For the purpose of providing operational information to the Master for safe return to port after a flooding casualty, passenger ships constructed on or after 1 January 2014 shall have:*

*.1 onboard stability computer; or*

*.2 shore-based support,*

*based on guidelines developed by the Organization”*

Therefore, Statutory Panel established PT 30 in order to fulfill the following Tasks:

Task 36:

The discussion within the panel was started on the uniform applicability of UR L5; it dealt with several aspects of such UR. In particular it was agreed by the majority that the following actions were necessary:

- to achieve a common understanding on the wording “1%/50cm max”; and
- to review UR L5 in order to eliminate the vague expressions to prevent different applications by Societies.

Following to the outcome of SLF 53, as per the PA in Rec.3.1 of IACS Observer Report, the Statutory Panel has been requested to specify the output data to be provided by Type 3 software for SRtP, taking into account the suggested output as per IACS UR L5 and the proposal amendments to SOLAS Regulation II-1/8-1. This issue has been included in the task relevant to the revision of the UR L5.

## Task 37:

The task comes out from the discussion within the Statutory Panel with the aim of amending the UR L5 with the definition and technical specification of a new Type 4 for SRtP software on the basis of the discussion comments carried out within SP.

### 4. Summary of Changes intended for the revised Resolution

- **Application**

The references to the 1966 Load Line Convention or the 1988 Protocol to the Load Line Convention, as amended, the IMO MODU Code and/or the 2008 IS Code, has been added as well as the requirement of a Type 4 stability software for safe return to port (SRtP) of passenger ships in case of not providing shore-based support for safe return to port (SRtP), has been included.

- **Types of stability software**

The Type 2 definition has been modified to allow for two different approaches with respect to the use of the limit curve; furthermore the definition of the new Type 4 dedicated for SRtP has been included.

- 

A new paragraph clearly requiring that Type 3 and Type 4 stability software should be based on hull form models has been included

- **Functional requirements**

This section has been split into two sub-sections:

4.1 General requirements for any type of stability software which includes the minimum requirements common for all the types of stability software and

4.2 Further requirements for Type 4 stability software which includes the minimum requirements dedicated for SRtP purposes.

The Panel agreed that the UR need not specify what the software is "not" required to calculate and, therefore, the following two proposed items were deleted:

- The system is not intended to compute transient asymmetrical flooding whereby the ship could capsize under the immediate inrush of floodwater before there is time for equalization measures to take effect.

- The system is not intended to make any allowance for the motion of the ship in a seaway, including the effects of tide, current or wave action.

The Panel, agreeing that UR L5 should be limited to stability software, and not address the number of PCs required to run that software, concluded that the proposal for at least two independent stability computers should be removed from this revision.

- **Acceptable tolerances**

Table 1 has been revised with the addition of "+/-" before the tolerance values in order to explicitly show that the tolerances should be applied in both directions.

The word "max" after tolerance values in Table 1 has been deleted and footnote 2 has been added to clarify the application when two values are given.

The explication "(both solid and corrected for free surfaces)" has been added to GMT with the aim to clearly indicate the application of this tolerance.

The tolerance for FS correction has been deleted as it is considered as a redundancy for the already present tolerances (having the same value of 2%) for Free surface effect and Displacement.

The definition of the distance of unprotected openings from WL has been clarified.

Three additional notes to Table 1 on the application of tolerances have been introduced in order to achieve a uniform application by IACS Societies

- **Approval Procedure**

Verification of functional requirements under paragraph 4.1.2 has been included.

- **Specific Approval**

The sentence "For Type 4 stability software for SRtP, the Society shall examine at least three damage cases, each of them associated with at least three loading conditions taken from the ship's approved stability information. Output of the software is to be compared with results of corresponding load / damage case in the approved damage stability booklet or an alternative independent software source." has been added.

## **5. Points of discussions or possible discussions**

Task 36:

### **1 Identify to achieve a common understanding on the wording "1%/50cm max"**

1. 1 A common position has been achieved on all the tolerances in Table 1 having double values with the addition of the following note:

When applying the tolerances in Table 1 having two values, the allowable tolerance is the greater of the two values.

1.2 Furthermore the Panel agreed with the PT's recommendation to delete the requirement of the tolerance relevant to FS correction with the following technical justification:

- a) Being the FS correction the ratio free surface moment / displacement, and being the tolerance requested the same value (2%) for displacement, free surface moment, free surface correction, we can conclude that this requirement is redundant, because we already have got the requirement of free surface moment and the requirement of displacement.
- b) While both FS correction and Displacement show, in general, wide values, and therefore the requirement of 2% as tolerance is easily fulfilled, the FS correction show in general a very small value (some centimetres) for which the fulfillment of 2% as tolerance may be very hard.

Due to the above deletion, it was considered necessary to add the clarification "*(both solid and corrected for free surface)*" after GMt.

1.3 After it has been noted that "margin line" has no reference in SOLAS 2009, but URL5 may be applied also to vessel approved under deterministic SOLAS in which margin line is defined, it has been unanimously agreed to amend the existing text in Table 1

"Distance to unprotected openings or margin line from WL, if applicable" with the revised text

Distance from WL to unprotected and weathertight openings, margin line or other relevant point if applicable.

## **2 Review UR L5 in order to eliminate the vague expressions to prevent different applications by Societies.**

At paragraph 5 the second sentence states:

*Deviation from these tolerances shall not be accepted unless the Society considers that there is a satisfactory explanation for the difference and that there will be no adverse effect on the safety of the ship.*

The following questions relevant to the uniform application have been raised:

- 1) What is the technical criteria on the basis of which members shall evaluate when "*..omissis .....there will be no adverse effect on the safety of the ship.*" ?

2) On the basis of what technical considerations an explanation is "satisfactory"?

At paragraph 5.1 the second sentence states:

*Output data tolerances are to be close to zero, however, small differences associated with calculation rounding or abridged input data are acceptable.*

3) What is the limit for considering differences as *small differences*?

At paragraph 5.1 the third sentence states:

*Additionally differences associated with the use of hydrostatic and stability data for trims that differ from those in the approved stability information, are acceptable subject to review by the individual Society.*

4) what is the limit for considering acceptable differences associated with the use of hydrostatic and stability data for trims that differ from those in the approved stability information?

5) in what does the review by the individual Society consist?

After a lengthy discussion the outcome of the majority of the PT members is what has been included as Notes in Table 1, and forwarded to the Panel. The Panel discussed there additional notes and amended the same and the final version as agreed by the Panel is reflected in Rev.3 of the UR.

Furthermore, it has been unanimously noted by PT members that the definition of Type 2 stability software is vague when referring to previously approved loading condition, therefore such wording has been deleted. This was agreed by the Safety Panel which replaced the deleted text with "checking all the stability requirements (intact and damage stability) on the basis of a limit curve."

### **3. Discussion on the conclusion in item 3.2 of PCf (how to apply for ships with major conversion and offshore units) ;**

As far as item 3. is concerned, the conclusions stated in paragraph 3.2 of SP10006cPCf are:

- 1) UR L 5 shall be applied to existing ships contracted for construction prior to 1 July 2005, but which undergo a major conversion (refer to example in UI SC 226.1)! after that date;
- 2) The qualifying majority is of the view that UR L 5 should be in general applied to offshore units. The mandatory installation of stability software on such units should be left to discretion of each member.

These conclusions have been agreed by the majority of the PT members with a concern pertaining the application date.



### Task 37:

The terms of references established by SP for the PT work relevant to task 37 is included in the work specification in the approved Form A:

1. to develop the draft revised UR L5 based on the conclusion/comments in 1.3) of SP11016cPCx dated 5th June 2012
2. to review Section 6 of the existing UR L5 and to revise it, if needed, with view to reflecting any unique aspects of Type 4 software to be tested initially and periodically
3. to review the following Panel Member's position/comments included in SP11016c PCz 1) noting comments made by Panel Chairman included in SP11016c PCz 2) and advise the Panel accordingly:
4. to review the following Panel Member's comments in SP11016c PCz 1) noting comments made by Panel members included in SP11016c PCz 3) and advise the Panel accordingly.

As far as 1. is concerned all the conclusion/comments have been considered and included in URL5draft11.doc.; the wording 3D geometric (hull forms) has been modified because one half of PT members deems that "3D" confuses and it is sufficient to provide the sentence only "Both Type 3 and Type 4 stability software should be based on hull form model." The other half of PT members prefers the alternative sentence "Both Type 3 and Type 4 stability software should be based on hull form models that is directly calculates from a full three-dimensional geometric mode".

Similarly the sentences in 4.1.3 and 4.1.4 included between square brackets are those for which a majority has not been reached within the PT so the final decision whether maintain the text of not, is left to SP members

As far as the stability criteria to be fulfilled by Type 4 software, as IMO did not establish any criterion on the matter, they are left to the discretion of the Administration.

As far as 2. is concerned, the last sentence in 6. has been added within square brackets because the majority whether to maintain or delete such a sentence was not reached within PT 30.

PT 30 unanimously agreed that only the inclusion in 6.2 of the request of a minimum number of [three] loading condition and [three] damage cases is necessary; the number of at least three loading conditions and three damage cases was unanimously agreed within PT 30 but was left to square brackets for final acceptance by Safety Panel.

PT 30 also unanimously agreed that no modification is necessary to the remaining paragraph 6. 7. 8. 9. 10, as the requirements included in such paragraphs may be applied also to the Type Four software without any need of further changes.

As far as 3. and 4. are concerned, the opinion unanimous shared within PT 30 on the matter is that, as the necessity of the creation of the Type 4 has been unanimously recognized, and that the Type 4 has been included in URL5-draft11.doc, the pre-programmed damage cases are not the huge number of probabilistic damage cases developed in order to fulfill SOLAS Ch. II-1, but they are only some cases which are necessary for the periodical checking of the software only. These damage cases may be not necessarily fetched from those of SOLAS, but they shall be "frozen" (not editable) exactly as the test conditions referred in the present URL5 item 6.2; their use is for the software approval and periodical checking only.

On the other hand in case of a passenger ship the keel of which is laid on or after 1 January 2009 not subject to SRtP requirements, if she is provided with a software capable of carrying out stability calculation, this software is required to be as Type 2, in which any loading case is compared with one or more GM/KG limiting curves according to SOLAS.

A passenger ship the keel of which is laid after 1 January 2009 and subject to SRtP requirements should be provided with Type 2 software and, if not assisted by a shore based emergency team, with a Type 4 software, which, as defined in the URL5-draft11.doc at item 3, is a software calculating damage stability associated with an actual loading condition and an actual flooding case, using direct application of user defined damage, for the purpose of providing operational information for safe return to port.

Therefore a PT Member's idea of the switch between "pre-programmed damage cases" and "actual damage cases" can be completed by a simple choice of input model, then the "unchangeable" becomes "changeable" is supportable by PT 30 and included in 4.2 of URL5-draft11.doc.

Furthermore during the PT discussion, one PT Member raised the following point:

One other additional issue. Noting that URL5 states ' The requirements of this UR apply to stability software on ships contracted for construction on or after 1 January 2007 PT Member, in the past, raised a query regarding the application of this UR to:

- ship's which undergo conversions on or after said date
- offshore units

It appears that some Class Societies apply this UR to all of the above. It would be sensible to have a unified approach in this matter and we request that this be considered within this review.

The PT Member is concerned that application date of 1st January 2007 may require retrospective application to offshore units and therefore request that the panel considers our request for application date to be moved to December 2013.

The majority of PT Members shares that for the application date as requested by one PT Member, there are no specific comments. For the application of this UR L5 to offshore unit, PT 30 majority deems that "offshore unit" include the mobile offshore drilling unit which apply the quite different both intact and damage stability requirements. Therefore the wording "offshore unit" should be changed with "ships covered by the IMO resolution MSC.235(82) as amended and 2008 SPS Code as amended, or any other offshore support vessels which is undergoing review at IMO."

The output of the PT was considered within the Panel and the conclusions drawn from the same are included in Rev.3 of the UR.

## **6. Attachments**

None.

## **Technical Background (TB) document for UR L5 (Rev.4 June 2020)**

### **1. Scope and objectives**

UR L5 is an IACS Unified Requirement addressing minimum requirements for the approval of onboard software and hardware used for stability calculations.

This revision was made to clearly indicate that the pre-defined relevant damage cases of both sides of the ship are to be included in Type 3 software.

### **2. Engineering background for technical basis and rationale**

None

### **3. Source/derivation of the proposed IACS Resolution**

Internal query raised by a member, in conjunction with the comment it received from UK PSC.

### **4. Summary of Changes intended for the revised Resolution:**

Paragraph 4.1.3 has been revised so that it specifies the pre-defined relevant damage cases of both sides of the ship are to be pre-programmed in Type 3 software.

### **5. Points of discussions or possible discussions**

For the inquiry raised by a member that whether master can confirm the compliance with damage stability requirement by carrying out the calculation twice by transposing the loading conditions to the opposite side at unsymmetrical loading condition with the damage case for only one side pre-programmed with Type 3 software, a majority of members considered that requiring the suggested method is not meeting the requirement for the check to be automatic, although it would be theoretically possible to consider asymmetric loading in this way.

During the discussion by email correspondence, one member commented that the method is permissible only if suitable warnings are provided but this view is not included in this change.

For reference, previously the Panel has reviewed UK MCA Marine Guidance Note (MGN) 611(M) "Damage Stability: Alternative verification method for tankers - UK interpretations and procedures" under the subject PS18020j upon the request of UK MCA and it introduces consideration on one ship side damage as a shortcoming for implementation of MSC.1/Circ.1461 in its item 2.2.

### **6. Attachments if any**

Att. 1:

MSC.1/Circ.1461 "GUIDELINES FOR VERIFICATION OF DAMAGE STABILITY REQUIREMENTS FOR TANKERS"

Att. 2:

UK MCA Marine Guidance Note (MGN) 611(M) "Damage Stability: Alternative verification method for tankers - UK interpretations and procedures"

# IACS

INTERNATIONAL ASSOCIATION OF CLASSIFICATION SOCIETIES LTD.

PERMANENT SECRETARIAT: 4 Matthew Parker Street

Westminster, London SW1H 9NP, UNITED KINGDOM

TEL: +44(0)207 976 0660

INTERNET: [permsec@iacs.org.uk](mailto:permsec@iacs.org.uk) Web Site: [www.iacs.org.uk](http://www.iacs.org.uk)

August 2024

## History Files (HF) and Technical Background (TB) documents for URs concerning Machinery Installations (UR M)

Res. No.	Title	Current Rev.	HF/TB?
UR M1	Cylinder overpressure monitoring of internal combustion engines	Deleted (Aug 2004)	TB
UR M2	Alarm devices of internal combustion engines	1971	No
UR M3	Speed governor and overspeed protective device	Rev.7 Feb 2024	HF
UR M4		Deleted <i>Refer to F35</i>	No
UR M5	Mass production of internal combustion engines, procedure for inspection	Deleted Feb 2015	No
UR M6	Test pressures for parts of internal combustion engines	Deleted Feb 2015	No
UR M7		Deleted <i>Re-categorised as Rec.26</i>	No
UR M8		Deleted <i>Re-categorised as Rec.27</i>	No
UR M9	Crankcase explosion relief valves for crankcases of internal combustion engines	Rev.3, Corr.2 Sept 2007	TB
UR M10	Protection of internal combustion engines against crankcase explosions	Rev.4 July 2013	HF
UR M11	Protective devices for starting air mains	1972	No
UR M12	Fire extinguishing systems for scavenge manifolds	1972	No
UR M13		Deleted <i>Re-categorised as Rec.28</i>	No
UR M14	Mass production of internal combustion engines: definition of mass production	Deleted Feb 2015	No
UR M15		Deleted <i>Re-categorised as Rec.29</i>	No
UR M16	Devices for emergency operation of propulsion steam turbines	Rev.1 Jan 2005	TB

Res. No.	Title	Current Rev.	HF/TB?
UR M17		Deleted (Jul 1998)	No
UR M18	Parts of internal combustion engines for which material tests are required	Deleted Feb 2015	TB
UR M19	Parts of internal combustion engines for which non-destructive tests are required	Deleted Feb 2015	No
UR M20	Periodical Survey of Machinery	Deleted (Nov 2001) <i>Requirements relocated to Urs Z18 and Z21</i>	TB
UR M21	Mass production of internal combustion engines: type test conditions	Deleted Feb 2015	No
UR M22	No record		
UR M23	Mass production of engines: mass produced exhaust driven turboblowers	Deleted Feb 2015	No
UR M24	Requirements concerning use of crude oil or slops as fuel for tanker boilers	Rev.2 Aug 2023	HF
UR M25	Astern power for main propulsion	Rev.4 June 2017	HF
UR M26	Safety devices of steam turbines	Corr.1 Feb 2005	No
UR M27	Bilge level alarms for unattended machinery spaces	Del Mar 2022	HF
UR M28	Ambient reference conditions	1978	No
UR M29	Alarm systems for vessels with periodically unattended machinery spaces	Rev.3 1997	No
UR M30	Safety systems for vessels with periodically unattended machinery spaces	Rev. 1 1997	No
UR M31	Continuity of electrical power supply for vessels with periodically unattended machinery spaces	Deleted Jan 2023	HF
UR M32	Definition of diesel engine type	Deleted Feb 2015	No
UR M33	Scantlings of intermediate shafts	Deleted (Feb 2005) <i>Replaced by UR M68</i>	TB
UR M34	Scantlings of coupling flanges	1980	No
UR M35	Alarms, remote indications and safeguards for main reciprocating i.c. engines installed in unattended machinery spaces	Rev.8 Jan 2019	HF
UR M36	Alarms and safeguards for auxiliary reciprocating internal combustion engines driving generators in unattended machinery spaces	Rev.6 Dec 2018	HF
UR M37	Scantlings of propeller shafts	Deleted (Feb 2005) <i>Replaced by UR M68</i>	TB
UR M38	k-factors for different shaft design features (intermediate shafts) – see M33	Deleted (Feb 2005) <i>Replaced by UR M68</i>	TB
UR M39	k-factors for different shaft design features (propeller shafts) – see M37	Deleted (Feb 2005) <i>Replaced by UR M68</i>	TB

<b>Res. No.</b>	<b>Title</b>	<b>Current Rev.</b>	<b>HF/TB?</b>
UR M40	Ambient conditions – Temperatures	1981	No
UR M41	Automation – type testing conditions for control and instrumentation equipment	Deleted (1991) <i>Superseded by UR E10</i>	No
UR M42	Steering gear	Rev.6 Mar 2022	HF
UR M43	Bridge control of propulsion machinery	Rev.1 Feb 2024	HF
UR M44	Documents for the approval of diesel engines	Corr.1 Feb 2022	HF
UR M45	Ventilation of Machinery Spaces	Del Nov 2022	HF
UR M46	Ambient conditions – Inclinations and Ship Accelerations and Motions	Rev.4 Aug 2024	HF
UR M47	Bridge control of propulsion machinery for attended machinery spaces	Deleted (Feb 2024) <i>Superseded by UR M43</i>	HF
UR M48	Permissible limits of stresses due to torsional vibrations for intermediate, thrust and propeller shafts	Deleted (Feb 2005) <i>Replaced by UR M68</i>	TB
UR M49	Availability of Machinery	Deleted (Dec 2003) <i>Merged with UR E8 to form UR M61</i>	TB
UR M50	Programme for type testing of non–mass produced I.C. engines	Deleted Feb 2015	TB
UR M51	Factory Acceptance Test and Shipboard Trials of I.C. Engines	Corr.1 Oct 2018	HF
UR M52	Length of aft stern bush bearing	Rev.2 Nov 2019	HF
UR M53	Calculations for I.C. Engine Crankshafts	Rev.5 May 2023	HF
UR M54	Steering gear – action for ships in service	Deleted (1997)	No
UR M55	Planned maintenance scheme (PMS) for machinery	Deleted (May 2001)	No
UR M56	Marine gears – Load capacity of involute parallel axis spur and helical gears	Corr.2 Mar 2023	HF
UR M57	Use of Ammonia as a Refrigerant	1993	No
UR M58	Charge Air Coolers	Deleted Feb 2015	No
UR M59	Control and Safety System for Dual Fuel Diesel Engines	Deleted June 2019	No
UR M60	Control and Safety of Gas Turbines for Marine Propulsion Use	Rev.1 Nov 2021	HF
UR M61	Starting Arrangements of Internal Combustion Engines	Rev.3 Feb 2024	HF
UR M62	Rooms for emergency fire pumps in cargo ships	Deleted June 2014	TB
UR M63	Alarms and safeguards for emergency reciprocating I.C. engines	Rev.1 Jan 2023	HF

<b>Res. No.</b>	<b>Title</b>	<b>Current Rev.</b>	<b>HF/TB?</b>
UR M64	Design of integrated cargo and ballast systems on tankers	Rev.1 July 2004	TB
UR M65	Draining and Pumping Forward Spaces in Bulk Carriers	Rev.1 July 2004	TB
UR M66	Type Testing Procedure for Crankcase Explosion Relief Valves	Corr.1 Oct 2021	HF
UR M67	Type Testing Procedure For Crankcase Oil Mist Detection and Alarm Equipment	Rev.2 Feb 2015	HF
UR M68	Dimensions of propulsion shafts and their permissible torsional vibration stresses	Rev.3 Feb 2021	HF
UR M69	Qualitative Failure Analysis for Propulsion and Steering on Passenger Ships	Del Mar 2022	HF
UR M70	<i>Under Development</i>		
UR M71	Type Testing of I.C. Engines	Corr.1 June 2016	HF
UR M72	Certification of Engine Components	Rev.3 Apr 2023	HF
UR M73	Turbochargers	Rev.2 May 2023	HF
UR M74	Installation of Ballast Water Management Systems	Rev.2 June 2021	HF
UR M75	Ventilation of emergency generator rooms	Rev.1 Jan 2021	HF
UR M76	Location of fuel tanks in cargo area on oil and chemical tankers	Rev.1 June 2018	HF
UR M77	Storage and use of SCR reductants	Rev.4 Feb 2023	HF
UR M78	Reciprocating Internal Combustion Engines Fuelled by Natural Gas	Rev.2 Jan 2024	HF
UR M79	Towing winch emergency release systems	Rev.1 Feb 2020	HF
UR M80	Requirements for AC Generating sets	May 2019	HF
UR M81	Safety measures against chemical treatment fluids used for exhaust gas cleaning systems and the residues which have hazardous properties	Rev.1 July 2023	HF
UR M82	Type Testing Procedure of Explosion Relief Devices for Combustion Air Inlet and Exhaust Gas Manifolds of I.C. Engines Using Gas as Fuel	Mar 2023	HF
UR M83	Testing of the control system of controllable pitch propellers intended for main propulsion	Oct 2023	HF
UR M84	Capacity and availability of compressed air for essential services	Feb 2024	HF



**TB (Deletion of UR M1 )**  
**Cylinder Overpressure Monitoring of Internal Combustion Engines**

**Technical Justification for  
deletion and the need for revision of M35 and M36.**

1. WP/MCH Task 64 was established to review the requirement in UR M1 for cylinder overpressure monitoring of internal combustion engines.
2. The objectives of the Task were to review the requirement in UR M1 for cylinder overpressure monitoring of internal combustion engines and address its application to unattended machinery spaces.
3. The work specification included:
  - Review SOLAS II-1 Reg 27.2 and UR M1.
  - Determine whether remote indication/alarm is feasible and consider its inclusion in UR M35 and M36 for alarms for periodically unattended internal combustion engines.
4. The background to the task was that IACS WP/MCH members reported cases of owners requesting alarms for cylinder overpressure to be included with the other UMS alarms. It is acknowledged that sentinel valves only provide audible indication when crew members are within earshot.
5. The current requirement for overpressure monitoring stems back to when the design of combustion equipment and operation of engines was not always reliable with the possibilities of excessive fuel charge, pre-ignition and “hanging up” of injection valves. Cylinder pressure relief valves were installed and generally set a pressure corresponding to 110% of the maximum cylinder pressure.
6. The improvements in design and reliability of combustion equipment associated with current designs of marine diesel engines has led the industry to agree that the need for full overpressure relief to be unnecessary and that a sentinel valve could be an acceptable means of indicating that excessive cylinder firing pressure was being affected. By nature of its function the operation of such a sentinel valve would only be recognised in an attended machinery space.
7. Acceptance of a sentinel valve has now been questioned as it does not protect an engine cylinder from excessive pressure as identified in SOLAS Chapter II-1, Regulation 27.2. It is proposed to delete M1 from the Unified Requirements concerning Machinery Installations.
8. It is however recognised that cylinder pressure monitoring is one of the parameters that provides an input to the safe and reliable operation of electronically controlled engines and requirements for monitoring cylinder pressure and provision of overpressure alarm are considered essential where a single failure in equipment or system design could be the cause of cylinder overpressure. . In this respect the WP will propose a new task to review M 35 and M36.

## UR M3 “Speed governor and overspeed protective device”

### Summary

The UR provides requirements for Speed governor and overspeed protective devices.

### Part A. Revision History

Version no.	Approval date	Implementation date when applicable
Rev.7 (Feb 2023)	02 February 2024	01 January 2025
Rev.6 (Nov 2018)	12 November 2018	01 January 2020
Rev.5 (Feb 2006)	February 2006	-
Corr.1 (Aug 2003)	August 2003	-
Rev.4 (June 2002)	June 2002	-
Rev.3 (1990)	1990	-
Rev.2 (1986)	1986	-
Rev.1 (1984)	1984	-
New (1971)	1971	-

#### • Rev.7 (Feb 2023)

##### 1 Origin of Change:

- Based on IACS Requirement (New revision of UR M43 and deletion of UR M47)

##### 2 Main Reason for Change:

The references made in UR M3 to requirements of UR M43 and UR M47 are obsolete due to the deletion of these requirements.

##### 3 List of non-IACS Member classification societies contributing or participating in IACS Working Group:

Text.

##### 4 History of Decisions Made:

Members agreed to the deletion of the references to UR M43 and UR M47 in M3.1.3 following the deletion and changes made for UR M43 Rev. 1 and the deletion of UR M47 (PM20906dIMh).

## **5 Other Resolutions Changes:**

None.

## **6 Any hinderance to MASS, including any other new technologies:**

M3.1.3 requires local control of engines, which precludes MASS operations.

## **7 Dates:**

Original Proposal : 30 December 2022 (Ref: PM20906dIMd)  
Panel Approval : 10 January 2024 (Ref: 23186\_PMa)  
GPG Approval : 02 February 2024 (Ref: 23186\_IGc)

### **• Rev.6 (Nov 2018)**

#### **.1 Origin for Change:**

Other (*External Query raised through IACS member*)

#### **.2 Main Reason for Change:**

To include newer IACS requirements for testing generator sets i.e. Testing Engine and Alternator together, including the coupling.

UR M3.2 specifies requirements for speed governors of prime movers used for driving generators, whilst UR E13.4.4 specifies requirements for voltage regulation system of A.C. generators - including voltage regulation during transient conditions. As such there are IACS requirements when either one of them is separately tested but there are no specific IACS requirements when testing a generator set.

#### **.3 List of non-IACS Member Classification Societies contributing through the TC Forum and/or participating in IACS Working Group:**

None

#### **.4 History of Decisions Made:**

- Form A approved under 16230\_IGa/IAa in December 2016.
- Draft UR submitted to GPG under 16230 (Ref. 16230\_PMb – 25 October 2018)

#### **.5 Other Resolutions Changes**

None

#### **.6 Dates:**

Original Proposal: February 2017 Made by: Machinery Panel  
Panel Approval: 25 October 2018 (Ref: 16230\_PMb)  
GPG Approval: 12 November 2018 (Ref: 16230\_IGb)

- **Rev.5 (Feb 2006)**

Refer to the Annex 1 - TB document in Part B.

- **Corr.1 (Aug 2003)**

No records available

- **Rev.4 (June 2002)**

No records available

- **Rev.3 (1990)**

No records available

- **Rev.2 (1986)**

No records available

- **Rev.1 (1984)**

No records available

- **New (1971)**

No records available

## **Part B. Technical Background**

List of Technical Background (TB) documents for UR M3:

Annex 1.     **TB for Rev.5 (Feb 2006)**

See separate TB document in Annex 1.

Annex 2.     **TB for Rev.6 (Nov 2018)**

See separate TB document in Annex 2.

Annex 3.     **TB for Rev.7 (Feb 2024)**

See separate TB document in Annex 3.

**Note:** *There are no Technical Background (TB) documents available for New (1971), Rev.1 (1984), Rev.2 (1986), Rev.3 (1990), Rev.4 (June 2002) and Corr.1 (Aug 2003).*

## Technical Background

### UR M3 (Rev.5 Feb 2006)

#### Machinery Panel Task PM5201

In the course of revision of UR M3, giving rise to Rev.4 (June 2002), the wording of M3.2.1 was changed, and joined with the requirements which was in last sentence of M3.2.3 .

Thus, the requirement for recovery time to steady state not to exceed 5 seconds when the total consumer load is applied suddenly, was made applicable to emergency generating sets.

It resulted from industry that modern turbocharged engines cannot satisfy the above requirement, and can hardly cope with transient frequency variation, unless the engine is oversized in respect of the total consumer load.

Especially for passenger ships, where the emergency power requirement is quite high, it resulted difficult to satisfy the requirement while complying with other practical constraints.

It was therefore decided to evaluate the requirement in UR M3 Rev.4 against the SOLAS Reg. II-1/42 and Reg II-1/43

It resulted that the requirement from the UR was effectively stricter than SOLAS, in that the SOLAS Regulations II-1/42.2 and 43.2 do require the emergency source of power to be capable of supplying “simultaneously” the required services, but the scope of the regulation is the power balance, and not the transitory behaviour at start-up and during switching on, which, according to Reg. 42.3.1.2 is only subject to a limit of 45 seconds upon failure of the electrical supply from the main source of electrical power.

There was therefore some room for softer but technically sound requirements and it was considered that there is no need for much stricter load-taking capability requirements for the emergency generating sets.

The proposal put forward highlighted that supplying the electrical load in steps, similarly to what regularly accepted for the main source of electrical power, is a technically sound solution, provided the following constraints are complied with:

- the 45 seconds limit is to be satisfied;
- the emergency power distribution system is to be made such that the loads are automatically switched on in steps;
- the load steps are not larger than the emergency source of power can accept without giving rise to excessive frequency disturbances,
- the maximum allowable load step for the generator should be established in advance, to enable a suitable power distribution system design

The UR has been modified accordingly.

Submitted by MCH Panel Chairman  
30 Dec 2005

## **Permsec's note: GPG discussion**

1. DNV(NVa) commented as follows:

DNV can not accept the requirement given in M3.2.3. We require 3 equal steps since modern engine with high charging air pressure will normally not be able to take 50% sudden load. This is the reason for adding the new requirement for emergency generator. If we where to require load steps of 50%, almost every installation will have to be verified in accordance with the exception given M3.2.3. Consequently DNV can not agree to have a UR where in most the cases the exception has to be applied.

2. LR replied(LRb):

In LR's view the Form A of this task was specific in as much emergency generator prime movers were to be addressed only. The comment in NVa seem to indicate a change of direction.

As far as we are concerned the current requirements for the main generator prime movers do allow a relaxation of loading from two steps to three steps and therefore we do not see the argument as being strong enough to stop completion of this task. LR is not convinced that the majority of the engines will have difficulties in coping with the two step load. We would prefer to see the draft submitted to Council for adoption based on 3/4 majority.

3. DNV responded:

DNV understand LR's comment in LRb, and have therefore reconsidered the situation and decided that we can accept UR M3 as revised in (PM5201).

Therefore, unanimous agreement was achieved at GPG level, too (6001\_IGc, 25 Jan 06)

### **Implementation (6001\_ICa, 6 Feb 2006):**

UR M3(Rev.4) was adopted on 6 Feb 2006. The requirements introduced therein are to be implemented within one year of adoption by Council. END

## Technical Background (TB) document for UR M3 (Rev.6 Nov 2018)

### 1. Scope and objectives

The objective is to revise UR M3 to include additional requirements to cover generator sets i.e. Engine and Alternator together, including the coupling.

### 2. Engineering background for technical basis and rationale

Following an external query associated with the transient voltage response limitation (when applying the two load steps to maximum power loading), it was recognised that there were neither specific IACS requirements for testing an Engine and an Alternator together nor which included the coupling, where installed.

It was noted that while UR M3.2 specifies requirements for speed governors of prime movers used for driving generators, UR E13.4.4 specifies requirements for voltage regulation system of A.C. generators - including voltage regulation during transient conditions. As such there are IACS requirements when either one of them is separately tested but are not aligned with each other for the case when the two items are tested together.

While UR E13 requires that all tests are to be carried out in accordance with IEC 60092-301, there are deviations between UR M3 and IEC 60092-301 when it comes to load steps used for testing. After discussions, the Panel agreed to use this opportunity to consider aligning the load tests required in UR M3 to that of IEC 60092-301.

After further discussion and based on a qualified majority, it was concluded that the tests required by UR M3 and by UR E13 are different and both tests need to be carried out.

### 3. Source/derivation of the proposed IACS Resolution

External query raised through IACS member.

### 4. Summary of Changes intended for the revised Resolution:

Fig. 1 from UR M3 has been revised to align it with the figure in ISO 8528-5:2013, which provides limiting curves for up to 5 power stages.

The reference to paragraph 3.1.1 in M3.2.1 was changed to 3.2.5

### 5. Points of discussions or possible discussions

In addition to the items listed under point 4 above, the following items were also discussed by the Machinery Panel:

Consideration was given to include requirements covering cyclic irregularity and frequency cyclic variation, including an associated testing procedure to verify that it is within the allowed tolerance. Based on a qualified majority subsequent to further review, the panel expressed a view that requirements for cyclic irregularity and frequency cyclic variation should not be included.



Regarding the alignment of tests as required by UR M3 and UR E13, based on a qualified majority it was concluded that the tests required by UR M3 and by UR E13 are different and both tests need to be carried out.

A new sub-section M3.3 was evaluated for inclusion, in order to specify additional requirements for generating sets covering torsional vibration, coupling selection criteria, power requirement, rating plate for generator sets and testing requirements associated with engine and alternator. After discussion, the qualified majority of panel Members decided not to include this new sub-section in UR M3 and to include it in a new dedicated UR.

**6. Attachments if any**

None

## **Technical Background (TB) document for UR M3 (Rev.7 Feb 2024)**

### **1. Scope and objectives**

To update UR M3 following revision 1 of UR M43 and the deletion of UR M47.

### **2. Engineering background for technical basis and rationale**

None.

### **2a. Specification of the data utilised in the development/revision of the proposed IACS Resolution, if any**

N/A.

### **3. Source/derivation of the proposed IACS Resolution**

None.

### **4. Summary of Changes intended for the revised Resolution:**

The reference to UR M43.8 and M43.10 requirements and to UR M47 have been deleted in M3.1.3, as some of these requirements have been deleted, or are not deemed necessary.

### **5. Points of discussions or possible discussions**

None.

### **6. Attachments if any**

None.

IACS WP/MCH  
TECHNICAL BACKGROUND DOCUMENT

**Rev.2, M9 – Safety valves for crankcases of internal combustion engines.**

2.1. Scope and objectives

The item is covered by Task 41. The question put forward by RINA initiated the revision . Proposal was related to the possible use of more than two crankcase explosion relief valves, which seemed to be in conflict with text in current IACS UR M9, Note 2.

2.2 Points of discussion

The subject was discussed, and it was agreed that the use of more than two safety valves could be accepted from a technical point of view, provided they otherwise satisfied the requirements of UR M9.2 and M10.4.

*In order to avoid future confusion as to this it was agreed to propose a revision of IACS UR M9, by deleting the present Note 2.*

2.3 Source/derivation of proposed requirements

Initiated by question made by RINA in their fax MAC/VBC/25182 - 1999-06-16

2.4 Decision by voting.

All WP/MCH members agreed in above.

Submitted by WP/MCH Chairman on 10 May 2000

## Technical Background

### Revision UR M9 (Rev.3) and M10(Rev.2) New URs (M 66 & M67) for Type Testing Crankcase Explosion Relief Valves and Oil Mist Detection Arrangements

1. WP/MCH Task 55 was established to review the requirements in URM9 “Safety valves for crankcases of internal combustion engines” and M10 “Protection of internal combustion engines against crankcase explosions” for applicability and suitability to modern diesel engines.
2. The work specification included the following:
  - Review crankcase explosion reports for the past 10 years.
  - Review SOLAS requirements applicable to diesel engine crankcase safety.
  - Establish philosophy for a holistic approach to crankcase safety.
  - Consider the applicability of the safeguards in M9 and M10 for crankcase to all types of modern diesel engines – (high speed, medium speed and large slow speed engines + “large” and “small” bore engines).
  - Propose a set Unified Requirements for crankcase safety that include:
    - Requirements for submission of plans and particulars
    - Assessment of engine arrangements
    - Design of equipment
    - Testing of equipment and safety arrangements
    - Type testing requirements
    - Monitoring arrangements
    - Protection of engine and personnel
    - Through life survey and inspection
3. The background to the task was that there have been a number of serious incidents involving crankcase explosions in large diesel engines in the past 5-6 years that have resulted in loss of life and major damage to ships and their machinery. Questions have been raised regarding the adequacy of current standards for crankcase safety with engine builders and ship-owners pressing for revision/re-assessment of the current the standards that essentially stem from the Reina del Pacifico incident in 1947.
4. UR M9 has been extended to address design requirements for explosion relief valves in terms of a required provision of a flame arrester that prevents the passage of flame following a crankcase explosion and for valve to be type tested. The possible effects of shielding on relief valve efficacy have been recognised with a requirement for testing if such shielding is fitted.
5. The revised M9 also includes requirements for a manufacturer’s installation and maintenance manual with instructions installation, maintenance and actions required to be followed after a crankcase explosion. Requirements for marking of the valves have also been included.

6. UR M10 has been revised to remove requirements for the explosion relief valve (moved to M9) and clarify the existing text. The revised M10 now includes requirements for type testing of oil mist detection/monitoring systems and compliance with the oil mist manufacturer's instructions. Requirements for arrangements and installation onto the engine have been defined and also for system testing.

7. UR M10 also addresses alternative methods of preventing the build-up of oil mist and methods of assessment.

8. To support the extensive revisions to M9 and M10 new Unified Requirements for type testing explosion relief valves and for oil mist monitoring/detection arrangements have been developed. These URs provide a common standard against which relief valves and oil mist monitoring/detection systems can be assessed. They define the scope, purpose, test facilities, processes, assessment and reporting.

Note by the Permanent Secretariat:

1. GPG added the following implementation statement to the URs:

"Engines are to be fitted with components and arrangements complying with this UR when:

- 1) an application for certification of an engine is dated on/after 1 January 2006; or
- 2) installed in new ships for which the date of contract for construction is on or after 1 January 2006."

2. The URs (M 66 & 67, M9(Rev.2) and M20(Rev.3)) do not apply to existing engines on the existing ships.

Submitted by WP/MCH Chairman 24<sup>th</sup> August 2004

**Technical Background Document**  
**UR M9(Rev.3, Corr.1, November 2005)**  
**UR M10(Rev.2, Corr.1, November 2005)**  
**UR M66(New, Corr.1, November 2005)**  
**UR M67(New, Corr.1, November 2005)**

1. These UR Ms were adopted in Jan 2005 for implementation from 1 Jan 2006.
2. However, IACS was requested, via the Machinery Panel, by CIMAC and MAN/B&W, to postpone the 1 Jan 06 implementation date for the type testing requirements for crankcase explosion relief valves and crankcase oil mist detection/monitoring and alarm arrangements contained in IACS URs M66 and M67, respectively.
3. This discussion led to re-issuance of these UR Ms, changing the implementation statements.

These UR Ms were re-issued as 'Corr.1' on 29 Nov 2005.

4. GPG Chairman's message (4069gIGk, 14/11/2005) contains a more detailed background for this amendment.

For records, GPG/Council Chairmen's messages are attached to the TB document for the January 2005 versions.

Permanent Secretariat  
29 Nov 2005

**GYH**

---

**From:** AIACS@eagle.org  
**Sent:** 23 November 2005 20:50  
**To:** iacs@bureauveritas.com; iacs@ccs.org.cn; iacs@dnv.com; iacs@gl-group.com;  
 krsiacs@krs.co.kr; iacs@lr.org; clnkiacs@classnk.or.jp; iacs@rina.org; iacs@rs-head.spb.ru;  
 johnderose@iacs.org.uk; colinwright@iacs.org.uk; gilyonghan@iacs.org.uk;  
 terryperkins@iacs.org.uk; efs@iacs.org.uk; richardleslie@iacs.org.uk;  
 helenbutcher@iacs.org.uk; MCH-Panel@gl-group.com  
**Subject:** 4069glCd: UR M66, M67 - application date

Date: 23 Nov 05

TO: IACS Council Members

TO: IACS GPG Chairman & Members

TO: IACS Permanent Secretary: Mr. R. Leslie

TO: IACS Machinery Panel Chairman: Dr. U. Petersen

FROM: R. D. Somerville

File Ref: T-12-2

Subject: 4069glCd: UR M66, M67 - application date

1. All Members have replied to ICc. Eight Members have supported the proposed course of action in IGk.
2. Lloyd's, supported by RINA, proposes that the URs need not be withdrawn, as proposed in IGk, but that only the implementation date need be changed. LR proposed posponement to 1 July 06 -- instead of 1 Jan 07, as proposed in IGk.

2.1 Regarding the implementation date of 1 July 06 vs. 1 Jan 07, this had already been debated in GPG and the strong majority supported 1 Jan 2007. I conclude 1 January 2007 is agreed.

2.2 Regarding whether to "withdraw" the URs or "postpone" their date of application, to my understanding either approach is acceptable and will result in the same outcome.

3. Therefore to accomodate the request that the URs not be withdrawn, I conclude that the agreed course of action is:

3.1 **Perm Sec** is to revise the uniform application statements for the URs, as follows, reissue them, and post them on the IACS website:

3.1.1 For URs M66 and M67:

"Note: Engines are to be fitted with components and arrangements complying with this UR when:

- 1) an application for certification of an engine is dated on/after 1 January 2007; or
- 2) installed in new ships for which the date of contract for construction is on or after 1 January 2007."

3.1.2 For UR M9, Rev.3:

"2. Engines are to be fitted with components and arrangements complying with Revision 3 of this UR, except for M9.8, when:

- 1) an application for certification of an engine is dated on/after 1 January 2006; or
  - 2) installed in new ships for which the date of contract for construction is on or after 1 January 2006.
- The requirements of M9.8 apply, in both cases above, from 1 January 2007."

3.1.3 For UR M10, Rev.2:

"2. Engines are to be fitted with components and arrangements complying with Revision 2 of this UR, except for M10.8, when:

- 1) an application for certification of an engine is dated on/after 1 January 2006; or
  - 2) installed in new ships for which the date of contract for construction is on or after 1 January 2006.
- The requirements of M10.8 apply, in both cases above, from 1 January 2007."

3.2 **Machinery Panel** is to:

- a. inform CIMAC and MAN/B&W of the postponed application of URs M66 and M67, and the intention to update them;
- b. update URs M66 and M67, as quickly as possible, taking account of CIMAC's, MAN/B&W and Panel Member's inputs;
- c. once adopted at Panel level, send the revised URs to CIMAC for quick review/comment and notification to the equipment suppliers;
- d. further update the URs as needed in light of any comments received from CIMAC;
- e. submit the revised URs to GPG for approval not later than the end of the 1st Q 2006.

3.3 Upon adoption of the revised URs by IACS Council, **Machinery Panel** is to send them to CIMAC for their information and requesting that CIMAC notify the equipment suppliers of the requirements.

Regards,

Robert D. Somerville

IACS Council Chairman

email protected and scanned by BIS Advanced Spam & Virus Checking - powered by AdvascanTM  
- keeping email useful



**GYH**

---

**From:** AIACS@eagle.org  
**Sent:** 14 November 2005 22:00  
**To:** iacs@bureauveritas.com; iacs@ccs.org.cn; iacs@dnv.com; iacs@gl-group.com;  
krsiacs@krs.co.kr; iacs@lr.org; clnkiacs@classnk.or.jp; iacs@rina.org; iacs@rs-head.spb.ru;  
johnderose@iacs.org.uk; colinwright@iacs.org.uk; gilyonghan@iacs.org.uk;  
terryperkins@iacs.org.uk; efs@iacs.org.uk; richardleslie@iacs.org.uk;  
helenbutcher@iacs.org.uk  
**Cc:** MCH-Panel@gl-group.com  
**Subject:** 4069IGk: UR M66, M67 - application date

Date: 14 Nov 05

TO: Mr. R.D. Somerville, IACS Council Chairman

CC: IACS Council Members  
CC: IACS GPG Members

CC: IACS Machinery Panel Chairman: Dr. U. Petersen

CC: IACS Permanent Secretary: Mr. R. Leslie

FROM: S.R. McIntyre

File Ref: T-12-2

Subject: 4069IGk: UR M66, M67 - application date

1. IACS has been requested, via the Machinery Panel, by CIMAC and MAN/B&W, to postpone the 1 Jan 06 implementation date for the type testing requirements for crankcase explosion relief valves and crankcase oil mist detection/monitoring and alarm arrangements contained in IACS URs M66 and M67, respectively. Their request is to give the equipment manufacturers and the engine builders more time to adapt to the new requirements. Industry has also recommended the need for some improvements/clarifications in the two URs, which the Machinery Panel has agreed are needed/appropriate.

1.1 Since CIMAC was involved in the IACS decision, some years ago, to develop these URs, in retrospect it would have been advisable to submit the URs for external review by CIMAC before their adoption to ensure that CIMAC would be fully aware of the requirements and the timetable for their implementation--and working with IACS Societies to ensure that their suppliers were apprised of and complying with the new requirements. Unfortunately, this was not done.

1.2 The type testing requirements of URs M66 and M67 are invoked in recent revisions of M9 and M10, respectively.

2. The Machinery Panel recommended that GPG postpone implementation of URs M66 and M67 and advised GPG that both URs need to be updated/clarified.

2.1 Several Members have also advised that they needed more time for initial implementation and could not implement the two URs from 1 Jan 06 as had been originally agreed by Council.

3. Having carefully considered the input from CIMAC, MAN/B&W, the Machinery Panel and Members, GPG agrees that IACS should postpone the implementation of these URs by one year to give time for updating them, vetting the changes with CIMAC, notifying industry and for Members to process the related rule changes. Therefore, GPG requests Council's agreement to the following course of action:

3.1 URs M66 and M67, along with M9.8 of M9, Rev.3 and M10.8 of M10, Rev.2 are to be withdrawn pending the updating of M66 and M67, which needs to be accomplished as quickly as possible (ie. the target date of 1st Q 2006 for revising M66, agreed at GPG 59, needs to be accelerated);

3.2 The updated URs, once adopted at Panel level are to be sent to CIMAC by the Machinery Panel for quick review/comment by CIMAC, and then further updated by the Panel in light of any comments received, prior to submission to GPG/Council;

3.3 The updated URs M66 and M67, once adopted by GPG/Council, are to be issued as "Corr" (since the initial versions will never have been implemented)--with uniform application from 1 Jan 2007 (instead of 1 Jan 2006);

3.4 M9, Rev.3 without M9.8, and M10, Rev. 2, without M10.8, are to be reissued as "Corr" until the updated M66 and M67 are adopted by Council, at which time M9.8 and M10.8 are to be included in M9, Rev.4 and M10, Rev.3, respectively for application from 1 Jan 2007.

4. Council Chairman is kindly requested to seek Council's agreement to this course of action as soon as possible.

Regards,

S.R. McIntyre

IACS GPG Chairman

email protected and scanned by BIS Advanced Spam & Virus Checking - powered by AdvascanTM  
- keeping email useful

## Technical Background

### Revision UR M9 (Rev.3) and M10(Rev.2) New URs (M 66 & M67) for Type Testing Crankcase Explosion Relief Valves and Oil Mist Detection Arrangements

1. WP/MCH Task 55 was established to review the requirements in URM9 “Safety valves for crankcases of internal combustion engines” and M10 “Protection of internal combustion engines against crankcase explosions” for applicability and suitability to modern diesel engines.
2. The work specification included the following:
  - Review crankcase explosion reports for the past 10 years.
  - Review SOLAS requirements applicable to diesel engine crankcase safety.
  - Establish philosophy for a holistic approach to crankcase safety.
  - Consider the applicability of the safeguards in M9 and M10 for crankcase to all types of modern diesel engines – (high speed, medium speed and large slow speed engines + “large” and “small” bore engines).
  - Propose a set Unified Requirements for crankcase safety that include:
    - Requirements for submission of plans and particulars
    - Assessment of engine arrangements
    - Design of equipment
    - Testing of equipment and safety arrangements
    - Type testing requirements
    - Monitoring arrangements
    - Protection of engine and personnel
    - Through life survey and inspection
3. The background to the task was that there have been a number of serious incidents involving crankcase explosions in large diesel engines in the past 5-6 years that have resulted in loss of life and major damage to ships and their machinery. Questions have been raised regarding the adequacy of current standards for crankcase safety with engine builders and ship-owners pressing for revision/re-assessment of the current the standards that essentially stem from the Reina del Pacifico incident in 1947.
4. UR M9 has been extended to address design requirements for explosion relief valves in terms of a required provision of a flame arrester that prevents the passage of flame following a crankcase explosion and for valve to be type tested. The possible effects of shielding on relief valve efficacy have been recognised with a requirement for testing if such shielding is fitted.
5. The revised M9 also includes requirements for a manufacturer’s installation and maintenance manual with instructions installation, maintenance and actions required to be followed after a crankcase explosion. Requirements for marking of the valves have also been included.

6. UR M10 has been revised to remove requirements for the explosion relief valve (moved to M9) and clarify the existing text. The revised M10 now includes requirements for type testing of oil mist detection/monitoring systems and compliance with the oil mist manufacturer's instructions. Requirements for arrangements and installation onto the engine have been defined and also for system testing.

7. UR M10 also addresses alternative methods of preventing the build-up of oil mist and methods of assessment.

8. To support the extensive revisions to M9 and M10 new Unified Requirements for type testing explosion relief valves and for oil mist monitoring/detection arrangements have been developed. These URs provide a common standard against which relief valves and oil mist monitoring/detection systems can be assessed. They define the scope, purpose, test facilities, processes, assessment and reporting.

Note by the Permanent Secretariat:

1. GPG added the following implementation statement to the URs:

"Engines are to be fitted with components and arrangements complying with this UR when:

- 1) an application for certification of an engine is dated on/after 1 January 2006; or
- 2) installed in new ships for which the date of contract for construction is on or after 1 January 2006."

2. The URs (M 66 & 67, M9(Rev.2) and M20(Rev.3)) do not apply to existing engines on the existing ships.

Submitted by WP/MCH Chairman 24<sup>th</sup> August 2004

6. UR M10 has been revised to remove requirements for the explosion relief valve (moved to M9) and clarify the existing text. The revised M10 now includes requirements for type testing of oil mist detection/monitoring systems and compliance with the oil mist manufacturer's instructions. Requirements for arrangements and installation onto the engine have been defined and also for system testing.

7. UR M10 also addresses alternative methods of preventing the build-up of oil mist and methods of assessment.

8. To support the extensive revisions to M9 and M10 new Unified Requirements for type testing explosion relief valves and for oil mist monitoring/detection arrangements have been developed. These URs provide a common standard against which relief valves and oil mist monitoring/detection systems can be assessed. They define the scope, purpose, test facilities, processes, assessment and reporting.

Note by the Permanent Secretariat:

1. GPG added the following implementation statement to the URs:

"Engines are to be fitted with components and arrangements complying with this UR when:

- 1) an application for certification of an engine is dated on/after 1 January 2006; or
- 2) installed in new ships for which the date of contract for construction is on or after 1 January 2006."

2. The URs (M 66 & 67, M9(Rev.2) and M20(Rev.3)) do not apply to existing engines on the existing ships.

Submitted by WP/MCH Chairman 24<sup>th</sup> August 2004

## UR M10 “Protection of internal combustion engines against crankcase explosions”

### Part A. Revision History

Version no.	Approval date	Implementation date when applicable
Rev.4 (July 2013)	24 July 2013	1 January 2015
Rev.3 (Sept 2008)	11 September 2008	1 January 2010
Corr.2 (Oct 2007)	05 October 2007	-
Corr.1 (Nov 2005)	07 December 2005	-
Rev.2 (Jan 2005)	10 January 2005	-
Corr.1 (1997)	12 May 1997	-
Rev.1 (1991)	<i>No records</i>	-
New (1972)	<i>No records</i>	-

#### • Rev 4 (July 2013)

##### .1 Origin of Change:

- Suggestion by IACS member

##### .2 Main Reason for Change:

To implement definitions of Low-, Medium- and High-Speed Engines as made in UR M71.

##### .3 List of non-IACS Member classification societies contributing through the TC Forum and/or participating in IACS Working Group:

None

##### .4 History of Decisions Made:

The matter was discussed by Machinery Panel under PM 12407 during 16<sup>th</sup> and 17<sup>th</sup> Meeting and all members agreed with the introduction of the same definitions as made in the UR M71. Implementation date agreed is 01 January 2015.

##### .5 Other Resolutions Changes

None

##### .6 Dates:

Original Proposal: September 2012 by Machinery Panel  
 Machinery Panel Approval: 25 June 2013  
 GPG Approval: 24 July 2013 (Subject No: 12189\_IGb)

- **Rev 3 (Sept 2008)**

Refer to the TB document in Annex 3.

- **Rev 2 Corr.2 (Oct 2007)**

Contracted for construction – Standard footnote added (Ref: 7546aIGa). There is no TB document available.

- **Rev 2 Corr.1 (Nov 2005)**

Refer to the TB document in Annex 2.

- **Rev 2 (Jan 2005)**

Refer to the TB document in Annex 1.

- **Rev 1 Corr.1 (1997)**

Editorial correction in M10.6. "0.25" corrected to "2.5". There is no TB document available.

- **Rev 1 (1991)**

No records available.

- **New (1972)**

No records available.

## **Part B. Technical Background**

List of Technical Background (TB) documents for UR M10:

Annex 1. **TB for Rev.2 (Jan 2005)**

See separate TB document in Annex 1.

Annex 2. **TB for Rev.2 Corr.1 (Nov 2005)**

See separate TB document in Annex 2.

Annex 3. **TB for Rev.3 (Sept 2008)**

See separate TB document in Annex 3.

Annex 4. **TB for Rev.4 (July 2013)**

See separate TB document in Annex 4.

*Note: There are no Technical Background (TB) documents available for New (1972), Rev.1 (1991), Corr.1 (1997) and Rev.2 Corr.2 (Oct 2007).*



## Technical Background

### Revision UR M9 (Rev.3) and M10(Rev.2) New URs (M 66 & M67) for Type Testing Crankcase Explosion Relief Valves and Oil Mist Detection Arrangements

1. WP/MCH Task 55 was established to review the requirements in URM9 “Safety valves for crankcases of internal combustion engines” and M10 “Protection of internal combustion engines against crankcase explosions” for applicability and suitability to modern diesel engines.
2. The work specification included the following:
  - Review crankcase explosion reports for the past 10 years.
  - Review SOLAS requirements applicable to diesel engine crankcase safety.
  - Establish philosophy for a holistic approach to crankcase safety.
  - Consider the applicability of the safeguards in M9 and M10 for crankcase to all types of modern diesel engines – (high speed, medium speed and large slow speed engines + “large” and “small” bore engines).
  - Propose a set Unified Requirements for crankcase safety that include:
    - Requirements for submission of plans and particulars
    - Assessment of engine arrangements
    - Design of equipment
    - Testing of equipment and safety arrangements
    - Type testing requirements
    - Monitoring arrangements
    - Protection of engine and personnel
    - Through life survey and inspection
3. The background to the task was that there have been a number of serious incidents involving crankcase explosions in large diesel engines in the past 5-6 years that have resulted in loss of life and major damage to ships and their machinery. Questions have been raised regarding the adequacy of current standards for crankcase safety with engine builders and ship-owners pressing for revision/re-assessment of the current the standards that essentially stem from the Reina del Pacifico incident in 1947.
4. UR M9 has been extended to address design requirements for explosion relief valves in terms of a required provision of a flame arrester that prevents the passage of flame following a crankcase explosion and for valve to be type tested. The possible effects of shielding on relief valve efficacy have been recognised with a requirement for testing if such shielding is fitted.
5. The revised M9 also includes requirements for a manufacturer’s installation and maintenance manual with instructions installation, maintenance and actions required to be followed after a crankcase explosion. Requirements for marking of the valves have also been included.

6. UR M10 has been revised to remove requirements for the explosion relief valve (moved to M9) and clarify the existing text. The revised M10 now includes requirements for type testing of oil mist detection/monitoring systems and compliance with the oil mist manufacturer's instructions. Requirements for arrangements and installation onto the engine have been defined and also for system testing.

7. UR M10 also addresses alternative methods of preventing the build-up of oil mist and methods of assessment.

8. To support the extensive revisions to M9 and M10 new Unified Requirements for type testing explosion relief valves and for oil mist monitoring/detection arrangements have been developed. These URs provide a common standard against which relief valves and oil mist monitoring/detection systems can be assessed. They define the scope, purpose, test facilities, processes, assessment and reporting.

Note by the Permanent Secretariat:

1. GPG added the following implementation statement to the URs:

"Engines are to be fitted with components and arrangements complying with this UR when:

- 1) an application for certification of an engine is dated on/after 1 January 2006; or
- 2) installed in new ships for which the date of contract for construction is on or after 1 January 2006."

2. The URs (M 66 & 67, M9(Rev.2) and M20(Rev.3)) do not apply to existing engines on the existing ships.

Submitted by WP/MCH Chairman 24<sup>th</sup> August 2004

**Technical Background Document**  
**UR M9(Rev.3, Corr.1, November 2005)**  
**UR M10(Rev.2, Corr.1, November 2005)**  
**UR M66(New, Corr.1, November 2005)**  
**UR M67(New, Corr.1, November 2005)**

1. These UR Ms were adopted in Jan 2005 for implementation from 1 Jan 2006.
2. However, IACS was requested, via the Machinery Panel, by CIMAC and MAN/B&W, to postpone the 1 Jan 06 implementation date for the type testing requirements for crankcase explosion relief valves and crankcase oil mist detection/monitoring and alarm arrangements contained in IACS URs M66 and M67, respectively.
3. This discussion led to re-issuance of these UR Ms, changing the implementation statements.

These UR Ms were re-issued as 'Corr.1' on 29 Nov 2005.

4. GPG Chairman's message (4069gIGk, 14/11/2005) contains a more detailed background for this amendment.

For records, GPG/Council Chairmen's messages are attached to the TB document for the January 2005 versions.

Permanent Secretariat  
29 Nov 2005

**GYH**

---

**From:** AIACS@eagle.org  
**Sent:** 23 November 2005 20:50  
**To:** iacs@bureauveritas.com; iacs@ccs.org.cn; iacs@dnv.com; iacs@gl-group.com;  
 krsiacs@krs.co.kr; iacs@lr.org; clnkiacs@classnk.or.jp; iacs@rina.org; iacs@rs-head.spb.ru;  
 johnderose@iacs.org.uk; colinwright@iacs.org.uk; gilyonghan@iacs.org.uk;  
 terryperkins@iacs.org.uk; efs@iacs.org.uk; richardleslie@iacs.org.uk;  
 helenbutcher@iacs.org.uk; MCH-Panel@gl-group.com  
**Subject:** 4069glCd: UR M66, M67 - application date

Date: 23 Nov 05

TO: IACS Council Members

TO: IACS GPG Chairman & Members

TO: IACS Permanent Secretary: Mr. R. Leslie

TO: IACS Machinery Panel Chairman: Dr. U. Petersen

FROM: R. D. Somerville

File Ref: T-12-2

Subject: 4069glCd: UR M66, M67 - application date

1. All Members have replied to ICc. Eight Members have supported the proposed course of action in IGk.
2. Lloyd's, supported by RINA, proposes that the URs need not be withdrawn, as proposed in IGk, but that only the implementation date need be changed. LR proposed posponement to 1 July 06 -- instead of 1 Jan 07, as proposed in IGk.

2.1 Regarding the implementation date of 1 July 06 vs. 1 Jan 07, this had already been debated in GPG and the strong majority supported 1 Jan 2007. I conclude 1 January 2007 is agreed.

2.2 Regarding whether to "withdraw" the URs or "postpone" their date of application, to my understanding either approach is acceptable and will result in the same outcome.

3. Therefore to accomodate the request that the URs not be withdrawn, I conclude that the agreed course of action is:

3.1 **Perm Sec** is to revise the uniform application statements for the URs, as follows, reissue them, and post them on the IACS website:

3.1.1 For URs M66 and M67:

"Note: Engines are to be fitted with components and arrangements complying with this UR when:

- 1) an application for certification of an engine is dated on/after 1 January 2007; or
- 2) installed in new ships for which the date of contract for construction is on or after 1 January 2007."

3.1.2 For UR M9, Rev.3:

"2. Engines are to be fitted with components and arrangements complying with Revision 3 of this UR, except for M9.8, when:

- 1) an application for certification of an engine is dated on/after 1 January 2006; or
  - 2) installed in new ships for which the date of contract for construction is on or after 1 January 2006.
- The requirements of M9.8 apply, in both cases above, from 1 January 2007."

3.1.3 For UR M10, Rev.2:

"2. Engines are to be fitted with components and arrangements complying with Revision 2 of this UR, except for M10.8, when:

- 1) an application for certification of an engine is dated on/after 1 January 2006; or
  - 2) installed in new ships for which the date of contract for construction is on or after 1 January 2006.
- The requirements of M10.8 apply, in both cases above, from 1 January 2007."

3.2 **Machinery Panel** is to:

- a. inform CIMAC and MAN/B&W of the postponed application of URs M66 and M67, and the intention to update them;
- b. update URs M66 and M67, as quickly as possible, taking account of CIMAC's, MAN/B&W and Panel Member's inputs;
- c. once adopted at Panel level, send the revised URs to CIMAC for quick review/comment and notification to the equipment suppliers;
- d. further update the URs as needed in light of any comments received from CIMAC;
- e. submit the revised URs to GPG for approval not later than the end of the 1st Q 2006.

3.3 Upon adoption of the revised URs by IACS Council, **Machinery Panel** is to send them to CIMAC for their information and requesting that CIMAC notify the equipment suppliers of the requirements.

Regards,

Robert D. Somerville

IACS Council Chairman

email protected and scanned by BIS Advanced Spam & Virus Checking - powered by AdvascanTM  
- keeping email useful

**GYH**

---

**From:** AIACS@eagle.org  
**Sent:** 14 November 2005 22:00  
**To:** iacs@bureauveritas.com; iacs@ccs.org.cn; iacs@dnv.com; iacs@gl-group.com;  
 krsiacs@krs.co.kr; iacs@lr.org; clnkiacs@classnk.or.jp; iacs@rina.org; iacs@rs-head.spb.ru;  
 johnderose@iacs.org.uk; colinwright@iacs.org.uk; gilyonghan@iacs.org.uk;  
 terryperkins@iacs.org.uk; efs@iacs.org.uk; richardleslie@iacs.org.uk;  
 helenbutcher@iacs.org.uk  
**Cc:** MCH-Panel@gl-group.com  
**Subject:** 4069IGk: UR M66, M67 - application date

Date: 14 Nov 05

TO: Mr. R.D. Somerville, IACS Council Chairman

CC: IACS Council Members  
 CC: IACS GPG Members

CC: IACS Machinery Panel Chairman: Dr. U. Petersen

CC: IACS Permanent Secretary: Mr. R. Leslie

FROM: S.R. McIntyre

File Ref: T-12-2

Subject: 4069IGk: UR M66, M67 - application date

1. IACS has been requested, via the Machinery Panel, by CIMAC and MAN/B&W, to postpone the 1 Jan 06 implementation date for the type testing requirements for crankcase explosion relief valves and crankcase oil mist detection/monitoring and alarm arrangements contained in IACS URs M66 and M67, respectively. Their request is to give the equipment manufacturers and the engine builders more time to adapt to the new requirements. Industry has also recommended the need for some improvements/clarifications in the two URs, which the Machinery Panel has agreed are needed/appropriate.

1.1 Since CIMAC was involved in the IACS decision, some years ago, to develop these URs, in retrospect it would have been advisable to submit the URs for external review by CIMAC before their adoption to ensure that CIMAC would be fully aware of the requirements and the timetable for their implementation--and working with IACS Societies to ensure that their suppliers were apprised of and complying with the new requirements. Unfortunately, this was not done.

1.2 The type testing requirements of URs M66 and M67 are invoked in recent revisions of M9 and M10, respectively.

2. The Machinery Panel recommended that GPG postpone implementation of URs M66 and M67 and advised GPG that both URs need to be updated/clarified.

2.1 Several Members have also advised that they needed more time for initial implementation and could not implement the two URs from 1 Jan 06 as had been originally agreed by Council.

3. Having carefully considered the input from CIMAC, MAN/B&W, the Machinery Panel and Members, GPG agrees that IACS should postpone the implementation of these URs by one year to give time for updating them, vetting the changes with CIMAC, notifying industry and for Members to process the related rule changes. Therefore, GPG requests Council's agreement to the following course of action:

3.1 URs M66 and M67, along with M9.8 of M9, Rev.3 and M10.8 of M10, Rev.2 are to be withdrawn pending the updating of M66 and M67, which needs to be accomplished as quickly as possible (ie. the target date of 1st Q 2006 for revising M66, agreed at GPG 59, needs to be accelerated);

3.2 The updated URs, once adopted at Panel level are to be sent to CIMAC by the Machinery Panel for quick review/comment by CIMAC, and then further updated by the Panel in light of any comments received, prior to submission to GPG/Council;

3.3 The updated URs M66 and M67, once adopted by GPG/Council, are to be issued as "Corr" (since the initial versions will never have been implemented)--with uniform application from 1 Jan 2007 (instead of 1 Jan 2006);

3.4 M9, Rev.3 without M9.8, and M10, Rev. 2, without M10.8, are to be reissued as "Corr" until the updated M66 and M67 are adopted by Council, at which time M9.8 and M10.8 are to be included in M9, Rev.4 and M10, Rev.3, respectively for application from 1 Jan 2007.

4. Council Chairman is kindly requested to seek Council's agreement to this course of action as soon as possible.

Regards,

S.R. McIntyre

IACS GPG Chairman

email protected and scanned by BIS Advanced Spam & Virus Checking - powered by AdvascanTM  
- keeping email useful

## Technical Background

### UR M10 (Rev. 3, Sept 2008) and UI SC 228 (New, Dec 2008)

#### Existing SOLAS Regulation Analysis

SOLAS Reg. II-1/27.5 requires:

*Main turbine propulsion machinery and, where applicable, main internal combustion propulsion machinery and auxiliary machinery shall be provided with automatic shutoff arrangements in the case of failures ....which could lead rapidly to .... serious damage or explosion. The administration may permit overriding automatic shutoff devices.*

SOLAS Reg. II-1/31.2.10 requires:

*Automation systems shall be designed in a manner which ensures that threshold warning of impending or imminent slowdown or shutdown of the propulsion machinery is given to the officer in charge of the navigational watch in time to assess the navigational circumstances in an emergency. In particular, the system shall control, monitor, alert and take safety action to slow down or stop propulsion while providing the officer in charge of the navigational watch an opportunity to manually intervene, except for those case where manual intervention will result in total failure of the engine and/or propulsion equipment within a short time, for example in the case of overspeed.*

SOLAS Reg. II-1/31.3 requires:

*Where the main propulsion and associated machinery, including sources of main electrical supply, are provided with various degrees of automatic or remote control and are under continuous manual supervision from a control room the arrangements and controls shall be so designed, equipped and installed that the machinery operation will be as safe and effective as if it were under direct supervision; for this purpose regulations 46 to 50 shall apply as appropriate. Particular consideration shall be given to protect such spaces against fire and flooding.*

SOLAS Reg. II-1/47.2 requires:

*Internal combustion engines of 2,250 kW and above or having cylinders of more than 300 mm bore shall be provided with crankcase oil mist detectors or engine bearing temperature monitors or equivalent devices.*

#### Summarising SOLAS:

Engines are to be fitted with safety system shutting off the engines to prevent serious damage or explosion and overrides may be permitted.

The safety system, either in attended or unattended machinery spaces, is to alert and take action (alarm + slow down or stop) but, when action is taken on the propulsion system, the watch officer is to be given an opportunity to intervene (alarm + override), except for those case where manual intervention will result in total failure of the engine and/or propulsion equipment within a short time.

For periodically unattended machinery, engines larger than a given size are to be equipped with oil mist detectors or bearing temperature monitors or equivalent devices (SOLAS does not specify which action they are to initiate); the same applies to machinery systems under automatic or remote control or under remote manual supervision.

#### Existing IACS UR Analysis

- IACS UR M10 in item 10.8 gives a requirement applicable to oil mist detectors (including type testing to UR M67), but does not require an oil mist detector (OMD) to be fitted.
- IACS UR M35 Table 1 (slow speed main engines in unattended machinery spaces) requires an OMD to be installed and give alarm and **slow** down.
- IACS UR M35 Table 2 (medium speed main engines in unattended machinery spaces) requires an OMD to be installed and give alarm and **shut** down.
- (IACS UR M36 Table 1 (auxiliary engines in unattended machinery spaces) requires an OMD to be installed and give alarm and shut down).



- IACS UR M67 gives standard type testing conditions for OMD.

**Summarising IACS URs:**

OMD (or equivalent arrangements) is to be fitted only to engines when installed in an unattended machinery space.

The actions to be taken are described in M35, M36.

The alarm system is to be in accordance with M29.

The safety system is to be in accordance with M30.

The OMD is to be type tested in accordance with M.67

**Assessment of ISO TC8/SC1 WD 7240-26 "Fire detection and alarm systems - Point type oil mist detectors"**

This document has been considered.

Summary of review:

It addresses requirements applicable to oil mist detectors to be used in open spaces for fire detection systems in buildings and vessels. (It is not deemed applicable to oil mist detectors to be used in engine crankcases, even if some part could be used as guidance).

**Summarising findings – changes to M10 and new SC228**

It is recognized that:

1. An OMD is a safety device and this also applies to bearing temperature devices and equivalent devices where fitted instead of an OMD.
2. Where OMD arrangements or alternative arrangements are used to initiate slow down, an alarm is to be given before intervention of the safety system.
3. Where OMD arrangements or alternative arrangements are used to initiate shut down, the alarm may be given upon intervention of safety system.
4. Where arrangements are provided for overriding a safety system, they are to be such that inadvertent operation is prevented.
5. Visual indication is to be given at the relevant control station(s) when a safety override is operated.
6. The consequences of overriding a safety system are to be established and documented.

The Rev.3 of UR M10 and a new UI SC228 has been prepared to address the above.

Submitted by Machinery Panel Chairman  
30 July 2008

**Permanent Secretariat note (January 2009):**

- UR M10 Rev.3 was approved, with the following implementation statement, by GPG on 11 September 2008 (ref. 6098\_IGj):

*"Note:*

*1) The requirements of M10 Rev. 3 are to be uniformly implemented by IACS Societies for engines:*

*i) when an application for certification of an engine is dated on or after 1 January 2010; or*

*ii) which are installed in new ships for which the date of contract for construction is on or after 1 January 2010.*

*2) The "contract for construction" date means the date on which the contract to build the vessel is signed between the prospective owner and the shipbuilder. For further details regarding the date of "contract for construction", refer to IACS Procedural requirement (PR) No.29."*

- After initial review by GPG new UI SC228 was returned to Machinery Panel to clarify a possible discrepancy between the UI text and revised UR M10.8, before being approved by GPG on 22 December 2008 (ref. 6098\_IGI).

## Technical Background (TB) document for UR M10 (Rev.4 July 2013)

### 1 Scope and objectives

Introducing definitions for Low-, Medium- and High-Speed Engines in the new UR M71 made it necessary to investigate the effect on other documents using these terms.

The changes introduced are not expected have any effect on the technical content of the UR, the sole purpose is to align the documents.

### 2 Engineering background for technical basis and rationale

Requirements in the URs applicable to I.C. engines do depend upon engine speed and engine design. It was therefore necessary to introduce definitions of engine speed in the newly developed UR M71.

### 3 Source/derivation of the proposed IACS Resolution

UR M71

### 4 Summary of Changes intended for the revised Resolution

It was considered in the panel that the applicability of different requirement is better defined by making reference to engine speed. Hence the same definitions have been introduced.

### 5 Points of discussions or possible discussions

This task was triggered by IACS Machinery Panel as a result of discussion of a Member's proposal during 15<sup>th</sup>, 16<sup>th</sup> and 17<sup>th</sup> Panel Meetings. Definitions for Low-, Medium- and High-Speed Engines were introduced in the new UR M71 "Type Testing of I.C. Engines".

### 6 Attachments if any

None



# **Technical Background**

## **Revision of M16 (Rev.1)**

M16 dates back to 1974 and has not been revised since then. A revision is necessary of following reasons:

1. The wording “safety device” implies that it should be function tested. All safety functions are normally required to be verified by testing, except these devices for emergency operation. In order to justify this practice the heading should be altered to just “devices for emergency.....”.
2. M16 mentions no verification of the devices. Full verification by testing various combinations during sea trial is considered too much (see 1), but a trial mounting before the sea trial should be required.
3. M16 does not require any minimum power in these emergency operating conditions. Without a certain minimum the objective of these devices is unclear.
4. M16 does not require specification of available/permissible power in the various combinations. This should be available onboard.
5. A high permissible power in these emergency operating conditions may jeopardise the last stage reduction gearing due to the influence of shaft alignment on gear faceload distribution. This potential problem should be addressed.

Submitted by WP/MCH Chairman  
02 December 2004

IACS WP/MCH  
TECHNICAL BACKGROUND DOCUMENT

**Rev.4, M18 – Parts of internal combustion engines for which material tests are required.**

2.1 Scope and objectives

The item is covered by Task 41. Question was put forward by DNV. Ref. fax DNV J-450 dated 1999-07-02.

2.2 Points of discussion

A discussion was initiated based on DNV's earlier input.

*It was agreed that the term "Supercharger" used in UR M18.2 and M23 is to be understood as turbochargers and engine driven compressors (incl. "Root blowers"), but not auxiliary blowers.*

The question "mass produced" or "non-mass produced" is considered quite important as to UR M18.2/M23. It appears that Manufacturer Survey Arrangements (MSAs) are currently issued based on conditions actually not covered by IACS UR, and IACS members' normal procedures are to some extent differing from the procedure laid out in the URs.

*It was agreed to take this matter up later as a separate task in order to clarify/rectify the requirements given in M18.5.*

*As to M 18.1 and M18.2, it was agreed to propose this revised as follows:*

- *Amend M18.1: The list given below applies to engines and superchargers not covered by M5 and M23*
- *Amend M18.2 (xiv): Supercharger shaft and rotor, including blades (Supercharger is understood as turbochargers and engine driven compressors (incl. "Root blowers"), but not auxiliary blowers).*

2.3 Source/derivation of proposed requirements

Initiated by question forwarded by DNV in their fax DNV J-450 dated 1999-07-02.

2.4 Decision by voting.

All WP/MCH members agreed in above.

## Technical Background for Rev.5, M 20

### 1. Scope of objectives

This revision is to introduce a requirement for machinery verification run during dry docking to verify safe operation of main and auxiliary machinery. This is one of the outcomes of the ESP Tripartite (IACS, OCIMF, INTERTANKO) technical Working Group which was held on 15 October 1999 in London.

### 2. Points of discussions or possible discussions

- BV (GPG) did not agree to the first sentence of the proposed requirement in that it is the owners' responsibility to check the machinery installations are in good operational condition after a ship is re-floated. However, all Council unanimously agreed to the amendment.
- NEW MVR Requirement has been positioned in new section M 20.5. Originally it was proposed to place it under UR Z7 with change to its title "Hull Classification Surveys and Machinery Verification Runs". Subsequent GPG discussion yielded that it should be placed in UR Z 18, however, the Permsec suggested to put it in M 20 since the Z 18 had not been formally adopted.

### 3. Source/derivation of proposed requirements

The final minute of the Tripartite meeting reads (C 40/6/WP.1):

- IACS has given further consideration to this item and proposed the following wording for inclusion in IUR Z7:  
"At the time of dry docking a dock trial is to be carried out to attending surveyors' satisfaction to confirm satisfactory operation of main and auxiliary machinery. If significant repairs are carried out to main or auxiliary machinery or steering gear, consideration should be given to a sea trial to attending surveyors' satisfaction.
- The Working Group agreed to the above wording.
- This measure would be applicable to any type of ship but would not be recorded in the CER for Tankers.

Prepared by the IACS Permanent Secretariat

**Technical Background Document**  
**WP/SRC Task 1**  
**New UR Z 18, Z21 and deletion of M20**  
**(+ Rev.8 of Z7)**

**Objective and Scope:**

To review existing UR M 20 and relocate it as a UR under UR Z.

**Source of Proposed Requirements:**

WP/SRC Chairman reported by e-mail 6 May 1999 that WP/SRC Members had discussed and reviewed the requirements contained in UR M20 through correspondence and at their last meeting and had relocated the text of M20 to a new UR Z18. A proposal for resolving ABS' existing reservations against M20 is included in the proposed UR Z18.

**Points of Discussion:**

WP/SRC unanimously agreed to the proposed draft UR Z 18.

Note by the Permanent Secretariat

GPG did not accept WP/SRC's proposal for resolving ABS' reservations since the proposal would not, in fact, lead to any greater uniformity in practice than by simply retaining ABS' existing reservations, and therefore did not approve the proposed UR Z18, pending receipt and consideration of an acceptable means of resolving ABS' reservations from the ABS GPG representative. The ABS GPG representative reported to GPG, at its 51<sup>st</sup> meeting on 2-4 October 2001 that ABS was not prepared to change its practice and that he could not identify any means of resolving ABS' reservations without significant change to other Members practices, which other Members were not prepared to accept.

Therefore, GPG expressed its preparedness to live with ABS reservation to the tail shaft survey requirements of ex M20 (now Z21), agreed to isolate it from Z18.

Outcome:

- Delete M 20;
- Create new Z18 excluding tail shaft survey requirements;
- Create new Z21 for the tail shaft survey requirements.
- Revision 8 of Z7 to have the same descriptions of special survey as those in Z10s and Z18.

(GPG considered it prudent to keep Revision 8 of Z7 in abeyance until WP/SRC complete its Task 83 "revision of Z7".)

Date of submission: 6 May 1999  
By WP/SRC Chairman's e-mail

## UR M24 “Requirements concerning use of crude oil or slops as fuel for tanker boilers”

### Summary

This UR provides requirements for tankers where crude oil or slops are used as fuel for boilers. This revision clarifies that the UR will not be applicable when low flash point crude oil is used, and the design is subject to SOLAS regulation II-1/55.

### Part A. Revision History

Version no.	Approval date	Implementation date when applicable
Rev.2 (August 2023)	07 August 2023	1 January 2025
Rev.1 (1976)	No record	-
New (1975)	No record	-

#### • Rev.2 (August 2023)

##### 1 Origin of Change:

- Other (*FUA No.9 of GPG 85 - update of the Rule linkage table*)

##### 2 Main Reason for Change:

Revision 2 of UR M24 aims to clarify whether UR M24 shall be applied additionally with engineering analysis as stated in SOLAS regulation II-1/55 or the design and construction should follow SOLAS regulation II-1/55 or UR M24, i.e., when requirements in UR M24 are followed, it should be understood being complying with requirements in SOLAS regulation II-1/55.

##### 3 List of non-IACS Member classification societies contributing or participating in IACS Working Group:

None.

##### 4 History of Decisions Made:

1. Following a member suggestion, it was agreed M24.7 (renumbered to M24.8) should be referred to from UR P2.1 under task PM20906f (see PM20906aIMc).

2. Members agreed that UR M24 should not be directly applied to ship subject to IGF code (PM20906aIMb) and therefore new M24.1 was added to the UR. Noting that the main point to consider for the application of UR M24 is then whether crude oil is low flash point or not and that generally crude oil is low flash point, members agreed to the proposed text for M24.1 stating that UR M24 is applicable to tankers where crude oil or slops are used as fuel for boilers except where there is

conflict with alternative design and arrangements required in accordance with SOLAS II-1/55 (PM20906aIMh).

**5 Other Resolutions Changes:**

As indicated in §4 History of decisions made, a reference to M24.8 will be referred to in UR P2.1.

**6 Any hinderance to MASS, including any other new technologies:**

None.

**7 Dates:**

Original Proposal	: 19 January 2021	(Ref: PM210906aIMa)
Panel Approval	: 03 May 2023	(Ref: PM20906aIMi)
GPG Approval	: 07 August 2023	(Ref: 23055_IGd)

• **Rev.1 (1976)**

No records available.

• **New (1975)**

No records available.

\*\*\*\*\*



## **Part B. Technical Background**

List of Technical Background (TB) documents for UR M24:

### **Annex 1. TB for Rev.2 (August 2023)**

See separate TB document in Annex 1.

*Note: There are no Technical Background (TB) documents available for New (1975) and Rev.1 (1976).*

## **Technical Background (TB) document for UR M24 Rev.2 (August 2023)**

### **1. Scope and objectives**

To clarify application of the UR versus the alternative design and arrangements of SOLAS Reg. II-1/55.

### **2. Engineering background for technical basis and rationale**

A review of UR M24 Rev.1 was undertaken by the Machinery Panel to identify any inconsistency with the IGF Code, considering as starting point whether crude oil or slops are regarded as low-flashpoint fuel defined in SOLAS Reg. II-2/2.30.

### **3. Source/derivation of the proposed IACS Resolution**

The subject revision is an outcome of FUA No. 9 of GPG 85, which tasked the Machinery Panel to take action on records kept by IACS on the status of URs.

### **4. Summary of Changes intended for the revised Resolution:**

An introductory paragraph has been inserted clarifying that where conflict is identified between the UR provisions and the alternative requirements of SOLAS Reg. II-1/55, the SOLAS requirements take precedence. Due to the new paragraph, the subsequent paragraphs have been renumbered.

### **5. Points of discussions or possible discussions**

1. On a query whether crude oil/slops can never have a flash point equal to 60C or above, or they usually have a flash point (FP) of less than 60°C, according to received member's replies, the crude oil flash point is in general below 60°C , however there might be some cases in which the FP can exceed 60°C .
2. UR M24.1 newly added in the UR M24 (Rev.2) was provided on the basis of the conclusion that UR M24 should not be directly applied to ships subject to the IGF code. Therefore, what is important is not "whether crude oil is used as fuel", but "whether crude oil is low-flashpoint fuel".

If crude oil used as fuel for boilers is not low-flashpoint fuel, then UR M24 will be applied, and if crude oil used as fuel for boilers is low-flashpoint fuel, then SOLAS II-1/55 will be applied taking precedence over UR M24. In the latter case, if there is a conflict between the requirements of UR M24 and SOLAS II-1/55, then it is necessary to follow SOLAS II-1/55, including engineering analysis.

### **6. Attachments if any**

None.

## UR M25 “Astern power for main propulsion”

### Part A. Revision History

Version no.	Approval date	Implementation date when applicable
Rev.4 (June 2017)	15 June 2017	1 July 2018
Rev.3 (July 2003)	-	-
Rev.2 (1997)	-	-
Rev.1 (1984)	-	-
New (1975)	-	-

#### • Rev.4 (June 2017)

##### .1 Origin of Change:

- Based on Vessel Incident (Saffier and Key Bora)

##### .2 Main Reason for Change:

This task has been received from GPG (e-mail 12095\_IGb dated 9 July 2012), which has requested the Machinery Panel to review the MAIB report and to submit to GPG its views and the preferred possible course of actions. The MAIB report addresses the investigation of the failure of the controllable pitch propeller (CPP) of the cargo ship Saffier resulting in heavy contact with a berthed tug in Immingham harbour on 25 June 2011.

In connection with the incident, it was agreed during the 18<sup>th</sup> meeting of the Machinery Panel that:

- a. developing a UR Zxx is the appropriate way to address this matter, and
- b. the scope of this task should be extended to cover on-board tests required in case of retrofit of essential machinery, not limited to CPPs.

Additionally, another MAIB accident investigation report (No 31/2014) for KEY BORA, which made heavy contact with the jetty because the CPP's astern response was inadequate and did not develop sufficient astern thrust in time to stop the vessel, was also taken into consideration.

Consequently, it was agreed to develop:

- a. a UR Zxx “On-board tests required during commissioning of essential equipment and systems for propulsion”, to address the on-board tests to be carried out for new essential equipment and systems and also for replacement, modification, repair or re-adjustment of existing essential equipment and systems for propulsion; and
- b. new requirements for UR M25 to specifically address astern manoeuvring trials.

On 30 November 2016, the Survey panel Chairman informed Machinery panel Chairman, by PM12601\_PYb, that Survey Panel members unanimously agreed that there was no need to issue a new UR Zxx but the UR Z18 would be modified accordingly, in order to address the above matters, by the introduction of a new paragraph 4.2. This proposal was also agreed by machinery panel members by PM12601\_IMr dated 26 December 2016.

### **.3 List of non-IACS Member Classification Societies contributing through the TC Forum and/or participating in IACS Working Group:**

None

### **.4 History of Decisions Made:**

Form A agreed by Panel and submitted to GPG under 12095\_PMa dated 4 November 2014. The Form A was developed taking into account the decision of the Panel to:

- expand the scope of the task and develop a UR Zxx to address on-board testing during commissioning of essential equipment and systems for propulsion, not limited to CPP systems
- to develop new requirements for UR M25 to specifically address astern manoeuvring trials.

GPG required (under 14181\_IAa dated 10 November 2014) the KEY BORA case to be addressed by the Panel.

Final versions of UR Zxx and UR M25 (Rev.4) were approved by Panel during the 23<sup>rd</sup> meeting in March 2016.

The final text of the new paragraph 4.2 of UR Z18 was agreed by machinery panel members by PM12601\_IMs dated 27 February 2017 and communicated to the Survey panel chairman. On that occasion machinery panel members also agreed on the inclusion in the note of the draft UR M25 of the following statements which refers to UR Z18:

*"(b) ships other than those specified in the preceding (a) on which astern testing is carried out in accordance with Z18 on or after 1 July 2018."*

Final version of UR M25 (Rev.4) was approved by Panel by PM12601\_IMv dated 24 May 2017.

### **.5 Other Resolutions Changes**

None

### **.6 Dates:**

Original Proposal: 04 July 2013                      Made by Machinery Panel Member  
Panel Approval: 24 May 2017 (Ref: PM12601)  
GPG Approval: 15 June 2017 (Ref 12095\_IGi)

- **Rev.3 (July 2003)**

Refer to Annex 1 in Part B.

- **Rev.2 (1997)**

No TB document available

- **Rev.1 (1984)**

No TB document available.

- **New (1975)**

No TB document available.

## Part B. Technical Background

List of Technical Background (TB) documents for UR M25:

Annex 1     **TB for Rev.3 (July 2003)**

See separate TB document in Annex 1.



Annex 2     **TB for Rev.4 (June 2017)**

See separate TB document in Annex 2.



*Note: There are no separate Technical Background (TB) documents for New (1975), Rev.1 (1984) and Rev.2 (1997).*

**Technical Background (TB) document for UR M25 (Rev.3 July 2003)**

WP/MCH Task 61 "M25.1 regarding duration of astern trials". WP/MCH submitted proposed amendments to M25.1 requiring that the main propulsion machinery should be capable of reversing the direction of thrust so as to bring the ship to rest from maximum service speed.

NK Council clarified what should have been written in M25.2. Agreed.

## **Technical Background (TB) document for UR M25 (Rev.4 June 2017)**

### **1. Scope and objectives**

The objectives of the task were to:

a) Develop a UR Zxx "ON-BOARD TESTS REQUIRED FOR COMMISSIONING OF ESSENTIAL EQUIPMENT AND SYSTEMS FOR PROPULSION", to address the on-board tests to be carried out for:

- new essential equipment and systems intended for propulsion
- replacement, modification, repair or re-adjustment of existing essential equipment and systems for propulsion.

b) Develop new requirements for UR M25 to specifically address astern manoeuvring trials.

With reference to the objectives as per item a) above, in November 2016 Survey panel members agreed to introduce a new paragraph in UR Z18 instead of developing a new UR Zxx. This proposal was also agreed by machinery panel members by PM12601\_IMr dated 26 December 2016

### **2. Engineering background for technical basis and rationale**

This task was triggered by the UK MAIB and their report on the investigation of the failure of the controllable pitch propeller of the cargo ship Saffier. The MAIB requested IACS to develop a unified requirement stating that, during commissioning trials of new and existing CPP systems, the response times for ahead and astern pitch demand are also recorded and verified to be in accordance with the values expected by the CPP system manufacturer.

After discussions within the Panel, it was decided to expand the scope of the task to on-board tests for commissioning of essential equipment and systems for propulsion.

### **3. Source / derivation of the proposed IACS Resolution**

- MAIB Report on the investigation of the failure of the controllable pitch propeller of the cargo ship Saffier resulting in heavy contact with a berthed tug in Immingham harbour on 25 June 2011, Report No. 9/2012, May 2012.
- MAIB accident investigation report (No. 31/2014) for KEY BORA, which made heavy contact with the jetty because the CPP's astern response was inadequate and did not develop sufficient astern thrust in time to stop the vessel.

### **4. Summary of Changes intended for the revised Resolution**

- Addition of M25.4 requiring on-board tests to demonstrate the astern response characteristics of essential equipment and systems for propulsion.
- Rearrangement of Footnote 2 as M25.5.



## **5. Points of discussions or possible discussion**

The position of one member was to require tests to demonstrate that the response time for any pitch change was acceptable. The Panel decided not to follow this position as UR M25 covers only the astern operation of the ship and accordingly, to limit the application of the requirement to astern pitch demand.

## **6. Attachments if any**

None

## UR M27 “Bilge level alarms for unattended machinery spaces”

### Summary

UR M27 duplicated with SOLAS regulation II-1/48 was deleted.

### Part A. Revision History

Version no.	Approval date	Implementation date when applicable
Del (Mar 2022)	08 March 2022	-
New (1976)	1976	-

#### • Del (Mar 2022)

##### 1 Origin of Change:

- Other (Periodical review carried out by Machinery Panel)

##### 2 Main Reason for Change:

UR M27 duplicated with SOLAS regulation II-1/48 was deleted in accordance with IACS Procedure Volume 1 so that possible conflicts with statutory requirements (e.g., in the case where alternative design and arrangements according to SOLAS regulation II-1/55 against the regulation II-1/48 are applied) can be avoided.

##### 3 List of non-IACS Member classification societies contributing or participating in IACS Working Group:

None

##### 4 History of Decisions Made:

None

##### 5 Other Resolutions Changes:

None

##### 6 Any hinderance to MASS, including any other new technologies:

None

**7 Dates:**

Original Proposal	: 20 January 2021	(Ref: PM20906bIMa)
Panel Approval	: 19 January 2022	(Ref: PM20906bIMd)
GPG Approval	: 08 March 2022	(Ref: 20206fIGb)

- **New (1976)**

No documents are available.

\*\*\*\*\*

## Part B. Technical Background

List of Technical Background (TB) documents for UR M27:

**Note:** *There are no Technical Background (TB) documents available for New (1976) and Del (Mar 2022).*

# UR M31 “Continuity of electrical power supply for vessels with periodically unattended machinery spaces”

## Summary

UR M31 who contains no additional requirements to SOLAS except for the “45 seconds” requirement was deleted.

## Part A. Revision History

Version no.	Approval date	Implementation date when applicable
Del (Jan 2023)	20 January 2023	-
New (1978)	1978	-

### • Del (Jan 2023)

#### 1 Origin of Change:

- Other (Periodical review carried out by Machinery Panel)

#### 2 Main Reason for Change:

UR M31 who contains no additional requirements to SOLAS except for the “45 seconds” requirement was deleted.

#### 3 List of non-IACS Member classification societies contributing or participating in IACS Working Group:

None

#### 4 History of Decisions Made:

Taking into account the case where SOLAS regulations II-1/41.5 and II-1/53.2 are not applied to ships (e.g., non-SOLAS ships and ships to which *Alternative Design and Arrangements* as per Part E of SOLAS Chapter II-1 are applied), discussion was conducted on whether the “45 seconds” requirement should be retained in this UR subject to development of exemption clauses for the following ships: (1) ships subject to the said alternative design and arrangements and (2) ships whose propulsion and steering systems are independent from the main source of electrical power (including such ships to which SOLAS does not apply).

The Panel has, based upon its Members’ (the qualified majority’s) preference, decided to delete both the requirements in UR M31 duplicated to SOLAS and the “45 seconds” requirement, noting that this deletion does not affect IACS Members’ decision to keep the latter requirement in an appropriate manner in their Rules i.e. they can specify more stringent requirements than those set out by URs in their Rules.

**5 Other Resolutions Changes:**

None

**6 Any hinderance to MASS, including any other new technologies:**

None

**7 Dates:**

Original Proposal	: 01 February 2021	(Ref: PM20906cIMa)
Panel Approval	: 12 August 2022	(Ref: PM20906cIMf)
GPG Approval	: 20 January 2023	(Ref: 20206hIGb)

• **New (1978)**

No history files or TB document available.

\*\*\*\*\*

## Part B. Technical Background

List of Technical Background (TB) documents for UR M31:

**Note:** *There are no Technical Background (TB) documents available for the original version (1978) and Del (Jan 2023).*

**WP/MCH Task 41**  
**Technical Justification for revision of**

**M33 M37 M38 M39 M48**

**and**

**new UR M68**

CIMAC established a working group (WG14) for the purpose of getting a unified practice among Classification Societies on the topic of shafting and permissible torsional vibrations.

This WG14 concluded the work by the end of 2002, however, with a more restricted scope than the original. The original scope included issues for both 4-stroke and 2-stroke plants, but it soon became clear that due to the limited time (all to be within 2002) only 2-stroke plants with fixed pitch propellers could be handled.

It was the intention of WG14 that the agreements of 2002 should be reflected in the rules of the participating societies (ABS, GL, LR and DNV).

During the IACS MCH meeting in London 2003, it was agreed that actions should be taken versus very old URs, meaning a) confirm b) revise or c) delete. Among other, the above mentioned URs were chosen because:

- All 5 UR are interconnected and partly repeat each other
- Reservations were made (e.g. DNV)
- Several societies practiced considerable deviations from the UR
- WG14 had concluded on something different (for 2-stroke)
- Design features for controllable pitch propellers lacking

After revising the technical contents of the 5 URs, it was intended to merge them into one UR. The 4-stroke issues of WG14 (that were not in the agreement of 2002) had little or no relevance for the revision of these URs which only dealt with shafts. Of that reason the revision should include all relevant kinds of shafts.

The draft UR replaces M33, M37, M38, M39 and M48.

Note: This UR applies to ships constructed for construction from 1 July 2006.



## UR M35 “Alarms, remote indications and safeguards for main reciprocating I.C. engines installed in unattended machinery spaces”

### Summary

This UR provides requirements for alarms, remote indications and safeguards for main reciprocating I.C. engines installed in unattended machinery spaces

### Part A. Revision History

Version no.	Approval date	Implementation date when applicable
Rev.8 (Jan 2019)	23 January 2019	01 January 2020
Rev.7 (Mar 2016)	04 March 2016	01 July 2017
Rev.6 (July 2013)	24 July 2013	01 January 2015
Rev.5 (Aug 2008)	28 August 2008	01 January 2010
Rev.4 (1999)	03 March 1999	-
Rev.3 (1997)	12 May 1997	-
Rev.2 (1996)	<i>No records</i>	-
Rev.1 (1993)	<i>No records</i>	-
New (1980)	<i>No records</i>	-

#### • Rev.8 (Jan 2019)

##### .1 Origin of Change:

- Suggestion by IACS member

##### .2 Main Reason for Change:

To align requirements of UR M35 with requirements of UR M10.8 regarding the use of engine bearing temperature monitors or equivalent devices instead of oil mist detection arrangement to protect the engine crankcases.

##### .3 List of non-IACS Member classification societies contributing through the TC Forum and/or participating in IACS Working Group:

None

##### .4 History of Decisions Made:

The matter was offered and discussed at 27<sup>th</sup> Machinery Panel Meeting (27 Feb to 02 March 2018) and agreed during 28<sup>th</sup> Meeting (18 – 21 September 2018).

## **.5 Other Resolutions Changes**

None

## **.6 Dates:**

Original Proposal: February 2018 by Machinery Panel  
Panel Approval: 28 November 2018 (Ref. PM18908\_IMg)  
GPG Approval: 23 January 2019 (Ref. 18141\_IGh)

### **• Rev 7 (Mar 2016)**

#### **.1 Origin of Change:**

- Suggestion by IACS member

#### **.2 Main Reason for Change:**

To make consistent with UR M73; UR M73.5 requires turbocharger speed alarm for Categories B and C turbochargers but UR M35 does not cover them.

#### **.3 List of non-IACS Member classification societies contributing through the TC Forum and/or participating in IACS Working Group:**

None

#### **.4 History of Decisions Made:**

It was unanimously agreed to add the speed of turbocharger to monitoring item.

## **.5 Other Resolutions Changes**

None

## **.6 Dates:**

Original Proposal: November 2015 by Machinery Panel  
Machinery Panel Approval: 2 February 2016 (Ref: PM15906)  
GPG Approval: 4 March 2016 (Ref: 16028\_IGb)

### **• Rev 6 (July 2013)**

#### **.1 Origin of Change:**

- Suggestion by IACS member

#### **.2 Main Reason for Change:**

To exclude definitions for Low-, Medium- and High-Speed Engines and introduce terms "cross-head" and "trunk-piston" engines to describe the engine type to which the requirements apply.

**.3 List of non-IACS Member classification societies contributing through the TC Forum and/or participating in IACS Working Group:**

None

**.4 History of Decisions Made:**

The matter was discussed by Machinery Panel under PM 12407 during 16th and 17th Meetings and all members agreed to the introduction of the terms "cross-head" and "trunk-piston" engines instead of introducing the definitions "Low-, Medium- and High-Speed engines made in UR M71 as was the reason for initiating the task.

**.5 Other Resolutions Changes**

None

**.6 Dates:**

Original Proposal: September 2012 by Machinery Panel

Machinery Panel Approval: 25 June 2013

GPG Approval: 24 July 2013 (Subject No: 12189\_IGb)

- **Rev 5 (Aug 2008)**

Reference: 4069bIAb. Please see TB document in Annex 1 for details.

- **Rev 4 (1999)**

Revision to Table 1, item 4 & Table 2, item 2 and heading of Table 2 on page M35-5. There is no TB document available.

- **Rev 3 (1997)**

Extended footnote 3 to Table 2. Amendment to satisfy the requirement for independence between alarms and control (shut-down) system. There is no TB document available.

- **Rev 2 (1996)**

No records available.

- **Rev 1 (1993)**

No records available.

- **New (1980)**

No records available.

## **Part B. Technical Background**

List of Technical Background (TB) documents for UR M35:

### **Annex 1. TB for Rev.5 (Aug 2008)**

See separate TB document in Annex 1.

### **Annex 2. TB for Rev.6 (July 2013)**

See separate TB document in Annex 2.

### **Annex 3. TB for Rev.8 (Jan 2019)**

See separate TB document in Annex 3.

*Note: There are no Technical Background (TB) documents available for New (1980), Rev.1 (1993), Rev.2 (1996), Rev.3 (1997), Rev. 4 (1999) and Rev.7 (Mar 2016).*

**Technical Background Document**  
**Revision of UR M35 (Revision 5, August 2008)**  
**Revision of UR M36 (Revision 3, September 2008)**

**Alarms, remote indications and safeguards for main reciprocating I.C. engines  
installed in unattended machinery spaces**

**Objective and Scope:**

The aim of Task 5101 was to review the alarm requirements in UR M35 for oil mist detection (OMD) and turbocharger lubricating oil in comparison with slow speed engines and medium / high speed engines.

Further, to update the UR to reflect on modern engine design and to develop new requirements for fuel or hydraulic oil pressure monitoring of newly introduced electronically controlled diesel engines (E-engines).

Finally, the clarity of the information provided in the columns of Tables 1 and 2 was to be improved. For consistency reasons UR M36 was also to be reviewed with respect to requirements for fuel and hydraulic oil pressure monitoring on E-engines as well as the format of the table.

**Background:**

The background for the proposed modification / additions in the UR M35 has two aspects.

First: the harmonization of Table 1 and Table 2 of UR M35

and second: the development of new requirements for fuel or hydraulic oil pressure monitoring on E-engines.

**Points of discussion:**

A discussion developed around requirements for OMD. It has been pointed out that at present OMD is not regarded as a safety device and only required for unattended machinery spaces. Further, it has been suggested, that remote indication is needed to keep personnel away from the engine when an alarm is triggered. The Panel considered that there is still a problem with the reliability of the OMD alarm signal and that this needs to be taken into account when considering possible corrective action, such as engine slowdown or shutdown.

UR M35 was discussed in conjunction with UR M10 and there was a general view that OMD or alternative arrangements should be required for both attended and unattended machinery spaces. It has been agreed to introduce this in M10.

This would make the installation of OMD or alternative arrangements mandatory for all engines independent from the operational mode. The power limitation from Note 3 in Table 1 of UR M35 Rev.4 should also be added.

Finally, it has been decided to modify footnote 9 and 10 of table 1 and footnote 8 of table 2. With the changes in the footnotes M35 can be applied regardless of a different design of turbocharger lubrication.

To reflect on changes in the design of modern electronically controlled diesel engines there was agreement to introduce a low pressure alarm for common rail fuel oil and rail servo oil pressure.

### **Conclusion:**

Following changes to Table 1 and Table 2 in UR M35 have been agreed:

#### M35, Table 1 and 2, 1.0, add new item:

- "Common rail fuel oil pressure"; alarm pressure low

#### M35, Table 1 and 2, 2.0, add new item:

- "Common rail servo oil pressure"; alarm pressure low

#### M35, Table 1 9.0, change the wording to:

- "Exhaust gas temp. after each cylinder"

#### M35, Table 1, 3.0, add Notes 9 and 10:

- 9) Unless provided with a self-contained lubricating oil system integrated with the turbocharger (also Note 5 in Table 2).
- 10) Where outlet temperature from each bearing cannot be monitored due to the engine/turbocharger design alternative arrangements may be accepted.

#### M35, Table 2, 3.0, add new item and Note 8:

- New item: Turbocharger lub. oil temperature each bearing
- 8) Where outlet temperature from each bearing cannot be monitored due to the engine/turbocharger design alternative arrangements may be accepted.

#### M35, Table 1 and Table 2, Note 3:

- Add reference to OMD requirements in UR M10.8 or SOALS Reg. II-1/47.2

#### M36, Table 1:

- Add low level alarm for common rail fuel and servo oil pressure

The changes have been agreed unanimously by Panel members.

GPG approval, UR M35(Rev.5): 28 August 2008, s/n 4069bIGh  
GPG approval, UR M36(Rev.3): 22 September 2008, s/n 4069cIGb.

## **Technical Background (TB) document for UR M35 (Rev.6 July 2013)**

### **1 Scope and objectives**

Introducing definitions for Low-, Medium- and High-Speed Engines in the new UR M71 made it necessary to investigate the effect on other documents using these terms.

The changes introduced is not expected have any effect on the technical content of the UR, the sole purpose is to align the documents.

### **2 Engineering background for technical basis and rationale**

Requirements in the URs applicable to I.C. engines do depend upon engine speed and engine design. It was therefore necessary to introduce definitions of engine speed in the newly developed UR M71.

### **3 Source/derivation of the proposed IACS Resolution**

UR M71

### **4 Summary of Changes intended for the revised Resolution**

It was considered in the panel that the applicability of different requirement respectively in Tab 1 and Tab2 is better defined by making reference to Engine Design, rather than engine speed.

### **5 Points of discussions or possible discussions**

This task was triggered by IACS Machinery Panel as a result of discussion of a Member's proposal during 15<sup>th</sup>, 16<sup>th</sup> and 17<sup>th</sup> Panel Meetings. Definitions for Low-, Medium- and High-Speed Engines were introduced in the new UR M71 "Type Testing of I.C. Engines".

### **6 Attachments, if any**

None



## **Technical Background (TB) document for UR M35 (Rev.8 Jan 2019)**

### **1 Scope and objectives**

To align requirements of UR M35 with requirements of UR M10.8 regarding the use of engine bearing temperature monitors or equivalent devices instead of oil mist detection arrangement to protect the engine crankcases.

### **2 Engineering background for technical basis and rationale**

There is the discrepancy between requirements of UR M10.8 regarding the use of engine bearing temperature monitors or equivalent devices instead of oil mist detection arrangements to protect the engine crankcases and relevant fields in the Tables of parameters provided in UR M35 with regard to the respective alarms, shut-downs and slow-downs. UR M10.8 allows usage of engine bearing temperature monitors or equivalent devices instead of oil mist detection arrangements, however there is nothing in the relevant fields of UR M35.

Second and more important issue is the necessity to define the respective requirements for engine bearing temperature monitors and equivalent devices by the same way how it done for oil mist detector by introduction of UR M67. Due to increasing of demand for such monitors and devices and respective solutions existed on the market it is vital to provide the industry and Class Societies with common agreed requirements for approval of equivalent monitors/devices and further for unified and consistent application of the latter on the ship's main and auxiliary I.C. Engines

### **3 Source/derivation of the proposed IACS Resolution**

UR M10

### **4 Summary of Changes intended for the revised Resolution**

The items "2.0 Lubrication oil system" of Table 1 and Table 2 of UR M35 as well as the Note n.3 of Table 2 have been modified in order to be aligned with the text used in UR M10.8.

### **5 Points of discussions or possible discussions**

The final text was agreed by correspondence.

### **6 Attachments, if any**

None



## UR M36 “Alarms and safeguards for auxiliary reciprocating internal combustion engines driving generators in unattended machinery spaces”

### Summary

This UR provides requirements for alarms and safeguards for auxiliary reciprocating internal combustion engines driving generators in unattended machinery spaces.

### Part A. Revision History

Version no.	Approval date	Implementation date when applicable
Rev.6 (Dec 2018)	17 December 2018	1 January 2020
Rev.5 (Mar 2016)	04 March 2016	1 July 2017
Rev.4 (July 2013)	24 July 2013	1 January 2015
Rev.3 (Sep 2008)	22 September 2008	1 January 2010
Rev.2 (June 2000)	15 June 2000	-
Rev.1 (1993)	No records	-
New (1980)	No records	-

- **Rev 6 (Dec 2018)**

.1 Origin of Change:

- Suggestion by IACS member

.2 Main Reason for Change:

To align requirements of UR M36 with requirements of UR M10.8 regarding the use of engine bearing temperature monitors or equivalent devices instead of oil mist detection arrangement to protect the engine crankcases.

.3 List of non-IACS Member classification societies contributing through the TC Forum and/or participating in IACS Working Group:

None

.4 History of Decisions Made:

The matter was offered and discussed at 27<sup>th</sup> Machinery Panel Meeting (27 Feb to 02 March 2018) and agreed during 28<sup>th</sup> Meeting (18 – 21 September 2018).

.5 Other Resolutions Changes

None

**.6 Dates:**

Original Proposal: February 2018

Panel Approval: 28 November 2018 (Ref: PM18908\_IMg)

GPG Approval: 17 December 2018 (Ref: 18141\_IGe)

**• Rev 5 (Mar 2016)**

**.1 Origin for Change:**

- Suggestion by IACS member

**.2 Main Reason for Change:**

To make consistent with UR M73. UR M73.5 requires turbocharger speed alarm for Categories B and C turbochargers but UR M36 does not cover them.

**.3 List of non-IACS Member Classification Societies contributing through the TC Forum and/or participating in IACS Working Group:**

None

**.4 History of Decisions Made:**

It was unanimously agreed to add the speed of turbocharger to monitoring item.

**.5 Other Resolutions Changes**

None

**.6 Dates:**

Original Proposal: November 2015 by Machinery Panel

Panel Approval: 2 February 2016 (Ref: PM15906)

GPG Approval: 4 March 2016 (Ref: 16028\_IGb)

**• Rev 4 (July 2013)**

**.1 Origin of Change:**

- Suggestion by IACS member

**.2 Main Reason for Change:**

To introduce term "trunk-piston engines" instead of Medium-/High-Speed Engines.

**.3 List of non-IACS Member classification societies contributing through the TC Forum and/or participating in IACS Working Group:**

None

#### .4 History of Decisions Made:

The matter was discussed by Machinery Panel under PM 12407 during 16th & 17th Meetings and all members agreed with the introduction of the term "trunk-piston engines instead of Medium-/High-Speed I.C. Engines.

#### .5 Other Resolutions Changes

None

#### .6 Dates:

Original Proposal: September 2012 by Machinery Panel  
Machinery Panel Approval: 25 June 2013  
GPG Approval: 24 July 2013 (Subject No: 12189\_IGb)

- **Rev 3 (Sept 2008)**

Reference: 4069cIGb. Please see TB document in Annex 2 for details.

- **Rev 2 (June 2000)**

Approved at GPG 48. Please see TB document in Annex 1 for details.

- **Rev 1 (1993)**

No records available.

- **New (1980)**

No records available.

## Part B. Technical Background

List of Technical Background (TB) documents for UR M36:

Annex 1. TB for Rev.2 (June 2000)

See separate TB document in Annex 1.

Annex 2. TB for Rev.3 (Sep 2008)

See separate TB document in Annex 2.

Annex 3. TB for Rev.4 (July 2013)

See separate TB document in Annex 3.

Annex 4. TB for Rev.6 (Dec 2018)

See separate TB document in Annex 4.

*Note: There are no Technical Background (TB) documents available for New (1980), Rev.1 (1993) and Rev.5 (Mar 2016).*

IACS WP/MCH  
TECHNICAL BACKGROUND DOCUMENT

**Rev.2, M36 – Alarms and safeguards for auxiliary reciprocating internal combustion engines driving generators in unattended machinery spaces.**

2.1 Scope and objectives

The item is covered by Task 41, and dealt with under item 6.2 at WP/MCH's 40<sup>th</sup> meeting. Main objective was to achieve agreement as to a revised UR M36 which could be accepted by all IACS parties without reservations.

2.2 Points of discussion

The subject was thoroughly discussed at WP/MCH's 40<sup>th</sup> meeting. In this respect it was expressed that:

- Continuous review and updating of both IACS UR M35 and M36 is foreseen necessary also for the future.
- With regards to IACS UR M35 and M36, the requirement "shut down" is to be considered as more conservative than "slow down". Accordingly each Society will be free to request "shut down" by their Rules where IACS UR request "slow down" only, without giving any reservation.

As to revision of current IACS UR M36 it was concluded (all parties agreed) to propose to GPG the following alterations to be made:

- *A new requirement (based on NK's proposal) to be included in Table 1 requesting Alarm (high and low value) for "Fuel oil viscosity before injection pumps or Fuel oil temp before injection pumps". A footnote to be added to said requirement stating: "For heavy fuel oil burning engines only".*
- *A new requirement (based on NK's proposal) to be included in Table 1 requesting Alarm (high) for "Exhaust gas temperature after each cylinder". A footnote to be added stating: " For engine power above 500 kW/cyl.*

2.2 Source/derivation of proposed requirements

Earlier discussions within WP/MCH, input from CIMAC and proposal from NK.

2.3 Decision by voting.

All WP/MCH members agreed in above.

Submitted by WP/MCH Chairman on 10 May 2000

**Technical Background Document**  
**Revision of UR M35 (Revision 5, August 2008)**  
**Revision of UR M36 (Revision 3, September 2008)**

**Alarms, remote indications and safeguards for main reciprocating I.C. engines  
installed in unattended machinery spaces**

**Objective and Scope:**

The aim of Task 5101 was to review the alarm requirements in UR M35 for oil mist detection (OMD) and turbocharger lubricating oil in comparison with slow speed engines and medium / high speed engines.

Further, to update the UR to reflect on modern engine design and to develop new requirements for fuel or hydraulic oil pressure monitoring of newly introduced electronically controlled diesel engines (E-engines).

Finally, the clarity of the information provided in the columns of Tables 1 and 2 was to be improved. For consistency reasons UR M36 was also to be reviewed with respect to requirements for fuel and hydraulic oil pressure monitoring on E-engines as well as the format of the table.

**Background:**

The background for the proposed modification / additions in the UR M35 has two aspects.

First: the harmonization of Table 1 and Table 2 of UR M35

and second: the development of new requirements for fuel or hydraulic oil pressure monitoring on E-engines.

**Points of discussion:**

A discussion developed around requirements for OMD. It has been pointed out that at present OMD is not regarded as a safety device and only required for unattended machinery spaces. Further, it has been suggested, that remote indication is needed to keep personnel away from the engine when an alarm is triggered. The Panel considered that there is still a problem with the reliability of the OMD alarm signal and that this needs to be taken into account when considering possible corrective action, such as engine slowdown or shutdown.

UR M35 was discussed in conjunction with UR M10 and there was a general view that OMD or alternative arrangements should be required for both attended and unattended machinery spaces. It has been agreed to introduce this in M10.

This would make the installation of OMD or alternative arrangements mandatory for all engines independent from the operational mode. The power limitation from Note 3 in Table 1 of UR M35 Rev.4 should also be added.

Finally, it has been decided to modify footnote 9 and 10 of table 1 and footnote 8 of table 2. With the changes in the footnotes M35 can be applied regardless of a different design of turbocharger lubrication.

To reflect on changes in the design of modern electronically controlled diesel engines there was agreement to introduce a low pressure alarm for common rail fuel oil and rail servo oil pressure.

### **Conclusion:**

Following changes to Table 1 and Table 2 in UR M35 have been agreed:

#### M35, Table 1 and 2, 1.0, add new item:

- "Common rail fuel oil pressure"; alarm pressure low

#### M35, Table 1 and 2, 2.0, add new item:

- "Common rail servo oil pressure"; alarm pressure low

#### M35, Table 1 9.0, change the wording to:

- "Exhaust gas temp. after each cylinder"

#### M35, Table 1, 3.0, add Notes 9 and 10:

- 9) Unless provided with a self-contained lubricating oil system integrated with the turbocharger (also Note 5 in Table 2).
- 10) Where outlet temperature from each bearing cannot be monitored due to the engine/turbocharger design alternative arrangements may be accepted.

#### M35, Table 2, 3.0, add new item and Note 8:

- New item: Turbocharger lub. oil temperature each bearing
- 8) Where outlet temperature from each bearing cannot be monitored due to the engine/turbocharger design alternative arrangements may be accepted.

#### M35, Table 1 and Table 2, Note 3:

- Add reference to OMD requirements in UR M10.8 or SOALS Reg. II-1/47.2

#### M36, Table 1:

- Add low level alarm for common rail fuel and servo oil pressure

The changes have been agreed unanimously by Panel members.

GPG approval, UR M35(Rev.5): 28 August 2008, s/n 4069bIGh  
GPG approval, UR M36(Rev.3): 22 September 2008, s/n 4069cIGb.

## Technical Background (TB) document for UR M36 (Rev.4 July 2013)

### 1 Scope and objectives

Introducing definitions for Low-, Medium- and High-Speed Engines in the new UR M71 made it necessary to investigate the effect on other documents using these terms.

The changes introduced is not expected have any effect on the technical content of the UR, the sole purpose is to align the documents.

### 2 Engineering background for technical basis and rationale

Requirements in the URs applicable to I.C. engines do depend upon engine speed and engine design. It was therefore necessary to introduce definitions of engine speed in the newly developed UR M71.

### 3 Source/derivation of the proposed IACS Resolution

UR M71

### 4 Summary of Changes intended for the revised Resolution

It was considered in the panel that the applicability of different requirement respectively in Tab 1 and Tab2 is better defined by making reference to Engine Design, rather than engine speed.

### 5 Points of discussions or possible discussions

This task was triggered by IACS Machinery Panel as a result of discussion of a Member's proposal during 15<sup>th</sup>, 16<sup>th</sup> and 17<sup>th</sup> Panel Meetings. Definitions for Low-, Medium- and High-Speed Engines were introduced in the new UR M71 "Type Testing of I.C. Engines".

### 6 Attachments, if any

None





## **Technical Background (TB) document for UR M36 (Rev.6 Dec 2018)**

### **1 Scope and objectives**

To align requirements of UR M36 with requirements of UR M10.8 regarding the use of engine bearing temperature monitors or equivalent devices instead of oil mist detection arrangement to protect the engine crankcases.

### **2 Engineering background for technical basis and rationale**

There is the discrepancy between requirements of UR M10.8 regarding the use of engine bearing temperature monitors or equivalent devices instead of oil mist detection arrangements to protect the engine crankcases and relevant fields in the Tables of parameters provided in UR M36 with regard to the respective alarms, shut-downs and slow-downs. URM10.8 allows usage of engine bearing temperature monitors or equivalent devices instead of oil mist detection arrangements, however there is nothing in the relevant fields of UR M36.

Second and more important issue is the necessity to define the respective requirements for engine bearing temperature monitors and equivalent devices by the same way how it done for oil mist detector by introduction of UR M67. Due to increasing of demand for such monitors and devices and respective solutions existed on the market it is vital to provide the industry and Class Societies with common agreed requirements for approval of equivalent monitors/devices and further for unified and consistent application of the latter on the ship`s main and auxiliary I.C. Engines

### **3 Source/derivation of the proposed IACS Resolution**

UR M10

### **4 Summary of Changes intended for the revised Resolution**

Table 1 of UR M36 as well as the Note n.3 of this table have been modified in order to be aligned with the text used in UR M10.8.

### **5 Points of discussions or possible discussions**

The final text was agreed by correspondence.

### **6 Attachments, if any**

None

**WP/MCH Task 41**  
**Technical Justification for revision of**

**M33 M37 M38 M39 M48**

**and**

**new UR M68**

CIMAC established a working group (WG14) for the purpose of getting a unified practice among Classification Societies on the topic of shafting and permissible torsional vibrations.

This WG14 concluded the work by the end of 2002, however, with a more restricted scope than the original. The original scope included issues for both 4-stroke and 2-stroke plants, but it soon became clear that due to the limited time (all to be within 2002) only 2-stroke plants with fixed pitch propellers could be handled.

It was the intention of WG14 that the agreements of 2002 should be reflected in the rules of the participating societies (ABS, GL, LR and DNV).

During the IACS MCH meeting in London 2003, it was agreed that actions should be taken versus very old URs, meaning a) confirm b) revise or c) delete. Among other, the above mentioned URs were chosen because:

- All 5 UR are interconnected and partly repeat each other
- Reservations were made (e.g. DNV)
- Several societies practiced considerable deviations from the UR
- WG14 had concluded on something different (for 2-stroke)
- Design features for controllable pitch propellers lacking

After revising the technical contents of the 5 URs, it was intended to merge them into one UR. The 4-stroke issues of WG14 (that were not in the agreement of 2002) had little or no relevance for the revision of these URs which only dealt with shafts. Of that reason the revision should include all relevant kinds of shafts.

The draft UR replaces M33, M37, M38, M39 and M48.

Note: This UR applies to ships constructed for construction from 1 July 2006.

**WP/MCH Task 41**  
**Technical Justification for revision of**

**M33 M37 M38 M39 M48**

**and**

**new UR M68**

CIMAC established a working group (WG14) for the purpose of getting a unified practice among Classification Societies on the topic of shafting and permissible torsional vibrations.

This WG14 concluded the work by the end of 2002, however, with a more restricted scope than the original. The original scope included issues for both 4-stroke and 2-stroke plants, but it soon became clear that due to the limited time (all to be within 2002) only 2-stroke plants with fixed pitch propellers could be handled.

It was the intention of WG14 that the agreements of 2002 should be reflected in the rules of the participating societies (ABS, GL, LR and DNV).

During the IACS MCH meeting in London 2003, it was agreed that actions should be taken versus very old URs, meaning a) confirm b) revise or c) delete. Among other, the above mentioned URs were chosen because:

- All 5 UR are interconnected and partly repeat each other
- Reservations were made (e.g. DNV)
- Several societies practiced considerable deviations from the UR
- WG14 had concluded on something different (for 2-stroke)
- Design features for controllable pitch propellers lacking

After revising the technical contents of the 5 URs, it was intended to merge them into one UR. The 4-stroke issues of WG14 (that were not in the agreement of 2002) had little or no relevance for the revision of these URs which only dealt with shafts. Of that reason the revision should include all relevant kinds of shafts.

The draft UR replaces M33, M37, M38, M39 and M48.

Note: This UR applies to ships constructed for construction from 1 July 2006.

**WP/MCH Task 41**  
**Technical Justification for revision of**

**M33 M37 M38 M39 M48**

**and**

**new UR M68**

CIMAC established a working group (WG14) for the purpose of getting a unified practice among Classification Societies on the topic of shafting and permissible torsional vibrations.

This WG14 concluded the work by the end of 2002, however, with a more restricted scope than the original. The original scope included issues for both 4-stroke and 2-stroke plants, but it soon became clear that due to the limited time (all to be within 2002) only 2-stroke plants with fixed pitch propellers could be handled.

It was the intention of WG14 that the agreements of 2002 should be reflected in the rules of the participating societies (ABS, GL, LR and DNV).

During the IACS MCH meeting in London 2003, it was agreed that actions should be taken versus very old URs, meaning a) confirm b) revise or c) delete. Among other, the above mentioned URs were chosen because:

- All 5 UR are interconnected and partly repeat each other
- Reservations were made (e.g. DNV)
- Several societies practiced considerable deviations from the UR
- WG14 had concluded on something different (for 2-stroke)
- Design features for controllable pitch propellers lacking

After revising the technical contents of the 5 URs, it was intended to merge them into one UR. The 4-stroke issues of WG14 (that were not in the agreement of 2002) had little or no relevance for the revision of these URs which only dealt with shafts. Of that reason the revision should include all relevant kinds of shafts.

The draft UR replaces M33, M37, M38, M39 and M48.

Note: This UR applies to ships constructed for construction from 1 July 2006.

## UR M42 “Steering Gear”

### Summary

In Rev.6 of this Resolution, the definition of hydraulic locking has been clarified.

### Part A. Revision History

Version no.	Approval date	Implementation date when applicable
Rev.6 (Mar 2022)	03 March 2022	1 July 2023
Corr.1 (Oct 2021)	22 October 2021	-
Rev.5 (Feb 2021)	12 February 2021	1 July 2022
Rev.4 (June 2011)	27 June 2011	1 July 2012
Rev.3 (1997)	12 May 2011	-
Rev.2 (1995)	1998	-
Rev.1 (1986)	1986	-
New (1982)	1982	-

#### • Rev.6 (Mar 2022)

##### 1 Origin of Change:

- Suggestion by IACS member

##### 2 Main Reason for Change:

To clarify the definition of hydraulic locking.

##### 3 List of non-IACS Member classification societies contributing or participating in IACS Working Group:

None

##### 4 History of Decisions Made:

The Revision 6 was discussed by correspondence and agreed at the 34<sup>th</sup> Panel Meeting (from 31<sup>th</sup> August to 2<sup>th</sup> September 2021)

##### 5 Other Resolutions Changes:

UR E25(Rev.2)

##### 6 Any hinderance to MASS, including any other new technologies:

None

## **.7 Dates:**

Original Proposal : 11 May 2020 (Ref: PM20801\_IMa)  
Panel Approval : 20 January 2022 (Ref: PM20801\_IMI)  
GPG Approval : 03 March 2022 (Ref: 22013\_IGc)

### **• Corr.1 (Oct 2021)**

#### **1 Origin of Change:**

- Suggestion by IACS member

#### **2 Main Reason for Change:**

Application statement No. 1 needed clarification that it applies to Rev.4 of this UR.

#### **3 List of non-IACS Member classification societies contributing or participating in IACS Working Group:**

None

#### **4 History of Decisions Made:**

It was agreed that application statement No. 1 should be clarified. The way to refer to specific SOLAS regulations was also changed.

#### **5 Other Resolutions Changes:**

None

#### **6 Any hinderance to MASS, including any other new technologies:**

None

## **7 Dates:**

Original Proposal : 16 June 2021 (Ref: PM20906IIMa)  
Panel Approval : 06 October 2021 (Ref: PM20906IIMc)  
GPG Approval : 22 October 2021 (Ref: 20206dIGd)

### **• Rev.5 (Feb 2021)**

#### **1 Origin of Change:**

- Other (Periodical review to ascertain that the Resolution is suitable for the latest developments in technology)

#### **2 Main Reason for Change:**

There was a need to ascertain that this UR is suitable for the latest developments in technology.

**3 List of non-IACS Member classification societies contributing or participating in IACS Working Group:**

None

**4 History of Decisions Made:**

None

**5 Other Resolutions Changes:**

None

**6 Any hinderance to MASS, including any other new technologies:**

None

**7 Dates:**

Original Proposal: 28 October 2019 (Ref: PM18939\_IMd)  
Panel Approval: 9 November 2020 (Ref: PM20906\_IMf)  
GPG Approval: 12 February 2021 (Ref: 20206dIGb)

• **Rev.4 (June 2011)**

**1 Origin of Change:**

- Based on IMO Regulation (SOLAS II-1 regulation 29.3.2 & 29.4.2)

**2 Main Reason for Change:**

To develop a UI in respect of SOLAS Regulations II-1/29.3.2 and 29.4.2 and establish conditions for ships which cannot achieve deepest seagoing draught at the trial to replace the alternative requirement in UR M42.15(i).

**3 List of non-IACS Member classification societies contributing through the TC Forum and/or participating in IACS Working Group:**

None

**4 History of Decisions Made:**

PT agreed that no amendment to SOLAS II-1 regulation 29 would be necessary and that the draft UI to be developed by the team would be sufficient to meet the objectives of the task.

Review of DNV proposed method completed and the need for experimental data confirmed as necessary to verify the predicted steering gear loads for steering gear when rudders are partially submerged.

Reference to ISO 19019:2005 Sea-going vessels and marine technology – Instructions for planning, carrying out and reporting sea trials agreed by the PT as the reference procedure for all ships which are not at deepest seagoing draught. Draft UI and Proposed amendment to URM42 developed to support this reference.

Additional conditions were developed by the team to be applied when testing steering gear in accordance with the ISO instructions on all occasions when ships were not at the deepest draught for the trial, in order to establish reliable and consistent test methodology.

## **5 Other Resolutions Changes:**

UI SC246 (New June 2011) developed in respect of the panel task in conjunction with the UR amendment proposal.

- **Rev.3 (1997)**

No history file or TB document available.

- **Rev.2 (1995)**

No history file or TB document available.

- **Rev.1 (1986)**

No history file or TB document available.

- **New (1981)**

No history file or TB document available.

\*\*\*\*\*



## **Part B. Technical Background**

List of Technical Background (TB) documents for UR M42:

Annex 1. **TB for Rev.4 (June 2011)**

See separate TB document in Annex 1.

Annex 2. **TB for Rev.5 (Feb 2021)**

See separate TB document in Annex 2.

Annex 3. **TB for Corr.1 (Oct 2021)**

See separate TB document in Annex 3.

Annex 4. **TB for Rev.6 (Mar 2022)**

See separate TB document in Annex 4.

**Note:**

*There is no separate Technical Background (TB) document for UR M42 New (1981).*

# Technical Background for UR M42 Rev.4, June 2011

## 1. Scope and objectives

To establish alternative steering gear trial conditions for vessels which cannot be tested at their deepest seagoing draught and to develop a UI in respect of SOLAS Regulations II-1/29.3.2 and 29.4.2 and based on this interpretation consider whether/how UR M42.15(i) is compatible with UI and propose amendments to M42.15(i) as necessary.

## 2. Engineering background for technical basis and rationale

The SOLAS regulations require that the main steering gear and rudder stock shall be:

- of adequate strength and capable of steering the ship at maximum ahead service speed which shall be demonstrated; and
- capable of putting the rudder over from 35° on one side to 35° on the other side with the ship at its deepest seagoing draught and running ahead at maximum ahead service speed and, under the same conditions, from 35° on either side to 30° on the other side in not more than 28 s

Alternative steering gear trial conditions to those where the vessel is at the deepest sea going draught, which is normally equal to the summer load line, are considered necessary for certain ship types in order to provide acceptable testing conditions. In order to establish a sound and uniform practice, the draft UI is suggested to refer to ISO 19019:2005 and through a proposed amendment to UR M42 allow the trial requirements contained in the ISO instructions to replace the requirement for alternative testing provided that the loading condition specified will result in predictable trial conditions in compliance with UR M42.15(i) as proposed for amendment.

The extant ISO 19019:2005 Sea-going vessels and marine technology – Instructions for planning, carrying out and reporting sea trials contains a procedure to demonstrate the performance requirements of SOLAS regulations for steering gear and refers to the loading condition for the ship to be as close as practical to full load displacement. This procedure is referenced to replace the specially considered clause in M42.15, subject to additional conditions developed by the team to establish consistent and reliable testing for ships not tested at the deepest sea-going draught.

## 3. Source/derivation of the proposed IACS Resolution

For ships not at the deepest sea-going draught for the steering gear trial ISO 19019:2005 Sea-going vessels and marine technology – Instructions for planning, carrying out and reporting sea trials is referenced. The following extracts are relevant and applicable:

### 6.1 Steering gear trials

#### 6.1.1 Purpose

Steering gear trials are performed to verify the performance of the steering gear and to demonstrate its efficiency.

### 6.1.2 Trials specification

If the loading condition is not contractually specified, steering gear trials shall be conducted at a displacement as close as reasonably possible to full-load displacement for merchant ships and warships.

and;

#### 6.1.5.1 Ahead-steering-gear trial

With the main propulsion engines delivering maximum continuous rating ahead or at the corresponding shaft speed, the following rudder manoeuvres shall be executed.

The first direction of rudder movement, i.e. port or starboard, shall be at the discretion of the trial captain, considering the conditions in the area. The following description is for first rudder deflection to port.

- a) Amidships to 35° port — Hold for sufficient duration in order to record time taken, at the steering gear, between rudder amidships and 30°;
- b) 35° port to 35° starboard — Hold approximately 10 s; record time taken, at the steering gear, between 35° hardover to 30° to the opposite side (as the steering gear is slowing down between 30° and hardover);
- c) 35° starboard to 35° port — Hold approximately 10 s; record time taken between 35° starboard and 30° port;
- d) 35° port to amidships — Record time taken between 35° port and rudder amidships;
- e) trial completed.

This trial shall be repeated for each power unit of the steering gear and, if possible, for both units acting together. For emergency power units, trials shall be performed at reduced speed and reduced rudder angles. Setting of the propulsion plant of a single-screw main propulsion system shall not be changed during the trial; however, change in throttle adjustment or propeller pitch in the case of a controllable-pitch propeller plant or multi-screw main propulsion systems is permissible during the trial to avoid overload or overspeed. If the maximum rudder angle is less than 35°, the maximum possible rudder angle shall be used, with time determined to the maximum angle minus 5°, as above.

The additional requirements to be satisfied during the trial were developed and agreed by the PT to establish consistent and reliable trial conditions for all occasions when the trial is undertaken with the ship not at the deepest sea-going draught.

## **4. Summary of Changes intended for the revised Resolution:**

To replace the 'alternative trial conditions may be specially considered' term in UR M42.15(i) with specific requirements when the loading condition for the ship at the steering gear trial is contractually specified to be other than the deepest seagoing draft or the ship cannot achieve deepest draught to test in accordance with ISO 19019:2005 subject to additional conditions for consistent and reliable testing.

Proposed amendment

### 15. Trials

The steering gear should be tried out on the trial trip in order to demonstrate to the Surveyor's satisfaction that the requirements of the Rules have been met. The trial is to include the operation of the following:

(i) the steering gear, including demonstration of the performances required by Regulation 29.3.2 and 29.4.2. For controllable pitch propellers, the propeller pitch is to be at the maximum design pitch approved for the maximum continuous ahead R.P.M. at the main steering gear trial.

If the vessel cannot be tested at the deepest draught, ~~alternative trial conditions may be specially considered as stated in Section 6.1.5.1 of ISO 19019:2005~~ Sea-going vessels and marine technology – Instructions for planning, carrying out and reporting sea trials are to be applied.

If the loading condition is such that the ship is not at the deepest draught, steering gear trials shall be conducted at a displacement as close as reasonably possible to full-load displacement as required by Section 6.1.2 of ISO 19019:2005 on the conditions that either the rudder is fully submerged (zero speed waterline) and the vessel is in an acceptable trim condition, or the rudder load and torque at the specified trial loading condition have been predicted and extrapolated to the full load condition.

In this case for the main steering gear trial, the speed of ship corresponding to the number of maximum continuous revolution of main engine ~~is to~~ is to apply.

## **5. Points of discussions or possible discussions**

SOLAS II-1/29.3.2 and 29.4.2

Reviewed by the PT in order to generate a UI for the performance requirements for the main and auxiliary steering gear

UR M42.15(i)

Reviewed by the PT in order to establish requirements to replace the alternative trial conditions with specific reference to ISO 19019:2005 Sea-going vessels and marine technology – Instructions for planning, carrying out and reporting sea trials subject to additional conditions developed by the PT.

From work specification items for the panel task:

A review of the DNV proposal "Steering gear test with partly submerged rudder" was completed and an evaluation of the need for experimental data was completed, it was considered necessary that experimental data would be required to verify the proposed method.

## **6. Attachments if any**

None

## **Technical Background (TB) document for UR M42 (Rev.5 Feb 2021)**

### **1. Scope and objectives**

Periodical review to ascertain that the Resolution is suitable for the latest developments in technology.

### **2. Engineering background for technical basis and rationale**

#### **References to IMO instruments**

***Format:***

*regulation/paragraph x.x.x of SOLAS Chapter X/MARPOL Annex X/the XXX Code, as amended by IMO resolutions up to MSC.xx(xx)/MEPC.xx(xx)*

The note of CAUTION of Section 13 (Operating instructions) applicable only to existing ships has been deleted, taking into account that Rev.5 is applied only to new ships.

### **3. Source/derivation of the proposed IACS Resolution**

None

### **4. Summary of Changes intended for the revised Resolution:**

See item 2 above.

### **5. Points of discussions or possible discussions**

Technical validity of the requirement as per UR M42(Rev.4) was confirmed.

### **6. Attachments if any**

None

## **Technical Background (TB) document for UR M42 (Corr.1 Oct 2021)**

### **1. Scope and objectives**

Application statement No. 1 needed clarification that it applies to Rev.4 of this UR.

### **2. Engineering background for technical basis and rationale**

None

### **3. Source/derivation of the proposed IACS Resolution**

None

### **4. Summary of Changes intended for the revised Resolution:**

The change made to application statement No. 1 is as follows:

~~This revision of UR M42~~ Rev.4 of this UR applies to ships contracted for construction on or after 1 July 2012.

The way to refer to specific SOLAS regulations was also changed.

### **5. Points of discussions or possible discussions**

None

### **6. Attachments if any**

None

## **Technical Background (TB) document for UR M42 (Rev.6 Mar 2022)**

### **1. Scope and objectives**

To clarify the definition of hydraulic locking based on the guidance note which has been deleted from UI SC 94 Rev.1.

### **2. Engineering background for technical basis and rationale**

UR M42 12.2 specifies that an audible and visual alarm shall be provided on the navigating bridge, where hydraulic locking. In addition, it specifies two cases as triggers to activate the hydraulic locking. Regarding this requirement, a panel member found that a manufacturer had the following misunderstanding:

“Even if operating with only one hydraulic system, when either of the two cases specified in M42 12.2 is detected, it will lead to a situation that falls under the definition of hydraulic locking.”

A panel member pointed out that UI SC 94 Rev.1 had specified “hydraulic locking” as the following guidance note.

“Hydraulic locking means all situations where two hydraulic systems (usually identical) oppose each other in such a way that it may lead to loss of steering. It can either be caused by pressure in the two hydraulic systems working against each other or by hydraulic “by-pass” meaning that the systems puncture each other and cause pressure drop on both sides or make it impossible to build up pressure.”

Based on the above, the definition of hydraulic locking is added to UR M42 based on the guidance note which has been deleted from UI SC 94 Rev.1 to avoid misunderstanding.

### **3. Source/derivation of the proposed IACS Resolution**

None

### **4. Summary of Changes intended for the revised Resolution:**

The definition of hydraulic locking is added in UR M42 Appendix 1 based on the guidance note which has been deleted from UI SC 94 Rev.1.

In addition, the definition of steering gear control system in UR M42 Appendix 1 is aligned with the definition given in IACS SC94 to cover “the equipment required to control the steering gear power actuating system”.

### **5. Points of discussions or possible discussions**

None

### **6. Attachments if any**

None

## UR M43 “Bridge control of propulsion machinery”

### Summary

This UR provides requirements for the bridge control systems for propulsion machinery, for attended and unattended machinery spaces. In this revision requirements existing in SOLAS II-1/49 have been removed. Additionally, it includes requirements of attended machinery spaces which were in UR M47.

### Part A. Revision History

Version no.	Approval date	Implementation date when applicable
Rev.1 (Feb 2024)	02 February 2024	01 January 2025
New (1982)	No record	-

#### • Rev.1 (Feb 2024)

##### 1 Origin of Change:

- Other (FUA N°9 of GPG 85 - update of the Rule linkage table)

##### 2 Main Reason for Change:

Revision 1 of UR M43 aims at removing from the UR the requirements which can be considered as a duplication of what is required in SOLAS II-1/49. Additionally, UR M47 was referring to UR M43 and it was decided to transfer its requirements to UR M43.

##### 3 List of non-IACS Member classification societies contributing or participating in IACS Working Group:

None.

##### 4 History of Decisions Made:

- 1) Members agreed that paragraphs M43.1, M43.5, M43.9; M43.10, M43.11, M43.12, M43.13 and M43.14 can be deleted as they are considered as duplication of SOLAS II-1/49 requirements (PM20906dIMc).
- 2) Considering the current wording of UR M47 saying that UR M43 applies to the bridge control of propulsion machinery for all machinery spaces (unattended and attended) with the exception of clause M43.7 relating to steam turbines, members agreed that UR M47 can be transferred to UR M43.7 (Rev.0) and the title of UR M43 is changed to “Bridge control of propulsion machinery” instead of “Bridge control of propulsion machinery for unattended machinery spaces” (PM20906dIMc).
- 3) Members disagreed to delete requirements M43.2 (Rev. 0) but to modify it considering deletion of M43.1 (PM20906dIMd).



- 4) Members considered the risk that M43.8 (Rev. 0) could be seen as a relaxation of SOLAS II-1/49.5. It was decided to keep the requirements and modify it for ships not covered by the SOLAS convention (PM20906dIMg).

## **5 Other Resolutions Changes:**

UR M47 is deleted as its requirements are now included in UR M43.  
UR M3 is referring to deleted requirements of UR M43 and to UR M47.  
These references are to be deleted.

## **6 Any hinderance to MASS, including any other new technologies:**

The UR M43 requires control from bridge which precludes MASS operations.

## **7 Dates:**

Original Proposal	: 01 February 2021	(Ref: PM20906dIMa)
Panel Approval	: 10 January 2024	(Ref: 23186_PMa)
GPG Approval	: 02 February 2024	(Ref: 23186_IGc)

### **• New (1982)**

No record available.

## **Part B. Technical Background**

List of Technical Background (TB) documents for UR M43:

Annex 1. **TB for Rev. 1 (Feb 2024)**

See separate TB document in Annex 1.

## **Technical Background (TB) document for UR M43 (Rev 1 Feb 2024)**

### **1. Scope and objectives**

To delete requirements considered as duplication of SOLAS II-1/49, and to incorporate the exclusion provided by UR M47 in UR M43.

### **2. Engineering background for technical basis and rationale**

None.

### **2a. Specification of the data utilised in the development/revision of the proposed IACS Resolution, if any**

N/A.

### **3. Source/derivation of the proposed IACS Resolution**

The subject revision is an outcome of FUA No. 9 of GPG 85, which tasked the Machinery Panel to take actions on records kept by IACS on the status of URs.

### **4. Summary of Changes intended for the revised Resolution:**

Requirements considered as duplication of requirements existing in SOLAS II-1/49 are deleted: M43.1, M43.5, M43.9; M43.10, M43.11, M43.12, M43.13 and M43.14.

Requirements M43.2 and M43.8 have modified in order they cannot be considered as a duplication or a relaxation to existing SOLAS requirements. M43.8 is kept for ships not covered by the SOLAS convention.

By incorporating UR M47 requirement in a Note of UR M43.7 (renumbered as M43.5), the title of the UR has been modified.

Following the above modification, paragraphs have been renumbered.

### **5. Points of discussions or possible discussions**

The main point of discussion was concerning M43.8 (renumbered as M43.6) as some members found that there is a risk that M43.8 may be regarded as a relaxation to SOLAS regulation II-1/49.5 since, while the said regulation requires the preset speed and direction of thrust of the propeller to be maintained until local control is in operation unless the Administration considers it impracticable, UR M43.8 allows a change in propulsion power or direction of propeller rotation if it is not major and sudden under the condition of lack of power (electric, pneumatic, hydraulic).

While some members considered that lack of power could be a different failure mode from power failure, most members agreed that M43.8 is covered by SOLAS as the failure modes "lack of power (electric, pneumatic, hydraulic)" are part of the potential failures of a bridge control system covered by SOLAS II-1/49.5.

Finally, members decided to add an introductory sentence in the opening part of M43.8 without modification of other part of M43.8, which is advisable to avoid the risk that the remainder of M43.8 without the text of SOLAS Regulation II-1/49 may be regarded

as a relaxation to SOLAS regulation as if it does not require to maintain preset speed and direction and permits a change in propulsion power or direction of propeller rotation.

Other deleted requirements are covered by SOLAS II-1/49.

**6. Attachments if any**

None.

## UR M44 “Documents for the approval of diesel engines”

### Summary

In Corr.1 Rev.10 of this Resolution, footnote 5 of Tale 1 “The FMEA reports required will not be explicitly approved by the Classification Society” and an unpreferable phrase “by IMO resolutions up to MSC.472(101)” in Appendix 3 are deleted.

### Part A. Revision History

Version no.	Approval date	Implementation date when applicable
Corr.1 (Feb 2022)	28 February 2022	-
Rev.10 (Feb 2021)	12 February 2021	1 July 2022
Corr.2 (Nov 2016)	14 Nov 2016	-
Corr.1 (June 2016)	3 June 2016	-
Rev.9 (Dec 2015)	14 Dec 2015	1 July 2016
Rev.8 (Mar 2015)	12 March 2015	1 July 2016
Rev.7 (May 2004)	26 May 2004	-
Rev.6 (Nov 2003)	20 Nov 2003	-
Rev.5 (1992)	1992	-
Rev.4 (1989)	1989	-
Rev.3 (1986)	1986	-
Rev.2 (1984)	1984	-
Rev.1 (1983)	1983	-
New (1982)	1982	-

#### • Corr.1 (Feb 2022)

##### 1 Origin of Change:

- Other (A correction to make the UR M44 uniform with UR M60)

##### 2 Main Reason for Change:

To delete footnote 5 of Tale 1 “The FMEA reports required will not be explicitly approved by the Classification Society” and an unpreferable phrase “by IMO resolutions up to MSC.472(101)” in Appendix 3.

##### 3 List of non-IACS Member classification societies contributing or participating in IACS Working Group:

None

#### 4 History of Decisions Made:

During the review of UR M60 (Rev.1), a Member pointed out that UR M44, Table1, Footnote 5, states "*The FMEA reports required will not be explicitly approved by the Classification Society.*" However, there is no such mention in the draft revised UR M60(Rev.1). The Member further opined that, this statement should either be introduced in the draft UR M60(Rev.1) as well or be removed from UR M44, to maintain uniformity.

GPG noted that the documents listed in Table 1 in UR M44 (as the title of the table says) are for information only and not for approval (Documents for approval are listed in Table 2). Therefore, in Footnotes 5. of Table 1, 'The FMEA reports required will not be explicitly approved by the Classification Society' is considered redundant. Therefore, GPG decided to delete the above-mentioned text from UR M44.

Also, an unpreferable phrase "by IMO resolutions up to MSC.472(101)" in Appendix 3 has been deleted.

#### 5 Other Resolutions Changes:

None

#### 6 Any hinderance to MASS, including any other new technologies:

None

#### 7 Dates:

Original Proposal	: 08 November 2021	(Ref: 21163_IRa, Made by IACS Member)
Panel Approval	: 10 February 2022	(Ref: PM20002b)
GPG Approval	: 28 February 2022	(Ref: 21163aIGb)

#### • Rev.10 (Feb 2021)

#### 2 Origin of Change:

- Other (Update to comply with the required format when industry standards are referred to)

#### 2 Main Reason for Change:

There was a need to update this UR to comply with the following format when industry standards are referred to:

*[Standard Designation], [version/revision, if applicable], [year of publication]*  
*(examples: API Spec 2F, 6th Edition, 1997; ISO 4624, 2002), where*  
*[version/revision, if applicable] and/or [year of publication] are decided by IACS*  
*and*

*are not necessarily to be the current/latest version.*

To take this opportunity, references to IMO instruments have been specified in the following format based upon confirmation of amendments up to the latest one:

*regulation/paragraph x.x.x of SOLAS Chapter X/MARPOL Annex X/the XXX Code, as amended by IMO resolutions up to MSC.xx(xx)/MEPC.xx(xx)*

### **3 List of non-IACS Member classification societies contributing or participating in IACS Working Group:**

None

### **4 History of Decisions Made:**

None

### **5 Other Resolutions Changes:**

None

### **6 Any hinderance to MASS, including any other new technologies:**

None

### **7 Dates:**

Original Proposal: 28 October 2019 (Ref: PM18939\_Imd)  
Panel Approval: 9 November 2020 (Ref: PM20906\_Imf)  
GPG Approval: 12 February 2021 (Ref: 20206dIGb)

## **• Corr.2 (Oct 2016)**

### **1 Origin of Change:**

- Suggestion by a Machinery Panel Member

### **2 Main Reason for Change:**

- a. UR M44 (Corr.1) defines the documentation to be submitted for approval in Table 2, particularly Item Nos. 20 and 21 require submission of drawings of construction of accumulators and common accumulators for electronically controlled engines with common rail fuel injection system. However, some electronically controlled diesel engines (e.g. those designed by MAN Diesel & Turbo) are equipped with one complete electro-mechanical hydraulic pump system per cylinder – i.e. each cylinder is provided with one accumulator, and therefore no longer of “common rail” design since the term “common rail” refers to a single common fuel rail that supplies fuel oil under pressure to all the cylinders of a diesel engine, which is nothing more than a pressure accumulator.

20	Construction of accumulators (common rail) (for electronically controlled engine)
21	Construction of common accumulators (common rail) (for electronically controlled engine)

The wording "common rail" with parentheses in Item Nos. 20 and 21 can be misinterpreted that submission of those drawings is not required in the case where electronically controlled engines adopt fuel injection systems other than common rail system; however, since accumulators are essential components for electronically controlled engines, drawings of construction of accumulators should be submitted for approval when obtaining a Type Approval Certificate.

- b. For reference purpose, a member Society's system corresponding to Alternative Certification Scheme (ACS) is added to the list in the definition column of UR M44 – Appendix 1 – Glossary.

### **3 List of non-IACS Member classification societies contributing through the TC Forum and/or participating in IACS Working Group:**

None

### **4 History of Decisions Made:**

Deletion of "(common rail)" in Item Nos. 20 and 21 of UR M44 (Corr.1) Table 2 was agreed at the 24<sup>th</sup> Machinery Panel Meeting for the sake of clarity.

### **5 Other Resolutions Changes:**

None

### **6 Any hinderance to MASS, including any other new technologies:**

None

### **7 Dates:**

Original Proposal: 25 July 2016 Made by Machinery Panel

Panel Approval: 31 October 2016 (Ref: PM9906c)

GPG Approval: 14 November 2016 (Ref: 16200\_IGb)

## **• Corr.1 (June 2016)**

### **1 Origin of Change:**

- Suggestion by a Machinery Panel Member

### **2 Main Reason for Change:**

UR M44 (Rev.8) and M44 (Rev.9) contain provisions related to engine certification process (production) which require re-type approval of diesel engines with an existing type approval. To avoid future troubles caused by understandings diverse among



Societies/licensors/licensees/shipowners, it was found necessary to publish a corrigendum for further clarification.

### **3 List of non-IACS Member classification societies contributing through the TC Forum and/or participating in IACS Working Group:**

None

### **4 History of Decisions Made:**

During discussion, it was found out that UR M44 (Rev.8) and M44 (Rev.9) can be read that also existing types of diesel engines with an existing type approval need to be retype approved as a part of engine certification process (production), as far as literally reading the provisions in a rigorous manner. Thus, it was concluded necessary to publish a corrigendum in order to clarify that such re-type approval is not necessary and that certification process (production) for individual engines whose application is dated on or after 1 July 2016 is to be carried out in this UR accepting the existing type approval, etc.

### **5 Other Resolutions Changes:**

None

### **6 Any hinderance to MASS, including any other new technologies:**

None

### **7 Dates:**

Original Proposal: 02 November 2015 Made by Machinery Panel

Panel Approval: 15 April 2016 (Ref: PM9906a)

GPG Approval: 3 June 2016 (Ref: 16088\_IGc)

## **• Rev.9 (Dec 2015)**

### **1 Origin of Change:**

- Request by non-IACS entity (Suggestion by CIMAC)

### **2 Main Reason for Change:**

The task was triggered by CIMAC WG2's request to provide a harmonised application form across IACS members for approval of IC engines because experience shows an increasing number of different application forms from different classification societies. While developing the harmonised application form, CIMAC WG2 was invited to review the draft for comments and the Panel has taken into account CIMAC's comments as appropriate. The updated draft was also presented to CIMAC WG2 representatives at the 11th Joint Meeting between IACS MP and CIMAC WG2 held on 9 September 2015 during the 22nd Machinery Panel Meeting.

### **3 List of non-IACS Member classification societies contributing through the TC Forum and/or participating in IACS Working Group:**

None

### **4 History of Decisions Made:**

This harmonized application form and data sheet are intended to replace Appendix 3 of UR M44 (Rev.8) which was approved by GPG when the Rev.8 of the UR was published.

There was an argument over deleting "Society Logo" initiated by CIMAC WG2's request encouraging IACS members to use the same form hereby simplifying the work process of filling in forms. In the continued discussion, the Panel came to the conclusion to removing "Society Logo" to leave the space in blank and therefore an individual Society may choose to add the Society's logo respectively to comply with its document policy, if necessary. In connection with this, CIMAC also supported removal of Society's logo, hereby enabling the societies to print the application form on paper with their respective company logo.

### **5 Other Resolutions Changes:**

None

### **6 Any hinderance to MASS, including any other new technologies:**

None

### **7 Dates:**

Original Proposal: 29 July 2013 made by CIMAC WG2 (Ref: ST-12-066)

Panel Approval: 30 October 2015 (Ref: PM13926)

GPG Approval: 14 December 2015 (Ref: 14086\_IGc)

## **• Rev.8 (Dec 2015) – Complete Revision**

### **1 Origin of Change:**

- Request by non-IACS entity (Suggestion by CIMAC)

### **2 Main Reason for Change:**

The revision of IACS UR M44 was discussed at the September 2009 joint meeting between IACS MP and CIMAC WG 2 – Classification Societies – Diesel. An ad-hoc group from WG2 was tasked to revise UR M44. In recent years in some parts of East Asia there have been repeated discussions between engine manufacturers and local Class Representatives regarding approval status of drawings for engine components. Often times these discussions are the result of differences in the identification between drawings requested in the present UR M44 and the corresponding drawing identification used during survey of components. The drawings listed in UR M44 might be assembly drawings whereas the drawings used for survey might be detailed

manufacturing drawings. On other occasions the local Class Surveyors are often requesting the engine manufacturer and/or sub-suppliers to provide Class stamped drawings prior to or at survey, even though no stamped drawings are distributed to all licensees and their sub-suppliers; but, just lists of approved/reviewed drawings.

### **3 List of non-IACS Member classification societies contributing through the TC Forum and/or participating in IACS Working Group:**

None

### **4 History of Decisions Made:**

A Member lead incorporation of proposed revisions into UR M44. The Machinery Panel commented on proposed revisions by correspondence and at regularly scheduled meetings.

Form A was agreed in the Panel in December 2011.  
Form A approved by GPG in December 2011.

### **5 Other Resolutions Changes:**

None

### **6 Any hinderance to MASS, including any other new technologies:**

None

### **7 Dates:**

Original Proposal: September 2010 Made by Machinery Panel  
Panel Approval: 09 February 2015 by Machinery Panel  
GPG Approval: 12 March 2015 (Ref: 11191\_IGf)

- **Rev.7 (May 2004)**

Ref: 4069a (WP/MCH Task 65).  
Refer to the TB document in Annex 2.

- **Rev.6 (Nov 2003)**

Ref: 3051a  
Refer to the TB document in Annex 1. No history file available.

- **Rev.5 (Nov 1992)**

No history file or TB document available.

- **Rev.4 (Nov 1989)**

No history file or TB document available.

- **Rev.3 (Nov 1986)**

No history file or TB document available.

- **Rev.2 (Nov 1984)**

No history file or TB document available.

- **Rev.1 (Nov 1983)**

No history file or TB document available.

- **New (1982)**

No history file or TB document available.

\*\*\*\*\*

## **Part B. Technical Background**

List of Technical Background (TB) documents for UR M44:

- Annex 1.     **TB for Rev.6 (Nov 2003)**  
              See separate TB document in Annex 1.
- Annex 2.     **TB for Rev.7 (May 2004)**  
              See separate TB document in Annex 2.
- Annex 3.     **TB for Rev.8 (May 2015)**  
              See separate TB document in Annex 3.
- Annex 4.     **TB for Rev.10 (Feb 2021)**  
              See separate TB document in Annex 4.

**Note:**

*There are no Technical Background (TB) documents available for New (1982), Rev.1 (1983), Rev.2 (1984), Rev.3 (1986), Rev.4 (1989), Rev.5 (1992), Rev.9 (Dec2015), Corr.1 (June 2016), Corr.2 (Nov 2016) and Corr.1 (Feb 2022).*

## Technical Background

### UR M44 Rev.6 and P2 Rev.5

The UK MAIB report on its investigation of the causes of an engine fire in the high-speed ferry 'Stena Explorer' concluded that it was due to the incorrect reassembly of a compression fitting in a high pressure fuel line.

IACS did not concur in the MAIB recommendation to discontinue the use of such fittings, and so advised the MAIB in a letter from the GPG Chairman on 15 September 2003 (3051\_IGb).

However WP/MCH proposed amendments to UR M44 and P2 to enhance relevant requirements for approval and maintenance.

They are:

#### **UR M44:**

- i) Add suffix 7 to Item 33,*
- ii) Add FOOTNOTE 7.  
7. operation and service manuals are to contain maintenance requirements (servicing and repair) including details of any special tools and gauges that are to be used with their fitting/settings together with any test requirements on completion of maintenance.*
- iii) Add NOTE 5.  
5. Where the operation and service manuals identify special tools and gauges for maintenance purposes (see footnote 7.) refer to UR P2.7.4.14.*

#### **UR P2:**

- i) add P2.7.4.14: The installation of mechanical joints is to be in accordance with the manufacturer's assembly instructions. Where special tools and gauges are required for installation of the joints, these are to be supplied by the manufacturer.*
- ii) Add sentence above P2.7.4.1 :*  
*The application and pressure ratings of different mechanical joints are to be approved by the Classification Society. The approval is to be based on Type Approval procedure in P2.11.*

The amendments were approved by GPG on 30 September 2003 (3051aIGb)

## **Technical Background to Revision of M44 – Documents for the approval of diesel engines (Rev. 7, 2004)**

### **WP/MCH Task 65**

#### **Background:**

The object of the revision to UR M44 is update the document with respect to documents required for approval of current engine designs and the related scope of approval activities carried out by classification societies.

UR M44 provides a list of documents which are to be submitted to a classification society for the approval of a diesel engine. The first table in this UR identifies the requirements for submission of documents and the related activity concerning what will be carried out by classification societies after submission by the engine manufacturer.

#### **Details:**

It is generally understood that for a plan or design information to be approved there needs to be detailed criteria in the form of rules or specification, against which the design is appraised, and hence approval based upon. On this basis, a unified approach for the approval of diesel engines is achieved. During the 44<sup>th</sup> meeting of WP/MCH a detailed review of the existing plans list of UR M44 was carried out and a consensus reached on the validity of plans and information to be submitted, and their designation for approval, or for information. Additionally, it was proposed that a new designation, ‘A\*’ be adopted, requiring that the plan be submitted to the classification society for approval of materials and weld procedure specifications. This designation recognises that it may not be possible to approve a particular design due to there being no defined approval criteria, but the materials used in construction and welding procedures are important and may impact on the component and engine integrity.

At the meeting and during subsequent correspondence between members the opportunity was taken to propose several minor amendments to the nomenclature of engine components used in UR M44 to reflect current industry terminology.

It was acknowledged that diesel engine technology is rapidly moving and with the development of electronically controlled engines it is apparent that the rules for diesel engines need to address electronic control systems, which are undeniably complex systems for controlling the operation of the engine and all of its essential services. A crucial facet in the approval of an engine, its support systems including the engine’s control system itself, is ensuring that failure of a control system will not cause the loss of essential services for operation of the engine, or degrade the engine performance beyond an acceptable level. Failure Mode and Effects Analysis (FMEA) is a tool now widely being adopted within the marine industry to carry out a structured analysis of the effects of loss of function. By applying an FMEA the critical failure modes of a system can be identified and consequently, where unacceptable levels of risk are present, mitigating steps can be taken such as introducing redundancy into the system. The requirement for submission of an FMEA, as supporting documentation for the approval of plans, has been introduced into UR M44 where the engine incorporates an electronic control system. The requirement extends to all services which are considered essential to the operation of the engine.

**Points of discussion**

The draft was agreed without reservations or statements.

**GPG**

Approved GPG without amendment 7 May 2004, 4069aIGb.

**Council**

Adopted Council without amendment 26 May 2004, 4069aICa.

\*\*\*\*\*



## Technical Background (TB) document Rev 8 (Mar 2015)

### 1 Scope and objectives

Develop a revised UR M44 organized to:

- Describe the approval process and document flow;
- Identify the relationships between the Classification Society's engineering and survey staff and the engine designer (licensor), the licensee and their sub-suppliers and the shipyard;
- Account for licensor/licensee protocols so the attending Classification Society Surveyors are provided with evidence that the relevant design drawings reviewed by engineering are shown to be equivalent to the manufacturing drawings developed by the licensee for the use of the attending Surveyor.

### 2 Engineering background for technical basis and rationale

In recent years in some parts of East Asia, there have been repeated discussions between engine manufacturers and local Class Representatives regarding approval status of drawings for engine components. Often times these discussions are the result of differences in the identification between drawings requested in the present UR M44 and the corresponding drawing identification used during survey of components. The drawings listed in UR M44 might be assembly drawings whereas the drawings used for survey might be detailed manufacturing drawings. On other occasions the local Class Surveyors are often requesting the engine manufacturer and/or sub-suppliers to provide Class stamped drawings prior to or at survey, even though no stamped drawings are distributed to *all* licensees and their sub-suppliers; but, just lists of approved/reviewed drawings.

Based on the proposals in CIMAC WG 2 – Classification Societies – Diesel, letter of 11 July 2010 Revision of IACS UR M44 for I.C. Engines (ST-10-33) UR M44 was proposed to be expanded and reformatted from two tables listing documents to be submitted and diesel engine data to requirements listing information and data to be submitted along with a detailed explanation of the engine certification process describing engineering review and survey during manufacture and erection at the shipyard. This proposed reorganization resulted in this format:

M44.2:	Definitions
M44.3:	Overview - Approval process, Document flow
M44.4:	Type Approval Process
M44.5:	Certification Process

Definitions were added to UR M44 to clarify various terms used in the diesel engine certification process. The initial set of terms was developed by CIMAC WG 2 and forwarded with their letter ST-10-33. These were reviewed by the MP and in some cases the definitions were further clarified. The definitions are in Appendix 1.

An overview of the procedures to obtain an Engine Certificate is summarized in M44.3. The process is based on current practice by the IACS members. There is presently much misunderstanding between the engine licensee and the attending Surveyor at the manufacturing plant because design drawings developed by the engine designer (licensor) are used by the classification society during the drawing review. The licensee uses the design drawings to create their manufacturing drawings. These drawings are highly detailed. In almost all cases, the licensee's drawing numbers and

titles do not match the design drawings reviewed by the classification society causing the Surveyor to request the drawings be stamped.

A new Appendix 2 indicates the document flow for Type Approval (TA) and Factory Acceptance Testing (FAT). CIMAC WG 2 initiated these document flow diagrams to provide a visual aid to users to show which offices of the classification society, engine designer, component suppliers and engine manufacturer act on or use the drawings. The final diagrams were the result of much discussion between the MP and CIMAC WG 2.

M44.4 lists the requirements for the Type Approval process for new or revised engine designs. M44.5 lists the requirements for the certification process for a Type Approved engine. These requirements are based on current practices of the IACS members.

The Data Sheet and Engine Particulars in Appendix 3 have been reformatted. Dimensional data related to the reciprocating components in the engine cylinders and the crankshaft have been deleted. Material specifications for the crankshaft have been deleted. Data related to supercharging devices, over-speed protection, electronic control systems, crankcase safety devices, starting systems, cylinder overpressure, allowable fuels, engine attached filters and driven pumps and main engine emergency operation capabilities have been added.

A new Appendix 4 provides the format related to information required for the comparison list for the licensor and licensee's drawings. A new Appendix 5 provides the format for information required of the licensee to obtain confirmation from the licensor of any modifications to the engine's design by the licensee.

### **3 Source/derivation of the proposed IACS Resolution**

CIMAC WG2 dated 11 July 2010, Subject: Revision of IACS UR M44 for I.C. Engines and incorporate appropriate proposals.

### **4 Summary of Changes intended for the revised Resolution**

The existing table has been reorganized into Tables 1 and 2 per the comments of the CIMAC WG2 letter. New Tables in the appendices have been added such as:

Appendix 1 – New Glossary

Appendix 2 – Representative document flow diagrams providing an aid to all parties involved in the engine certification process as to their roles and responsibilities

Appendix 3 – Updated and reformatted data sheet

Appendices 4 and 5 – New forms providing guidance for licensee/licensor drawing list comparison and licensor acceptance of licensee revisions to the engine design.

### **5 Points of discussions or possible discussions**

During the development of Revision 8, CIMAC WG2 made several comments to the draft M44. The comments and MP responses are listed below for reference purposes only.

Clause/Sub-clause/Paragraph	CIMAC WG2 Comment	IACS MP Response
M44.3.1.2	<p>This drawing comparison process is not achievable for high-volume marine engine production (thousands of certified marine engines annually).</p> <p>This level of documentation cannot be supported; we simply do not have the resources to support this administrative burden.</p>	<p>The intent of this requirement is to allow the attending surveyor to establish that the engine being assessed is the same as that approved by the society. The surveyor will as part of this check that the production drawings used for survey are the same as those approved and where there are any differences, that they have been agreed with the society. The drawing comparison process is <u>only required once for each engine type</u> and then at any change in production drawings. And for the engine assembly and testing, please see M44.5.6. There is a reference to UR Z26 for Alternative Certification Schemes which also resolve this comment.</p>
M44.3.2.2.3	<p>If the designer acceptance is not confirmed, the engine is to be regarded as a different engine type and is to be subjected to the complete Type Approval Process by the Licensee.</p> <p>This shall be struck/erased</p> <p>This is a violation of copy rights</p> <p>Licensee cannot Type Approve Engine an engine - all components are the property of the Licensor.</p>	<p>As this requirement prevents the builder/ licensee from deviating from the approved licensor's drawings without the designer's acceptance, it satisfies the commenter's concerns.</p>
M44.3.2.2.4	<p>Identical comment for M44.3.1.2</p>	<p>There appears to be a misinterpretation of 3.2.2.4. As stated in 3.1.2, the drawing comparison is done once. Then all future built engines requiring certification are certificated by the Classification Society. If there are several variations of a base model, administration is to be decided by the individual Society. One approach we apply is to have the designer/licensee submit all the engine variations for one model initially. Then there will be no delay.</p>

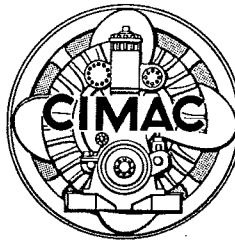
M44.3.2.2.5	High-volume engine production cannot have a built in delay waiting for approval before the engine is built. Engines are built exactly the same in series, and submittal for the unit certificate is typically after engine build and test is complete. Most plants are under Alternative System of Certification.	
M44.3.2.2.7	This is not the process for high-volume engines built in plants with ASC.	See M44.5.6 and response to Item 1.
M44.4.6	Substantive modifications or Major modifications or Major changes: Design modifications which lead to alterations in the stress levels, operational behaviour, fatigue life or an effect on other components or characteristics of importance such as emissions.	This definition is based in part on CIMAC letter WG2/ST-10-33 dated 11.07.2010 As follows: Design modifications which might lead to alterations in stresses, running behaviour application of other components or other changes of importance
	The inaccuracy of the above definition, much more evident in the second part, might lead to stresses between the manufacturer, the Class HO, and the Class site offices.	Regarding emissions, 'substantial modification' in NTC/1.3.2 is applicable. Emission behaviour is not a class issue.
	What has for instance a design assessment to share with emission?	
	How does one define an operational behaviour change?	Operational behaviour change relates to output power, speed, temperatures for any cooling fluids, gas temperatures, fluid or gas pressure changes, etc. Any parameter that is measurable.
	It seems there are no unique parameters to judge whether a change is substantive or not.	There are numerous parameters adhered to in manufacturing an engine such as tolerances. The Societies are concerned with the major dimension for various components. Any changes to an engine design need to be discussed with the Society.

M44.4.8	This is not reasonable There is no longer a fixed rule for allowable uprating for a TAC, so a new TAT is required?	Requests for increased ratings are in UR M71.3 Note 2 which is proposed. Here is the proposed text: 2) The engine is approved for the tested rating and pressures (100% corresponding to MCR). Provided documentary evidence of successful service experience is submitted, an increase (if design approved) may be permitted without a new type test if the increase from the type tested engine is within: - 5% of the maximum combustion pressure, or - 5% of the mean effective pressure, or - 5% of the rpm.
	The TAC will be INVALID? The substantial modification definition is too generic for stating that a TAC is invalid if there are substantial modifications in the design.	M44, Appendix 1 without approval by the Society will invalidate the TAC for that particular engine. Follow on engines designed in accordance with the Rules will be able to be certificated applying the applicable TAC.
M44.4.9.2	Proposed The Classification Society, if considered necessary, may request further documents to be submitted to the Classification Society, only in case they differ from the ones required as per Tables 1, 2, 3, and anyhow upon a precise and written motivation. The motivation must be linked to safety issues.	MP understands the issue for CIMAC is to limit requests for additional technical details to those drawings listed in Tables 1, 2 and 3. MP agrees with that in principal along with the requirement for written request from the Society to the engine manufacturer. However, MP disagrees with the last sentence. The request for additional information is to be based on verifying compliance with the Rule requirements because of a lack of information in the submitted drawings

M44 Table 2, Item 27	This is a new M44 requirement which is too broad in scope as written.	This request is from CIMAC letter WG2/ST-10-33 dated 11.07.2010, Section No.2 Item 5, "Requirements according to IACS UR P2 for mechanical joints." The failure of any engine piping systems will lead to degraded performance or complete loss of power which is unacceptable to all the Societies.
M44 Figure 2	This drawing comparison process is not achievable for high-volume marine engine production (thousands of certified marine engines annually). This level of documentation cannot be supported; we simply do not have the resources to support this administrative burden.	See response to M44.3.1.2
M44 Appendix 1	There is no longer a fixed rule for allowable uprating for a TAC, so a new TAT is required?	Requests for increased ratings are in UR M71.3 Note 2 which is proposed. See full response in Item 8
M44 Appendix 1, Modifications	The explanation given is not a clear definition.	
M44 Appendix 1, Substantive modifications or Major modifications or Major changes	Design modifications which lead to alterations in the stress level, fatigue life and/or to the definition of engine type according to IACS M32.	See response to M44.4.8
M44 Appendix 3	New M44 requirement to state "Performance Data" in terms of IACS UR M28 ambient reference conditions. A study of available marine diesel engine power data shows most companies are referencing power to ISO 15550 (clause 5) standard reference conditions (and same from ISO 3046-1 clause 5). Apparently this is to determine "service power" as defined in ISO 15550 section 3.3.8 at the UR M28 ambient reference conditions.	ISO 15550 states; 1.2 This International Standard applies to engines used for: a) land, rail-traction and marine use as defined in ISO 3046-1.  ISO 3046-1 references the IACS nominal ambient conditions stated in UR M28. It is understood that 'continuous power' (Type of power application) as used in the referred ISO standards (see ISO 3046, 11.3) is equivalent to the MCR as used throughout the IACS UR Ms.

**6 Attachments if any**

CIMAC WG2/ST-10-33 letter to Machinery Panel dated 11 July 2010, Subject: Revision of IACS UR M44 for I.C. Engines



CO-ORDINATING WORKING GROUP

"CLASSIFICATION SOCIETIES – DIESEL"

(WG2)

**Proposal towards IACS Machinery Panel**

St. Stutz/Secretary WG2/ST-10-33

11.07.2010

**Subject: Revision of IACS UR M44  
for I. C. Engines**

**Background**

On the occasion of the last Joint Meeting between IACS MP and CIMAC WG2 in September 2009 the revision of IACS UR M44 was subject to negotiations.

It was decided that the revision work shall be taken up by a small working group composed of A. Smith, C. Hadler, K. B. Hansen and St. Stutz.

One of the reasons behind the necessity to revise IACS UR M44 is that mainly in some parts of East Asia repeatedly discussions are coming up between engine manufacturers and local Class Representatives with regard to whether engine components were built in accordance with approved drawings or not. The problem is often caused by differences in the identification between drawings requested in IACS UR M44 and the corresponding drawing identification used for inspection of components, as the drawings mentioned in IACS UR M44 might be assembly drawings and the drawings for inspection might be detail drawings.

An other argument for revising IACS UR M44 is that local surveyors are often requesting the engine manufacturers and/or sub-suppliers to provide Class stamped drawings for inspection, even we have to realize that in normal cases no stamped drawings are distributed around the world but just lists of approved/appraised drawings.

With this proposal the responsibilities and actions shall be streamlined.

The proposal has been developed as follows:

- Section 1 and 2 are common for both 2 and 4-stroke manufacturers,
- Section 3 focuses exclusively on engine produced on the license ,
- Section 4 focuses on agreements not covered by section 3



Proposal

## **M44 Certification of I.C. Engines**

### M44.1 *Definitions*

The definitions as given in IACS UR M44, Appendix 1 shall clarify the meaning of the various specific expressions and lead to common understanding.

### M44.2 *Type Approval Process (TAP)*

A Type Approval Process consists of the following steps:

#### M44.2.1 *Design Approval/Appraisal (DA)*

DA's are valid as long as no substantial modifications have been implemented and might be extended/renewed based on evidence that all current rules and requirements are still covered.

#### M44.2.2 *Manufacturer Approval*

The assessment shall comprise manufacturing facilities and -process, machining tools, quality assurance, testing facilities etc. Conformity with the Class requirements will be covered by a Class Approval document.

#### M44.2.3 *Type Approval Test*

A Type Approval Test (TAT) required according to IACS UR M32 should be carried out in accordance with IACS UR M50 and shall be witnessed by Class.

#### M44.2.4 *Type Approval Certificate*

After the above steps have successfully been passed the Classes will issue a Type Approval Certificate (TAC).  
An extension/renewal of such certificates will be granted upon the submission of modified or new drawings (substantial modifications) compared to the former submission(s) for DA.  
A renewal can be granted when a declaration that no substantial modifications have been applied since the last submission is made.

M44.3        *Procedures*

M44.3.1        *Documents to be submitted to the Class Societies for Engine Information, Approval, Test and Inspection Purposes*

For each type of engine the documents listed in the following sections and if applicable to the type of engine are to be submitted to the Classification Societies for information, approval, recalculation or inspection for one (1) cylinder only if not otherwise specified.

Note:

In those cases in which a Licensor – Licensee agreement does NOT apply, an “Engine Designer” should be understood as the entity that has the Design Rights or is delegated by whom has the design rights to modify the design.

Documents for information, ref. to section 1, are to be submitted to the Classification Societies by Licensor.

Documents for approval and /or recalculation, ref. to section 2, are to be submitted to the Classification Societies by Engine Designer / Licensor.

Documents for inspection purposes, ref. to section 3, to be made available by Engine Builder / Licensees for the Class representative in charge of inspection.

After the design approval of an engine type has been given by a Classification Society for the first time, only those documents as listed in the section 1, 2, 3/4 which have undergone substantial modifications or new documents replacing existing documents will have to be submitted for consideration of the Class Society.

<b>Section No.: 1 - Documents for information</b>		
<p>The group consists of basic descriptive information so the Class can get a general impression of the engine and its design and relevant engine data and performances.</p> <p>Besides that, the section describe necessary aux. systems belonging to the engine, installations aspects, list of capacities/tech. specifications/requirements and information needed for maintenance and operating of the engine.</p> <p>Documents to be submitted by <b>engine designer/licensor</b>.</p>		
<b>List of drawings to be submitted for Information</b>		<b>Item Nos. ref. to existing IACS UR M44</b>
1	Engine particulars <sup>1</sup>	1
2	Engine cross section	2
3	Thrust bearing, assembly (if applicable)	5
4	Cylinder cover, assembly	9
5	Cylinder liner, assembly	10
6	Connecting rod, assembly	17
7	Crosshead, assembly (if applicable)	18
8	Piston, assembly	20
9	Camshaft / chain drive, assembly (where applicable)	21
10	Schematic layout or other equivalent documents of starting air system <sup>2</sup>	24
11	Schematic layout or other equivalent documents of fuel oil system <sup>2</sup>	25
12	Schematic layout or other equivalent documents of lube oil system <sup>2</sup>	26
13	Schematic layout or other equivalent documents of cooling water system <sup>2</sup>	27
14	Schematic layout or other equivalent documents of hydraulic system <sup>2</sup>	
15	Schematic diagram of engine control and safety system	28
16	Operation- and Service Manuals (as soon as available)	32
17	FMEA (for electronically controlled engines) <sup>3</sup>	
18	Type Test Report after the TAT	34
19	Shielding and insulation of exhaust pipes, assembly	29
20	Production specifications for castings and welding (sequence)	
21	Material specifications of main parts with information on NDT, pressure tests etc.	22

<sup>1)</sup> Project Guide/ Marine Installation Manual

<sup>2)</sup> with main dimensions, operating media, max . working pressure, if not include in engine particulars

<sup>3)</sup> Common platform required. To be decided in collaboration IACS MP/CIMAC WG 15

**Section No.: 2 – Documents for Class approval or recalculation.**

The group contains documents and drawings which have to be approved by the Class.  
The documents are to be submitted to the Class by engine designer/licensor.

List of documents for Class approval and/or recalculation		Item Nos. ref. to existing IACS UR M44	Remarks
1	Crankshaft calculations (for each cylinder configuration) according to the enclosed data sheet and to IACS UR M53	11-14	
2	Results of calculation for crankcase explosion relief valves	31	
3	Requirements according to IACS UR M9 for crankcase explosion relief valves		M9.12
4	Requirements according to IACS UR M10 for oil mist detection and/or alternative alarm arrangements		M10.18
5	Requirements according to IACS UR P2 for mechanical joints.		
6	Shielding of high pressure fuel/gas pipes, assembly		
7	Welding instruction		
8	Compliance with inclination limits		
9	Engine frames, welding drawings (if applicable)		
10	Bedplate/oil sump welding drawings		
11	Results from environmental tests, control components		
12	according to IACS UR E10 Documents as required in IACS UR E22		
13	Type test program to be approved before TAT		

**Section No.: 3 – Documents for inspection of components and systems**

This section applies only to those Realities governed by Licensor – Licensee type of agreements.

The section contains documents (drawings & production- quality specifications) needed for inspection and testing of the engine, engines parts and systems in the production.

Only for inspection purpose and upon request for clarification, the **Licensee** has to show to the Class representative the relevant detail drawings, production quality control specifications and acceptance criteria.

The **Licensee** must be prepared to provide the Class representative with a “List of Comparison” which compares **Licensee** drawing Id. to **Licensor** drawing Id.

If there are differences in the technical content on the Licensee drawing compared to the similar **Licensor** drawing the **Licensee** must provide the Class Representative with a list “Request for Alternative Execution” approved by **Licensor** and signed by **Licensee** and Licensor.

At any time the **Licensee** is responsible for the accuracy of the List of Compared drawing Id. and the content on the List of Request for Alternative Execution.

List of Component Drawings and systems drawings as far as requested by the relevant Class, for which the Licensee must make available detail drawings for Inspection		Drawings	Specifications for Inspection
1	Crankshafts (pins, journals, flanges etc.)	The relevant detail drawings are to be shown upon request to every individual local Class Representative for inspection purpose.	Relevant quality and production specification for every individual item must be made available upon request. In case of deviations between the approved documentation and the documentation according to which the engine is being built, the <b>Licensee</b> has to provide as well those modification notices showing the <b>Licensors</b> handling codes.
2	Pistons, piston rods		
3	Connecting rods		
4	Crossheads, if applicable		
5	Cylinder liners		
6	Cylinder covers		
7	Cylinder blocks		
8	Engine blocks		
9	Engine frames, if applicable		
10	Bedplates, if applicable		
11	Bolts for crankshaft couplings		
12	Tie rods, if applicable		
13	Valve bodies, if applicable		
14	Bolts for crosshead, if applicable		
15	Bolts for cylinder covers/heads		
16	Bolts for main bearings		
17	Bolts for connecting rod		
18	Camshaft drive wheels		
19	High pressure pipes		
20	Pumps, if applicable		

**Section No.: 4 – Documents for inspection of components and systems**

This section applies to Self-Manufacturing Companies, Assembly Shops and to those Realities (such as Joint Ventures) governed by agreements different from the Licensor – Licensee type.

The section contains documents (drawings & production - quality specifications) needed for inspection and testing of the engine, engines parts and systems in the production.

Only for inspection purpose and upon request for clarification the Engine Builder has to show to the Class representative the relevant detail drawings, production quality control specifications and acceptance criteria.

The **Engine Builder** must be prepared to provide the Class representative with a “List of Comparison” which compares **Engine Builder** drawing Id. to **Engine Designer** drawing Id.

If there are differences in the technical content on the Engine Builder drawing compared to the similar Engine Designer drawing, the **Engine Builder** must provide to the Class Representative evidence of the equivalence and agreement with Engine Designer.

At any time the **Engine Builder** is responsible for the accuracy of the “List of Comparison” of drawing Id.

List of Component Drawings and systems detail drawings, as far as requested by the relevant Class, made available for Inspection purposes		Drawings	Specifications for Inspection
1	Crankshafts (pins, journals, flanges etc.)	Only for inspection purposes and upon request of the individual local Class Representative, the relevant detail drawings are to be shown for clarification during inspection.	Only for inspection purposes and upon request relevant quality and production specification for every individual item must be made available.
2	Pistons, piston rods		
3	Connecting rods		
4	Crossheads, if applicable		
5	Cylinder liners		
6	Cylinder covers		
7	Cylinder blocks		
8	Engine blocks		
9	Engine frames, if applicable		
10	Bedplates, if applicable		
11	Bolts for crankshaft couplings		
12	Tie rods, if applicable		
13	Valve bodies, if applicable		
14	Bolts for crosshead, if applicable		
15	Bolts for cylinder covers/heads		
16	Bolts for main bearings		
17	Bolts for connecting rods		
18	Bolts for counterweights, if applicable		
19	Camshaft drive wheels, if applicable		
20	High pressure pipes		
21	Pumps, if applicable		

- M44.3.2 Comparison List  
(see attachment 1)
- M44.3.3 List of alternative Execution  
(see attachment 2)
- M44.3.4 Data Sheet  
(see attachment 3)

M44.4 Acceptance of Components/Certification

Whenever a manufacturer of internal combustion engine components is purchasing lots of materials which can not be identified for specific projects or Classes due to the time frame until the material is used up as well as when producing for spare parts stocks, the IACS members accept that the materiel identification and certification will be carried by one single Class and that all other IACS members will accept the respective documents issued by this specific Class.

It goes without saying that the material supplier will call up Classes in turns. Furthermore, the IACS members accept that the presence of a surveyor is not always necessary when pieces of such lots are being cut for specific projects.

M44.5 Certification of Parts subject to Class Approval

Under such components we understand parts, which are fitted to an engine and which are subject to a Class approval, as well as parts, which shall be carried on board as replacement parts (Spare Parts) for components which might fail during operation of the engine or are subject to wear and tear and which, call for change in situ to keep the vessel moving.

Engine Designer and Engine Builder must define and agree the procedure according to which they select, evaluate and reevaluate such Part Manufacturers and declare such companies as approved suppliers

**M44**  
cont'd

**DATA SHEET**

for calculation of Crankshafts for I.C. Engines

– based on IACS UR M 53 –

1	Engine Builder
2	Engine Type Designation
3	Stroke-Cycle <input type="checkbox"/> 2 SCSA <input type="checkbox"/> 4 SCSA
4	<p>Kind of engine</p> <p><input type="checkbox"/> In-line engine</p> <p><input type="checkbox"/> V-type engine with adjacent connecting rods</p> <p><input type="checkbox"/> V-type engine with articulated-type connecting rods</p> <p><input type="checkbox"/> V-type engine with forked/inner connecting rods</p> <p><input type="checkbox"/> Crosshead engine</p> <p><input type="checkbox"/> Trunk piston engine</p>
5	<p>Combustion Method</p> <p><input type="checkbox"/> Direct injection</p> <p><input type="checkbox"/> Precombustion chamber</p> <p><input type="checkbox"/> Others: _____</p>
6	<p>Fig. 1 Designation of the cylinders</p>
7	<p>Sense of Rotation (corresponding to Item 6)</p> <p><input type="checkbox"/> Clockwise <input type="checkbox"/> Counter clockwise</p>



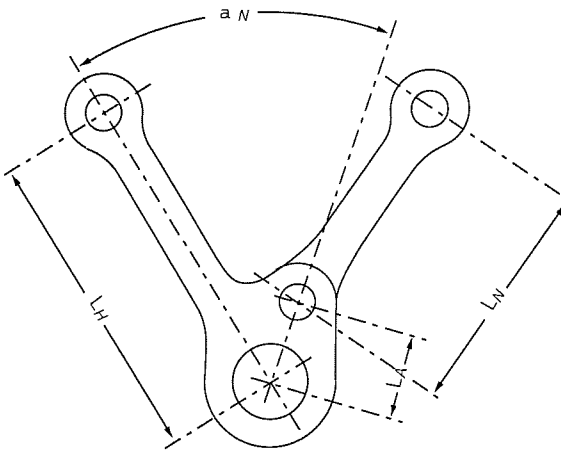
**M44**  
 cont'd

8	Firing Order (corresponding to Item 6 and 7)		
9	Firing Intervals [deg] (corresponding to Item 8)		
10	Rated Power		kW
11	Rated Engine Speed		1/min
12	Mean Effective Pressure		bar
13	Mean Indicated Pressure		bar
14	Maximum Cylinder Pressure (Gauge)		bar
15	Charge Air Pressure (Gauge) (before inlet valves or scavenge ports)		bar
16	Nominal Compression Ratio		–
17	Number of Cylinders		–
18	Diameter of Cylinders		mm
19	Length of Piston Stroke		mm
20	Length of Connecting Rod (between bearing centers)		mm
21	Oscillating Mass of one cylinder (mass of piston, rings, pin, piston rod, crosshead, oscillating part of connecting rod)		kg
22	Digitalized Gas Pressure Curve (Gauge) – presented at equidistant intervals [bar versus crank angle] – (intervals not more than 5° CA) <input type="checkbox"/> given in the appendix		

Additional Data of V-type Engines			
23	V-Angle $\alpha_v$ (corresponding to Item 6)		deg
For the Cylinder Bank with Articulated-type Connecting Rod (Dimensions corresponding to Item 27)			
24	Maximum Cylinder Pressure (Gauge)		bar
25	Charge Air Pressure (Gauge) (before inlet valves or scavenge ports)		bar
26	Nominal Compression Ratio		–



M44  
cont'd

27	 <p style="text-align: center;">Articulated-type connecting rod</p>		
28	Distance to Link Point $L_A$		mm
29	Link Angle $\alpha_N$		deg
30	Length of Connecting Rod $L_N$		mm
31	Oscillating Mass of one cylinder (mass of piston, rings, pin, piston rod, crosshead, oscillating part of connecting rod)		kg
32	Digitalized Gas Pressure Curve (Gauge) – presented at equidistant intervals [bar versus crank angle] – (intervals not more than 5° CA) <input type="checkbox"/> given in the appendix		
For the Cylinder Bank with Inner Connecting Rod			
33	Oscillating Mass of one cylinder (mass of piston, rings, pin, piston rod, crosshead, oscillating part of connecting rod)		kg

Data of Crankshaft (Dimensions corresponding to Item 39)	
Note: For asymmetric cranks the dimensions are to be entered both for the left and right part of crank throw.	
34	Drawing No.
35	Kind of crankshaft (e.g. solid-forged crankshaft, semi-built crankshaft, etc.)



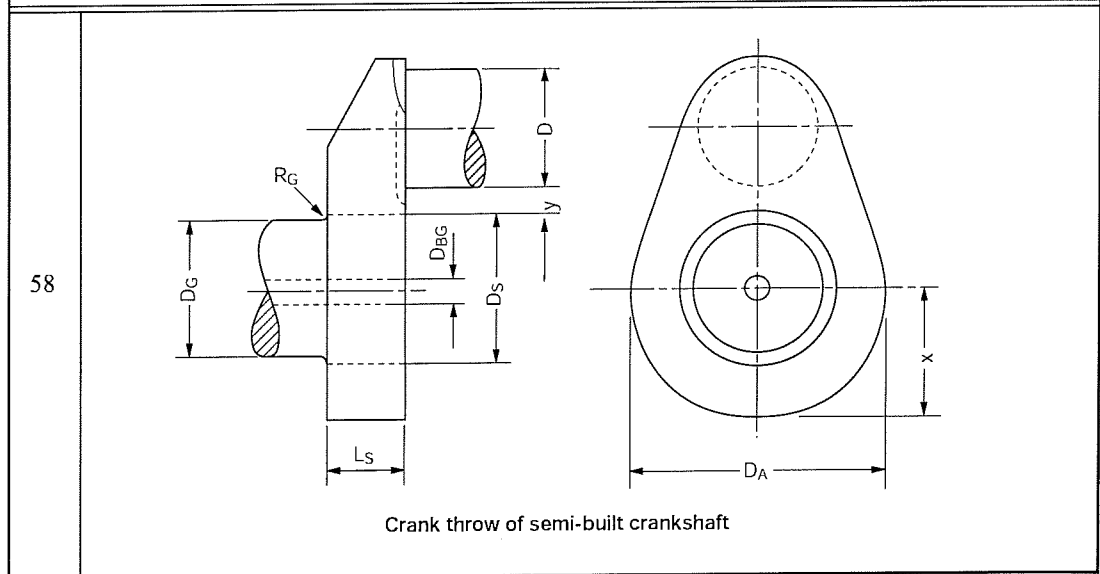
**M44**  
cont'd

36	Method of Manufacture (e.g. free form forged, cast steel, etc.)  <input type="checkbox"/> Description of the forging process – if c.g.f forged or drop-forged – given in the appendix	
37	Heat treatment (e.g. tempered)	
38	Surface Treatment of Fillets, Journals and Pins (e.g. induction hardened, nitrided, rolled, etc.)  <input type="checkbox"/> Full details given in the appendix	
<p style="text-align: center;">Crank throw for in-line engine                      Crank throw for engine with 2 adjacent connecting rods</p> <p style="text-align: center;">Crank dimensions necessary for the calculation of stress concentration factors</p>		
40	Crankpin Diameter $D$	mm
41	Diameter of Bore in Crankpin $D_{BH}$	mm
42	Fillet Radius of Crankpin $R_H$	mm
43	Recess of Crankpin $T_H$	mm

**M44**  
cont'd

44	Journal Diameter $D_G$		mm
45	Diameter of Bore in Journal $D_{BG}$		mm
46	Fillet Radius of Journal $R_G$		mm
47	Recess of Journal $T_G$		mm
48	Web Thickness $W$		mm
49	Web Width $B$		mm
50	Bending Length $L_1$		mm
51	Bending Length $L_2$		mm
52	Bending Length $L_3$		mm
53	Oil Bore Design <input type="checkbox"/> Safety margin against fatigue at the oil bores is not less than than acceptable in the fillets		
54	Diameter of Oil Bore		mm
55	Smallest Edge Radius of Oil Bore		mm
56	Surface Roughness of Oil Bore Fillet		$\mu\text{m}$
57	Inclination of Oil Bore Axis related to Shaft Axis		deg

Additional Data for Shrink-Fits of Semi-Built Crankshafts  
(dimensions corresponding to Item 58)



**M44**  
 cont'd

59	Shrink Diameter $D_s$		mm
60	Length of Shrink-Fit $L_s$		mm
61	Outside Diameter of Web $D_A$ or Twice the Minimum Distance $x$ (the smaller value is to be entered)		mm
62	Amount of Shrink-Fit (upper and lower tolerances)		mm
			%o
63	Maximum Torque (ascertained according to M 53.2.2.2 with consideration of the mean torque)		Nm

Data of Crankshaft Material			
Note: Minimum values of mechanical properties of material obtained from longitudinal test specimens			
64	Material Designation (according to DIN, AISI, etc.)		
65	Method of Material Melting Process (e.g. open-hearth furnace, electric furnace, etc.)		
66	Tensile Strength		N/mm <sup>2</sup>
67	Yield Strength		N/mm <sup>2</sup>
68	Reduction in Area at Break		%
69	Elongation $A_5$		%
70	Impact Energy – KV		J
71	Young's Modulus		N/mm <sup>2</sup>
Additional Data for Journals of Semi-Built Crankshafts			
72	Material Designation (according to DIN, AISI, etc.)		
73	Tensile Strength		N/mm <sup>2</sup>
74	Yield Strength		N/mm <sup>2</sup>



**M44**  
cont'd

Data According to Calculation of Torsional Stresses			
Note: In case the Society is entrusted with carrying out a forced vibration calculation to determine the alternating torsional stresses to be expected in the engine and possibly in its shafting, the data according to M53.2.2.1 are to be submitted.			
75	Max. Nominal Alternating Torsional Stress (ascertained by means of a harmonic synthesis according to M53.2.2.2 and related to cross-sectional area of bored crank pin)		N/mm <sup>2</sup>
76	Engine Speed (at which the max. nominal alternating torsional stress occurs)		1/min
77	Minimum Engine Speed (for which the harmonic synthesis was carried out)		1/min

Data of Stress Concentration Factors (S.C.F.) and/or Fatigue Strength Furnished by Reliable Measurements			
Note: To be filled in only when data for stress concentration factors and/or fatigue are furnished by the engine manufacturer on the basis of measurements. Full supporting details are to be enclosed.			
78	S.C.F. for Bending in Crankpin Fillet $\alpha_B$		–
79	S.C.F. for Torsion in Crankpin Fillet $\alpha_T$		–
80	S.C.F. for Bending in Journal Fillet $\beta_B$		–
81	S.C.F. for Shearing in Journal Fillet $\beta_Q$		–
82	S.C.F. for Torsion in Journal Fillet $\beta_T$		–
83	Allowable Fatigue Strength of Crankshaft $\sigma_{DW}$		N/mm <sup>2</sup>

Remarks	
84	

**M44**  
cont'd

Remarks (continued)	



**Class Inspection of Engine Components  
List of Comparison  
Licensee Id. Nos. compared to Licensor Id. Nos.**

Licensee: \_\_\_\_\_ Engine type: \_\_\_\_\_ Licensees Engine No.: \_\_\_\_\_

No	Components and Systems for Inspection	Drawing No's.		Drawing modified by Licensee e.g.		Remarks  List of Alternative Execution approved by Licensor  Id.: xyzxyz
		Licensor	Licensee	Yes	No	
1						
2						
3						
4						
5						
6						
7						
8						

26						
27						
28						
29						
30						
31						
32						
33						

Date / Place: \_\_\_\_\_

Person in Charge: \_\_\_\_\_  
Licensee Block Letters

\_\_\_\_\_  
Signatures



## List of Alternative Execution

Page( ) of ( )

<b>Licensee information</b>			
Licensee:		LoAE No.:	
Description:		Info No.:	
Engine type:		Main Section:	
Engine No.:		Plant Id.:	
Design Spec: <input type="checkbox"/> General <input type="checkbox"/> Specific Nos:			
<i>Licensor design:</i>	<i>State relevant part or drw. numbers. Insert drawing clips or pictures.</i>	<i>Licensee execution:</i>	
<i>Add any relevant information</i>			
		<p>For example:</p> <ul style="list-style-type: none"> <li>• Differences in geometri</li> <li>• Differences in the funtionalety</li> <li>• Material</li> <li>• Harshness</li> <li>• Surface condition</li> <li>• Alternative standard</li> <li>• Licensee production informations introduced on the drawing</li> <li>• Weldings or castings</li> <li>• etc.</li> </ul>	
Reason:	<input type="checkbox"/> Licensee's production <input type="checkbox"/> Sub-supplier's production <input type="checkbox"/> Cost down <input type="checkbox"/> Tools	Interchangeability w. Licensor design: <input type="checkbox"/> Yes <input type="checkbox"/> No	Non-conformity Report (NCR): <input type="checkbox"/> Yes
		Certified by Licensee: Initials: Date:	
<b>Licensor comments</b>			
LoAE:	<input type="checkbox"/> Accepted as alternative execution <i>(Licensor undertake responsibility)</i> <input type="checkbox"/> No objection <input type="checkbox"/> Not acceptable <i>(Licensee undertake responsibility)</i>	NCR:	<input type="checkbox"/> Approved <input type="checkbox"/> Conditionally approved <input type="checkbox"/> Rejected
		Certified by Licensor: Initials: Date:	
Licensor ref.:			Date:
Licensee ref.:			Date:

Return to: Licensor

NCR(Non-conformity Report) may alternatively be sent to local Licensor site-office

Expression	Definition
Acceptance criteria	The set of values or criteria which a design, product, service or process is required to conform with, in order to be accepted
Accepted	Status of a design, product, service or process, which has been found to conform to specific acceptance criteria
Action- or activity code	Instruction in a modification notice under which circumstances a design modification is to be implemented
Alternative System of Certification (ASC)	A system, by which a society evaluates a manufacturers quality assurance and quality control arrangements for compliance with Rule requirements, then authorizes a manufacturer to undertake and witness testing normally required to be done in the presence of a surveyor. The alternative System of Certification as presently administrated by the Member Societies is generally known as: ABS: Product Quality Assurance BV: Alternative Survey Scheme CCS: Quality System Approval DNV: Manufacturing Survey Arrangement GL: Alternative System Certification????????????? KR: Quality Assurance System LR: LR Quality Schemes NK: Approved Survey Scheme RINA: Alternative Survey Scheme RS: Recognition of Manufacturers
Appraisal	Refers to the evaluation by a competent body
Approval	The granting of permission for a design, product, service or process to be used for a stated purpose under specific conditions based upon a satisfactory appraisal
Assembly	Equipment or a system made up of components or parts
Assess	Determine the degree of conformity of a design, product, service, process, system or organization with identified specifications, rules, standards or other normative documents
Audit	Planned systematic and independent examination to determine whether the activities are documented. The documented activities are implemented. The results meet the stated objectives
Auditor	Individual who has the qualifications and experience to perform audits
Certificate	A formal document attesting compliance of a design, product, service or process with the specified requirements
Certification	A procedure whereby a design, product, service or process is approved in accordance with specified requirements
Class	Short for Classification Society
Class Approval	Approved by means of a Class Certificate
Classification	Is that specific type of certification, which relates to the Rules of the relevant Classification Society
Classification Mark/ Notation	Assignment of a classification mark or notation. The relevant components and materials may require certification with the applicable Rules of the Society
Classification Process	Essential part of the classification process is the initial and periodic certification of materials and components to the Rules of the relevant Classification Society
Competent Body	Organization recognized as having appropriate knowledge and expertise in a scific area
Component	Part, Member of Equipment or System
Conformity	Where a design, product, process or service demonstrates compliance with its specific requirements
Construction Mark	A Construction Mark identifies the type of surveillance made prior to the issuance of the Certificate of Classification to a ship Ships which are built in accordance with the requirements of the Rules and under the survey of the Society Ships built under the survey of other authorities and which have been assigned by such authorities a Class deemed equivalent to a Class described in the Rules Ships are built under the survey of the Society but do not meet some provisions of the Rules One of the marks here above is also assigned , followed by the symbol of the corresponding additional Class Notation, to classed automated installations, refrigerating plants, lifting appliances and generally to any installation for which a certificate or an annex to the certificate is issued
Contract	Agreement between two or more parties relating to the scope of service

<b>Expression</b>	<b>Definition</b>
Contractor	see supplier
Customer	Party who purchases or receives goods or services from another
Delegation of Authority	See IMO
Design	All relevant plans, documents calculations described in the performance, installation and manufacturing of a product
Design Analysis	Investigative methodology selectively used to assess the design
Design appraisal	Evaluation of all relevant plans, calculations and documents related to the design
Design approval	Process whereby permission is granted for the design to be used for a stated purpose under specific condition
Design Examination Certificate	See IEU Marine directive for definition
Design review	Part of the appraisal process to evaluate specific aspects of the design
Directive	See EU
Documentation	The provision of appropriate documental evidence to support an assessment
Drawings approval/ plan approval	Part of the design approval process which relates to drawings and plans
Equipment	Part of a system assembled from components
Equivalent	An acceptable, no less effective alternative to specified criteria
Evaluation	Systematic examination of the extent to which a design, product, service or process satisfies specific criteria
Examination	Assessment by a competent person to determine compliance with requirements
Inspection	Examination of a design, product service or process by an Inspector
Inspection Plan	List of tasks of inspection to be performed by the Inspector
Installation	The assembling and final placement of components, equipment and subsystems to permit operation of the system
Manufacturer	Party responsible for the manufacturing and quality of the product
Manufacturing process	Systematic series of actions directed towards manufacturing a product
Manufacturing process approval	Approval of the manufacturing process adopted by the manufacturer during production of a specific product
Material	Goods supplied by one manufacturer to another manufacturer that will require further forming or manufacturing before becoming a new product
Modification	A limited change that does not affect the current approval
Modification notice	Information about a design modification with new mod. index or new drawing number replacing the former drawing
Mutual recognition	The result of an arrangement between two or more bodies that consider that an approval or a certification granted by one of them, under special conditions, is acceptable to the others
Original Spare Parts	Parts produced fully in line with the engine designer's drawings, specifications and quality requirements. The supplier must be approved by the engine designer and/or -manufacturer and Classes. The respective documents are to be purchased in a legal proper way.
Performance test	Technical operation where a specific performance characteristic is determined
Producer	See manufacturer
Product	Result of the manufacturing process
Prototype Test	Investigations on the first or one of the first new engines with regard to optimization, fine tuning of engine parameters and verification of the expected running behaviour
Quality Assurance	All the planned and systematic activities implemented within the quality system, and demonstrated as needed to provide adequate confidence that an entity will fulfil requirements for quality. Ref. ISO 8402
Regulation	Rule or order issued by an executive authority or regulatory agency of a government and having the force of law
Repair	Restore to original or near original condition the results of wear and tear or damages for a product or system in service
Requirement	Specified characteristics used for evaluation purposes
Review	Systematic evaluation
Revision	Means to record changes in one or more particulars of design drawings or specifications
Specification	Technical data or particulars which are used to establish the suitability of materials, products, components or systems for their intended use

<b>Expression</b>	<b>Definition</b>
Substantial or major modifications/changes	Design modifications which might lead to alterations in stresses, running behaviour application of other components or other changes os importance
Subsupplier/ subcontracter	One who contracts to supply material to another supplier
Supplier	One who contracts to furnish materials or design, products, service or components to a customer or user
Test	A technical operation that consists of the determination of one or more characteristics or performance of a given product, material, equipment, organism, physical phenomenon, process or service according to a specified procedure. A technical operation to determine if one or more characteristic(s) or performance of a product, process or service satisfies specific requirements
Traceability	Ability to follow back through the design and manufacturing process the origine
Type Approval	<ol style="list-style-type: none"> <li>1. Evaluation of a design to determine conformance with specifications</li> <li>2. Witnessing manufacture and testing of a type of product to determine compliance with the specification</li> <li>3. Evaluation of the manufacturingarrangements to confirm that the product can be consistently produced in accordance with the specification</li> </ol>
Type Test	Last step of the type approval procedure. Test program in accordance with M50
Witness	To be physically present at a test and being able to record and give evidence about it's outcome

## Technical Background (TB) document for UR M44 (Rev.10 Feb 2021)

### 1. Scope and objectives

UR M44(Rev.9) does not reflect the agreed format for referencing the ISO standards. Rev.10 has been developed to comply with the agreed format.

### 2. Engineering background for technical basis and rationale

#### A) Format for references to Industry standards

**Format:**

*[Standard Designation], [version/revision, if applicable], [year of publication]*  
*(examples: API Spec 2F, 6th Edition, 1997; ISO 4624, 2002), where [version/revision, if applicable] and/or [year of publication] are decided by IACS and are not necessarily to be the current/latest version.*

#### B) Format for references to IMO instruments (where the number of amendments is large)

**Format:**

*regulation/paragraph x.x.x of SOLAS Chapter X/MARPOL Annex X/the XXX Code, as amended by IMO resolutions up to MSC.xx(xx)/MEPC.xx(xx)*

### 3. Source/derivation of the proposed IACS Resolution

None

### 4. Summary of Changes intended for the revised Resolution:

UR M44 has been updated to specify the revision/version of the ISO standards and MSC resolutions as follows:

ISO standards	Replaced by
ISO 9000 series	ISO 9001:2015
ISO 9001	ISO 9001:2015
ISO 8216	ISO 8216-1:2017
MSC resolutions	Replaced by
MSC.81(70)	MSC.81(70), as amended by IMO resolutions up to MSC.472(101)

### 5. Points of discussions or possible discussions

None

### 6. Attachments if any

None

## UR M45 “Ventilation of Machinery Spaces”

### Summary

UR M45 which contains no additional requirements to existing statutory requirements (SOLAS and ICLL) was deleted.

### Part A. Revision History

Version no.	Approval date	Implementation date when applicable
Del (Nov 2022)	08 November 2022	-
Rev.2 (Feb 2011)	01 February 2011	1 January 2012
Rev.1 (1987)	1987	-
New (1982)	1982	-

#### • Del (Nov 2022)

##### 1 Origin of Change:

- Other (Periodical review carried out by Machinery Panel)

##### 2 Main Reason for Change:

UR M45 which contains no additional requirements to existing statutory requirements (SOLAS and ICLL) was deleted.

##### 3 List of non-IACS Member classification societies contributing or participating in IACS Working Group:

None

##### 4 History of Decisions Made:

None

##### 5 Other Resolutions Changes:

None

##### 6 Any hinderance to MASS, including any other new technologies:

None

##### 7 Dates:

Original Proposal : 28 October 2019 (Ref: PM18939\_IMd)  
 Panel Approval : 12 August 2022 (Ref: PM20906\_IMzq)  
 GPG Approval : 08 November 2022 (Ref: 20206gIGb)

- **Rev.2 (Feb 2011)**

**.1 Origin for Change:**

- Suggestion by an IACS member

**.2 Main Reason for Change:**

- To clarify which machinery space is to be ventilated continuously.
- To modify the title of UR M45 to be consistent with the title of SOLAS Regulation II-1/35 (machinery space instead of engine room)

**.3 List of non-IACS Member classification societies contributing through the TC Forum and/or participating in IACS Working Group:**

None

**.4 History of Decisions Made:**

The IACS Machinery Panel agreed to carry out the task to revise UR M45. Form A was agreed in the Panel in May 2010. The Machinery Panel developed the draft of revised UR M45 and submitted for GPG approval in January 2011.

**.5 Other Resolutions Changes**

None

**.6 Dates:**

Original proposal: May 2010 *Made by:* Machinery panel  
Panel Approval: 04 January 2011  
GPG Approval: 01 February 2011 (Ref. 11003\_IGc)

- **Rev. 1 (1995)**

No records are available.

- **New (1995)**

No records are available.

## **Part B. Technical Background**

List of Technical Background (TB) documents for UR M45:

Annex 1. **TB for Rev.2 (Feb 2011)**

See separate TB document in Annex 1.

*Note: There are no separate Technical Background (TB) documents for New (1982), Rev.1 (1987) and Del (Nov 2022).*



## **Technical Background for UR M45 Rev.2, Feb 2011**

### **1. Scope and objectives**

To modify the existing UR M45 in order for Member Societies to uniformly implement the requirement for continuous ventilation of machinery spaces in all weather conditions on the Load Line convention.

- To clarify the application UR M45 to the Machinery spaces
- Revise "UR M45 Ventilation of Machinery Spaces" to Clarify the "Machinery spaces" mentioned in UR M45

### **2. Engineering background for technical basis and rationale**

- International Convention on Load Lines, 1966, as amended by the Protocol of 1988 (ICLL mentioned below) has entered into force on 1 January 2005. Annex I Chapter II Regulation 17(3) of ICLL states: "... ventilators necessary to continuously supply the machinery space shall have coamings of sufficient height to comply with regulation 19(3), without having to fit weathertight closing appliances. Ventilators necessary to continuously supply the emergency generator room, if this is considered buoyant in the stability calculation or protecting opening leading below, shall have coamings of sufficient height to comply with regulation 19(3), without having to fit weathertight closing appliances."
- SOLAS Reg. II-1/35 states : "Machinery spaces of category A shall be adequately ventilated so as to ensure that when machinery or boilers therein are operating at full power in all weather conditions, including heavy weather, an adequate supply of air maintained to the spaces for the safety and comfort of personnel and the operation of the machinery. Any other machinery space shall be adequately ventilated appropriate for the purpose of that machinery space."
- From abovementioned regulations, it is understood that only machinery spaces of category A shall be ventilated continuously. But the existing UR45 requires all machinery space to be ventilated continuously in all weather conditions. Furthermore, the title of UR M45 (engine room) is not consistent with the title of SOLAS Regulation II-1/35 (machinery space). So it was agreed to modify the existing UR M45 to clarify which machinery space is to be ventilated continuously in all weather conditions.

### **3. Source/derivation of the proposed IACS Resolution**

None

### **4. Summary of Changes intended for the revised Resolution:**

The following description of UR M45 has been updated to clarify the "Machinery spaces".

- The title of UR M45 has been updated to be consistent with the title of SOLAS Regulation II-1/35 (machinery space instead of engine room)
- The existing first paragraph of UR M45 has been removed and replaced with "The ventilation of machinery spaces shall be according to the principles laid down in SOLAS Regulation II-1/35", so that UR M45 is aligned with SOLAS Regulation II-1/35.
- The new sentence "The Machinery spaces are those defined in SOLAS Regulation II-1/3.16" has been added for clarification, so that the definition of machinery spaces within UR M45 is aligned with the definition of machinery spaces within SOLAS Regulation II-1/3.16.

#### **5. Points of discussions or possible discussions**

- "Machinery spaces" whether including the "Machinery spaces of category A". This is the requirements of SOLAS Reg. II-1/35.
- The revision is to be submitted to respective Conventions for evaluation; for example ICLL and SOLAS

#### **6. Attachments if any**

None

## UR M46 “Ambient conditions – Inclinations and Ship Motions”

### Summary

Note 3 to M46.2 is updated accommodating the reference clause nos. of the IGC Code and the IBC Code that were previously specified in UI SC6 and UI SC290.

### Part A. Revision History

Version no.	Approval date	Implementation date when applicable
Rev.4 (August 2024)	26 August 2024	1 January 2026
Rev.3 (August 2023)	09 August 2023	1 January 2025
Rev.2 (Dec 2018)	19 December 2018	1 January 2020
Rev.1 (June 2002)	No records	-
New (1982)	No records	-

#### • Rev.4 (August 2024)

##### 1 Origin of Change:

- Suggestion by IACS member

##### 2 Main Reason for Change:

Reference clause nos. of the IGC Code and the IBC Code which are the main part of interpretation in UI SC6 and UI SC290 have been transferred to UR M46 (Note 3 to M46.2).

##### 3 List of non-IACS Member classification societies contributing or participating in IACS Working Group:

None.

##### 4 History of Decisions Made:

The Panel considered the revision of UI SC6, UI SC290 and UR M46, and after deliberations decided to delete the redundant UIs (i.e. UI SC6 and UI SC290) and add reference clause nos. of the IGC Code and the IBC Code to UR M46 (Note 3 to M46.2).

In the course of discussion, it was found that similar requirements as Note 3 to M46.2 is present in item 8 of UR E10 (inclination test), and the Panel decided to update relevant part of UR E10 as well.

##### 5 Other Resolutions Changes:

- UI SC6

- UI SC290
- UR E10

**6 Any hinderance to MASS, including any other new technologies:**

None.

**7 Dates:**

Original Proposal:	19 January 2024	(Ref: PM24002_RIa)
Panel Approval:	02 July 2024	(Ref: PM24002_IMf)
GPG Approval:	26 August 2024	(Ref: 21036aIGd)

**• Rev.3 (August 2023)**

**1 Origin of Change:**

- Suggestion by IACS member

**2 Main Reason for Change:**

To establish and add requirements for verification.

**3 List of non-IACS Member classification societies contributing or participating in IACS Working Group:**

None.

**4 History of Decisions Made:**

Issue raised as a potential New Work Item by a member during the 29th Machinery Panel meeting (March 2019)  
 Revised UR M46 agreed by Machinery Panel (PM19923\_IMu dated 07/07/2023)

**5 Other Resolutions Changes:**

None.

**6 Any hinderance to MASS, including any other new technologies:**

None.

**7 Dates:**

Original Proposal	: 06 May 2019	(Ref: PM19923_IMa)
Panel Approval	: 07 July 2023	(Ref: PM19923_IMu)
GPG Approval	: 09 August 2023	(Ref: 21036_IGf)

**• Rev.2 (Dec 2018)**

**1 Origin of Change:**

- Suggestion by IACS member

## **2 Main Reason for Change:**

Perceived conflict between Note 1 in UR M46 Rev.1 and UR E10 Rev.6

## **3 List of non-IACS Member classification societies contributing through the TC Forum and/or participating in IACS Working Group:**

None.

## **4 History of Decisions Made:**

Issue raised by a member at the 27th Machinery Panel meeting (March 2018)  
Revised UR M46 agreed by Machinery Panel (PM18911\_IMd dated 26/10/2018)

## **5 Other Resolutions Changes**

None.

## **6 Dates:**

Original proposal: March 2018

Panel Approval: 26 October 2018 (Ref: PM18911\_IMd)

GPG Approval: 19 December 2018 (Ref: 18185\_IGe)

### **• Rev.1 (June 2002)**

No records available.

### **• New (1982)**

No records available.

\*\*\*\*\*

## **Part B. Technical Background**

List of Technical Background (TB) documents for UR M46:

Annex 1. **TB for Rev.2 (Dec 2018)**

See separate TB document in Annex 1.

Annex 2. **TB for Rev.3 (August 2023)**

See separate TB document in Annex 2.

Annex 3. **TB for Rev.4 (August 2024)**

See separate TB document in Annex 3.

*Note: There are no Technical Background (TB) documents available for New (1982) and Rev.1 (June 2002).*

## **Technical Background (TB) document for UR M46 Rev.2 (Dec 2018)**

### **1. Scope and objectives**

To remove a possible conflict between Note 1 in UR M46, Rev.1 and test no. 8 in UR E10, Rev.6.

### **2. Engineering background for technical basis and rationale**

Note 1 of UR M46, Rev.1 requires for switch gear, electrical and electronic appliances that no undesired switching operations or operational changes may occur up to an angle of inclination of 45 deg. while test no. 8 of UR E10 stipulates static and dynamic inclination angles of 22.5 deg. in the test specification for type approval. These two requirements appear to be at variance. Upon consideration the Panel qualified majority concluded that the type test requirements in UR E10 should apply and that the inclination angle of 45 deg. in Note 1 in UR M46 may be deleted.

### **3. Source/derivation of the proposed IACS Resolution**

Members practice in the application of UR M46 and UR E10.

### **4. Summary of Changes intended for the revised Resolution:**

Deletion of the required inclination angle of 45 deg. from Note 1.

### **5. Points of discussions or possible discussions**

Two members considered that the requirements in UR M46 and UR E10 are distinctly different in that UR M46 requires that switches and controls are to remain in their last set position and this is seen as an additional requirement.

One member was of the view that Note 1 of UR M46 may be added to UR E10, however, another member considered that this was not appropriate since UR E10 specifies test requirements whereas Note 1 in UR M46 gives a requirement, however, without stipulating tests.

### **6. Attachments if any**

None.

## **Technical Background (TB) document for UR M46 (Rev.3 August 2023)**

### **1. Scope and objectives**

It was proposed to revise UR M46 to ensure clarity of the static and dynamic inclinations that the machinery is expected to perform at. This new task will address the concerns and uncertainties of compliance with UR M46. The objective of the revision was essentially in three parts.

1. To require the dynamic conditions under which essential machinery and equipment is required to operate satisfactorily to be determined.
2. To establish acceptable approaches by which machinery and equipment manufacturers can demonstrate satisfactory operation under the conditions described in the UR.
3. To establish acceptable approaches by which ship builders can demonstrate satisfactory operation when installed onboard under the conditions described in the UR.

### **2. Engineering background for technical basis and rationale**

IACS UR M46 defines the ambient conditions "to be applied to the layout, selection and arrangement of all shipboard machinery, equipment and appliances to ensure proper operation" and in particular the dynamic angles of inclination due to ship motion.

Recent in-service experience, external feedback and ensuing discussions with industry suggests that, from a machinery and equipment manufacturing perspective, the definition of dynamic inclinations as stated in the UR is unclear and arguably incomplete, and therefore needs further definition.

A series of recent main engine fuel gas compressor in-service failures has been attributed to compressor components (conrods) unsuited to the higher accelerations to which deck mounted (LNGC compressor room located) compressors are subject to in heavy weather.

Additionally, it has become evident that there is also unclarity with regards to how machinery and equipment manufacturers and the means by which shipbuilders would be expected to demonstrate compliance with the requirements in respect of their scope of supply, which therefore needs establishing.

The failures highlighted the need for verification of machinery and equipment for operation under dynamic inclinations and the accelerations resulting therefrom. During the ensuing discussions within the IACS Machinery Panel, the need for defining a consistent approach to the verification of both static and dynamic inclinations became apparent.

#### **2a. Specification of the data utilised in the development/revision of the proposed IACS Resolution, if any**

None.



### **3. Source/derivation of the proposed IACS Resolution**

Members practice in the application of UR M46 and in-service feedback from recent relevant failures.

### **4. Summary of Changes intended for the revised IACS Resolution:**

Change of UR title to better reflect scope.

In 46.1 word 'all' deleted to reflect the applicability of the UR more accurately.

New 46.3 added indicate when information is required to be submitted for verification by Class.

New 46.4 added to specify a documentation requirement for ship builders, with a view to ensuring that expected accelerations and ship motions periods are to be within machinery and equipment manufacturers requirements.

New 46.5 added to indicate information required to be submitted.

### **5. Points of discussions or possible discussions**

Much discussion between IACS members during the development of the revised UR. Comments and concerns raised by members included the scope of applicability i.e. which machinery and equipment the UR applied to, the methods by which dynamic ship motions may be established recognising that SOLAS II-1, 26.6 does not fully define the dynamic motions e.g. rolling and pitching periods are undefined, the difficulty and cost to the industry in demonstrating compliance with the UR and the application date of the UR given the significant implications for the industry.

Also much discussed was the current approach of members to the verification or the existing UR (Rev.2) which revealed wide differences between members.

Draft Rev.3 of UR has been consulted with Hull Panel for estimation ship's acceleration and motion methodology.

As estimation acceleration method in CSR and the CSS Code is far less specific than content of M46.2 and further to upcoming new revision of CSR which will refer to roll period only and not pitch and heave period, then qualified majority in Machinery Panel agreed to do not recommend any methodology for estimation ship's acceleration and motion in the Rev.3 of UR.

Draft Rev.3 of UR has been shared with CIMAC for their view and feedback, which their feedback implemented to draft Rev.3 of UR.

### **6. Attachments if any**

None.

## **Technical Background (TB) document for UR M46 (Rev.4 August 2024)**

### **1. Scope and objectives**

It was proposed to consider revision of the two UIs (i.e. UI SC6 and UI SC290), either to delete UI SC6 and update UI SC290 both covering 1983 & 2014 IGC Code, or to simply delete the two UIs recognizing that the requirement is sufficiently addressed by UR M46 and possibly to update UR M46 (Note 2 to M46.2) adding references to IGC Code and IBC Code.

### **2. Engineering background for technical basis and rationale**

The inclination requirement for emergency source of electrical power on gas carriers and chemical tankers is addressed in UI SC6 and UI SC290. The two UIs are dealing with the same issue and the same contents, with the only difference of the reference clause nos. for IGC Code between old and new IGC Code, i.e. UI SC6 refers to 1983 IGC Code and UI SC290 mentions 2014 IGC Code.

The duplication of the UIs is thought to be originated from GPG instruction (ref. 18902\_IGe and PM5901fIMI: "creating UIs that will be published as "new" and also revising the old UIs by adding the references to the old IGC Code that will be published as Revisions").

This panel is of the view that the instruction would be applicable when specific requirement of old IGC Code has been revised or replaced by new IGC Code. However, in this case, the requirement is same and the two UIs are just indicating the re-adjusted clause number of old & new IGC Code, thus not advisable.

In the meantime, it is observed that the same inclination requirement is already covered by UR M46 (Note 3 of M46.2).

Still, it was found that similar requirements as Note 3 to M46.2 is present in item 8 of UR E10 (inclination test).

#### **2a. Specification of the data utilised in the development/revision of the proposed IACS Resolution, if any**

None.

### **3. Source/derivation of the proposed IACS Resolution**

UI SC6, UI SC 290  
SOLAS II-1/Reg.43.6  
1983 IGC Code, clause 2.9.2.2  
2014 IGC Code, clause 2.7.2.2  
IBC Code, clause 2.9.3.2

### **4. Summary of Changes intended for the revised IACS Resolution:**

Note 3 to M46.2 has been updated, adding reference clause nos. of the IGC Code (both 1983 IGC Code and 2014 IGC Code) and the IBC Code. By the transfer of the reference clauses, UI SC6 and UI SC290 have been deleted.

**5. Points of discussions or possible discussions**

It was suggested to also update UR E10 item 8 referencing Note 3 to M46.2. One member opined that the update of UR E10 could be addressed at a later stage. Following the qualified majority, UR E10 is also updated.

**6. Attachments if any**

None.

## UR M47 “Bridge control of propulsion machinery for attended machinery spaces”

### Summary

UR M47 requirements are transferred to UR M43 and is therefore deleted.

### Part A. Revision History

Version no.	Approval date	Implementation date when applicable
Del (Feb 2024)	02 February 2024	
New (1983)	1983	

- **Del (Feb 2024)**

#### 1 Origin of Change:

- Other (FUA N°9 of GPG 85 - update of the Rule linkage table)

#### 2 Main Reason for Change:

UR M47 was referring to UR M43 and it was decided to transfer its requirements to UR M43.

#### 3 List of non-IACS Member classification societies contributing or participating in IACS Working Group:

None.

#### 4 History of Decisions Made:

Considering the current wording of UR M47 saying that UR M43 applies to the bridge control of propulsion machinery for all machinery spaces (unattended and attended) with the exception of clause M43.7 (Rev.0) relating to steam turbines, members agreed that UR M47 can be transferred to UR M43.7 (Rev.0), which is renumbered as UR M43.5 (Rev.1) (PM20906dIMc).

#### 5 Other Resolutions Changes:

UR M43 includes now the requirements of UR M47 and UR M43 title is changed to “Bridge control of propulsion machinery” instead of “Bridge control of propulsion machinery for unattended machinery spaces”.

#### 6 Any hinderance to MASS, including any other new technologies:

None.

**7 Dates:**

Original Proposal	: 01 February 2021	(Ref: PM20906dIMa)
Panel Approval	: 10 January 2024	(Ref: 23186_PMa)
GPG Approval	: 02 February 2024	(Ref: 23186_IGc)

- **New (1983)**

No record available.

## Part B. Technical Background

List of Technical Background (TB) documents for UR M47:

**Note:** *There are no Technical Background (TB) documents available for the original version (1983) and Del (Feb 2024).*

## UR M51 "Factory Acceptance Test and Shipboard Trials of I.C. Engines"

### Part A. Revision History

Version no.	Approval date	Implementation date when applicable
Corr.1 (Oct 2018)	08 October 2018	-
Rev.4 (Feb 2015)	27 February 2015	1 July 2016
Rev.3 (Jan 2008)	15 January 2008	1 January 2009
Rev.2 (July 2003)	16 July 2003	-
Corr.1 (1997)	12 May 1997	-
Rev.1 (1990)	No records	-
New (1987)	No records	

- **Corr.1 (Oct 2018)**

.1 Origin for Change:

- Suggestion by IACS member

.2 Main Reason for Change:

-

.3 List of non-IACS Member classification societies contributing through the TC Forum and/or participating in IACS Working Group:

None

.4 History of Decisions Made:

The reference to UR M51.3.3.2 in UR M51.3.3.4 was changed to UR M51.3.3.3 for the reason that the operational profile of the engines driving generators for auxiliary purposes was evaluated to be more similar to that of the engines driving generators for electric propulsions (UR M51.3.3.3) rather than to that of the propulsion engines driving propeller or impeller only (UR M51.3.3.2).

TB document is not required for this corrigenda

.5 Other Resolutions Changes

None

.6 Dates:

Panel Approval: 17 September 2018 (Ref: PM18908)

GPG Approval: 08 October 2018 (Ref: 18141\_IGc)

- **Rev.4 (Feb 2015)**

- .1 Origin for Change:

- Request by non-IACS entity (CIMAC)
    - Suggestion by IACS members

- .2 Main Reason for Change:

- There existed differences between the current practices of diesel engine design and manufacture, and the current URs requirements. These discrepancies needed to be resolved through updating and revising the current UR M51.

- .3 List of non-IACS Member classification societies contributing through the TC Forum and/or participating in IACS Working Group:

- None

- .4 History of Decisions Made:

- The text of M51 was revised after the Kick-off PT meeting, and was discussed during the later three PT meetings. The revised draft was agreed at the last PT meeting. The draft UR prepared by the PT was further discussed by the Panel during the 14<sup>th</sup>, 15<sup>th</sup> and 16<sup>th</sup> meeting and by correspondence.

- .5 Other Resolutions Changes

- Other UR M files were also reviewed and edited (under subject number 7569\_).

- .6 Dates:

- Original Proposal: 02 April 2010 (Made by: IACS Members) Panel  
Approval: 08 January 2015 (By: IACS Machinery Panel) GPG  
Approval: 27 February 2015 (Ref: 7569\_IGw)

- **Rev.3 (Jan 2008)**

- Refer to the TB document in Part B.

- **Rev.2 (July 2003)**

- Refer to the TB document in Part B.

- **Corr. (1997)**

- Typographical error of paragraph number 2.12 was corrected to read as 2.1.2.

- **Rev.1 (1990)**

- No history files or TB document available.

- **Original resolution (1987)**

- No history files or TB document available.



## Part B. Technical Background

List of Technical Background (TB) documents:

Annex 1. TB for Rev.2 (July 2003)

See separate TB document in Annex 1.



Annex 2. TB for Rev.3 (Jan 2008)

See separate TB document in Annex 2.



Annex 3. TB for Rev.4 (Feb 2015)

See separate TB document in Annex 3.



*Note: No Technical Background (TB) documents available for New (1987), Rev. 1 (1990), Corr.1 (1997) and Corr.1 (Oct 2018).*

Annex 1 Technical Background (TB) document

**Technical Background (TB) document for Rev.2 (July 2003)**

WP/MCH submitted a proposed amendment to M51.2.1 “shipboard trials”.

\*\*\*

Annex 2 Technical Background (TB) document

**Technical Background (TB) document for Rev.3 (Jan 2008)**

**UR M50 (Rev.3, Jan 2008) “Programme for type testing of non-mass produced  
I.C. engines”**

**and**

**UR M51 (Rev.3, Jan 2008) “Programme for trials of i.c. engines to assess  
operational capability”**

**Machinery Panel Tasks PM5102 and PM6102**

**Objective and Scope:**

The aim of Task PM5102 was to reconsider UR M50 and UR M51 for electronically controlled two stroke and four stroke diesel engines especially in view of performance of the type approval test as required by the current UR M50 and the factory acceptance test as required by the current UR M51.

The aim of Task PM6102 was to clarify the text of UR M51 2.1.3 and 2.1.4 to avoid different interpretations regarding the tests to be carried out on engines used for ship's electrical propulsion.

It has been decided by the Panel to combine both tasks to one Revision only.

**Points of discussion:**

In Task 5102 three issues have been identified to be reflected in UR M50 and UR M51:

- a) Reference to the FMEA required by UR M44 for the type approval test in M50.
- b) A possible waiver for specific tests for an engine type which already has been type tested as conventional mechanical diesel engine (e.g. turbo charger cutoff test) in M50.
- c) Reference to FMEA for the FAT and other tests in UR M51.

During the discussion the preference of the group was not to mention the turbocharger cut-off test explicitly, but rather to include a more generic statement.

As far as testing on board is concerned in UR M51 2.1.3 the wording “Main engines driving generators for propulsion” is not intended to include engines driving generators, which also supply electrical power to the ship network.

The intention of this paragraph is to address the tests to be carried out when an engine drives a generator, which is dedicated to the supply of an electric propulsion motor.

Engines driving generators supplying electrical power to the ship network (even if electrical propulsion is included among the network electrical users) are to be tested as required in UR M51 2.1.4.

The need to revise the wording to meet the above interpretation was discussed. In addition during the discussion it has been recognized that also the wording “rated power” in UR M51

2.1.3 a) may lead to different interpretations, since it is not immediate to understand if reference is made to rated power of the engine, of the generator or of the propulsion motor. It has been agreed that the intent of the requirement is referred to the rated power of the propulsion motor.

### **Conclusion:**

Following changes are proposed:

UR M50: insert in 3.3 Functional tests

“3.3.5 Integration Test

For electronically controlled diesel engines integration tests shall verify that the response of the complete mechanical, hydraulic and electronic system is as predicted for all intended operational modes. The scope of these tests shall be agreed with the Society for selected cases based on the FMEA required in UR M44.”

M50.5 Notes

“5.3 If an electronically controlled diesel engine has been type tested as a conventional engine the Society may waive tests required by this UR provided the results of the individual tests would be similar.”

UR M51: Include a new paragraph 1.5 with the same text as in 3.3.5 above.

Based on the discussion of Task 6102 a new wording has been agreed for UR M51, Paragraph 2.1.3 :

“2.1.3 Single main engine driving generator for propulsion”

UR M51 2.1.3 a) shall read:

“100% power (rated propulsion power): at least 4 hours”

and the relevant note has to be modified to:

"Tests are to be based on the rated electrical powers of the electric propulsion motor."

The changes have been agreed unanimously by Panel members.

Submitted by Machinery Panel Chairman  
22 November 2007

**(Permanent Secretariat note: Approved by GPG 15 January 2008, ref. 7720\_IGc)**

Annex 3 Technical Background (TB) document

## **Technical Background (TB) document for Rev.4 (Feb 2015)**

### **Scope and objectives**

The valid version (January 2008) does not contain any safety precautions or test bed requirements. Test requirements for engine plants with power take off were also lacking.

Important testing of the entire propulsion plant when passing through barred speed ranges and system stability are not addressed in the present version.

It was decided to edit the revision in a chronological order, i.e. starting with safety precautions and general requirements.

### **Engineering background of changes and additions.**

The following descriptions of technical backgrounds follow the sequence of the proposed revision.

- A) Requirements to safety of personnel were taken over from the revised UR on type testing.
- B) Recording of parameters to be taken during the FAT needed to be clarified. It was decided to require almost the same level as for type testing.
- C) In item 3.3.1 the main objective of the overload test is to establish the margin between turbocharger speed at 110% load under stable conditions and turbocharger overspeed.
- D) In item 3.3.2 and 3.3.3 the objectives of the 110 % overload requirement are explained (old text being unclear).
- E) Item 3.3.4 is new and defines the required overload. The difference to gensets is that the overload refers to propulsion together with 110 % generator overload. This is clarified in the text.
- F) Item 3.4 is new and deals with turbocharger surge margins for propulsion engines. In this chapter, the matching of the turbocharger with the engine is considered based upon member practices. Turbochargers shall have a compressor characteristic that allows the engine, for which it is intended, to operate without surging during all operating conditions. For category C turbochargers used on propulsion engines the methods for surge margin testing during the engine workshop testing are specified. Although confirmation of surge margins using actual engines is preferable, using a compressor chart is allowed as an alternative verification method for 2-stroke engines because testing using actual engines can be difficult for reasons such as cost, etc.

G) Start up tests is removed from the FAT to the Shipboard trials since this is a matter of starting media capacity.

H) The previous reference to running-in under Shipboard trials is moved to the beginning of FAT.

I) Under Shipboard trials in 4.1 the objectives are explained. The old M51 dealt with the engine only. The new and expanded text deals with the engines' compatibility with the entire plant and its control systems.

J) In item 4.4.1 (propulsion engines with fixed pitch propeller) the important change is that the previous requirement of 70 % astern rpm is removed. For the same reason the sub-item on stopping tests contains a warning and a reference to 4.5.1 which deals with torsional vibrations in barred speed ranges. Passing through a barred speed range can lead to excessive torsional vibration (more than theoretically estimated) and cause slippage of a keyless fitted propeller (and even bent shafts), unless the passage is made in a proper way. This is particularly important when operating the engine in the astern direction. The torque-rpm characteristic can be different from forward, especially if the ship is moving slowly forward. This affects the propeller damping which usually is the major damping source. Therefore the previous testing requirement of 70 % astern rpm is removed. There is no reason to expose the plant to unnecessary risk, and the 70 % is not a SOLAS requirement.

Note: The 70 % requirement probably originated from steam turbines in order to dimension the astern turbine properly.

K) Item 4.4.3 is new and deals with engines driving generators for electric propulsion and/or auxiliary. It was discussed whether a single engine driving a generator for propulsion should be a separate item, but since the selected requirements were identical it was considered there was no need for it. This requirement applies irrespective of whether an engine is used either:

- as part of a common power generation system used for both propulsion and auxiliary power; or
- exclusively to generate power for electric propulsion.

L) Item 4.4.4 is also new and deals with propulsion engines having PTO. The chosen requirements are analogous to the corresponding items in 4.4.

M) Item 4.5.1 (passing through a barred speed range) is new. The background is explained in J) above.

Both up and down passage are to be recorded since either of them can lead to the highest vibration level.

The ship's draft and speed are also important parameters. The slowest passage (and thus highest vibration level) will occur at maximum draft and

with hull fouling. This has to be considered in connection with the various acceptance criteria by the Societies.

Last but not least, a stable fuel index is very important. The influence of even small fuel index oscillations on the torsional vibration level is often severely underestimated. Even more important than the oscillation amplitude is the phase angle. As the latter is not visible, the acceptance level for the (double) amplitude of oscillation is conservatively set.

## **Attachments**

None

## UR M52 'Length of aft stern bush bearing'

### Summary

The purpose of the present revision is to introduce requirements for grease lubricated bearings and for the type approval of synthetic materials for oil lubricated stern tube bearings.

### Part A. Revision History

Version no.	Approval date	Implementation date when applicable
Rev.2 (Nov 2019)	21 November 2019	1 January 2021
Rev.1 (Jan 2019)	7 January 2019	1 January 2020
New (1986)	-	

- **Rev. 2 (Nov 2019)**

#### 1 Origin of Change:

- Suggestion by IACS member

#### 2 Main Reason for Change:

During the revision of UR M52 (Rev.1, Jan 2019) regarding water lubricated bearings:

- one member proposed to introduce requirements in UR M52 for grease lubricated bearings, arguing that such bearings could be found on some small ships.
- one member proposed to introduce a clause requiring the type approval of synthetic materials intended for oil lubricated stern tube bearings, in the same way as for water lubricated stern tube bearings (see UR M52.3.3).

#### 3 List of non-IACS Member classification societies contributing through the TC Forum and/or participating in IACS Working Group:

None

#### 4 History of Decisions Made:



UR M52 Rev.2 agreed during the 30<sup>th</sup> meeting of the Machinery Panel.

**5 Other Resolutions Changes**

None

**6 Any hinderance to MASS, including any other new technologies:**

None

**7 Dates:**

Original Proposal: January 2019 (Machinery Panel member)  
Panel Approval: September 2019 (30th panel meeting) and  
30 October 2019 (Ref: 18213aPMa)  
GPG Approval: 21 November 2019 (Ref: 18213aIGb)

• **Rev. 1 (Jan 2019)**

**1 Origin of Change:**

Suggestion by IACS member

**2 Main Reason for Change:**

Resolve reservation by one member against M52.3

**3 List of non-IACS Member classification societies contributing through the TC Forum and/or participating in IACS Working Group:**

None

**4 History of Decisions Made:**

UR M52 Rev.1 agreed by correspondence

**5 Other Resolutions Changes**

None

**6 Dates:**

Original proposal: Proposal by Machinery Panel member, September 2018  
Final Approval by the Machinery Panel: 11 December 2018 (Ref: PM18105\_IME)  
GPG Approval: 07 January 2019 (Ref: 18213\_IGb)

- **New (1986)**

No records available

## **Part B. Technical Background**

List of Technical Background (TB) documents for UR M52:

Annex 1. **TB for Rev.1 (Jan 2019)**

See separate TB document in Annex 1.

Annex 2. **TB for Rev.2 (Nov 2019)**

See separate TB document in Annex 2.

Note: There is no Technical Background (TB) document available for New (1986).



## **Technical Background (TB) document for UR M52 Rev.1 (Jan 2019)**

### **1 Scope and objectives**

The UR was revised to resolve a reservation by one member against requirements for lignum vitae as bearing material.

### **2 Engineering background for technical basis and rationale**

The Panel agreed unanimously to remove paragraph 3 from this UR, noting that the requirement is from 1986 and that water lubricated bearings of lignum vitae are no longer installed in current designs.

### **3 Source/derivation of the proposed IACS Resolution**

UR aligned with current industry practice

### **4 Summary of Changes intended for the revised Resolution**

Removal of paragraph 3 relating to water lubricated bearings of lignum vitae

One Member Society proposed to modify the existing paragraph M52.4 on "Water lubricated bearings of synthetic material", renumbered in Revision 1 as M52.3, in order to generalize the 4 times criteria for water lubrication bearings subject to the special consideration for bearings of synthetic materials. The proposal was finally agreed by the qualified majority to read as follow:

"M52.3 Water lubricated bearings

3.1 The length of the bearing is to be not less than 4.0 times the Rule diameter of the shaft in way of the bearing.

3.2 For a bearing of synthetic material, consideration may be given to a bearing length not less than 2.0 times the Rule diameter of the shaft in way of the bearing, provided the bearing design and material is substantiated by experiments to the satisfaction of the Society.

3.3 Synthetic materials for application as water lubricated stern tube bearings are to be Type Approved."

### **5 Points of discussions or possible discussions**

- One Member Society proposed to introduce requirement in UR M52 for grease lubricated bearings and proposed the following wording to be added in the UR:

"M52.3 Grease lubricated bearings

The length of grease lubricated bearings is generally to be not less than 4 times the rule diameter of the shaft in way of the bearing.

For installations with adequate sealing / gland devices, the minimum length of the bearings may be determined in accordance with M52.1 or M52.2, as applicable."

The qualified majority of Members agreed to introduce such requirements in the UR M52 but also agreed to reconsider the matter at the next revision of the UR.

- One Member Society proposed to modify para 1.2 as follow:

"1.2 The length of the bearing may be less provided the normal bearing pressure is not more than 8 bar as determined by static bearing reaction calculation taking into account shaft and propeller weight which is deemed to be exerted solely on the aft bearing divided by the projected area of the shaft and if the results of the operational check are satisfactory. However, the minimum length is to be not less than 1,5 times the actual diameter."

But the proposal was not supported by the qualified majority.

**6 Attachments if any**

None

## **Technical Background (TB) document for UR M52, Rev.2 (Nov 2019)**

### **1 Scope and objectives**

The UR M52 was revised to:

- introduce requirements for grease lubricated stern tube bearings,
- require synthetic materials for oil lubricated stern tube bearings to be type approved.

### **2 Engineering background for technical basis and rationale**

The Panel, on the basis of the members' experience, agreed to require a minimum length for a grease-lubricated bearing of not less than 4.0 times the rule diameter of the shaft in way of the bearing.

The Panel also agreed that synthetic materials, which are required to be type approved for application as water lubricated stern tube bearings (see UR M52.3.3), should also be required to be type approved for application as oil lubricated bearings.

### **3 Source/derivation of the proposed IACS Resolution**

The new requirements for grease lubricated stern tube bearings and for the type approval of synthetic materials for oil lubricated stern tube bearings are aligned with industry practice.

### **4 Summary of Changes intended for the revised Resolution**

The Panel decided to introduce the following text:

- "M52.4 Grease lubricated bearings  
4.1 The length of a grease lubricated bearing is to be not less than 4.0 times the rule diameter of the shaft in way of the bearing."
- "2.3. Synthetic materials for application as oil lubricated stern tube bearings are to be Type Approved."

### **5 Points of discussions or possible discussions**

- One member proposed to add the following relaxation for grease lubricated stern tube bearings:  
"For installations with adequate sealing / gland devices, the minimum length of the bearings may be determined in accordance with M52.1 or M52.2, as applicable."

This proposal was however not supported by the qualified majority.

- One member proposed to add requirements for bearings made of synthetic materials and intended for applications such as pintle, stock and carrier disc bearings in rudders and possibly in other ship equipment e.g. fins stabilizers.

This proposal was however not supported by the qualified majority.

- One member proposed to develop criteria for the type approval of synthetic materials used for oil lubricated and water lubricated bearings.

This proposal was supported by the qualified majority and the Panel decided to develop a new UR to address it.

#### **6 Attachments if any**

N/A

## UR M53 “Calculations for I.C. Engine Crankshafts”

### Summary

The Revision 5 of this UR provide amendments to the formula for the calculation of the acceptability factor (Q) for crankpin fillet & journal fillet in Appendix IV, paragraph 4.3.

### Part A. Revision History

Version no.	Approval date	Implementation date when applicable
Rev.5 (May 2023)	25 May 2023	1 July 2024
Rev.4 (Aug 2019)	13 August 2019	1 January 2021
Rev.3 (June 2017)	15 June 2017	1 July 2018
Rev.2 (Jan 2011)	06 Jan 2011	1 Jan 2012
Rev.1 (Dec 2004)	Dec 2004	1 Jan 2007
New (1986)	1986	-

#### • Rev.5 (May 2023)

##### 1 Origin of Change:

- Request by non-IACS entity (CIMAC)

##### 2 Main Reason for Change:

CIMAC proposed to modify the formula for the calculation of the acceptability factor (Q) for crankpin fillet and journal fillet in UR M53 (Rev.4, Aug 2019) Appendix IV, paragraph 4.3 for the reason that the use of the maximum principal equivalent stress formulation was evaluated to be more appropriate than the multi-axial Gough-Pollard formulation.

##### 3 List of non-IACS Member Classification Societies contributing through the TC Forum and/or participating in IACS Working Group:

None

##### 4 History of Decisions Made:

- 1) Initial proposal submitted by CIMAC in February 2021 (Ref. PM21903\_IMa dated 16/02/2021)
- 2) On December 2022 Machinery Panel requested to CIMAC to clarify the technical points and support of the proposed modification.
- 3) The UR M53 (Rev. 5) was agreed by correspondence in Machinery Panel



## 5 Other Resolutions Changes

None

## 6 Any hinderance to MASS, including any other new technologies:

None

## 7 Dates:

Original Proposal:	February 2021	(Ref. PM21903_IMa dated 16/02/2021)
Panel Approval:	21 April 2023	(Ref: PM21903_IMf)
GPG Approval:	25 May 2023	(Ref: 22053_IGd)

## • Rev.4 (Aug 2019)

### 1 Origin of Change:

Request by non-IACS entity (CIMAC)

### 2 Main Reason for Change:

CIMAC proposed to modify the formula for the calculation of the acceptability factor (Q) for crankpin oil bore in UR M53 (Rev.3, June 2017) Appendix IV, paragraph 4.3 for the reason that the use of the maximum principal equivalent stress formulation was evaluated to be more appropriate than the multi-axial Gough-Pollard formulation.

### 3 List of non-IACS Member Classification Societies contributing through the TC Forum and/or participating in IACS Working Group:

None

### 4 History of Decisions Made:

- 4) Initial proposal submitted by CIMAC in May 2018 (Ref. PM18916\_IMa dated 07/05/2018)
- 5) On October 2018 and later on January 2019 (Ref. PM18916\_PMa dated 01/10/2018 and PM18916\_PMc dated 15/01/2019) the Machinery Panel requested to CIMAC significant examples in support of the proposed modification.
- 6) The UR M53 (Rev. 4) was agreed by correspondence

## 5 Other Resolutions Changes:

None

## 6 Any hinderance to MASS, including any other new technologies:

None

## 7 Dates:

Original Proposal: May 2018 (Ref. PM18916\_IMa dated 07/05/2018)

Panel Approval: 22 July 2019 (Ref: PM18916\_IMf)

GPG Approval: 13 August 2019 (Ref: 19145\_IGb)

## • Rev.3 (June 2017)

### 1 Origin of Change:

- Request by non-IACS entity (CIMAC)

### 2 Main Reason for Change:

CIMAC has proposed changes of existing UR M53 (Rev.2) with the inclusion of new Appendices allowing to:

- a. provide methods using Finite Elements calculations in order to evaluate stress concentration factors, in addition to existing empirical formulae used presently.
- b. provide methods in order to evaluate stress in oil bore and fillets when surface treatment process is applied.
- c. provide methods in order to evaluate fatigue strength by experiment

### 3 List of non-IACS Member Classification Societies contributing through the TC Forum and/or participating in IACS Working Group:

None

### 4 History of Decisions Made:

- Initial proposal submitted by CIMAC in February 2011
- Appendix VI submitted by CIMAC in May 2012
- IACS comments to CIMAC proposal sent to CIMAC in November 2013
- Revised documents submitted by CIMAC in February 2014
- UR M53 revised in accordance with CIMAC comments and adopted by the Machinery Panel in April 2015
- Revised UR M53 submitted to CIMAC in April 2015
- CIMAC comments received in June 2015. CIMAC agreed that the examples would not be introduced in the UR but in the Technical Background.
- Final version of UR M53 (Rev.3) adopted by the Machinery Panel at the 22<sup>nd</sup> meeting in March 2016

### 5 Other Resolutions Changes

None

### 6 Dates:

Original Proposal: Feb 2011 Made by CIMAC Panel

Approval: 24 May 2017 (Ref: PM11100)

GPG Approval: 15 June 2017 (Ref 12184\_IGc)

## • Rev.2 (Jan 2011)

### 1 Origin of Change:

- Request by non-IACS entity (CIMAC)

### 2 Main Reason for Change:

CIMAC raised the issue that the empirical stress concentration factors in the calculation rules in the UR M53 do not cover some of the currently used crankshaft designs. Therefore in order to assist, the alternative method for calculation of Stress Concentration Factors in the web fillet radii of crankshafts by utilizing Finite Element Method was agreed.

### 3 List of non-IACS Member classification societies contributing through the TC Forum and/or participating in IACS Working Group:

None

### 4 History of Decisions Made:

CIMAC submitted its proposal during the IACS-CIMAC (WG2) Sept. 2008 meeting. The proposal was then discussed in the Machinery Panel. After reviewing the proposal the Machinery Panel had comments which were later clarified by CIMAC. However the IACS Machinery Panel had concerns with the extent of validation, as the validation was made for one test previously and that no further validation data was available. After further discussion it was agreed to insert it as an appendix and use it as an alternative approach when the prescriptive method does not apply.

### 5 Other Resolutions Changes

None

### 6 Dates:

Original Proposal: September 2008 Made by CIMAC (WG2)

Panel Approval: September 2010

GPG Approval: 06 January 2011 (Ref: 10171\_IGc)

## • Rev.1 (Dec 2004)

See TB in Part B.

## • New (1986)

No TB document available.

## **Part B. Technical Background**

List of Technical Background (TB) documents for UR M53:

Annex 1     **TB for Rev.1 (Dec 2004)**

See separate TB document in Annex 1.

Annex 2     **TB for Rev. 2 (Jan 2011)**

See separate TB document in Annex 2.

Annex 3     **TB for Rev. 3 (June 2017)**

See separate TB document in Annex 3.

Annex 4     **TB for Rev. 4 (Aug 2019)**

See separate TB document in Annex 4.

Annex 5     **TB for Rev. 5 (May 2023)**

See separate TB document in Annex 5.

*Note: There is no separate Technical Background (TB) document for New (1986).*

**CIMAC Crankshaft Working Group (WG4)  
Documentation and remarks to IACS WP/MCH comments  
July 2. 2003, M. W. Rasser / Chairman**

**CIMAC Proposal for Revised M53  
IACS WP/MCH Comments**

Comments have been received from members and these essentially stem from the need to provide technical justification for the changes and new requirements.

For the proposals to be accepted and incorporated as Unified Requirements we have to provide a technical justification for the requirements and it is noted that we have not received any additional technical documentation other than the 30 pages expanded from the original 15.

Identification of the changes and the background to each change and addition is required as part of the technical justification.

Some comments received include:

1) Fig 5 and Fig 7

For crankshafts with overlap and recessed fillets, the web thickness  $W$  appears to be taken at the outside of the web which is different from that indicated in Fig 5 for a crankshaft without overlap, where  $W$  is taken from the centre of the recessed fillet.

CIMAC remark:

The definition of  $W$  for cranks with overlap is identical to M53-issue 1986, and is taken from the outside of the web.

The definition of  $W$  for cranks without overlap is newly introduced, see Fig. 5.

The newly introduced definition of  $W$  is proposed based on the fact that all 2-stroke manufacturers have crankshafts in operation for long time which do not fulfil the M53 with respect to the limitation of  $TH$  ( $TH \leq RH$ ).

The proposal is therefore to define a reduced web thickness in such a way that it ends at the centre of  $RH$ . The definition also matches the relevant cross section more closely.

2) M53.2.2.2

Statement there are to be no barred speed ranges above a speed ratio of  $\lambda > 0.8$  of rated speed. It is not unusual to have barred speed ranges above a speed ratio of  $\lambda > 0.8$  for the one cylinder misfiring condition in two stroke engines and it is suggested that the sentence should be modified to read. There are to be no barred speed ranges above a speed ratio of  $\lambda > 0.8$  for normal firing conditions.

CIMAC remark:

Agreed. The wording is included in the latest draft M53 revision.

3) M53.6

- K factor for cast steel crankshaft (was 0.93) has been removed and replaced by “is to be agreed between engine manufacturer and the Classification Society.” No technical justification has been given about the inadequacy of the previous value considering that semi-built cast steel crankshafts are widely used. It is considered that a specific value should be established in the UR. Also it is considered necessary to establish basic requirements regarding fatigue testing of crankshafts or specimens and to include these in the UR.

CIMAC remark:

The K factor for cast steel cranks has been removed and replaced by the comment on agreement between engine builders and Classification Society. The wording was agreed between CIMAC and the IACS representative Mr. E. Sandberg in a meeting held on 15/16 April 1999.

The reason for the modified wording was that the previous figure of 0.93 was not considered realistic according to crankshaft manufacturer data. In current practice only 2-stroke engines use cast steel cranks with special treatment (e.g. stroke peening). Those engines never use the K figure, as given in UR M53 – issue 1986, but get individual approval from Classification Societies.

The wording as proposed is now consistent with the procedures followed since many years.

- Regarding the provision of alternative means of determining of fatigue strength based on testing of specimens taken from a full size crankthrow it is proposed a size correction factor should be established, or to develop procedures for specimen testing in order to provide for a common basis of acceptance of such fatigue test results.

CIMAC remark:

CIMAC see the development of a common basis for the acceptance of fatigue test results outside the scope of the UR M53 revision. The wording in M53.6 as proposed is now consistent with the procedures followed since many years.

#### 4) M53.2.1.3

The calculation of alternating bending stress does not take into account alternating axial stress. For crosshead type engines LR Rules take into account axial alternating stress derived from forced-damped calculations.

The section includes a procedure for calculating alternating bending and torsional stresses in outlet of oil bore. LR Rules do not publish a procedure but require that a fatigue strength calculation or alternative fatigue test results may be required to demonstrate acceptability of the design. Whilst no objection is raised to the proposed approach its accuracy is crucially dependent on the evaluation of the stress concentration for the oil hole. In the absence of a detailed justification, LR would continue to require, perhaps as an alternative to the proposed calculation method full fatigue analysis or experimental results.

#### 5) M53.3

The dimensional ratio  $r$  lower limit is extended to 0.015, LR Rules limit this to 0.03. It is not clear on what grounds this extension is proposed.

CIMAC remark:

The discussion to extended the range of the parameter “ $r$ ” from the current value of 0.03 down to lower values dates back some years. Meanwhile technical progress has obviated this range extension, as it is unlikely that modern crankshaft designs show fillet radii with the parameter “ $r$ ” below 0.03.

The latest draft M53 therefore goes back to the original range for the parameter “ $r$ ” with a lower limit of 0.03.

6) M53.4

These stresses indicate that the misalignment component considered is  $\sqrt{10}\text{N/mm}^2$  and that for the crosshead engines, assuming the same level of misalignment the axial component is  $\sqrt{20}\text{N/mm}^2$ .

LR would recommend that the value of  $\sqrt{20}\text{N/mm}^2$  should be used only as guidance where no axial vibration calculations are available. It is considered that this value may be too high for a majority of systems operating away from axial or torsional (cross coupled effect should be considered) natural frequencies.

CIMAC remark:

CIMAC agree with this recommendation, nevertheless the wording of the UR M53 – issue 1986 is carried over to the latest draft M53.

7) M53.8

The background to the expression in paragraph 8.2 is requested.



CIMAC remark:

M53.8 para 8.2

21/1/2002 MWR

$M_{max}$  ... Maximum torque [Nm]

$D_s$  ... Shrink fit diameter [mm]

$D_{BG}$  ... Bore diameter [mm]

$S_R$  ... Safety against slipping [-]

$\mu$  ... friction coefficient [-]

Area of pressfit

$$A = D_s \cdot l_s \cdot \pi \quad [\text{mm}^2]$$

Contact pressure (necessery)

$$\text{Tangential force : } F_T = \frac{M_{max} \cdot S_R \cdot 2}{D_s}$$

$$\text{Friction force : } F_R = p \cdot A \cdot \mu$$

#

$$p = \frac{M_{max} \cdot S_R \cdot 2 \cdot 1000}{\mu \cdot \pi \cdot D_s^2 \cdot l_s}$$

Tangential stress at inner bore diameter

$$\sigma_V = - \frac{2 \cdot p}{1 - \left(\frac{D_{BG}}{D_s}\right)^2} = - \frac{M_{max} \cdot S_R \cdot 4000}{\mu \cdot \pi \cdot D_s^2 \cdot l_s \cdot \left(1 - \left(\frac{D_{BG}}{D_s}\right)^2\right)}$$

$\sigma_V$  must be lower than  $\sigma_{sp}$

$$\Rightarrow D_{BG} = D_s \cdot \sqrt{1 - \frac{M_{max} \cdot S_R \cdot 4000}{\mu \cdot \pi \cdot D_s^2 \cdot l_s \cdot \sigma_{sp}}} \Rightarrow \text{represent the maximum bore diameter, where } \sigma_{sp} \text{ is reached}$$

The method uses the linear elastic theory to calculate stresses.

#### Literature

- „Auslegung elastisch-plastisch beanspruchter Pressverbände“ Author Franz Gustav Kollmann published in "Forschung Ing.-Wes." Vol. 44 (1978) NR. 1, p. 1 – 11
- DIN 7190 "Pressverbände, Berechnungsgrundlagen und Gestaltungsregeln"

A reply to the points raised a copy of the development process for the proposed changes that include technical justifications would assist in the final acceptance of the proposals by the WP/MCH.

Norman Rattenbury  
Lloyd's Register of Shipping  
26<sup>th</sup> September 2001



## **UR M53 REVISED EDITION**

**MAIN DIFFERENCE  
BETWEEN DECIDED WORDING DURING  
CIMAC W.G. MEETING (15/16<sup>th</sup> APRIL 1999)  
AND FINAL WORDING PRESENTED  
IACS/CIMAC COMMON MEETING  
(11<sup>th</sup> NOVEMBER 1999)**



**§ 53.2.2.2. « CALCULATION OF NOMINAL  
ALTERNATING TORSIONAL STRESS »**

**NEW TEXT IS ONLY CLEARER  
ON DEFINITION, METHOD  
AND USE OF METHOD.**



**PRESENTATION OF CIMAC W.G. C.D. WORK**

**DURING COMMON MEETING CIMAC/IACS**

**HELD IN OSLO 11<sup>th</sup> OF NOVEMBER 1999**



## UR M53

### CIMAC PROPOSAL SYNTHESIS

#### WHAT WAS NOT CHANGED

- CALCULATION PRINCIPLE
- NOMINAL STRESS CALCULATIONS
- STRESS CONCENTRATION FACTORS CALCULATIONS
- FATIGUE STRENGTH FORMULA
- SHRINKFIT CALCULATIONS IN CASE OF SEMI-BUILT CRANKSHAFT
- MINIMUM SAFETY COEFFICIENT FACTOR FIGURE



## UR M53

### CIMAC PROPOSAL SYNTHESIS

#### WHY NO CHANGE ?

- **AFTER YEARS OF EXPERIENCE, PRESENT METHOD GIVES GENERALLY PRETTY GOOD RESULTS ON THE SAFE SIDE.**
- **IT MINIMIZES AMOUNT OF WORK.**
- **IT SHOULD BE EASIER TO COME TO AN AGREEMENT ON UPDATED VERSION BETWEEN BOTH PARTIES.**



## UR M53

### CIMAC PROPOSAL SYNTHESIS

#### WHY CHANGES ?

- **IN ORDER TO HAVE A SAFER DESIGN OF CRANKSHAFT (SAFETY FACTOR AROUND OIL HOLE).**
- **IN ORDER TO BE MORE WELL SUITED TO NOWADAYS CRANKSHAFT DESIGN (EXTENSION OF CONCENTRATION FACTOR RANGE AND GEOMETRICAL PARAMETERS OF SEMI-BUILT CRANKSHAFT).**
- **IN ORDER TO AVOID MISTAKE IN APPLYING THE U.R. BY AVOIDING AMBIGUOUS DEFINITIONS.**
- **IN ORDER TO OPEN THE U.R. TO ALTERNATIVE ASSESSMENT PROCEDURES (SURFACE TREATMENT, FATIGUE STRENGTH, F.E. CALCULATIONS, ...).**



## UR M53

### CIMAC PROPOSAL SYNTHESIS

#### **MAIN IMPROVEMENTS ALREADY PRESENTED TO IACS AND DOCUMENTED**

- **SAFETY FACTOR CALCULATION AROUND CRANKPIN OIL HOLE (ONLY IN CASE OF DIAMETRAL ONE).**
- **EXTENSION OF SOME CONCENTRATION FACTORS RANGE (ONLY WHEN FEASIBLE ACCORDING TO PREVIOUS EXPERIMENTAL RESULTS).**
- **IMPROVED DEFINITIONS OF CALCULATION PRINCIPLE, VARIOUS STRESSES AND STRESS CONCENTRATION FACTORS.  
(IN CONSISTENCY WITH ANALYSIS METHOD USED AT CREATION OF PRESENT U.R.).**
- **CLARIFICATION CONCERNING GEOMETRIC PARAMETERS OF CRANKSHAFT.  
(SPECIALLY IN CASE OF 2 STROKES ENGINES)**





## **UR M53**

### **CIMAC PROPOSAL SYNTHESIS**

#### **WHAT WAS IMPROVED SINCE OUR LAST MEETING ACCORDING TO IACS/WP REQUESTS**

- **MORE PRECISE DEFINITION OF EQUIVALENT ALTERNATING STRESSES USED IN U.R.**

**THESE DEFINITIONS ARE SUPPORTED BY 2 APPENDIXES INCLUDED IN CIMAC PROPOSED TEXT :**

- **APPENDIX 1 FOR STRESSES IN FILLETS**
- **APPENDIX 2 FOR STRESSES AROUND OIL HOLE**

- **NEW PARAGRAPH CONCERNING FATIGUE STRENGTH OF CRANKSHAFT TO ALLOW – AS AN ALTERNATIVE – CLASSIFICATION SOCIETY APPROVED EXPERIMENTAL METHODS BASED ON SAMPLE RESULTS (AND NOT ON FULL SCALE CRANKTHROW).**



## UR M53

### **IACS POSITION AFTER PRESENTATION OF CIMAC UR M53 REVISED TEXT :**

- **NEW PROPOSAL IS CLEARER AND DOES NOT NEED MUCH INTRODUCTION AND SUPPORT INFORMATION.**
- **SOME PRECISIONS AND MODIFICATIONS ARE STILL ASKED TO CIMAC C.D. W.G.**
- **DETAILED REVIEW AND EVALUATION OF PROPOSAL IS REQUESTED TO EACH MEMBER OF IACS/WP/MCH BEFORE END OF YEAR 2000.**

## **Revision of Unified Requirements UR M53, Calculation of Crankshafts for Internal Combustion Engines – Task 8.**

Mr. Bertrand, chairman CIMAC WG-Crankshaft Dimensions (CD) gave a presentation on the subject and informed about the new CIMAC proposal for revised UR M53. It was emphasized that fundamental parts had not been altered, but that weak areas had been improved and volume thus increased from earlier 15 pages to now 30.

In the presentation and the subsequent discussion the following was highlighted :

- The **new proposal is clearer than earlier versions and do not need much introduction and support information**. However, when submitting the final proposal to WP/MCH, **CIMAC was requested to provide documentary evidence of :**

- (a) **Specific reasons for individual requirement changes.**
- (b) **That the changes have the full support of all associated manufacturers of 2 and 4 stroke engines.**

- Current proposal is to be considered as a temporary proposal. Even when accepted and included in the IACS UR, the work within CIMAC, aiming at further improvements, will continue in line with the technical development.

- Shrink fit criteria are not covered by the current proposal. This is a task for future development/revisions.

- The new proposal is covering steel crankshafts, and is not suitable for crankshafts made from cast iron.

- It is important that criteria are well defined. GL's experience from last IACS audit clearly illustrated how difficult it could be to explain to an auditor on what basis approval was made when not in compliance with current UR M53.

- The new proposal (ref. top of page 4) have a paragraph which opens for the use of other criteria than those given in the UR itself. A number of WP/MCH's members found this somewhat confusing and expressed that lack of common minimum requirements, could involve that members in principle were free to accept designs on a subjective basis. This could mean that **we do not have Unified Requirements, but Unified Recommendations. Is this considered sufficient for crankshafts ?**

- With basis in above, **it was considered mandatory that the UR M53 gave clear criteria/definition as to what could be considered as « equivalent methods »**. Accordingly, and upon request, Mr. Sandberg, DNV produced a proposal for definition/interpretation of the term « equivalent » intended applied for the new proposal to UR M53. The proposal with ref. to M53, page 4, amendment to 1.1 scope : ..... equivalence to these rules, reads : *« Equivalence is understood as : No alteration in principles affecting non apparent safety factors, i.e. the assumption of max bending and max torsion coinciding in time and position is to be maintained together with the acceptability factor. Empirical methods as e.g. calculation of nominal stresses, stress concentration factors, combination of stresses, fatigue strength, etc may be replaced by more relevant methods of ..... »*

It was agreed that :

0. *Copy of the presentation given by Mr. Bertrand should be submitted WP/MCH's chairman (preferably in electronic form) for distribution to the WP/MCH members. Status : Not yet received. Reminder is hereby given.*
1. *All WP/MCH members should evaluate above definition together with the already distributed proposal for revision of UR M53.*
2. *All WP/MCH members should perform a detail review of the proposal submitted (together with above definition of equivalency) and revert with their comments to WP/MCH's chairman within end of this year. In this respect due attention should also be paid to the language and terms used. (In some places, translation to English (from French and German) have resulted in some unfortunate terms/wording, which need to be evaluated and considered corrected, e.g. W is defined as second moment of area).*



## **SHORT HISTORY OF UR M53** **TECHNICAL EVOLUTION (1986 – 1999)**

- **SEPT. 91 (PARIS) :**
  - **First discussions about oil hole safety factor calculation.**
  
- **JUNE 92 (PARIS) :**
  - **Definition, then edition, of « Basic Documents » on which are based the original version of UR M53.**
  - **Discussion on the range of validity for SCF parameters.**
  
- **JUNE 93 (PARIS) :**
  - **Proposal for introducing plasticity criteria in shrinkfit.**
  - **Approval of oil hole method.**
  - **Approval of decisions concerning SCF parameters extension range.**
  
- **OCT. 94 (WINTERTHUR) :**
  - **Discussion about new definition for W and B.**
  - **Proposal for calculation of shrinkfit with plasticity.**
  
- **JUNE 97 (PARIS) :**
  - **Approval of modification concerning W, B and shrinkfit calculations with plasticity.**



- **JUNE 98 (COPENHAGEN) :**

- 1<sup>st</sup> complete rewording of UR M53 incorporating :

- \* Oil hole safety coeff. calculation method

- \* Extension range of SCF factors

- \* Clear definitions of various parameters consistently with « Basic Documents »

- \* Cancellation of proposed method about plasticity effects during shrinkfit

- 1<sup>st</sup> discussion about future of UR M53

- **APRIL 99 (ST NAZAIRE) :**

- Definitive revision of UR M53 agreed by all W.G. members with addition of :

- \* Appendix for clear explanation of SCF.

- \* Possibility of  $\sigma_{DW}$  determination by alternative experimental method.

- State of art in crankshaft design presented by each W.G. member.

- **OCT. 99 :**

- Presentation to IACS WP/MCH of previous revised edition of UR M53 (with only one editorial modification).

## **Technical Background for UR M53 Rev.2, Jan 2011**

### **1. Scope and objectives**

The present UR M53 does not cater for some of the current designs of crankshaft and the Industry through CIMAC have proposed an alternative calculation procedure.

### **2. Engineering background for technical basis and rationale**

The analytical method in UR M53 is based on empirical formulae developed from strain gauge measurements of various crank geometries. Use of these formulae beyond any of the various validity ranges can lead to erroneous results in either direction, i.e. results that are more inaccurate than indicated by the mentioned standard deviations. Therefore the FEM-based method is highly recommended and this Technical Background is taken from the work undertaken by CIMAC.

The SCF's calculated according to the rules of this document are defined as the ratio of stresses calculated by FEM to nominal stresses in both journal and pin fillets. When used in connection with the present method in M53 von Mises stresses shall be calculated for bending and principal stresses for torsion or when alternative methods are considered.

### **3. Source/derivation of the proposed IACS Resolution**

See Proposal by CIMAC WG4 ST-08-044 dated 29.06.2009.

### **4. Summary of Changes intended for the revised Resolution:**

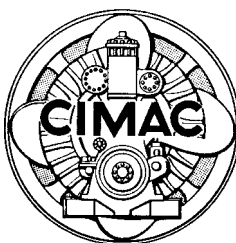
See Proposal by CIMAC WG4 ST-08-044 dated 29.06.2009.

### **5. Points of discussions or possible discussions**

Proposal by CIMAC WG4 ST-08-044 dated 29.06.2009 was subject to extensive discussion regarding the validity of the proposal. A major concern was the lack of far reaching validation offered. It was for this reason that the proposal has been accepted as an alternative only where the current prescriptive rules in UR M53 are out of bounds and not as a means to replace UR M53 in its entirety.

### **6. Attachments if any**

Proposal by CIMAC WG4 (IACS UR M53, Appendix III "Guidance for calculation of Stress Concentration Factors in the web fillet radii of crankshafts by utilizing Finite Element Method"



CO-ORDINATING WORKING GROUP

"CLASSIFICATION SOCIETIES – DIESEL"

(WG2)

**Proposal by CIMAC WG4**

ST-08-044

29.06.2009

## **IACS UR M53, Appendix III**

**“Guidance for calculation of**

# **Stress Concentration Factors**

**in the web fillet radii of crankshafts by utilizing  
Finite Element Method”**

# Index

1. General.....	3
2. Model requirements.....	3
2.1. Element mesh recommendations.....	3
2.2. Material .....	4
2.3. Element mesh quality criteria .....	4
2.3.1. Principal stresses criterion.....	5
2.3.2. Averaged/unaveraged stresses criterion .....	5
3. Load cases .....	5
3.1. Torsion .....	5
3.2. Pure bending (4 point bending) .....	7
3.3. Bending with shear force (3 point bending).....	8
3.3.1. Method 1.....	10
3.3.2. Method 2.....	10



## 1. General

The objective of the analysis is to substitute the analytically calculated Stress Concentration Factors (SCF) at the crankshaft fillets by suitable Finite Element Method (FEM) calculated figures. The analytical method is based on empirical formulae developed from strain gauge measurements of various crank geometries. Use of these formulae beyond any of the various validity ranges can lead to erroneous results in either direction, i.e. results that are more inaccurate than indicated by the mentioned standard deviations. Therefore the FEM-based method is highly recommended.

The SCF's calculated according to the rules of this document are defined as the ratio of stresses calculated by FEM to nominal stresses in both journal and pin fillets. When used in connection with the present method in M53 von Mises stresses shall be calculated for bending and principal stresses for torsion or when alternative methods are considered.

The procedure as well as evaluation guidelines are valid for both solid cranks and semibuilt cranks (except journal fillets).

The analysis is to be conducted as linear elastic FE analysis, and unit loads of appropriate magnitude are to be applied for all load cases.

The calculation of SCF at the oil bores is at present not covered by this document.

It is advised to check the element accuracy of the FE solver in use, e.g. by modelling a simple geometry and comparing the stresses obtained by FEM with the analytical solution for pure bending and torsion.

Boundary Element Method (BEM) may be used instead of FEM.

## 2. Model requirements

The basic recommendations and perceptions for building the FE-model are presented in 2.1. It is obligatory for the final FE-model to fulfil the requirement in 2.3.

### 2.1. Element mesh recommendations

In order to fulfil the mesh quality criteria it is advised to construct the FE model for the evaluation of Stress Concentration Factors according to the following recommendations:

- The model consists of one complete crank, from the main bearing centreline to the opposite side main bearing centreline.
- Element types used in the vicinity of the fillets:
  - 10 node tetrahedral elements
  - 8 node hexahedral elements
  - 20 node hexahedral elements
- Mesh properties in fillet radii. The following applies to  $\pm 90$  degrees in circumferential direction from the crank plane:

- Maximum element size  $a=r/4$  through the entire fillet as well as in the circumferential direction. When using 20 node hexahedral elements, the element size in the circumferential direction may be extended up to  $5a$ . In the case of multi-radii fillet  $r$  is the local fillet radius. (If 8 node hexahedral elements are used even smaller element size is required to meet the quality criteria.)
- Recommended manner for element size in fillet depth direction
  - First layer thickness equal to element size of  $a$
  - Second layer thickness equal to element size of  $2a$
  - Third layer thickness equal to element size of  $3a$
- Minimum 6 elements across web thickness.
- Generally the rest of the crank should be suitable for numeric stability of the solver.
- Counterweights only have to be modelled only when influencing the global stiffness of the crank significantly.
- Modelling of oil drillings is not necessary as long as the influence on global stiffness is negligible and the proximity to the fillet is more than  $2r$ , see figure 2.1.
- Drillings and holes for weight reduction have to be modelled.
- Submodeling may be used as far as the software requirements are fulfilled.

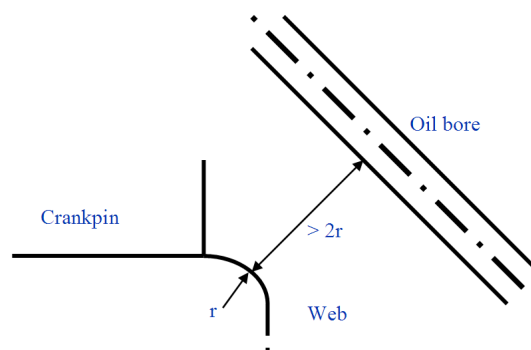


Figure 2.1. Oil bore proximity to fillet.

## 2.2. Material

UR M53 does not consider material properties such as Young's Modulus ( $E$ ) and Poisson's ratio ( $\nu$ ). In FE analysis those material parameters are required, as strain is primarily calculated and stress is derived from strain using the Young's Modulus and Poisson's ratio. Reliable values for material parameters have to be used, either as quoted in literature or as measured on representative material samples.

For steel the following is advised:  $E= 2.05 \cdot 10^5$  MPa and  $\nu=0.3$ .

## 2.3. Element mesh quality criteria

If the actual element mesh does not fulfil any of the following criteria at the examined area for SCF evaluation, then a second calculation with a refined mesh is to be performed.

### 2.3.1. Principal stresses criterion

The quality of the mesh should be assured by checking the stress component normal to the surface of the fillet radius. Ideally, this stress should be zero. With principal stresses  $\sigma_1$ ,  $\sigma_2$  and  $\sigma_3$  the following criterion is required:

$$\min(|\sigma_1|, |\sigma_2|, |\sigma_3|) < 0.03 \cdot \max(|\sigma_1|, |\sigma_2|, |\sigma_3|)$$

### 2.3.2. Averaged/unaveraged stresses criterion

The criterion is based on observing the discontinuity of stress results over elements at the fillet for the calculation of SCF:

- Unaveraged nodal stress results calculated from each element connected to a node<sub>i</sub> should differ less than by 5 % from the 100 % averaged nodal stress results at this node<sub>i</sub> at the examined location.

## 3. Load cases

To substitute the analytically determined SCF in UR M53 the following load cases have to be calculated.

### 3.1. Torsion

In analogy to the testing apparatus used for the investigations made by FVV the structure is loaded pure torsion. In the model surface warp at the end faces is suppressed.

Torque is applied to the central node located at the crankshaft axis. This node acts as the master node with 6 degrees of freedom and is connected rigidly to all nodes of the end face.

Boundary and load conditions are valid for both in-line and V-type engines.

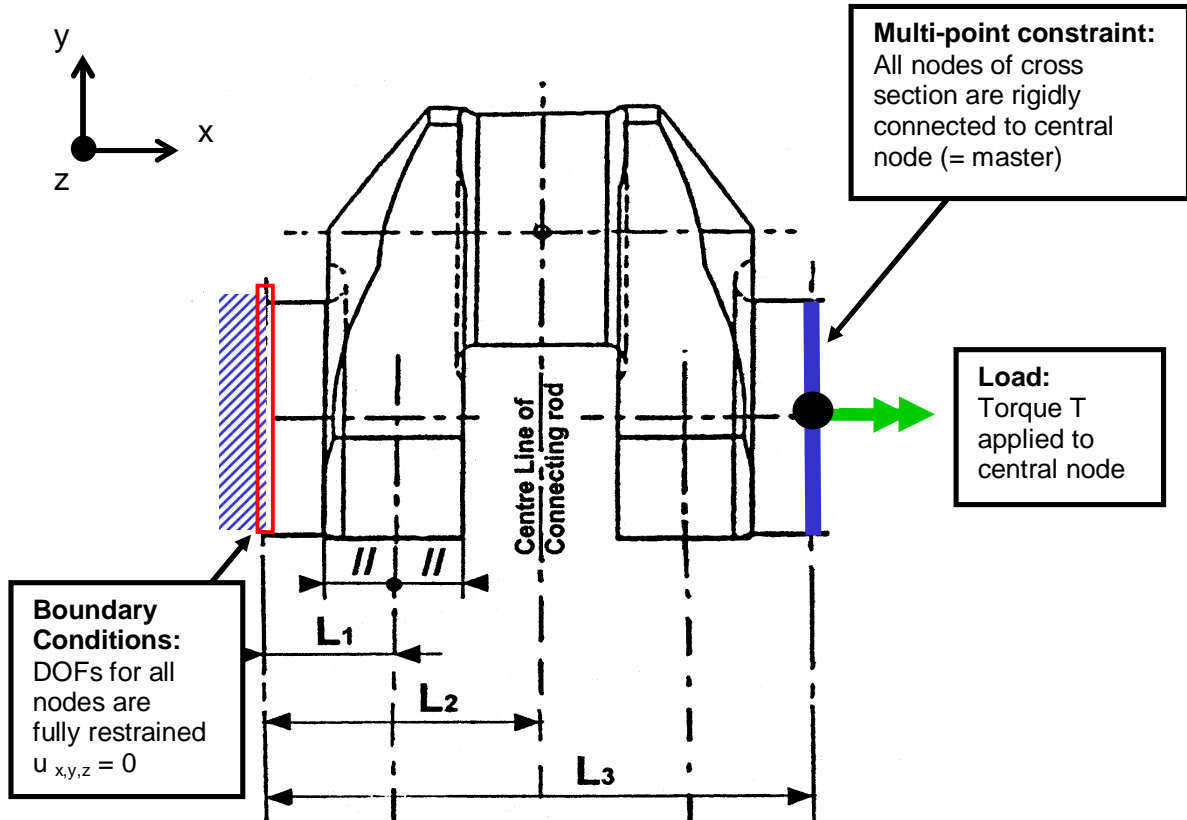


Figure 3.1 Boundary and load conditions for the torsion load case.

For all nodes in both the journal and crank pin fillet principal stresses are extracted and the equivalent torsional stress is calculated:

$$\tau_{equiv} = \max \left( \frac{|\sigma_1 - \sigma_2|}{2}, \frac{|\sigma_2 - \sigma_3|}{2}, \frac{|\sigma_1 - \sigma_3|}{2} \right)$$

The maximum value taken for the subsequent calculation of the SCF:

$$\alpha_T = \frac{\tau_{equiv,\alpha}}{\tau_N}$$

$$\beta_T = \frac{\tau_{equiv,\beta}}{\tau_N}$$

where  $\tau_N$  is nominal torsional stress referred to the crankpin and respectively journal as per UR M53 2.2.2 with the torsional torque  $T$ :

$$\tau_N = \frac{T}{W_p}$$

### 3.2. Pure bending (4 point bending)

In analogy to the testing apparatus used for the investigations made by FVV the structure is loaded in pure bending. In the model surface warp at the end faces is suppressed.

The bending moment is applied to the central node located at the crankshaft axis. This node acts as the master node with 6 degrees of freedom and is connected rigidly to all nodes of the end face.

Boundary and load conditions are valid for both in-line- and V- type engines.

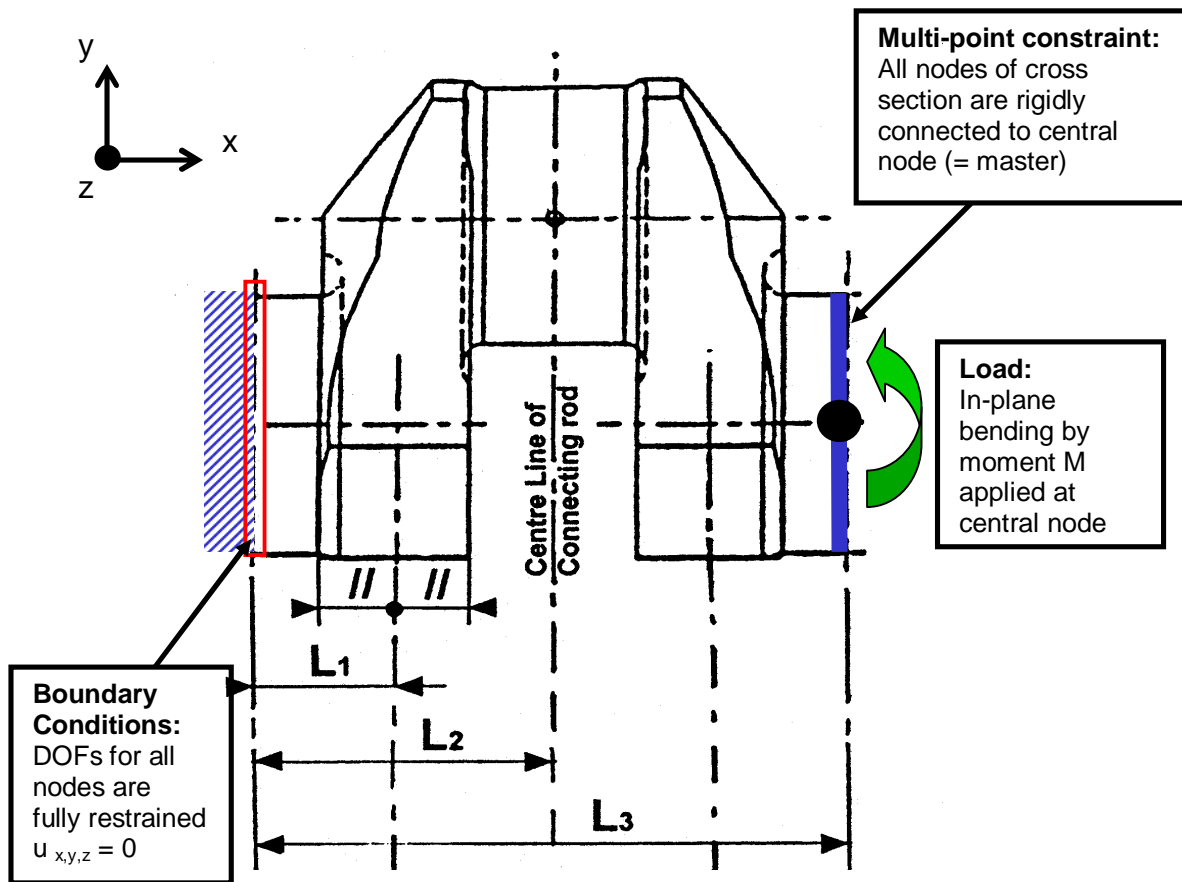


Figure 3.2 Boundary and load conditions for the pure bending load case.

For all nodes in both the journal and pin fillet von Mises equivalent stresses  $\sigma_{equiv}$  are extracted. The maximum value is used to calculate the SCF according to:

$$\alpha_B = \frac{\sigma_{equiv,\alpha}}{\sigma_N}$$

$$\beta_B = \frac{\sigma_{equiv,\beta}}{\sigma_N}$$

Nominal stress  $\sigma_N$  is calculated as per UR M53 2.1.2.1 with the bending moment  $M$ :

$$\sigma_N = \frac{M}{W_{eqw}}$$

### 3.3. Bending with shear force (3-point bending)

This load case is calculated to determine the SCF for pure transverse force (radial force,  $\beta_Q$ ) for the journal fillet.

In analogy to the testing apparatus used for the investigations made by FVV, the structure is loaded in 3-point bending. In the model, surface warp at the both end faces is suppressed. All nodes are connected rigidly to the centre node; boundary conditions are applied to the centre nodes. These nodes act as master nodes with 6 degrees of freedom.

The force is applied to the central node located at the pin centre-line of the connecting rod. This node is connected to all nodes of the pin cross sectional area. Warping of the sectional area is not suppressed.

Boundary and load conditions are valid for in-line and V-type engines. V-type engines can be modelled with one connecting rod force only. Using two connecting rod forces will make no significant change in the SCF.

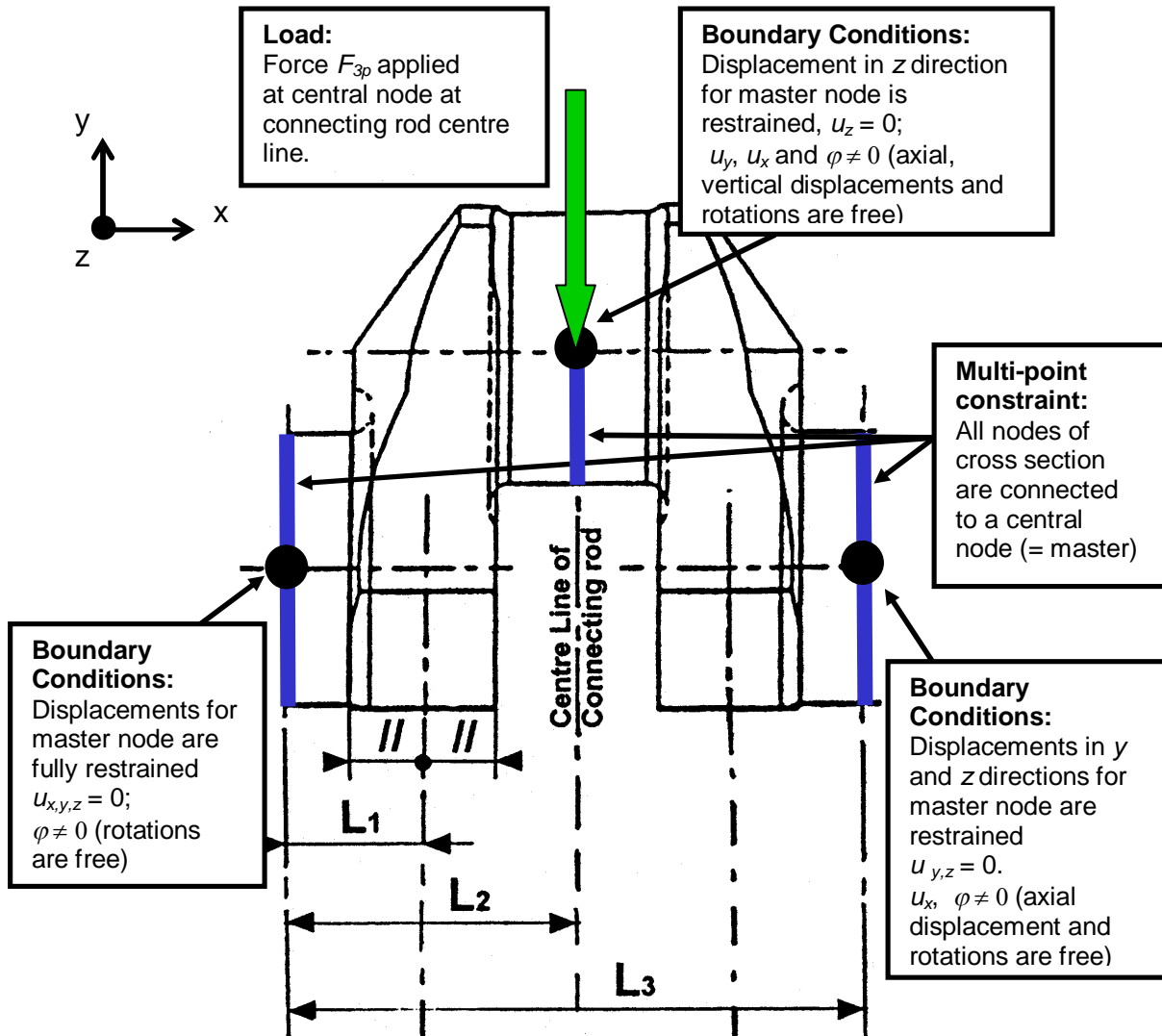


Figure 3.3. Boundary and load conditions for the 3-point bending load case of an in-line engine.

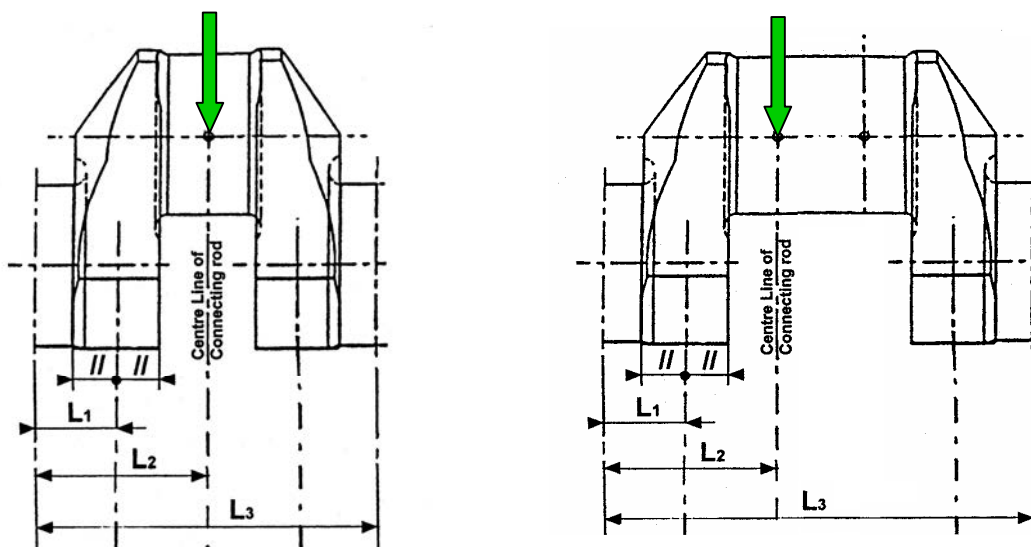


Figure 3.4 Load applications for in-line and V-type engines.

The maximum equivalent von Mises stress  $\sigma_{3P}$  in the journal fillet is evaluated. The SCF in the journal fillet can be determined in two ways as shown below.

### 3.3.1. Method 1

This method is analogue to the FVV investigation. The results from 3-point and 4-point bending are combined as follows:

$$\sigma_{3P} = \sigma_{N3P} \cdot \beta_B + \sigma_{Q3P} \cdot \beta_Q$$

where:

- $\sigma_{3P}$  as found by the FE calculation.
- $\sigma_{N3P}$  Nominal bending stress in the web centre due to the force  $F_{3P}$  [N] applied to the centre-line of the actual connecting rod, see figure 3.4.
- $\beta_B$  as determined in paragraph 3.2.
- $\sigma_{Q3P} = Q_{3P}/(B \cdot W)$  where  $Q_{3P}$  is the radial (shear) force in the web due to the force  $F_{3P}$  [N] applied to the centre-line of the actual connecting rod, see also figures 3 and 4 in M53.

### 3.3.2. Method 2

This method is **not** analogous to the FVV investigation. In a statically determined system with one crank throw supported by two bearings, the bending moment and radial (shear) force are proportional. Therefore the journal fillet SCF can be found directly by the 3-point bending FE calculation.

The SCF is then calculated according to

$$\beta_{BQ} = \frac{\sigma_{3P}}{\sigma_{N3P}}$$

For symbols see 3.3.1.

When using this method the radial force and stress determination in M53 becomes superfluous. The alternating bending stress in the journal fillet as per UR M53 2.1.3 is then evaluated:

$$\sigma_{BG} = \pm \left| \beta_{BQ} \cdot \sigma_{BFN} \right|$$

Note that the use of this method does not apply to the crankpin fillet and that this SCF must not be used in connection with calculation methods other than those assuming a statically determined system as in M53.



## Technical Background (TB) document for UR M53 (Rev.3 June 2017)

### 1. Scope and objectives

The objective of this task is to introduce additional requirements to UR M53 Rev.2 on the basis of the changes proposed by CIMAC, covering the following items:

- a. evaluation of stress concentration factors (SCF) by finite elements calculation,
- b. evaluation of stress in oil bore and fillets when surface treatment process is applied,
- c. evaluation of fatigue strength by experiment (fatigue tests).

### 2. Engineering background for technical basis and rationale

The engineering background has been provided by CIMAC and is summarized below:

#### a) Calculation of SCF factors

The objective of the analysis is to substitute the analytically calculated Stress Concentration Factor (SCF) at the oil bore outlet by suitable Finite Element Method (FEM) calculated figures. The analytical method is based on empirical formulae developed from strain gauge or photo-elasticity measurements of various round bars. Use of these formulae beyond any of the various validity ranges can lead to erroneous results in either direction, i.e. results that more inaccurate than indicated by the mentioned standard deviations.

The SCF calculated according to CIMAC method is defined as the ratio of stresses calculated by FEM to nominal stresses calculated analytically. When used in connection with the present method in M53 Rev.2, von Mises stresses are to be calculated for bending and principal stresses for torsion.

The analysis is to be conducted as linear elastic FE analysis. It is advised to check element accuracy of the FE solver in use, e.g. by modelling a simple geometry and comparing the stresses obtained by FEM with the analytical solution.

#### b) Calculation of surface treated fillets and oil bore outlets

The basic principle is that the alternating working stresses shall be below the local fatigue strength (including the effect of surface treatment) wherein non-propagating cracks may occur. This is then divided by certain safety factor. This applies through the entire fillet or oil bore contour as well as below the surface to a depth below the treatment-affected zone – i.e. to cover the depth all the way to the core.

Consideration of the local fatigue strength shall include the influence of the local hardness, residual stress and mean working stress. The influence of the 'giga-cycle effect', especially for initiation of subsurface cracks, should be covered by the choice of safety margin.

It is of vital importance that the extension of hardening/peening in an area with concentrated stresses be duly considered. Any transition where the hardening/peening is ended is likely to have considerable tensile residual stresses. This forms a 'weak spot' and is important if it coincides with an area of high stresses. Alternating and mean working stresses must be known for the entire area of the stress concentration as well as to a depth of about 1.2 times the depth of the treatment.

### c) Evaluation of fatigue tests

Fatigue testing can be divided into two main groups: testing of small specimens and full size crank throws.

For crankshafts without fillet surface treatment, the fatigue strength can be determined by testing small specimens taken from a full size crank throw. One advantage is the rather high number of specimens which can be then manufactured. Another advantage is that the tests can be made with different stress ratios (R-ratios) and / or different modes e.g. axial, bending and torsion, with or without a notch. This is required for evaluation of the material data to be used with critical plane criteria.

For crankshafts with surface treatment, the fatigue strength can only be determined through testing of full size crank throws. For cost reasons, this usually means a low number of crank throws. The load can be applied by hydraulic actuators in a 3- or 4-point bending arrangement, or by an exciter in a resonance test rig. The latter is frequently used, although it usually limits the stress ratio to  $R = 1$ .

Testing can be made using the staircase method or a modified version thereof, where the first specimen is subjected to a stress level that is most likely well below the average fatigue strength. When this specimen has survived  $10^7$  cycles, this same specimen is subjected to a stress level one increment above the previous. The increment should be selected to correspond to the expected level of the standard deviation. This is continued with the same specimen until failure. Then the number of cycles is recorded and the next specimen is subjected to a stress that is at least two increments below the level where the previous specimen failed.

### **3. Source / derivation of the proposed IACS Resolution**

CIMAC WG4 proposal "IACS UR M53, Appendix IV, Guidance for evaluation of Fatigue Tests", dated 16.10.2009.

CIMAC WG4 Proposal "IACS UR M53, Appendix V, Guidance for calculation of Surface Treated Fillets and Oil Bore Outlets", dated 03/12/2010.

CIMAC WG4 Proposal "IACS UR M53, Appendix VI, Guidance for calculation of Stress Concentration Factors in the oil bore outlets of crankshafts by utilizing Finite Element Method", dated 03.12.2010.

### **4. Summary of Changes intended for the revised Resolution**

The main changes to UR M53 Rev.2 consist in adding the following new Appendixes:

- Appendix IV: Guidance for evaluation of Fatigue Tests,
- Appendix V: Guidance for calculation of Surface Treated Fillets and Oil Bore Outlets,
- Appendix VI: Guidance for calculation of Stress Concentration Factors in the oil bore outlets of crankshafts by utilizing Finite Element Method.

## 5. Points of discussions or possible discussions

- A) The following comments have been made by the Machinery Panel to the documents submitted by CIMAC:

### Appendix IV : Guidance for evaluation of fatigue tests :

#### a) Paragraph 1

"For crankshafts without any fillet surface treatment, the fatigue strength can be determined by testing small specimens taken from a full size crank throw".

While there are the introduced advantages in Chapter 1 on testing small specimens taken from a full size crank throw, it is not considered that the fatigue strength can be determined only by testing small specimens taken from a full size crank throw unless the following are not shown by the technical documents.

- i) There is the difference of the stress gradient by the size effect in comparison between the test result by the small specimen taken from a full size crank throw and the test result by the full size crank throws as it is.
- ii) There is a problem whether the direction of the principle stress on the full size crank throw is the same as the one on small specimen taken from crank throw or not.
- iii) It should be mentioned that this does not apply to crankshafts without fillet surface treatment but with other parts treated which could induce residual stress in the neighbourhood of fillet.

#### b) Chapter 5

In case where the size or configuration etc. of the full size crank throw is different, there is the possibility that the fatigue strength vary by the above i) and ii) compared with the existing results for similar crankshaft.

Therefore, it is necessary that enough technical data are also submitted for the classification review so as to complement the above possibility.

#### c) Cleanliness steel

Regarding the high and super clean steel described in Chapter 3 and the cleanliness steel described in Chapter 5, to take in the evaluation of the fatigue strength of the cleanliness steel based on this Appendix IV may be premature due to the lack of discussion.

Therefore, it is necessary to have another argument from the beginning stage such as definition and manufacturing process etc. for this kind of steel.

### Appendix V : Surface treated Fillets and oil Bore outlets

One example on each case shall be submitted (at least induction hardening and shot peening), in order to evaluate what kind of documents can be produced by Manufacturers in order to fulfil these guidelines.

“acceptability factor” issue mentioned on § 3.3 : limit value of 1.15 is mentioned but in the last paragraph, door is opened to accept other (lower?) value and to call it a “safety factor”. Example illustrating this should be provided.

- B) CIMAC answers together with revised versions of Appendix IV and Appendix V were deemed satisfactory and UR M53 was updated accordingly by the Machinery Panel. It should be noted that Examples 2.1 and 2.2 in Appendix IV have not been included in the UR but in the present TB (see below).
- C) The updated version of UR M53 was submitted to CIMAC. Minor corrections were made by the Machinery Panel in accordance with the comments received from CIMAC.

## **6. Attachments**

Attachment 1: Evaluation of fatigue tests results - Calculation of sample mean and standard deviation – Example 2.1

Attachment 2: Evaluation of fatigue tests results - Confidence interval for mean fatigue limit – Example 2.2

**Attachment 1**  
**Evaluation of fatigue tests results**  
**Calculation of sample mean and standard deviation – Example 2.1**

Hypothetical test results may look as shown in Figure 2.1. The processing of the results and the evaluation of the sample mean and the standard deviation are shown in Figure 2.2.

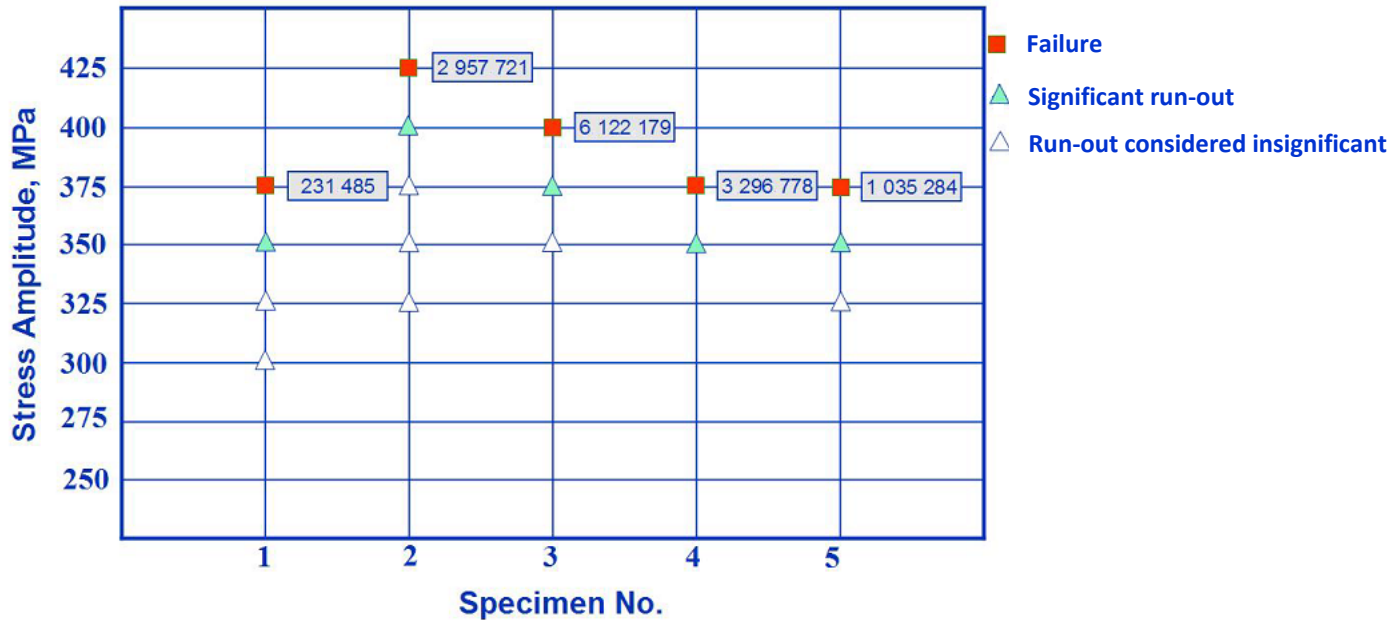
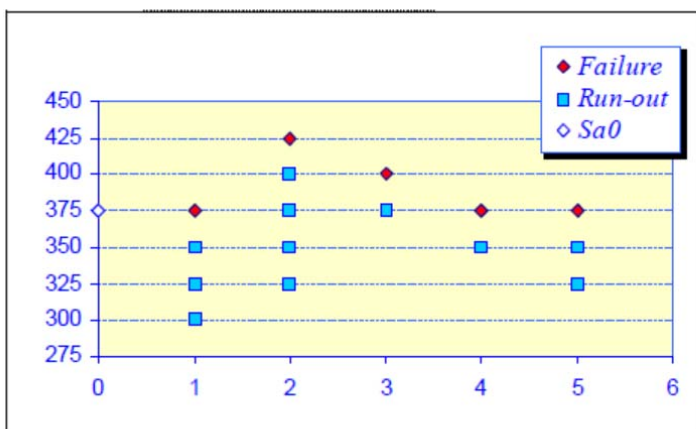


Figure 2.1. Log sheet of a modified staircase test.

Stress level 0,  $S_{a0} := 375 \cdot \text{MPa}$

Stress increment,  $d := 25 \cdot \text{MPa}$



i	f <sub>i</sub>	i*f <sub>i</sub>	i <sup>2</sup> *f <sub>i</sub>
2	1	2	4
1	1	1	1
0	3	0	0
Σ	5	3	5
	F	A	B

$$F = \sum f_i$$

$$A = \sum i \cdot f_i$$

$$B = \sum i^2 \cdot f_i$$

$i = 0, 1, 2, \dots$  is the stress level numbering, the numbering usually starts from zero  
 $f_i$  is number of test specimen at stress level,  $i$

Level 0 is the lowest value of the less frequent occurrence in the test results.

$$F := 5$$

$$A := 3$$

$$B := 5$$

### Sample mean

Sample mean,

$$\bar{S}_{\text{max}} := \begin{cases} S_{a0} + d \cdot \left( \frac{A}{F} - \frac{1}{2} \right) & \text{if } C = 1 \\ S_{a0} + d \cdot \left( \frac{A}{F} + \frac{1}{2} \right) & \text{if } C = 2 \end{cases} \quad S_a = 377.5 \text{ MPa}$$

### Standard deviation

Sample standard deviation,

$$\bar{s}_{\text{w}} := 1.62 \cdot d \cdot \left( \frac{B \cdot F - A^2}{F^2} + 0.029 \right) \quad s = 27.09 \text{ MPa}$$

Standard deviation ratio,

$$s_r := \frac{s}{S_a} \quad s_r = 0.072$$

Figure 2.2. Processing of the staircase test results.

**Attachment 2**  
**Evaluation of fatigue tests results**  
**Confidence interval for mean fatigue limit – Example 2.2**

Applying a 90 % confidence interval ( $\alpha = 0.1$ ) and  $n = 10$  (5 failures and 5 run-outs) leads to  $t_{\alpha, n-1} = 1.383$ , taken from a table for statistical evaluations (E. Dougherty: Probability and Statistics for the Engineering, Computing and Physical Sciences, 1990. Note that  $\nu = n - 1$  in the tables.). Hence:

$$S_{a90\%} = S_a - 1.383 \cdot \frac{s}{\sqrt{n}} = S_a - 0.4373 \cdot s$$

To be conservative, some authors would consider  $n$  to be 5, as the physical number of used specimen, then to  $t_{\alpha, n-1} = 1.583$ .

## Technical Background (TB) document for UR M53 (Rev.4, Aug 2019)

Example (2) in Page 2 was updated on 11 Sep 2019 – Ref: 19145\_IGc

### 1. Scope and objectives

The objective of this task is the modification of the formula for the calculation of the acceptability factor (Q) for crankpin oil bore in UR M53 (Rev.3, June 2017) Appendix IV, paragraph 4.3 for the reason that the use of the maximum principal equivalent stress formulation was evaluated to be more appropriate than the multi-axial Gough-Pollard formulation.

### 2. Engineering background for technical basis and rationale

- In the CIMAC opinion the use of the maximum principal equivalent stress formulation is more appropriate than the multi-axial Gough-Pollard formulation, because bending and torsional loads lead to an uni-axial stress state (see Appendix II); this would have the same logic as chapter 5 of M53 (i.e calculate the equivalent stress at the oil bore according to chapter 5.2 (maximum principal stress) and compare it to the tensile fatigue strength from torsional testing only,  $\sigma_{DWOT}$ ).

According to their opinion CIMAC proposed to modify the formula for the calculation of the acceptability factor for the crankpin oil bore as follow:

Related to crankpin oil bore:

$$Q = \left( \sqrt{\left( \frac{\sigma_{BO}}{\sigma_{DWOT}} \right)^2 + \left( \frac{\tau_{TO}}{\tau_{DWOT}} \right)^2} \right)^{-1} \quad \xleftarrow{\text{replace}} \quad Q = \frac{\sigma_{DWOT}}{\sigma_v}; \quad \sigma_v = \frac{1}{3} \sigma_{BO} \cdot \left[ 1 + 2 \sqrt{1 + \frac{9}{4} \left( \frac{\sigma_{TO}}{\sigma_{BO}} \right)^2} \right]$$

where:

$\sigma_{DWOT}$	fatigue strength by bending testing	$\xleftarrow{\text{replace}}$	$\sigma_{DWOT}$	fatigue strength by means of largest principal stress from torsion testing
$\tau_{DWOT}$	fatigue strength by torsion testing	$\xleftarrow{\text{delete}}$		

The details of the Technical Background offered by CIMAC, regarding their proposal, are enclosed in the Attachment 1 to Annex 4.

- On 01/10/2018, CIMAC was requested by IACS to provide significant examples in order to have a comparison between the results obtained from the current acceptability factor calculation and those obtained from the new proposed one and CIMAC provided the following three (3) examples:

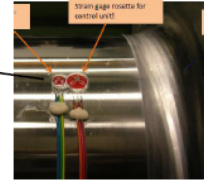




### Example (1)

strength

- Strain gauge measurements from torsional test leads to a nominal alternating torsional strength:  $\tau_n = 141MPa$
- There are no bending test results available, because crank never fails at oil bore during bending test.
- At the oil bore, there is a 1D uni-axial stress state (torsional load leads to tensile strength only, see M53, 2.2.3 and App. II)



$$\tau_{DWOT} = N/A$$

$$\sigma_{DWOT} = \gamma_t \cdot \tau_n = 3.7 \cdot 141MPa = 522MPa$$

stress

- Stress concentration factors from M53 lead to alternating bending stress  $\sigma_{BO}$  (2.1.4) and alternating torsional stress  $\sigma_{TO}$  (2.2.3):

$$\sigma_{BO} = 118MPa$$

$$\sigma_{TO} = 244MPa$$



### Example (2) – Gough - Pollard Formula

- Current formula:

$$Q = \left( \sqrt{\left( \frac{\sigma_{BO}}{\sigma_{DWOT}} \right)^2 + \left( \frac{\tau_{TO}}{\tau_{DWOT}} \right)^2} \right)^{-1} = \left( \sqrt{\left( \frac{\sigma_{BO}}{\sigma_{DWOT}} \right)^2} \right)^{-1} = 4.42$$



reduce multi-axial formula to 1D case ( $\tau_{TO} = 0$ )

- This acceptability factor is too large. And, not correct, because the Gough-Pollard formula can only be applied to multi-axial stress states.



## Example (3) – Maximum Principal Stress Formula

- New formula:

$$\sigma_v = \frac{1}{3} \sigma_{BO} \cdot \left[ 1 + 2 \sqrt{1 + \frac{9}{4} \left( \frac{\sigma_{TO}}{\sigma_{BO}} \right)^2} \right] = 296 \text{MPa}; \quad Q = \frac{\sigma_{DWOT}}{\sigma_v} = 1.76$$

- This formula uses the tensile strength result from torsional test only, no bending results are needed.

Regarding the examples provided by CIMAC some Machinery Panel Members commented that these examples are more representative of theoretical test cases and do not, therefore, demonstrate how the proposed revision to the calculation of the acceptability factor might affect specific in-service crankshafts.

- On 15/01/2019, CIMAC was requested by IACS to provide more examples related to specific in-service crankshaft designs, ideally demonstrating the effect across a range of sizes; in this regard CIMAC advised as follow:

*"None of the engine manufacturers present has crankshaft in the field, which have been submitted for approval according to M53 App. IV. Therefore, we are not able to satisfy your request.*

*We still are convinced that the proposed correction of the oil bore formula is indispensable and therefore ask you to change App. IV according to our proposal. The proposed revision is meant to correct our own mistake. DNVGL has already incorporated this proposal in the draft of their next revision of CG-0037"*

- In the light of the above, the unanimity of the Machinery Panel Members, after reconsideration of the proposal, agreed to revise the formula for the calculation of the acceptability factor (Q) for crankpin oil bore in UR M53 (Rev.3, June 2017) Appendix IV, paragraph 4.3 according to the CIMAC proposal, as it was observed that the formula is already used in UR M53 (M53.5.2 combined with the acceptability criteria of M53.7).

### 3. Source / derivation of the proposed IACS Resolution

CIMAC WG4 proposal "CIMAC\_WG4\_2018-0504\_AppIV\_OilBore.pdf", dated 07/05/2018.

### 4. Summary of Changes intended for the revised Resolution

- The text of UR M53 (Rev.3, June 2017) Appendix IV, paragraph 4.3 has been modified as follow:

“In order to combine tested bending and torsion fatigue strength results in calculation of crankshaft acceptability, see M53.7, the Gough-Pollard approach and the maximum principal equivalent stress formulation can be applied for the following cases:”

- The formula for the calculation of the acceptability factor (Q) for **crankpin oil bore** in UR M53 (Rev.3, June 2017) Appendix IV, paragraph 4.3 has been replaced by the following one:

$$Q = \frac{\sigma_{DWOT}}{\sigma_v}; \quad \sigma_v = \frac{1}{3} * \sigma_{BO} * \left[ 1 + 2 * \sqrt{1 + \frac{9}{4} * \left( \frac{\sigma_{TO}}{\sigma_{BO}} \right)^2} \right]$$

And the definition of  $\sigma_{DWOT}$  has been amended as follow:

$\sigma_{DWOT}$  fatigue strength by means of largest principal stress from torsion testing  
~~fatigue strength by bending testing~~

## 5. Points of discussions or possible discussions

The UR M53 (Rev.4) has been agreed by correspondence.

## 6. Attachments

Attachment 1: CIMAC WG 4, UR M53 App. IV, Comment on Oil Bore Analysis

## Attachment 1

## CIMAC WG 4, UR M53 App. IV, Comment on Oil Bore Analysis


**CIMAC**

THE INTERNATIONAL COUNCIL ON COMBUSTION ENGINES

## Introduction

- Fatigue strength and acceptability factor from
  - UR M53
  - DNVGL-CG-0037 (Class Guideline)
  - Full scale fatigue testing (App. IV)
- Proposal for acceptability factor calculation from fatigue test data at oil bore.


**CIMAC**

THE INTERNATIONAL COUNCIL ON COMBUSTION ENGINES

## Acceptability Factors (screenshot from UR M53)

### M 53.5 CALCULATION OF EQUIVALENT ALTERNATING STRESS

#### 5.1 General

In the fillets, bending and torsion lead to two different biaxial stress fields which can be represented by a Von Mises equivalent stress with the additional assumptions that bending and torsion stresses are time phased and the corresponding peak values occur at the same location (see Appendix I).

As a result the equivalent alternating stress is to be calculated for the crankpin fillet as well as for the journal fillet by using the Von Mises criterion.

At the oil hole outlet, bending and torsion lead to two different stress fields which can be represented by an equivalent principal stress equal to the maximum of principal stress resulting from combination of these two stress fields with the assumption that bending and torsion are time phased (see Appendix II).

The above two different ways of equivalent stress evaluation both lead to stresses which may be compared to the same fatigue strength value of crankshaft assessed according to Von Mises criterion.

- Von MISES is the wrong equivalent stress evaluation for oil bore outlets



## Acceptability Factors (UR M53)

- Equivalent stress:

- cpf, mjf (von MISES):  $\sigma_v = \pm \sqrt{(\sigma_{BH} + \sigma_{add})^2 + 3 \cdot \tau_H^2}$  ;  $\sigma_v = \pm \sqrt{(\sigma_{BG} + \sigma_{add})^2 + 3 \cdot \tau_G^2}$

- oil bore (max. principal):  $\sigma_v = \pm \frac{1}{3} \sigma_{BO} \cdot \left[ 1 + 2 \sqrt{1 + \frac{9}{4} \left( \frac{\sigma_{TO}}{\sigma_{BO}} \right)^2} \right]$

- Fatigue strength (von MISES):

$$\sigma_{DW} = \pm K \cdot (0.42 \cdot \sigma_B + 39.3) \cdot \left[ 0.264 + 1.073 \cdot D^{-0.2} + \frac{785 - \sigma_B}{4900} + \frac{196}{\sigma_B} \cdot \sqrt{\frac{1}{R_x}} \right]$$

- Acceptability factor:  $Q = \frac{\sigma_{DW}}{\sigma_v}$   $Q \geq 1.15$



## Acceptability Factors (DNVGL-CG-0037)

- Stress: bending and torsional stress from SCF

- Fatigue strength:

- cpf, mjf:  $\sigma_f = K_b \cdot f(\sigma_B; \sigma_{0.2}) \cdot f(R_a) \cdot f(\chi) \cdot f(\sigma_M)$

$$\tau_f = K_t \cdot \frac{1}{\sqrt{3}} \cdot f(\sigma_B; \sigma_{0.2}) \cdot f(R_a) \cdot f(\chi) \cdot f(\tau_M)$$

- oil bore:  $\sigma_{fh} = K_h \cdot f(\sigma_B; \sigma_{0.2}) \cdot f(R_a) \cdot f(\chi) \cdot f(\sigma_M)$

- Acceptability factor:  $S = 1,15$

- cpf, mjf (GOUGH-POLLARD):  $\left( \frac{\sigma_H}{\sigma_{fH}} \right)^2 + \left( \frac{\tau_H}{\tau_{fH}} \right)^2 \leq \frac{1}{S^2}$  ;  $\left( \frac{\sigma_G}{\sigma_{fG}} \right)^2 + \left( \frac{\tau_G}{\tau_{fG}} \right)^2 \leq \frac{1}{S^2}$

- oil bore (max. principal):  $\frac{1}{3} \cdot \sigma_{BO} \cdot \left[ 1 + 2 \sqrt{1 + \frac{9}{4} \left( \frac{\sigma_{TO}}{\sigma_{BO}} \right)^2} \right] \leq \frac{\sigma_{fO}}{S}$



## Full Scale Fatigue Testing

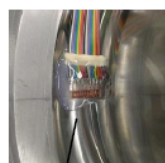
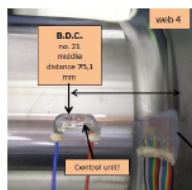
- Full scale (single crank) fatigue testing is done for bending and torsional load separately.
- Appendix IV defines a modified staircase method which leads to a bending **and** torsional fatigue strength.  
Strictly speaking, the fatigue test leads to “damage torque load” and strain gauge measured stress at different locations for the damage case. From these, fatigue strength at critical locations (cpf, mjf, oil bore) is calculated.
- The fatigue strength in the oil bore outlet  $\sigma_{DWOT}$  is calculated as the alternating **tensile** stress for the damage case under torsional load with SCF (see M53 chap. 2.2.3).
- The crank will fail at the weakest of the critical locations (assumed cpf below).



## Acceptability Factors (UR M53 App. IV)

- Strain gauge measured fatigue strength (from full scale pulse test):

bending test



– oil bore:

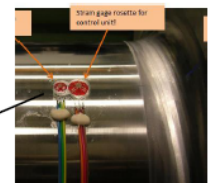
– crank pin fillet:

$$\sigma_{DWCT} = ***MPa$$

– main journal fillet:

$$\sigma_{DWJT} = ***MPa$$

torsional test



$$\tau_n = ***MPa$$

$$\sigma_{DWOT} = \gamma_T \cdot \tau_n$$

$$\tau_{DWCT} = \alpha_T \cdot \tau_n$$

$$\tau_{DWJT} = \beta_T \cdot \tau_n$$



## Acceptability Factors (UR M53 App. IV)

- Stress: bending and torsional stress from SCF
- Fatigue strength (from full scale pulse test):

	cpf	mjf	oil bore
bending test	$\sigma_{DWCT}$	n/a	X
torsional test	$\tau_{DWCT}$	n/a	$\sigma_{DWOT}$

= alternating tensile stress in outlet of journal oil bore due to torsion

- Acceptability factor (GOUGH-POLLARD):  $Q \geq 1.15$

– cpf: 
$$Q = \left( \sqrt{\left( \frac{\sigma_{BH}}{\sigma_{DWCT}} \right)^2 + \left( \frac{\tau_{BH}}{\tau_{DWCT}} \right)^2} \right)^{-1}$$

– mjf: 
$$Q = \left( \sqrt{\left( \frac{\sigma_{BG}}{\sigma_{DWJT}} \right)^2 + \left( \frac{\tau_G}{\tau_{DWJT}} \right)^2} \right)^{-1}$$

– oil bore: 
$$Q = \left( \sqrt{\left( \frac{\sigma_{BO}}{\sigma_{DWOT}} \right)^2 + \left( \frac{\tau_{TO}}{\tau_{DWOT}} \right)^2} \right)^{-1}$$

$\tau_{DWOT}$  not available from test ?



## Acceptability Factors: Inconsistencies

- Von MISES is the wrong equivalent stress formulation for oil bore outlets and in consequence is GOUGH-POLLARD the wrong multi-axial criterion for acceptability factor calculation.
- Formula to calculate acceptability factor for oil bore outlet in UR M53 App. IV chap. 4.3 uses:

$\sigma_{DWOT}$       fatigue strength by bending testing  
 $\tau_{DWOT}$       fatigue strength by torsion testing

where only “fatigue strength by torsional test” can be determined, and leads to tensile fatigue strength.





## Acceptability Factors

(Proposal: use max. principal stress for oil bore)

- Stress: bending and torsional stress from SCF
- Fatigue strength (from full scale pulse test):

	cpf	mjf	oil bore
bending test	$\sigma_{DWCT}$	n/a	X
torsional test	$\tau_{DWCT}$	n/a	$\sigma_{DWOT}$

= alternating tensile stress in outlet of journal oil bore due to torsion

- Acceptability factor:  $Q \geq 1.15$

– cpf (GOUGH-POLLARD):

$$Q = \left( \sqrt{\left( \frac{\sigma_{BH}}{\sigma_{DWCT}} \right)^2 + \left( \frac{\tau_{BH}}{\tau_{DWCT}} \right)^2} \right)^{-1}$$

– mjf (GOUGH-POLLARD):

$$Q = \left( \sqrt{\left( \frac{\sigma_{BG}}{\sigma_{DWJT}} \right)^2 + \left( \frac{\tau_G}{\tau_{DWJT}} \right)^2} \right)^{-1}$$

– oil bore (max. principal):

$$Q_{OT} = \frac{\sigma_{DWOT}}{\sigma_v}; \quad \sigma_v = \frac{1}{3} \sigma_{BO} \cdot \left[ 1 + 2 \sqrt{1 + \frac{9}{4} \left( \frac{\sigma_{TO}}{\sigma_{BO}} \right)^2} \right]$$



## Conclusion

- At the oil bore outlet the maximum principal equivalent stress formulation is more appropriate than the **multi**-axial GOUGH-POLLARD formulation, because bending and torsional loads lead to a **uni**-axial stress state (see App. II / B and App. VI / F). To use a different approach for oil bore compared to fillets is in alignment with DNVGL-CG-0037.





## Proposal for Change of UR M53 App. IV (page 48)

Related to crankpin oil bore:

$$Q = \left( \sqrt{\left( \frac{\sigma_{BO}}{\sigma_{DWOT}} \right)^2 + \left( \frac{\tau_{TO}}{\tau_{DWOT}} \right)^2} \right)^{-1} \quad \leftarrow \text{replace} \quad Q = \frac{\sigma_{DWOT}}{\sigma_v}; \quad \sigma_v = \frac{1}{3} \sigma_{BO} \cdot \left[ 1 + 2 \sqrt{1 + \frac{9}{4} \left( \frac{\sigma_{TO}}{\sigma_{BO}} \right)^2} \right]$$

where:

$\sigma_{DWOT}$  fatigue strength by bending testing  $\leftarrow$  replace  $\sigma_{DWOT}$  fatigue strength by means of largest principal stress from torsion testing  
 $\tau_{DWOT}$  fatigue strength by torsion testing  $\leftarrow$  delete

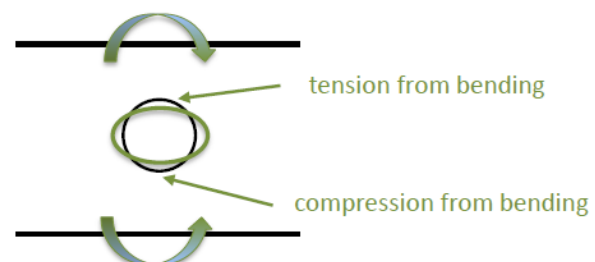
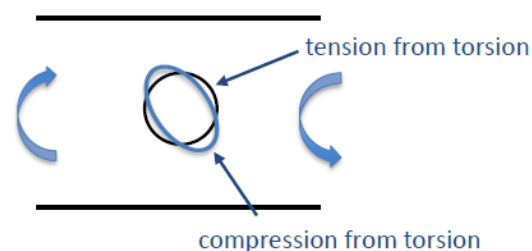


## Appendix – Uni-axial Stress State at Oil Bore



### Uni-axiality at Edge of Oil Bore

- Torsion of the crankpin leads to ovalization of the oil bore.
- This leads to tensile stress only
- Bending of the crankpin leads to ovalization of the oil bore.
- This leads to tensile stress only.
- In combination, there is only an uni-axial stress state. There is only tensile stress  $\sigma(\alpha)$  at the edge of the oil bore – no shear stress (see App. II).



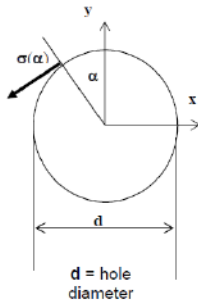


# Uni-axiality at Edge of Oil Bore (App. II)

**M53**  
(cont)

Stress Concentration Factors and stress distribution at the edge of oil drillings

Appendix II



Stress type	Nominal stress tensor	Uniaxial stress distribution around the edge	Mohr's circle diagram
Tension	$\begin{bmatrix} \sigma_n & 0 \\ 0 & 0 \end{bmatrix}$	$\sigma_\alpha = \sigma_n \gamma_B / 3 [1 + 2 \cos(2\alpha)]$	<p><math>\gamma_B = \sigma_{max} / \sigma_n</math> for <math>\alpha = k\pi</math></p>
Shear	$\begin{bmatrix} 0 & \tau_n \\ \tau_n & 0 \end{bmatrix}$	$\sigma_\alpha = \tau_n \sin(2\alpha)$	<p><math>\gamma_T = \sigma_{max} / \tau_n</math> for <math>\alpha = \frac{\pi}{4} + k \frac{\pi}{2}</math></p>
Tension + shear	$\begin{bmatrix} \sigma_n & \tau_n \\ \tau_n & 0 \end{bmatrix}$	$\sigma_\alpha = \frac{\gamma_B}{3} \sigma_n \left\{ 1 + 2 \left[ \cos(2\alpha) + \frac{3}{2} \frac{\gamma_T}{\gamma_B} \frac{\tau_n}{\sigma_n} \sin(2\alpha) \right] \right\}$	<p><math display="block">\sigma_{max} = \frac{\gamma_B}{3} \sigma_n \left[ 1 + 2 \sqrt{1 + \frac{9}{4} \left( \frac{\gamma_T}{\gamma_B} \frac{\tau_n}{\sigma_n} \right)^2} \right]</math> for <math>\alpha = \frac{1}{2} \text{tg}^{-1} \left( \frac{3 \gamma_T \tau_n}{2 \gamma_B \sigma_n} \right)</math></p>

## Technical Background (TB) document for UR M53 (Rev.5 May 2023)

### 1. Scope and objectives

The purpose is to revise UR M53 (Rev.4 Aug 2019), applicable to ships complying with the crankshafts whose application for design approval is dated on or after 1 January 2021.

### 2. Engineering background for technical basis and rationale

Revision 5 proposed by CIMAC with technical justification and effect to design of crankshafts.

### 3. Source/derivation of the proposed IACS Resolution

None.

### 4. Summary of Changes intended for the revised Resolution:

The Rev.5 of the UR M53 was developed for correction Q formula.

### 5. Points of discussions or possible discussions

5.1 CIMAC WG4 proposed a change to App.IV which indicating the maximum principal equivalent stress formulation is more appropriate than the multi-axial Gough-Pollard formulation. The proposal accepted by IACS machinery panel on Rev.4 of UR M53.

Later, three errors found in the formula which have been taken over from Rev.3

- The alternating torsional stress in crankpin fillet  $\tau_H$  is defined on page 14. while  $\tau_{BH}$  is not defined at all in M53. Therefore:  $\tau_{BH}$  agreed to be replaced by  $\tau_H$ .
- Chapter 4 (page 21) explains the use of the additional stress  $\sigma_{add}$  together with the alternating bending stresses in the fillets:  $\sigma_{BH}$  and  $\sigma_{BG}$ . Therefore, the additional bending stress  $\sigma_{add}$  agreed to be included.
- Introductory text for the equations for stress at the crankpin and journal needed to be updated to clarify that they are done at the fillet.

5.2 Machinery Panel asked CIMAC to provide specific on the effect of modification to the calculation formulae.

5.3 CIMAC clarified effect of modifications as follows;

Proposed modifications give more correct results for the acceptability factors because now "further bending stresses due to misalignment and bedplate deformation as well as due to axial and bending vibrations" are considered. With this, the formulas in App. IV are consistent to M53 chapter 5.

**M53**  
(cont)

#### M 53.4 ADDITIONAL BENDING STRESSES

In addition to the alternating bending stresses in fillets (see item M 53.2.1.3) further bending stresses due to misalignment and bedplate deformation as well as due to axial and bending vibrations are to be considered by applying  $\sigma_{add}$  as given by table:

Type of engine	$\sigma_{add}$ [N/mm <sup>2</sup> ]
Crosshead engines	$\pm 30$ (*)
Trunk piston engines	$\pm 10$

5.4 Machinery Panel evaluated the scope of modifications and agreed on Revision 5 of UR M53.

**6. Attachments if any**

None

## UR M56 “Marine gears – load capacity of involute parallel axis spur and helical gears”

### Summary

In Rev.4 Corr.2 of this Resolution, reference to an industry standard has been corrected.

### Part A. Revision History

Version no.	Approval date	Implementation date when applicable
Corr.2 (Mar 2023)	31 March 2023	-
Corr.1 (Oct 2021)	22 October 2021	-
Rev.4 (Feb 2021)	12 February 2021	1 July 2022
Rev.3 (Oct 2015)	8 October 2015	1 January 2017
Rev.2 (Oct 2013)	11 October 2013	1 January 2015
Corr.1 (1996)	1996	-
Rev.1 (1994)	1994	-
New (1990)	1990	-

#### • Corr.2 (Mar 2023)

##### 1 Origin of Change:

- Suggestion by IACS member

##### 2 Main Reason for Change:

Reference to an industry standard referred to from this UR needed correction as agreed by Machinery Panel.

##### 3 List of non-IACS Member classification societies contributing or participating in IACS Working Group:

None

##### 4 History of Decisions Made:

It was agreed that reference to an industry standard referred to from this UR should be corrected.

##### 5 Other Resolutions Changes:

None

**6 Any hinderance to MASS, including any other new technologies:**

None

**7 Dates:**

Original Proposal : 10 January 2023 (Ref: PM23100\_IMa)  
Panel Approval : 10 March 2023 (Ref: PM23100\_IMb)  
GPG Approval : 31 March 2023 (Ref: 20206dIGj)

• **Corr.1 (Oct 2021)**

**1 Origin of Change:**

Suggestion by IACS member

**2 Main Reason for Change:**

Reference to an industry standard referred to from this UR needed correction as agreed by Machinery Panel.

**3 List of non-IACS Member classification societies contributing or participating in IACS Working Group:**

None

**4 History of Decisions Made:**

It was agreed that reference to an industry standard referred to from this UR should be corrected.

**5 Other Resolutions Changes:**

None

**6 Any hinderance to MASS, including any other new technologies:**

None

**7 Dates:**

Original Proposal : 15 June 2021 (Ref: PM20906IIMa)  
Panel Approval : 06 October 2021 (Ref: PM20906IIMc)  
GPG Approval : 22 October 2021 (Ref: 20206dIGd)

• **Rev.4 (Feb 2021)**

**1 Origin of Change:**

Other (Update to comply with the required format when industry standards are referred to)

## 2 Main Reason for Change:

There was a need to update this UR to comply with the following format when industry standards are referred to:

*[Standard Designation], [version/revision, if applicable], [year of publication]*  
(examples: API Spec 2F, 6th Edition, 1997; ISO 4624, 2002), where  
*[version/revision, if applicable] and/or [year of publication] are decided by IACS and are not necessarily to be the current/latest version.*

## 3 List of non-IACS Member classification societies contributing or participating in IACS Working Group:

None

## 4 History of Decisions Made:

None

## 5 Other Resolutions Changes:

None

## 6 Any hinderance to MASS, including any other new technologies:

None

## 7 Dates:

Original Proposal:	28 October 2019	(Ref: PM18939_IMd)
Panel Approval:	9 November 2020	(Ref: PM20906_IMf)
GPG Approval:	12 February 2021	(Ref: 20206dIGb)

## • Rev.3 (Oct 2015)

### 1 Origin of Change:

- Suggestion by IACS Member

### 2 Main Reason for Change:

Clarification on field application of UR M56.

### 3 List of non-IACS Member classification societies contributing through the TC Forum and/or participating in IACS Working Group:

None

#### **4 History of Decisions Made:**

Suggestion from a Machinery Panel Member was discussed by correspondence within Machinery Panel and during the 20th meeting.

#### **5 Other Resolutions Changes:**

None

#### **6 Dates:**

Original Proposal: 19 March 2014	made by a Member
Panel Approval: 8-11September 2015	(22nd Panel Meeting)
GPG Approval: 8 October 2015	(Ref. 15154_IGb)

#### **• Rev.2 (Oct 2013)**

##### **1 Origin of Change:**

- Suggestion by IACS Member

##### **2 Main Reason for Change:**

The previous revision 1 was based on the 1996 edition of International Standards ISO 6336. These standards were revised during 2006 through 2008 introducing very important changes, compared with their previous edition, that have a significant influence to the calculation outcome. Consequently, the UR M56 had to be brought inline with the currently valid edition of ISO 6336 standards.

##### **3 List of non-IACS Member classification societies contributing through the TC Forum and/or participating in IACS Working Group:**

None.

#### **4 History of Decisions Made:**

GPG approved the task PM 11918 on 2012-03-11 (12031\_IGb)

Machinery panel agreed the revision 2 on 2013-09-06.

GPG adopted the revision 2 on 2013-10-11.

#### **5 Other Resolutions Changes:**

None

#### **6 Dates:**

Original Proposal: 24 October 2012	made by a Member
Panel Approval: 06 September 2013	(By Machinery Panel)
GPG Approval: 11 October 2013	(Ref. 12031_IGf)



- **Corr.1 (1996)**

No history file or TB document available.

- **Rev.1 (1994)**

No history file or TB document available.

- **New (1990)**

No history file or TB document available.

## **Part B. Technical Background**

List of Technical Background (TB) documents for UR M56:

Annex 1. **TB for Rev.2 (Oct 2013)**

See separate TB document in Annex 1.

Annex 2. **TB for Rev.3 (Oct 2015)**

See separate TB document in Annex 2.

Annex 3. **TB for Rev.4 (Feb 2021)**

See separate TB document in Annex 3.

Annex 4. **TB for Corr.1 (Oct 2021)**

See separate TB document in Annex 4.

Annex 5. **TB for Corr.2 (Mar 2023)**

See separate TB document in Annex 5.

**Note:**

*There are no separate Technical Background (TB) documents for the New (1990), Rev.1 (1994) and Corr.1 (1996).*

## Technical Background Document for UR M56 (Rev. 2 Oct 2013)

### 1 Scope and objectives

Revision 2 reflects changes in the calculation of surface durability (pitting) and tooth root bending strength of gears introduced by the international standards series ISO 6336 by their editions in 2006 through 2008.

Since the time the revision 1 of UR M56 was adopted, these standards have undergone their important updates. These updates can in certain cases have a significant influence to the decision whether a gear pair is acceptable or not.

### 2 Engineering background for technical basis and rationale

Changed procedure for calculations of some factors in the new edition of standards.

### 3 Source/derivation of the proposed IACS Resolution

International standards

- ISO 6336-1:2006 & Corr. 1:2008, Calculation of load capacity of spur and helical gears - Part 1: Basic principles, introduction and general influence factors;
- ISO 6336-2:2006 & Corr. 1:2008, Calculation of load capacity of spur and helical gears - Part 2: Calculation of surface durability (pitting);
- ISO 6336-3:2006 & Corr. 1:2008, Calculation of load capacity of spur and helical gears - Part 3: Calculation of tooth bending strength;
- ISO 6336-5:2003, Calculation of load capacity of spur and helical gears - Part 5: Strength and quality of materials

### 4 Summary of Changes intended for the revised Resolution

Revision 2 of the UR M56 introduces a few additional formulae for the calculation of gear pair geometrical values.

Revision 2 changes procedure for calculation of factors  $K_v$  (partially),  $Z_w$  and  $Y_{\delta relT}$ .

Revision 2 corrects formulae for calculation of factors  $Z_{B\beta}$ ,  $Z_{D\beta}$ ,  $Z_{\beta}$  and  $Y_{RrelT}$ . Different formula for  $Z_{\beta}$  in the new edition of standards and its background actually initiated work on revision 2.

Revision 2 keeps only reference to the standards in the procedure for calculation of factors  $K_v$  (partially),  $K_{H\beta}$ ,  $K_{H\alpha}$ ,  $K_{F\alpha}$ ,  $Y_F$ ,  $Y_S$  as in the previous revision, rather than reproducing the text from the standards. This keeps the UR text compact, though not completely stand-alone. The same was done in the revision 1.

Revision 2 introduces new factors  $Y_B$  and  $Y_{DT}$  based on the new edition of standards.

### 5 Points of discussions or possible discussions

Load sharing factor  $K_v$  and design factor  $Y_d$  do not exist and are not referenced to either in the present editions of the standards, or in the previous one. However, they are kept in the revised UR, having a real significance in the calculation of marine gears.

### 6 Attachments if any

None.

## **Technical Background Document for UR M56 (Rev.3 Oct 2015)**

### **1 Scope and objectives**

Clarification on field application of UR M56.

### **2 Engineering background for technical basis and rationale**

The task was triggered by the proposal of a Member Society of establishing threshold values for application of IACS UR M56, since small size equipment are mass produced according to standardized design criteria widely experienced in service and built by specialized manufacturers.

Additionally, for gears intended to auxiliary services, it appear unfeasible to apply the UR to any kind of equipment without a minimum size threshold, because this would make very small equipment (e.g. windshield wipers, watertight doors closing gears) subject to approval, thus causing an excessive burden.

### **3 Source/derivation of the proposed IACS Resolution**

None.

### **4 Summary of Changes intended for the revised Resolution**

Rev.3 has modified section 1.2 "Scope and field of application" introducing threshold values respectively for gears intended for main propulsion and for essential auxiliary services.

### **5 Points of discussions or possible discussions**

Several options were considered pertaining to setting specific threshold values for gears intended for main propulsion and for essential auxiliary services-i.e. one option was "220 kW for main propulsion and 110kW for auxiliary services"; and the other was "110 kW for both main propulsion and auxiliary services". Although some members preferred introducing "110 kW for both main propulsion and auxiliary services", in the continued discussion, Machinery Panel concurred that setting "220 kW for main propulsion and 110kW for auxiliary services" would be more appropriate considering the fact that member societies may freely impose stricter limitation than "220 kW for main propulsion and 110kW for auxiliary services".

### **6 Attachments if any**

None.

## Technical Background Document for UR M56 (Rev.4 Feb 2021)

### 1. Scope and objectives

UR M56(Rev.3) does not reflect the agreed format for referencing the ISO standards. Rev.4 has been developed to comply with the agreed format.

### 2. Engineering background for technical basis and rationale

#### Format for references to Industry standards

**Format:**

*[Standard Designation], [version/revision, if applicable], [year of publication] (examples: API Spec 2F, 6th Edition, 1997; ISO 4624, 2002), where [version/revision, if applicable] and/or [year of publication] are decided by IACS and are not necessarily to be the current/latest version.*

### 3. Source/derivation of the proposed IACS Resolution

None

### 4. Summary of Changes intended for the revised Resolution

UR M56 has been updated to specify the revision/version of the ISO standards as follows:

ISO standards	Replaced by
ISO 6336-1	ISO 6336-1:2019
ISO 6336-2	ISO 6336-2:2019
ISO 6336-3	ISO 6336-3:2019
ISO 6336-5	ISO 6336-5:2016
ISO 1328	ISO 1328-2:1997

### 5. Points of discussions or possible discussions

None

### 6. Attachments if any

None

**Technical Background (TB) Document for UR M56 (Corr.1 Oct 2021)****1. Scope and objectives**

Reference to an industry standard referred to from this UR needed correction as agreed by Machinery Panel.

**2. Engineering background for technical basis and rationale**

None

**3. Source/derivation of the proposed IACS Resolution**

None

**4. Summary of Changes intended for the revised Resolution**

Correction of reference to an industry standard is as follows:

<b>ISO standard</b>	<b>Replaced by</b>
ISO 1328-2:1997	ISO 1328-2:2020

**5. Points of discussions or possible discussions**

None

**6. Attachments if any**

None

**Technical Background (TB) Document for UR M56 (Corr.2 Mar 2023)****1. Scope and objectives**

Reference to an industry standard referred to from this UR needed correction as agreed by Machinery Panel.

**2. Engineering background for technical basis and rationale**

None

**3. Source/derivation of the proposed IACS Resolution**

None

**4. Summary of Changes intended for the revised Resolution**

Correction of reference to an industry standard is as follows:

<b>ISO standard</b>	<b>Replaced by</b>
ISO 1328 2:2020	ISO 1328-1:2013

**5. Points of discussions or possible discussions**

None

**6. Attachments if any**

None

# UR M60 “Control and Safety of Gas Turbines for Marine Propulsion Use”

## Summary

In Rev.1 of this UR, requirements have been updated, taking into account gas turbine manufacturers’ requests.

## Part A. Revision History

Version no.	Approval date	Implementation date when applicable
Rev.1 (Nov 2021)	24 November 2021	1 January 2023
New (1997)	1997	-

### • Rev.1 (Nov 2021)

#### 1 Origin of Change:

- Suggestion by IACS member

#### 2 Main Reason for Change:

The item was triggered by a suggestion from a Machinery Panel Member. The following requests regarding gas turbines were received from manufacturers:

- (1) IACS UR M60.2.2b) should be limited to forced lubrication systems, and,
- (2) Whether each safety device of a gas turbine should be examined based upon FMEA in reference to UR M78 and UR M44.

Regarding the above requests, Machinery Panel considered the revision of IACS UR M60.

#### 3 List of non-IACS Member classification societies contributing or participating in IACS Working Group:

None

#### 4 History of Decisions Made:

Form A was approved on 13 July 2021 by Machinery Panel.

#### 5 Other Resolutions Changes:

None



**6 Any hinderance to MASS, including any other new technologies:**

None

**7 Dates:**

Original Proposal	: 25 June 2020	(Ref: PM20002bIMb)
Panel Approval	: 13 July 2021	(Ref: PM20002bIMh)
GPG Approval	: 24 November 2021	(Ref: 21163_IGb)

**• New (1997)**

No records are available

\*\*\*\*\*

## **Part B. Technical Background**

List of Technical Background (TB) documents for UR M60:

Annex 1. **TB for Rev.1 (Nov 2021)**

See separate TB document in Annex 1.



**Note:** *There is no Technical Background (TB) document available for the New (1997).*

## **Technical Background (TB) document for UR M60 (Rev.1 Nov 2021)**

### **1. Scope and objectives**

To review existing UR M60 and update it as requested from manufacturers.

### **2. Engineering background for technical basis and rationale**

The Panel has discussed whether each safety device of gas turbines should be based upon FMEA, because the monitoring and safety systems for DF or GF engines have been based upon FMEA in the fifth paragraph of 2.2.7 of UR M78.

As a result, it was concluded that the safety devices of gas turbine should also be based upon FMEA.

There was a request that the safety device in response to unacceptable lubricating oil pressure drop in UR M60.2.2b) should be limited to the case of the forced lubrication systems. However, it was concluded that all safety devices should be covered by FMEA.

### **3. Source/derivation of the proposed IACS Resolution**

None.

### **4. Summary of Changes intended for the revised Resolution:**

1) The following additional text has been added in paragraph 2.1:

*"Unless the FMEA required by this UR proves otherwise, the alarm and shutdown functions for gas turbines are to be provided in accordance with Table 1 of this UR in addition to the general monitoring and safety system functions given by the Classification Societies."*

2) The note regarding implementation date has been added.

3) The requirement in paragraph 3.1 has been amended to make it clear that alarm devices can be added or omitted depending on the result of FMEA.

4) The requirement in paragraph 3.2 has been moved to footnotes in Table 1.

5) The marks in Table 1 have been changed in the same way as UR M35 and M36 (e.g. high, low, x).

### **5. Points of discussions or possible discussions**

There was a concern that an additional paragraph in M60.2.1 would lead to misunderstanding that performing FMEA could be omitted. After discussion, Rev.1 of UR has been unanimously agreed by Machinery Panel Members based upon the Panel consensus that performing FMEA is mandatory and that this amendment is not intended to omit FMEA.

### **6. Attachments if any**

None.

## UR M61 "Starting Arrangements of Internal Combustion Engines"

### Summary

The requirements for engine starting in this UR M61 have been updated to include a cross reference to the newly developed UR M84 - Capacity and availability of compressed air for essential services to ensure that the new requirements in UR M84 relating to compressed air for essential services are also fully considered together with the requirements for engine starting.

### Part A. Revision History

Version no.	Approval date	Implementation date when applicable
Rev.3 (Feb 2024)	20 February 2024	01 July 2025
Rev.2 (Aug 2023)	04 August 2023	01 January 2025
Rev.1 (Feb 2022)	04 February 2022	01 January 2023
New (Dec 2003)	Dec 2003	-

#### • Rev.3 (Feb 2024)

##### 1 Origin of Change:

- Suggestion by IACS member

##### 2 Main Reason for Change:

As part of the development of UR M84 - *Capacity and availability of compressed air for essential services* carried out under task PM23200 which addresses the capacity and availability of compressed air for essential services and which cross references UR M61 - *Starting Arrangements of Internal Combustion Engines*, it was considered appropriate to make a corresponding reciprocal update to UR M61 since both UR's are concerned with compressed air for essential services.

##### 3 List of non-IACS Member classification societies contributing or participating in IACS Working Group:

None

##### 4 History of Decisions Made:

UR M61 Rev.3 agreed by correspondence.

##### 5 Other Resolutions Changes:

None

**6 Any hinderance to MASS, including any other new technologies:**

None

**7 Dates:**

Original Proposal	:	31 August 2023	(Ref. PM23200 IMd)
Panel Approval	:	26 January 2024	(Ref. PM23200_IMk)
GPG Approval	:	20 February 2024	(Ref.20206eIGg)

• **Rev.2 (August 2023)**

**1 Origin of Change:**

Suggestion by IACS member

**2 Main Reason for Change:**

Review of UR M61 providing requirements for the split ratio of the total capacity of the starting air compressors.

**3 List of non-IACS Member classification societies contributing or participating in IACS Working Group:**

None

**4 History of Decisions Made:**

UR M61 Rev.2 agreed by the correspondence.

**5 Other Resolutions Changes:**

None

**6 Any hinderance to MASS, including any other new technologies:**

None

**7 Dates:**

Original Proposal	:	14 October 2022	(Ref. PM20906xIMa)
Panel Approval	:	20 July 2023	(Ref. PM20906xIMd)
GPG Approval	:	04 August 2023	(Ref.20206eIGd)

• **Rev.1 (Feb 2022)**

**1 Origin of Change:**

Suggestion by IACS member

## **2 Main Reason for Change:**

Review of UR M61 providing requirements for starting arrangements of internal combustion engines for engines ready to start in cold condition and warm running condition, which does not offer clarifications for engines in such conditions.

## **3 List of non-IACS Member classification societies contributing or participating in IACS Working Group:**

None

## **4 History of Decisions Made:**

UR M61 Rev.1 agreed by the correspondence.

## **5 Other Resolutions Changes:**

None

## **6 Any hinderance to MASS, including any other new technologies:**

None

## **7 Dates:**

Original Proposal	: 08 April 2021	(Ref. PM20906iIMa)
Panel Approval	: 12 November 2021	(Ref. PM20906iIMe)
GPG Approval	: 04 February 2022	(Ref. 20206eIGb)

### **• New (Dec 2003)**

Refer to Annex I of part B.

\*\*\*\*\*

## **Part B. Technical Background**

List of Technical Background (TB) documents:

Annex 1.     **TB for New (Dec 2003)**

See separate TB document in Annex 1.

Annex 2.     **TB for Rev.1 (Feb 2022)**

See separate TB document in Annex 2.

Annex 3.     **TB for Rev.2 (Aug 2023)**

See separate TB document in Annex 3.

Annex 4.     **TB for Rev.3 (Feb 2024)**

See separate TB document in Annex 4.

## **Technical Background –**

**(New) UR M61 ‘Starting arrangements of internal combustion engines’**

**deletion of**

**UR M49 ‘Availability of machinery’ and**

**UR E8 ‘Starting arrangements of internal combustion engines’**

### **1. General**

There had been a long discussion in 1998-1999 with respect to the definitions of “deadship” and “blackout”. The main reason was that the SOLAS definitions of blackout and deadship condition were quite different from those given in UR M49 (Rev.1, 1996).

### **2. UR M 49**

At present, Rev.1 of M49 (1996) is effective.

In 1998, WP/MCH suggested that a footnote be added to UR M49.1 in order to make reference to SOLAS II-1/42.3.4 and 43.3.4. GPG 44 (1998) also considered that the existing UR M49.1 was to be isolated from M49.2, the latter together with UR E8 being relocated as new UR M61.

At the same time, GPG 44 decided that approval of Rev.2 of UR M49 be put in abeyance until the development of UI SC 124 was finalized.

UR M49 (Rev.2) and M61(New), so prepared by the Permanent Secretariat, were passed to WP/MCH for review. In particular, WP/MCH was to clarify the scope of application of **M49** and **M61** to non-SOLAS ships (part of WP/MCH Task 41).

WP/MCH reported to GPG 52 (March 2002) that M49 should apply to all ships subject to further debate. WP/MCH consequently suggested in March 2003 (GPG 54) that an application note should be added to UR M49 to the extent that M 49 applies to non-SOLAS vessels. The draft footnote read: *These requirements (M49) apply only to ships required to comply with SOLAS [and ships above 200 GRT]*. WP/MCH Chairman later confirmed in consultation with experts that the square bracket be removed. However, Council did not approve it (June 2003).

### **3. UI SC 124**

GPG 44 (1998) found that the draft text of SC 124 did not clarify the definition of “deadship” and “blackout”. UI SC 124 was then withdrawn and WP/MCH was tasked to develop an interpretation of the two terms with a view to elaborating a definition to be used in UR M49 and SC 124 and if necessary other resolutions. However, WP/MCH failed to reach a common understanding of the term “deadship condition” in 1998.

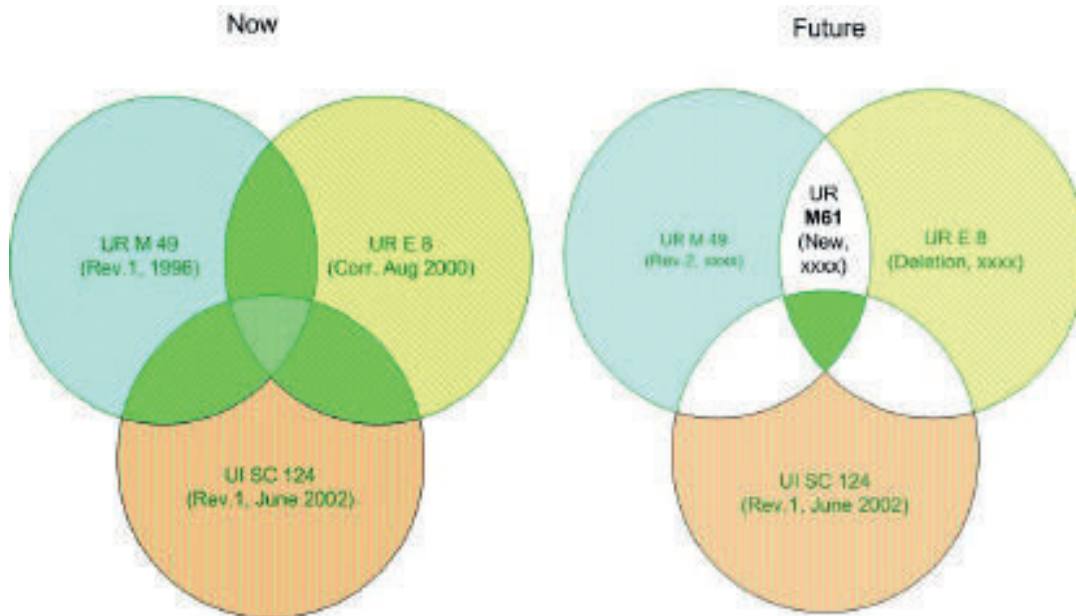
Hence, GPG 46 (1999) attempted to develop a generally agreeable definition.

*With assistance from the WP/MCH, CPC/Council finally approved UI SC 124 in*



May 1999. It was submitted to IMO DE (DE 43/Inf.5). Revised in June 2002 and submitted to IMO MSC 76.

### Status at this point



#### 4. Tasking of WP/MCH

In August 2003 GPG tasked WP/MCH to consider

M49:

- a. whether the text of UR M49.1(draft Rev.2, xxxx) should be amended in light of UI SC 124(Rev.1, June 2002) ;
- b. whether the wording [and ships above 200GRT] should be deleted from the note to UR M49(draft Rev.2, xxxx) or retained;

M61:

- c. whether the text of new draft UR M61 is appropriate, taking into account 7225\_NVc of 26 May 98 from the then GPG Chairman.

#### 5 WP/MCH submission

The WP concluded that text of UR M 61 is not adequate and changes suggested previously by GPG need to be introduced. However with the introduction of these changes M61.3 would become a word by word copy of SOLAS regulation II-1/44. Therefore WP did not see any need for this requirement as a class one and proposed to GPG to delete M61.3.

IMO has adopted MSC/Circ.736 (which is recommendatory) that interpreted SOLAS regulation II-1/44.1. There was a need to draft a UI that would simply reference the relevant paragraphs of this circular with respect to the regulation in question. This arrangement will create uniform application on behalf of the Flags in cases where a particular Flag is silent on circular application.

With the publication of the revised SC124 the need for UR M49 as it stands were now be brought into question. The origins of the UR M49 stem from SOLAS II-1/26.4 with the need to define what "dead ship" conditions entailed. In view of the latest SC124 it would now seem sensible to make a new UIs for SOLAS II-1/26.4 and HSC 9.1.5 and delete M49. In doing this it would make it clear that the requirements are only applicable to SOLAS/HSC vessels and obviate the discussions regarding the notes to M49. The definition of "dead ship" in the new UIs would be consistent with SC124.

With the above in mind WP/MCH:

- i) proposed to delete M61.3,
- ii) suggested to draft a UI that would reference relevant paragraphs of SOLAS Reg. II-1/44.1 and MSC/Circ.736,
- iii) sought approval for the deletion of UR M49 and drafting of UI for SOLAS II-1/26.4 and HSC 9.1.5.

GPG concurred and approved the subsequent drafts and deletion of UR M49 and UR E8 (as per 3097cIGf of 12 November 2003; tacit 19 November) .

\*\*\*\*\*

Permanent Secretariat 21 November 2003.

## **Technical Background (TB) document for UR M61 (Rev.1 Feb 2022)**

### **1. Scope and objectives**

Review of the required number of starts for internal combustion engines.

### **2. Engineering background for technical basis and rationale**

Engine starting test is generally performed during Sea trials (some members require it in the mooring trials) to verify the total capacity of the air receivers to provide not less than 12 consecutive starts for an engine of reversible type (6 starts for an engine of non-reversible type). It has, however, been acknowledged that it is difficult to conduct the test with the engine in a cold condition because the engine is ready for start in a warm condition.

### **3. Source/derivation of the proposed IACS Resolution**

None

### **4. Summary of Changes intended for the revised Resolution:**

The requirements mentioning the engine conditions (such as cold conditions and warm running condition) have been deleted.

### **5. Points of discussions or possible discussions**

Original version of UR M61 provides the requirement for the number of starting engines based on the cold condition and additional starting for the engine in a warm running condition. However, it does not provide a piece of specific advice for a required additional number of starts or definition of the warm running condition.

In this point, one member tried to find the reference for the additional number of starts in the warm running condition and proposed to delete the text if a detail requirement cannot be provided.

The majority members agree to delete the text, but the following opinions have been raised by other members:

- a. One member expressed concerns about the temperature of engine room, which may have effects on the number of starts or may not be sufficient as contained mass of air in air bottles (at high temperature, say 55°C as example only) tends to exhaust rapidly without achieving the required number of starts.

Some members agree with the concerns. On the other hand, the majority is of the view that the required test in UR M61 had been developed depending on the engine condition whether it is in cold or warm and the engine room temperature should be controlled taking into account UR M28 and M40.

- b. One member proposed developing the guideline for improvement of wording and clarification on the total capacity of air receivers covering adverse conditions (cold starting, minimum air pressure, etc.), for instance:

*the total capacity of air receivers > the required number of starts x the capacity of compressed air of  $P_{min}$  required for 1 starting attempt in the coldest condition anticipated for the engine*

However, the qualified majority deems that there is no need for the starting test to be conducted in the coldest condition anticipated for the engine and the aforementioned proposal has not been reflected in the UR.

Besides, Members have confirmed that Rev.1 of UR M61 should also apply to gas turbines, which fall under the category "internal combustion engines".

**6. Attachments if any**

None

## **Technical Background (TB) document for UR M61 (Rev.2 August 2023)**

### **1. Scope and objectives**

Review of the requirements for the ratio of capacity of each starting air compressor to the total capacity.

### **2. Engineering background for technical basis and rationale**

In a design in which the starting air receivers are also used for the control system, a third air compressor with a smaller capacity may be installed in addition to two air compressors with almost the same capacity in order to minimize the voltage fluctuation when the air compressor starts. (e.g. Total capacity is divided by a ratio of 40:40:20)  
The UR was reviewed as it was not clear whether such a design complied with the requirements of the previous M61.1.2 and M61.1.3.

### **3. Source/derivation of the proposed IACS Resolution**

None

### **4. Summary of Changes intended for the revised Resolution:**

The requirements for the ratio of capacity of each starting air compressor to the total capacity have been clarified.

### **5. Points of discussions or possible discussions**

It was confirmed that the percentage of air compressor capacity described in paragraph 2 was acceptable by members. But it was considered that it could conflict with the requirement of M61.1.2 quoted below. It was therefore decided to amend the text of M61.1.2.

"M61.1.2 Where the main engine is arranged for starting by compressed air, two or more air compressors are to be fitted. At least one of the compressors is to be driven independent of the main propulsion unit and is to have the capacity not less than 50 % of the total required."

On the other hand, although M61.1.3 states that "The capacity is to be approximately equally divided between the number of compressors fitted", it was agreed that this does not prohibit the above percentages.

### **6. Attachments if any**

None

## **Technical Background (TB) document for UR M61 (Rev.3 Feb 2024)**

### **1. Scope and objectives**

To ensure that all UR's relating to compressed air for essential services, including engine starting, are readily apparent to industry.

### **2. Engineering background for technical basis and rationale**

The changes introduced in Rev.3 of UR M61 recognise that the arrangements for the supply of compressed air for essential services in UR M84 are applicable to compressed air for engine starting which is the subject of this UR.

### **3. Source/derivation of the proposed IACS Resolution**

Suggestion by member.

### **4. Summary of Changes intended for the revised Resolution:**

A reference to 'low pressure compressed air systems' is added in UR M61.1.5 together with a cross reference to the new UR M84.2.2 - *Capacity and availability of compressed air for essential services*.

### **5. Points of discussions or possible discussions**

Suggestion was agreed.

### **6. Attachments if any**

None

## UR M63 “Alarms and safeguards for emergency internal combustion (I.C.) engines”

### Summary

In Rev.1 of this UR, the scope of required alarms and safeguards for fuel oil leakage in UR M63 has been clarified compared with UR M35 and M36.

### Part A. Revision History

Version no.	Approval date	Implementation date when applicable
Rev.1 (Jan 2023)	17 January 2023	1 January 2024
New (Jan 2005)	January 2005	-

#### • Rev.1 (Jan 2023)

##### 1 Origin of Change:

- Suggestion by IACS member

##### 2 Main Reason for Change:

Clarify the scope of required alarms and safeguards for fuel oil leakage in UR M63 compared with UR M35 and M36

##### 3 List of non-IACS Member classification societies contributing or participating in IACS Working Group:

None

##### 4 History of Decisions Made:

Amendment of UR agreed through correspondence

##### 5 Other Resolutions Changes:

None

##### 6 Any hinderance to MASS, including any other new technologies:

None

##### 7 Dates:

Original Proposal	: 07 October 2020	(Ref: PM20601_IMa)
Panel Approval	: 04 July 2022	(Ref: PM20601_IMi)
GPG Approval	: 17 January 2023	(Ref: 22200_IGb)

- **New (Jan 2005)**

No records are available

\*\*\*\*\*



## **Part B. Technical Background**

List of Technical Background (TB) documents for UR M63:

Annex 1. **TB for New (Jan 2005)**

See separate TB document in Annex 1.

Annex 2. **TB for Rev.1 (Jan 2023)**

See separate TB document in Annex 2.

## **Technical Background (TB) document for UR M63 (New Jan 2005)**

Current Unified requirements address, to a limited extent alarms and safeguards for emergency diesel engines. The purpose of an emergency diesel engine is to act as an alternative source of power for essential services for the safety of the ship in the event of the main source(s) being out of action or unavailable. It was therefore considered that requirements for automatic shutdown of such engines should be investigated to ensure consistent application of requirements regarding provision of automatic safeguards.

The WP/MCH has been tasked to investigate, develop and propose Unified requirement for alarms and safeguards for emergency diesel engines, including:

- requirements for alarms for the engine operating parameters that could affect the prolonged operation of the engine (e.g. high cooling temperature, LO low pressure and leakage of FO injection pipe).
- requirements for automatic shutdown of the engine when immediate breakdown of the engine (e.g. overspeed) is imminent.
- requirements for automatic shutdown in other cases (e.g. low cooling water pressure and use of over-ride arrangements).

In addressing the above, the WP reviewed SOLAS requirements applicable to emergency diesel engine operation, has established philosophy for alarms and safeguards for emergency diesel engines, has considered safeguards contained in URs M2, M3.2, M36 and of SOLAS regulation II-1/27.5, as a possible basis when determining safeguards applicable for emergency diesel engines.

The initial draft UR had been agreed by the WP, approved by GPG in March 2002 and submitted to Council in May 2002. Subsequently, in light of comments raised by Council Members the draft had been referred to WP/EL and WP/FP&S for their review and comments to WP/MCH.

Having received in September 2004 the comments from these two WGs, WP/MCH unanimously agreed the second draft UR which was submitted to GPG on 16 November 2004.

15/12/2004  
KP

## **Technical Background (TB) document for UR M63 (Rev.1 Jan 2023)**

### **1. Scope and objectives**

Clarify the scope of required alarm and safeguards for fuel oil leakage in UR M63 compared with UR M35 and M36

### **2. Engineering background for technical basis and rationale**

According to table 1 of UR M63, 'Fuel oil leakage from pressure pipes' shall be monitored and activated alarm irrespective of engine power for emergency diesel engines. The required parameter is intended for the prolonged operation of the engine, taking into account the technical background of M63.

On the other hand, a similar parameter, but applying to high pressure pipes, for main and auxiliary internal combustion engine is required in accordance with UR M35 and M36 respectively. For the UR M36, the parameter 'Fuel oil leakage from high pressure pipes' at table 1 had been amended from 'pressure pipe' at the Rev.3 in September 2008. Even if a background of Rev.3 was not traceable, it seems that the parameter was maybe amended depending on comparison with UR M35. And the goal seems for the fire protection like the SOLAS II-2/Reg.4.2.2.5.2.

### **3. Source/derivation of the proposed IACS Resolution**

UR M35, M36

### **4. Summary of Changes intended for the revised Resolution:**

Update the parameter "Fuel oil leakage from pressure pipes" in table 1 to "Fuel oil leakage from high pressure pipes" (adding the 'high' in the expression).

The parameter "Oil mist concentration in crankcase" is also updated by an expression same as in UR M35 and M36.

Update the table 1 to be presented by texts (e.g. high, low, x) instead of figure for improvement of understanding and further potential maintenance.

The term "I.C. engines" is modified to "reciprocating I.C. engine". And regarding the change of term, one member requested to clarify the application of UR M63 whether it can be applied to engines using other non-traditional fuel oil such as gas, ammonia, LPG, bio-derived fuels, and a flashpoint below 60°C. It is clarified that UR M63 applies to engines using fuels covered by ISO 8217.

## **5. Points of discussions or possible discussions**

Regarding the addition part for application of UR M63.1,

- One member suggested applying the UR M63 to engine using distillate marine fuel covered by ISO 8217:2017.
- One member has been of the opinion that the expression for clarification does not need, because the SOLAS convention limits fuel with a flashpoint of not less than 43°C.

Both understandings are not wrong, but the Panel decided to add the text, taking into account the industrial practice and needs of clarification.

Regarding the parameter for fuel oil leakage in Table 1, the expression 'fuel injection pipes and common rails' is added to clarify the scope of high pressure pipes.

One Member questioned whether the F.O. leakage alarm of Table 1 of this UR should be applied to engines with unit injector, but the Panel confirmed that the said alarm should not be applied to unit injectors.

## **6. Attachments if any**

None

**(IACS UR M64, 2003)**

**Technical background to the adoption of the new IACS UR M64**

The scope of this new IACS UR has been derived from the investigations into the “IEVOLI SUN” casualty and possible lessons to be considered. This chemical tanker had installed an integrated cargo and ballast system driven by a hydraulic power pack. The power supply to the circuit was common with other consumers located in the forecastle space. The flooding of the forecastle space caused short circuit in an electric switch of component of the bow thruster thus determining the automatic shutdown of the integrated system. Due to this emergency stop, both the cargo and ballast pumps became inoperable. The activation of the ballast pumps would have delayed and/or mitigated the consequences of progressive flooding of the double hull spaces through the air vents due to reduction of freeboard.

The “IEVOLI SUN” had neither the power pack supply nor the control panel located in the fore flooded compartments. However, there are other installations on existing tankers where the power pack or control panels are located in the forward spaces, which might be at risk in the event of damage and flooding of these spaces due to extreme weather conditions.

The matter could generally be relevant to any integrated hydraulic or electric system used to drive both cargo and ballast pumps. This type of integrated systems is extensively installed on new tankers. Manufacturers of these systems have been consulted and have agreed the scope and general principles of the IACS UR, which, as intended, is to be applied to new designs of integrated cargo and ballast systems installed on new tankers, irrespective of their size.

The identified design features are intended to address designer’s attention to the fact that in the event of failure of the automatic or remote control system, a secondary means of control is to be made available for the operation of the integrated cargo and ballast system. However, other design features can be found to achieve the same objective.

Finally, some of the design features indicated in this IACS UR might be applicable to all remotely controlled cargo and ballast systems and not only integrated systems. Through this IACS UR, designers should become aware that, in general, the operation of remotely controlled cargo and ballast systems may be necessary, under certain emergency circumstances or during the course of navigation, to enhance the safety of tankers.

Note: A proposal to establish a lower limit of size application (..tankers of 1,000 DWT and above...) in M64.1 was not agreed by GPG.

Submitted by the Chairman of the CG/ICB

Date: March 2003

## **Technical Background Document for new draft UR for Draining and Pumping Forward Spaces in Bulk Carriers**

### **1. Scope and Objective**

MSC 76 adopted new SOLAS regulation XII/13 on the availability of pumping arrangements. Thereafter IACS has identified a need for a Unified Interpretation of this regulation that would interpret the arrangements necessary to bring into operation the means for draining and pumping of spaces covered by the regulation.

However the argument was put forward, and accepted as valid, that the regulation lacks the requirements for the capacity of dewatering system. Subsequently it was agreed that these requirements are to be additional to the SOLAS regulation, should be applicable to new ships and thus take the form of an IACS UR.

The draft UR is written to apply to all new bulk carriers as defined by regulation XII/1.1, of single or double side skin construction, and has no ship length limitations.

### **2. Points of discussion**

The first draft was given to the WP by GPG with a task to review the draft in light of GPG Members' comments. These comments had focused on one aspect of the draft UR that had proposed to regulate the capability of the dewatering system by means of specifying the speed of removing water through a piping system.

WP Members had reviewed their GPG Members' objections to that aspect of the draft. Two Members (ABS and NK) did not consider it necessary to specify a minimum speed for removing the water from the forward spaces, as per item 1. b) of the original draft, in addition to the dewatering rate specified under item 1. a).

### **3. Source/derivation of proposed amendments**

MARIN reports made available to the Derbyshire Formal Inquiry include identification of testing that in typhoon "Orchid" conditions with the ship in its intact state, initial flooding through one open 500mm diameter hole could be as much as 63 tonnes per hour. Once flooding had commenced, the rate could increase rapidly to values between 100 to 650 tonnes per hour. For the purpose of identifying a realistic dewatering rate as a minimum requirement, the 63 tonnes per hour through a 500 mm opening has been used as a basis for any size opening. In round figures, 320 A m<sup>3</sup>/hr equates to 63 tonnes/hr through a 500 mm opening.

### **4. Decision**

As mentioned in section 2 above, 2 Members have explicitly agreed to the draft UR subject to deletion of the speed of dewatering requirement. With tacit acceptance by the remaining Members the draft was agreed by consensus.

KP

# UR M66 “Type Testing for Crankcase Explosion Relief Valves”

## Summary

In Rev.4 Corr.1 of this Resolution, references to industry standards have been corrected.

## Part A. Revision History

Version no.	Approval date	Implementation date when applicable
Corr.1 (Oct 2021)	22 October 2021	-
Rev.4 (Feb 2021)	12 February 2021	1 July 2022
Rev.3 (Jan 2008)	January 2008	1 July 2008
Rev.2 Corr.1 (Oct 2007)	October 2007	-
Rev.2 (Sept 2007)	September 2007	1 January 2008
Rev.1 Corr.1 (Mar 2007)	March 2007	-
Rev.1 (Oct 2006)	October 2006	1 July 2007 (Corrected by Corr.1)
New Corr.1(Nov 2005)	November 2005	-
New (Jan 2005)	January 2005	1 January 2007

### • Corr.1 (Oct 2021)

#### 1 Origin of Change:

- Suggestion by IACS member

#### 2 Main Reason for Change:

References to some of industry standards referred to from this UR needed corrections as agreed by Machinery Panel.

#### 3 List of non-IACS Member classification societies contributing or participating in IACS Working Group:

None

#### 4 History of Decisions Made:

It was agreed that references to some of industry standards referred to from this UR should be corrected.

#### 5 Other Resolutions Changes:

None

**6 Any hinderance to MASS, including any other new technologies:**

None

**7 Dates:**

Original Proposal : 15 June 2021 (Ref: PM20906IIMa)  
Panel Approval : 06 October 2021 (Ref: PM20906IIMc)  
GPG Approval : 22 October 2021 (Ref: 20206dIGd)

• **Rev.4 (Feb 2021)**

**1 Origin of Change:**

- Other (Update to comply with the required format when industry standards are referred to)

**2 Main Reason for Change:**

There was a need to update this UR to comply with the following format when industry standards are referred to:

*[Standard Designation], [version/revision, if applicable], [year of publication]  
(examples: API Spec 2F, 6th Edition, 1997; ISO 4624, 2002), where  
[version/revision, if applicable] and/or [year of publication] are decided by IACS  
and  
are not necessarily to be the current/latest version.*

**3 List of non-IACS Member classification societies contributing or participating in IACS Working Group:**

None

**4 History of Decisions Made:**

None

**5 Other Resolutions Changes:**

None

**6 Any hinderance to MASS, including any other new technologies:**

None

**7 Dates:**

Original Proposal: 28 October 2019 (Ref: PM18939\_IMd)  
Panel Approval: 9 November 2020 (Ref: PM20906\_IMf)  
GPG Approval: 12 February 2021 (Ref: 20206dIGb)



- **Rev.3 (Jan 2008)**

No history file available.

- **Rev.2 Corr.1 (Oct 2007)**

No history file available.

- **Rev.2 (Sept 2007)**

No history file available.

- **Rev.1 Corr.1 (Mar 2007)**

No history file available.

- **Rev.1 (Oct 2006)**

No history file available.

- **New Corr.1 (Nov 2005)**

No history file available.

- **New (Jan 2005)**

No history file available.

\*\*\*\*\*

## **Part B. Technical Background**

List of Technical Background (TB) documents for UR M66:

Annex 1. **TB for New (Jan 2005)**

See separate TB document in Annex 1.

Annex 2. **TB for Corr.1 (Nov 2005)**

See separate TB document in Annex 2.

Annex 3. **TB for Rev.1 (Oct 2006)**

See separate TB document in Annex 3.

Annex 4. **TB for Rev.2 (Mar 2007)**

See separate TB document in Annex 4.

Annex 5. **TB for Rev.3 (Jan 2008)**

See separate TB document in Annex 5.

Annex 6. **TB for Rev.4 (Feb 2021)**

See separate TB document in Annex 6.

Annex 7. **TB for Corr.1 (Oct 2021)**

See separate TB document in Annex 7.

**Note:**

*There are no separate TB documents for Rev.1 Corr.1 (Mar 2007) and Rev.2 Corr.1 (Oct 2007).*

## Technical Background

### Revision UR M9 (Rev.3) and M10(Rev.2) New URs (M 66 & M67) for Type Testing Crankcase Explosion Relief Valves and Oil Mist Detection Arrangements

1. WP/MCH Task 55 was established to review the requirements in URM9 “Safety valves for crankcases of internal combustion engines” and M10 “Protection of internal combustion engines against crankcase explosions” for applicability and suitability to modern diesel engines.
2. The work specification included the following:
  - Review crankcase explosion reports for the past 10 years.
  - Review SOLAS requirements applicable to diesel engine crankcase safety.
  - Establish philosophy for a holistic approach to crankcase safety.
  - Consider the applicability of the safeguards in M9 and M10 for crankcase to all types of modern diesel engines – (high speed, medium speed and large slow speed engines + “large” and “small” bore engines).
  - Propose a set Unified Requirements for crankcase safety that include:
    - Requirements for submission of plans and particulars
    - Assessment of engine arrangements
    - Design of equipment
    - Testing of equipment and safety arrangements
    - Type testing requirements
    - Monitoring arrangements
    - Protection of engine and personnel
    - Through life survey and inspection
3. The background to the task was that there have been a number of serious incidents involving crankcase explosions in large diesel engines in the past 5-6 years that have resulted in loss of life and major damage to ships and their machinery. Questions have been raised regarding the adequacy of current standards for crankcase safety with engine builders and ship-owners pressing for revision/re-assessment of the current the standards that essentially stem from the Reina del Pacifico incident in 1947.
4. UR M9 has been extended to address design requirements for explosion relief valves in terms of a required provision of a flame arrester that prevents the passage of flame following a crankcase explosion and for valve to be type tested. The possible effects of shielding on relief valve efficacy have been recognised with a requirement for testing if such shielding is fitted.
5. The revised M9 also includes requirements for a manufacturer’s installation and maintenance manual with instructions installation, maintenance and actions required to be followed after a crankcase explosion. Requirements for marking of the valves have also been included.

6. UR M10 has been revised to remove requirements for the explosion relief valve (moved to M9) and clarify the existing text. The revised M10 now includes requirements for type testing of oil mist detection/monitoring systems and compliance with the oil mist manufacturer's instructions. Requirements for arrangements and installation onto the engine have been defined and also for system testing.

7. UR M10 also addresses alternative methods of preventing the build-up of oil mist and methods of assessment.

8. To support the extensive revisions to M9 and M10 new Unified Requirements for type testing explosion relief valves and for oil mist monitoring/detection arrangements have been developed. These URs provide a common standard against which relief valves and oil mist monitoring/detection systems can be assessed. They define the scope, purpose, test facilities, processes, assessment and reporting.

Note by the Permanent Secretariat:

1. GPG added the following implementation statement to the URs:

"Engines are to be fitted with components and arrangements complying with this UR when:

- 1) an application for certification of an engine is dated on/after 1 January 2006; or
- 2) installed in new ships for which the date of contract for construction is on or after 1 January 2006."

2. The URs (M 66 & 67, M9(Rev.2) and M20(Rev.3)) do not apply to existing engines on the existing ships.

Submitted by WP/MCH Chairman 24<sup>th</sup> August 2004

**Technical Background Document**  
**UR M9(Rev.3, Corr.1, November 2005)**  
**UR M10(Rev.2, Corr.1, November 2005)**  
**UR M66(New, Corr.1, November 2005)**  
**UR M67(New, Corr.1, November 2005)**

1. These UR Ms were adopted in Jan 2005 for implementation from 1 Jan 2006.
2. However, IACS was requested, via the Machinery Panel, by CIMAC and MAN/B&W, to postpone the 1 Jan 06 implementation date for the type testing requirements for crankcase explosion relief valves and crankcase oil mist detection/monitoring and alarm arrangements contained in IACS URs M66 and M67, respectively.
3. This discussion led to re-issuance of these UR Ms, changing the implementation statements.

These UR Ms were re-issued as 'Corr.1' on 29 Nov 2005.

4. GPG Chairman's message (4069glGk, 14/11/2005) contains a more detailed background for this amendment.

For records, GPG/Council Chairmen's messages are attached to the TB document for the January 2005 versions.

Permanent Secretariat  
29 Nov 2005

**GYH**

---

**From:** AIACS@eagle.org  
**Sent:** 23 November 2005 20:50  
**To:** iacs@bureauveritas.com; iacs@ccs.org.cn; iacs@dnv.com; iacs@gl-group.com;  
krsiacs@krs.co.kr; iacs@lr.org; clnkiacs@classnk.or.jp; iacs@rina.org; iacs@rs-head.spb.ru;  
johnderose@iacs.org.uk; colinwright@iacs.org.uk; gilyonghan@iacs.org.uk;  
terryperkins@iacs.org.uk; efs@iacs.org.uk; richardleslie@iacs.org.uk;  
helenbutcher@iacs.org.uk; MCH-Panel@gl-group.com  
**Subject:** 4069glCd: UR M66, M67 - application date

Date: 23 Nov 05

TO: IACS Council Members

TO: IACS GPG Chairman & Members

TO: IACS Permanent Secretary: Mr. R. Leslie

TO: IACS Machinery Panel Chairman: Dr. U. Petersen

FROM: R. D. Somerville

File Ref: T-12-2

Subject: 4069glCd: UR M66, M67 - application date

1. All Members have replied to ICc. Eight Members have supported the proposed course of action in IGk.
2. Lloyd's, supported by RINA, proposes that the URs need not be withdrawn, as proposed in IGk, but that only the implementation date need be changed. LR proposed posponement to 1 July 06 -- instead of 1 Jan 07, as proposed in IGk.

2.1 Regarding the implementation date of 1 July 06 vs. 1 Jan 07, this had already been debated in GPG and the strong majority supported 1 Jan 2007. I conclude 1 January 2007 is agreed.

2.2 Regarding whether to "withdraw" the URs or "postpone" their date of application, to my understanding either approach is acceptable and will result in the same outcome.

3. Therefore to accomodate the request that the URs not be withdrawn, I conclude that the agreed course of action is:

3.1 **Perm Sec** is to revise the uniform application statements for the URs, as follows, reissue them, and post them on the IACS website:

3.1.1 For URs M66 and M67:

"Note: Engines are to be fitted with components and arrangements complying with this UR when:

- 1) an application for certification of an engine is dated on/after 1 January 2007; or
- 2) installed in new ships for which the date of contract for construction is on or after 1 January 2007."

3.1.2 For UR M9, Rev.3:

"2. Engines are to be fitted with components and arrangements complying with Revision 3 of this UR, except for M9.8, when:

- 1) an application for certification of an engine is dated on/after 1 January 2006; or
  - 2) installed in new ships for which the date of contract for construction is on or after 1 January 2006.
- The requirements of M9.8 apply, in both cases above, from 1 January 2007."

3.1.3 For UR M10, Rev.2:

"2. Engines are to be fitted with components and arrangements complying with Revision 2 of this UR, except for M10.8, when:

- 1) an application for certification of an engine is dated on/after 1 January 2006; or
- 2) installed in new ships for which the date of contract for construction is on or after 1 January 2006.

The requirements of M10.8 apply, in both cases above, from 1 January 2007."

3.2 **Machinery Panel** is to:

- a. inform CIMAC and MAN/B&W of the postponed application of URs M66 and M67, and the intention to update them;
- b. update URs M66 and M67, as quickly as possible, taking account of CIMAC's, MAN/B&W and Panel Member's inputs;
- c. once adopted at Panel level, send the revised URs to CIMAC for quick review/comment and notification to the equipment suppliers;
- d. further update the URs as needed in light of any comments received from CIMAC;
- e. submit the revised URs to GPG for approval not later than the end of the 1st Q 2006.

3.3 Upon adoption of the revised URs by IACS Council, **Machinery Panel** is to send them to CIMAC for their information and requesting that CIMAC notify the equipment suppliers of the requirements.

Regards,

Robert D. Somerville

IACS Council Chairman

email protected and scanned by BIS Advanced Spam & Virus Checking - powered by AdvascanTM  
- keeping email useful

**GYH**

---

**From:** AIACS@eagle.org  
**Sent:** 14 November 2005 22:00  
**To:** iacs@bureauveritas.com; iacs@ccs.org.cn; iacs@dnv.com; iacs@gl-group.com;  
krsiacs@krs.co.kr; iacs@lr.org; clnkiacs@classnk.or.jp; iacs@rina.org; iacs@rs-head.spb.ru;  
johnderose@iacs.org.uk; colinwright@iacs.org.uk; gilyonghan@iacs.org.uk;  
terryperkins@iacs.org.uk; efs@iacs.org.uk; richardleslie@iacs.org.uk;  
helenbutcher@iacs.org.uk  
**Cc:** MCH-Panel@gl-group.com  
**Subject:** 4069IGk: UR M66, M67 - application date

Date: 14 Nov 05

TO: Mr. R.D. Somerville, IACS Council Chairman

CC: IACS Council Members  
CC: IACS GPG Members

CC: IACS Machinery Panel Chairman: Dr. U. Petersen

CC: IACS Permanent Secretary: Mr. R. Leslie

FROM: S.R. McIntyre

File Ref: T-12-2

Subject: 4069IGk: UR M66, M67 - application date

1. IACS has been requested, via the Machinery Panel, by CIMAC and MAN/B&W, to postpone the 1 Jan 06 implementation date for the type testing requirements for crankcase explosion relief valves and crankcase oil mist detection/monitoring and alarm arrangements contained in IACS URs M66 and M67, respectively. Their request is to give the equipment manufacturers and the engine builders more time to adapt to the new requirements. Industry has also recommended the need for some improvements/clarifications in the two URs, which the Machinery Panel has agreed are needed/appropriate.

1.1 Since CIMAC was involved in the IACS decision, some years ago, to develop these URs, in retrospect it would have been advisable to submit the URs for external review by CIMAC before their adoption to ensure that CIMAC would be fully aware of the requirements and the timetable for their implementation--and working with IACS Societies to ensure that their suppliers were apprised of and complying with the new requirements. Unfortunately, this was not done.

1.2 The type testing requirements of URs M66 and M67 are invoked in recent revisions of M9 and M10, respectively.

2. The Machinery Panel recommended that GPG postpone implementation of URs M66 and M67 and advised GPG that both URs need to be updated/clarified.

2.1 Several Members have also advised that they needed more time for initial implementation and could not implement the two URs from 1 Jan 06 as had been originally agreed by Council.

3. Having carefully considered the input from CIMAC, MAN/B&W, the Machinery Panel and Members, GPG agrees that IACS should postpone the implementation of these URs by one year to give time for updating them, vetting the changes with CIMAC, notifying industry and for Members to process the related rule changes. Therefore, GPG requests Council's agreement to the following course of action:



3.1 URs M66 and M67, along with M9.8 of M9, Rev.3 and M10.8 of M10, Rev.2 are to be withdrawn pending the updating of M66 and M67, which needs to be accomplished as quickly as possible (ie. the target date of 1st Q 2006 for revising M66, agreed at GPG 59, needs to be accelerated);

3.2 The updated URs, once adopted at Panel level are to be sent to CIMAC by the Machinery Panel for quick review/comment by CIMAC, and then further updated by the Panel in light of any comments received, prior to submission to GPG/Council;

3.3 The updated URs M66 and M67, once adopted by GPG/Council, are to be issued as "Corr" (since the initial versions will never have been implemented)--with uniform application from 1 Jan 2007 (instead of 1 Jan 2006);

3.4 M9, Rev.3 without M9.8, and M10, Rev. 2, without M10.8, are to be reissued as "Corr" until the updated M66 and M67 are adopted by Council, at which time M9.8 and M10.8 are to be included in M9, Rev.4 and M10, Rev.3, respectively for application from 1 Jan 2007.

4. Council Chairman is kindly requested to seek Council's agreement to this course of action as soon as possible.

Regards,

S.R. McIntyre

IACS GPG Chairman

email protected and scanned by BIS Advanced Spam & Virus Checking - powered by AdvascanTM  
- keeping email useful

**Technical Background Document**  
**UR M66 Rev.1 (October 2006)**  
**Type Testing Procedure for Crankcase Explosion Relief Valves**

**Scope and objectives**

UR M66 is currently issued as 'Corr.1' with an application from 1 January 2007. During discussions at the joint Machinery Panel/CIMAC meeting in September 2005 it was the common view that UR M66 requires some further improvements/ clarifications. Accordingly, a new task for the Machinery Panel was raised (PM5104) and the Panel tasked to revise M66 with a view to address CIMAC concerns and to remove errors and ambiguities.

**Points of discussion or possible discussions**

Changes to UR M66 are mainly of an editorial nature to clarify specific requirements. In the course of the review process comments were received from CIMAC, Penn-Troy Manufacturing and Pyropress (see Appendix).

CIMAC's comments were discussed at the joint Machinery Panel/CIMAC meeting in September 2005 and again at the CIMAC WG2 meeting on 7 September 2006 and at the joint Machinery Panel/ CIMAC meeting on 19 September 2006. The Panel's response is indicated in the attached CIMAC proposal of 22 September 2005. All comments were taken into consideration by the Panel in the review process.

Penn-Troy Manufacturing approached IACS with a concern about the applicability of UR M66 to their explosion relief valves which feature internal oil wetting of the flame arrester as part of the design. The Machinery Panel considered this issue and agreed to add a 'Note' under paragraph 1.2 allowing for this feature.

Pyropress UK approached IACS with concerns about the M66 requirement for a free area of explosion relief valves of not less than 115 sq cm per cubic metre of crankcase gross volume as their valves are designed for a ratio of typically 700 sq cm per cubic metre. The Panel agreed that as long as the purpose in item 3 of M66 is verified the prescriptive requirements relating to the 115 ratio need not be insisted upon. To that effect a new 'Note 2' was introduced in paragraph 4.1.11.

LR recalled that the origins of the minimum standard of 115 sq cm per cubic metre for crankcase relief stem from work carried out in the late 1940s and 1950s and theory presented by Benson and Burgoyne on ignition in closed spherical vessels with central ignition.

The final draft text of M66 was sent to CIMAC on 21 July 2006 with a four week deadline for comments. A corrigendum for item 7.2.1.1 was sent on 17 August 2006. CIMAC reverted on 1 September 2006 with a proposal to modify item 9 'Design series qualification' (see Appendix). This proposal was discussed at the CIMAC WG2 meeting on 7 September 2006 and at the joint Machinery Panel/ CIMAC meeting on 19 September 2006 and further modified as reflected in the new paragraphs 9.3 and 9.4.

The Panel at its 4<sup>th</sup> meeting (19 – 22 September 2006) considered whether the new paragraphs 9.3 and 9.4 constitute technical changes rather than clarifications. It was the Panel's view that they are relaxations compared with the previous requirements and should therefore not affect the implementation date of 1 January 2007.

**Source/derivation of proposed requirements**

N/A

**Decision by Voting (if any)**

The revised text was agreed unanimously by Panel members.

**Appendix**

The following comments from industry were received in the course of the revision of M66 (attached):

- CIMAC (22 September 2005)
- Penn-Troy Manufacturing (26 May 2006)
- Pyropress (9 March 2006)
- CIMAC (1 September 2006)

Machinery Panel Chairman

25 September 2006

**Permanent Secretariat Note:**

Subject no. 4069g – agreed by GPG and Council 16 October 2006 (IGq).



## CIMAC CWG „CS-D“ WG2

### Proposal towards IACS Machinery Panel

St. Stutz/Secretary WG2

22.09.2005

**Subject: New Unified Requirement IACS UR M66**

#### Background

As the final text in IACS UR M66 has not been discussed with Cimac CWG2 before coming in force and in the light of a usually good cooperation between IACS and Cimac we kindly ask IACS MP to take the below comments into consideration and reconsider the final text and the date for coming in force.

For the valve makers it might be difficult to overcome the situation in time as they should get the possibility to prepare themselves (get familiarized) with the new situation.

#### Proposal

The date of coming into force of the new UR M66 is strongly recommended to be postponed until a common text has been agreed between IACS, CIMAC and the valve makers and enable the valve makers to prepare themselves.

Following M66 items are recommended to be revised taking into consideration the respective comments below:

#### 5.1

We feel that the pressure 0.2 bar is an unnecessary requirement as the valves have to open at 0.05bar and not at 0.2bar (full open at 0.2 bar)

*Panel: Wording changed to “... The pressure in the test vessel is to be not less than atmospheric and is not to exceed the opening pressure of the relief valve.”*

#### 6.2

The requirements for 0.2bar have been discussed with N. Rattenbury several times. He accepted to specify a lower opening pressure. The IACS requirement 0.2bar means a pressure where the valve is fully open. But it has to be taken into

consideration that these 0.2bar are rather related to the spring characteristic and thus we do not see any inconsistency of a pressure between 0.05 and 0.2bar.

-2-

Furthermore, some trunk engines shall have a higher opening pressure of 0.1bar. For which engines then M66 should be valid?

*Panel: Wording changed to “... demonstrate that the opening pressure is in accordance with the specification within a tolerance of +/- 20 % and ...”*

*The tolerance level of 20% was selected on the basis of the valve manufacturer's published data. It is considered that it is the valve manufacturer rather than the user who should provide the technical data relevant to the product. It is not clear why CIMAC members should wish to re-define the OEM's specification.*

### **7.2.2.3**

We propose to revise the text as follows:

“Provided that the first explosion test successfully demonstrated that there was no indication of combustion outside the flame arrester, a second explosion test without the polythene bag arrangement is to be carried out in as rapid sequence as possible. During the second explosion the valve is to be monitored by video recording and preferably by recording with a heat sensitive camera.

*Panel: Covered by 7.1.3 and 4.1.5*

### **7.2.2.4**

Under this item it is proposed to maintain the valve closed for 10 seconds but under 6.2 a time of 30 seconds is mentioned. Why this discrepancy?

*Panel: The Panel clarifies that the different time periods required in paragraphs 7.2.2.4 and 6.2 apply to different test conditions (cf. Minutes of joint Machinery Panel/CIMAC meeting, September 2005).*

### **8.1.2**

How to check the valve lift?

*Panel: The Panel clarifies that the objective of this paragraph is to determine the cross sectional area and lift after an explosion (cf. Minutes of joint Machinery Panel/CIMAC meeting, September 2005).*

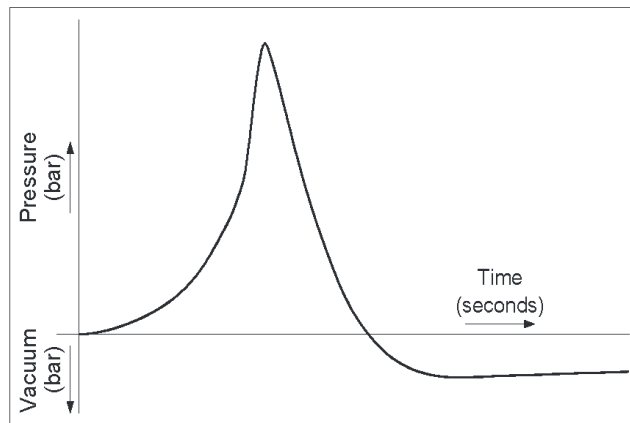
### **8.1.7**

Where do these values come from “0.3bar underpressure for 10 seconds”?  
See also 7.2.2.4.

**Panel:** These values have been determined from actual field tests/measurements and are considered to provide an acceptable baseline for assessment purposes. The following explanation was provided to CIMAC:

#### Typical Crankcase Pressure/Time Curve – Crankcase Explosion

The diagram below shows a typical pressure/time with a simulated crankcase explosion. There will be an under-pressure (vacuum) following the pressure rise due to the explosion as air and combustion products are expelled through the relief valve during the explosion sequence. The explosion sequence takes place over a very short period of time and the recording equipment needs to be capable of recording at a very fast rate which requires a large memory. Recording of the pressure variation over ten seconds time duration from the start of the ignition sequence is achievable with readily available equipment and is considered to sufficient to ascertain that the valve has re-seated after an explosion. The 0.3 bar under pressure (vacuum) is consistent with what has been found during testing of the different valves.



NR  
16th November 2005

### 9.1

We propose to revise the text as follows:

“A series of valves can be approved on the bases of a single test of one device of a medium size if all geometric features of the valve can be scaled linear and that all valves have the same nominal opening pressure and flame arrester fulfil the requirement 9.2”.

**Panel:** Propose to keep paragraph 9.1, subject to editorial corrections (cf. Minutes of joint Machinery Panel/CIMAC meeting, September 2005).

### 9.2

“flame screen” is to be changed to “flame arrester” in first and fourth line.

**Panel:** Agreed, the term ‘flame arrester’ will be used.

Dr. Petersen

Thank you for your reply. I too have been traveling and I am sorry for the delay in responding to you.

Penn-Troy has done testing some years ago showing the effectiveness of the oil wetted BICERA flame trap. The BICERA Internal Flame Trap was originally researched and patented by BICERA. (now BICERI) In part, their research was in response to a crankcase explosion aboard the REINA DEL PACIFICO. (See link: <http://brew.clients.ch/engine.htm> )

The oil wetting of the screen comes from the normal splash and spray of oil in a crankcase. It is important that when testing that the oil wetting also be simulated. When Penn-Troy did testing, it was with a small oil pump spraying an oil mist on the screen to simulate a normal crankcase environment. Flame emission was determined by film and direct observations.

Regarding the US Coast Guard specifications, they require relief valves with a screen type flame arrestor and also require a minimum of 1.5 in<sup>2</sup> of relief area for each cubic foot of crankcase volume.

(345 cm<sup>2</sup>/ 1 Meter<sup>3</sup>) This is three times the minimum relief area stated in the IACS specifications.

One question that has come up is the means of adjusting the volume of the test vessel. In our testing, Penn-Troy regulated the required test vessel volume by adding oil or water to the vessel to reduce the internal air volume of an oversize vessel to match the size valve being tested. I assume that this same method can be used to reduce the internal air volume of the test tanks used for IACS testing. It is a practical way of maintaining the correct volume per section 4.1.12 of M66.

Greg Powers

-----  
----- Original Message -----**From:** MCH-Panel **To:** [gwpowers@epix.net](mailto:gwpowers@epix.net) **Cc:** GYH **Sent:** Wednesday, June 07, 2006 5:52 AM **Subject:** UR M66, Task 5104

Date: 7 June 2006

Dear Mr Powers, first of all my apologies for the delayed response, I have been out of the office most of the time recently. Regarding your enquiry please be advised as follows:

1. Engines are to be fitted with components and arrangements complying with UR M66 when:  
a) an application for certification of an engine is dated on/ after 1 January 2007, or b) installed in new ships for which the date of contract for construction is on or after 1 January 2007.

1 IACS decided on the application date 1 January 2007 to give industry sufficient time to prepare for the test procedure. Currently the IACS Machinery Panel revises the text of January 2005 to respond to specific feedback from industry. The review is not intended to introduce substantive changes but rather to improve the clarity of certain requirements. The review is due to be completed shortly.

2 The objectives of the test procedure in UR M66 are fourfold:

- 3.1 To verify the effectiveness of the flame arrester,
- 3.2 To verify that the valve closes after an explosion,
- 3.3 To verify that the valve is gas/air tight after an explosion, and
- 3.4 To establish the level of over pressure protection provided by the valve. The test procedure laid down in UR M66 does not make specific reference to oil wetting of internal flame arresters. In this context it would be of interest to learn which test specification Penn-Troy Manufacturing uses for its flame arresters, what kind of tests are conducted and how it is verified that no flame passes through the valve. I note from the literature enclosed with your emails that Bicera valves meet specifications from the U.S. Coast Guard, ABS and other classification societies. Which specifications are these? Do they relate to the pressure relief capability or also to the flame arrester? I look forward to hearing from you,

Regards,  
Dr Ulf Petersen  
IACS Machinery Panel Chairman

-----Ursprüngliche Nachricht-----**Von:** Greg Powers [mailto:gwpowers@epix.net]  
**Gesendet:** Freitag, 26. Mai 2006 15:30 **An:** MCH-Panel **Betreff:** Fw: Reference: UR M66, Task 5104

Dear Dr. Petersen / Machinery Panel

Could you update me with your progress on revisions to M66, Crankcase Relief Valves?

Our company is concerned with a couple of issues:

- 1 UR M66 seems to make no provision in the test for oil wetting of the flame suppression screen of relief valves with internal flame traps. Our Bicera Valve has an internal flame trap. The normal oil splash of a crankcase wets the surface of the flame suppression screen and enhances it's effectiveness substantially. The new testing criteria should make allowance for this feature if internal flame traps are used.
- 2 The Bicera Valve was designed from the beginning to incorporate an internal, oil wetted flame arrester as well as an external cover to direct the exhaust. The large, external flame arrester of some valves make it difficult and cumbersome to add a deflector cover because the external flame arrester takes up so much area. To give the exhausting gasses room to flow between the flame arrester and the deflector cover would require a very large cover relative to the valve size. The Bicera Valve



does not have any external flame arresting components to inhibit the flow of the gases. The internal flame arrestor has a large surface area relative to the size of the valve, and it's efficiency is increased by oil wetting from the normal oil splash present in crankcases.

Please let me know if I can provide any further information.

Gregory Powers  
Penn-Troy Manufacturing

From: martin@pyropress.com  
Date: Thu, 09 Mar 2006 10:40:23 +0000  
To: jennydeedman@iacs.org.uk  
Subject: explosion relief valve, M66

Jenny Thank you for your e-mail and copy of M66.  
However I have some additional quires which I have initially directed to Collin Wright as the contact I was passed to ref. my telephone conversation 3.3.06.

For the attention of Collin Wright.  
Collin. Reference our recent telephone conversation I have a query concerning IACS standard M66. I understand you may be more of a tank rather than a case expert however if you can help, I have a project of updating and re-certifying our crankcase explosion relief valves. Our valves originated from BICERI (British Internal Combustion Engine Research Institute) from whom we manufactured under licence, these valves have a long track record and have been shown to be affective within the design parameters laid down. We are now looking for registration with relevant approval and with testing to IACS M66. One major difference between the two standards is the relief area to cubic volume. M66 calls for 115 cm sq /M.cu; this relates to a BICERI figure of 700 cm sq /M.cu.

M66 section 4.1.12 gives 115 as a minimum " relief valve to be not less than 115 cm sq/ M cu of the gross volume." This would indicate larger relief areas are acceptable, but the testing volume is then tied down to +15% to 10% from the 115 volume ratio.  
This effectively restricts all valves designed to BICERI criteria, which are fit for purpose if sized appropriately.

I would be grateful if you could give any information on the origins of 115 cm sq/ M cu for flame arresters and whether M66 is likely to be amended to accommodate larger relief area valves.

Regards

Martin Elver

## **CIMAC comment on final draft UR M66, 1 September 2006**

To: Dr. Ulf Petersen, Chairman IACS Machinery Panel

**Subject: IACS UR M66, comments to final draft version of 17 Aug. 2006**

Dear Mr. Petersen,

Referring to your e-mail of 17 August 2006, we ask you kindly to consider the following (very late) comments.

We appreciate your effort to finalize the wording on IACS UR M66, and in general, we agree to the text. However, we believe some areas could be defined more precisely.

Our objective is that the tests should result in approved valves to be used on diesel engines. For example, on some two-stroke engines valve sizes from "173" to "735" are used.

During the tests in 1999, we tested the two sizes of valves "173" on a 1.6 m<sup>3</sup> test vessel, and a valve size "420" on a 10 m<sup>3</sup> test vessel.

Those tests formed the basis for approval of the whole series of valves.

We presume that similar test procedure can be used again; however, in Item 3 (Purpose) on page 1, four purposes are mentioned that is 3.1.1 to 3.1.4.

In the present IACS UR M 66 revision of August 2006, only Item 3.1.1 is taken in consideration in Item 9.

Therefore, we are suggesting the following modifications of Item 9.1 and 9.2:

9.1 A series of valves can be approved on the basis of a single test of one device of a medium size, if all geometric features of the valves are scaled linear, and that all valves have the same nominal opening pressure. In addition, it has to be documented that the spring characteristics ensure that the valve will be completely open at a pressure of 0.2 bar, and that the flame arrester fulfils the requirement in 9.2

9.2 The qualification of quenching devices to prevent the passage of flame can be evaluated for other similar devices of identical type where one device has been tested and found satisfactory.

The quenching ability of a flame arrester depends on the total mass of quenching lamellas/mesh. Provided the materials, thickness of materials, depth.....etc.

Beside our comments to item 9, we have a small wish to change the texts in item 7.2.2.3. We believe that the wording "and there are no signs of damage to the flame arrester or valve" will course many arguments regarding what is considered a damage (?). Conclusively, if the valve is able to function during the second test, then it should be accepted. Nevertheless, we will recommend our customers to replace the flame arrester after a crankcase explosion.

For your further information, Cimac WG 2 will have an ordinary group meeting on 7 September 2006, at MTU in Friedrichshafen.

Mr. C Hardler participates as a Cimac member, and Mr. Norman Rattenbury as an IACS representative.  
The topic IACS UR M 66 is on the Cimac agenda.

Best regards,  
Kjeld B Hansen  
Cimac WG2 Chairman

# Technical Background, Internal

## UR M66, Rev.2 (Sept 2007)

### *Scope and objectives*

UR M66 Corr. 1 as currently published on the IACS website has been used as a basis for tests of crankcase explosion relief valves at FTZU in Ostrava, Czech Republic in April 2007. During the tests it became apparent that the location of the flange at 1/3 distance from the end of the test vessel may lead to unstable and not reproducible conditions inside the test vessel after ignition of the methane in air mixture. Furthermore, the flame arresting capability of the valves could not always be clearly determined from observations and video recordings. It was considered necessary by all parties attending the tests (class representatives from LR, GL and RS, engine designers MAN and Wartsila and experts from the test laboratory) to record tests with a heat sensitive camera to identify any possible flame transmission.

Valve manufacturers requested fewer valve sizes of one particular design to be tested in order to obtain a balanced requirement for valve sizes to be tested given the considerable effort involved in the tests.

The Panel has addressed the points above and made corresponding modifications in Corr. 2 of M66. In addition, some editorial improvements and clarifications were introduced.

### *Points of discussion*

#### UR M66 Corr. 2

The RS Panel member made two proposals for changes to the M66 Corr. 2. The first relates to tolerances in 4.1.3 (-2.5% instead of -1%). The second suggestion relates to means of ignition in 5.4 (proposal to add 'or equal alternative means of ignition'). RS indicated that these proposals could also be considered in future revisions of M66 and that they did not insist on their implementation at this point in time (PM7101\_RSb of 6 June 2007). Since LR and GL explicitly did not support these proposal and no further comments were received from Panel members it was concluded not to adopt these proposals now but to re-consider them in a future revision of M66.

Externally, the changes in M66 Corr. 2 were discussed with representatives from MAN and Wartsila at a meeting arranged by GL on 10<sup>th</sup> May 2007. Both engine builders supported the changes.

#### Implementation date

The implementation date of M66, Corr. 1 as published on the IACS website is 1st July 2007. Hoerbiger in particular has expressed concerns about this date, stating that they require 12 to 18 months to set up a new production line and requesting an unspecified extension for the implementation date (cf. Annex 1). Taking into account these concerns RS, KR, NK, DNV and ABS supported a new implementation date for M66, Corr. 2 of 1 January 2008. In principle LR and GL also agreed to this date, however, there was still some discussion in the Panel about the interpretation of the application statement which would then read:

#### Quote

Note: Engines are to be fitted with components and arrangements complying with this UR when:

- 1) an application for certification of an engine is dated on/after 1 January 2008; or
- 2) installed in new ships for which the date of contract for construction is on or after 1 January 2008.

#### Unquote

LR, GL and ABS are anxious to implement M66 Corr. 2 at the earliest possible opportunity. In 2006 GL recorded several instances of crankcase explosions while LR recorded 143 crankcase explosions in its classed fleet in the period 1990 to 2001 and several more since. Other members also report crankcase explosions on vessels classed by them. As further discussions about the interpretation of the above Note remained inconclusive, and in view of the urgency of the matter, it was concluded to

revert back to GPG and seek advice about the exact wording of the application statement.

### ***Source/derivation of proposed requirements***

Experience gained from tests conducted at FTZU in Ostrava in April 2007.

### ***Decision by voting***

The revised text of M66 was supported by all members commenting (with the RS concerns outlined above)

Regarding the implementation date the positions were as follows:

Support for 1 January 2008: RS, KR, NK, DNV, ABS, LR, GL

Support for 1 July 2007: CCS

Both dates acceptable: IRS

No comments: BV, RINA

The wording of the application statement remained inconclusive at the time of writing.

Hamburg, 26 June 2007  
Chairman IACS Machinery Panel

### **Permanent Secretariat note (September 2007):**

#### ***GPG discussion***

By 2/3 majority (RS disagreed, DNV did not reply) GPG decided that the new version of UR M66 should be a Rev.2 rather than a Corr.2 since the technical content of the UR has been changed. The technical content of the revised UR M66 was agreed by all replying members.

After discussion GPG agreed on the following implementation statement for UR M66 Rev. 2:

*"Engines are to be fitted with components and arrangements complying with this UR when:*  
*1) the engine is installed on existing ships (i.e. ships for which the date of contract for construction is before 1 January 2008) and the date of application for certification of the engine is on or after 1 January 2008; or*  
*2) the engine is installed on new ships (i.e. ships for which the date of contract for construction is on or after 1 January 2008)."*

ABS proposed to withdraw all previous versions of UR M66 since they all appear to be flawed, however as BV currently has files under review which are being certified against UR M66 Corr.1, it was concluded that this was not possible and UR M66 Rev.2 would simply replace Corr.1 for projects covered by the aforementioned implementation statement.

UR M66 Rev.2 was approved 14 September 2007, ref. 4069gIGv.



**Germanischer Lloyd  
Att. Mr. Ulf Petersen  
Chairman IACS Machinery Panel  
Vorsetzen 35  
D-20459 Hamburg**

**Compression Technology**

HOERBIGER  
VENTILWERKE GmbH & Co KG

Braunhubergasse 23  
1110 Vienna, Austria  
Phone: +43 1 74 00 4-0  
Fax: +43 1 74 34 222-222  
info-hvw@hoerbiger.com  
www.hoerbiger-compression.com

UID: ATU 58154838

HG Vienna FN 251 808 g  
ARA-Lizenz Nr. 14248  
ABN-AMRO Vienna  
Swift-Code ABNAATWW  
IBAN: AT 77 19985 000 2301 1009

**Date: May25th, 2007**

**Subject: Type Approval for Explosion Relief Valves & New  
IACS Rules**



Dear Mr. Petersen,

Since many years Hoerbiger Vienna manufactures explosion relief valves for marine diesel engines. Per year we supply more than 20.000 relief valves for the engine industry. These valves are often inspected by external classification authorities based on valid type approvals.

Since 2005 (when IACS updated the rule M66) Hoerbiger has spent substantial effort to improve the existing valves to fulfil the rules. We have performed several tests at the testing institute FTZU, but we did not pass so far. You may already have received the information that the new rules require substantial higher strength of existing explosion relief valves.

After a long phase of tests and improvements we finally informed members of the IACS authority mid April 2007 during a meeting in Ostrava, that Hoerbiger will design a complete new relief valve to fulfil the new rules. At the same meeting discussions have been held if the test procedures (as defined in M66) shall be modified in some points.



Next week Hoerbiger is going to do internal tests with the new design at FTZU and as a next step we plan to invite the classification societies for official type approval tests within 2 months. To prepare the official tests we kindly ask you to inform us if the IACS rule M66 is going to be modified in the near future based on the discussions held in Ostrava.


If the new design passes the official tests successfully Hoerbiger will require a 12 to 18 month time frame to setup new production and assembly lines. Since the new design builds larger some engine manufacturers will have to adapt their frame constructions to incorporate our valves.

We kindly ask you to extend the due date in the M66.

- Please inform us, if there will be any official statement by IACS in this regard.

Best regards

  
Thomas Halwachs  
Product Manager

  
Johannes Besau  
Key Account Manager

Receipt acknowledged 5/6/07



## TECHNICAL BACKGROUND

### UR M66, Rev.3 – January 2008

1. IACS has received several letters from Industry raising concerns about the application of revision 2 of UR M66. As a result of that GPG members were asked to comment on the following issues:

- (i) Support or disagreement to CCS proposal to move the date in the application statement to 1 July 2008;
- (ii) Support or disagreement to NK proposal to substitute "the date of application for certification of the engine" with "application for registration of classification (new construction)" in the application statement.

2. With respect to change of the application statement to 1 July 2008:

- ABS were very reluctant to put back the application statement for the revision of UR M66, but said that "if Members are going to reserve on the application date then the only way to get unanimous, uniform application of the revised UR may be to again set back the application date".
- GL were also reluctant and not in favour of extending the application date for this safety relevant device in general. But they were prepared to grant a period of grace for flame arresters until 30 June 2008.
- CCS, NK, DNV, RS, BV, KR, RINA and LR could accept to change the date in the application statement to 1 July 2008. RINA proposed a new text as shown below.

It was therefore concluded to change the implementation note in rev.2 of UR M66 according to RINA's proposal.

3. With respect to NK's proposal to substitute "the date of application for certification of the engine" with "application for registration of classification (new construction)", ABS, RS, GL, KR, LR and RINA explicitly objected. CCS and DNV did not comment upon it, and LR said that "we fail to recognise what "application for registration of classification (new construction)" means contractually. For classification purposes there is only one date that counts - date of "contract for construction" of the ship as defined in PR 29".

ABS proposed to define the "date of application for certification of the engine" as "the date of whatever document the Society requires/accepts as an application or request for certification of an individual engine". DNV, RS, BV, GL, KR, LR and RINA agreed they could support this. Thus the definition was by majority accepted to be incorporated in RINA's aforementioned proposal for a new implementation note.

4. Therefore the revised Item 1) of the implementation Note, incorporating RINA and ABS's proposals, reads as follows:

## Technical Background (TB) Document for UR M66 (Rev.4 Feb 2021)

### 1. Scope and objectives

UR M66(Rev.3) does not reflect the agreed format for referencing the EN, ISO and VDI standards. Rev.4 has been developed to comply with the agreed format.

### 2. Engineering background for technical basis and rationale

#### Format for references to Industry standards

**Format:**

*[Standard Designation], [version/revision, if applicable], [year of publication] (examples: API Spec 2F, 6th Edition, 1997; ISO 4624, 2002), where [version/revision, if applicable] and/or [year of publication] are decided by IACS and are not necessarily to be the current/latest version.*

### 3. Source/derivation of the proposed IACS Resolution

None

### 4. Summary of Changes intended for the revised Resolution

UR M66 has been updated to specify the revision/version of the EN, ISO and VDI standards as well as MSC Circulars as follows:

<b>EN, ISO and VDI standards</b>	<b>Replaced by</b>
EN 12874:2001	EN 12874:2002
ISO/IEC EN 17025:2005	ISO/IEC 17025:2017
EN 1070:1998	EN 1070:2018
VDI 3673	VDI 3673:2002
<b>MSC Circulars</b>	<b>Replaced by</b>
MSC/Circular 677	MSC/Circ.677 as amended by MSC/Circ.1009 and MSC.1/Circ.1324

### 5. Points of discussions or possible discussions

None

### 6. Attachments if any

None

**Technical Background (TB) Document for UR M66 (Corr.1 Oct 2021)****1. Scope and objectives**

References to some of industry standards referred to from this UR needed corrections as agreed by Machinery Panel.

**2. Engineering background for technical basis and rationale**

None

**3. Source/derivation of the proposed IACS Resolution**

None

**4. Summary of Changes intended for the revised Resolution**

Corrections of references to industry standards are as follows:

<b>EN standards</b>	<b>Correction</b>
EN 12874:2002	ISO 16852:2016
EN 1070:2018	ISO 12100:2010

**5. Points of discussions or possible discussions**

None

**6. Attachments if any**

None

## UR M67 “Type Testing Procedure for Crankcase Oil Mist Detection and Alarm Equipment”

### Part A. Revision History

Version no.	Approval date	Implementation date when applicable
Rev.2 (Feb 2015)	22 February 2015	1 July 2016
Corr.1 (Oct 2007)	5 October 2007	-
Rev.1 (Oct 2006)	10 October 2006	1 January 2008
Corr.1 (Nov 2005)	7 December 2005	-
New (Jan 2005)	10 January 2005	1 January 2007

- **Rev.2 (Feb 2015)**

**.1 Origin of Change:**

- Feedback from OMD manufacturer

**.2 Main Reason for Change:**

Difficulty in conducting tests due to health and safety issues in relation to the use mineral based oil mists, toxicity and flammability.

**.3 List of non-IACS Member classification societies contributing through the TC Forum and/or participating in IACS Working Group:**

None

**.4 History of Decisions Made:**

None

**.5 Other Resolutions Changes**

None

**.6 Dates:**

Original Proposal: 5 July 2010 Made by a Member  
 Panel Approval: 2 February 2015 by Machinery Panel  
 GPG Approval: 22 February 2015 (Ref: 11045\_IGj)

- **Corr.1 (Oct 2007)**

Contracted for Construction – Standard footnote added (Ref: 7546aIGa).

No Technical Background Document available.

- **Rev.1 (Oct 2006)**

Changes to address CIMAC concerns and remove errors/ambiguities (Ref: Machinery Panel Task PM5105 & GPG ref: 4069gIGp).

Refer Technical Background in Part B, Annex 3 for details.

- **Corr.1 (Nov 2005)**

Refer Technical Background in Part B, Annex 2 for details (GPG ref: 4069g).

- **New (Jan 2005)**

Refer Technical Background in Part B, Annex 1 for details.

## Part B. Technical Background

List of Technical Background (TB) documents for UR M67:

Annex 1. **TB for New (Jan 2005)**

See separate TB document in Annex 1.



Annex 2. **TB for Corr.1 (Nov 2005)**

See separate TB document in Annex 2.



Annex 3. **TB for Rev.1 (Oct 2006)**

See separate TB document in Annex 3.



Annex 4. **TB for Rev.2 (Feb 2015)**

See separate TB document in Annex 4.



*Note: No Technical Background (TB) document is available for Corr.1 (Oct 2007).*

## Technical Background

### Revision UR M9 (Rev.3) and M10(Rev.2) New URs (M 66 & M67) for Type Testing Crankcase Explosion Relief Valves and Oil Mist Detection Arrangements

1. WP/MCH Task 55 was established to review the requirements in URM9 “Safety valves for crankcases of internal combustion engines” and M10 “Protection of internal combustion engines against crankcase explosions” for applicability and suitability to modern diesel engines.
2. The work specification included the following:
  - Review crankcase explosion reports for the past 10 years.
  - Review SOLAS requirements applicable to diesel engine crankcase safety.
  - Establish philosophy for a holistic approach to crankcase safety.
  - Consider the applicability of the safeguards in M9 and M10 for crankcase to all types of modern diesel engines – (high speed, medium speed and large slow speed engines + “large” and “small” bore engines).
  - Propose a set Unified Requirements for crankcase safety that include:
    - Requirements for submission of plans and particulars
    - Assessment of engine arrangements
    - Design of equipment
    - Testing of equipment and safety arrangements
    - Type testing requirements
    - Monitoring arrangements
    - Protection of engine and personnel
    - Through life survey and inspection
3. The background to the task was that there have been a number of serious incidents involving crankcase explosions in large diesel engines in the past 5-6 years that have resulted in loss of life and major damage to ships and their machinery. Questions have been raised regarding the adequacy of current standards for crankcase safety with engine builders and ship-owners pressing for revision/re-assessment of the current the standards that essentially stem from the Reina del Pacifico incident in 1947.
4. UR M9 has been extended to address design requirements for explosion relief valves in terms of a required provision of a flame arrester that prevents the passage of flame following a crankcase explosion and for valve to be type tested. The possible effects of shielding on relief valve efficacy have been recognised with a requirement for testing if such shielding is fitted.
5. The revised M9 also includes requirements for a manufacturer’s installation and maintenance manual with instructions installation, maintenance and actions required to be followed after a crankcase explosion. Requirements for marking of the valves have also been included.

6. UR M10 has been revised to remove requirements for the explosion relief valve (moved to M9) and clarify the existing text. The revised M10 now includes requirements for type testing of oil mist detection/monitoring systems and compliance with the oil mist manufacturer's instructions. Requirements for arrangements and installation onto the engine have been defined and also for system testing.

7. UR M10 also addresses alternative methods of preventing the build-up of oil mist and methods of assessment.

8. To support the extensive revisions to M9 and M10 new Unified Requirements for type testing explosion relief valves and for oil mist monitoring/detection arrangements have been developed. These URs provide a common standard against which relief valves and oil mist monitoring/detection systems can be assessed. They define the scope, purpose, test facilities, processes, assessment and reporting.

Note by the Permanent Secretariat:

1. GPG added the following implementation statement to the URs:

"Engines are to be fitted with components and arrangements complying with this UR when:

- 1) an application for certification of an engine is dated on/after 1 January 2006; or
- 2) installed in new ships for which the date of contract for construction is on or after 1 January 2006."

2. The URs (M 66 & 67, M9(Rev.2) and M20(Rev.3)) do not apply to existing engines on the existing ships.

Submitted by WP/MCH Chairman 24<sup>th</sup> August 2004



**Technical Background Document**  
**UR M9(Rev.3, Corr.1, November 2005)**  
**UR M10(Rev.2, Corr.1, November 2005)**  
**UR M66(New, Corr.1, November 2005)**  
**UR M67(New, Corr.1, November 2005)**

1. These UR Ms were adopted in Jan 2005 for implementation from 1 Jan 2006.
2. However, IACS was requested, via the Machinery Panel, by CIMAC and MAN/B&W, to postpone the 1 Jan 06 implementation date for the type testing requirements for crankcase explosion relief valves and crankcase oil mist detection/monitoring and alarm arrangements contained in IACS URs M66 and M67, respectively.
3. This discussion led to re-issuance of these UR Ms, changing the implementation statements.

These UR Ms were re-issued as 'Corr.1' on 29 Nov 2005.

4. GPG Chairman's message (4069glGk, 14/11/2005) contains a more detailed background for this amendment.

For records, GPG/Council Chairmen's messages are attached to the TB document for the January 2005 versions.

Permanent Secretariat  
29 Nov 2005

**GYH**

---

**From:** AIACS@eagle.org  
**Sent:** 23 November 2005 20:50  
**To:** iacs@bureauveritas.com; iacs@ccs.org.cn; iacs@dnv.com; iacs@gl-group.com;  
 krsiacs@krs.co.kr; iacs@lr.org; clnkiacs@classnk.or.jp; iacs@rina.org; iacs@rs-head.spb.ru;  
 johnderose@iacs.org.uk; colinwright@iacs.org.uk; gilyonghan@iacs.org.uk;  
 terryperkins@iacs.org.uk; efs@iacs.org.uk; richardleslie@iacs.org.uk;  
 helenbutcher@iacs.org.uk; MCH-Panel@gl-group.com  
**Subject:** 4069glCd: UR M66, M67 - application date

Date: 23 Nov 05

TO: IACS Council Members

TO: IACS GPG Chairman & Members

TO: IACS Permanent Secretary: Mr. R. Leslie

TO: IACS Machinery Panel Chairman: Dr. U. Petersen

FROM: R. D. Somerville

File Ref: T-12-2

Subject: 4069glCd: UR M66, M67 - application date

1. All Members have replied to ICc. Eight Members have supported the proposed course of action in IGk.
2. Lloyd's, supported by RINA, proposes that the URs need not be withdrawn, as proposed in IGk, but that only the implementation date need be changed. LR proposed posponement to 1 July 06 -- instead of 1 Jan 07, as proposed in IGk.
  - 2.1 Regarding the implementation date of 1 July 06 vs. 1 Jan 07, this had already been debated in GPG and the strong majority supported 1 Jan 2007. I conclude 1 January 2007 is agreed.
  - 2.2 Regarding whether to "withdraw" the URs or "postpone" their date of application, to my understanding either approach is acceptable and will result in the same outcome.
3. Therefore to accomodate the request that the URs not be withdrawn, I conclude that the agreed course of action is:
  - 3.1 **Perm Sec** is to revise the uniform application statements for the URs, as follows, reissue them, and post them on the IACS website:
    - 3.1.1 For URs M66 and M67:
 

"Note: Engines are to be fitted with components and arrangements complying with this UR when:  
 1) an application for certification of an engine is dated on/after 1 January 2007; or  
 2) installed in new ships for which the date of contract for construction is on or after 1 January 2007."
    - 3.1.2 For UR M9, Rev.3:
 

"2. Engines are to be fitted with components and arrangements complying with Revision 3 of this UR, except for M9.8, when:

- 1) an application for certification of an engine is dated on/after 1 January 2006; or
  - 2) installed in new ships for which the date of contract for construction is on or after 1 January 2006.
- The requirements of M9.8 apply, in both cases above, from 1 January 2007."

3.1.3 For UR M10, Rev.2:

"2. Engines are to be fitted with components and arrangements complying with Revision 2 of this UR, except for M10.8, when:

- 1) an application for certification of an engine is dated on/after 1 January 2006; or
  - 2) installed in new ships for which the date of contract for construction is on or after 1 January 2006.
- The requirements of M10.8 apply, in both cases above, from 1 January 2007."

3.2 **Machinery Panel** is to:

- a. inform CIMAC and MAN/B&W of the postponed application of URs M66 and M67, and the intention to update them;
- b. update URs M66 and M67, as quickly as possible, taking account of CIMAC's, MAN/B&W and Panel Member's inputs;
- c. once adopted at Panel level, send the revised URs to CIMAC for quick review/comment and notification to the equipment suppliers;
- d. further update the URs as needed in light of any comments received from CIMAC;
- e. submit the revised URs to GPG for approval not later than the end of the 1st Q 2006.

3.3 Upon adoption of the revised URs by IACS Council, **Machinery Panel** is to send them to CIMAC for their information and requesting that CIMAC notify the equipment suppliers of the requirements.

Regards,

Robert D. Somerville

IACS Council Chairman

email protected and scanned by BIS Advanced Spam & Virus Checking - powered by AdvascanTM  
- keeping email useful

**GYH**

---

**From:** AIACS@eagle.org  
**Sent:** 14 November 2005 22:00  
**To:** iacs@bureauveritas.com; iacs@ccs.org.cn; iacs@dnv.com; iacs@gl-group.com;  
krsiacs@krs.co.kr; iacs@lr.org; clnkiacs@classnk.or.jp; iacs@rina.org; iacs@rs-head.spb.ru;  
johnderose@iacs.org.uk; colinwright@iacs.org.uk; gilyonghan@iacs.org.uk;  
terryperkins@iacs.org.uk; efs@iacs.org.uk; richardleslie@iacs.org.uk;  
helenbutcher@iacs.org.uk  
**Cc:** MCH-Panel@gl-group.com  
**Subject:** 4069IGk: UR M66, M67 - application date

Date: 14 Nov 05

TO: Mr. R.D. Somerville, IACS Council Chairman

CC: IACS Council Members  
CC: IACS GPG Members

CC: IACS Machinery Panel Chairman: Dr. U. Petersen

CC: IACS Permanent Secretary: Mr. R. Leslie

FROM: S.R. McIntyre

File Ref: T-12-2

Subject: 4069IGk: UR M66, M67 - application date

1. IACS has been requested, via the Machinery Panel, by CIMAC and MAN/B&W, to postpone the 1 Jan 06 implementation date for the type testing requirements for crankcase explosion relief valves and crankcase oil mist detection/monitoring and alarm arrangements contained in IACS URs M66 and M67, respectively. Their request is to give the equipment manufacturers and the engine builders more time to adapt to the new requirements. Industry has also recommended the need for some improvements/clarifications in the two URs, which the Machinery Panel has agreed are needed/appropriate.

1.1 Since CIMAC was involved in the IACS decision, some years ago, to develop these URs, in retrospect it would have been advisable to submit the URs for external review by CIMAC before their adoption to ensure that CIMAC would be fully aware of the requirements and the timetable for their implementation--and working with IACS Societies to ensure that their suppliers were apprised of and complying with the new requirements. Unfortunately, this was not done.

1.2 The type testing requirements of URs M66 and M67 are invoked in recent revisions of M9 and M10, respectively.

2. The Machinery Panel recommended that GPG postpone implementation of URs M66 and M67 and advised GPG that both URs need to be updated/clarified.

2.1 Several Members have also advised that they needed more time for initial implementation and could not implement the two URs from 1 Jan 06 as had been originally agreed by Council.

3. Having carefully considered the input from CIMAC, MAN/B&W, the Machinery Panel and Members, GPG agrees that IACS should postpone the implementation of these URs by one year to give time for updating them, vetting the changes with CIMAC, notifying industry and for Members to process the related rule changes. Therefore, GPG requests Council's agreement to the following course of action:

3.1 URs M66 and M67, along with M9.8 of M9, Rev.3 and M10.8 of M10, Rev.2 are to be withdrawn pending the updating of M66 and M67, which needs to be accomplished as quickly as possible (ie. the target date of 1st Q 2006 for revising M66, agreed at GPG 59, needs to be accelerated);

3.2 The updated URs, once adopted at Panel level are to be sent to CIMAC by the Machinery Panel for quick review/comment by CIMAC, and then further updated by the Panel in light of any comments received, prior to submission to GPG/Council;

3.3 The updated URs M66 and M67, once adopted by GPG/Council, are to be issued as "Corr" (since the initial versions will never have been implemented)--with uniform application from 1 Jan 2007 (instead of 1 Jan 2006);

3.4 M9, Rev.3 without M9.8, and M10, Rev. 2, without M10.8, are to be reissued as "Corr" until the updated M66 and M67 are adopted by Council, at which time M9.8 and M10.8 are to be included in M9, Rev.4 and M10, Rev.3, respectively for application from 1 Jan 2007.

4. Council Chairman is kindly requested to seek Council's agreement to this course of action as soon as possible.

Regards,

S.R. McIntyre

IACS GPG Chairman

email protected and scanned by BIS Advanced Spam & Virus Checking - powered by AdvascanTM  
- keeping email useful

## Technical Background

### Revision UR M9 (Rev.3) and M10(Rev.2) New URs (M 66 & M67) for Type Testing Crankcase Explosion Relief Valves and Oil Mist Detection Arrangements

1. WP/MCH Task 55 was established to review the requirements in URM9 “Safety valves for crankcases of internal combustion engines” and M10 “Protection of internal combustion engines against crankcase explosions” for applicability and suitability to modern diesel engines.
2. The work specification included the following:
  - Review crankcase explosion reports for the past 10 years.
  - Review SOLAS requirements applicable to diesel engine crankcase safety.
  - Establish philosophy for a holistic approach to crankcase safety.
  - Consider the applicability of the safeguards in M9 and M10 for crankcase to all types of modern diesel engines – (high speed, medium speed and large slow speed engines + “large” and “small” bore engines).
  - Propose a set Unified Requirements for crankcase safety that include:
    - Requirements for submission of plans and particulars
    - Assessment of engine arrangements
    - Design of equipment
    - Testing of equipment and safety arrangements
    - Type testing requirements
    - Monitoring arrangements
    - Protection of engine and personnel
    - Through life survey and inspection
3. The background to the task was that there have been a number of serious incidents involving crankcase explosions in large diesel engines in the past 5-6 years that have resulted in loss of life and major damage to ships and their machinery. Questions have been raised regarding the adequacy of current standards for crankcase safety with engine builders and ship-owners pressing for revision/re-assessment of the current the standards that essentially stem from the Reina del Pacifico incident in 1947.
4. UR M9 has been extended to address design requirements for explosion relief valves in terms of a required provision of a flame arrester that prevents the passage of flame following a crankcase explosion and for valve to be type tested. The possible effects of shielding on relief valve efficacy have been recognised with a requirement for testing if such shielding is fitted.
5. The revised M9 also includes requirements for a manufacturer’s installation and maintenance manual with instructions installation, maintenance and actions required to be followed after a crankcase explosion. Requirements for marking of the valves have also been included.

6. UR M10 has been revised to remove requirements for the explosion relief valve (moved to M9) and clarify the existing text. The revised M10 now includes requirements for type testing of oil mist detection/monitoring systems and compliance with the oil mist manufacturer's instructions. Requirements for arrangements and installation onto the engine have been defined and also for system testing.

7. UR M10 also addresses alternative methods of preventing the build-up of oil mist and methods of assessment.

8. To support the extensive revisions to M9 and M10 new Unified Requirements for type testing explosion relief valves and for oil mist monitoring/detection arrangements have been developed. These URs provide a common standard against which relief valves and oil mist monitoring/detection systems can be assessed. They define the scope, purpose, test facilities, processes, assessment and reporting.

Note by the Permanent Secretariat:

1. GPG added the following implementation statement to the URs:

"Engines are to be fitted with components and arrangements complying with this UR when:

- 1) an application for certification of an engine is dated on/after 1 January 2006; or
- 2) installed in new ships for which the date of contract for construction is on or after 1 January 2006."

2. The URs (M 66 & 67, M9(Rev.2) and M20(Rev.3)) do not apply to existing engines on the existing ships.

Submitted by WP/MCH Chairman 24<sup>th</sup> August 2004

## Technical Background Document UR M67 Rev.1 (October 2006)

### Type Testing Procedure for Crankcase Oil Mist Detection and Alarm Equipment

#### Scope and objectives

UR M67 is currently issued as 'Corr.1' with an application from 1 January 2007. During discussions at the joint Machinery Panel/CIMAC meeting in September 2005 it was the common view that UR M67 requires some further improvements/ clarifications. Accordingly, a new task for the Machinery Panel was raised (PM5105) and the Panel tasked to revise M67 with a view to address CIMAC concerns and to remove errors and ambiguities.

#### Points of discussion or possible discussions

Changes to UR M67 are mainly of an editorial nature to clarify specific requirements. In the course of the review process comments were received from Schaller Automation, Maersk and Kidde Fire Protection UK (see Appendix). These were taken into consideration by the Panel in the review process. The following changes of a technical nature were made:

- 5.1.2 (j) Delete reference to moving parts as also other fluids in pipes or components may cause problems (Schaller comment)
- 8.1.3 Clarification of orientation and adding reference to equipment manufacturer's specification (Schaller and Maersk comment)
- 12.2.4 Clarification of Functionality tests (Maersk comment)

Regarding Maersk's comment on paragraph 5.1.1(j) the Panel considered that moving parts are those that are free to move when the equipment is inclined under static and dynamic ship movements. The terminology is consistent with that used for other equipment and stems from IACS UR E10 for inclination testing which is well understood by industry.

With respect to the requirement in paragraph 6.3 the Panel clarified the intention as follows:

- Paragraph 6.4 stipulates a maximum alarm set point of 5% of the LEL. In paragraph 6.3 the lower and upper detection limits are set to 0% and 10% respectively, the maximum detection limit hence corresponding to twice the maximum alarm set point.
- Should a manufacturer design an OMD with an oil mist concentration alarm set point below 5% (e.g. 3%) then the lower and upper detection limits are required to be 0% and twice the alarm set point respectively, in this example 6%.

The Panel at its 4<sup>th</sup> meeting (19 – 22 September 2006) examined the nature of the changes made and considered that the new requirements in 6.7 and 6.8 are of a technical nature rather than purely editorial. The changes are in response to feedback received from industry (Kidde Fire Protection and Schaller Automation). Consequently, a new Note 3 was added setting the implementation date for paragraphs 6.7 and 6.8 to 1 January 2008.

The draft text of the UR was sent to CIMAC on 21 July 2006 with a four week deadline for comments. As of 11 September 2006 no comments were received from CIMAC.

#### Source/derivation of proposed requirements

N/A



**Decision by Voting (if any)**

The revised text was agreed unanimously by Panel members.

**Appendix**

The following comments from industry were received in the course of the revision of M67 (attached):

- Kidde Fire Protection UK (25 April 2006)
- Schaller Automation (28 June 2006)
- Maersk (15 July 2006)

Machinery Panel Chairman

25 September 2006

**Permanent Secretariat Note:**

Subject no. 4069g – agreed by GPG and Council 10 October 2006 (IGp).

Commentary on M67 from Kidde.

Kidde is fully in support of the aims of M67 in its aim to test the ability of oil mist detectors for use in monitoring engine crankcases to perform to specification and withstand the expected environment. Kidde does, however, oppose the details of the testing methodology for good technical reasons. All currently approved oil mist detectors operate by detecting the effects of light scattered by the oil mist, either by detecting the scattered light directly or by detecting the reduction in intensity of a light beam projected through the mist. Thus, the detected signal is a measure of the light scattering properties of the oil mist and not a direct measure of the mass density of the oil mist. The relationship between the amount of light scattered and the mass density is a complicated function of particle size distribution in the mist, the physical properties of the oil and the wavelength of light used to make the measurement. In particular, the particle size distribution has a strong effect and this can be changed by the chemical composition of the oil, the temperature of the hot surface from which it is evaporated and the environmental conditions in and around the oil mist detector. The particle size distribution of an aerosol, of which an oil mist is an example, can also undergo changes with time after formation due to evaporation, agglomeration or settling. Testing any detector against an oil mist quantified in terms of mass density, therefore, introduces a number of uncertainties which can change the apparent sensitivity of the detector when its properties have remained stable. This problem has been addressed over many years in the approval testing of smoke detectors (an oil mist detector can be considered as a special class of smoke detector) and the agreed methodology is to use an obscuration meter of defined type as a reference instrument. A suitable device is defined, for example, in BS EN 54-7:2001 Annex C. This has the additional advantage of making calibration measurement much more precise, convenient and with continuous real time output. Apart from the uncertainties described above, aerosol mass density measurements by filter sampling is difficult experimentally, relatively time consuming and only provides an average measurement over the sampling period.

Of course, in order to calibrate oil mist detectors against an obscuration meter, an agreed calibration of the meter to oil mist mass density under a set of defined conditions needs to be defined. At present, each manufacturer has their own calibration, obtained under different conditions at different test sites, which have been maintained over long periods. It would be useful to the industry and would increase the confidence of end-users if such a calibration was carried out by an independent laboratory under the direction of the IACS.

Dr Brian Powell



## Remarks / Questions to the Unified requirements M67 of IACS:

### Type Testing Procedure For Crankcase Oil Mist Detection/Monitoring and Alarm Arrangements

3.1.5 *To verify time delays between mist extraction from crankcase and alarm activation*

Time between injection of oil mist and alarm or leaving the engine and alarm?

5.1.2 *Range of tests for the detectors*

(i) *Static and dynamic inclinations, if moving parts are contained*

Not only mechanical moving parts can produce problems under certain inclinations of the ship (engine) but also fluids like water or oil inside the device or pipes.

6. *Functional test process*

6.2 *The concentration of oil mist in **the test vessel** is to be measured in the top and bottom of the vessel and is not to differ by more than 10%*

Test vessel, a container, filled with oil mist?

Acc. 4.1.1.4 of the UR M67 it's necessary to have more than 2 m<sup>3</sup> of oil mist, only to check the oil mist concentration inside the vessel?

Other methods, to produce oil mist with a certain concentration are allowed, for e. to evaporate a certain quantity of oil in a box with a certain volume?

6.3 *....The LEL corresponds to an oil mist concentration of approximately 50mg/l (**13% oil-air mixture**)*

13% = V%? Calculation is not clear

8.1.2.1 *Oil mist detection / Monitoring devices are to be tested in the orientation in which they intended to be installed on an engine or gear case.*

Under consideration of the possible inclination?

8.1.2.2 *Type testing is to be carried out for **each range of oil mist detection/monitoring devices** that a manufacturer requires classification approval*

Range = type of oil mist detectors or diff. sensitivity levels on an oil mist detector?

# E-mail

**To:** IACS Limited. **Date:** 14 July 2006  
**Attn.:** Mr. Richard Leslie **Our ref.:** General-05/00738-0084  
**E-mail:** permsec@iacs.org.uk **Your ref.:** Oil Mist Detectors  
**C.c.:**

---

Dear Sirs,

## **IACS UR M10 & UR M67**

We have been studying your unified requirements M10 & M67.

We do not feel that these documents are describing their intension sufficiently. We have therefore made some comments and questions to the individual paragraphs where definitions or descriptions need to be improved. Please see attachment.

We will appreciate if you can bring these comments to the right forum and look forward to get a feedback.

We are at your disposal if further clarification to our comments is needed.

Yours faithfully,  
for MAERSK SHIP DESIGN A/S

Søren P. Arnberg

/Per Hother Rasmussen

**Head Office:**  
Postal Address: 50, Esplanaden, DK-1098 Copenhagen K  
Office Address: 45 3<sup>rd</sup> floor, Amaliegade, DK-1256 Copenhagen K  
Phone: +45 3363 3363 • Fax: +45 3363 5830  
E-mail: cphmsd@maersk.com

**Odense Office:**  
Postal Address: P.O. Box 70, DK-5100 Odense C  
Office Address: 150, Lindoe Alleen • DK-5330 Munkebo  
Phone: +45 6397 2100 • Fax: +45 3363 5830  
E-mail: cphmsd@maersk.com

## **IACS Unified Requirements M10 / M67 questions / comments.**

### **M10.12**

We understand it as one central covering more engines is acceptable, when alarm indication is clearly showing which engine is having the alarm / shut-down condition.

### **M10.13**

Acceptable test procedures.

We find that the Class Societies shall define / describe the test procedures required in order to ensure uniform acceptance by the various surveyors attending.

A smoke test shall be performed at shop trial for every engine equipped with an oil mist detector.

### **M10.15**

“Provide an alarm indication in the event of a foreseeable functional failure”

Does that cover the wording used in e.g. LR Part 6, Chapter 1, section 2.4.6 ?

“The safety system is to be designed to “fail-safe”. The characteristics of the “fail-safe” operation are to be evaluated on the basis not only of the safety system and its associated machinery, but also the complete installation. Failure of a safety system is to initiate an audible and visual alarm.”

### **M10.19**

Please see comments for M10.13

### **M10.20**

“Time to be as short as reasonable practicable”

We find that a maximum time elapsing from mist generation starts until detector reacts on same should be defined. Could e.g. be 10 secs from any point of detection on an engine.

### **M67-5.1.1 j**

Static and dynamic inclinations, if moving parts are contained.

Kindly specify what is understood as a “moving” part.

### **M67-8.1.2.1**

Operating orientation, detector shall be able to operate in both operating directions.

### **M67-12.2.4 b**

Maintenance & test manual, Functionality tests.

How to make a test as realistic as possible? (M10.19)

## Technical Background for UR M67 (Rev.2, Feb 2015)

### 1. Scope and objectives

The review of M67, Type Testing Procedure for Crankcase Oil Mist Detection and Alarm Equipment identified the following concerns:

- Toxicity of mineral oil mists;
- Difference in alarm set point requirements between obscuration and light scattering detection methods;
- Test required to demonstrate detection of an obscured sensor as required by M10.16;
- Sedimentation method used to calculate oil droplet is prone to error;
- Gravimetric method for oil mist droplet density requires clean laboratory conditions;
- The specification does not clearly record the sensitivity or precision of the sensor;
- The "dirty oil" to test for obscuration is imprecise;
- Test chamber temperature is as not recorded;
- No self-test requirement;
- No standard test report.

### 2. Engineering background for technical basis and rationale

#### INTRODUCTION

The initial research into crankcase explosions and oil mist was funded by The British Internal Combustion Engine Research Association (BICERA) and the British Shipbuilding Research Association (BSREA) in 1950s. Most subsequent research has been more general looking into the behaviour of aerosols. Research into the carcinogenic effect of mineral based oil mists has led to strict exposure limits being set in a number of countries, including UK and USA.

#### OIL MIST

Early experiments found:

- Oil mist created is when oil in droplet or liquid vaporises on contact with a hot surface. On cooling a mist (cloud of droplets) forms, like a meteorological fog, it may stratify due to temperature variations in the space.
- Oil mist forms with a droplet size mainly  $< 20\mu\text{m}$ ;
- Lower Explosion Limit almost constant for droplets in the range  $0.4\mu\text{m}$  to  $21.6\mu\text{m}$  ( $48.6\text{ mg/L}$  to  $55.8\text{ mg/L}$ ) and is effected by:
  - o Droplet size
  - o Oil mist density
  - o Volatility of oil
  - o Ambient temperature; a  $23^\circ\text{C}$  to  $100^\circ\text{C}$  rise increases the velocity by 30%
- No Upper Explosive Limit has been established; even very dense mists propagate flames.

Definitions for different oil mists are:

- $< 1\mu\text{m}$  "smoke", blue. Formed from contact with hot surface,  $> 800^\circ\text{C}$ ;
- $1 - 10\mu\text{m}$ , "mist", white. Mechanically generated, at between  $200^\circ\text{C}$  and  $600^\circ\text{C}$ ;
- $> 50\mu\text{m}$  "spray", mechanically generated, e.g. from damaged pipe work.

#### Oil Mist Combustion

There is no single theory for the combustion of aerosols and sprays. The main theories found were:

- Evaporation of droplets;

- Turbulence;
  - Flame propagation in aerosols.
- The following key points are made across the research reviewed;
- Smaller droplets evaporate quickly before the flame front and eventually burn as gas;
  - Mid-sized droplets completely burn in their own gas atmosphere; and
  - Large droplets burn only partially on the surface and a drop of the core is left unburned.
  - Flame front propagation is effected by:
    - heat transfer between droplets, which is related to droplet size and distance;
    - Volatility and its density, which also affect "rain out" due to gravity;
  - The oil/ air ratio defines whether explosion is possible;
  - Oil mists explosions can occur with hotspots of 650°C;
  - Increasing oil mist density and temperature increases the power of explosions but not the frequency;
  - Usual temperature at which explosions occurred is at around 820°C;
  - It is the presence of vapour and not droplets, which determines ignitability;
  - Some research suggests that it may be the ignition of gasses rather than oil vapour or mist that leads to explosions;
  - Age of Oil has not been found to have any effect.

### **Delayed ignition**

- Research shows there are two areas of spontaneous combustion for two distinct temperature ranges for a range of oil mist vapour densities.
  - ~270°C to 350°C for 13 to 18% air/ oil ratios;
  - ~350°C to ~ 400°C dead band where no ignition occurs;
  - ~400°C upwards with air/ oil ratios of 4 to 17%.
- This may explain reports where ignition has occurred after the oil mist has been detected and engines have been slowed or shutdown.
- Oxidation and cracking of the oil due to temperature leads to gasses and vapours more dangerous than oil mist. The movement of air on restarting an engine can cause the gases to ignite on contact with hot surfaces.

### **Engine size**

The likelihood of an explosion in a small engine is less than a large engine and is thought to be due to increased relative surface area cooling and mass of metal to receive heat.

### **OIL MIST DETECTORS**

There are two main types of OMD:

- Light scattering devices have a linear output and therefore can present a real-time measurement of the oil mist concentration;
- The obscuration devices detect a percentage obscuration. By comparing deviations from average values for an engine, an alarm is triggered when the alarm level is exceeded;

To determine the performance of an OMD the following needs be known:

- Oil droplet size: to verify that the oil mist is representative of the oil mists found within engine crankcases;
- Oil mist concentration, to benchmark OMD under test against.

### **Determination of droplet size**

The measurement of droplet size is a complex process and prone to experimental error. The difficulties encountered are:

- Variation in droplet size;
- Range of speeds of the droplets;
- Changes on droplet size with time due to coalescence.

The two main methods of determining the size of droplets are sedimentation or optical methods. These methods do not produce identical results; this is thought to be due to the differences in the rate of coalescence of oil droplets. The optical methods report smaller droplet size compared with the sedimentation method.

### **Sedimentation method**

This yields an average droplet size value using Stokes Law, which relates the radius of the droplet to the droplet settling velocity, the force acting upon the droplets, the viscosity of the carrier medium and the difference in densities of the oil droplet and the carrier medium.

To minimise boundary the effects of the tank walls, convective currents and thermal gradients a volume of at least 1m<sup>3</sup> is needed. A high density of oil mist is needed to ensure the boundary layer of the mist can be easily seen. 30 to 60 minutes are needed to ensure accurate results, and need to be repeated at least 3 times to ensure consistent results have been obtained. The ambient temperature also has an effect.

### **Optical methods**

A number of different techniques exist such as Photo Analysis, Laser diffraction, Phase Doppler, Mie Light Scattering; which are available as commercial laboratory equipment. Their cost is considerably higher compared to the sedimentation tank. They do enable a significantly smaller test volume, whilst accurately determining the droplet size distribution. Optical methods can use a number of numerical methods to calculate the droplet size. For comparison with the sedimentation method, the arithmetic mean diameter should be used.

### **Determination of Oil Mist Concentration**

A number of different methods can be used to calculate the oil mist concentration:

- Gravimetric Method: A known volume of oil mist is drawn through a filter, which is then weighed. This requires specialist scales and rigorous environmental controls to prevent contamination of the sample;
- Volumetric method: A known volume of oil used to generate the oil mist and to calculate the density of oil mist;
- Flow method: A flow meter calculates the volume of oil mist injected into the test volume.

Variations in coalescence are believed to accounts for the discrepancies between the methods.

## **SAFETY ISSUES ASSOCIATED WITH OIL MIST**

### **Health Effects**

Mineral based oil mists are carcinogenic. The UK and US regulatory bodies have set "permissible exposure limits" of 0.005mg/litre, to be time weight averaged over an 8-hour period. The UK has set short term exposure limits of 15 minute exposure limit of



0.01 mg/L, limited to 4 times per day, with a minimum interval between exposures of 60 minutes. These levels are considerably below the levels required for OMD testing. Commercial smoke generators used for fire and accident simulation and film and drama productions use low toxicity oils, with PEL well below that of mineral oils reducing the hazard and allowing much greater exposure levels and times. These oils are available in a range of viscosities including ones equivalent to the SAE 40 specified by UR M67.

### **Risk of Explosions**

There is a possibility that during testing the LEL could be exceeded and an explosion could occur. The use of "white" oils, with aromatics removed, greatly reduces the risk. The use of either a 28.3% carbon dioxide or 45% nitrogen enrichment increases the LEL to a level where explosions are not possible. Nitrogen with a density close to air is preferred as it has less impact on the dynamics of the oil mist.

## **TEST EQUIPMENT**

### **Oil Mist Generator**

There is a range of methods for creating oil mist: dropping defined quantity oil onto a "hot plate", temperature controlled crucible; or pneumatic oil mist generators as used in stage productions and fire simulators.

Commercial oil mist generators can produce oil mists with a known initial droplet size of 0.2 to 5  $\mu\text{m}$ . Droplet sizes rapidly change after creation due to coalescence.

### **Test Chamber**

When the sedimentation and gravimetric methods are to be used, a minimum 1m<sup>3</sup> test chamber is needed to minimise boundary effects. Smaller volumes may be acceptable with optical methods.

## **3. Source / derivation of the proposed IACS Resolution**

Feedback from a manufacturer raising the issue of oil mist hazards preventing testing to M67. This prompted a research exercise into addressing issues associated with toxicity and flammability of oil mist during testing, and other issues as identified during investigation.

## **4. Summary of Changes intended for the revised Resolution**

### **AMENDMENTS TO UR M67**

#### **6.3 Detector Span Range**

The current range specified is not appropriate for OMDs using light scattering techniques. The setting of the alarm limit is dependent upon the detector location, engine arrangement and vessel type, which all impact the degree of background oil mist within the sump of the engine. An oil mist concentration range should be specified that it is suitable for both optical and obscuration modes of detection.

#### **7.2 Lens obscuration**

Detector and alarm equipment to be tested, clause 7.2 to be amended to require repeatable method of lens obscuration to be used. And at a level which will

prevent false alarms, which can lead to operator complacency and a failure for the system to detect dangerous levels of oil mist. The manufacturer is to define the percentage obscuration to be used and provide an independent report verifying the obscuration medium.

## 8 Method

8.1.1.1 Test Oil: Acceptance use of nontoxic oils with equivalent viscosity and density properties to SAE 40 monograde mineral oil.

Test Chamber: Minimum size to be 1m<sup>3</sup>.

Maximum Oil Mist Droplet Size: Alternative means of droplet sizing should be accepted, the method used to be declared.

- Atmosphere/propellant of oil mist to take into account the associated explosion risk;
- Droplet size <20µm with an average value of 5µm.

## **NEW REQUIREMENTS**

### 6.6 OMD Specification

Accuracy, precision, resolution, resolution and response time to be assessed as part of the type testing. This will help define the performance of OMDs and assist ensuring a level playing field between manufacturers.

Definitions taken from the Joint Committee for Guides in Metrology (JCGM)

- Accuracy: accuracy of measurement, accuracy closeness of agreement between a measured quantity value and a true quantity value of a measurand.
- Precision: precision closeness of agreement between indications or measured quantity values obtained by replicate measurements on the same or similar objects under specified conditions.
- Sensitivity of a measuring system: sensitivity quotient of the change in an indication of a measuring system and the corresponding change in a value of a quantity being measured.
- Resolution: smallest change in a quantity being measured that causes a perceptible change in the corresponding indication.
- Response time: the time between measurand being measured and detector indicating a change.

6.10 Self test: An alarm to indicate system failure either a through build-up of dirt or component failure to be required.

6.4 Alarm set points to be set allowed, appropriate to detector technology.

8 Ambient temperature: to be set at -15°C to 55°C.

9.1.2 Assessment: The maximum percentage level of lens obscuration to be recorded.

11 The Report: common test report with OMD performance details to be included on Class Societies type approvals certificate. The report to include the following:

- Serial numbers of sample sensors and associated control and monitoring equipment under test;

- Serial numbers and calibration certificates of test equipment used;
- Specification of test oil used;
- Oil mist propellant, if used;
- Ambient temperature of test;
- Performance of OMD in mg/L;
- Accuracy of OMD;
- Precision of OMD;
- Range of OMD;
- Resolution of OMD;
- Response time of OMD;
- Sensitivity of OMD;
- Obscuration of sensor detection, declared as percentage of obscuration. 0% totally clean, 100% totally obscure;
- Detector failure alarm;

## 5. Points of discussions or possible discussions

Paragraph	Summarised comments from industry and other IACS Members
General comments	
	Comments from a number of parties raised concerns over continued specification of SAE 80 grade oil and requested SAE 40 is specified and agreed by the panel.
	Comments from manufacturers – detailed in separate files held by the IACS Machinery Panel
Specific comments	
8.1.1.1	C. Proposed that a minimum height of the test chamber is stipulated as this is the critical factor in the sedimentation method. A value of 1.0 meter was proposed and implemented.
	C. Specify how oil mist is generated. A. Change not agreed as a single method could cause excessive costs to manufacturers.
	C. The temperature influences the lifetime of droplets significantly. Proposed to require a constant temperature in the chamber during tests (range 20 to 25 deg C. is suggested as practicable). A. It was agreed that the ambient temperature is to be set for the test chamber and its local environment prior to testing. It is practical to require the temperature to be controlled and monitored during testing. Commercial oil mist generators all appear to heat the oil, this includes commercial smoke generators. As such the temperature is likely to rise inside the chamber. The temperature is likely to vary dependent on the device used.
	C. The term “or equivalent” should be removed, unless the scope of equivalency is defined. A. This was not implemented as the scope is already linked to viscosity.

	<p>C. Information on the on importance of droplet size? Engine oil mists appears to be given as in the range of 1 to 20 microns, but how important is it for detector testing? The smaller the droplet size the greater the obscuration, the explosion risk appears to be fairly constant up to 20 microns. Droplet size in crankcases said to be typically 1 to 13 microns. Total obscuration of a light source from a few cms away occurs at 4-5mg/L.</p> <p>A. A droplet size &lt; 5 µm is considered as most important contributor to fire. Therefore, the detector is to be tested to verify the exact indication of this droplet size.</p> <p>The droplet size of the oil mist used for the test is an important parameter to be regulated in the UR; considering that "The smaller the droplet size the greater the obscuration", the minimum droplet size should have to be established (to test the sensor on worst case) instead of the "maximum droplet size of 5 um"</p> <p>Immersion methods have been accepted as an alternative method for measuring droplet sizes based upon meeting with manufacturers.</p> <p>Both of the sedimentation method and direct measure method can be used to measure droplet sizes.</p>
	<p>C. What, if any, alternatives to the sedimentation method have been used for measuring droplet sizes? What was the basis for acceptance?</p> <p>A definition for "suitable equivalent" to sedimentation method should be given. (Alternatively replace by "sedimentation method or other methods traceable to recognized standards or referable to the sedimentation method"; a metrology expert should give his advice in this respect).</p> <p>A. Both of the sedimentation method and direct measure method can be used to measure droplet sizes.</p> <p>The terms "equivalent" and "equivalence" are used in the Oct 2007 version of the UR. It is considered that there are no problems with requiring equivalence as it is the responsibility of those proposing alternatives to demonstrate that what they are proposing has equivalent properties etc.</p> <p>The extent to which application of the sedimentation method has been used is unclear; calibration records of the distribution of droplet sizes have been accepted.</p>
	<p>C. The Gravimetric method is too complicated to calculate density of oil mist, an alternative method would be preferred.</p> <p>What, if any, alternative methods to the gravimetric method have been accepted for calculating density of oil mist? What was the basis for acceptance?</p> <p>A. Alternative methods have not been accepted so far. The gravimetric method has been used for all tests, and no application for an alternative in this respect was reported.</p>
6.3	C. Original rationale behind twice the alarm set point range

	<p>requirement?</p> <p>A. In order to ensure a high accuracy at 5% (2.5 mg/l) the measurement range shall be from 0 ~ 10% LEL.</p> <p>Accuracy of the measurements (scale),</p> <p>Generally, in the instrument and meter industry, accuracy <math>\pm 10\%</math> means 10% of the full measuring range. But, there is no limitation of maximum measuring range (only minimum limitation in M67) , so if the alarm point is very low(for example, 1.0mg/l), but measuring range is very large(&gt;5.0mg/l), the accuracy at alarm point is very low(<math>\pm 0.5</math> at 1.0mg/l, i.e. <math>\pm 50\%</math>), and mis-alarm can easily to happen.</p> <p>If design accuracy is <math>\pm 10\%</math> of the full measuring range, it is suggested that the maximum range is limited to twice the alarm set point.</p> <p>It is suggested that a requirement for accuracy at the concentration value corresponding to the alarm set point is established instead.</p>
6.4	The set point of 5% LEL has been chosen as having a safe margin to the 100% LEL because the OMDs are not explosion-proof.
6.6	Measurement delay should be required to OMD; it is suggested that the measurement delay of the OMD should not be longer than 5 seconds.

**6. Attachments, if any**

None.

# UR M68 “Dimensions of propulsion shafts and their permissible torsional vibration stresses”

## Summary

In Rev.3 of this Resolution, the way to refer to instruments other than those specified by IACS was unified.

## Part A. Revision History

Version no.	Approval date	Implementation date when applicable
Rev.3 (Feb 2021)	12 February 2021	1 July 2022
Rev.2 (Apr 2015)	14 April 2015	1 January 2017
Rev.1 (Aug 2014)	12 August 2014	1 July 2015
Corr.2 (Nov 2012)	22 November 2012	-
Corr.1 (Mar 2012)	21 March 2012	-
New (Feb 2005)	20 February 2005	1 July 2006

### • Rev.3 (Feb 2021)

#### 1 Origin of Change:

- Other (Update to comply with the required format when industry standards are referred to)

#### 2 Main Reason for Change:

There was a need to update this UR to comply with the following format when industry standards are referred to:

*[Standard Designation], [version/revision, if applicable], [year of publication]*  
 (examples: API Spec 2F, 6th Edition, 1997; ISO 4624, 2002), where  
 [version/revision, if applicable] and/or [year of publication] are decided by IACS  
 and  
 are not necessarily to be the current/latest version.

#### 3 List of non-IACS Member classification societies contributing or participating in IACS Working Group:

None

#### 4 History of Decisions Made:

None

**5 Other Resolutions Changes:**

None

**6 Any hinderance to MASS, including any other new technologies:**

None

**7 Dates:**

Original Proposal: 28 October 2019 (Ref: PM18939\_Imd)  
Panel Approval: 9 November 2020 (Ref: PM20906\_Imf)  
GPG Approval: 12 February 2021 (Ref: 20206dIGb)

• **Rev.2 (Feb 2015)**

**.1 Origin for Change:**

Suggestion by an IACS member

**.2 Main Reason for Change:**

To develop the approval requirements for the use of alloy steel which has a minimum specified tensile strength greater than 800 N/mm<sup>2</sup> for intermediate shaft material.

**.3 List of non-IACS Member classification societies contributing through the TC Forum and/or participating in IACS Working Group:**

None

**.4 History of Decisions Made:**

The Machinery Panel commented on revisions by correspondence and at regularly scheduled meetings.

**.5 Other Resolutions Changes**

None

**.6 Dates:**

Original proposal: 25 July 2011 *Made by:* Machinery Panel  
Panel Approval: 6 March 2015  
GPG Approval:

• **Rev.1 (Aug 2014)**

**.1 Origin for Change:**

Proposal by IACS Machinery Panel

**.2 Main Reason for Change:**

Outcome of the consequence assessment for Corr. 1 carried out under PM12913.  
Details provided in Part B.

**.3 List of non-IACS Member classification societies contributing through the TC Forum and/or participating in IACS Working Group:**

None

**.4 History of Decisions Made:**

This task was initiated based on PM11925 ("To revise UR M68.7-3 due to failure in the formula for stress concentration"), where the members unanimously agreed that formulae in the previous revision were wrong. UR M68.7 was updated accordingly.

GPG requested the Machinery Panel to assess possible impact on the products already approved in accordance with the former formulae in M68.7.

The consequence assessment and proposed changes to Footnotes 6) and 7) have been unanimously agreed.

**.5 Other Resolutions Changes**

None

**.6 Dates:**

Original proposal: 14 August 2012 Made by: Machinery Panel  
Panel Approval: 22 November 2013 (PM12913\_IMi)  
GPG Approval: 12 August 2014 (Ref: 12144\_IGf)

• **Corr.2 (Nov 2012)**

**.1 Origin for Change:**

Suggestion by Machinery Panel Chairman

**.2 Main Reason for Change:**

An error in M68.6 Table of k and ck factors for different design features was discovered and corrected as follows:

The column "longitudinal slot" under the heading "thrust shafts external to engines" moved under the heading "intermediate shafts with".

**.3 List of non-IACS Member classification societies contributing through the TC Forum and/or participating in IACS Working Group:**

None

**.4 History of Decisions Made:**



The proposed correction has been unanimously agreed.

**.5 Other Resolutions Changes**

None

**.6 Dates:**

Original proposal: 06 June 2012 *Made by:* Machinery Panel

Panel Approval: 06 June 2012

GPG Approval: 22 November 2012 (Ref. 12022\_IGh)

• **Corr.1 (Mar 2012)**

**.1 Origin for Change:**

Suggestion by an IACS member

**.2 Main Reason for Change:**

An error in a formula has been discovered which require correction.

**.3 List of non-IACS Member classification societies contributing through the TC Forum and/or participating in IACS Working Group:**

None

**.4 History of Decisions Made:**

The proposed correction has been unanimously agreed.

**.5 Other Resolutions Changes**

None

**.6 Dates:**

Original proposal: 03 January 2012 *Made by:* a Member

Panel Approval: 16 February 2012

GPG Approval: 21 March 2012 (Ref. 12022\_IGe)

• **New (Feb 2005)**

Refer to TB document in Part B Annex 1. No history file available.

\*\*\*\*\*

## **Part B. Technical Background**

List of Technical Background (TB) documents for UR M68:

Annex 1. **TB for New (Feb 2005)**

See separate TB document in Annex 1.

Annex 2. **TB for Corr.1 (Mar 2012)**

See separate TB document in Annex 2.

Annex 3. **TB for Rev.1 (Aug 2014)**

See separate TB document in Annex 3.

Annex 4. **TB for Rev.2 (Feb 2015)**

See separate TB document in Annex 4.

Annex 5. **TB for Rev.3 (Feb 2021)**

See separate TB document in Annex 5.

**Note:**

*There is no separate TB document prepared for Corr.2 (Oct 2012).*

## Technical Background for UR M68 New, Feb 2005

### WP/MCH Task 41

#### Technical Justification for revision of M33 M37 M38 M39 M48 and new UR M68

CIMAC established a working group (WG14) for the purpose of getting a unified practice among Classification Societies on the topic of shafting and permissible torsional vibrations.

This WG14 concluded the work by the end of 2002, however, with a more restricted scope than the original. The original scope included issues for both 4-stroke and 2-stroke plants, but it soon became clear that due to the limited time (all to be within 2002) only 2-stroke plants with fixed pitch propellers could be handled.

It was the intention of WG14 that the agreements of 2002 should be reflected in the rules of the participating societies.

During the IACS MCH meeting in London 2003, it was agreed that actions should be taken versus very old URs, meaning a) confirm b) revise or c) delete. Among other, the above mentioned URs were chosen because:

- All 5 UR are interconnected and partly repeat each other
- Reservations were made
- Several societies practiced considerable deviations from the UR
- WG14 had concluded on something different (for 2-stroke)
- Design features for controllable pitch propellers lacking

After revising the technical contents of the 5 URs, it was intended to merge them into one UR.

The 4-stroke issues of WG14 (that were not in the agreement of 2002) had little or no relevance for the revision of these URs which only dealt with shafts. Of that reason the revision should include all relevant kinds of shafts.

The draft UR replaces M33, M37, M38, M39 and M48.

Note: This UR applies to ships constructed for construction from 1 July 2006.

Submitted by WP/MCH Chairman  
21 Dec 2004

## Technical Background for UR M68 Corr.1, Mar 2012

### 1. Scope and objectives

It has been discovered that an error in the formula for stress concentration in slots commonly applied for OD shafts. The formula as stated in IACS UR68.7-3 should be updated accordingly.

The consequence is improved estimation of stress concentration in slots.

### 2. Engineering background for technical basis and rationale

The original formula, that was based on/verified by FEM parameter studies is as follows:

$$\alpha_t = 2,3 + 0,4 \frac{l-s}{\sqrt{tr}}$$

With intention of simplifying the equation, by only using parameters usually applied in shafting the following substitutions were made:

$$e = 2r \Rightarrow r = e/2$$

$$t = \frac{d-d_i}{2}$$

leading to the following equation:

$$\alpha_t = 2,3 + 0,4 \frac{l-s}{\sqrt{\left[\frac{d-d_i}{2}\right] \times \frac{e}{2}}}$$

$$\alpha_t = 2,3 + 0,8 \frac{l-s}{d \times \sqrt{\left(1 - \frac{d_i}{d}\right) \times \frac{e}{d}}}$$

however, by error it was applied  $0,4 \times \sqrt{2}$ , rather than  $0,4 \times 2$ .

Consequently the following formula has been stated and applied in the requirements:

$$\alpha_t = 2,3 + 0,57 \frac{l-s}{d \times \sqrt{\left(1 - \frac{d_i}{d}\right) \times \frac{e}{d}}}$$

leading to:

$$SCf = \alpha_{t(hole)} + 0,57 \frac{l-s}{d \times \sqrt{\left(1 - \frac{d_i}{d}\right) \times \frac{e}{d}}}$$

The correct formulae should be

$$SCf = \alpha_{t(hole)} + 0,8 \frac{l-s}{d \times \sqrt{\left(1 - \frac{d_i}{d}\right) \times \frac{e}{d}}}$$

**3. Source/derivation of the proposed IACS Resolution**

None

**4. Summary of Changes intended for the revised Resolution:**

Replace the original formulae with the amended formulae.

**5. Points of discussions or possible discussions**

None

**6. Attachments if any**

None

## Technical Background for UR M68 (Rev.1, Aug 2014)

### 1. Scope and objectives

Assess the possible impact on products already approved in accordance with the formula in UR M68.7

### 2. Engineering background for technical basis and rationale

It has proven difficult to do a detailed study of the consequences.

The following scope has been done:

- General consideration of increased notch factor and possible counter actions.
- Evaluation of slot design on delivered shafts
- Parameter study to evaluate the tabulated default notch factors applied in simplified method.

#### General consideration of increased notch factor and possible counter actions.

An increased stress concentration factor will increase the local stresses and hence reduce the permissible nominal stress level.

For an existing shaft where the stress concentration has proven to be higher than initially expected the fatigue lifetime will be reduced. It will have to be evaluated for each separate case if the expected lifetime still is within acceptable limits, as the lifetime also is influenced by the materials notch sensitivity and highly dependent on the occurring vibratory stresses (system dependent)

The high stress level occurs in the end of the slot and will result in fatigue cracks. To enable an early detection of cracks it could be recommended to have focus on the slot during shaft survey and to request crack detecting NDT in the slot end.

#### Evaluation of slot design on delivered shafts

A random selection of relative new shaft designs has been evaluated. (Characteristics as shown in table below).

l/d	e/d	di/d	alfat	scf_old	scf_new	scf increase	old C <sub>K</sub>	new C <sub>K</sub>	C <sub>K</sub> increase
0,76	0,10	0,39	2,16	3,71	4,33	16,81 %	0,39	0,33	-14,39 %
0,99	0,13	0,17	2,17	3,66	4,26	16,45 %	0,40	0,34	-14,13 %
0,84	0,09	0,43	2,17	4,02	4,77	18,62 %	0,36	0,30	-15,69 %
0,84	0,10	0,40	2,17	3,85	4,52	17,62 %	0,38	0,32	-14,98 %
0,84	0,10	0,40	2,17	3,85	4,52	17,62 %	0,38	0,32	-14,98 %
0,77	0,10	0,39	2,17	3,71	4,33	16,76 %	0,39	0,34	-14,36 %
0,84	0,09	0,36	2,16	3,91	4,62	18,05 %	0,37	0,31	-15,29 %
0,84	0,10	0,38	2,17	3,82	4,49	17,49 %	0,38	0,32	-14,89 %
0,70	0,12	0,39	2,18	3,39	3,88	14,40 %	0,43	0,37	-12,59 %
0,81	0,14	0,34	2,19	3,46	3,97	14,78 %	0,42	0,36	-12,88 %

Although the stress concentration is increased by 14-19% the shafts are still above the tabulated default  $C_K$  value of 0,3.

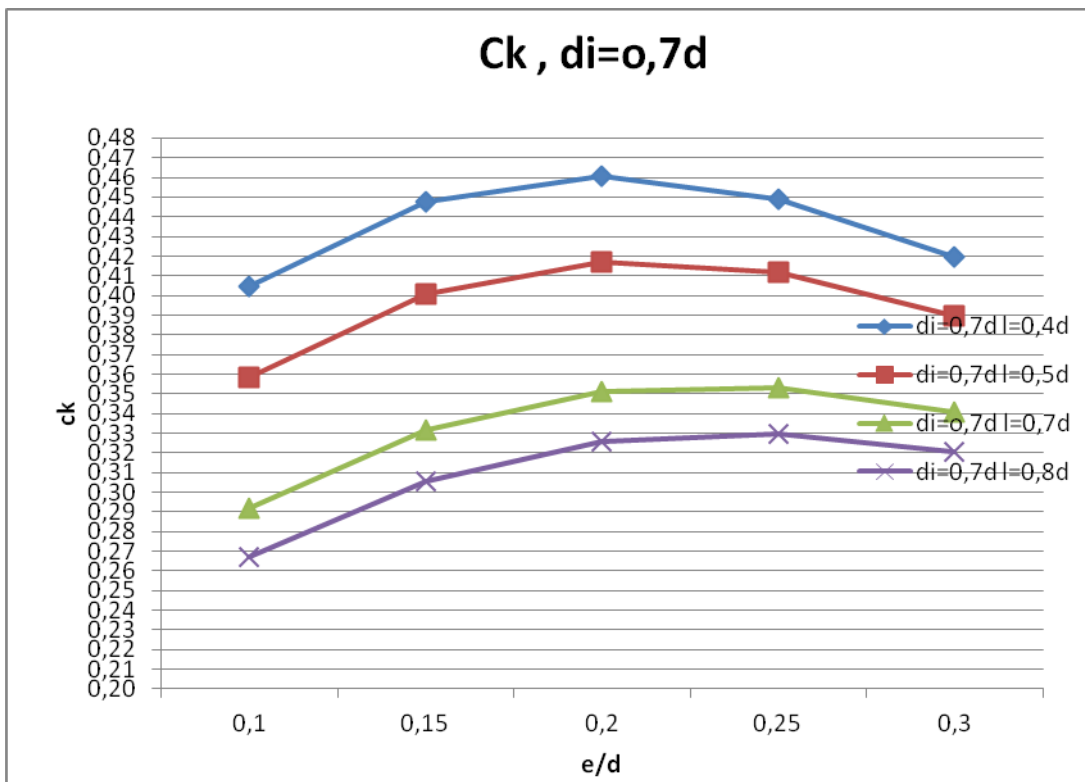
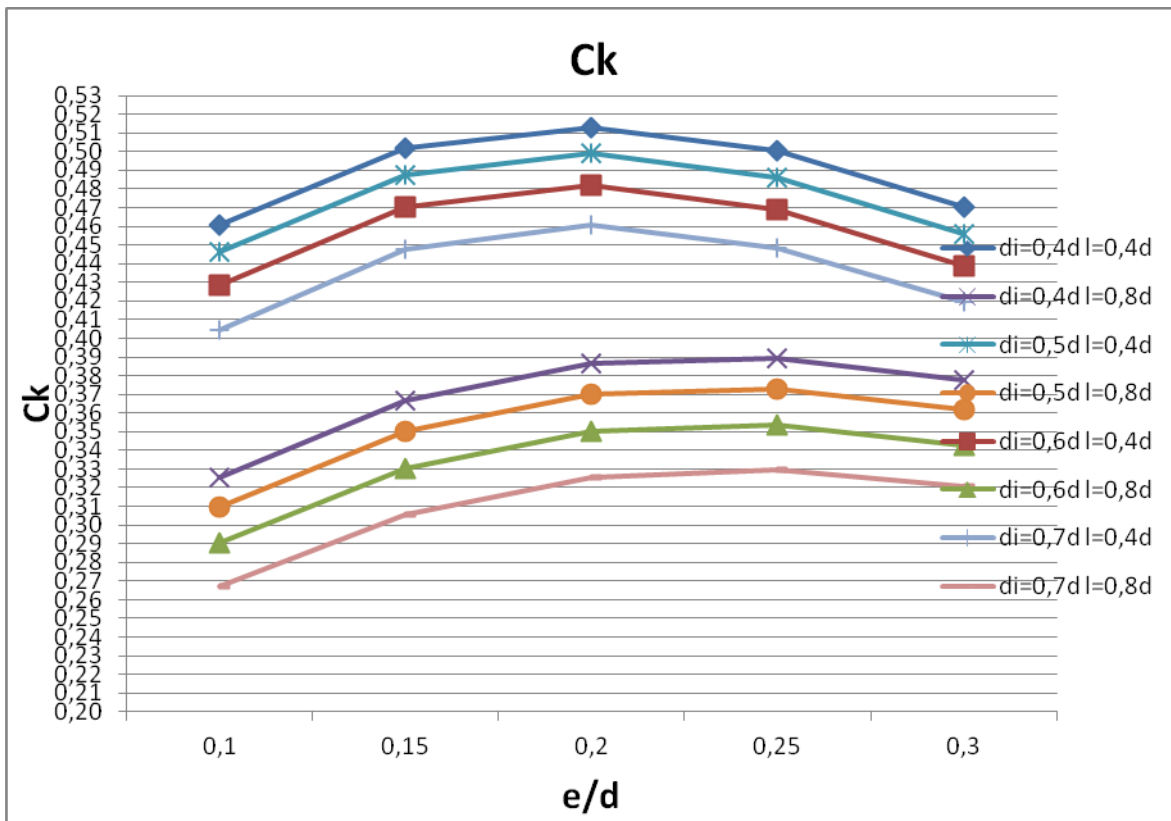
For two cases revised permissible stresses have been compared against torsional vibration level. Results proved to be acceptable.

Parameter study to evaluate the tabulated default notch factors applied in simplified method.

A parameter study has been done to evaluate the tabulated default values applied for shafts with slot in M68.6.

Based on the investigation and the received comments from the members the following is proposed:

- The default value for  $C_K = 0,3$  is kept unchanged
- slot geometry under footnote 6) is modified as follows;:
  - $d_i/d < 0,7$  (previous: 0,8)
  - $l/d < 0,8$  (previous: 0,8)
  - $e/d > 0,15$  (previous 0,1)
- Default value for  $k = 1,2$  is kept unchanged.
- Text under footnote 7) is modified to read:  
7)  $C_K = 0.3$  is an approximation within the limitations in 6). More accurate estimate of the stress concentration factor (scf) may be determined from M68.7.3 or by direct application of FE calculations. In which case:  $C_K = 1.45/scf$   
Note that the scf is defined as the ratio between the maximum local principal stress and  $\sqrt{3}$  times the nominal torsional stress (determined for the bored shaft without slots).





**3. Source/derivation of the proposed IACS Resolution**

Impact assessment as outlined above.

**4. Summary of Changes intended for the revised Resolution:**

Implement changes in Footnotes 6) and 7).

**5. Points of discussions or possible discussions**

None

**6. Attachments if any**

None

## **Technical Background for UR M68 (Rev.2, Apr 2015)**

### **1. Scope and objectives**

To develop requirements related to the approval of alloy steel which has a minimum specified tensile strength greater than 800 N/mm<sup>2</sup> intended for use as intermediate shaft material.

### **2. Engineering background for technical basis and rationale**

Since it is generally believed that the fatigue strength of notched steel decreases as tensile strength increases when the tensile strength of said steel exceeds 800 N/mm<sup>2</sup>, both UR M68.3 and UR M68.4 specify 800 N/mm<sup>2</sup> the upper limit for the minimum specified tensile strength of alloy steels used to make intermediate shafts.

Due to recent advances made in material technology, however, it has been discovered that there are cases when the minimum specified tensile strength of alloy steel used for intermediate shafts exceeds 800 N/mm<sup>2</sup>, the fatigue strength of the steel exhibits equivalent to or greater than the fatigue strengths of alloy steels used for intermediate shafts that have a minimum tensile strength of exactly 800 N/mm<sup>2</sup>.

Therefore, if it can be verified that alloy steel used for intermediate shafts exhibits similar fatigue life as conventional steel, even when minimum specified tensile strength of the alloy steel exceeds 800 N/mm<sup>2</sup>, it is generally believed that the current specified calculation formulas may be still used.

To confirm the above, torsional fatigue tests were carried out by one member using a material which has a minimum specified tensile strength of 950 N/mm<sup>2</sup>.

### **3. Source/derivation of the proposed IACS Resolution**

None.

### **4. Summary of Changes intended for the revised Resolution:**

Approval requirements related to the use of alloy steel which has a minimum specified tensile strength greater than 800 N/mm<sup>2</sup> as intermediate shaft materials was added as Appendix I.

### **5. Points of discussions or possible discussions**

#### Appendix I

##### 1. Application

The panel decided that the upper limits of minimum specified tensile strength should be specified. The limit was set as 950 N/mm<sup>2</sup> since this is the value which had been tested by one member.

##### 2.1 Test conditions

Test conditions are primarily based upon ISO 1352. However, ISO 1352 is a little too open because it includes a number of options; Therefore, the test conditions

only reference specific requirements in ISO 1352. More details regarding this are specified in the UR itself based upon the tests carried out by one member.

### 3. Cleanliness requirements

Cleanliness requirements are specified according to a member society's comments. A summary is given as follows:

*We limit the validity of the standard formula to 800 MPa tensile, because we consider that if the material contains inclusions / defects, the fatigue strength at such high levels may be dominated by crack growth. In such case, the fatigue strength is not likely to follow proportionally to the tensile strength at these strength levels.*

*Therefore we say that only if clean steel forgings are used, the formula can be used for higher strength than 800.*

*For the present steel, I agree that the tests documents that the formula can be used up to 950 MPa. But where is this particular steel, compared to the "worst" steel that can be delivered with this specification, in terms of cleanliness? The maximum "S" level specified, for example ( $S_{max} = 0.030$ ) is not compliant to what we usually consider as a clean steel specification.*

*The UR should state the "S" content of this particular steel, and should also document its content of non-metallic inclusions by a cleanliness test, before their request can be accepted.*

Although the panel agrees to introduce cleanliness requirements, there are no specific national or international standards for such materials. Therefore, the panel agreed to do the following:

- Require the cleanliness test in accordance with ISO 4967 method A. The degree of cleanliness is specified in Table 2 based upon a member society's practices.
- Require that specific steel composition be approved by the Society.

### **6. Attachments if any**

None

## Technical Background (TB) document for UR M68 (Rev.3 Feb 2021)

### 1. Scope and objectives

UR M68(Rev.2) does not reflect the agreed format for referencing the ISO standards. Rev.3 has been developed to comply with the agreed format.

### 2. Engineering background for technical basis and rationale

#### Format for references to Industry standards

**Format:**

*[Standard Designation], [version/revision, if applicable], [year of publication]*  
*(examples: API Spec 2F, 6th Edition, 1997; ISO 4624, 2002), where*  
*[version/revision, if applicable] and/or [year of publication] are decided by IACS and*  
*are not necessarily to be the current/latest version.*

### 3. Source/derivation of the proposed IACS Resolution

None

### 4. Summary of Changes intended for the revised Resolution

UR M68 has been updated to specify the revision/version of the ISO standards as follows:

ISO standards	Replaced by
ISO 1352	ISO 1352:2011
ISO 4967	ISO 4967:2013

### 5. Points of discussions or possible discussions

None

### 6. Attachments if any

None

# UR M69 “Qualitative Failure Analysis for Propulsion and Steering on Passenger Ships”

## Summary

UR M69 was deleted, taking into account that the content of this UR has already caused some conflict/confusion with MSC.1/Circ.1369.

## Part A. Revision History

Version no.	Approval date	Implementation date when applicable
Del (Mar 2022)	08 March 2022	-
Rev.1 (Feb 2021)	12 February 2021	1 July 2022
New (June 2008)	June 2008	-

### • Del (Mar 2022)

#### 1 Origin of Change:

- Suggestion by IACS member

#### 2 Main Reason for Change:

UR M69 was deleted, taking into account that the content of this UR has already caused some conflict/confusion with MSC.1/Circ.1369.

#### 3 List of non-IACS Member classification societies contributing or participating in IACS Working Group:

None

#### 4 History of Decisions Made:

None

#### 5 Other Resolutions Changes:

None

#### 6 Any hinderance to MASS, including any other new technologies:

None

## **7 Dates:**

Original Proposal : 24 March 2021 (Ref: PM20906hIMa)  
Panel Approval : 10 November 2021 (Ref: PM20906hIMe)  
GPG Approval : 08 March 2022 (Ref: 20206dIGh)

### **• Rev.1 (Feb 2021)**

#### **1 Origin of Change:**

Other (Periodical review to ascertain that the Resolution is suitable for the latest developments in technology)

#### **2 Main Reason for Change:**

There was a need to ascertain that this UR is suitable for the latest developments in technology.

#### **3 List of non-IACS Member classification societies contributing or participating in IACS Working Group:**

None

#### **4 History of Decisions Made:**

None

#### **5 Other Resolutions Changes:**

None

#### **6 Any hinderance to MASS, including any other new technologies:**

None

## **7 Dates:**

Original Proposal : 28 October 2019 (Ref: PM18939\_IMd)  
Panel Approval : 09 November 2020 (Ref: PM20906\_IMf)  
GPG Approval : 12 February 2021 (Ref: 20206dIGb)

### **• New (2008)**

Refer to Part B Annex I for Technical Background file

\*\*\*\*\*

## **Part B. Technical Background**

List of Technical Background (TB) documents for UR M69:

Annex 1.     **TB for New (June 2008)**

See separate TB document in Annex 1.

Annex 2.     **TB for Rev.1 (Feb 2021)**

See separate TB document in Annex 2.

**Note:** *There is no Technical Background (TB) document available for Del (Mar 2022)*

## Technical Background

### New Unified Requirement M69 (June 2008) for “Qualitative Failure Analysis for Propulsion and Steering on Passenger Ships”

#### *IACS Machinery Panel Task PM5911 – NTSB Report MAR/01-01 Recommendation to IACS*

#### **Background:**

A Project Team was established with a specific aim:

To evaluate whether the NTSB recommendation is justified and whether IACS needs to develop a UR for qualitative failure analysis for propulsion systems on new passenger ships. Depending on the results of evaluation:

- a. Draft a letter to NTSB providing technical justification for why IACS considers a qualitative failure analysis is not necessary **or**
- b. Develop a UR for qualitative failure analysis for propulsion systems on new passenger ships.

#### **Narrative:**

1. After evaluating the documentation relating to the incident, the Project Team decided that the best way of handling the issue was to develop a Unified Requirement specifically dealing with the NTSB's concerns

2. Since the NTSB report was issued, it was noted that the IMO had agreed revisions to SOLAS Chapter II-2, Regulation 21 which included safe return to port requirements for passenger ships having a length of 120 m or having three or more main vertical zones.

3. The task was to respond to a request for a "requirement for systems designers, manufacturers, and/or shipyards to perform and submit qualitative failure analysis to ensure the fail-safe operation of propulsion systems on new passenger ships".

4. The NTSB advised that requirements should "not focus solely on redundant propulsion systems". The NTSB in their findings "did not recommend that redundant propulsion systems be required on new passenger ships, nor that qualitative failure analysis should be limited to redundant propulsion systems". The "requirement would be applicable to all new passenger vessels regardless of the propulsion system used".

5. The NTSB further advised that as for the "meaning of the phrase ensure fail-safe operation of propulsion systems, the critical term was identified as fail-safe". The NTSB "recognised that individual components may fail - however the failure or malfunction of an individual component should not propagate through the entire system, resulting in a complete loss of propulsive power".

6. The NTSB also advised that "they believe that a qualitative failure analysis can be used to identify potential failures that could lead to a complete loss of propulsion. This information could help the designer determine what modifications could increase the reliability of the system. Although redundancy is one method that designers can use to achieve high reliability, improving the robustness of non-redundant components might also be an effective way to achieve this objective".

7. The **Objectives** stated in the draft UR are the keystone of the requirements and the extent of analysis required for different ships and propulsion arrangements needed to identified for ships needing to comply with the safe return to port and those that do not (outside the scope of SOLAS requirements).



8. During the development process it was agreed to include steering arrangements as well as propulsion noting the interdependence for safe manoeuvring of the ship.

9. It was agreed that it would not be effective to carry out failure analysis at component level if all the equipment in a compartment affected by fire or flooding was not available. In effect, where a ship is designed in accordance with the SOLAS safe return to port concept, the arrangements would be such that there would be at least two independent means for propulsion and steering. In such arrangements, it would only be necessary to carry out an analysis of the effects of failure in all the equipment due to fire or flooding in any space or compartment - i.e., all equipment within a space or compartment affected by fire or flooding would be lost. This is reflected Objective 1 in the revised document. Where the ship is not designed in accordance with the safe return to port concept, it would be necessary to carry out an analysis at component level as reflected in Objective 2. This was accepted as a realistic approach.

10. By taking the analysis to a high level for ships designed in accordance with the safe return to port concept, more components will be analysed at the same time and to repeat the analysis for single components would not add value when the result has to prove the availability of propulsion and steering.

11. For ships which are not designed with the safe return to port concept, single component analysis has been added for single systems.

12. The most severe common cause failures - fire and flooding have been identified for analysis which address the NTSB reported failure mode. It was noted that the Ecstasy did not have the analysis required by the final sentence in the **Systems to be considered** section of the proposed UR.

13. Under the headings **Systems to be considered**, the list was based on input from the Project Team and Machinery Panel Members and is considered sufficient to cover the systems that could affect the availability of propulsion and steering arrangements.

14. Under the headings **Failure Criteria** and **Verifications of Solutions**, these are considered to represent the current "state of the art" and which again have had extensive input from Machinery panel Members.

Submitted by Machinery Panel Chairman  
10 June 2008

**Permanent Secretariat note, June 2008:**

New UR M69 was approved by GPG on 23 June 2008 (ref. 1125\_IGs) with an implementation date of 1 January 2010.

## **Technical Background (TB) document for UR M69 (Rev.1 Feb 2021)**

### **1. Scope and objectives**

Periodical review to ascertain that the Resolution is suitable for the latest developments in technology.

### **2. Engineering background for technical basis and rationale**

#### **References to IMO instruments**

***Format:***

*regulation/paragraph x.x.x of SOLAS Chapter X/MARPOL Annex X/the XXX Code, as amended by IMO resolutions up to MSC.xx(xx)/MEPC.xx(xx)*

### **3. Source/derivation of the proposed IACS Resolution**

None

### **4. Summary of Changes intended for the revised Resolution:**

See item 2 above.

### **5. Points of discussions or possible discussions**

Technical validity of the recommendation as per M69 (Original version) was confirmed.

### **6. Attachments if any**

None

## UR M71 "Type Testing of I.C. Engines"

### Part A. Revision History

Version no.	Approval date	Implementation date when applicable
Corr.1 (June 2016)	3 June 2016	-
New (Feb 2015)	27 February 2015	1 July 2016

#### • Corr.1 (June 2016)

##### .1 Origin for Change:

- Suggestion by a Machinery Panel Member

##### .2 Main Reason for Change:

While reviewing UR M44 (Rev.8) and M44 (Rev.9) at Machinery Panel, it was found necessary to publish a corrigendum in order to clarify that UR M71 applies for type approval process of IC Engines.

##### .3 List of non-IACS Member classification societies contributing through the TC Forum and/or participating in IACS Working Group:

None

##### .4 History of Decisions Made:

UR M71 (New) specified "an application for certification" in the notes for implementation status, while UR M44 (Rev.8) and M44 (Rev.9) referring to M71, uses "certification" as wording relating to production of individual diesel engines. To avoid future troubles caused by understandings diverse among Societies/licensors/licensees/shipowners, it was concluded necessary to publish a corrigendum in order to clarify that UR M71 applies for type approval process of IC Engines.

##### .5 Other Resolutions Changes

None

##### .6 Dates:

Original Proposal: 02 November 2015 Made by Machinery Panel  
 Panel Approval: 15 April 2016 (Ref: PM9906a)  
 GPG Approval: 3 June 2016 (Ref: 16088\_IGc)

- **New (Feb 2015)**

**.1 Origin for Change:**

- IACS WP/MCH Task 50

**.2 Main Reason for Change:**

To update the content of UR M5, M14, M18, M23, M50, M51 and any other related URs to make them aligned with modern manufacturing technologies and current quality control procedures, including resolution of Reservations put forward.

**.3 List of non-IACS Member classification societies contributing through the TC Forum and/or participating in IACS Working Group:**

None

**.4 History of Decisions Made:**

Four meetings in the PT were held during the period 2008 and 2009 as part of the top level project PT 5906 to rationalise all i.c. engine related UR's. A decision was taken to combine the existing UR's M21, M32 and M50 detailing the requirements for Type Testing and also at the same time to consider objections from the Industry to IACS on some of the current requirements.

The draft submitted to the Machinery Panel was agreed at the last PT meeting.

The Machinery Panel has added definition for low-, medium-, and high-speed diesel engines, removed the requirement to strip down high-speed engines and made editorial changes to enhance readability.

**.5 Other Resolutions Changes**

UR M21, M32 and UR M50 are to be deleted and replaced by this UR.

**.6 Dates:**

Original Proposal: 02 April 2010 (Made by: IACS Machinery Panel PT50)  
Panel Approval: 08 January 2015 (By: IACS Machinery Panel)  
GPG Approval: 27 February 2015 (Ref: 7569\_IGw)

## Part B. Technical Background

List of Technical Background (TB) documents for UR M71:

Annex 1. **TB for Original UR M71 (Feb 2015)**

See separate TB document in Annex 1.



Note: There is no separate Technical Background (TB) document available for Corr.1 (June 2016).

Annex 1 Technical Background (TB) document

## **Technical Background (TB) document for Original UR M71 (Feb 2015)**

### **1. Scope and objectives**

Existing UR's M21, M32 and M50 to be reviewed taking into account operational feedback. The opportunity to combine M21, M32 and M50 into a new UR covering all engines was to be taken.

### **2. Engineering background for technical basis and rationale**

Experience gained through the implementation of existing UR M 21, M32 and UR M 50.

### **3. Source/derivation of the proposed IACS Resolution**

Feedback from Class Societies on existing UR M 21 and UR M 50, and industry via CIMAC WG2.

### **4. Summary of Changes intended for the revised Resolution:**

#### M71.1

Standardises the definition of Engine Approval and where Type testing is placed in the overall process. Engine components which are considered to be of interest and are required to be demonstrated by the test as being in compliance with applicable criteria and/or standards have been described.

The maximum validity time for the Type Approval certificate has been based upon the IMO MCS Circular 1221. This standardises the time period but individual Societies can make this time period shorter.

Define low-, medium-, and high speed diesel engines.

#### M71.3

The engine type has been defined in a way that is as meaningful as possible without leading to excessive testing requirements.

The extension of a type test certificate to a different torque rating is now based upon engine parameters that are more meaningful to the running performance of the components under examination. Requests for extension will be required to be substantiated with a declaration of satisfactory service history of the engine type; this information is considered as equivalent to Stage A of the type test.

#### M71.5

The testing is split into three recognisable modules:

**Stage A.** It has been recognised that many hours of tests are undertaken in-house (internal) prior to the official type test and the information from these are to be taken into account *provided detailed records* are maintained. These are further detailed in

M71.7 and the purpose is to reduce the number of running hours undertaken during the official tests.

**Stage B.** Detailed in M71.8

**Stage C.** Detailed in M71.9

M71.6

It was recognised that some designs of cylinder heads would not enable pressure measurements to be taken. For the purpose of type testing heads are to be suitably modified to enable these pressure measurements to be taken such that confidence in the results and design intent is achieved.

M71.7

The 100hr full load test has been moved to the stage A test to reduce the length of time Societies are required to be in attendance. This is on the basis that full records are kept by the manufacturer's test house and are available to Classification societies at any time upon request.

M71.8

The time to be run at any load point is a function of attaining steady state conditions and the length of time required for collection of data and for the attending surveyor to make a visual inspection. A recommendation time of 0.5 hours has been made.

## **5. Points of discussions or possible discussions**

### **M71.3, Notes 2)**

Discussion over an increase of the mean effective pressure proposed by CIMAC WG2 took place within the Panel.

*Providing maximum power is not increased by more than 10%, an increase of maximum approved power may be permitted without a new type test provided engineering analysis and evidence of successful service experience in similar field applications (even if the application is not classified) or documentation of internal testing are submitted if the increase from the type tested engine is within:*

- 10% of the maximum combustion pressure, or
- **15% of the mean effective pressure**, or
- 10% of the rpm

On the one hand, an increase in MEP by 15% was supported by six members as the increase in MEP by 15% is only applicable on condition that the RPM is reduced, given that the increase in MEP is also subject to the limitation to the power increase of 10% and the additional requirements, such as engineering analysis and service experience or internal testing, are also taken into account.

On the other hand, five members were of the view that the MEP should remain at 10% because MEP has a close relationship with engine component through-life loading and

the engine stress level is proportional to MEP even with a slight decrease in the RPM. It is difficult to ensure the stress level of critical engine components, such as crankshaft and connecting rod, is still within the designed safety margin.

#### **M71.8**

Discussion centred on the test's load points after receiving representation from WG2. The consensus of the PT was that a Type Test should be exhaustive and any relaxation to test points should be considered in the acceptance test of individual engines.

#### **6. Attachments if any**

None



## UR M72 “Certification of Engine Components”

### Summary

This revision of the UR provides clarifications regarding the NDE requirements of Engine Components.

### Part A. Revision History

Version no.	Approval date	Implementation date when applicable
Rev.3 (April 2023)	28 April 2023	1 July 2024
Rev.2 (Jan 2019)	07 January 2019	1 January 2020
Rev.1 (Mar 2016)	04 March 2016	1 July 2017
Corr.1 (Aug 2015)	20 August 2015	-
New (Feb 2015)	27 February 2015	1 July 2016

#### • Rev 3 (Apr 2023)

##### 1 Origin for Change:

Suggestion by IACS member

##### 2 Main Reason for Change:

Task PM22913 was initiated to deal with queries from an engine manufacturer, submitted by CIMAC to the Panel, regarding waiving the NDE testing of cylinder heads due to special shaper of cylinder heads.

During the discussion on the above issue, further amendments to the text of UR M72 Note 2 were proposed by several members to clarify and improve the requirements.

##### 3 List of non-IACS Member Classification Societies contributing through the TC Forum and/or participating in IACS Working Group:

None

##### 4 History of Decisions Made:

A qualified majority agreed to edit the note 2 of UR M72. The revisions to UR M72 resulting from PM22913 were agreed by a qualified majority. The changes agreed under tasks PM22913 were combined into revision 3 of this UR.

##### 5 Other Resolutions Changes

None

## 6 Dates:

Original Proposal:	17 July 2022	(by Machinery Panel)
Panel Approval:	04 April 2023	(Ref: PM22913_IMd)
GPG Approval:	28 April 2023	(Ref: 23047_IGc)

### • Rev 2 (Jan 2019)

#### 1 Origin for Change:

- Suggestion by IACS member

#### 2 Main Reason for Change:

Task PM16910 was initiated to deal with queries from an engine manufacturer, submitted by a panel member, regarding the testing of cylinder blocks. Strict application of the UR M72 requirements would suggest that the requirements for engines that have a cylinder block type arrangement only apply to crosshead engines so therefore there are no test requirements for trunk-piston engines with a cylinder block type arrangement. (e.g. 4-stroke engines where the cylinders are not integral with the crank case).

During the discussion on the issue above, further amendments to the text of UR M72 were proposed by several members in order to clarify and improve the requirements.

In connection with UR M72, a further external query on the interpretation of the contents of UR M72 raised by an engine manufacturer was also being dealt with under task PM16907. This query regarded the application of the M72 requirements mechanical and chemical composition testing for high pressure fuel system components and a request for clarification of the Society Certificate definition in paragraph 1.2. The outcome from task PM16907 was a response to the manufacturer, it was agreed that any necessary revisions to UR M72 would be combined with the changes decided in PM16910.

#### 3 List of non-IACS Member Classification Societies contributing through the TC Forum and/or participating in IACS Working Group:

None

#### 4 History of Decisions Made:

A qualified majority agreed to extend the scope of PM16910 to include wider editorial modifications to UR M72.

The revisions to UR M72 resulting from PM16907 and PM16910 were agreed by a qualified majority.

The changes agreed under tasks PM16907 and PM16910 were combined into revision 2 of this UR.

## 5 Other Resolutions Changes

None

### 6 Dates:

Original Proposal: March 2016 by Machinery Panel  
Panel Approval: 11 December 2018 (Ref: PM16910\_IMm)  
GPG Approval: 07 January 2019 (Ref: 18212\_IGb)

- **Rev 1 (Mar 2016)**

#### 1 Origin for Change:

- Suggestion by IACS member

#### 2 Main Reason for Change:

UR M72 requires hydraulic testing for high pressure fuel injection systems and common servo oil systems in the case of engines having cylinder bore exceeding 300mm. However, for engines having cylinder bore not exceeding 300mm, the hydraulic testing requirements are not sufficiently clear especially for high pressure fuel injection pipes including common fuel rail and high-pressure common servo oil systems. Machinery panel was agreed to revise UR M72 to clarify the scope of hydraulic testing.

#### 3 List of non-IACS Member Classification Societies contributing through the TC Forum and/or participating in IACS Working Group:

None

#### 4 History of Decisions Made:

The majority agreed that hydraulic testing is to be certified for all parts of the high-pressure piping system for components for engines of cylinder bore >300mm and that Test Reports are required for components for engines of cylinder bore  $\leq$ 300mm.

## 5 Other Resolutions Changes

None

### 6 Dates:

Original Proposal: November 2015 by Machinery Panel  
Panel Approval: 3 February 2016 (Ref: PM15906)  
GPG Approval: 4 March 2016 (Ref: 16028\_IGb)

- **Corr.1 (Aug 2015)**

#### 1 Origin for Change:

- Request by non-IACS entity (Doosan Engines)

## 2 Main Reason for Change:

IACS Machinery Panel considered an external query questioning on the definitions of "Cylinder jacket" in UR M6 and "Cylinder liner, steel parts". Machinery Panel has worked on UR M72 to add a note as a follow-up action of the external query from Doosan Engines. The background is that UR M72 (new Feb 2015), which will replace both UR M6 and M18, requires pressure test for Cylinder block (for crosshead engines) and Engine block (for >400 kW/Cyl), but does not use the term "cylinder jacket" which may result in confusion whether the upper/lower jackets (new design) are to be pressure tested. In this respect, Machinery Panel decided to add a note in UR M72 to complement it.

## 3 List of non-IACS Member classification societies contributing through the TC Forum and/or participating in IACS Working Group:

None

## 4 History of Decisions Made:

It was unanimously agreed within Machinery Panel to amend UR M72 as a 'Corrigendum' as this is just a clarification to the existing requirements (not a new technical requirement) and hence not considered as a 'Revision'. The implementation date of this corrigendum will be the same as that of the original version, i.e. 1 July 2016.

## 5 Other Resolutions Changes

None

## 6 Dates:

Panel Approval: 31 July 2015 (Ref: PM15904)  
GPG Approval: 20 August 2015 (Ref: 15099\_IGe)

### • New (Feb 2015)

## 1 Origin for Change:

- Suggestion by IACS members
- Based on IACS Requirement (*M6, M18, M19, M58*)

## 2 Main Reason for Change:

For the test, inspection and certification of engine parts, perceived discrepancies existed among the existing unified requirements, modern manufacturing technology and current quality control procedures, and actual practices of IACS members. Alternative certification schemes will also be considered by PT. It is required to develop a new UR, which addresses engine parts certification, tests and inspection, to make them aligned.

### **3 List of non-IACS Member classification societies contributing through the TC Forum and/or participating in IACS Working Group:**

None

### **4 History of Decisions Made:**

All URs related engine and engine parts inspection, such as M5, M6, M18, M19, M23 and so on, were reviewed during first two PT meeting. The initial draft was developed after the second PT meeting, which considered the existing requirements of engine parts inspections and PT members' proposals. The draft UR was worked out during the last two PT meetings. Many hours were spent in the process of determining which engine components should be included in the UR, relevant examinations/inspections that need to be carried out, type of certificates that should be required, and how the examination and certificate requirements of the engine components shall apply to engines of different type/bore size/power.

At the last PT meeting, the draft UR was completed except for the ">x kW" break-off points for engines.

The engine size break-points have been finalised by the panel.

At the 16<sup>th</sup> meeting it was agreed to move the definitions of Type of Certificates from UR Z-ACS to M72.

One society advised that all pumps, pipes and valves for the hydraulic oil and the flammable oil systems in the machinery space are generally required to be hydraulically tested depending on the design pressure not the physical size of the equipment or part.

Considering the danger of fire, hydraulic testing for the following parts and systems is to be carried out regardless of the size of the engine:

- High pressure fuel injection pump body,
- High pressure fuel injection valves that are not autofretted,
- High pressure fuel injection pipes including common fuel rail,
- High pressure common servo oil system,
- Accumulator of common rail fuel or servo oil system,
- Piping, pumps, actuators, etc. for hydraulic drive of valves, if applicable.

A majority of the Panel members voted to keep the present limitation of hydraulic testing to engines with cylinder bores exceeding 300mm.

### **5 Other Resolutions Changes**

UR M6, M18, M19 and M58 to be deleted and replaced by this UR.

### **6 Dates:**

Original Proposal: 02 April 2010 (Made by: IACS Machinery Panel PT)  
Panel Approval: 08 January 2015 (By: IACS Machinery Panel)  
GPG Approval: 27 February 2015 (Ref: 7569\_IGw)

## **Part B. Technical Background**

List of Technical Background (TB) documents:

Annex 1. **TB for New (Feb 2015)**

See separate TB document in Annex 1.

Annex 2. **TB for Rev.2 (Jan 2019)**

See separate TB document in Annex 2.

Annex 3. **TB for Rev.3 (Apr 2023)**

See separate TB document in Annex 3.

**Note:** *There are no Technical Background (TB) documents available for Corr.1 (Aug 2015) and Rev.1 (Mar 2016).*

## **Technical Background (TB) document for UR M72 (New Feb 2015)**

### **1. Scope and objectives**

Within the scope given in the Form A for MCH panel task PM5906, the existing UR's M5, M14, M18, M23 were identified as those dealing with testing of engine parts and materials.

The objective was to make them aligned with modern manufacturing technology and current quality control procedures considering that, with only minor deviations, all engine parts are manufactured with automated machines under strict quality control, thus granting full interchangeability of parts, and manual adjustment of parts is not normally applied.

Some additional UR's were also identified (M6, M19, M58) as dealing with testing of engine parts and materials, and have been reviewed as well, since the opportunity to combine them into a new UR covering all engine parts and testing activities was to be taken.

### **2. Engineering background for technical basis and rationale**

Modern production technology which improves the accuracy and repeatability in component manufacturing. Improved quality control measures. Experience gained through the implementation of existing URs and perceived need to solve the Reservation put forward.

### **3. Source/derivation of the proposed IACS Resolution**

Reconsideration of previous URs and feed back from Class Societies on existing URs.

### **4. Engineering background of changes and additions.**

A draft for an M72 was developed based upon proposals from different Societies, starting from general principles (suitably equipped plant, applied quality control system, conformity of production, documentation, class requirements) and going into details of a table listing tests and documentation required for engine parts.

For the definitions of type of documentation required and symbols, reference was made to the UI dealing with Alternative Certification Scheme (UI-ACS)

In the work to decide which engine components should be included in Table M72.2 of the UR, relevant examinations/inspections that need to be carried out, the kinds of certificates that should be required, and how the examination and certificate requirements of the engine components shall apply to engines of different type/bore size/power, factors as engine component criticality, manufacturer's quality control and practical issues as it has been recognized that not all parts can be tested under survey.

The work also focused on the possibility to delegate to the manufacturer most of the tests (and thus only requiring a Work's certificate), similar to that established for an Alternative Certification Scheme based on the general principle that a quality control

system is to be in force.

The figure identifying the threshold size for each component can be either the bore diameter, the power (eventually per cylinder) or the type of engine (crosshead vs. trunk piston).

Significant modifications in respect of previously applicable URs are:

- Deletion of the definition of "mass production" and inspection procedures
- Addition of material test report for main, crosshead, and crankpin bearing
- Addition of Ultrasonic tests for bolts
- Deletion of material and NDT requirements for Crosshead and relevant bolts
- Deletion of material and NDT requirements for Steel gear wheels for camshaft drives
- Deletion of pressure test of piston crown
- Deletion of pressure test for injection valves and pipes that are auto fretted
- Deletion of pressure test for cooling space of exhaust pipes
- Addition of pressure test of air side of Charge air coolers
- Test requirements for turbochargers are moved into UR M-TC

## **5. Points of discussions or possible discussions**

The need/possibility to require a Society Certificate, when the documentation requirement for all the tests to be carried out is a Work's certificate (except for a visual inspection); it was decided that the Work's certificates documentation review is an actual operation which, together with a visual inspection can allow the issuance of a Society certificate for the relevant component.

Therefore, for nearly all the material properties (chemical and mechanical properties), NDT, pressure tests and dimensional inspection, only Work's certificates are required (with the only exception of crankshafts and conrods).

One Society advised all pumps, pipes and valves for the hydraulic oil and the flammable oil systems in the machinery space are generally required to be hydraulically tested depending on the design pressure not the physical size of the equipment or part.

Considering the danger of fire, hydraulic testing for the following parts and systems is to be carried out regardless of the size of the engine:

- High pressure fuel injection pump body,
- High pressure fuel injection valves that are not autofretted,
- High pressure fuel injection pipes including common fuel rail,
- High pressure common servo oil system,
- Accumulator of common rail fuel or servo oil system,
- Piping, pumps, actuators, etc. for hydraulic drive of valves, if applicable.

A majority of the Panel members disagreed with the proposal so the present limitation of hydraulic testing for engines with cylinder bores exceeding 300mm remained.

During the course of review of the UR by the Panel several editorial changes and



corrections were made for requirements clarification for users.

One Society proposed required testing of the following items applicable to all main diesel engines that are essential for machinery propulsion:

- Engine driven pumps (oil, water, fuel, bilge)
- Coolers, both sides

The proposed additional testing requirements are based in part on the fact other similar equipment installed in the machinery space are generally required to have hydraulic testing based on the design pressure not the physical size of the equipment they are installed in.

A majority of the members disagreed with the proposal so the present limitation of hydraulic testing for engines with power output exceeding 800 kW per cylinder remained.

For repair of engines with bores less than 300 mm, UR accepts material certification of connecting rods based on manufacturer's Work's Certificate, rather than Society Certificate, in line with the practice of one Society.

An attempt to apply the document when amending M44 revealed that the X used in table M72.2 was not understood and it was agreed to add the explanation of the meaning of X.

## **6. Attachments if any**

None

## **Technical Background (TB) document for UR M72(Rev.2 Jan 2019)**

### **1. Scope and objectives**

Queries raised by manufacturers initiated two parallel tasks (PM16907 and PM16910). Task PM16907 resulted in a formal response being sent to the manufacturer. The points addressed in this response required some revision of UR M72 to clarify the certificate definitions and the requirements applying to high pressure fuel systems.

The query that initiated PM16910 relates to the testing requirements for cylinder blocks and whether these should apply to trunk piston type engines. This task's primary objective was to clarify this aspect of the Table. During initial reviews a range of further editorial amendments were identified by several members to clarify and improve the content of the UR. A qualified majority agreed to extend the scope of PM16910 to include wider changes to the UR to clarify a number of other minor issues.

### **2. Engineering background for technical basis and rationale**

The principal technical change considered under PM16910 relates to the test requirements for cylinder blocks. It was agreed that the terminology in UR M72 should be understood in accordance with ISO 7967-1:2005 where the following definitions apply:

Engine block: crankcase with an integral cylinder or cylinder jacket (or casing)

Cylinder block: two or more cylinders, integral or bolted together

This means that the cylinder block test requirements should be applied to all engines that have this type of arrangement (irrespective of the engine type). Further interpreting UR M72 it was considered that the testing and certification requirements should be applied where the engine power is greater than 400kW/cylinder (to align with the requirements for engine blocks).

Further changes were discussed and agreed on the basis of the improvements made to the clarity of the current technical requirements.

### **3. Source/derivation of the proposed IACS Resolution**

Amendments to the UR were developed under tasks PM16907 and PM16910.

### **4. Summary of Changes intended for the revised Resolution:**

Changes to UR M72 identified as a result of PM16907 were as follows:

- The definition of society certificate was modified to clarify which component is to be tested.
- Minor modification to wording of Works Certificate definition to aid clarity.
- The requirements for mechanical and chemical testing for "High pressure fuel injection pipes including common fuel rail" and "High pressure common servo oil system" were identified, clarifying that "W(C+M) applies when  $D \leq 300\text{mm}$ .

- The requirements for mechanical and chemical testing for "high pressure fuel injection pump body" were introduced and made applicable both to  $D \leq 300\text{mm}$  and  $D > 300\text{mm}$ .
- New footnote added to clarify that the requirements of UR M72 will be superseded if there are any applicable requirements provided in another UR.

Changes to UR M72 related to PM16910 as follows:

- Paragraph 1.4 amended in order to add the wording "batch" to clarify the definition of the Test Report.
- Paragraph 1.7 amended to open the requirement beyond the apparent assumption that the manufacture of the component is started and completed at a single site and make it more applicable to current manufacturing approaches.
- Cylinder blocks - The applicability of the testing requirements was amended to align with the requirements for engine blocks ( $< 400\text{kW/cyl}$ ).
- Forged main journals with flange – visual inspection expanded to include reference to fillets after it was noted that journals with flange might have a fillet radius (transition fillet radius) that should be subject to visual inspection.
- Piston rod – "if applicable" deleted as not considered necessary.
- Piston rod & Cross head – addition text in the non-destructive testing column deleted as it is potentially confusing. It was suggested that the current requirement appears to mandate two stages of CD and it is not immediately apparent why CD would need to be completed before final machining or why UT is not required after final machining.
- Various other minor typographical corrections made throughout.
- The rows of the table relating to "Semi-built crankshaft", "Crank throw" and "Forged main journal and journals with flange" were consolidated into a single row in the table as they all have the same test requirements.

## **5. Points of discussions or possible discussions**

The changes to UR M72 were agreed by a qualified majority the following points of discussion were made:

PM16907 – the queries from the manufacturer relating to the technical requirements of the UR resulted in the following responses, these were adapted/incorporated into the revision of UR M72:

- With regards to high pressure injection systems and common servo oil systems, IACS originally intended to require "W" only for engines with bore exceeding 300mm and 'TR' for engines with bore not exceeding 300mm. Following this principle, IACS found it necessary to amend the requirements of hydraulic testing for those systems in Table M72.2 after adoption of UR M72. In particular, the hydraulic testing for "High pressure Fuel injection pipes

including common fuel rail" you have questioned are required for both D>300mm ("W") and D<300mm ("TR"). Please see UR M72 Rev.1 which was adopted on February 2016.

- Required documentation level was discussed for a long time, and then "W" or "TR" was put in the appropriate place for all components listed in Table M72.2.
- While it is not clearly specified in UR M72, it is necessary for piping to comply with relevant IACS UR such as UR P2.
- The expression "the certified product itself" is neither "a 3.2 certificate of the raw material" nor "type approved product". The expression "the certified product itself" means the product itself entitled to the certificate as a result of tests and inspections carried out.

Queries relating to the certificate types were replied to with the following agreed response, these points were incorporated into the revision of UR M72:

- The intention of sentence "the test was witnessed by the Society Surveyor" is to clarify that certificates issued by manufacturers are considered equivalent to a Society Certificate provided that Class surveyor endorsed it, even if certificates itself are not issued by Classification Society.
- In DNV-GL, ACS is MSA. In other Societies, please see page 11, APPENDIX 1 GLOSSARY, IACS UR M44.
- The expression "accredited third party" means "a completely independent person with stamp authority from the Classification Society, or a laboratory accepted by the Classification Society and authorized by the Authorities of the country where the laboratory is located to carry out the specific tests". In this case, the work's certificate is considered equivalent to a Society Certificate.

PM16910 – Changes made as described in section 4 above were agreed by a qualified majority, the following changes were proposed but did not receive majority support:

- Deletion of paragraph 1.5 was proposed as it was considered potentially superfluous to requirements and could be removed with no negative effect on the remaining UR but this did not receive sufficient support from the panel. All other changes were agreed (or amendments made that were then agreed) by the panel.
- Following a request by a Member Society, Members were requested to express their intention or not to add mechanical and chemical testing requirements for High pressure fuel injection valve (item 28 in Table M72.2). The qualified majority decided not to add these requirements for the reason that these valves are to be periodically maintained (with completely dismantled and assembled including an injection test at the last stage of maintenance) and Members are not aware of valve failures that may be attributed to a lack of mechanical and chemical testing.
- One Member Society proposed to modify paragraph 1.4 as follow in order to better clarify that the intent of the proposed update is to tie the Test Report to

the components being certified or the related batch:

“1.4 Test Report (TR)

This is a document signed by the manufacturer stating:

- conformity with requirements.
- that the tests and inspections have been carried out on samples from the current production batch relating to the component(s) being certified.”

The proposal was not supported by the qualified majority.

**6. Attachments if any**

None

## **Technical Background (TB) document for UR M72 (Rev.3 April 2023)**

### **1. Scope and objectives**

Queries raised by manufacturers initiated on tasks (PM22913).

Task PM22913 resulted in a formal response being sent to the manufacturer. The points addressed in this response required some revision of UR M72 to clarify the required NDE test when isn't applicable due to shape of components.

The query that initiated PM22913 relates to the testing requirements for cylinder Heads and blocks of Engines.

This task's primary objective was to clarify this aspect of the note 2 of UR M72. During initial reviews a range of further editorial amendments were identified by several members to clarify and improve the content of the UR note 2. A qualified majority agreed to extend the scope of PM22913 to include changes to the UR to clarify a footnote 2 issues.

### **2. Engineering background for technical basis and rationale**

The principal technical change considered under PM22913 relates to the NDE test requirements for cylinder heads & blocks. It was agreed that the terminology in UR M72 note 2 should be understood in accordance with ISO 12680-1 where the following definitions apply:

Ultrasonic examination Part1 for steel casting for general purposes & EN 12680-2 Founding – Ultrasonic examination Part 2 for steel casting for highly stressed components.

Further changes were discussed and agreed on the basis of the improvements made to the clarity of the current technical requirements.

### **3. Source/derivation of the proposed IACS Resolution**

Amendments to the UR were developed under tasks PM22913.

### **4. Summary of Changes intended for the revised Resolution:**

Changes to UR M72 identified as a result of PM22913 were as follows:

Non-destructive examination means e.g., ultrasonic testing, crack detection by MPI or DP. When certain NDE method on the finished component is impractical (for example UT for items 12/13), the NDE method can be performed at earlier appropriate stages in the production of the component, see M72.1.2.

### **6. Attachments if any**

None

## UR M73 “Turbochargers”

### Summary

In Rev.2 of this UR, clarifications have been provided as regards the expression “totally new design”, the type testing load cycles and the containment test.

### Part A. Revision History

Version no.	Approval date	Implementation date when applicable
Rev.2 (May 2023)	25 May 2023	1 July 2024
Rev.1 (Mar 2022)	23 March 2022	1 January 2023
Corr.1 (June 2016)	03 June 2016	-
New (Feb 2015)	27 February 2015	1 July 2016

- **Rev.2 (May 2023)**

#### 1 Origin of Change:

Suggestion by IACS member

#### 2 Main Reason for Change:

2.1 To review the UR M73 based on industry comments seeking clarification on the expression “totally new design” specified in M73.3 and whether the 500 load cycles test is limited to turbochargers for high-speed engines;  
 2.2 to clarify the containment test temperature; and  
 2.3 to consider a proposal made in the past by the industry on containment safety critical cases.

#### 3 List of non-IACS Member classification societies contributing or participating in IACS Working Group:

None

#### 4 History of Decisions Made:

The revised UR was developed and agreed by correspondence and meeting within the panel.

#### 5 Other Resolutions Changes:

None

#### 6 Any hinderance to MASS, including any other new technologies:

None

## **7 Dates:**

Original Proposal	: 03 October 2018	(Made by: Machinery Panel)
Panel Approval	: 24 April 2023	(Ref: PM13914aIMza & PM13914c)
GPG Approval	: 25 May 2023	(Ref: 19027_IGc)

### **• Rev.1 (Mar 2022)**

#### **1 Origin for Change:**

Suggestion by a Machinery Panel Member

#### **2 Main Reason for Change:**

Need for uniform policy for legacy Turbochargers designed prior to entry into force of UR M73; in particular to Note 2 of UR M73 for the "date of application for certification".

#### **3 List of non-IACS Member Classification Societies contributing through the TC Forum and/or participating in IACS Working Group:**

None

#### **4 History of Decisions Made:**

With regard to the expression "new turbocharger type", the question is whether a turbocharger unit covered by a Type Approval (TA) certificate which is issued (or extended) on or after the effective date (1 July 2016) of the UR would need to be in full compliance with the requirements of the current (latest) edition of UR. Thus it was considered necessary to update the Application Note(s) of the UR.

#### **5 Other Resolutions Changes:**

Consideration for a possible combination with the work of PM13914a.

#### **6 Any hinderance to MASS, including any other new technologies:**

None

## **7 Dates:**

Original Proposal	: 23 April 2021	Made by Machinery Panel
Panel Approval	: 13 December 2021	(Ref: PM13914bIMf)
GPG Approval	: 23 March 2022	(Ref: 22027_IGb)

### **• Corr.1 (June 2016)**

#### **1 Origin for Change:**

Suggestion by a Machinery Panel Member



## **2 Main Reason for Change:**

While reviewing UR M44 (Rev.8) and M44 (Rev.9) at Machinery Panel, it was found necessary to publish a corrigendum for further clarification on the application of UR M73.

## **3 List of non-IACS Member Classification Societies contributing through the TC Forum and/or participating in IACS Working Group:**

None

## **4 History of Decisions Made:**

UR M73 contains not only the requirements to be applied for individual turbochargers (i.e., M73.4) but also the requirements to be applied for new turbocharger types (i.e., paragraphs other than M73.4). Thus, it was concluded necessary to publish a corrigendum in order to clarify the above.

Additionally, consideration was given to the term "a generic range" in paragraphs 2.3 and 3.2.2 coming with no clear definition. Therefore, a footnote providing the definition of "a generic range" was inserted at the bottom of a page containing paragraph 3.2.2 so as to give clearer understanding.

## **5 Other Resolutions Changes**

None

## **6 Dates:**

Original Proposal	: 02 November 2015	Made by Machinery Panel
Panel Approval	: 15 April 2016	(Ref: PM9906a)
GPG Approval	: 03 June 2016	(Ref: 16088_IGc)

## **• New (Feb 2015)**

### **1 Origin for Change:**

IACS WP/MCH Task 50

### **2 Main Reason for Change:**

The existing M23 had been reviewed by PT PM5906, and perceived discrepancies were identified between the existing requirements and today's design and safety philosophy. It was agreed to develop a complete revision of UR for turbochargers, which addressed the technical requirements for turbochargers and their matching with engines.

### **3 List of non-IACS Member classification societies contributing through the TC Forum and/or participating in IACS Working Group:**

None

#### **4 History of Decisions Made:**

The existing M23 was reviewed after the Kick-off PT meeting, and the team agreed to develop a complete revision of UR for turbochargers, which addresses the requirements for turbocharger design approval, type test, monitoring and alarm, certification and matching with engines.

The draft was agreed at the last PT meeting.

Based upon feedback on Turbo Charger failure where the housing did not manage to contain the rotating parts due to the way the turbine disintegrated the containment test was altered.

#### **5 Other Resolutions Changes:**

UR M23 to be deleted and replaced by this UR.

#### **6 Dates:**

Original Proposal	: 01 July 2010	(Machinery Panel PM5906)
Panel Approval	: 08 January 2015	(Machinery Panel)
GPG Approval	: 27 February 2015	(Ref: 7569_IGw)

## **Part B. Technical Background**

List of Technical Background (TB) documents for UR M73:

Annex 1.        **TB for New (Feb 2015)**

See separate TB document in Annex 1.

Annex 2.        **TB for Rev.1 (Mar 2022)**

See separate TB document in Annex 2

Annex 3.        **TB for Rev.2 (May 2023)**

See separate TB document in Annex 3

*Note: There is no separate Technical Background (TB) document available for Corr.1 (June 2016).*

## Technical Background (TB) document for Original UR M73 (Feb 2015)

### 1. Scope and objectives

Perceived discrepancies between the existing M23 “Mass production of engines: mass produced exhaust driven turboblowers” and today’s design and safety philosophy required a complete revision of the UR for turbochargers. The new M-73 reflects changes in turbocharger design approaches and manufacturing processes based on modern technologies. The requirements are applicable for turbochargers regarding design approval, type testing and certification. The requirements focus on safety of personnel (containment in the event of disc burst), reliable lifetime performance, monitoring and proper matching with the engines.

### 2. Engineering background

Turbochargers are categorized in three groups depending on served power by cylinder groups with:

Category A  $\leq 1000$  kW

Category B  $>1000$  kW and  $\leq 2500$  kW

Category C  $> 2500$  kW

Documentation, type testing, certification and alarm and monitoring depend on this grouping. For all turbochargers a new introduced containment requirement becomes mandatory. Turbochargers shall fulfil containment in the event of a rotor burst. This means that at a rotor burst no part may penetrate the casing of the turbocharger or escape through the air intake.

### 3. Source /derivation of the proposed IACS Resolution

Even careful design and testing cannot completely exclude the event of a rotor burst or parts of it. By implementation of containment requirements in their rules some Societies have already addressed this. Based on their own design approach, containment tests or an analysis of sufficient containment integrity of the casing have been carried out by major turbocharger manufacturers.

### 4. Summary of Changes intended for the revised Resolution

**M73.2** The documentation to be submitted depends on the categorization. For turbochargers in Category A  $\leq 1000$  kW only the documentation for the containment and its integrity in case of a rotor burst must be submitted.

For categories B and C a more comprehensive documentation including alarm levels and type test reports shall be submitted.

For category C turbochargers, among others, additional material specifications, possible welding details and the summary of lifespan calculation shall be submitted.

**M73.3** Here design requirements and corresponding type testing are specified. Focus is especially on the integrity of the containment and the component lifespan. For a generic range of turbochargers this shall be analyzed.

**M73.4** Certification shall be based on the adoption and application of a quality system which shall ensure that the designer's specifications are met and that manufacturing is in accordance with the approved drawings. For category C turbochargers this shall be verified by means of periodic product audits by the society.

**M73.5** For all turbochargers of category B and C in this part for the parameters to be monitored the alarm and display requirements are given.

**5. Points of discussions or possible discussions**

None

**6. Attachments if any**

None

## **Technical Background (TB) document for M73 Rev.1 (Mar 2022)**

### **1. Scope and objectives**

With regard to the expression “new turbocharger type” the discussion is on whether a turbocharger unit covered by a Type Approval (TA) certificate which is issued (or extended) on or after the effective date (1 July 2016) of the UR would need to be in full compliance with the requirements of the current (latest) edition of UR.

### **2. Engineering background for technical basis and rationale**

Example case of possible scenario: TA certification: Last TA cert no. 3 for turbo model XY having validity dates 15 Sep 2018 - 14 Sep 2023 replaced expired TA cert no.2 for same model XY that had validity dates 15 Sep 2013 – 14 Sep 2018 and original application for certification date of 10 Aug 2013.

Compliance to UR M73: Turbochargers covered in last TA cert no. 3 for turbo model XY having validity dates 15 Sep 2018 - 14 Sep 2023 may not have been built in full compliance with the current(latest) UR M73 being in effect on or after 1 July 2016.

### **3. Source /derivation of the proposed IACS Resolution**

There is a need for uniform approach between members, as opinions were divided. Some societies were of the view that the requirements of UR M73 are to be implemented for legacy turbochargers on/after 1 July 2016, while other societies' position was that legacy T/Cs are not required to comply with UR M73 at the time of their type approval certificates renewal.

### **4. Summary of Changes intended for the revised Resolution**

After agreement to additions of the following types of Notes to the uniform application statement of this UR, Machinery Panel has agreed to the following:

(A) the need to replace the wording “becomes invalid” and “the issuance of a new certificate” with “reaches its expiry date” and “the issuance of a renewal certificate”, respectively,

(B) deletion (and transfer to the TB file) of the last sentence of Note 2 based upon the understanding that it is clear that the “date of application” related to the existing (expired) type approval certificates cannot be used as the new “date of application” for renewal of type approval certificates.

(C) deletion (and transfer to the TB file) of the last sentence of the 1st Paragraph of Note 3 covered by the preceding sentence stating “[...] reaches its expiry date” and,

*Note 2: The “date of application for certification” is the date of whatever document the Classification Society requires/accepts as an application or request for certification of a new turbocharger type or of a turbocharger type that has undergone substantive modifications in respect of the one previously type approved, or for renewal of an expired type approval certificate. On or after [date] the “date of application” of an expired type approval certificate*

*may not be carried over/re-considered for the issuance of a new certificate and/or the validity of an existing certificate may not be extended for turbochargers that are not built in compliance with this UR revision.*

*Note 3: The requirements of UR M73 Rev.1, except for M73.4, are to be uniformly implemented by IACS Societies to turbochargers with the date of application for certification on or after [date]. Turbochargers with an existing type approval on [date] are not required to be re-type approved in accordance with this UR until the current Type Approval becomes invalid. For the purpose of certification of these turbochargers, the current type approval and related submitted documentation will be accepted in place of that required by this UR revision until the current type approval expires or the turbocharger type has undergone substantive modifications.*

*The requirements of M73.4 Rev.1 are to be uniformly implemented by IACS Societies to turbochargers with the date of application for certification of an individual turbocharger on or after [date].*

## **5. Points of discussions or possible discussions**

With regard to Note 2, for the purpose of certification of these turbochargers, the current type approval and related submitted documentation will be accepted in place of that required by this UR revision until the current type approval expires or the turbocharger type has undergone substantive modifications.

With regard to Note 3, on or after 1 January 2023 the “date of application” of an expired type approval certificate may not be carried-over/re-considered for the issuance of a renewal certificate and/or the validity of an existing certificate may not be extended for turbochargers that are not built in compliance with this UR revision.

## **6. Attachments if any**

None

## **Technical Background (TB) document for UR M73 Rev.2 (May 2023)**

### **1. Scope and objectives**

The scope is the revision of the UR M73 to clarify the following points:

- 1) The expression "totally new design" in the context of a new reference containment test is required.
- 2) Whether 500 load cycles tests are required only for high-speed engines or also for low and medium speed engines, taking into account the provisions of UR M71 "Type Testing of I.C. Engines".
- 3) The temperature at which the containment test is conducted.
- 4) Designs with cases more critical than those defined in the UR with respect to containment safety.

### **2. Engineering background for technical basis and rationale**

- 1) Various examples were proposed by the members regarding design changes that should be considered as "totally new design". Among them, what the members commonly considered as "totally new designs" were described as examples in this UR.
- 2) Some members considered that the 500 load cycles test was related to the item of the type test of the high-speed engines specified in the UR M 71.5.6 (Corr.1) and that it was not necessary to conduct this test for turbochargers intended for low and medium speed engines. However, the majority view was that 500 load cycles tests could not be omitted even for low and medium speed engines, and it was decided to state this clearly in this UR. (See paragraph 5)
- 3) In addition to the above 1), focus was given to the temperature and speed at which containment tests are to be carried out, and it was considered necessary to discuss the relationship between test speed, material temperature and mechanical properties, and the implications this may have for the containment test. (i.e., turbocharger operation resulting in lower casing temperatures may cause the material to have a more brittle behaviour which may, consequentially, provide a more onerous condition than would be the case at the maximum temperature. On the other hand, the materials conventionally used for turbocharger casings exhibit a characteristic whereby the Ultimate Tensile Strength (UTS) reduces as the temperature increases, albeit that the relationship is non-linear. In addition, as the casing temperature increases with engine power/turbocharger speed and that the centrifugal force of fragments which detach from the rotor increases with the square of turbocharger speed, it is considered that the most onerous test condition exists at maximum temperature and rotor speed.)

After reviewing these matters with the industry, it was recognized that providing evidence for all cases in the speed range and temperature range would impose an undue burden on the manufacturer of the turbocharger that is



not proportionate to the risk. Therefore, it was considered reasonable for manufacturers to review potential for more critical cases and, if such cases were identified, to require manufacturers to provide evidence of containment safety.

**2a. Specification of the data utilised in the development/revision of the proposed IACS Resolution, if any**

N/A

**3. Source/derivation of the proposed IACS Resolution**

N/A

**4. Summary of Changes intended for the revised Resolution**

- 1) List examples of design changes considered as "totally new design".
- 2) Clarify that 500 load cycles tests are required not only for high-speed engines but for low and medium speed engines.
- 3) Clarify the containment test temperature.
- 4) Specify that manufacturers are to determine whether test conditions more critical than those defined in M73 exist with respect to containment safety.

**5. Points of discussions or possible discussions**

Regarding 500 load cycles tests, a member understood that the turbochargers for high-speed engines installed in high-speed vessels such as patrol vessels and fishing vessels should undergo the 500 load cycles test because those vessels perform quick and repeated start-stop operations, but it is not necessary to conduct the test for turbochargers for low and medium-speed engines typically installed in merchant vessels because those vessels don't perform such operations. However, majority disagreed with the above view.

Regarding the test temperature, a member pointed out that, unlike the speed, it is difficult to cause a burst at the intended temperature. However, there was a dissenting opinion that the test could actually be conducted, and this was not reflected in this UR.

**6. Attachments if any**

None

# UR M74 “Ballast Water Management Systems”

## Summary

In Rev.2 of this Resolution, the outcome of comprehensive review of the existing requirements has been reflected.

## Part A. Revision History

Version no.	Approval date	Implementation date when applicable
Rev.2 (June 2021)	01 June 2021	1 July 2022
Rev.1 (Dec 2014)	19 May 2016	1 January 2017
New (Sept 2015)	17 September 2015	1 January 2017

### • Rev.2 (June 2021)

#### 1 Origin of Change:

- Request by non-IACS entity (INTERCARGO)

#### 2 Main Reason for Change:

- To address the following priority work:
  - 1.1. Align the requirements of IACS UR M74 with IEC 60092-502, SOLAS, IMO IBC and IGC Codes and UI SC 274;
  - 1.2. Separate clearly in the revised text of UR M74 the requirements which are exclusively applicable to tankers from the requirements applicable to any other type of ship;
  - 1.3. Extend the sketches of UR M74 to the most complete range of BWMS (including UV and electrolysis systems representing more than 90% of the BWMS's market);
  - 1.4. Align the requirements of UR M74 with UR P2;
  - 1.5. Analyse the applicability, the scope and the objective of the risk assessment specified in UR M74 § 3.4.4 to ensure that the operational limitations and need for mitigation measures are anticipated upstream from manufacturer's side and capitalized in a generic design appraisal process of manufacturer's package before shipyard's submission of the installation drawings for each installation on board a specific ship;
  - 1.6. Beyond the Statutory Type Approval Certification issued by the Administration for the compliance with IMO G8 Guideline, analyse the applicability, the scope and the objective of the Type Approval Certification process (or equivalent) to ensure that the type of BWMS

complies with the Classification Rules and to ensure a consistent implementation for each installation on board (for new building and retrofit installation) as well as for the replacement of components during the lifecycle of the ship.

- 1.a. Revise UR M74 with regards to the above objectives 1.1. to 1.4.
- 1.b. Include all the potential benefits for the design review process by Classification Societies with regards to the above objectives 1.5. and 1.6. in the revised text of UR M74 or propose follow-up actions to the Machinery Panel.
- To address risks associated with various types of BWTS.
- To address the other priority work as follows:
  - 2.1. to analyse the concerns raised by INTERCARGO related to "retrofit problems" with regards to the following:
    - a. power consumption, mechanical reliability, replacement of components and consumables;
    - b. INTERCARGO's clarification expressed in MEPC 71/4/19 and MEPC 71/INF.20;
  - 2.2. to include the concerns raised by INTERCARGO with regards to the above objective 2.1. in the revised text of UR M74 or propose follow-up actions to the Machinery Panel.
  - 3. to analyse the additional concerns which extend beyond the objective 2., to include these additional considerations in the revised text of UR M74.

### **3 List of non-IACS Member classification societies contributing or participating in IACS Working Group:**

None

### **4 History of Decisions Made:**

- By 16208\_IGa (2016-11-4) followed by IGb (2016-11-13), Machinery Panel was tasked to revise the UR M74 with the view of addressing the concerns raised by INTERCARGO related to the "retrofitting problems" on existing ships.
- Machinery Panel's reference PM11902bIMc dated 2017-01-16 where the creation of a Project Team to address the task PM11902b was agreed.
- Machinery Panel's reference PM11902bIMd dated 2017-03-14 deciding to conglobate the two tasks PM11902a and PM11902b in one task renumbered "PM11902b" for the works of the Project Team PT PM42/2017.

- By 16208IGe (2017-05-16) Machinery Panel was tasked to review the documents MEPC 71/INF.20 (*Information on the technical and operational challenges of retrofitting ballast water treatment systems on existing bulk carriers*) and MEPC 71/4/19 (*Challenges faced by bulk carrier owners and operators*) prepared by INTERCARGO for the 71th session of the IMO MEPC.
- By 17162IGa (2017-11-01), the first stage of PT PM 42/2017 discussion was provided to Safety Panel for their use under the task reference PS17030a (SP14017p): discuss fire safety protection issues associated with various types of BWTS considering the work of Machinery Panel's PM42/2017.
- Discussion was commenced to review the outcome of the PT PM 42/2017 in December 2019, and Rev.2 of this Resolution was agreed in February 2021.
- Furthermore, the following discussion was carried out:
  - o After review of one of the F series URs developed by Safety Panel on BWMS, it was agreed to delete the proposed paragraph in UR M74.3.3.1.5 which was intended to require "interlock".
  - o After review of the definitions of the cargo area for oil tankers and for chemical tankers, it was agreed that only the definition for oil tankers should be changed.

## 5 Other Resolutions Changes:

None

## 6 Any hinderance to MASS, including any other new technologies:

None

## 7 Dates:

Original Proposal: 04 November 2016 (Ref: 16208\_IGa\_IMd)  
 Panel Approval: 10 May 2021 (Ref: PM11902dIMd)  
 GPG Approval: 01 June 2021 (Ref: 16208\_IGp)

## • Rev.1 (May 2016)

### 1 Origin for Change:

- Suggestion by IACS member

### 2 Main Reason for Change:

To address GPG's comments on the UR M74 (New Sept 2015) as well as additional issues raised by Machinery Panel members.

### 3 List of non-IACS Member classification societies contributing through the TC Forum and/or participating in IACS Working Group:

None

#### **4 History of Decisions Made:**

The amendment to paragraph 3.1.7.1 proposed by GPG was generally agreed by the Panel subject to the deletion of “and PSC purpose” considering that the sampling point for PSC purpose is specified in paragraph 5.2 of Res. MEPC.173(58).

Regarding the proposed text as new paragraph 3.1.7.2, the Panel agreed with the philosophy but considers that ‘correct operation’ is undefined and the term ‘system’ could be referring to the whole system, or just the sampling system.

A Panel member proposed to revise the para 3.2.3.3 of the UR to add a non-return valve to the double block and bleed arrangement for the following reasons:

- the revised FSS Code requires the two means to prevent the backflow.
- the automatic double block and bleed valves are less safe than the other arrangements mentioned in 3.2.3.1 and 3.2.3.2 in the UR.

This proposal was supported by the majority thus agreed by the Machinery Panel.

The Machinery Panel, at its 21st meeting, agreed to revise the wording in para 3.1.3 of the UR to introduce the requirement on minimum treatment rate while operates the BWMS.

The Panel also agreed to update the definition of hazardous area in para 2.3 of the UR to align it with the IGC Code.

Noting the original version (New, Sept 2015) of UR M74 is not yet in force, GPG approved that the same uniform implementation date (1 January 2017) should be applied to the revision 1.

Considering that the existing uniform implementation statement in New (Sept 2015) can be also interpreted as the date of application to survey installations for BWMS onboard, GPG agreed to update the statement to clarify that the UR is to apply when a request to approve plans is made on or after 1 January 2017.

#### **5 Other Resolutions Changes**

None

#### **6 Dates:**

Panel Approval: 27 January 2016 (Ref: PM11902)

GPG Approval: 19 May 2016 (Ref: 11164\_IGq)

#### **• New (Sept 2015)**

##### **1 Origin for Change:**

- Other (triggered by the Panel at the 12th meeting)

##### **2 Main Reason for Change:**

Despite the fact that the BWM Convention (2004) is expected to enter into force soon, the current UR set does not cover the issues raised with respect to the installation of the Ballast Water Management Systems (BWMS). For this reason, the Panel has decided to develop a relevant UR to assist shipyards, ship owners and makers of BWMS in view of smooth implementation of the Convention.

**3 List of non-IACS Member classification societies contributing through the TC Forum and/or participating in IACS Working Group:**

None

**4 History of Decisions Made:**

Form A agreed by GPG under 11164\_IGd dated 27 December 2011.

**5 Other Resolutions Changes**

None

**6 Dates:**

Original Proposal: 14 October 2011 (Ref: 11164\_PMa)

Panel Approval: 1 June 2015 (Ref: PM11902)

GPG Approval: 17 September 2015 (Ref: 11164\_IGm)

\*\*\*\*\*

## Part B. Technical Background

List of Technical Background (TB) documents for UR M74:

Annex 1. **TB for New (Sept 2015)**

See separate TB document in Annex 1.

Annex 2. **TB for Rev.2 (June 2021)**

See separate TB document in Annex 2.



**Note:** *There is no Technical Background (TB) document available for Rev.1 (May 2016).*

## Technical Background document for UR M74 (New, Sept 2015)

### 1. Scope and objectives

The BWM Convention (2004)<sup>1</sup> will enter into force soon. However, there is no unified requirement with respect to the installation of the Ballast Water Management Systems (BWMS). For this reason, the Machinery Panel has decided to develop a relevant UR 'Installation of ballast water management system' through PT11902. The benefit of undertaking the task is to provide specified requirements for shipyards, ship owners and makers of BWMS, which will in turn assist in smooth implementation of the Convention.

### 2. Engineering background for technical basis and rationale

This UR has been developed based on the results of the risk assessment and each PT member's experience/knowledge as there is no relevant rule except for BWM Convention 2004. The specific procedures for developing the UR are as follows:

1. To investigate BWMS approved by IMO so far;
2. To categorize types of BWMS;
3. To assess the risk of each type of BWMS (i.e. Piping Leaks, Explosion, etc.)
4. To categorize places where BWMS are installed (i.e. Dangerous area and safe area);
5. To develop the frame of UR (i.e. 1. Application, 2. Definition, etc.); and
6. To develop a draft UR based on identified risks and places where BWMS are installed, taking into account the following observations:
  - a. class involvement may potentially be relevant for the consideration of other aspects (extending beyond the actual management performance of the system)
  - b. broader aspects in relation with the integration of a ballast management system with other shipboard systems;

### 3. Source / derivation of the proposed IACS Resolution

1. BWM Convention (2004)
2. BWM.2/Circ.30: List of ballast water management systems that make use of Active Substances which received Basic and Final Approvals (2010)
3. IEC 60092-502: 1999 'Electrical installations in ships – Tankers'
4. IEC 60079: Electrical apparatus for explosive gas atmospheres
5. ABS GUIDE FOR BALLAST WATER TREATMENT Section.4/3.3 Ventilation System
6. IACS Recommendation No.9 Guidelines for installation of cargo oil discharge monitoring and control system on board oil tanker (Sept. 2005 Deleted)
7. MSC 292(87): ADOPTION OF AMENDMENTS TO THE INTERNATIONAL CODE FOR FIRE SAFETY SYSTEMS (2010)
8. MSC.1/Circ.1370: GUIDELINES FOR THE DESIGN, CONSTRUCTION AND TESTING OF FIXED HYDROCARBON GAS DETECTION SYSTEMS (2010)
9. SOLAS Reg.II-2/9

---

<sup>1</sup> BWM Convention (2004): International Convention for the Control and Management of Ship's Ballast Water and Sediments adopted 13 Feb. 2004



#### 4. Summary of Changes intended for the revised Resolution

None

#### 5. Points of discussions or possible discussions

##### (1) Means of protection from the overflow

PT Members unanimously agreed to the following requirement 3.1.3 in the draft for the prevention of sustained flow including an audible and visible alarm with the values in the square brackets based on each member's experience.

『3.1.3 Means are to be provided to protect BWMS from the sustained flow which exceeds the [110]% of TRC for [60] seconds. An audible and visible alarm is to be activated when the flow exceeds [105]% of TRC.』

However, some members in the Machinery Panel pointed out that the wording 3.1.3 in the draft does not in line with the G8 and G9 of BWM Convention because the threshold level for alarming is subject to Flag Administration TA. Therefore, the following revised wording is inserted in the final draft.

『3.1.3 The BWMS is to be operated at a flow rate which does not exceed the Treatment Rated Capacity (hereinafter referred to as 'TRC') specified in the Type Approval Certificate (TAC) of flag administration.』

##### (2) How to arrange BWMS in tankers

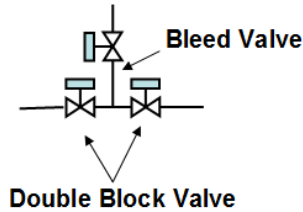
The requirement 3.2.2 in the draft was a highly controversial topic.

In case of tankers carrying flammable liquids having a flashpoint not exceeding 60 °C or products listed in IBC Code Ch.17, two sets of an independent BWMS are required in principle – i.e. one for ballast tanks in hazardous areas and the other for ballast tanks in non-hazardous areas. However, it was generally agreed that two sets of an independent BWMS in one vessel could be a burden for ship owners. For these reasons, all members of PT11902 tried to find a solution and found out 'an appropriate isolation arrangement' to install 'one' BWMS in tankers. Subsequently, the following two isolation methods were proposed in the draft as appropriate isolation.

- i) Two(2) screw down check valves in series



- ii) Automatic double block and bleed valves



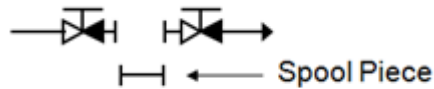
However, some members in the Machinery Panel raised reservations about the safety level of appropriate isolation arrangement, especially 'Automatic double block and bleed valves'.

For this reason, industry hearing was carried out to reflect the opinion of shipyards and ship owners on this matter. Industries have had a general consensus on our intention and agreed with the concept of 'Two (2) screw down check valves in series'.

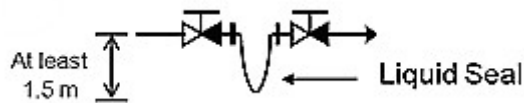
But they also have some doubts on the safety of 'Automatic double block and bleed valves', especially in case of the failure of valves, just like the members of IACS Machinery Panel pointed out. And, therefore, they have the less positive view on this arrangement, 'Automatic double block and bleed valves', expecting little profit in spite of lots of effort.

In consideration of the opinions by panel members and industries, it was decided to withdraw the proposal 'Automatic double block and bleed valves' and only consider two of the methods as appropriate isolation. However, GPG agreed to retain it. "Automatic double block and bleed valves" as an acceptable arrangement in 3.2.3. Means of appropriate isolation are therefore as follows:

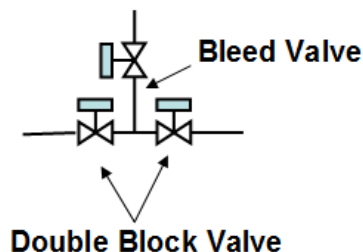
- .1 Two screw down check valves in series with a spool piece, or



- .2 Two screw down check valves in series with a liquid seal at least 1.5 m in depth, or



- .3 Automatic double block and bleed valves

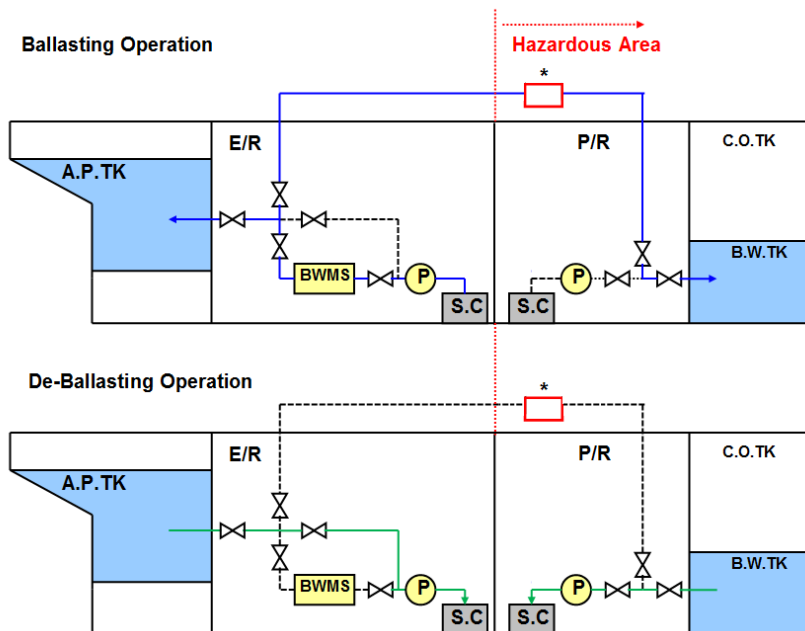


Examples of appropriate isolation arrangements are shown in Annex I. Isolation arrangements are to be fitted on the exposed deck in the hazardous area. Also, ballast

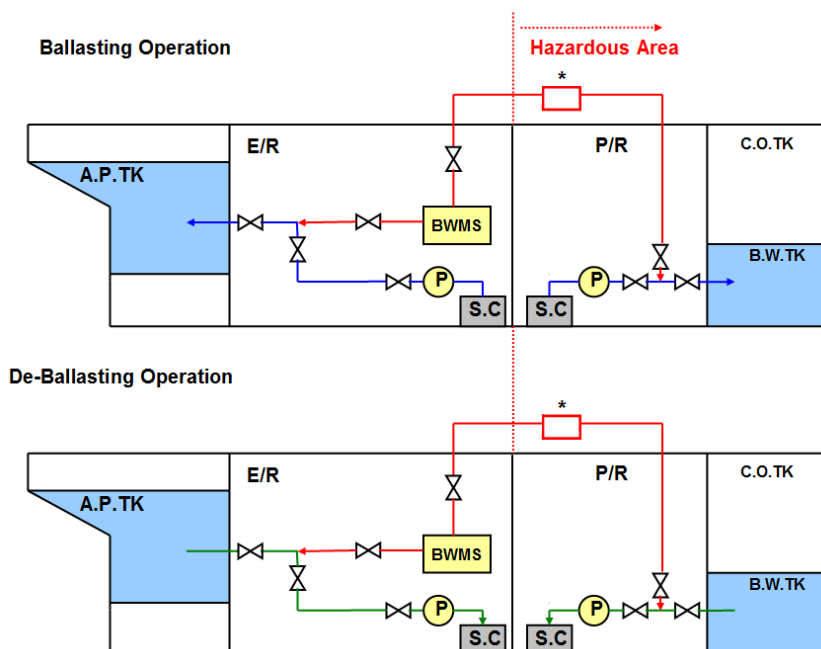
water originating from a hazardous area is not to discharge into a non-hazardous area, except as given by 3.1.7.

Annex I:

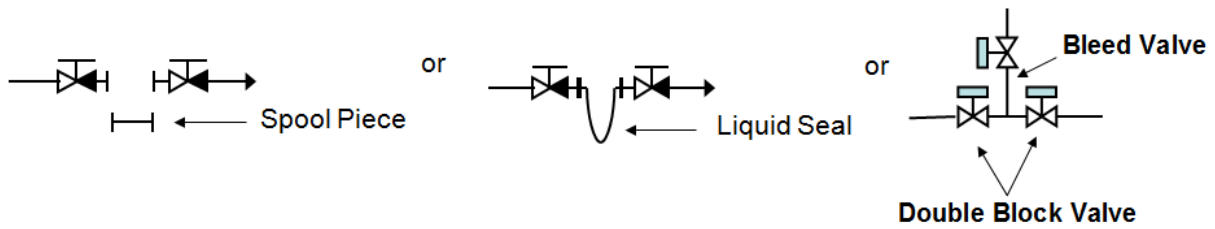
- BWMS which does not require after-treatment



- BWMS which requires after-treatment [Injection Type]



\* : Appropriate Isolation Means: Two (2) screw down check valves in series with a spool piece or a liquid seal, or automatic double block and bleed valves



### (3) Ventilation

The below table in the draft was developed based on the ABS GUIDE FOR BALLAST WATER TREATMENT, 'Section.4 / 3.3 Ventilation System'.

		BWMS in an enclosed space with access to hazardous area, Zone 1 <sup>1</sup>	BWMS in an enclosed space with access to hazardous area, Zone 2 <sup>1</sup>	
			Option 1	Option 2
Over-press. protection <sup>2</sup>	Overpressure ventilation	O	O	
	Overpressure loss alarm	O	O	
	Automatic power disconnection	O	O	
Air lock protection <sup>3</sup>	Air lock access	O		O
Mechanical ventilation <sup>4</sup>	At least 6 air change/hr			O
	Ventilation failure alarm			O
1. Refer to IEC60092-502 Clause 3.15. 2. Refer to IEC60092-502 Clause 8.4. 3. Refer to IEC60092-502 Clause 8.3. 4. The access is fitted with two doors forming an air-lock, both gas-tight, self-closing and without holding back arrangements.				

However, the above table is simplified as the following wording, '3.3 Ventilation', in the final draft because some members gave comments that it is so complicated.

### 3.3 Ventilation

#### 3.3.1 BWMS not in hazardous areas

- .1 A BWMS that does not generate dangerous gas is to be located in an adequately ventilated area.
- .2 A BWMS that generates dangerous gas is to be located in the space fitted with a mechanical ventilation system providing at least six (6) air changes per hour or as specified by the BWMS manufacturer, whichever is greater.

#### 3.3.2 BWMS in hazardous areas

A BWMS, regardless of generating dangerous gas, is to be located in the space fitted with mechanical ventilation complying with relevant requirements, i.e. IEC60092-502, IBC code, IGC code, etc.」

#### (4) Special Requirements

During the 20th machinery panel meeting dated from 16th to 19th Sept. 2014, Panel discussed how to deal with oily bilge water from the space where BWMS was located. Some members thought that the oily bilge water could be neglected due to the small amount, it can be treated as the same to the space for hydraulic machinery. Some members thought that even if there was a little leakage oily water, it can be accumulated by appropriate tray. After discussion, most of members thought it was unnecessary to address some requirements for oily bilge water from the space whether BWMS was located.

#### (5) Application of PV valves to de-oxidation type of BWMS

Paragraph 3.1.8 was proposed to allow the application of PV valves to de-oxidation type of BWMS, which requires an effective means to segregate ballast tanks from open air during the ballast water treatment process.

3.1.8 Pressure-vacuum valves (PV valves) may be accepted for closing devices of air pipes where the ballast water tanks are required to be closed due to the method of the BWMS, e.g. De-oxidation type of BWMS.

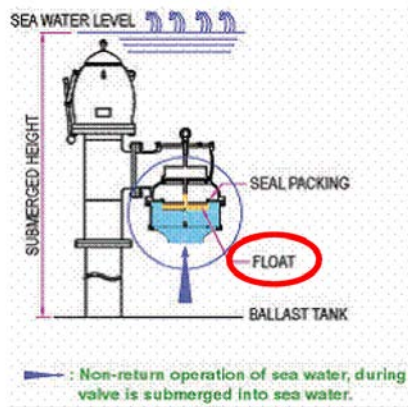
Several members argued that PV valves might be accepted only on tankers in accordance with Reg.20(4) of the ICLL Convention. In the prolonged discussion, however, considering the characteristics of de-oxidation type of BWMS, the Panel agreed to adopt PV valves as a practical means of segregation from open air.

In this case, ballast tanks should also be fulfilled the requirements of Reg. 20 of ICLL Convention. Following arrangements were suggested as satisfying such requirements;

- i) A possible solution proposed is to combine a closable air pipe head at convention height above the deck and a PV valve at a height above the deck, both depending on location onboard. In other words, it proposes to fit a closable air pipe head at the height above the deck (760 mm / 450 mm) according to Reg. 20 of ICLL Convention and additionally to fit a PV valve at the height above the deck (4500 mm / 2300 mm) as a means of segregating the ballast tank from the air in order to comply with current ICLL Regulations and at the same time to adopt a PV valve as a practical means of segregation for the de-oxidation type of BWMS.
- ii) If PV valves are applied, water on deck may flood easily into ballast tanks through the vacuum side of PV valves since the vacuum side of PV valves can be simply opened by the water ingress pressure. Therefore, the vacuum side of PV valves should be considered as open-end. One possible solution discussed was to assemble an automatic closing device to the vacuum side so that it can prevent water ingress through vacuum side of PV valves. Alternatively, PV valves equipped with a floater inside the chamber to prevent the flooding into

the tank may be utilised to prevent penetration of sea water (See the figure below).

10. Optional arrangement 2.  
for water ballast tanks



Finally, Machinery Panel decided to remove paragraph 3.1.8 from the UR and to insert the above into the Technical Background under the points of discussions.

## 6. Attachments if any

None

## Technical Background document for UR M74 (Rev.2 June 2021)

### 1 Scope and objectives

1. Investigate all the BWMS on the market (Attachment 1) and provide a complete categorization of the available technologies (Table 1 and Annex II of UR M74 Rev.2).
2. Identify the specific hazards associated with the various BWMS technologies and provide the necessary requirements in Rev.2 when this was not covered in the Rev.1 (Attachment2, Table 2).
3. Separate from the UR M74 all the requirements related to fire safety that will be addressed by the Safety Panel PT PS17030a (Attachment 2, Table 2).
4. Apply the above principles set in 4. to the full range of in-line BWMS technologies identified in 1. and extend the Annex I accordingly (Rev.2 Annex I).
5. Align the requirements with the other IACS UR and UI, IMO regulations and IEC standards.
6. Revamp the vague expressions of the Rev.1 that could be subject to non-harmonized interpretations.
7. Provide the necessary requirements to ensure that the Rules from the Classification Societies will be fully implemented.
8. Clarify the applicability and scope of the risk assessment specified in UR M74 § 3.4.4
9. Beyond the statutory Type Approval Certification issued by the Administrations or their RO in the scope of the IMO Convention (G8 Guideline and BWMS Code), clarify the applicability and scope of the Type Approval Certification conducted for BWMS in the scope of Classification Rules and certification of components in the scope of Classification Rules
10. Address the concerns raised by INTERCARGO related to "retrofit problems".

### 2 Engineering background for technical basis and rationale

See Attachment 3.

### 3 Source/derivation of the proposed IACS Resolution

The Rev.2 is based on deep and thorough consideration of the following IMO, IACS and IEC requirements:

1. 2004 BWM Convention, IMO BWM/CONF/36 entered into force on 08 September 2017
2. 2008 G2 Guideline: IMO MEPC Res. 173(58) - Guidelines for ballast water sampling

→ Reference made in §3.2. 4 of the Rev.2 for the sampling lines (§3.1.7 in Rev.1)

3. 2008 G8 Guideline: IMO MEPC Res. 174(58) - Guidelines for the approval of BWMS

4. 2016 G8 Guideline: IMO MEPC 279(70) - Guidelines for the approval of BWMS that applies:

- a. when approving BWMS as soon as possible, but not later than 28 October 2018; and,
- b. for any BWMS installed on ships on or after 28 October 2020.
- c. BWMS installed on board ships prior to 28 October 2020 should be approved taking into account either the 2008 G8 Guideline, or preferably the 2016 G8 Guidelines.

→ Reference made for the implementation date of the Rev.2 at Note (3) of the front page.

Rev.2 of this UR is to be uniformly implemented by IACS Societies for BWMS:

i) For existing ships, where an application for approval for the plans of BWMS is made on or after 1 January 2022; or

ii) For new ships contracted for construction on or after 1 January 2022.

5. 2008 G9 Guideline: IMO MEPC Res. 169(57) - Procedure for approval of BWMS that make use of active substances

6. IMO (GESAMP) MEPC Reports for the Basic and Final approval in accordance with the G9 Guideline which provide for the concerned BWMS the necessary information for the assessment related to the presence of dangerous liquids or dangerous gas, the chemical reactions in presence, the necessary safety measures to be considered, etc.

→ Reference made for the safety assessment addressed by Note (1) of Table 1, Note (2) of §3.3.2, Note of §3.3.3.5 and Note of §3.3.4 of the Rev.2

7. IMO BWM.2/Circ. 7: Interim Survey Guidelines for the purpose of the International Convention for the Control and Management of Ship's Ballast Water and Sediments under the Harmonized System of Survey and Certification (Res. A.948(23)) implemented in 2017's HSSC Code Res. A.1120(30).

8. IMO BWM.2/Circ. 20: Guidance to ensure safe handling and storage of chemicals and preparations used to treat ballast water and the development of safety procedures for risks to the ship and crew resulting from the treatment process

9. IMO BWM.2/Circ.34/Rev.6: List of ballast water management systems that make use of active substances which received Basic and Final Approvals (2017)



10. IMO's document in Attachment 1, Table 3: List of BWMS which received Type Approval Certification by their respective Administrations (resolutions MEPC.175(58) and MEPC.228(65))

11. SOLAS Ch. II-2 Reg. 3/6: Definition of "cargo area" for oil tankers

→ Reference made in §2.2 of the Rev.2 and corrected in §3.2 of the Rev.2

12. IBC Code Ch. 1.3.6: Definition of "cargo area" for chemical tankers

→ Reference made in §2.2 of the Rev.2 and corrected in §3.2 of the Rev.2

13. IGC Code Ch. 1.2.7: Definition of "cargo area" for gas carriers

→ Reference made in §2.2 of the Rev.2 and corrected in §3.2 of the Rev.2

14. Note: On gas carriers, there is no ballast tank falling under the definition of "cargo area".

15. IMO Res. A.673(16) as amended by MSC Res. 236(82) Ch. 1.3.1 (or OSV Chemical Code Res. A.1122(30) Ch 1.2.7): Definition of "cargo area" for OSV transporting and handling limited amount of noxious and hazardous substances in bulk

→ Reference made in §2.2 of the Rev.2 and corrected in §3.2 of the Rev.2

16. FSS Code Ch. 15 as amended by IMO MSC Res. 367(93): Inert gas systems

→ Reference made in §3.1.7 of the Rev.2 to select the applicable requirements for BWMS categories 3a, 3b, 3c and 8

→ Reference used in §2.2.3.1.3 of FSS Code Ch 15 for modifying "screw-down non-return valve" of the Rev.1 to "non-return valve with positive means of closure" + "Note: As an alternative of the means of closure, an additional valve having such means of closure may be provided between the non-return valve and..." in §3.2.3 of the Rev.2

→ Reference used in §2.3.1.1.2 of FSS Code Ch 15 to prohibit the installation of BWMS categories 3b and 3c in cargo area in §3.2.1.1 of the Rev.2

17. FSS Code Ch. 16, IMO MSC Res. 292(86): Fixed hydrocarbon gas detection systems

→ Reference used in § 3.2.4 of the Rev.2 (previously §3.1.7 in Rev.1).

18. IMO MSC.1 Circ. 1370: Guidelines for the design, construction and testing of fixed hydrocarbon gas detection systems

19. IACS UR P2 Rev.2 (November 2001): Rules for pipes

→ Reference made to UR P2 Table 1 in §3.3.2.1 of Rev.2 for the selection of the applicable Class of piping conveying dangerous gas (example O<sub>2</sub> by-product, CH<sub>4</sub> by product, O<sub>3</sub> active substance, H<sub>2</sub> by-product) or dangerous liquids (example

sulfuric acid active substance): Class I without special safeguards or Class II with special safeguard

- Reference made to Note 1) of Table 1 of UR P2 in Note 1) of §3.3.2.1 of Rev.2 to specify the acceptable "special safeguards" in case of Class II piping conveying dangerous gas (ex. O<sub>2</sub>, O<sub>3</sub>, H<sub>2</sub>): only pipe duct or double walled pipe can reduce a gas leakage and limit its consequences
- Reference made to Note 1) of UR P2 Table 1 in Note 2) of §3.3.2.1 of Rev.2 to specify the acceptable "special safeguards" in case of Class II piping conveying dangerous liquids (ex. Sulfuric acid): additional safeguard may be considered such as shielding, screening, etc.

20. IACS UR P4 Rev.4 (December 2008): Production and application of plastic pipes on ships

- Reference made in Note 3) §3.3.2.1 of Rev.2

21. IACS UR F20 Rev.7 (May 2015): Inert gas systems

- Reference made in §3.1.3.1.7 of Rev.2
- Reference used in Note of §3.2.1.1 of Rev.2 to make the difference in between BWMS using an Inert Gas Generator (categories 3b or 3c) and BWMS using a Nitrogen Generator (categories 3a and 8).
- Reference made to the foot note \*) "safe location" of UR F20 in Footnote \*) of Rev.2

22. IACS UR F44 Rev.2 (October 2010): Fore peak ballast systems on oil tankers

- Reference made in Note §3.2.2 of Rev.2 to use the same BWMS for both Fore Peak Tank (that could be located outside the cargo area) and the other ballast water tanks within the cargo area when they are all supplied by the same ballasting system in accordance with the UR F44.

23. IACS UI SC274 (December 2015): Hazardous area classification in respect of selection of electrical equipment, cables and wiring and positioning of openings and air intakes

- Reference made in §3.2.1 of Rev.2.

24. IEC 60092-502 (1999) §3.15: Definition of "hazardous area"

- Reference made in §2.5 of the Rev.2 to tackle the inconsistencies of Rev.1.

25. IEC 60092-502 (1999) § 4.2.2.7: 3m zone 1 beyond gas or vapour outlet

- Reference made in Footnote \*) of the Rev.2 (outlet of the H<sub>2</sub> degas device)

26. IEC 60092-502 (1999) §4.2.2.9: 1.5m zone 1 beyond openings into cofferdams or other zone 1 spaces

→ Reference made in § 3.1.5 of the Rev.2 (outlet of the P/V protecting devices installed on ballast water tanks)

27. IEC 60092-502 (1999) §4.2.2.9: 1.5m zone 2 beyond zone 1 as specified in 4.2.2

→ Reference made in Footnote \*) and 3.1.5 of the Rev.2

28. IEC 60079-29 which includes not only Part 29-1: Gas detectors - Performance requirements of detectors for flammable gases; but also

- a. Part 29-2: Gas detectors - Selection, installation, use and maintenance of detectors for flammable gases and oxygen; and
- b. Part 29-3: Gas detectors - Guidance on functional safety of fixed gas detection systems; and
- c. Part 29-4: Gas detectors - Performance requirements of open path detectors for flammable gases; and

→ Reference made to IEC 60079-29 in §3.3.1.1 of Rev.2 instead of 60079-29-1 (Rev.1) to include also the 60079-29-2 and 60079-29-3 and 60079-29-4

#### **4 Summary of Changes intended for the revised Resolution**

Comprehensive revision as highlighted in the underlined version of Rev.2.

#### **5 Points of discussions or possible discussions**

See Attachment 3.

#### **6 Attachments if any**

- **Attachment 1:** IMO's list of the 83 BWMS which have received Type Approval Certification by their respective Administrations (updated in December 2019).
- **Attachment 2:** BWMS Technologies – Identification of the specific hazards
  - o Table 1: Proposal from PT PM 42/2017: issues addressed by the Machinery Panel through the UR M74 Rev.2
  - o Table 2: Proposal from PT PM 42/2017: Fire safety protection issues to be addressed by the Safety Panel PT through PS17030a (SP14017p)
- **Attachment 3:** Detailed Engineering Background and Points of Discussion

\*\*\*\*\*

**Table 1: List of ballast water management systems that make use of Active Substances which received Basic Approval from IMO<sup>1</sup>**

	<b>Name of the system and proposing country</b>	<b>Name of manufacturer</b>	<b>Date of Basic Approval</b>
1	Peraclean® Ocean (subsequently changed to SEDNA® Ballast Water Management System (Using Peraclean® Ocean)), Germany	Degussa GmbH, Germany	24 March 2006 (MEPC 54)
2	Electro-Clean (electrolytic disinfection) system (subsequently changed to Electro-Cleen™), Republic of Korea	Techcross Ltd. and Korea Ocean Research and Development Institute (KORDI)	24 March 2006 (MEPC 54)
3	Special Pipe Ballast Water Management System (combined with Ozone treatment), Japan (subsequently changed to FineBallast OZ (the Special Pipe Hybrid Ballast Water Management System combined with Ozone treatment version))	Japan Association of Marine Safety (JAMS)	13 October 2006 (MEPC 55)
4	EctoSys™ electrochemical system, Sweden (subsequently changed to the RWO ballast water management system)	Permascand AB, Sweden, subsequently acquired by RWO GmbH, Germany	13 October 2006 (MEPC 55)
5	PureBallast System, Sweden	Alfa Laval/Wallenius Water AB	13 July 2007 (MEPC 56)
6	NK Ballast Water Treatment System, Republic of Korea (subsequently changed to NK-O3 BlueBallast System (Ozone))	NK Company Ltd., Republic of Korea	13 July 2007 (MEPC 56)
7	Hitachi Ballast Water Purification System (ClearBallast), Japan	Hitachi, Ltd./Hitachi Plant technologies, Ltd.	4 April 2008 (MEPC 57)
8	Resource Ballast Technologies System, South Africa	Resource Ballast Technologies (Pty) Ltd.	4 April 2008 (MEPC 57)
9	GloEn-Patrol™ Ballast Water Management System, Republic of Korea	Panasia Co., Ltd.	4 April 2008 (MEPC 57)
10	OceanSaver® Ballast Water Management System, Norway	MetaFil AS (subsequently changed to OceanSaver AS)	4 April 2008 (MEPC 57)
11	TG Ballastcleaner and TG Environmentalguard System (subsequently changed to JFE Ballast Water Management System), Japan	The Toagosei Group (TG Corporation, Toagosei Co., Ltd. and Tsurumi Soda Co., Ltd.)	10 October 2008 (MEPC 58)
12	Greenship Sedinox Ballast Water Management System, the Netherlands	Greenship Ltd	10 October 2008 (MEPC 58)
13	Ecochlor® Ballast Water Treatment System, Germany	Ecochlor, Inc, Acton, the United States	10 October 2008 (MEPC 58)
14	Blue Ocean Shield Ballast Water Management System, China	China Ocean Shipping (Group) Company (COSCO)	17 July 2009 (MEPC 59)

<sup>1</sup> More comprehensive information regarding the systems approved until May 2019 is available in document BWM.2/Circ.34/Rev.8.

Table 1 (continued)

	<b>Name of the system and proposing country</b>	<b>Name of manufacturer</b>	<b>Date of Basic Approval</b>
15	Hyundai Heavy Industries Co., Ltd. (HHI) Ballast Water Management System (EcoBallast), Republic of Korea	Hyundai Heavy Industries Co., Ltd., Republic of Korea	17 July 2009 (MEPC 59)
16	AquaTriComb™ Ballast Water Treatment System, Germany	Aquaworx ATC GmbH	17 July 2009 (MEPC 59)
17	SiCURE™ Ballast Water Management System, Germany	Siemens Water Technologies	26 March 2010 (MEPC 60)
18	Sunrui Ballast Water Management System (subsequently changed to BalClor Ballast Water Management System), China	Qingdao Sunrui Corrosion and Fouling Control Company	26 March 2010 (MEPC 60)
19	DESMI Ocean Guard Ballast Water Management System, Denmark	DESMI Ocean Guard A/S	26 March 2010 (MEPC 60)
20	Blue Ocean Guardian (BOG) Ballast Water Management System, (subsequently changed to "ARA Ballast" Ballast Water Management System), Republic of Korea	21st Century Shipbuilding Co., Ltd.	26 March 2010 (MEPC 60)
21	Hyundai Heavy Industries Co., Ltd. (HHI) Ballast Water Management System (HiBallast), Republic of Korea	Hyundai Heavy Industries Co., Ltd., Republic of Korea	26 March 2010 (MEPC 60)
22	Kwang San Co., Ltd. (KS) Ballast Water Management System "En-Ballast", Republic of Korea	Kwang San Co., Ltd.	26 March 2010 (MEPC 60)
23	OceanGuard™ Ballast Water Management System, Norway	Qingdao Headway Technology Co., Ltd.	26 March 2010 (MEPC 60)
24	Severn Trent DeNora BalPure® Ballast Water Management System (subsequently changed to BalPure® BP-500), Germany	Severn Trent De Nora (STDN), LLC	26 March 2010 (MEPC 60)
25	Techwin Eco Co., Ltd. (TWECO) Ballast Water Management System (Purimar), Republic of Korea	Techwin Eco Co., Ltd. Purchased by Samsung	1 October 2010 (MEPC 61)
26	AquaStar Ballast Water Management System, Republic of Korea (subsequently changed to AquaStar™ BWMS and MACGREGOR WATER BALLAST TREATMENT SYSTEM)	AQUA Eng. Co., Ltd.	1 October 2010 (MEPC 61)
27	Kuraray Ballast Water Management System, (subsequently changed to MICROFADE™ Ballast Water Management System), Japan	Kuraray Co., Ltd.	1 October 2010 (MEPC 61)
28	ERMA FIRST Ballast Water Management System (subsequently changed to ERMA FIRST BWTS), Greece	ERMA FIRST ESK Engineering Solutions S.A.	15 July 2011 (MEPC 62)
29	BlueSeas Ballast Water Management System, Singapore	Envirotech and Consultancy Pte. Ltd.	15 July 2011 (MEPC 62)
30	SKY-SYSTEM® with Peraclean® Ocean Ballast Water Management System, Japan	Katayama Chemical, Inc.	15 July 2011 (MEPC 62)

Table 1 (continued)

	Name of the system and proposing country	Name of manufacturer	Date of Basic Approval
31	JFE BallastAce that makes use of NeoChlor Marine® Ballast Water Management System, Japan	JFE Engineering Corporation	15 July 2011 (MEPC 62)
32	BallastMaster Ballast Water Management System, Germany	GEA Westfalia Separator Systems GmbH	15 July 2011 (MEPC 62)
33	BlueWorld Ballast Water Management System, Singapore	Envirotech and Consultancy Pte. Ltd.	15 July 2011 (MEPC 62)
34	Neo-Purimar™ Ballast Water Management System, Republic of Korea	Samsung Heavy Industries Co., Ltd.	15 July 2011 (MEPC 62)
35	"Smart Ballast" Ballast Water Management System, Republic of Korea	STX Metal Co., Ltd.	2 March 2012 (MEPC 63)
36	DMU ·OH Ballast Water Management System, China	Dalian Maritime University	2 March 2012 (MEPC 63)
37	EcoGuardian™ Ballast Water Management System, Republic of Korea	Hania IMS Co., Ltd.	2 March 2012 (MEPC 63)
38	KTM-Ballast Water Management System, Republic of Korea (subsequently changed to MARINOMATE™ Ballast Water Management System)	Korea Top Marine (KT Marine) Co., Ltd.	5 October 2012 (MEPC 64)
39	Hamworthy Aquarius™-EC BWMS, the Netherlands (subsequently changed to Aquarius™-EC BWMS)	Hamworthy Water Systems Ltd.	5 October 2012 (MEPC 64)
40	OceanDoctor Ballast Water Management System, China	Jiujiang Precision Measuring Technology Research Institute	5 October 2012 (MEPC 64)
41	HS-BALLAST Ballast Water Management System, Republic of Korea	HWASEUNG R&A Co., Ltd.	5 October 2012 (MEPC 64)
42	GloEn-Saver™ Ballast Water Management System, Republic of Korea	PANASIA Co., Ltd.	5 October 2012 (MEPC 64)
43	Van Oord Ballast Water Management System, the Netherlands	Van Oord B.V.	17 May 2013 (MEPC 65)
44	REDOX AS Ballast Water Management System, Norway	REDOX Maritime Technologies AS	17 May 2013 (MEPC 65)
45	BlueZone™ Ballast Water Management System, Republic of Korea	SUNBO INDUSTRIES Co., Ltd., DSEC Co., Ltd., and the Korean Institute of Machinery & Material (KIMM)	17 May 2013 (MEPC 65)
46	ECOLCELL BTs Ballast Water Management System, Italy	Azienda Chimica Genovese (ACG)	4 April 2014 (MEPC 66)
47	Ecomarine-EC Ballast Water Management System, Japan	Ecomarine Technology Research Association	4 April 2014 (MEPC 66)
48	ATPS-BLUE <sub>sys</sub> Ballast Water Management System, Japan	Panasonic Environmental Systems & Engineering Co., Ltd.	4 April 2014 (MEPC 66)
49	KURITA™ Ballast Water Management System, Japan	Kurita Water Industries Ltd.	4 April 2014 (MEPC 66)
50	ElysisGuard ballast water management system, Singapore	KALF Engineering Pte. Ltd.	17 October 2014 (MEPC 67)

Table 1 (continued)

	<b>Name of the system and proposing country</b>	<b>Name of manufacturer</b>	<b>Date of Basic Approval</b>
51	NK-CI BlueBallast System, Republic of Korea	NK Company Ltd.	15 May 2015 (MEPC 68)
52	ECS-HYCHLOR™ System, Republic of Korea	TECHCROSS Inc.	15 May 2015 (MEPC 68)
53	ECS-HYCHEM™ System, Republic of Korea	TECHCROSS Inc.	15 May 2015 (MEPC 68)
54	ECS-HYBRID™ System, Republic of Korea	TECHCROSS Inc.	15 May 2015 (MEPC 68)
55	VARUNA Ballast Water Treatment System, Singapore	Kadalneer Technologies Pte. Ltd.	15 May 2015 (MEPC 68)
56	ClearBal BWMS, Denmark	University of Strathclyde	28 October 2016 (MEPC 70)
57	MICROFADE II BWMS, Netherlands	Kashiwa Co., Ltd. and Kuraray Co., Ltd	7 July 2017 (MEPC 71)
58	Envirocleanse inTank™ BWTS, Norway	Envirocleanse, LLC	7 July 2017 (MEPC 71)
59	BIOBALLAST 1000	Biomarine S.r.l.	26 October 2018 (MEPC 73)
60	CleanBallast® – Ocean Barrier System	Veolia Water Technologies Deutschland GmbH	17 May 2019 (MEPC 74)
61	FlowSafe, Cyprus	Flowater Technologies Ltd.	17 May 2019 (MEPC 74)

**Table 2: List of ballast water management systems that make use of Active Substances which received Final Approval from IMO<sup>2</sup>**

	<b>Name of the system and proposing country</b>	<b>Name of manufacturer</b>	<b>Date of Final Approval</b>
1	PureBallast System, Norway	Alfa Laval/Wallenius Water AB	13 July 2007 (MEPC 56)
2	SEDNA® Ballast Water Management System (Using Peraclean® Ocean), Germany	Degussa GmbH, Germany	4 April 2008 (MEPC 57)
3	Electro-Clean™ System, Republic of Korea	Techcross Ltd. and Korea Ocean Research and Development Institute (KORDI)	10 October 2008 (MEPC 58)
4	OceanSaver® Ballast Water Management System, Norway	OceanSaver AS	10 October 2008 (MEPC 58)
5	RWO Ballast Water Management System (CleanBallast), Germany	RWO GmbH Marine Water Technology, Germany	17 July 2009 (MEPC 59)
6	NK-O3 BlueBallast System (Ozone), Republic of Korea	NK Company Ltd., Republic of Korea	17 July 2009 (MEPC 59)
7	Hitachi Ballast Water Purification System (ClearBallast), Japan	Hitachi, Ltd. /Hitachi Plant technologies, Ltd.	17 July 2009 (MEPC 59)
8	Greenship Sedinox Ballast Water Management System, the Netherlands	Greenship Ltd	17 July 2009 (MEPC 59)
9	GloEn-Patrol™ Ballast Water Management System, Republic of Korea	Panasia Co., Ltd.	26 March 2010 (MEPC 60)
10	Resource Ballast Technologies System, South Africa	Resource Ballast Technologies (Pty) Ltd.	26 March 2010 (MEPC 60)
11	JFE BallastAce® Ballast Water Management System, Japan	JFE Engineering Corporation	26 March 2010 (MEPC 60)
12	Hyundai Heavy Industries Co., Ltd. (HHI) Ballast Water Management System (EcoBallast), Republic of Korea	Hyundai Heavy Industries Co., Ltd., Republic of Korea	26 March 2010 (MEPC 60)
13	Special Pipe Hybrid Ballast Water Management System combined with Ozone treatment version (SP-Hybrid BWMS Ozone version), Japan	Mitsui Engineering & Shipbuilding Co., Ltd.	1 October 2010 (MEPC 61)
14	"ARA Ballast" Ballast Water Management System, Republic of Korea	21st Century Shipbuilding Co., Ltd.	1 October 2010 (MEPC 61)
15	BalClor Ballast Water Management System, China	Qingdao Sunrui Corrosion and Fouling Control Company	1 October 2010 (MEPC 61)
16	OceanGuard™ Ballast Water Management System, Norway	Qingdao Headway Technology Co., Ltd.	1 October 2010 (MEPC 61)
17	Ecochlor® Ballast Water Management System, Germany	Ecochlor Inc, Acton, the United States	1 October 2010 (MEPC 61)

<sup>2</sup> More comprehensive information regarding the systems approved until May 2019 is available in document BWM.2/Circ.34/Rev.8.



Table 2 (continued)

	<b>Name of the system and proposing country</b>	<b>Name of manufacturer</b>	<b>Date of Final Approval</b>
18	Severn Trent De Nora BalPure® Ballast Water Management System (subsequently changed to BalPure® BP-500), Germany	Severn Trent De Nora (STDN), LLC	1 October 2010 (MEPC 61)
19	HiBallast Ballast Water Management System, Republic of Korea	Hyundai Heavy Industries Co., Ltd.	15 July 2011 (MEPC 62)
20	Purimar Ballast Water Management System, Republic of Korea	Samsung Heavy Industries Co., Ltd.	15 July 2011 (MEPC 62)
	Final Approval extended for use in fresh water		17 May 2019 (MEPC 74)
21	SiCURE™ Ballast Water Management System, Germany	Siemens Water Technologies	2 March 2012 (MEPC 63)
22	ERMA FIRST Ballast Water Management System (subsequently changed to ERMA FIRST BWTS), Greece	ERMA FIRST E.S.K. Engineering Solutions S.A.	2 March 2012 (MEPC 63)
23	MICROFADE™ Ballast Water Management System, Japan	Kuraray Co., Ltd.	2 March 2012 (MEPC 63)
24	AquaStar™ Ballast Water Management, Republic of Korea (subsequently changed to AquaStar™ BWMS and MACGREGOR WATER BALLAST TREATMENT SYSTEM)	AQUA Eng. Co.	2 March 2012 (MEPC 63)
25	Neo-Purimar™ Ballast Water Management System, Republic of Korea	Samsung Heavy Industries Co., Ltd. (SHI)	2 March 2012 (MEPC 63)
26	DESMI Ocean Guard BWMS, Denmark	DESMI Ocean Guard A/S	5 October 2012 (MEPC 64)
27	JFE BallastAce that makes use of NEO-CHLOR MARINE™, Japan	JFE Engineering Corporation	5 October 2012 (MEPC 64)
28	Smart Ballast BWMS, Republic of Korea	STX Metal Co., Ltd.	5 October 2012 (MEPC 64)
29	AQUARIUS® EC Ballast Water Management System, the Netherlands	Wärtsilä Water Systems Limited	17 May 2013 (MEPC 65)
30	EcoGuardian™ Ballast Water Management System, Republic of Korea	Hanla IMS Co., Ltd.	17 May 2013 (MEPC 65)
31	OceanDoctor BWMS, China	Jiujiang Precision Measuring Technology Research Institute and Institute of Marine Materials Science and Engineering of Shanghai Maritime University	17 May 2013 (MEPC 65)
32	Ballast Water Management System with PERACLEAN® OCEAN (SKY-SYSTEM), Japan	Nippon Yuka Kogyo Co., and Katayama Chemical, Inc.	4 April 2014 (MEPC 66)
33	Evonik Ballast Water Treatment System with PERACLEAN® OCEAN, Germany	Evonik Industries AG	4 April 2014 (MEPC 66)

Table 2 (continued)

	<b>Name of the system and proposing country</b>	<b>Name of manufacturer</b>	<b>Date of Final Approval</b>
34	MARINOMATE™ Ballast Water Management System, Republic of Korea	KT Marine Co. Ltd.	17 October 2014 (MEPC 67)
35	BlueZone™ Ballast Water Management System, Republic of Korea	SUNBO Industries Co. Ltd.	17 October 2014 (MEPC 67)
36	KURITA Ballast Water Management System, Japan	Kurita Water Industries Ltd.	17 October 2014 (MEPC 67)
37	Ecomarine-EC Ballast Water Management System, Japan	Ecomarine Technology Research Association	15 May 2015 (MEPC 68)
38	ECS-HYCHLOR™ System, Republic of Korea	TECHCROSS Inc.	22 April 2016 (MEPC 69)
39	NK-CI BlueBallast System, Republic of Korea	NK Company Ltd.	22 April 2016 (MEPC 69)
40	ATPS-BLUE <sub>sys</sub> Ballast Water Management System, Japan	Panasonic Environmental Systems & Engineering Co., Ltd.	22 April 2016 (MEPC 69)
41	ECS-HYCHEM™ System, Republic of Korea	TECHCROSS Inc.	28 October 2016 (MEPC 70)
42	ECS-HYBRID™ System, Republic of Korea	TECHCROSS Inc.	7 July 2017 (MEPC 71)
43	Envirocleanse inTank™ BWTS (Electrochlorination Variation), Norway	Envirocleanse, LLC.	26 October 2018 (MEPC 73)
44	Envirocleanse inTank™ BWTS (Bulk Chemical Variation), Norway	Envirocleanse, LLC	17 May 2019 (MEPC 74)
45	MICROFADE II, Japan	Kuraray Co., Ltd.	17 May 2019 (MEPC 74)

**Table 3: List of type approvals for ballast water management systems that are in accordance with the 2016 Guidelines (G8) or the BWMS Code (resolution MEPC.279(70) or MEPC.300(72))\***

	Approval Date	Name of the Administration	Name of the ballast water management system	Copy of Type Approval Certificate	Active Substance employed	MEPC report granting Final Approval
1	2 February 2018	Norwegian Maritime Authority	PureBallast 3.2 and PureBallast 3.2 Compact Flex ballast water management system	Provided (MEPC 72/INF.19)	No Active Substances used according to the communication received from the Administration of Singapore (please refer to MEPC 72/INF.19)	Not applicable
2	21 September 2018	Danish Environmental Protection Agency and Danish Maritime Authority	CompactClean ballast water management system	Provided (MEPC 74/INF.32)	No Active Substances used according to the communication received from the Administration of Denmark (please refer to MEPC 74/INF.32)	Not applicable
3	14 December 2018	Norwegian Maritime Authority	OceanGuard® Ballast Water Management System	Provided (MEPC 74/INF.9)	Yes, please refer to MEPC 61/2/21, annex 5	Please see MEPC 61/24, paragraph 2.7
4	19 December 2018	Norwegian Maritime Authority	HiBallast™ Ballast Water Management System	Provided (MEPC 74/INF.8)	Yes, please refer to MEPC 62/2/18, annex 5	MEPC 62/24, paragraph 2.5
5	20 December 2018	Norwegian Maritime Authority	Envirocleanse inTank™ Electro-chlorination Ballast Water Treatment System	Provided (MEPC 74/INF.6)	Yes, please refer to MEPC 73/4/1, annex 5	Please see MEPC 73/19, paragraph 4.4
6	6 April 2018 (revised 20 December 2018)	Norwegian Maritime Authority	BalClor® Ballast Water Management System	Provided (MEPC 74/INF.7)	Yes, please refer to MEPC 61/2/15, annex 9	MEPC 61/24, Paragraph 2.7.3

\* Table 3 above was compiled based on information provided to IMO by the respective Administrations taking into account resolution MEPC.228(65) on *Information reporting on type approved ballast water management systems*

**Table 4: List of type approvals for ballast water management systems that are in accordance with Guidelines (G8) (resolutions MEPC.125(53) and MEPC.174(58))\***

	Approval Date	Name of the Administration	Name of the ballast water management system	Copy of Type Approval Certificate	Active Substance employed	MEPC report granting Final Approval
1	June 2008	Det Norske Veritas, on behalf of the Norwegian Administration	PureBallast System	Provided (MEPC 61/INF.3)	Yes, please refer to MEPC 56/2/2, annex 5	MEPC 56/23, paragraph 2.8
2	10 June 2008	Federal Maritime and Hydrographic Agency, Germany	SEDNA® Ballast Water Management System (Using Peraclean® Ocean)	Provided (MEPC 58/INF.17)	Yes, please refer to MEPC 57/2/10, annex 7	MEPC 57/21, paragraph 2.16
3	2 September 2008	Office of the Maritime Administration, Marshall Islands	NEI Treatment System VOS-2500-101	Available at request	No Active Substances used according to the communication received from the Administration of Marshall Islands (Letter of 10 December 2008)	Not applicable
4	31 December 2008	Ministry of Land, Transport and Maritime Affairs, Republic of Korea	Electro-Clean™ System	Provided (MEPC 59/INF.6)	Yes, please refer to MEPC 58/2/7, annex 7	MEPC 58/23, paragraph 2.8
5	17 April 2009	Det Norske Veritas, on behalf of the Norwegian Maritime Directorate	OceanSaver® Ballast Water Management System	Provided (MEPC 59/INF.17 and MEPC 62/INF.15)	Yes, please refer to MEPC 58/2/8, annex 4	MEPC 58/23, paragraph 2.10
6	29 April 2009	Lloyd's Register, as delegated by the Administration of the United Kingdom	Hyde GUARDIAN™ ballast water management system	Provided (MEPC 59/INF.20)	No Active Substances used according to the communication received from the Administration of United Kingdom (please refer to MEPC 59/INF.20)	Not applicable

\* Table 4 above was compiled based on information provided by the respective Administrations taking into account resolution MEPC.228(65) on *Information reporting on type approved ballast water management systems*. Systems listed in this table may have also received type approval based on the 2016 Guidelines (G8) or the BWMS Code (resolution MEPC.279(70) or MEPC.300(72)). Please refer to Table 3 for a list of ballast water management systems that have received type approvals under the 2016 Guidelines (G8) or the BWMS Code.

Table 4 (continued)

	Approval Date	Name of the Administration	Name of the ballast water management system	Copy of Type Approval Certificate	Active Substance employed	MEPC report granting Final Approval
7	12 November 2009	Det Norske Veritas, on behalf of the Norwegian Maritime Directorate	OptiMarin Ballast System (OBS)	Provided (MEPC 61/INF.4)	No Active Substances used according to the communication received from the Administration of Norway (please refer to MEPC 61/INF.4)	Not applicable
8	24 November 2009	Ministry of Land, Transport and Maritime Affairs, Republic of Korea	NK-O3 BlueBallast System (Ozone)	Provided (MEPC 60/INF.14)	Yes, please refer to MEPC 59/2/16, annex 6	MEPC 59/24, paragraph 2.8.
9	4 December 2009	Ministry of Land, Transport and Maritime Affairs, Republic of Korea	GloEn-Patrol™ Ballast Water Management System	Provided (MEPC 61/2/19)	Yes, please refer to MEPC 60/2/11, annex 4	MEPC 60/22, paragraph 2.7
10	19 January 2010	Merchant Shipping Directorate of Malta	NEI Treatment System VOS-2500-101	Provided (BWM.2/Circ.25)	Please refer to circular BWM.2/Circ.25	Not applicable
11	5 March 2010	Ministry of Land, Infrastructure, Transport and Tourism of Japan	Hitachi Ballast Water Management System (ClearBallast)	Provided (MEPC 61/INF.21)	Yes, please refer to MEPC 59/2/19, annex 4	MEPC 59/24, paragraph 2.8
12	26 May 2010 and 25 March 2011	Inspection and Measurement Division, Maritime Bureau, Ministry of Land, Infrastructure, Transport and Tourism of Japan	JFE BallastAce® Ballast Water Management System	Provided (MEPC 62/INF.25)	Yes, please refer to MEPC 60/2/12, annex 5	MEPC 60/22, paragraph 2.7
13	1 September 2010	Federal Maritime and Hydrographic Agency, Germany	CleanBallast® 500-1 ballast water management system (formerly named RWO Ballast Water Management System (CleanBallast))	Provided (MEPC 67/INF.29)	Yes, please refer to MEPC 59/2/16, annex 5	MEPC 59/24, paragraph 2.8
14	28 January 2011	China Maritime Safety Administration	BalClor™ Ballast Water Management System	Provided (MEPC 62/INF.29)	Yes, please refer to MEPC 61/2/15, annex 9	MEPC 61/24, Paragraph 2.7.3

Table 4 (continued)

	Approval Date	Name of the Administration	Name of the ballast water management system	Copy of Type Approval Certificate	Active Substance employed	MEPC report granting Final Approval
15	19 April 2011	The South African Department of Transport	Resource Ballast Technologies System	Provided (MEPC 62/INF.18)	Yes, please refer to MEPC 60/2/11, annex 7	MEPC 60/22, paragraph 2.7
	Renewal 18 January 2013	The South African Department of Transport		Provided (MEPC 65/INF.26)		
16	16 February 2011	China Maritime Safety Administration	Blue Ocean Shield Ballast Water Management System	Provided (MEPC 62/INF.28)	No Active Substances used according to the communication received from the Administration of China (please refer to MEPC 62/INF.28)	Not applicable
17	10 March 2011	Det Norske Veritas, on behalf of the Norwegian Maritime Directorate	PureBallst 2.0 and PureBallast 2.0 Ex	Provided (MEPC 62/INF.14)	No Active Substances used according to the communication received from the Administration of Norway (please refer to MEPC 62/INF.14)	Not applicable
18	16 March 2011	The Ministry of Land, Transport and Maritime Affairs, Republic of Korea	EcoBallast Ballast Water Management System (Hyundai Heavy Industries Co., Ltd.)	Provided (MEPC 63/INF.5)	Yes, please refer to MEPC 59/2/16, annex 8	MEPC 60/22, paragraph 2.13
19	28 March 2011	China Maritime Safety Administration	BSKY™ Ballast Water Management System	Provided (MEPC 62/INF.30)	No Active Substances used according to the communication received from the Administration of China (please refer to MEPC 62/INF.30)	Not applicable
20	29 April 2011	Federal Maritime and Hydrographic Agency, Germany	Ocean Protection System® OPS-250	Provided (MEPC 67/INF.27)	No Active Substances used according to the communication received from the Administration of Germany (please refer to MEPC 67/INF.27)	Not applicable
21	6 June 2011	Inspection and Measurement Division, Maritime Bureau, Ministry of Land, Infrastructure, Transport and Tourism of Japan	FineBallast® OZ (the Special Pipe Hybrid Ballast Water Management System combined with Ozone treatment version)	Provided (MEPC 63/INF.12)	Yes, please refer to MEPC 61/2/15, annex 6	MEPC 61/24, paragraph 2.7

Table 4 (continued)

	Approval Date	Name of the Administration	Name of the ballast water management system	Copy of Type Approval Certificate	Active Substance employed	MEPC report granting Final Approval
22	27 July 2011	Federal Maritime and Hydrographic Agency, Germany	BalPure® BP-500	Provided (MEPC 64/INF.20)	Yes, please refer to MEPC 61/2/21, annex 7	MEPC 61/24, paragraph 2.7
23	6 August 2011	Office of the Maritime Administrator, Republic of the Marshall Islands	NEI Treatment System VOS-500 to VOS-6000	Available at request	No Active Substances used according to the communication received from the Administration of Marshall Islands (Letter of 9 August 2011)	Not applicable
24	31 October 2011	The Ministry of Land, Transport and Maritime Affairs, Republic of Korea	Purimar™ System	Provided (MEPC 63/INF.6)	Yes, please refer to MEPC 62/2/18, annex 6	MEPC 62/24, paragraph 2.5
25	7 November 2011	Det Norske Veritas, on behalf of the Norwegian Maritime Directorate	OceanGuard™ Ballast Water Management System	Provided (MEPC 65/INF.2)	Yes, please refer to MEPC 61/2/21, annex 5	MEPC 61/24, paragraph 2.7
26	4 November 2011	Federal Maritime and Hydrographic Agency, Germany	Ecochlor® Ballast Water Treatment System, Series 75	Provided (MEPC 67/INF.26)	Yes, please refer to MEPC 61/2/21, annex 6	MEPC 61/24, paragraph 2.7
27	11 November 2011	The Ministry of Land, Transport and Maritime Affairs, Republic of Korea	HiBallast™ Ballast Water Management System	Provided (MEPC 63/INF.4)	Yes, please refer to MEPC 62/2/18, annex 5	MEPC 62/24, paragraph 2.5
28	22 December 2011	Det Norske Veritas, on behalf of the Norwegian Maritime Directorate	OceanSaver® Ballast Water Management System	Provided (MEPC 64/INF.4)	Yes, please refer to MEPC 58/2/8, annex 4	MEPC 58/23, paragraph 2.10



Table 4 (continued)

	Approval Date	Name of the Administration	Name of the ballast water management system	Copy of Type Approval Certificate	Active Substance employed	MEPC report granting Final Approval
29	10 May 2012  Amended (1 <sup>st</sup> ) 15 January 2015  Amended (2 <sup>nd</sup> ) 19 October 2018	Hellenic Republic, Ministry of Development, Competitiveness and Shipping, General Secretariat of Shipping, Merchant Ships Inspection General Directorate, Design and Construction Directorate	ERMA FIRST BWTS   ERMA FIRST BWTS	Provided (MEPC 64/INF.26)  Amended (MEPC 68/INF.19)  Amended (MEPC 74/INF.4)	Yes, please refer to MEPC 63/2/11, annex 5	MEPC 63/23, paragraph 2.7
30	30 May 2012	Inspection and Measurement Division, Maritime Bureau, Ministry of Land, Infrastructure, Transport and Tourism of Japan	MICROFADE™ Ballast Water Management System	Provided (MEPC 64/INF.17)	Yes, please refer to MEPC 63/2/11, annex 6	MEPC 63/23, paragraph 2.7
31	12 June 2012	China Maritime Safety Administration	Cyeco™ Ballast Water Management System	Provided (MEPC 64/INF.12)	No Active Substances used according to the communication received from the Administration of China (please refer to MEPC 64/INF.12)	Not applicable
32	15 June 2012	The Ministry of Land, Transport and Maritime Affairs, Republic of Korea	AquaStar™ Ballast Water Management System (subsequently changed to AquaStar™ BWMS and MACGREGOR WATER BALLAST TREATMENT SYSTEM)	Provided (MEPC 64/INF.18)	Yes, please refer to MEPC 63/2/11, annex 7	MEPC 63/23, paragraph 2.7
33	12 July 2012	The Ministry of Land, Transport and Maritime Affairs, Republic of Korea	ARA PLASMA BWTS Ballast Water Management System	Provided (MEPC 64/INF.33)	Yes, please refer to MEPC 61/2/15, annex 8	MEPC 61/24, paragraph 2.7
34	27 August 2012	Federal Maritime and Hydrographic Agency, Germany	BallastMaster ultraV 250 ballast water management system (formerly named AquaTriComb BW 250)	Provided (MEPC 67/INF.28)	No Active Substances used according to the communication received from the Administration of Germany (please refer to MEPC 67/INF.28)	Not applicable



Table 4 (continued)

	Approval Date	Name of the Administration	Name of the ballast water management system	Copy of Type Approval Certificate	Active Substance employed	MEPC report granting Final Approval
35	20 September 2012	The Norwegian Maritime Authority	CrystalBallast® Ballast Water Management System	Provided (MEPC 65/INF.13)	No Active Substances used according to the communication received from the Administration of Norway (please refer to MEPC 65/INF.13)	Not applicable
36	7 November 2012	The Danish Maritime Authority and the Danish Nature Agency	DESMI Ocean Guard OxyClean Ballast Water Management System	Provided (MEPC 65/INF.5)	Yes, please refer to MEPC 64/2/6, annex 4	MEPC 64/23, paragraph 2.6
37	12 December 2012	The Norwegian Maritime Authority	MMC Ballast Water Management System	Provided (MEPC 66/INF.9)	No Active Substances used according to the communication received from the Administration of Norway (please refer to MEPC 66/INF.9)	Not applicable
38	20 December 2012	The Netherlands Ministry of Infrastructure and the Environment	Wärtsilä AQUARIUS® UV ballast water management system	Provided (MEPC 65/INF.11)	No Active Substances used according to the communication received from the Administration of the Netherlands (please refer to MEPC 65/INF.11)	Not applicable
39	5 February 2013	China Maritime Safety Administration	BALWAT Ballast Water Management System	Provided (MEPC 66/INF.15)	No Active Substances used according to the communication received from the Administration of China (please refer to MEPC 66/INF.15)	Not applicable
40	5 June 2013	French Ministry of Ecology Sustainable Development and Energy	BIO-SEA® Ballast Water Treatment System	Provided (MEPC 66/INF.10)	No Active Substances used according to the communication received from the Administration of France (please refer to MEPC 66/INF.10)	Not applicable
41	26 June 2013	Inspection and Measurement Division, Maritime Bureau, Ministry of Land, Infrastructure, Transport and Tourism of Japan	JFE BallastAce	Provided (MEPC 66/INF.30)	Yes, please refer to MEPC 64/2/7, annex 5	MEPC 64/23, paragraph 2.6

Table 4 (continued)

	Approval Date	Name of the Administration	Name of the ballast water management system	Copy of Type Approval Certificate	Active Substance employed	MEPC report granting Final Approval
42	22 August 2013	China Maritime Safety Administration	HY™-BWMS	Provided (MEPC 66/INF.14)	No Active Substances used according to the communication received from the Administration of China (please refer to MEPC 66/INF.14)	Not applicable
43	10 October 2013	China Maritime Safety Administration	NiBallast™ Ballast Water Management System	Provided (MEPC 66/INF.12)	No Active Substances used according to the communication received from the Administration of China (please refer to MEPC 66/INF.12)	Not applicable
44	4 November 2013	China Maritime Safety Administration	Cyeco™ Ballast Water Management System	Provided (MEPC 66/INF.16)	No Active Substances used according to the communication received from the Administration of China (please refer to MEPC 66/INF.16)	Not applicable
45	5 November 2013	Inspection and Measurement Division, Maritime Bureau, Ministry of Land, Infrastructure, Transport and Tourism of Japan	FineBallast MF	Provided (MEPC 66/INF.28)	No Active Substances used according to the communication received from the Administration of Japan (please refer to MEPC 66/INF.28)	Not applicable
46	14 November 2013	The Norwegian Maritime Authority	KBAL Ballast Water Management System	Provided (MEPC 65/INF.12)	No Active Substances used according to the communication received from the Administration of Norway (please refer to MEPC 65/INF.12)	Not applicable
47	2 December 2013	China Maritime Safety Administration	Seascope Ballast Water Management System	Provided (MEPC 66/INF.13)	No Active Substances used according to the communication received from the Administration of China (please refer to MEPC 66/INF.13)	Not applicable
48	20 December 2013	The Norwegian Maritime Authority	Trojan Marinex™ Ballast Water Management System	Provided (MEPC 67/INF.6)	No Active Substances used according to the communication received from the Administration of Norway (please refer to MEPC 67/INF.6)	Not applicable

Table 4 (continued)

	Approval Date	Name of the Administration	Name of the ballast water management system	Copy of Type Approval Certificate	Active Substance employed	MEPC report granting Final Approval
50	24 February 2014	Federal Maritime and Hydrographic Agency (BSH)	SeaCURE BWMS SC-1500/1	Provided (MEPC 69/INF.13)	No Active Substances used according to the communication received from the Administration of Germany (please refer to MEPC 69/INF.13)	MEPC 63/23, paragraph 2.7
51	27 March 2014	Inspection and Measurement Division, Maritime Bureau, Ministry of Land, Infrastructure, Transport and Tourism of Japan	Miura BWMS ballast water management system	Provided (MEPC 67/INF.20)	No Active Substances used according to the communication received from the Administration of Japan (please refer to MEPC 67/INF.20)	Not applicable
52	30 April 2014	Federal Maritime and Hydrographic Agency, Germany	Cathelco Ballast Water Management System – A2	Provided (MEPC 67/INF.30)	No Active Substances used according to the communication received from the Administration of Germany (please refer to MEPC 67/INF.30)	Not applicable
53	18 June 2014	Inspection and Measurement Division, Maritime Bureau, Ministry of Land, Infrastructure, Transport and Tourism of Japan	ECOMARINE ballast water management system	Provided (MEPC 67/INF.21)	No Active Substances used according to the communication received from the Administration of Japan (please refer to MEPC 67/INF.21)	Not applicable
54	30 June 2014	The Norwegian Maritime Authority	Alfa Laval PureBallast 3.0 Ballast Water Management System	Provided (MEPC 67/INF.5)	No Active Substances used according to the communication received from the Administration of Norway (please refer to MEPC 67/INF.5)	Not applicable
55	11 July 2014	China Maritime Safety Administration	PACT marine™ Ballast Water Management System	Provided (MEPC 68/INF.5)	No Active Substances used according to the communication received from the Administration of China (please refer to MEPC 68/INF.5)	Not applicable
56	5 September 2014	The Danish Maritime Authority and The Danish Nature Agency	RayClean™ BWTS	Provided (MEPC 68/INF.10)	No Active Substances used according to the communication received from the Administration of Denmark (please refer to MEPC 68/INF.10)	Not applicable

Table 4 (continued)

	Approval Date	Name of the Administration	Name of the ballast water management system	Copy of Type Approval Certificate	Active Substance employed	MEPC report granting Final Approval
57	21 October 2014	Inspection and Measurement Division, Maritime Bureau, Ministry of Land, Infrastructure, Transport and Tourism of Japan	SKY-SYSTEM®	Provided (MEPC 68/INF.28)	Yes, please refer to MEPC 66/2/7, annex 4 and Corr.1	MEPC 66/21, paragraph 2.5
58	17 November 2014	China Maritime Safety Administration	OceanDoctor® Ballast Water Management System	Provided (MEPC 68/INF.4)	Yes, please refer to MEPC 65/2/19, annex 7	MEPC 65/22 paragraph 2.8
59	5 January 2015	The Danish Maritime Authority and The Danish Nature Agency	Bawat™ BWMS	Provided (MEPC 68/INF.9)	No Active Substances used according to the communication received from the Administration of Denmark (please refer to MEPC 68/INF.9)	Not applicable
60	27 January 2015	China Maritime Safety Administration	AHEAD®-BWMS ballast water management system	Provided (MEPC 69/INF.2)	No Active Substances used according to the communication received from the Administration of China (please refer to MEPC 68/INF.2)	Not applicable
61	6 February 2015	United Kingdom, Maritime & Coastguard Agency	Coldharbour GLD™ Ballast Water Management System, incorporating types SeaGuardian™ IGG500 to IGG6000	Provided (MEPC 68/INF.27)	No Active Substances used according to the communication received from the Administration of the United Kingdom (please refer to MEPC 68/INF.27)	Not applicable
62	28 February 2015	China Maritime Safety Administration	YP-BWMS ballast water management system	Provided (MEPC 69/INF.5)	No Active Substances used according to the communication received from the Administration of China (please refer to MEPC 69/INF.5)	Not applicable
63	8 May 2015	Ministry of Oceans and Fisheries of Republic of Korea	EcoGuardian™ Ballast Water Management System	Provided (MEPC 69/INF.31)	No Active Substances used according to the communication received from the Administration of the Republic of Korea (please refer to MEPC 69/INF.31)	MEPC 65/22, paragraph 2.8

Table 4 (continued)

	Approval Date	Name of the Administration	Name of the ballast water management system	Copy of Type Approval Certificate	Active Substance employed	MEPC report granting Final Approval
64	8 September 2015	Ministry of Oceans and Fisheries of the Republic of Korea	BlueZone™ Ballast Water Management System	Provided (MEPC 69/INF.32)	No Active Substances used according to the communication received from the Administration of the Republic of Korea (please refer to MEPC 69/INF.32)	MEPC 67/20, paragraph 2.6
65	12 September 2015	China Maritime Safety Administration	NiBallast™ Ballast Water Management System	Provided (MEPC 69/INF.3)	No Active Substances used according to the communication received from the Administration of China (please refer to MEPC 69/INF.3)	Not applicable
66	19 November 2015	Netherlands Shipping Inspectorate, Ministry of Infrastructure and the Environment	Van Oord Ballast Water Management System	Provided (MEPC 69/INF.15)	No Active Substances used according to the communication received from the Administration of Norway (please refer to MEPC 69/INF.15)	Please see MEPC 65/22, paragraph 2.5
67	21 December 2015	China Maritime Safety Administration	Seascape® Ballast Water Management System	Provided (MEPC 69/INF.4)	No Active Substances used according to the communication received from the Administration of China (please refer to MEPC 69/INF.4)	Not applicable
68	23 December 2015	French Ministry of Ecology Sustainable Development and Energy	BIO-SEA® Ballast Water Treatment System (BWTS); Models BIO-SEA®30-55, BIO-SEA®30-87, BIO-SEA®60-55, BIO-SEA®60-87 and BIO-SEA®90-87	Provided (MEPC 70/INF.24)	No Active Substances used according to the communication received from the Administration of France (please refer to MEPC 70/INF.24)	Not applicable
69	11 January 2016	China Maritime Safety Administration	LeesGreen® Ballast Water Management System	Provided (MEPC 70/INF.5)	No Active Substances used according to the communication received from the Administration of China (please refer to MEPC 70/INF.5)	Not applicable

Table 4 (continued)

	Approval Date	Name of the Administration	Name of the ballast water management system	Copy of Type Approval Certificate	Active Substance employed	MEPC report granting Final Approval
70	15 April 2016	China Maritime Safety Administration	PACT Marine™ Ballast Water Management System	Provided (MEPC 70/INF.4)	No Active Substances used according to the communication received from the Administration of China (please refer to MEPC 70/INF.4)	Not applicable
71	27 July 2016	Singapore	Semb-Eco LUV 500 ballast water management system	Provided (MEPC 70/INF.22)	No Active Substances used according to the communication received from the Administration of Singapore (please refer to MEPC 70/INF.22)	Not applicable
72	12 January 2017	Singapore	Semb-Eco LUV 500 & Semb-Eco LUV 1500 ballast water management system	Provided (MEPC 71/INF.12)	No Active Substances used according to the communication received from the Administration of Singapore (please refer to MEPC 71/INF.12)	Not applicable
73	13 January 2017	Inspection and Measurement Division, Maritime Bureau, Ministry of Land, Infrastructure, Transport and Tourism of Japan	KURITA BWMS	Provided (MEPC 71/INF.26)	Yes, please refer to MEPC 67/2/4, annex 6	Please see MEPC 67/20, paragraph 2.6
74	19 March 2017	Netherlands Shipping Inspectorate, Ministry of Infrastructure and the Environment	Damen InvaSave 300	Provided (MEPC 71/INF.4)	No Active Substances used according to the communication received from the Administration of the Netherlands (please refer to MEPC 71/INF.4)	Not applicable
75	30 March 2017	Inspection and Measurement Division, Maritime Bureau, Ministry of Land, Infrastructure, Transport and Tourism of Japan	ATPS-BLUE <sub>sys</sub>	Provided (MEPC 71/INF.27)	Yes, please refer to MEPC 69/4/5, annex 6	Please see MEPC 69/21, paragraph 4.6

Table 4 (continued)

	Approval Date	Name of the Administration	Name of the ballast water management system	Copy of Type Approval Certificate	Active Substance employed	MEPC report granting Final Approval
76	13 November 2017	Singapore	Semb-Eco LUV 250, Semb-Eco LUV 500, Semb-Eco LUV 750, Semb-Eco LUV 1000 and Semb-Eco LUV 1500 ballast water management system	Provided (MEPC 72/INF.2)	No Active Substances used according to the communication received from the Administration of Singapore (please refer to MEPC 72/INF.2)	Not applicable
77	2 February 2018	Norwegian Maritime Authority	PureBallast 3.2 and PureBallast 3.2 Compact Flex ballast water management system	Provided (MEPC 72/INF.19)	No Active Substances used according to the communication received from the Administration of Singapore (please refer to MEPC 72/INF.19)	Not applicable
78	6 April 2018 (revised 20 December 2018)	Norwegian Maritime Authority	BalClor® Ballast Water Management System	Provided (MEPC 74/INF.7)	Yes, please refer to MEPC 61/2/15, annex 9	MEPC 61/24, Paragraph 2.7.3
79	12 April 2018	French Ministry of Ecology, Sustainable Development and Energy	BIO-SEA® B ballast water management system (BWMS); Models BIO SEA B01-0055 to BIO-SEA B14 2000	Provided (MEPC 73/INF.7)	No Active Substances used according to the communication received from the Administration of France (please refer to MEPC 73/INF.7)	Not applicable
80	21 September 2018	Danish Environmental Protection Agency and Danish Maritime Authority	CompactClean ballast water management system	Provided (MEPC 74/INF.32)	No Active Substances used according to the communication received from the Administration of Denmark (please refer to MEPC 74/INF.32)	Not applicable
81	14 December 2018	Norwegian Maritime Authority	OceanGuard® Ballast Water Management System	Provided (MEPC 74/INF.9)	Yes, please refer to MEPC 61/2/21, annex 5	Please see MEPC 61/24, paragraph 2.7
82	19 December 2018	Norwegian Maritime Authority	HiBallast™ Ballast Water Management System	Provided (MEPC 74/INF.8)	Yes, please refer to MEPC 62/2/18, annex 5	MEPC 62/24, paragraph 2.5



83	20 December 2018	Norwegian Maritime Authority	Envirocleanse inTank™ Electro-chlorination Ballast Water Treatment System	Provided (MEPC 74/INF.6)	Yes, please refer to MEPC 73/4/1, annex 5	Please see MEPC 73/19, paragraph 4.4
----	------------------	------------------------------	---	--------------------------	---	--------------------------------------

**Note: all lists above updated in December 2019.**



**Table 1, Proposal from PT PM 42/2017: issues addressed by the Machinery Panel through the UR M74 Rev. 2**

BWMS's Technology category →			1	2	3a	3b	3c	4	5	6	7a	7b	8
Identification of specific hazards ↓	←Reference in UR M74 Rev. 2	←Reference in UR M74 Rev. 1	In-line UV including UV + Advanced Oxidation Technology (AOT) or UV + TiO2 or UV + Plasma	In-line Flocculation (ex. Clearballast™)	In-line membrane separation and de-oxygenation (injection of N2 from a N2 Generator) ex. Ni-Ballast™	In-line de-oxygenation (injection of Inert Gas from Inert Gas Generator) ex. VOS™	In-tank de-oxygenation with Inert Gas Generator ex. GLD™	In-line full flow electrolysis (ex. Electroclean™)	In-line side stream electrolysis (ex. HiBallast™)	In-line (stored) chemical injection (ex. JFE BallastAce® with NeoChlor Marine® or TG Ballast Cleaner®)	In-line side-stream ozone injection without gas/liquid separation tank and without Discharge treatment tank (ex. NK-O3 BlueBallast)	In-line side-stream ozone injection with gas/liquid separation tank and Discharge water treatment tank (ex. FineBallast@OZ)	In-tank pasteurization and de-oxygenation with N2 Generator ex. BAWAT™
Risk of fire & explosion: <b>location of BWMS in hazardous areas of tankers outside the cargo pump room with certified safe type of electrical equipment</b>	3.2.1.1 Annex I, Table 1	Not covered	Acceptable			Not acceptable, refer to IMO MSC Res. 367(93), FSS Code Ch 15 §2.3.1.2		Acceptable			Not acceptable		Acceptable
Potential reactivity or increased hazardous environment with high concentration of cargo vapors: <b>location of BWMS in cargo pump room</b>	3.2.1.2 Annex I, Table 1	Not covered	Acceptable			Not acceptable, refer to IMO MSC Res. 367(93), FSS Code Ch 15 §2.3.1.2		Not acceptable unless it is demonstrated by the BWMS manufacturer that the risk can be disregarded			Not acceptable		Acceptable
Contamination from BWMS room to other enclosed spaces: <b>O2 and O3 piping and vent pipe routing through other enclosed spaces</b>	3.3.2.5 3.3.2.6 3.3.2.7	Not covered	-	-	-	-	-	-	-	-	X	X	-
O2 leakage inside BWMS room: O2 detection	3.3.1.2	Not covered	-	-	[LA] with min 2 sensors as per IMO MSC Res. 369(93), FSS Code Ch 15 § 2.2.4.5.4		-	-	-	-	[LA], [HA], [HHA+shutdown] with min 2 sensors		[LA] with min 2 sensors
O3 leakage from O3 generator inside BWMS room: O3 detection, [HA], [HHA+shutdown]	3.3.1.3	Not covered	-	-	-	-	-	-	-	-	[HA], [HHA+shutdown] with 2 sensors		-
O3 leakage from O3 double walled piping or pipe ducts: (O3 detection [HA], [HHA+shutdown]) or (monitored under-pressurization with alarm and shutdown)	3.3.1.4	Not covered	-	-	-	-	-	-	-	-	X	X	-

Location of the O2 vent outlet to safe area	Foot-note*) 2) 3.3.1.6	Not covered	-	-	X	-	-	-	-	-	X	X	X
Flammable/explosive vapors detection	Modified in 3.3.1.1	3.1.6.1	-	(1)	-	-	-	(1)	(1)	(1)	-	-	-
Other hazardous gas detection	3.3.1.1	Not covered	-	(1)	-	-	-	(1)	(1)	(1)	-	-	-
Location of the inert gas or nitrogen product enriched air vent outlet to safe area	Foot-note*) 2) 3.3.1.6	Not covered	-	-	X	X	X	-	-	-	X	X	X
Location of the O3 generator and O3 destructor vent outlets	Foot-note*) 2) 3.3.1.6	Not covered	-	-	-	-	-	-	-	-	X	X	-
Failure of the Ozone Destructor Device (ODS)	Foot-note*) 4)	Not covered	-	-	-	-	-	-	-	-	X	X	-
Location of the chemical storage tank vents	3.3.3.3	Not covered	-	X	-	-	-	-	-	X	-	-	-
Segregation of drainages coming from the spill trays of chemical storage tanks and other associated components (pumps, filters, etc.) subject to leakage.	3.3.3.5	Not covered	-	(1)	-	-	-	-	-	(1)	-	-	-
Location of the H2 vent outlet	Foot-note*) 3) Modified in 3.3.1.5	3.1.6.3	-	-	-	-	-	Generally applicable in case of H2 de-gas arrangement is provided (for example chlorination BWMS involving the reaction $\text{NaCl} + \text{H}_2\text{O} \rightarrow \text{NaOCl} + \text{H}_2$ )			-	-	-
H2 de-gas arrangement within enclosed spaces (risk of leakage): vent pipe routing, class of piping, junction of pipes, double walled piping or pipe ducts, H2 detection, hazardous area, shut-downs	Modified in 3.3.1.1 3.3.1.5 3.3.2.1 3.3.2.2 3.3.2.3 3.3.2.4 3.3.2.5 3.3.2.7	3.1.6.3 3.4.1 3.4.1.1 3.4.1.2	-	-	-	-	-				-	-	-
Pressure/vacuum protecting device for the ballast piping	Modified in 3.1.5	3.1.4	-	-	X	X	-	-	-	-	-	-	-
Pressure/vacuum protecting devices for the ballast tanks in cargo area	3.1.5	Not covered	-	-	X	X	X	-	-	-	-	-	-

P/V valve, P/V breaker, P/V breather valves outlets in cargo area (hazardous areas and distance from sources of ignition)	3.1.5	Not covered	-	-	X	X	X	-	-	-	-	-	-
Risk of leakage from piping conveying active substances, by-products or neutralizer that are containing dangerous gas/liquids	Modified in 3.3.2.1 3.3.2.2	3.4.1 3.4.1.1	-	X	-	-	-	X	X	X	X	X	-
Risk of leakages from chemical storage tanks: protection against corrosion	Modified in 3.3.3.1	3.4.2.1	-	X	-	-	-	-	-	X	-	-	-
Risk of leakages from chemical storage tanks: class of pressure vessel	Modified in 3.3.3.2	3.4.2.2	-	X	-	-	-	-	-	X	-	-	-
Location of vent from chemical storage tanks	Modified in 3.3.3.3	3.4.2.3	-	X	-	-	-	-	-	X	-	-	-
Specific operational procedures for the storage and handling of chemicals, PPE: as required by Material Safety Data Sheet, and BWM.2/Circ.20	3.3.3.4	3.4.2.4	-	X	-	-	-	X	X	X	X	X	-
Risk of leakages from chemical storage tanks: drainage containment	3.3.3.5	Not covered	-	X	-	-	-	-	-	X	-	-	-
Risk of cavitation extended to the ballast piping downstream (BWMS using special pipe, smart pipe or water lift with pressure/vacuum reactor)	3.1.8	Not covered	-	-	-	X	-	-	-	-	-	X	-

No modification from Rev. 1 to Rev. 2		Modified from Rev. 1 to Rev. 2		New requirement in Rev. 2
---------------------------------------	--	--------------------------------	--	---------------------------

Notes:  
 "X" in the cell indicates that the hazard is relevant.  
 "-" in the cell indicates that the hazard is not relevant.  
 (1) To be investigated on a case by case basis based on the result of the IMO (GESAMP) MEPC report for Basic and Final approval in accordance with the G9 Guideline.

**Table 2, Proposal from PT PM 42/2017: Fire safety protection issues to be addressed by the Safety Panel PT through PS17030a (SP14017p)**

BWMS's Technology category →			1	2	3a	3b	3c	4	5	6	7a	7b	8
<b>Identification of specific hazards ↓</b>	←Reference in UR M74 Rev. 2	←Reference in UR M74 Rev. 1	In-line UV including UV + Advanced Oxidation Technology (AOT) or UV + TiO2 or UV + Plasma	In-line Flocculation (ex. Clearballast™)	In-line membrane separation and de-oxygenation (injection of N2 from a N2 Generator) ex. Ni-Ballast™	In-line de-oxygenation (injection of Inert Gas from Inert Gas Generator) ex. VOS™	In-tank de-oxygenation with Inert Gas Generator ex. GLD™	In-line full flow electrolysis (ex. Electroclean™)	In-line side stream electrolysis (ex. HiBallast™)	In-line (stored) chemical injection (ex. JFE BallastAce® with NeoChlor Marine® or TG Ballast Cleaner®)	In-line side-stream ozone injection without gas/liquid separation tank and without Discharge treatment tank (ex. NK-O3 BlueBallast)	In-line side-stream ozone injection with gas/liquid separation tank and Discharge water treatment tank (ex. FineBallast®OZ)	In-tank pasteurization and de-oxygenation with N2 Generator ex. BAWAT™
Fire growth potential: acceptable spaces outside cargo area for the location of the BWMS (accommodation spaces, service spaces, control stations, machinery spaces of category A, other machinery spaces, Ro-Ro spaces, etc)	Removed	3.4.3.2 3.1.8	Not assessed by PT PM 42/2017		X	Same as for Inert Gas Generator (machinery space of category A)	X	(1)	(1)	(1)	X	X	X
Containment of fire: fire categorization of the BWMS room and fire integrity of the boundaries with adjacent spaces	Removed	3.4.3.1											
Prevention against fire: Fire detection	Not covered												
Fire fighting: fixed fire fighting system in the BWMS room	Not covered												
Fire fighting: portable fire fighting equipment in the BWMS room	Not covered												
Contamination from BWMS room to other enclosed spaces: direct access to other enclosed spaces	Not covered												
Contamination from BWMS room to other enclosed spaces: gas-tight and self-closing door	Not covered		(1)	X	X	X	(1)	(1)	(1)	X	X	X	
Contamination from BWMS room to other spaces: Independent ventilation + outlet arranged at a safe location on the open deck (refer to the definitions)	Removed	3.1.6.2 3.1.8	(1)	X	Same as for Inert Gas Generator	X	X	X	X	X	X	X	

proposed UR M74 2.7)						(machinery space of category A)						
Ventilation of the BWMS room: minimum air changes per hour, mechanical extraction type, etc.	Removed	3.3.1.1 3.3.1.2 3.3.2		Min. 6	Min. 6 (extraction type)	Min. 6 (positive pressure type)	Min. 6	Min. 6	Min. 6	Min. 20 + alarm + shutdown	Min. 6 (extraction type)	
Chemical reactivity: potential reactivity with the performance of the type of the foam in case the BWMS is located in a space protected by a fixed foam fire extinguishing system	Not covered			(1)			(1)	(1)	(1)			
Chemical or physical reactivity with water: potential reactivity with water spraying system (example exothermic reactivity from Sulfuric acid tank of Ecochlor)	Not covered								(1)			
Compressed air storage inside BWMS room: impact on the calculation of the minimum capacity of the gas fire extinguishing medium	Not covered									In case the BWMS is located in a space protected by a fixed gas fire extinguishing system		
Compressed O2 storage inside BWMS room: impact on the calculation of the minimum capacity of the gas fire extinguishing medium	Not covered											
O3 leakage inside the BWMS room: air breathing apparatus	Removed	3.1.8								X	X	
Chemical leakage inside the BWMS room : Emergency eye wash, shower	Not covered								(1)			

Not assessed by PT PM 42/2017	Preliminary assessment has been conducted by PT PM 42/2017 but a further assessment by the Safety Panel PT (PS17030a) is required.
-------------------------------	--

**Notes:**

"X" in the cell indicates that the hazard is relevant.

"-" in the cell indicates that the hazard is not relevant.

(1) To be investigated on a case by case basis based on the result of the IMO (GESAMP) MEPC report for Basic and Final approval in accordance with the G9 Guideline.

Removed	<p>This hazard has been identified and assessed by the PT PM 42/2017 with the following recommendation: to be further assessed by the Safety Panel PT (PS17030a). Consequently, PT PM 42/2017 proposed to delete the requirement related to this issue from the UR M74 Rev. 2:</p> <p><i>3.1.6 Where the operating principle of the BWMS involves the generation of a dangerous gas, the following requirements are to be satisfied:</i></p> <p><i>3.1.6.2 The ventilation line of a space where dangerous gas could be present is to be led to a safe area on open deck.</i></p> <p><i>3.1.8 For the spaces, including hazardous areas, where toxicity, asphyxiation, corrosivity or reactivity is present, these hazards are to be taken into account and additional precautions for the ventilation of the spaces and protection of the crew are to be considered.</i></p> <p><i>3.3 Ventilation</i></p> <p><i>3.3.1 BWMS not in hazardous areas:</i></p>
---------	--

	<p><del>1 A BWMS that does not generate dangerous gas is to be located in an adequately ventilated area.</del></p> <p><del>2 A BWMS that generates dangerous gas is to be located in a space fitted with a mechanical ventilation system providing at least 6 air changes per hour or as specified by the BWMS manufacturer, whichever is greater.</del></p> <p><del>3.3.2 A BWMS, regardless of whether or not it generates dangerous gas, is to be located in a space fitted with mechanical ventilation complying with relevant requirements, e.g. IEC60092-502, IBC Code, IGC Code, etc.</del></p> <p><del>3.4.3 Where the BWMS is installed in an independent compartment, the compartment is to be:</del></p> <p><del>1 Provided with fire integrity equivalent to other machinery spaces.</del></p> <p><del>2 Positioned outside of any combustible, corrosive, toxic, or hazardous areas unless otherwise specifically approved.</del></p>
--	--

Detailed Engineering Background and Points of Discussion

1. Categorization of the BWMS technologies and identification of the specific hazards associated with the various technologies:

This Rev.2 has been developed based on PT’s members experience, information available from their respective Classification Societies, benchmarking of the available Classification Rules for the installation of BWMS (but not limited to the Classification Rules of the Societies of the PT members) and an exhaustive review of the 83 BWMS listed in IMO’s document in Attachment 1 according to the latest list dated May 2018 published in IMO website.

<https://wwwcdn.imo.org/localresources/en/OurWork/Environment/Documents/Table%20of%20BA%20FA%20TA%20updated%20January%202020.pdf>

The various technologies and their categorization resulting from this exhaustive review are illustrated in the Table 1 and Annex II of UR M74 Rev.2.

<b>BWMS's Technology category (informative Annex II should be referred to)</b>		<b>1</b>	<b>2</b>	<b>3a</b>	<b>3b</b>	<b>3c</b>	<b>4</b>	<b>5</b>	<b>6</b>	<b>7a</b>	<b>7b</b>	<b>8</b>
<b>Characteristics ↓</b>		In-line UV or UV + Advanced Oxidation Technology (AOT) or UV + TiO2 or UV + Plasma	In-line Flocculation	In-line membrane separation and de-oxygenation (injection of N2 from a N2 Generator).	In-line de-oxygenation (injection of Inert Gas from Inert Gas Generator)	In-tank de-oxygenation with Inert Gas Generator	In-line full flow electrolysis	In-line side stream electrolysis	In-line (stored) chemical injection	In-line side-stream ozone injection without gas/liquid separation tank and without Discharge treatment tank	In-line side-stream ozone injection with gas/liquid separation tank and Discharge water treatment tank	In-tank pasteurization and de-oxygenation with N2 generator
<b>Des-infection when ballasting</b>	Making use of active substance		X			In-tank technology: No treatment when ballasting or de-ballasting	X	X	X	X	X	In-tank technology: No treatment when ballasting or de-ballasting
	Full flow of ballast water is passing through the BWMS	X	X	X	X		X				X	
	Only a small part of ballast water is passing through the BWMS to generate the active substance								X			
<b>After-treatment when de-ballasting</b>	Full flow of ballast water is passing through the BWMS	X									X	
	Injection of neutralizer						X	X	X	X	X	
	Not required by the Type Approval Certificate issued by the Administration		X	X								
<b>Examples of dangerous gas as defined in UR M74 §2.3</b>			(1)	O2 N2	CO2 CO		H2 Cl2	H2 Cl2	(1)		O2 O3 N2	O2 N2
<b>Note:</b>		(1) To be investigated on a case by case basis based on the result of the IMO (GESAMP) MEPC report for Basic and Final approval in accordance with the G9 Guideline. (2) In-line side stream electrolysis may also be applied in-tank in circulation mode (no treatment when ballasting or de-ballasting).										

Taking into consideration future developments of BWMS technologies, some additional technologies may be considered in this Table 1 by identifying their characteristics in the same manner as for the above BWMS categories 1, 2, 3a, 3b, 3c, 4, 5, 6, 7a, 7b and 8.

The PT conducted a risk analysis for all these BWMS to identify all the potential hazards to be considered with regards to their respective categories.

The PT has been informed that another PT reporting to the Safety Panel will be tasked through PS17030a (SP14017p) with the following objectives:

- i. To assess fire safety protection issues associated with the various types of BWMS taking into account safety hazards identified by the Machinery Panel (under M42/2017).*
- ii. To consider whether location restrictions are needed for certain types of BWMS (wrt to e.g., ro-ro spaces, engine rooms etc.).*
- iii. To develop the appropriate interpretations/understanding for issues raised.*

At the end of that technical approach, the PT concluded that:

- i. There is an extensive diversity of BWMS technologies and the existing Rev.1 is not addressing this complete range of technologies.
- ii. The existing Rev.1 is not fully covering the potential issues related to the BWMS; and
- iii. The existing Rev.1 contains requirements that will be subject to a separate task PS17030a from a different working group (Safety Panel, SP14017p)
- iv. The BWMS technologies are originated from the water treatment facilities at shore but remains new and only partially explored by the marine industry.
- v. Not all BWMS have been subject to a risk analysis by the Classification Societies, only some of them.
- vi. In their MEPC (GESAMP) Reports for the Basic and Final approval in accordance with the G9 Guideline for BWMS that makes use of active substances, the IMO provides the necessary information for the assessment related to the presence of dangerous liquids or dangerous gas, the chemical reactions in presence, the necessary safety measures to be considered, etc.

To tackle the concerns from this conclusion, the PT considered that it will be necessary to:

- i. insert the Table 1 of the Attachment 2 in §2.1 of the Rev.2;
- ii. make reference to these categories in the wording of the requirements of the Rev.2 to clarify for which BWMS's technology the requirement is applicable;
- iii. insert a Table 2 in §3.1 of the Rev.2 to clarify the applicability of the requirements with regards to the technologies;
- iv. revise the concerned requirements of Rev.1, as necessary;
- v. add the missing requirements in Rev.2 where they are not covered by the existing Rev.1;
- vi. make reference in the Rev.2 to the IMO (GESAMP) MEPC report for the Basic and Final approval in accordance with the G9 Guideline for the assessment of the potential dangerous gas and dangerous liquids that could be expected to be stored or handled by the BWMS and the necessary mitigation measures to be considered for the safety of the ship and its crew;
- vii. remove from the UR M74 the issues that will be addressed by the Safety Panel PT through the task PS17030a (SP14017p)

The result of this work is illustrated in:

- i. Table 2 of the Attachment 2: Proposal from PT PM 42/2017: issues addressed by the Machinery Panel through the UR M74 Rev.2; and
- ii. Table 3 of the Attachment 2: Proposal from PT PM 42/2017: Fire safety protection issues to be addressed by the Safety Panel PT through PS17030a (SP14017p)



## 2. Re-alignment of the definitions and requirements with the IMO, IACS and IEC requirements

The PT identified in the Rev.1 some confusing misalignments with the IMO, IACS and IEC requirements:

- i. When compared to the definition given in the IGC Code Ch. 1.2.24 adopted through IMO Resolution MSC 370(93), there is a mistake in the definition of "hazardous areas" given in §2.3: "electrical" is missing in "...installation and use of electrical equipment."
- ii. The definition of the "hazardous areas" given in §2.3 has been extracted from the IGC Code Ch. 1.2.24 adopted through IMO Resolution MSC 370(93) but is not aligned with the definition of the "hazardous areas" applicable for oil or chemical tankers.
- iii. Considering that the definition of "hazardous areas" given in the IGC Code is related to the hazards generated by the liquefied gas cargoes (i.e. large quantities of gas), is it relevantly applicable for BWMS which are dealing with limited quantities of active substances?
- iv. The difference made in between the "dangerous gas" defined in §2.2 with the definition of "hazardous areas" given in §2.3 is not sufficiently clear and could lead to confusion in its interpretation.
- v. In §3.1.5 of Rev.1 (renumbered §3.1.6 in the Rev.2), when we apply the definition of "hazardous areas" given in §2.3, we will request certified electrical equipment (understand implicitly certified in accordance with IEC 60079 - Electrical apparatus for explosive gas atmospheres) in case the atmosphere is not flammable/explosive but presents some other hazards like toxicity, corrosivity and reactivity. This would not be logical and would not address the concern.
- vi. In §3.1.4, §3.1.6.2, §3.1.6.3, §3.4.2.3, reference is made to "safe area on open deck", does it mean "non-hazardous in the sense of IEC 60092-502" or "non-hazardous in the sense of §2.3" or "non-hazardous in the sense of the definition given in the IGC Code" or "at a sufficient distance from any source of ignition"?
- vii. In §3.1.7, reference is made to "safe area" but the requirement excludes the liquefied gas carriers: why having extracted in §2.3 the definition of the hazardous areas from the IGC Code?
- viii. In §3.2.2, reference is made to "non-hazardous area", is it the same meaning as "safe area" described previously?
- ix. In §3.2.3, it is said: "isolation arrangements are to be fitted on the exposed deck in the hazardous area". There are hazardous areas on the open deck in way of the battery room and paint rooms access doors and ventilation openings and also on the forward poop deck in case of stern cargo loading/unloading manifold arranged in accordance with IACS UR F16: is it an acceptable location for the means of appropriate isolation?
- x. For gas carriers carrying flammable liquids having a flash point not exceeding 60°C, the segregated ballast water tanks could be hazardous area but their ballast pump is located in the Engine Room (non-hazardous). The reason is that there is no ballast tank within the cargo area for liquefied gas carriers. But in such case, the application of §3.2.2 to the liquefied gas carriers will be conflicting with the IGC Code.
- xi. Some chemical carriers can carry toxic cargoes that are not flammable. In such case, there is no hazardous area in the sense of the IEC 60092-502 referred to in the IBC Code but the segregated ballast water tanks remains within the cargo area. These tankers would be excluded from the application of §3.2.2 which is not in compliance with IBC Code Ch. 3.5.1.

The PT identified that the above conflicts have been created by a confusion in between the concept of "hazardous area" given in the IEC 60092-502 and only aimed at placing requirements on the type of electrical equipment installed in these hazardous area and the

concept of "cargo area" given in the IMO and IACS requirements which is aimed at segregating the piping systems. To tackle with those conflicts, the PT introduced the following definition:

¶ 2.2 Cargo area of tankers is defined in SOLAS Ch. II-2 Reg. 3/6, IBC Code Ch. 1.3.6, IGC Code Ch. 1.2.7 and LHNS Guidelines Res. A.673(16) as amended by MSC Res. 236(82) Ch. 1.3.1 (or OSV Chemical Code Res. A.1122(30) Ch 1.2.7) as applicable.¶

Upon further review of the definitions of the cargo area for oil tankers and for chemical tankers following GPG Members comments, the below discussion was carried out by the Panel.

- i. The qualified majority has not been achieved on the view that the requirement related to the cargo area in this UR should be applied to NLS tankers regardless of the application of the IBC Code, taking into account that the IBC Code may or may not apply to NLS tankers (not carrying liquid products listed in Chapter 17 of the Code). However, from a practical viewpoint, while the IBC Code is not necessarily applied to NLS tankers, category Z substances listed in Chapter 18 of the IBC Code are normally carried by oil tankers and therefore there was no need to explicitly cover NLS tankers in this UR.
- ii. The extension of the definition of the cargo area for oil tankers was considered, with a view to covering also tankers carrying "other liquid products having a similar fire hazard" stated in SOLAS regulation II-2/1.6.1. The qualified majority has been achieved on the following modification:

for oil tankers to which regulation 1.6.1 of SOLAS Chapter II-2 as amended by IMO resolutions up to MSC.421(98) (hereinafter the same) applies, regulation 3.6 of SOLAS Chapter II-2 as amended by IMO resolutions up to MSC.421(98)

By referring to the "cargo area", the PT re-aligned the piping segregation with the IMO and IACS requirements listed in Section 3 as quoted below. For Paragraph 3.2.2, addition of the second sentence to accept alternative arrangements was discussed by the Panel, but the qualified majority agreed on deleting it given the possible lack of uniform implementation of the Rev.2.

¶ ~~3.2.2 For tankers carrying flammable liquids having a flashpoint not exceeding 60 °C or products listed in the IBC Code having a flashpoint not exceeding 60 °C or cargoes heated to temperature above their flashpoint and cargoes heated to temperature within 15 °C of their flashpoint.~~

In general, two independent BWMS ~~may~~ should be required i.e. one for ballast tanks ~~in hazardous areas located within the cargo area~~ and the other one for ballast tanks ~~in non-hazardous areas located outside cargo area~~. Specific arrangements where only one single In-line BWMS (categories 1, 2, 3a, 3b, 4, 5, 6, 7a and 7b) could be accepted are given in Annex I.¶

¶ ~~3.2.4. 3.1.7 Ballast piping, including Sampling lines which are connected to the ballast water piping system serving the tanks in the cargo hazardous area and provided for the purpose of the following:~~

~~- for any BWMS: ballast water sampling required by the G2 Guideline of the BWM Convention (2004); or~~

~~- for BWMS technologies categories 4, 5, 6, 7a and 7b: total residual oxidant (TRO) analysis in closed loop system from ballast tanks considered as hazardous areas, is are not to be led into an a non-hazardous enclosed space outside the cargo area regarded as a safe area, without any appropriate measures, except ships carrying liquefied gases in bulk. However, the a sampling point lines for checking the performance of BWMS, for ballast water containing dangerous gas, may lead into a non-hazardous enclosed space outside the cargo area be located in a safe area provided the following requirements are fulfilled:~~

.1 The sampling facility (for BWMS monitoring/control) is to be located within a gas tight enclosure (hereinafter, referred to as a 'cabinet'), and the following i) through (iii) ~~iv)~~ are to be complied.

- i) In the cabinet, a stop valve is to be installed on ~~in~~ each sampling line sample pipe.

- ii) Gas detection equipment is to be installed in the cabinet and the valves specified in i) above are to be automatically closed upon activation of the gas detection equipment.
- iii) Audible and visual alarm signals are to be activated both locally and at the BWMS control station when the concentration of explosive gases reaches a pre-set value, which should not be higher than 30% of the lower flammable limit (LFL) of the concerned product. Upon an activation of the alarm, all electrical power to the cabinet is to be automatically disconnected.
- iv) The cabinet is to be vented to a safe location in non-hazardous area on open deck and the vent is to be fitted with a flame arrester.

.2 The standard internal diameter of sampling pipes is to be the minimum necessary in order to achieve the functional requirements of the sampling system.

.3 The cabinet measuring system is to be installed as close to the bulkhead as possible to the bulkhead facing the cargo area, and length of the sampling lines located outside the cargo area are to be routed on their shortest ways measuring pipe in any safe area is to be as short as possible.

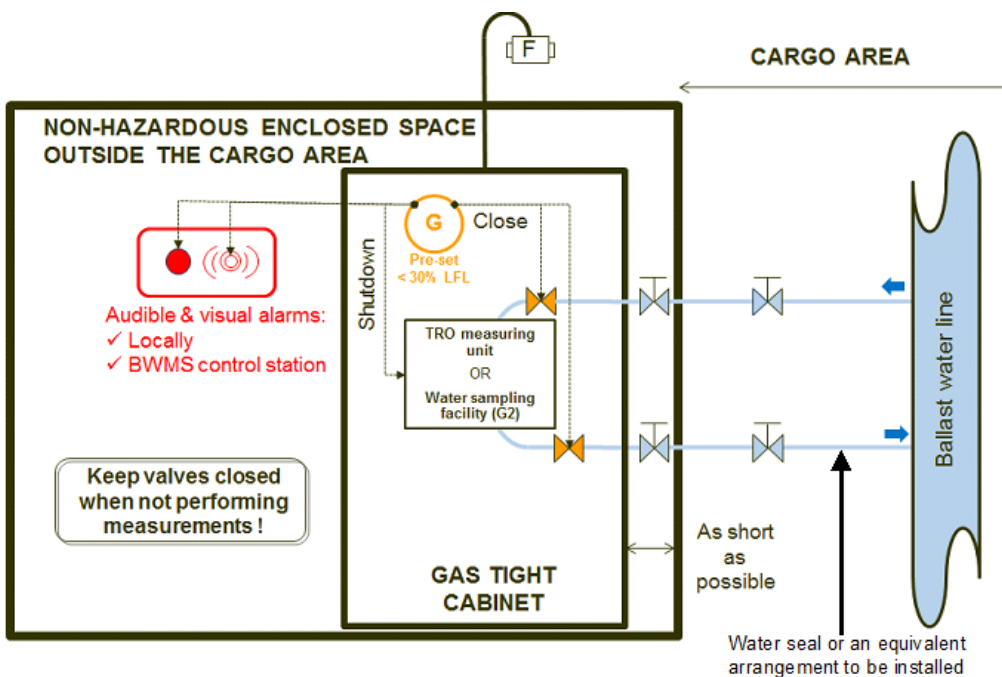
.4 Stop valves are to be located in the non-hazardous enclosed space outside the cargo area safe area, in both the suction and return lines pipes close to the bulkhead penetrations through the bulkhead facing the cargo area. A warning plate stating "Keep valve closed when not performing measurements" is to be posted near the valves. Furthermore, in order to prevent backflow, a water seal or equivalent arrangement is to be installed on the hazardous area side of the return pipe.

.5 A safety stop valve is to be installed on the cargo hazardous area side of for each sampling line pipe.

.6 The samples which are extracted from the ballast water piping system serving the tanks within the cargo area are not to be discharged to a tank located outside the cargo area and not to discharge to a piping line supplying the spaces located outside the cargo area.]

In order to avoid the confusion in between:

the requirement given in §3.2.4 (originally §3.1.7 in the Rev.1) which is applicable to the water sampling lines of tankers subject to §3.2 (aligned with the FSS Code Ch. 16) vs. the requirement given in §3.2.3 (aligned with FSS Code Ch. 15) which is applicable to the main ballast lines and active substances or neutralizer injection lines, the following sketch has been added in §3.2.4: ]



The PT re-aligned below the definition of the "hazardous area" with the definition given in the IEC 60092-502 as referred to in §3.1.5 of the Rev.1 (renumbered §3.1.6 in the Rev.2) where a further modification and retention of the sentence decided by the Panel are highlighted in red:

¶ ~~2.5 2-3~~ Hazardous area is defined in IEC 60092-502:1999 and means an area in which an explosive gas atmosphere is or may be expected to be present, in quantities such as to require special precautions for the construction, installation and use of electrical equipment apparatus. When a gas atmosphere is present, the following hazards may also be present: toxicity, asphyxiation, corrosivity and reactivity.】

The PT introduced the definition of the « non-hazardous areas”:

¶ 2.6 Non-hazardous area means an area which is not a hazardous area as defined in above 2.5.】

The PT completed the definition of the « dangerous gas » which is now clearly differentiated from the definition of « hazardous area » where further editorial modifications and retention of the sentence decided by the Panel are highlighted in red:

¶ ~~2.3 2-2~~ Dangerous gas means any gas which may develop an explosive and/or toxic atmosphere being hazardous to the crew and/or the ship due to ~~the presence of flammability, explosiveness, toxicity, asphyxiation, corrosiveness and reactivity hazards may be present with and for which~~ due consideration of the hazards ~~for is required~~, e.g. hydrogen (H<sub>2</sub>), hydrocarbon gas, oxygen (O<sub>2</sub>), carbon dioxide (CO<sub>2</sub>), carbon monoxide (CO), ozone (O<sub>3</sub>), chlorine (Cl<sub>2</sub>) and chlorine dioxide (ClO<sub>2</sub>), etc.】

The PT introduced the definition of the “safe location” for the location of the outlets of the vent pipes releasing either inert gas or nitrogen enriched air or oxygen-enriched air with reference to the note \*) “safe location” of UR F20 and extended that approach for hydrogen-enriched air:

¶ Footnote \*):

Safe location needs to address the specific types of discharges separately.  
Signboards or similar warnings at the discharge areas are to be provided.:

Safe location\*(1): inert gas or nitrogen product enriched air from:

- in-line (categories 3a and 3b) and in-tank (categories 3c and 8) de-oxygenation BWMS: the protection devices installed on the ballast tanks, nitrogen or inert gas generators, nitrogen buffer tank (if any); or
  - in-line ozone injection BWMS (categories 7a and 7b): the oxygen generator;
- safe locations on the open deck are:
- not within 3 m of areas traversed by personnel; and
  - not within 6 m of air intakes for machinery (engines and boilers) and all ventilation inlets/outlets.

Safe location\*(2): oxygen-enriched air from:

- in-line and in-tank de-oxygenation BWMS (categories 3a and 8): the nitrogen generator; or
  - in-line ozone injection BWMS (categories 7a and 7b): the protection devices or vents from oxygen generator, compressed oxygen vessel, the ozone generator and ozone destructor devices;
- safe locations on the open deck are:
- outside of hazardous area;
  - not within 3 m of any source of ignition and from deck machinery, which may include anchor windlass and chain locker openings, and equipment which may constitute an ignition hazard;
  - not within 3 m of areas traversed by personnel; and
  - not within 6 m of air intakes for machinery (engines and boilers) and all ventilation inlets.

Safe location\*(3): hydrogen by-product enriched gas from:

- in-line full flow electrolysis BWMS (category 4), in-line side-stream electrolysis BWMS (category 5) and in-line injection BWMS using chemical which is stored onboard (category 6): the hydrogen de-gas arrangement (when provided);

safe locations on the open deck are:

- not within 5 m of any source of ignition and from deck machinery, which may include anchor windlass and chain locker openings, and equipment which may constitute an ignition hazard;
- not within 3 m of areas traversed by personnel; and
- not within 5 m of air intakes from non-hazardous enclosed spaces.

The areas on open deck, or semi-enclosed spaces on open deck, within 3 m of the outlets are to be categorized hazardous zone 1 plus an additional 1,5 m surrounding the 3 m hazardous zone 1 is to be categorized hazardous zone 2.

Electrical apparatus located in the above hazardous areas zone 1 and zone 2 is to be suitable for at least IIC T1.

Safe location\*(4): For in-line ozone injection BWMS (categories 7a and 7b), vent outlet from O3 destructor device (ODS) can be considered as oxygen-enriched air ~~as per paragraph .2~~ provided that:

- the ODS are duplicated; and
- the manufacturer justified that the quantity of consumable (activated carbon) used by the ODS is sufficient for the considered life cycle of the BWMS; and
- ozone detection is arranged in the vicinity of the discharge outlet from the vent outlet of the ODS to alarm the crew in case the ODS is not working.

If one of the above 3 conditions is not fulfilled, the safe location from ODS on open deck are:

- outside of hazardous area;
- not within 3 m of any source of ignition;
- not within 6 m of areas traversed by personnel; and
- not within 6 m of air intakes for machinery (engines and boilers) and all ventilation inlets.]

### **3. Revamping of the Annex I in Rev.2**

The PT noted the following issues and inconsistencies in the existing Annex I of Rev.1:

- i. There is no indication on the colour code to explain the difference in between the blue/red/green/black dotted lines (refer to PM11902cIMb regarding the questions for clarification on M74 3.2.3 and Annex).
- ii. The valves indicated in the Annex I are not addressed in the UR but provide confusion to the reader (refer to PM11902cIMb regarding the questions for clarification on M74 3.2.3 and Annex).
- iii. The ballast discharging lines are oriented to the sea chest which could be confusing.
- iv. The Annex I in Rev.1 is actually allowing only limited BWMS technologies:
  - a. BWMS which does not require after treatment: cases 1.2 and 1.3a
  - b. BWMS which requires after treatment: cases 1.3b and 1.6

To tackle with the above issues, the PT decided to completely revamp the Annex I and adopted the following driving principles:

1. With due consideration of the definition of "cargo area" given in SOLAS Convention, IBC and IGC Codes and LHNS Guidelines (or OSV Chemical Code):
  - The segregated ballast water tanks sited immediately adjacent to integral cargo tanks are to be considered within the cargo area: §3.2 and Annex I apply
  - When the cargo tanks are not integral tanks but independent tanks arranged in a cargo hold (ex. Asphalt carrier or gas carriers Type A, Type B and Type C) or separated with insulation spaces and/or inter-membrane spaces (ex. Membrane LNG carriers), the segregated ballast water tanks are not to be considered within the cargo area: §3.2 and Annex I do not apply.
2. FSS Code Ch. 15 §2.3.1.1.2 *The inert gas generators shall be located outside the cargo tank area.*
  - Cases 2.3b is not allowed, refer to §3.2.1.1 in Rev.2.

3. Considering the O2 generator, O2 storage tank and O3 generator that significantly promote the potential of fire and explosion, the PT unanimously agreed to extend the same to BWMS categories 7a and 7b.  
→ Cases 2.7a and 2.7b are not allowed, refer to §3.2.1.1 in Rev.2.

4. IBC Code Ch. 3.5 Bilge and ballast arrangements

*3.5.1 Pumps, ballast lines, vent lines and other similar equipment serving permanent ballast tanks shall be independent of similar equipment serving cargo tanks and of cargo tanks themselves. **Discharge arrangements for permanent ballast tanks sited immediately adjacent to cargo tanks shall be outside machinery spaces and accommodation spaces. Filling arrangements may be in the machinery spaces provided that such arrangements ensure filling from tank deck level and non-return valves are fitted.***

- The sea chests and ballast pumps in the ER can be used for filling the ballast tanks located within the cargo area (cases 1.2, 1.3a, 1.4, 1.5, 1.7a, 1.8a) but cannot be used for discharging the ballast tanks located within the cargo area (case 1.1 is not allowed).
- The sea chests and ballast pumps in the CPR cannot be used for filling or discharging the Aft Peak Tank.

5. IMO MSC Circ. 406 Rev.1, interpretation of IBC Ch. 3.5.1 *Discharge arrangement of permanent ballast tanks sited immediately adjacent to cargo tanks*

*An eductor situated in the cargo area using water power from the machinery spaces is acceptable for discharging purposes provided a non-return valve and means of separation are fitted in the supply line and the supply line is above deck level. A non-return valve and means of separation should be located outside the machinery space (see figure 4).*

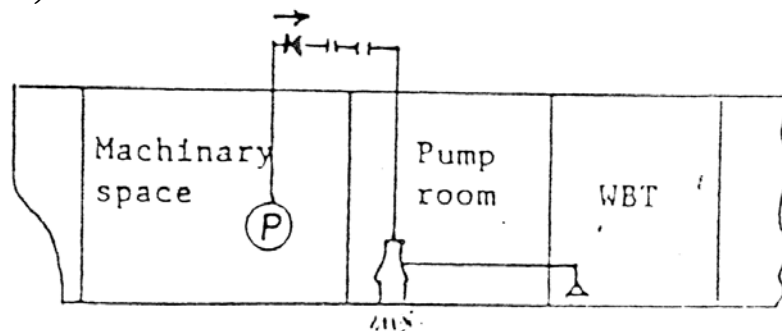


Figure 4 - Discharge arrangement of permanent ballast tanks sited immediately adjacent to cargo tanks (Paragraph 3.5.1)

- When full flow of ballast water is pumped from the ER and discharged to the cargo area, a spool piece (i.e. non-permanent connection) is required: difference is to be made in between the means of disconnection proposed in §3.2.3.1 vs. the other means of appropriate isolation proposed in §3.2.3.2 and §3.2.3.3.
- For cases 1.2, 1.3a, 1.4, 1.7b, 2.1, 2.2, 2.3a and 2.4: only the means of disconnection §3.2.3.1 are to be used.

The result of this technical approach is summarized in the below table:

The cases 2.1, 2.2, 2.3a and 2.4 are those for which additional consideration should be provided to:

- i. Prevent against any discharge arrangement from the segregated water ballast tanks within the cargo area that would be arranged in the machinery spaces;





	BWMS									
	Injection of neutralizer					X	X	X	X	X
	Not required by the Type Approval Certificate issued by the Administration		X	X						
<b>Examples of dangerous gas as defined in UR M74 §2.3</b>			(1)	O2 N2	CO2, CO	H2, Cl2	H2, Cl2	(1)	O2, O3, N2	
<b>Arrangement of one single BWMS</b>	BWMS is located outside the cargo area	Not Acceptable	Case 1.2 (2)	Case 1.3a (2)	Case 1.3b	Case 1.4 (2)	Case 1.5	Case 1.6	Case 1.7a	Case 1.7b (2)
	<del>BWMS is located in the cargo area</del>	<del>Case 2.1 (2), (3)</del>	<del>Case 2.2 (2), (3)</del>	<del>Case 2.3a (2), (3)</del>	<del>Not Acceptable</del>	<del>Case 2.4 (2), (3)</del>	<del>Case 2.5</del>	<del>Case 2.6</del>	<del>Not Acceptable</del>	
	*Notes: (1) To be investigated on a case by case basis based on the result of the IMO (GESAMP) MEPC report for Basic and Final approval in accordance with the G9 Guideline. (2) Only « Means of dis-connection » as described in 3.2.3.1 are to be applied. Other means of appropriate isolation 3.2.3.2. or 3.2.3.3 are not acceptable. <del>(3) Warning notice with operating instructions and means of mechanical or electronic interlocking are to be applied</del> (4) In-line side stream electrolysis may also be applied in-tank in circulation mode (no treatment when ballasting or deballasting)									

#### 4. Footnote \*) 4. (Rev.2) discharge from Ozone Destructor Device (ODS)

Ozone (O3) is a highly toxic gas (irritant and poisoning when inhaled), highly oxidant (corrosive), not flammable but promoting the combustion process so that spontaneous explosive reaction can be expected.

Ozone Destructor device (ODS) is fitted at the venting discharge from the Ozone generator. Through the ODS, the Ozone is catalysed back into Oxygen tanks to a catalytic process using activated carbon. For the BWMS categories 7a investigated, the PT members wondered whether we could expect Oxygen-enriched air only or also a probability of Ozone-enriched air at the outlet of the vent pipe from the ODS with due consideration of the potential failure modes. For the BWMS category 7a used for this investigation, the ODS is duplicated and contains a consumable (activated carbon) in sufficient quantity for all the life-cycle of the ship but there was no Ozone detector at the outlet of the ODS.

The PT discussed extensively on the reliability of the ODS and its potential failure modes. The PT recognized that the ODS is a passive device but identified that in case of mechanical damage of the ODS during the operations or maintenance of the ship, one or both ODS can be damaged and that, for safety reasons, the crew needs to be informed of such failure for renewing that damaged part. This investigation resulted into PT's decision that it is not necessary to introduce specific requirements related to the discharge of Ozone-enriched air but the following



requirements have to be considered in order to disregard the risk of ozone at the outlet of the vent pipe from the ODS:

¶ Safe location\*(4): For in-line ozone injection BWMS (categories 7a and 7b), vent outlet from O3 destructor device (ODS) can be considered as oxygen-enriched air as per paragraph .2 provided that:

- the ODS are duplicated; and
- the manufacturer justified that the quantity of consumable (activated carbon) used by the ODS is sufficient for the considered life cycle of the BWMS; and
- ozone detection is arranged in the vicinity of the discharge outlet from the vent outlet of the ODS to alarm the crew in case the ODS is not working.

If one of the above 3 conditions is not fulfilled, the safe location from ODS on open deck are:

- outside of hazardous area;
- not within 3 m of any source of ignition;
- not within 6 m of areas traversed by personnel; and
- not within 6 m of air intakes for machinery (engines and boilers) and all ventilation inlets.

]

#### **5. §3.1.2 (Rev.1) reference to the TAC issued by the Flag Administration, modified in Rev.2**

The group identified that through the 46 CFR 162.060-20 (b) (4), the USCG (who are not a ratifying Party to the IMO Convention) request a manual operation for the activation of the by-pass. This requirement is not applicable for the BWMS certified in accordance with the IMO G8 Guidelines only. In addition, 46 CFR 162.060-20 (b) indicates at (5) *Means that compensate for a momentary loss of power during operation of the BWMS so that unintentional discharges do not occur.* The PT discussed on potential interpretation of the combination of these two requirements leading to a "fail-close" operation mode of the by-pass which could be somehow conflicting with the principle of prioritizing the safety of the ship and its crew against the protection of the environment.

The PT noted that both IMO G8 Guidelines and USCG refer to the Operation Maintenance and Safety Manual (OMSM) to address the emergency procedures to be applied for securing the ship and noted that the manual is named "Operation and Technical Manual" in 2008 G8 Guideline but renamed OMSM in 2016 G8 Guideline. In practice, the manuals prepared by the BWMS's manufacturers are now commonly named OMSM even if they are approved in accordance with the 2008 G8 Guideline. The emergency procedures provided by the BWMS manufacturers in their OMSM could be summarized by "Emergency situation" → "BWMS shutdown" → "Alarm" → "By-pass open".

In order to address the applicable emergency procedures approved by the Administration during their review of the OMSM, the PT agreed for the addition of the following requirement in §3.1.3 of the Rev.2:

¶The arrangement of the bypasses or overrides of the BWMS is to be consistent with the approved Operation Maintenance and Safety Manual by the Flag Administration's Type Approval.

]

And in a new §3.1.9:

¶3.1.9 When it is required to have an automatic shutdown of the BWMS for safety reasons, this must be initiated by a safety system independent of the BWM control system. ]

In addition, it was noted that the operating limitations specified in the TAC issued by the Flag Administrations are not limited to the maximum Treatment Rated Capacity (TRC) only. Other operational limitations need to be considered such as minimum water salinity for electrolysis BWMS, after treatment (additional disinfection or neutralization) before discharging, etc. To address all the potential requirements specified in the TAC issued by the Flag Administrations, it was agreed to provide the following revision in §3.1.3 of Rev.2:

¶The BWMS is to be operated at a flow rate within the Treatment Rated Capacity (TRC) range in accordance with the requirements specified in the Type Approval Certificate (TAC) issued by the Flag Administration. BWMS should be operated within its Treatment Rated Capacity (TRC) as per the TAC. This may require limiting of ship’s ballast pump flowrates.¶

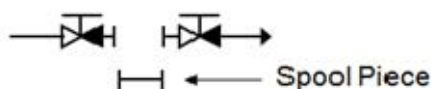
and

¶In case the maximum capacity of the ballast pump(s) exceeds the maximum treatment rated Capacity (TRC) of the BWMS specified in the TAC issued by the Flag Administration, there should be a limitation on the BWMP giving a maximum allowable flow rate for operating the ballast pump(s) that shall not exceed the maximum TRC of the BWMS. ¶

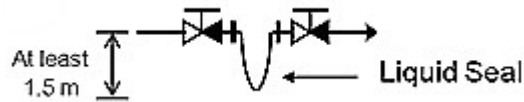
**6. §3.2.3 (Rev.1) means of appropriate isolation: screw-down valve, modified in Rev.2**

The PT noted that this requirement for “screw-down” was limiting the type of the valves to globe valves or gate valves only which is not a practical solution for the industry. In case of big diameters (example for the main ballast lines), the shipyards usually propose butterfly valves and in case of small diameters (example for the generation and injection of the active substances or neutralizer), shipyards could also propose ball valves. It is recognized that screw-down valves provide the highest level of protection against liquid leakages but are required when the consequence of a liquid leakage will be critical for the stability of the ship (example for flooding concerns through the bilge lines or through the valve on the collision bulkhead) but for some diameter ranges, screw-down valves are not easily available on the market and it is not possible to install an actuator with an hydraulic remote control for the screw-down valves (it needs the installation of an explosion proof electrical motor for each valve). In practice, the use of butterfly valves or ball valves is commonly accepted by the Classification Societies when the flooding through a valve leakage is not a concern for the stability of the ship in cases of cargo ships (See MSC.1/Circ.1567 and SOLAS regulation II-1/12.6.1 as amended by Resolution MSC.421(98)). In this regard, it is to be noted that the means of appropriate isolation are required to be installed on the exposed deck and consequently not relevant for the concern of flooding a watertight compartment located below the free-board deck. In this regard, the request for “screw-down” type at §3.2.3 was considered excessive by the PT. It was also noted that the purpose of the positive means of closure of the valves referred to in §3.2.3 is not primarily the protection against liquid leakages; this protection against liquid leakages is already achieved by the non-return swing check flap integrated to the non-return valve or by addition of a swing check valve. Through the reference to the non-return devices required for the inert gas systems in FSS Code Ch 15/2.2.3.1 (refer to HF for Rev.1), the PT identified that the primary purpose of the means of appropriate isolation is to prevent the return of dangerous vapours originated from the cargo area to the gas safe spaces when the pipes are empty. Therefore, it was agreed to align that §3.2.3 with FSS Code Ch. 15/2.2.3.1 through the following revision:

¶.1 Two ~~screw-down check~~ non-return valves with positive means of closing in series with a spool piece (also mentioned “means of disconnection” in Annex I), or  
Note: As an alternative to positive means of closure, an additional valve having such means of closure may be provided between the non-return valve and the spool piece.

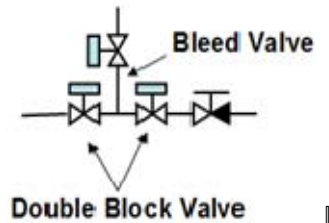


.2 Two ~~screw-down check~~ non-return valves with positive means of closing in series with a liquid seal at least 1.5 m in depth, or  
Note: As an alternative to positive means of closure, an additional valve having such means of closure may be provided between the non-return valve and the liquid seal.



.3 Automatic double block and bleed valves and a non-return valve with positive means of closing.

Note: As an alternative to positive means of closure, an additional valve having such means of closure may be provided after the non-return valve.



This modification remains in accordance with the SOLAS, IBC and IGC requirements which are not specifying "screw-down" type (see also IMO MSC Circ. 406 Rev.1 Figure 4 where "screw-down" is not mentioned).

An additional consideration has been raised for adding a remote control valve in the engine room to maintain the fire integrity of the bulkhead facing the cargo area. However, after further discussion, this consideration has been abandoned by the PT considering that this could be discussed with the PT Safety Panel PS17030a in charge of the fire protection issues related to the BWMS.

#### **7. §3.4.2.2 (Rev.1) strength and construction of chemical tanks, modified and renumbered §3.3.3.2 in Rev.2**

The PT acknowledged that the wording given in the Rev.1 was too vague and could be interpreted either with zeal (in practice, what kind of evidence involving the Classification Rules could be provided to justify that the tank has sufficient strength if the tank was not subject to a design review as applicable to a pressure vessel?) or with laxity (no reference to any Rules or standard means no straight forward action).

The PT also acknowledged that the existing requirement in Rev.1 was not making any difference in between a compressed O<sub>2</sub> storage tank (which is more dangerous than a compressed air tank subject to the pressure vessels requirements from the Classification Societies) and a N<sub>2</sub> buffer tank with low design pressure.

The PT also acknowledged that existing requirement in Rev.1 was not making any difference in between a sulphuric acid storage tank (which is highly dangerous due to the exothermic reaction of the acid sulphuric when in contact with water) and a neutralizer storage tank that would not contain dangerous liquids.

After extensive discussions, the PT agreed to modify the requirement by making the difference in between:

- independent tank permanently fixed on-board vs. portable tanks; and
- dangerous gas vs. non-dangerous gas (some gases ex. nitrogen are chemical substances but are not dangerous in the sense of the definition given in §2.3 of the Rev.2); and
- dangerous liquid vs. non dangerous liquid (some chemicals ex. the neutralizers are chemical substances but are not dangerous in the sense of the definition given in §2.4 of the Rev.2):

¶.2 Chemical substances (even if they are not defined as dangerous liquid in the sense of 2.4) and gas storage tanks are to have sufficient strength and be constructed such that maintenance and inspection can be easily performed be designed, constructed, inspected, certified and maintained in accordance with:

- for independent tanks permanently fixed onboard containing dangerous liquids (eg. sulfuric acid H2SO4) or dangerous gas (eg. oxygen O2): the Classification Rules as applicable to pressure vessels
- for independent tanks permanently fixed onboard not containing dangerous liquid (eg. sodium sulphite, sodium bisulphite or sodium thiosulphate neutralizers) and not containing dangerous gas (eg. nitrogen N2): the Classification Rules or other industry standard recognized by the Classification Society  
for portable tanks: the IMDG Code or other industry standard recognized by the Classification Society. ]

## 8. §4 (Rev.1) Automation, deleted in Rev.2

The PT identified that the existing §4 in Rev.1 was redundant and source of confusion with the following statutory requirements:

- 2008 G8 Guideline IMO MEPC Res. 174(58) §4 Technical specifications §4.5.3 and §4.5.4
- 2016 G8 Guideline IMO MEPC Res. 279(70) §4 Technical specifications §4.9.3 and §7 Installation requirements following Type Approval process §7.2 and PART 5 – Self Monitoring §5.3.5.

On the other hand, the PT did not identify the added value of that §4 compared to the statutory requirements of the IMO G8 Guidelines.

In order to avoid any conflict or misunderstanding with the Statutory requirements of the IMO G8 Guidelines, it was decided to delete that §4.

## 9. Risk assessment §3.3.4

The PT has conducted a survey with the following questions:

1. Refer to §3.3.4: what is your understanding and definition of an acceptable "Risk assessment" for BWMS? The majority replied that referring to acceptable standards (ex. ISO 31010) or Classification Rules (ex. BV's NI525 Risk Based Qualification of new technology methodological guidelines) or IACS (ex. Recommendation Rec. 146) plus that a reference to the methodology (ex. FMEA, FEMCA, HAZID, HAZOP, etc) were necessary.
2. With reference to §3.3.4: in which case should we request a "Risk assessment"? The majority replied:
  - For BWMS category 4: in all cases
  - For BWMS category 5: in all cases
  - For BWMS category 6: when the MSDS indicates that the chemical substance stored on-board is either flammable, toxic, corrosive or reactive;
  - For BWMS categories 7a and 7b: in all cases.
3. What is the expected outcome of requesting a risk assessment? The majority replied:
  - Ensure that the package supplied by BWMS's manufacturer is intrinsically safe; and
  - Provide mitigation measures to the hazards created by the BWMS which have been identified during the Classification's TAC process but that need to be considered during the installation on-board.
4. Do you agree that if a risk assessment is to be carried out for BWMS, it should be conducted in a generic manner during the Classification's TAC process and not in a systematic manner during the installation on-board a specific ship? The majority replied "YES"
5. Do you request a 3<sup>rd</sup> Party attending the risk assessment (for example attendance during HAZID or HAZOP meetings)? The majority replied "NO"
6. When the "Risk assessment" report is submitted to the Classification, is it required to be approved by the Classification Society? The majority replied "YES"
7. For which BWMS category (1, 2, 3a, 3b, 3c, 4, 5, 6, 7a, 7b, 8). The majority replied 4, 5, 6, 7a and 7b.
  - Would you systematically request a risk assessment? The majority replied "NO"
  - Would you request a risk assessment on a case by case basis: The majority replied "NO"
  - Would you exempt from requesting a risk assessment? The majority replied "NO"

The result of the discussions has been implemented in the following revision of §3.3.4:

¶3.3.4 A risk assessment may is to be conducted to ensure that risks, including but not limited to those arising from the use of dangerous gas affecting persons on board, the environment, the structural strength or the integrity of the ship are addressed. in a generic manner during the TAC process mentioned in 3.1.4 and submitted to the Classification Society for approval for the following BWMS categories:

- BWMS category 4: in all cases;

- BWMS category 5: in all cases;

- BWMS category 6: when one of the MSDS indicates that the chemical substance stored on-board is either flammable, toxic, corrosive or reactive;

- BWMS category 7a and 7b: in all cases.

Note: The IMO reports issued during the basic and final approval procedures of the BWMS that make use of active substances (G9 Guideline) could be used as a reference for this assessment.

.1 The recommended risk assessment techniques for BWMS and other guidances are listed below but not limited to:

- FMEA, FMECA, HAZID, HAZOP, etc.

- ISO 31010 – Risk Assessment Techniques

- IACS Recommendation Rec. 146

- Rules of the Classification Society for risk assessment techniques

.2 The risk assessment should ensure that the package supplied by the BWMS's manufacturer is intrinsically safe and/or provides mitigation measures to the hazards created by the BWMS which have been identified during the TAC process mentioned in 3.1.4 but that need to be implemented during the installation on-board. ]

By the Panel, the term "*TAC process*" was modified to "design review" according to improvement of §3.1.4 (See Section 11 below).

## **10. BWMS certification by Classification**

The PT has conducted a survey with the following questions:

1. Do you want Type Approval from Classification to be made mandatory for all BWMS? The majority replied "YES"
2. Do you think that the BWMS package should be inspected by Classification at manufactory? The majority replied "YES"
3. How do you identify the BWMS's components that are required to be inspected and certified by the Classification at manufactory (product certification) like pressure vessels, piping class I or Class II, self-draining, filters, switchboards, etc? The majority replied during the Type Approval or generic Design Approval process of manufacturer's package but this is too late if this is conducted for the installation on-board a specific ship.

The result of the discussions has been implemented by inserting the following §3.1.4 after §3.1.3:

¶3.1.3 The BWMS is to be operated at a flow rate within the Treatment Rated Capacity (TRC) range in accordance with the requirements specified in the Type Approval Certificate (TAC) issued by the Flag Administration.  
The arrangement of the bypasses or overrides of the BWMS is to be consistent with the approved Operation Maintenance and Safety Manual by the Flag Administration's Type Approval.  
In case the maximum capacity of the ballast pump(s) exceeds the maximum treatment rated Capacity (TRC) of the BWMS specified in the TAC issued by the Flag Administration there should be a limitation on the BWMP giving a maximum allowable flow rate for operating the ballast pump(s) that shall not exceed the maximum TRC of the BWMS.

3.1.4 BWMS should be subject to Type Approval process from the Classification society to verify the compliance of the BWMS's manufacturer package with the Classification Rules.

In general, monitoring functions of BWMS belongs to system category I under the application of the UR E22 Rev.2. However in case a by-pass valve is integrated in the valve remote control system, the by-pass valve belongs to the system category II Ballast transfer remote control system.

The BWMS's components are required to be inspected and certified by the Classification Society at the manufactory (Society Certificate (SC) as defined in UR M72) including pressure vessels, piping class I or II, filters, switchboards, etc.]

By the Panel, the following changes were made:

At the end of the first paragraph of §3.1.3, the following sentence was added: BWMS should be operated within its Treatment Rated Capacity (TRC) as per the TAC. This may require limiting of ship's ballast pump flowrates.

In the first paragraph of §3.1.4, the term "*Type Approval*" was modified to "design review" subject to addition of the following sentence at the end of said paragraph: Manufacturers of the BWMS may apply for this design review at the type approval process.

## **11. Cavitation**

In order to address the systems using the cavitation for the ballast water treatment, the following requirement has been added at §3.1.8:

§3.1.8 When cavitation is the BWMS treatment process (for example by use of pressure vacuum reactor working in combination with a vertical ballast water drop line) or part of the BWMS treatment process (for example by use of "smart pipe" or "special pipe" in BWMS category 7b or by use of "venturi pipe" in BWMS technology 3b) or by use other means, the design and the wall thickness or grade of materials or inside coating or surface treatment of the part of the piping where the cavitation is taking place is to be specifically considered]

On Member deemed that §3.1.8 should be applied to the category 7a due to usage of venturi pipe. PT clarified that §3.1.8 should apply to the "special pipes" provided intentionally for creating cavitation as a treatment process but §3.1.8 should not address ejectors used for injecting an active substance to the ballast water.

## **12. Other modifications**

The following notable modifications were made to improve the Rev.2:

In the first paragraph of §3.1.2, the following sentence was added as the first sentence: The BWMS is to be provided with by-pass or override arrangement to effectively isolate it from any essential ship system to which it is connected.

In the first paragraph of §3.1.5, a clarification was made that vacuum or overpressure in the ballast piping should also be covered.

In §3.1.7.2, compliance with F20.4.6 is also additionally required and a clarification was made that the terms "cargo tanks" and "cargo piping" (for the application of F20.4.6) should be understood as "ballast tanks" and "ballast piping" respectively and, for de-oxygenation BWMS (categories 3a, 3b, 3c and 8), the requirements in 3.1.7.1 prevail notwithstanding F20.4.

In §3.2, the term "cargo tank area" not defined in the FSS Code Chapter 15 was deleted.

In Note 2 of §3.2.3.1, a requirement, which may be applied the discretion of the Classification Society and for active substance piping and neutralizer piping (both up to 2 inches) only, was added for exceptional cases.

In §3.2.3.2, the location of the means of appropriate isolation was clarified.

In §3.3.1.2, it was clarified that automatic shutdown should be required when the oxygen level raises above 25 % and that audible and visual alarms independent from those specified in the preceding paragraph should be activated prior to this shut-down.

In §3.3.1.5, it was clarified that ventilation fans should be certified explosion proof and have spark arrestors in the location with H<sub>2</sub> in dangerous concentrations.

\*\*\*\*\*

## UR M75 “Ventilation of emergency generator rooms”

### Summary

In Rev.1 of this Resolution, changes have been made to achieve consistency with requirements from SOLAS Convention and the International Load Line Convention so that possible challenges during PSC inspections could be avoided.

### Part A. Revision History

Version no.	Approval date	Implementation date when applicable
Rev.1 (Jan 2021)	20 January 2021	1 January 2022
New (Feb 2016)	2 February 2016	1 January 2017

- **Rev.1 (Jan 2021)**

#### 1 Origin of Change:

- Suggestion by IACS member

#### 2 Main Reason for Change:

In paragraph 1 of UR M75 (Feb 2020) titled “Introduction”, following was stated:

##### Quote

*Emergency generator rooms are provided with ventilation openings for the admission of combustion air to engines and the removal of heat. These openings are usually provided with louvers which can be closed (when fire breaks out in emergency generator rooms). The louvers may be hand-operated or power-operated. Alternatively, the louvers may be of fixed type with a closing door which may be hand-operated or automatic.*

##### Unquote

Although, the above quoted text(in italics) was just a description of the arrangements commonly used for ventilation openings and closing devices in emergency generator rooms and had only informative value, it was observed that there was a possibility of the above text being understood as requiring the openings of emergency generator rooms to be fitted with closable louvers under all situations.

To elaborate on the above, the requirement for providing closing appliances for emergency generator room louvers is governed by Reg.9 of SOLAS Ch II-2, in particular notes of table 9.3. to 9.8 (i.e. based on the fact whether the emergency generator room is fitted with a fixed gas fire-extinguishing system) and in accordance to Reg. 19 of ICLL, Annex I;



In order to eliminate possible mis-understanding as described above and to clarify the applicability of the UR (i.e. when means of closure is fitted to the emergency generator room openings, provisions of UR M75 should apply), the UR has been amended.

**3 List of non-IACS Member classification societies contributing or participating in IACS Working Group:**

None

**4 History of Decisions Made:**

It's agreed by Machinery Panel Members that UR M75 is to be modified by:

- specifically stating that the emergency generator room air intake openings are required to be provided with closing appliances only under some certain circumstances as described in SOLAS and International Load Line Convention;

- removing the original content in '1. Introduction'.

**5 Other Resolutions Changes:**

None

**6 Any hinderance to MASS, including any other new technologies:**

None

**7 Dates:**

Original Proposal: 12 August 2019 (Made by Machinery Panel Member)

Panel Approval: 13 November 2020 (Ref: PM19937\_IMk)

GPG Approval: 20 January 2021 (Ref: 20214\_IGc)

• **New (Feb 2016)**

**1 Origin of Change:**

- Suggestion by IACS member

**2 Main Reason for Change:**

Reports of failures of emergency generators caused by inadvertent ventilation louver closing.

**3 List of non-IACS Member classification societies contributing through the TC Forum and/or participating in IACS Working Group:**

None

**4 History of Decisions Made:**

The UR was developed by correspondence in the Panel and agreed at the 22nd Panel meeting.

**5 Other Resolutions Changes:**

None

**6 Any hinderance to MASS, including any other new technologies:**

None

**7 Dates:**

Original Proposal: 23 April 2013 (Made by Machinery Panel Member)

Panel Approval: 22nd Panel Meeting

GPG Approval: 2 February 2016 (Ref: 14075\_IGe)

\*\*\*\*\*

## **Part B. Technical Background**

List of Technical Background (TB) documents for UR M75:

Annex 1. **TB for New (Feb 2016)**

See separate TB document in Annex 1.

Annex 2. **TB for Rev.1 (Jan 2021)**

See separate TB document in Annex 2.



## **Technical Background (TB) document for UR M75 (New Feb 2016)**

### **1. Scope and objectives**

- Prevent ventilation louvers of emergency generator rooms from inadvertently closing
- Clarify requirements for manual and automatic operation

### **2. Engineering background for technical basis and rationale**

Based on an incident where a leaking non-return valve in the air supply to the louver operating system resulted in the closing of a ventilation louver with subsequent failure of the emergency generator after a short period, it was considered that louvers shall be of the fail-to-open type.

Ventilation louvers need to be open when the emergency generator is started and safeguards are to be provided to prevent their inadvertent closing.

Ventilation louvers may either be hand-operated or power-operated (hydraulic / pneumatic / electric) and are to be operable under a fire condition.

### **3. Source/derivation of the proposed IACS Resolution**

None.

### **4. Summary of Changes intended for the revised Resolution:**

N/A.

### **5. Points of discussions or possible discussions**

None.

### **6. Attachments if any**

N/A.

## Technical Background (TB) document for UR M75 (Rev.1 Jan 2021)

### 1. Scope and objectives

1. Re-analyse UR M75 to identify the sentence which may lead to misunderstanding and confusion on the emergency generator room openings
2. Amend UR M75 to make it clear about the conditions under which means of closure should be fitted to the emergency generator room openings.

### 2. Engineering background for technical basis and rationale

1. Introduction of UR M75 reads as:

“

Emergency generator rooms are provided with ventilation openings for the admission of combustion air to engines and the removal of heat. These openings are usually provided with louvers which can be closed (when fire breaks out in emergency generator rooms). The louvers may be hand-operated or power-operated. Alternatively, the louvers may be of fixed type with a closing door which may be hand-operated or automatic.

”

But the sentence “These openings are usually provided with louvers which can be closed (when fire breaks out in emergency generator rooms).” has been understood as that the openings of emergency generator rooms are required to be fitted with closable louvers under all situations. This understanding is different from requirements from SOLAS and International Load Line Convention, which require closable louvers to be fitted to the emergency generator room openings only under some certain circumstances.

A member was of the opinion that section **1. Introduction** of existing UR M75 was just a description of the arrangements commonly used for ventilation openings and closing devices in emergency generator rooms. It had only informative value and was not a requirement. Accordingly, it was proposed to replace it by the application statement given in the first paragraph of section **2. Requirements**.

### 3. Source/derivation of the proposed IACS Resolution

None

### 4. Summary of Changes intended for the revised Resolution:

- The title of Section 2 is changed from ‘Introduction’ to ‘Application’.
- The content of section 1 is changed to clarifying intention of UR applying on closing means for the emergency generator room air intake openings. And the closing means can be provided by closable louver or closing appliances.
- The first sentence of Section 2 is deleted due to overlapping with Section 1.

## 5. Points of discussions or possible discussions

At the late stage of discussion, Machinery Panel discussed whether there is a need to add a footnote to Paragraph 1 of this UR as follows:

*Footnote \*1: This UR is not intended to apply to emergency generator rooms having air intake openings without means for closure such as those openings in accordance with Regulation 19(3) of the Protocol of 1988 relating to the International Convention on Load Lines, 1966, as amended by IMO resolutions up to MSC.375(93) and the notes of the following tables in Regulation 9 of SOLAS Chapter II-2, as amended by IMO resolutions up to MSC.421(98):*

- 1. Table 9.3 and 9.4 for ships carrying not more than 36 passengers;*
- 2. Table 9.5 and 9.6 for cargo ships except tankers; or*
- 3. Table 9.7 and 9.8 for tankers.*

However, the qualified majority did not support the idea to add a footnote based upon the understanding that the text itself of Paragraph 1 is clear and that additional maintenance can be avoided if IMO instruments are not referred to in this UR.

## 6. Attachments if any

None

## UR M76 “Location of fuel tanks in cargo area on oil and chemical tankers”

### Summary:

This UR identifies acceptable locations and arrangements for fuel tanks on oil and chemical tankers.

### Part A. Revision History

Version no.	Approval date	Implementation date when applicable
Rev.1 (June 2018)	12 June 2018	1 July 2019
New (Apr 2016)	12 April 2016	1 July 2017

- **Rev.1 (June 2018)**

#### .1 Origin for Change:

- Suggestion by IACS member

#### .2 Main Reason for Change:

During the discussion at Machinery Panel to plan to amend mandatory IMO instruments such as SOLAS chapter II-2 based on the original UR M76, a need was found out to clarify types of liquid cargoes to which this UR applies to.

#### .3 List of non-IACS Member Classification Societies contributing through the TC Forum and/or participating in IACS Working Group:

None

#### .4 History of Decisions Made:

It is agreed that this UR should be applied not only to low-flashpoint liquid cargoes (liquid cargoes having a flashpoint not exceeding 60°C) but also to toxic liquid cargoes for which toxic vapour detection is specified in column “k” of the table of chapter 17 of the IBC Code. It is also agreed that this UR is not intended to permit fuel tanks to be located adjacent to cargo tanks where prohibited by other regulations such as paragraph 15.12.3.1 of the IBC Code.

#### .5 Other Resolutions Changes

N/A

#### .6 Dates:

Original Proposal: 18 November 2016 Made by: Machinery Panel  
 Panel Approval: 09 May 2018 (Ref: PM16904a)  
 GPG Approval: 12 June 2018 (Ref: 18078\_IGc)

- **New (Apr 2016)**

**.1 Origin for Change:**

- Suggestion by IACS member

**.2 Main Reason for Change:**

Due to Emission Control Areas requirements to use of marine fuels with a sulphur content not exceeding 0,1 % m/m (per MARPOL Annex VI) and minimum viscosity of 2 cSt (per UI SC255 and IMO MSC.1/Circ.1467), typically for marine gas oil MGO, the ultra low sulphur fuel tank capacity on-board standard designs is found inadequate and therefore owners and yards are seeking to expand such capacity by adding fuel tanks within the cargo area.

**.3 List of non-IACS Member Classification Societies contributing through the TC Forum and/or participating in IACS Working Group:**

None

**.4 History of Decisions Made:**

- Form A approved under 12223\_IGa/IAa
- Draft UI submitted to GPG under 12223\_PMb on 21 August 2014
- Draft UI returned to Machinery Panel (12223\_IGd dated 28 October 2014: considered to go beyond an interpretation)
- Panel decision to re-cast into UR
- Draft UR submitted to GPG under 12223\_PMc on 27 April 2015
- Industry hearing initiated (12223\_IAb dated 15 May 2015)
- Industry feedback returned to Machinery Panel (12223\_IGg dated 20 July 2015)

**.5 Other Resolutions Changes**

N/A

**.6 Dates:**

Original Proposal: 5 March 2012 Made by: Machinery Panel  
Panel Approval: 9 March 2016 (Ref: PM12907)  
GPG Approval: 12 April 2016 (Ref: 12223\_IGk)



## Part B. Technical Background

List of Technical Background (TB) documents for UR M76:

Annex 1. **TB for Original Resolution**

See separate TB document in Annex 1.



Annex 2. **TB for Rev.1 (June 2018)**

See separate TB document in Annex 2.



## **Technical Background (TB) document for UR M76 (New Apr 2016)**

### **1. Scope and objectives**

The objective of this task is to identify acceptable locations and arrangements for fuel tanks on oil and chemical tankers and prepare a UR based on SOLAS Ch.II-2 Reg.4.5, also taking into account Reg.12A and 19 of MARPOL Annex I.

### **2. Engineering background for technical basis and rationale**

Fuel tanks on standard tanker designs are located aft or forward of the cargo and slop tank boundaries.

SOLAS Chapter II-2, Regulation 4.5.1.1 specifies that fuel tanks are accepted used for separating machinery spaces from cargo and slop tanks, but is not especially clear as to whether such tanks can also be located within the cargo tank block as defined in the UR.

Fuel tanks within the cargo tank block would be subject to certain regulatory constraints. A fuel tank located within the cargo tank block would have to comply with MARPOL Annex I requirements for double hull and SOLAS requirements for access from open deck. It is also generally prohibited to route fuel oil transfer, sounding and air pipes through cargo tanks and ballast tanks. It is required that pumps serving tanks adjacent to cargo tanks and located within the cargo area (e.g. ballast tanks, pipe tunnels, stool spaces and cofferdams) shall be located within the cargo area. Further, it is prohibited to connect piping systems serving tanks within the cargo area so that they supply to machinery spaces. It is generally accepted to have fuel pumps located in the engine room to serve fuel tanks adjacent to cargo tanks, but this is based on the assumption that the probability of leaks is minimized.

Unless machinery space fuel systems are specially designed for handling low flashpoint fuels, leakages of low flashpoint cargo or chemical cargoes into machinery spaces may result in crew safety risks, explosion hazards and contamination of fuel. The risk of such leakages either through structural failures or piping systems must be limited. Fuel tanks located aft or forward of cargo tanks having only one boundary adjacent to cargo or slop tanks (i.e. vertical transverse bulkhead) are acceptable and have been proven reliable. The location of fuel tanks for example below cargo tanks or in stool tanks may represent an increased risk of contamination based on increased area exposure, constant and elevated static pressure from cargo (and P/V-valves), as well as experiences with cracks or leaks within said cargo tank structures.

It should also be noted that fuel tanks adjacent to cargo tanks are exempted from the requirements for gas detection and thus limiting the ability to detect leakages before transfer to the engine room (ref. IACS UI SC268).

### **3. Source/derivation of the proposed IACS Resolution**

SOLAS Ch. II-2, Reg. 4.2.2.3.2

SOLAS Ch. II-2, Reg. 4.5.1.1

#### **4. Summary of Changes intended for the revised Resolution:**

New Resolution

#### **5. Points of discussions or possible discussions**

The following items were discussed by the Machinery Panel:

There was some discussion about the proper wording for 'open deck in the cargo area' as the terms 'cargo area' and 'cargo tank deck area' are used by other IMO instruments. It was clarified that the intention is to accept independent tanks located on open deck in the cargo area.

The proposal to add a new paragraph reading:

'Notwithstanding the above, fuel oil tanks may be situated in the entire cargo tank length provided that the minimum distances between the cargo tank boundaries and both the ship bottom and side-shell plating (in this case, 'w' should be measured excluding the breadth of the fuel oil tank) comply with the provisions of regulation 19.3 of MARPOL Annex I.' was rejected by the majority on the grounds that (i) it may give the impression that IACS promotes fuel tanks without double hull and/or within the protective area as required by MARPOL Annex I Reg.19.3, and (ii) it does not specify that the fuel tanks shall be segregated from the cargo tanks.

The original draft of a UI for SOLAS Ch.II-2 Reg.4.5 was not supported by GPG as it was felt that the text went beyond an interpretation of SOLAS. Upon further consideration the Panel agreed to re-draft the document as a Unified Requirement.

#### **6. Attachments if any**

N/A

## **Technical Background (TB) document for UR M76 (Rev.1 June 2018)**

### **1. Scope and objectives**

The objective of this task is to clarify the requirements in the previous (original) version adopted in April 2016 by eliminating vague expressions found therein, in particular, regarding permissive fuel tank location, cargoes (oil and chemical) to be covered, duplication with IMO instruments such as "instead of cofferdams".

### **2. Engineering background for technical basis and rationale**

- a) Clarification of the vague expression "at the forward and aft ends" found in provisions specifying permissive fuel tank location so that fuel tanks within the cargo tank block at the forward and aft ends will not be accepted.
- b) Clarification of the intention of the UR by eliminating duplication between the UR and IMO instruments which should not be reproduced in the UR i.e.:
  - the wording "cofferdams" like pump rooms and ballast tanks as isolating spaces between cargo tanks and machinery spaces already covered by SOLAS or the IBC Code; and
  - the sentence mentioning protective area of cargo tanks required by MARPOL Annex I and the IBC Code.
- c) Clarification of "oil tankers" and "chemical tankers" to be covered by this UR i.e.:
  - those carrying liquid cargoes having a flashpoint not exceeding 60°C; and
  - those carrying "toxic" liquid cargoes for which toxic vapour detection is specified in column "k" of the table of chapter 17 of the IBC Code.

### **3. Source/derivation of the proposed IACS Resolution**

None.

### **4. Summary of Changes intended for the revised Resolution:**

Clarification of permissive fuel tank location with elimination of duplication between the UR and IMO instruments (SOLAS, IBC Code, MARPOL Annex I) and clarification of "oil tankers" and "chemical tankers" to be covered by this UR.

### **5. Points of discussions or possible discussions**

None.

### **6. Attachments if any**

None.

## UR M77 “Storage and use of SCR reductants”

### Summary

In Rev.4 of this Resolution, it is clarified the application of UR M77 in a viewpoint of quantity and object.

### Part A. Revision History

Version no.	Approval date	Implementation date when applicable
Rev.4 (Feb 2023)	10 February 2023	1 January 2024
Rev.3 (Sep 2021)	11 September 2021	1 July 2022
Rev.2 (Dec 2020)	11 December 2020	1 January 2022
Rev.1 (Aug 2019)	31 August 2019	1 January 2021
Original version	01 September 2016	1 January 2018

#### • Rev.4 (Feb 2023)

##### 1 Origin of Change:

- Suggestion by IACS member

##### 2 Main Reason for Change:

To consider the meaning of word 'bulk quantities' in UR M77.1 and clarify the application scope of UR M77.

##### 3 List of non-IACS Member classification societies contributing or participating in IACS Working Group:

None

##### 4 History of Decisions Made:

Revision 4 developed by correspondence.

##### 5 Other Resolutions Changes:

None

##### 6 Any hinderance to MASS, including any other new technologies:

None

##### 7 Dates:

Original Proposal : 18 September 2021 (Ref: PM20306dIMa)

Panel Approval : 29 December 2022 (Ref: PM20306dIMg)  
GPG Approval : 10 February 2023 (Ref: 22207\_IGc)

• **Rev.3 (Sep 2021)**

**1 Origin of Change:**

Suggestion by IACS member

**2 Main Reason for Change:**

To provide a waiver for FRP vessels, from the requirement M77.2.9 for urea storage tanks to be of steel or other equivalent material with a melting point above 925 degrees C, when these are built as integral tanks.

**3 List of non-IACS Member classification societies contributing or participating in IACS Working Group:**

None

**4 History of Decisions Made:**

Revision 3 developed by correspondence.

**5 Other Resolutions Changes:**

None

**6 Any hinderance to MASS, including any other new technologies:**

None

**7 Dates:**

Original Proposal : 23 October 2020 (Ref: PM20306\_RIa)  
Panel Approval : 16 August 2021 (Ref: PM20306\_IMi)  
GPG Approval : 11 September 2021 (Ref: 21137\_IGc)

• **Rev.2 (Dec 2020)**

**1 Origin of Change:**

Other (Update to comply with the required format when industry standards are referred to)

**2 Main Reason for Change:**

There was a need to update this UR to comply with the following format when industry standards are referred to:

*[Standard Designation], [version/revision, if applicable], [year of publication]*  
(examples: API Spec 2F, 6th Edition, 1997; ISO 4624, 2002), where  
*[version/revision, if applicable]* and/or *[year of publication]* are decided by IACS  
and are not necessarily to be the current/latest version.

**3 List of non-IACS Member classification societies contributing or participating in IACS Working Group:**

None

**4 History of Decisions Made:**

None

**5 Other Resolutions Changes:**

None

**6 Any hinderance to MASS, including any other new technologies:**

None

**7 Dates:**

Original Proposal: 28 October 2019 (Ref: PM18939\_IMd)  
Panel Approval: 09 November 2020 (Ref: PM20906\_IMf)  
GPG Approval: 11 December 2020 (Ref: 20206\_IGb)

• **Rev.1 (Aug 2019)**

**1 Origin of Change:**

Suggestion by IACS member

**2 Main Reason for Change:**

To provide clarifications of some requirements in paragraphs 2.4, 2.6, 2.8 and 2.10 in order to have a uniform implementation between Members

**3 List of non-IACS Member classification societies contributing through the TC Forum and/or participating in IACS Working Group:**

None

**4 History of Decisions Made:**

Revision 1 developed by correspondence and finally agreed at the 29<sup>th</sup> Machinery Panel Meeting (from 26<sup>th</sup> to 28<sup>th</sup> of March 2019).

**5 Other Resolutions Changes**

None

## **6 Any hinderance to MASS, including any other new technologies:**

None

## **7 Dates:**

Original proposal: Proposal by a Machinery Panel Member (Ref. PM18903\_IMa dated 23/01/2018)  
Panel Approval: 29<sup>th</sup> Panel Meeting (from 26th to 28th of March 2019) and finally by PM18903\_IMn dated 13/06/2019 and PM18903\_IMp dated 26/07/2019.  
GPG Approval: 31/08/2019 (Ref. 19029\_IGf)

## **• New (Sep 2016)**

### **1 Origin for Change:**

Suggestion by IACS member

### **2 Main Reason for Change:**

Per 2.2.5 of the NOx Technical Code, NOx reducing devices such as Selective Catalytic Reduction (SCR) may be used so that marine diesel engines comply with MARPOL Annex VI/ Regulation 13. Although IMO has developed Guidelines with regard to particular requirements related to marine diesel engines fitted with Selective Catalytic Reduction (SCR) systems, it appears that Guidelines on the storage of the reductant have not been developed for selective catalytic reduction (SCR) converter systems.

### **3 List of non-IACS Member Classification Societies contributing through the TC Forum and/or participating in IACS Working Group:**

None

### **4 History of Decisions Made:**

Form A agreed within the 22<sup>nd</sup> Panel meeting.

Form A sent to GPG for record and monitoring purposes on 15 September 2015, under 15152\_PMa.

The Machinery Panel commented on proposed draft UR by correspondence and during the 22nd and 23rd Panel meetings.

Draft UR agreed within the Panel and submitted to GPG under 15152\_PMb on 21 July 2016

### **5 Other Resolutions Changes**

N/A



## **6 Dates:**

Original Proposal: 6 July 2015 made by Machinery Panel Member

Panel Approval: 21 July 2016 (Ref: PM13903)

GPG Approval: 01 September 2016 (Ref: 15152\_IGc)

## **Part B. Technical Background**

List of Technical Background (TB) documents for UR M77:

Annex 1. **TB for New (Sep 2016)**

See separate TB document in Annex 1.

Annex 2. **TB for Rev.1 (Aug 2019)**

See separate TB document in Annex 2.

Annex 3. **TB for Rev.2 (Dec 2020)**

See separate TB document in Annex 3.

Annex 4. **TB for Rev.3 (Sep 2021)**

See separate TB document in Annex 4.

Annex 5. **TB for Rev.4 (Feb 2023)**

See separate TB document in Annex 5.

## **Technical Background (TB) document for UR M77 (New Sep 2016)**

### **1. Scope and objectives**

The objective of this task is to develop requirements for storage and use of reductants (such as Marine NO<sub>x</sub> reduction agent AUS 40 to ISO18611:2014) in selective catalytic converters. The UR would be of assistance to the Shipyards, designers, shipowners and makers of SCR's, who undertake to install such devices in accordance with 2.2.5 of the NO<sub>x</sub> Technical Code recognizing that NO<sub>x</sub> reducing devices, such as Selective Catalytic Reduction (SCR), may be used so that marine diesel engines comply with MARPOL Annex VI/ Regulation 13.

### **2. Engineering background for technical basis and rationale**

The SCR units (one option of NO<sub>x</sub> reducing devices) are installed in the engine exhaust stream and fitted with a reaction chamber containing catalyst blocks together with an upstream dosing device that introduces a reducing agent into the exhaust stream. The reductant mixes within the exhaust gases and a chemical reaction on the surface of the catalyst reduces NO<sub>x</sub> entrained with the exhaust gas to nitrogen and water.

The SCR system can utilize either aqueous or anhydrous ammonia for the reduction reaction. Anhydrous ammonia is nearly 100% pure ammonia and often requires special permits for transportation and storage. The use of aqueous ammonia (28% or less) reduces transport and storage concerns. Modern exhaust emission abatement systems using SCR technologies use an ammonia reductant introduced as a urea/water solution (such as 40%/60%) sprayed into the exhaust stream to ensure mixing with the exhaust prior to the catalyst blocks.

Although IMO has developed Guidelines with regard to particular requirements related to certification of marine diesel engines fitted with Selective Catalytic Reduction (SCR) systems, it appears that IMO Guidelines on the storage of the reductant have not been developed so far (ISO has proceeded during the last years in the issuance of the standard 18611:2014 on Marine NO<sub>x</sub> reduction agent AUS 40 (aqueous urea solution) for selective catalytic reduction (SCR) converter systems).

### **3. Source/derivation of the proposed IACS Resolution**

- a) NO<sub>x</sub> Technical Code 2008 as amended;
- b) Res. MEPC.198(62) & MEPC.217(63);
- c) MEPC 66/INF.4;
- d) CIMAC paper no. 220 Field experience of Marine SCR;
- e) EPA/452/B-02-001 section 4, NO<sub>x</sub> Controls

### **4. Summary of Changes intended for the revised Resolution**

N/A

### **5. Points of discussions or possible discussions**

- The initial proposal to the Panel considered the cases of reductant i) using anhydrous ammonia (99.5% or greater concentration of ammonia by weight); ii) using aqueous ammonia (28% or less concentration of ammonia); and iii) using

urea based ammonia (40%/60% urea/water solution). Considering that pure anhydrous ammonia is extremely toxic and difficult to safely store and that aqueous ammonia needs hydrolysis before use, the Panel unanimously agreed in its 22nd meeting that the UR should be limited to the development of guidelines or requirements for the storage and use of ISO18611:2014 Marine NOx reduction agent AUS 40, while the use of other reductants such as anhydrous ammonia and aqueous ammonia is subject to special consideration.

- With regard to the urea based ammonia (such as 40%/60% urea/water solution), requirements on the location of the urea based ammonia storage tank, its associated piping systems, ventilation arrangements, level and temperature monitoring arrangements and means for the protection of the personnel are addressed in the UR.
- During the discussion within the Panel:
  - A proposal by a member to not limit the application of the UR to AUS 40 only, but to include also AUS 32 (not a marine specific standard) has been in principle agreed, therefore AUS 40 and its relevant ISO standard appear in the text following "e.g." or "such as".
  - A proposal by a member to replace "heated surfaces" in 2.1 by "surfaces whose temperature exceeds 100°C" has not been followed.
  - Paragraph 2.10 on venting, purging and venting of the storage tank has been added at the request of a member (agreed by the Panel).
  - A suggestion made for the deletion of the sentence on Personnel Protective Equipment as falling in operational items covered by the onboard safety management system per the ISM Code was not followed.
  - With regard to a proposal to include specification for a temperature range of -10deg.C to +30deg.C for the storage of urea, it was preferred that reference is made in 2.3 to conditions specified in recognized standards (such as ISO 18611-3).
  - An extensive discussion was conducted on paragraph 2.4 for ventilation of the urea storage tank when installed in a closed compartment or within the engine room: i) For the case of location of the urea storage tank within the engine room the initial proposal reading "the storage tank area and the machinery spaces may be served by a common ventilation system" has been replaced by a paragraph clarifying when a separate ventilation system is not required; ii) For the case of installation of the urea storage tank in a closed compartment, the six (6) air changes suggested by a member have been agreed by the Panel. After exchanging views, it has been agreed to insert in the paragraph requirements on continuous operation of the ventilation system and associated alarms should the ventilation stops, together with warning notices to be posted outside the compartment and adjacent to each point of entry, requiring the use of ventilation.
  - With regard to the "risk based analysis" referred to in sections 3 and 4 for aqueous ammonia and anhydrous ammonia, the initially sentence read "risk based analysis and suitable standards acceptable to the class society". The Panel, based on a member's suggestion, agreed to delete the supplementary text on suitable standards.
- In light of the agreed text, the suggestion to change the title of the UR from "Storage and use of ammonia for SCR units" to "Storage and use of SCR reductants" has been adopted by the Panel.

## 6. Attachments if any

None

## Technical Background (TB) document for UR M77 (Rev.1, Aug 2019)

### 1. Scope and objectives

The objective of this task was to amend the UR M77 (New, Sep. 2016) to clarify paragraphs UR M77.2.4, 77.2.6, 77.2.8 and 77.2.10 in order to have a uniform implementation between Members

### 2. Engineering background for technical basis and rationale

- Paragraph M77.2.4:

An IACS Member proposed to clarify the meaning of wording “..the area is to be served by an effective mechanical supply and exhaust ventilation system..”

In this regard it was observed that the quoted wording requires to install both an effective mechanical supply ventilation system and an effective mechanical exhaust ventilation system but this requirement was evaluated to be too strict compared with other similar requirements such as those for ventilation systems as stated in para. 12.1.4, of the IBC Code.

The qualified majority finally agreed that an effective mechanical ventilation system of extraction type providing not less than 6 air changes per hour was considered to be appropriate for the purpose of this paragraph.

An IACS Member, in order to solve their reservation against the requirement for alarm in case of loss of ventilation for urea storage tanks installed in a closed compartment, proposed to require only warning signs outside the entrances to the room instead of the audiovisual ventilation alarm.

The rationale for this proposal was explained to be in the significant difference between the risk associated with a gas fuel leakage compared to the leakage of urea; ammonia decomposition is mainly temperature dependent and at room temperature urea is stable enough to be stored for long periods. Furthermore, ammonia gas has a very distinct and strong odour, detectable long before the concentration is harmful (detectable at 5-30ppm, lethal at approximately 100 times that level for 10 minute exposure), which means any personnel intending to enter the space will be warned of a leak and failed ventilation system well before the concentration is a health hazard

The proposal was agreed by the qualified majority of Panel Members

An IACS Member proposed to modify the wording “purged” with “ventilated” for the reason that considering that that urea is not flammable it is sufficient to empty and ventilating the tank before entry.

This view was agreed by the qualified majority of Panel Members

- Paragraph M77.2.6:

An IACS Member highlighted a discrepancy between par. 2.5 (which require tanks to be fitted with High and low level alarms together with high and low temperature alarms) and par. 2.6 4th bullet (which require integral tanks to be fitted only with high temperature alarm and low level alarm).

Considering that paragraph 2.5 is applicable to all urea storage tanks and that the 4th bullet of paragraph 2.6 was evaluated to be redundant, the qualified majority decided to delete the 4th bullet of paragraph 2.6.

- Paragraph M77.2.8 renumbered as M77.2.9 in Rev.1:

Under Task PM16912, the Panel decided that a clarification of the term “non-combustible” in UR M77.2.8 was necessary and for this purpose the Panel initially developed the following common understanding:

"Reductant tanks shall be of steel or equivalent with a melting point above 925 degrees C.

Pipes/piping systems should be steel or equivalent material with melting point above 925 degrees C, except downstream of the tank valve, provided this valve is metal seated and arranged as fail-to-closed or with quick closing from a safe position outside the space in the event of fire. In such case, TA plastic piping without fire endurance test is acceptable (0). "

An IACS Member, following a request for clarification from a ship designer, requested the Machinery Panel Members if they shared the understanding that:

- 1) it is not necessary to apply paragraph 2.8 to reductant pump filters for removing extraneous material for the reason that such filters are not directly exposed to flames and therefore paragraph 2.8 is not applicable to such components;
- 2) it is not necessary to apply paragraph 2.8 to the protective coating for corrosion inside surface of piping systems, storage tanks and spill trays for the reason that such protective coating material is not related to the reductant solution leakages caused by being exposed to flame

and proposed the following amendment:

*"2.8 Reductant related piping systems, tanks, and other components which may come into contact with the reductant solution are to be of a suitable grade of non-combustible compatible material established to be suitable for the application, except for coating material and components which are not directly exposed to flames"*

The proposal was not accepted by the qualified majority of Members who finally agreed with the following text reflecting, with some improvements, the common understanding:

"Reductant tanks are to be of steel or other equivalent material with a melting point above 925 degrees C.

Pipes/piping systems are to be of steel or other equivalent material with melting point above 925 degrees C, except downstream of the tank valve, provided this valve is metal seated and arranged as fail-to-closed or with quick closing from a safe position outside the space in the event of fire; in such case, type approved plastic piping may be accepted even if it has not passed a fire endurance test. Reductant tanks and pipes/piping systems are to be made with a material compatible with reductant or coated with appropriate anti-corrosion coating."

- Paragraph M77.2.9 renumbered as M77.2.10 in Rev.1:  
An IACS Member, in order to solve their reservation against the requirement to provide safety showers, proposed to delete the safety showers from the requirement for the reason that even if there are some risks connected to the handling of Urea Solutions, it appear that for short term exposure they are limited to skin and eye irritation in case of direct contact, and only long term exposure may cause other systemic effects; for this reason to require safety showers seems to be not justified.  
The proposal was accepted by the qualified majority.

- Paragraph M77.2.10 renumbered as M77.2.11 in Rev.1:  
An IACS Member, following a request for clarification from a shipyards, requested the Machinery Panel Members if they shared the understanding that a portable purge system to be brought from shore meets the requirements in para 2.10 of UR M77 for the reason that paragraph 2.10 is related to the safety of a person entering the tank for inspection at surveys; in this regard a permanently installed purge system is not considered necessary.  
This view was agreed by the qualified majority of the Machinery Panel Members who finally agreed with the following text:  
"2.10 Urea storage tanks are to be arranged so that they can be emptied of urea and ventilated by means of portable or permanent systems."

### 3. Source/derivation of the proposed IACS Resolution

None

### 4. Summary of Changes intended for the revised Resolution

- Paragraph M77.2.4:
  - 1) The wording "..the area is to be served by an effective mechanical supply and exhaust ventilation system providing.." was amended to read "the area is to be served by an effective mechanical ventilation system of extraction type providing"
  - 2) The second and the third sentence of para 2.4 were amended as follow:  
"The ventilation system is to be capable of being controlled from outside the compartment ~~and is to be maintained in operation continuously except when the storage tank is empty and has been thoroughly air purged. If the ventilation stops, an audible and visual alarm shall be provided outside the compartment adjacent to each point of entry and inside the compartment, together with a warning notice requiring the use of such ventilation. A warning notice requiring the use of such ventilation before entering the compartment shall be provided outside the compartment adjacent to each point of entry.~~"
  - 3) The wording "air purged" was modified to read "ventilated"
- Paragraph M77.2.6:  
the 4th bullet of paragraph 2.6 has been deleted
- New Paragraph M77.2.7:  
The following new requirement has been introduced:  
"The requirements specified in M77.2.4 also apply to closed compartments normally entered by persons:
  - when they are adjacent to the urea integral tanks and there are possible leak points (e.g. manhole, fittings) from these tanks; or
  - when the urea piping systems pass through these compartments, unless the piping system is made of steel or other equivalent material with melting point above 925 degrees C and with fully welded joints."

- Paragraph M77.2.8 renumbered as M77.2.9 in Rev.1:  
The text was amended as follow:  
~~"2.89 Reductant related piping systems, tanks, and other components which may come into contact with the reductant solution are to be of a suitable grade of non-combustible compatible material established to be suitable for the application. Reductant tanks are to be of steel or other equivalent material with a melting point above 925 degrees C.~~  
  
Pipes/piping systems are to be of steel or other equivalent material with melting point above 925 degrees C, except downstream of the tank valve, provided this valve is metal seated and arranged as fail-to-closed or with quick closing from a safe position outside the space in the event of fire; in such case, type approved plastic piping may be accepted even if it has not passed a fire endurance test. Reductant tanks and pipes/piping systems are to be made with a material compatible with reductant or coated with appropriate anti-corrosion coating."
- Paragraph M77.2.9 renumbered as M77.2.10 in Rev.1:  
The wording "and safety showers" has been deleted
- Paragraph M77.2.10 renumbered as M77.2.11 in Rev.1:  
The text was amended as follow:  
~~"2.101 Urea storage tanks are to be arranged so that they can be emptied of urea, purged and vented and ventilated by means of portable or permanent systems."~~

## 5. Points of discussions or possible discussions

Text was agreed by correspondence and at the 29<sup>th</sup> Machinery Panel Meeting.

- A Member Society requested the Panel Members opinion whether the ventilation requirements specified in UR M77.2.4 applies also to the enclosed compartments adjacent to the urea tank and normally entered by persons which are designed and constructed as integral part of the hull in the case the urea piping systems pass through these compartments; in this regard it was proposed to add the following new paragraph M77.2.7 in order to include all cases where the ventilation requirements in para. 2.4 are to be applied (i.e. compartments adjacent to integral tanks and also all compartments passed through by urea piping):

"The requirements specified in M77.2.4 also apply to closed compartments normally entered by persons:

- when they are adjacent to the urea integral tanks and there are possible leak points (e.g. manhole, fittings) from these tanks; or
- when the urea piping systems pass through these compartments, unless the piping system is made of steel or other equivalent material with melting point above 925 degrees C and with fully welded joints"

The proposal was agreed by the qualified majority.

To clarify the matter some Members Societies proposed to add a new bullet in paragraphs M77.2.6 with the following text proposals which however were not supported by the qualified majority:

Proposal n.1:

A Members Society observed that integral tanks may have possible leak points such as bolted hatch and measuring points required in M77.2.5 whether or not the



urea piping systems pass through these compartments and proposed the following modification:

~~"The requirements specified in M77.2.4 also apply to closed compartments adjacent to these tanks and normally entered by persons, when the urea piping systems pass through these compartments, unless the piping system is made of steel or other equivalent material with melting point above 925 degrees C and with fully welded joints."~~

Proposal n.2:

A Members Society commented that the requirements in M77.2.4 should also apply to all compartments passed through by urea piping, regardless of whether or not they are adjacent to the tank (except when this piping is made of steel or other equivalent material with melting point above 925 degrees C and with fully welded joints) and propose the following modification:

~~"The requirements specified in M77.2.4 also apply to closed compartments adjacent to these tanks containing urea piping and normally entered by persons, when the urea piping systems pass through these compartments, unless the piping system is made of steel or other equivalent material with melting point above 925 degrees C and with fully welded joints."~~

Proposal n.3:

A Members Society commented that the agreed text for the new bullet is stringent in a point of view requiring the ventilation regardless of existence of possible leak points and propose the following modification:

"The requirements specified in M77.2.4 also apply to closed compartments adjacent to these tanks and normally entered by persons, when the directly attached fittings or openings/accesses on the tank are located or the urea piping systems pass through these compartments, unless the piping system is made of steel or other equivalent material with melting point above 925 degrees C and with fully welded joints."

- One Members Society proposed to add the following sentence to paragraph 2.9 of the draft UR M77 (Rev.1, June 2019):  
"...tank material other than steel is subject to special consideration (see MSC.1/Circ.1527 and UI SC282 for consideration)."

In this regard it was observed that the reference to MSC.1/Circ.1527 and UI SC282 may not be appropriate since both the documents provides interpretation for terms like "other approved material" or "other equivalent material" or "steel or equivalent" for specific SOLAS regulation (Reg.II-2/4.2.2.5,9.7.7.1) and circular (MSC.1/Circ.1321).

The following alternative texts for the first sentence of paragraph 2.9 were proposed to Members for their consideration:

Alternative 1:

"Reductant tanks are to be of steel or other equivalent material with a melting point above 925 degrees C; materials other than steel for reductant tanks are subject to special consideration by the Classification Society."

Alternative 2:

"Reductant tanks are to be of steel or other equivalent material; evaluation of equivalency of materials other than steel for reductant tanks is to be based on the proposed materials having passed a standard fire test for "A" class divisions."

The proposed alternatives were however not supported by the qualified majority.

**6. Attachments if any**

None

## Technical Background (TB) document for UR M77 (Rev.2 Dec 2020)

### 1. Scope and objectives

UR M77(Rev.1) does not reflect the agreed format for referencing the ISO standards. Rev.2 has been developed to comply with the agreed format.

### 2. Engineering background for technical basis and rationale

#### Format for references to Industry standards

*[Standard Designation], [version/revision, if applicable], [year of publication]*  
 (examples: API Spec 2F, 6th Edition, 1997; ISO 4624, 2002), where  
*[version/revision, if applicable] and/or [year of publication] are decided by IACS and are not necessarily to be the current/latest version.*

### 3. Source/derivation of the proposed IACS Resolution

None

### 4. Summary of Changes intended for the revised Resolution:

UR M77 has been updated to specify the revision/version of the ISO standards as follows:

ISO standards	Replaced by
ISO 18611-1	ISO 18611-1:2014
ISO 18611-3	ISO 18611-3:2014

### 5. Points of discussions or possible discussions

The changes are purely editorial with no impact on the Resolution since the UR M77 (New, Sep 2016) is assumed to be in line with the latest publications ISO 18611-1:2014 and ISO 18611-3:2014.

### 6. Attachments if any

None

## **Technical Background (TB) document for UR M77 (Rev.3 Sep 2021)**

### **1. Scope and objectives**

This revision is to provide a waiver for FRP vessels, from the requirement M77.2.9 for urea storage tanks to be of steel or other equivalent material with a melting point above 925 degrees C, when these are built as integral tanks

### **2. Engineering background for technical basis and rationale**

Yachts/Vessels less than 500GT often are made of FRP, while those above 500GT are typically made of steel. It is thought that UR M77.2.9 requirement for reductant tanks bans the installation of structural tanks made of FRP and forces to embed a steel tank in the FRP structure, which makes it impracticable for Yacht/Vessel Builders to accommodate and materialize.

It's believed that integral tanks made of FRP can be accepted on Yachts which themselves are made of FRP structure.

It is highlighted that the exemption provided for pleasure yacht/vessel by the paragraph 5.2.3 of MARPOL Annex VI Reg.13 is valid up to 1 January 2021, and there have been cases to install SCR. Timely development of exemption clause is necessary.

*5.2 The standards set forth in paragraph 5.1.1 of this regulation shall not apply to:  
"3. a marine diesel engine installed on a ship constructed prior to 1 January 2021 of less than 500 gross tonnage, with a length (L), as defined in regulation 1.19 of Annex I to the present Convention, of 24 metres or over when it has been specifically designed, and is used solely, for recreational purposes."*

### **3. Source/derivation of the proposed IACS Resolution**

According to paragraph 2.9 of UR M77, reductant tanks are to be of steel or other material with a melting point above 925 degrees C.

"2.9 Reductant tanks are to be of steel or other equivalent material with a melting point above 925 degrees C."

### **4. Summary of Changes intended for the revised Resolution:**

In consideration of 2. Engineering background and rationale, it is suggested to put a Footnote to UR M77.2.9, providing an exemption for FRP vessels. The initial clause agreed by qualified majority is as follows:

"Footnote to 2.9: Material requirement to be of steel or other equivalent material with a melting point above 925 degrees C is not applicable for integral tanks on FRP vessels less than 500 GT, provided that the integral tanks are coated and/or insulated with a self-extinguishing material."

## **5. Points of discussions or possible discussions**

The idea to develop an exemption clause for reductant tank made of FRP structure on FRP Yacht less than 500GT was agreed by qualified majority of the Machinery Panel members.

Concerning the idea of gross tonnage, one member suggests changing criterion from 500 GT to 400 GT, taking into account Regulation 5.1 of MARPOL Annex VI, which was not supported.

Among proposed Footnotes, the clause in above 4. Summary of change was finally proposed following the qualified majority, on the term "vessel" over "yacht" and on the need to specify a requirement for a self-extinguishing coating and/or insulation for integral tanks made of FRP.

A proposal to add an additional clause to exempt FRP vessels larger than 500GT on the basis of case by case acceptance which didn't achieve qualified majority support at the 2<sup>nd</sup> round of discussion was once more raised during 33<sup>rd</sup> Machinery Panel Meeting, and after deliberation it is decided to develop an alternative text in lieu of explicit expression of "case by case acceptance", without compromising the required clarity of IACS Procedures Volume 1, with a view to the universal implementation among all members in a uniform manner.

The footnote devised for the purpose is as follows:

\* Footnote to 2.9: Material requirement "to be of steel or other equivalent material" in the first paragraph with a melting point above 925 degrees C is not applicable for integral tanks on FRP vessels such as those listed below, provided that the integral tanks are coated and/or insulated with a self-extinguishing material.

- 1) FRP vessels complying with Regulation 17 of SOLAS Chapter II-2 based upon its associated IMO guidelines (MSC.1/Circ.1574), and
- 2) FRP vessels exempted from the application of SOLAS e.g., yachts, fast patrol, navy vessels, etc., generally of less than 500 gross tonnage, subject to yacht codes or flag regulations.

## **6. Attachments if any**

None

## **Technical Background (TB) document for UR M77 (Rev.4 Feb 2023)**

### **1. Scope and objectives**

This revision is to clarify application scope of UR M77, especially means of word stating 'bulk quantities' in UR M77.1.

### **2. Engineering background for technical basis and rationale**

UR M77 has been published in September 2016. And the UR M77.1 informs that the UR applies to arrangements for the storage and use of SCR reductants, especially, where the SCR reductants are typically carried on board in bulk quantities.

It is needed to provide a specific criterion or meaning of the word 'bulk quantities' referred in UR M77.1 for the application of UR M77.

Furthermore, it also should take a consideration whether UR M77 is applied on small tanks such as daily tank and buffer tank which is not storage tank.

### **3. Source/derivation of the proposed IACS Resolution**

None

### **4. Summary of Changes intended for the revised Resolution:**

The last phrase of UR M77.1 'which are typically carried on board in bulk quantities' is deleted since the phrase is not to mean specific quantities but to have expressional meaning which loading, unloading and storage of SCR reductant can be freely placed on board regardless of quantity of SCR reductants.

### **5. Points of discussions or possible discussions**

Regarding the small tanks such as daily tank and buffer tank, two kinds of volume 300 L and 500 L are proposed to leave to the discretion of individual Classification Societies. The former(300 L) is based on individual studies based on the following understanding from a member society.

The requirements are mostly aimed at chemicals that are not used directly in cleaning the exhaust or controlling the pH of process water in operation. A 300 L threshold should cover all necessary designs where small amounts of chemical are used as secondary process chemicals

And the latter(500L) has been proposed by reference to the SOLAS conventions for oil tanks capacity such as SOLAS II-2/Reg.4.2.2.3.4 and Reg.4.2.3.2.

The members determine the 500 L as a threshold after considering the background of both proposals.

### **6. Attachments if any**

None

## UR M78 "Reciprocating Internal Combustion Engines fuelled by Natural Gas".

### Summary

In Rev. 2 of this UR M78 Rev1 on "Safety of Internal Combustion Engine Supplied with Low Pressure Gas", the scope of application of the UR M78 has been made to cover all types of engines (High pressure and low pressure, two stroke and four stroke, gas injection and pre-mixed gas type engine); the UR M59 (1996) has been withdrawn as evaluated to be no more suitable for ships to which the 2016 IGC Code applies and the existing requirements of the withdrawn UR M59 will be revised with the view to be incorporated in the Revision 2 of UR M78.

### Part A. Revision History

Version no.	Approval date	Implementation date when applicable
Rev.2 (Jan 2024)	17 January 2024	1 January 2025
Rev.1 (Feb 2021)	12 February 2021	1 July 2022
New (July 2018)	17 July 2018	1 July 2019

#### • Rev.2 (January 2024)

##### 1 Origin of Change:

- Suggestion by IACS member  
 Based on IMO Regulation (*IGF & IGC Code*)

##### 2 Main Reason for Change:

UR M78 has been developed for Safety of Internal Combustion Engine Supplied with Low Pressure Gas. IACS Machinery Panel has the view that applicable requirements should be approached by engine type, rather than gas supplying pressure to cover trunk piston type and crosshead type, premixed type, port injection and gas direct injection, of course taking gas supply pressure under consideration.

##### 3 List of non-IACS Member classification societies contributing or participating in IACS Working Group:

None.

#### 4 History of Decisions Made:

AS A FOLLOW-UP ACTION OF TASK PM6902(Safety of Internal Combustion Engines Supplied with Low Pressure Gas), THE MACHINERY PANEL DECIDED TO DEAL WITH THE FOLLOWING ACTIVITIES BUT NOT LIMITED TO:

- To start the development of a Revision (Rev.1) of the UR M78 on "Safety of Internal Combustion Engine Supplied with Low Pressure Gas" to extend the scope of application of the UR M78 to cover all types of engines (High pressure and low pressure, two stroke and four stroke, gas injection and pre-mixed gas type engines).
- To withdraw the UR M59 (1996) as evaluated to be no more suitable for ships to which the 2016 IGC Code applies and to review the existing requirements of the UR M59 with the view to be incorporated in the Revision 1 of UR M78.
- Propose a modification of the structure for the revised UR (for example: part with requirements applicable to all engines + part with specific requirements applicable to 2-stroke engines + part with specific requirements applicable to 4-stroke engines).
- To deal with, and possibly solve the issue raised by CIMAC regarding IGF Section 10.3.1.2 (i.e., CIMAC recommend that the term "piston in direct communication with the crankcase" is explained more detailed so that it will not lead to misinterpretations – Reference is made to PM18914\_IMa dated 17/04/2018) and ensure that any work conducted by IACS is correctly focused on the issue raised.
- To consider, in the revision process, some additional comments received when the draft UR M 78(April 2018) was already agreed by the qualified majority.
- Both IGC and IGF Codes require that suitable pressure relief systems are fitted on engine components and systems (e.g. air inlet manifolds, scavenge spaces) that contain or are likely to contain ignitable gas and air mixture, unless these are designed to withstand the worst-case overpressure due to ignited gas leaks. For the protection of crankcases suitable IACS requirements are in place with URs M66 and M9, while for pressure relief systems on air inlet manifolds, scavenge spaces and exhaust gas manifolds UR M82 has been published.
- Consider the outcome of task PM18909 (addressing the issue of gas presence in the crankcase of 4-stroke low pressure dual fuel or gas engines and crankcase ventilation) for possible introduction of the relevant text in the revised UR M78, including acceptance criteria for M78.1.4.4.i).
- Consider the outcome of PM18914a regarding approval procedure for explosion relief devices for air inlet and exhaust manifolds.
- Current M78 refers to IGF and IGC Code in several paragraphs. The references to the Codes should be reviewed with regard to their applicability (especially M78.2.2.1.1 regarding general pipe design, materials, joining details, etc.).
- Define scope of testing and certification of engine components (in addition to M72).



**5 Other Resolutions Changes:**

None.

**6 Any hinderance to MASS, including any other new technologies:**

None.

**7 Dates:**

Original Proposal:	20 June 2019	(Ref: PM18914_IMg)
Panel Approval:	15 December 2023	(Ref: 18914_IMzg)
GPG Approval:	17 January 2024	(Ref: 23233_IGc)

• **Rev.1 (Feb 2021)**

No records are available.

• **New (July 2018)**

No records are available.

\*\*\*\*\*

## **Part B. Technical Background**

List of Technical Background (TB) documents for UR M78:

Annex 1. **TB for New (July 2018)**

See separate TB document in Annex 1.

Annex 2. **TB for Rev.1 (Feb 2021)**

See separate TB document in Annex 2.

Annex 3. **TB for Rev.2 (Jan 2024)**

See separate TB document in Annex 3.

## **Technical Background (TB) document for UR M78 (New July 2018)**

### **1. Scope and objectives**

The existing UR M59 (Control and Safety Systems for Dual Fuel Diesel Engines) was issued in 1996 at a time when marine dual fuel engines were mainly of the 4-stroke type, operated according to the Diesel cycle and supplied with gas at high pressure (300 - 350 bar) and intended for offshore applications.

Since then, 4-stroke dual fuel engines supplied with low pressure gas (typically 5 – 6 bar) have been placed on the marine market and extensively used on LNG carriers and on various types of gas-fuelled ships. It was therefore proposed to develop a new UR to cover such engines.

While dual fuel engines supplied with high pressure gas are operated according to the standard Diesel cycle, DF and gas fuel only engines supplied with low pressure gas are operated according to the Otto cycle, which involves a compression of a gas/air mixture and need therefore to be covered by specific requirements.

The objective was to develop a document covering all types of diesel engines supplied with low pressure gaseous methane: dual fuel engines, gas fuel only engines and premixed engines (where gas is mixed with air before the turbo-charger). It should be noted that this UR does not reproduce any part of the IGC Code, IGF code or other IACS URs but only makes reference to the relevant parts thereof.

As agreed in the Machinery Panel, the UR addresses the engine itself, excluding arrangement and installation on board.

The final benefit of this new IACS UR is to provide a common approach for design and testing of the concerned engines, thus enabling a uniform application for all designers and manufacturers.

### **2. Engineering background for technical basis and rationale**

#### **2.1 Risk analysis**

The UR requires a risk analysis to be conducted and gives provisions regarding the scope of the analysis and the different systems and equipment that need to be analysed.

#### **2.2 General principles for the safety of the engines**

Gas engines are to be capable of operating with the different qualities of gas that can be encountered.

Where there is a risk of explosion in certain systems or components of the engine, they are to be of reinforced design to withstand the explosion or fitted with explosion relief devices.

#### **2.3 Gas piping**

The gas piping on the engine is to be designed in accordance with the relevant provisions of the IGC Code and IGF Code, as applicable.

#### 2.4 "Double wall" versus "alternative" gas piping arrangement

The gas piping system on the engine is to be designed according to the "double wall" arrangement or, where permitted by the IGF Code, to the "alternative" single wall arrangement, when the engine is installed in an ESD-protected machinery space.

#### 2.5 Engine crankcase

The IGF Code does not require gas alarm or hot spot detection but a detailed evaluation regarding the hazard potential of fuel gas accumulation in the crankcase (see IGF reg. 10.3.1.2). This requirement has been considered as sufficient and introduced in paragraph 1.4 of the UR (Risk analysis).

The principle of a gas detection in the crankcase with an alarm before 100% LFL required by the IGC Code (reg. 16.7.3.3 and 13.6.17) has not been retained.

#### 2.6 Gas ignition in the cylinder

For the gas ignition in the cylinder, reference is made to the relevant provisions of the IGC Code and IGF Code.

#### 2.7 Control, monitoring, alarm, and safety systems

Alarms and safeties are to be provided in accordance with the Table except if the risk analysis proves otherwise.

#### 2.8 Specific design requirements

Paragraph 3 of the UR provides specific requirements for DF engines, for GF engines and for pre-mixed engines. They are basically consistent with the requirements laid down in the IGC and IGF Codes.

#### 2.9 Type testing

Specific requirements for gas engines have been introduced, such as verifying the permissible operating range for gas mode, the switch-over procedures between gas fuel and oil fuel modes (for DF engines).

For electrical prime movers, specific requirements have been introduced as the transient behaviour of gas engines in case of sudden load variations may differ from that of their counterpart supplied with FO.

Regarding the influence of the methane number or LHV of the fuel gas, it is not required to be verified during the Stage B type tests. It shall however be justified by the engine designer through internal tests or calculations and documented in the type approval test report.

### **2a. Specification of the data utilised in the development/revision of the proposed IACS Resolution, if any**

None

### **3. Source/derivation of the proposed IACS Resolution**

T The UR is consistent with:

- IGF Code
- Revised IGC Code

- Engine manufacturers' practices (through CIMAC).

#### **4. Summary of Changes intended for the revised Resolution:**

None

#### **5. Points of discussions or possible discussions**

The main points of discussions are detailed below.

##### 5.1 General comments

The following comments have been made by the PT Members:

- Member 1: We would suggest that the whole UR is checked for overlap with existing UR's. At one point we were trying to make this a standalone document but now seem to be just limiting to engine and just limiting to DF and GF requirements.

On that latter understanding all duplicated requirements could be deleted and just keep DF and GF specific requirements. Care needs to be exercised in trying to incorporate requirements from other IACS UR's that are still under development and may not be adopted in current form in the end.

- Member 2: Support XX above and would like to see that other URs related to engines are updated to also cover gas engines as found necessary.

After extensive discussions, it was decided not to reproduce any text from other Rules or Regulations (see 1. above). Accordingly, this new UR contains:

- Requirements specific to gas engines (e.g. risk analysis, safety of crankcase, etc.)
- Requirements which are relevant to subjects addressed by other IACS URs. Such requirements are in agreement with the concerned URs: UR M35 and UR M36 for alarms and safeties, UR M51 for factory acceptance test and shipboard trials of engines, UR M71 for type testing of engines, etc.

Requirements for the gas piping system were initially introduced, derived from IGC Code 5.11.2.2 (similar to IGF Code 7.3.2.1). They have finally been replaced by a reference to the IGC / IGF Codes. See 5.5 below.

##### 5.2 Design of crankshaft

The UR states that the design of crankshafts is to comply with UR M53.

The following reservations have been made by the PT members:

- PT Member 1: In the case of a dual fuel engine utilizing existing diesel engine design this may not be a problem but for dedicated gas engine design may be over conservative. UR M53 contains a lot of outdated empirical data based on old diesel engine testing. UR M53 needs updating.

- PT Member 2: UR M53 is just updated. If an engine designer finds the UR M53 calculation method to be over conservative, he might demonstrate sufficient strength by one of the appendixes developed.

- PT Member 3: It is suggested to discuss this issue with CIMAC.

After UR M53 updating (Subject No.: PM11100) and as no comments have been made by CIMAC on this issue, it has been decided to keep the initial text.

### 5.3 Low load operation

During the discussions within the PT, a clause had been proposed, requiring the ability of the engine to operate at low loads on gas to be demonstrated during the type tests.

- PT Member 1: has proposed to delete this clause, arguing as follows:

What is meant by 'low loads'? The type test required operating points should define what operational running is to be demonstrated. GF engines are likely better at low load than DF engines. The whole issue of low load running is a big one. DF and gas engines are promoted as meeting Tier III NOx limits but operation of all of the DF engines below 10-15% load is limited. If they can't run in gas mode all of the time (Which with the exception of GF engines they won't) then operational and statutory issues arise.

- PT Member 2: has proposed to state that the lowest declared power shall be demonstrated during the type test, which has been finally introduced in the UR.

It has finally been decided not to introduce any requirement for minimum load testing as this is covered by UR M71.7.2, which is referred to in paragraph 4.1.6 of the UR (Stage A – internal tests).

### 5.4 Gas piping

The following clause was initially proposed:

In accordance with UR P2.2, gas piping is to be designed and constructed to:

- Class II requirements when it is of the double walled arrangement.
- Class I requirements otherwise

The following comments have been made by the PT members:

- PT Member 1: UR P2.2 is for general piping systems and does not apply to gas process piping where IGC Code would typically be applicable. Propose to delete or clarify this. What is exactly meant in terms of design approval, test and certification by this? We do not see that there should be a difference in Class approval of the gas pipes between single or double wall arrangements.
- PT Member 2: Propose to extend the scope of UR P2 to cover gas fuel piping systems. Whereas P2 does not explicitly covers gas fuel piping

systems, "Flammable media with flash point below 60°C" and "liquefied gas" are covered by Table 1, which imposes Class I for the piping if arranged "without special safeguards", (according to Note 1 in the Table, the safeguard is intended "for reducing leakage possibility and limiting its consequences, e.g. pipes led in position where leakage of internal fluid will not cause a potential hazard or damage to surrounding areas, which may include the use of pipe ducts, shielding, screening, etc."). Class II is acceptable when the piping system is arranged "with special safeguards". There are specific requirements for Class I piping, concerning in particular:

- the non-destructive testing of welds and acceptance criteria,
  - the connection of pipes.
- PT Member 3: Propose to delete reference to UR P2.2 as this does not apply for gas, as fuel, piping.

The final text does not refer to UR P2.2. The extension of UR P2.2 to gas piping systems may however still be considered.

#### 5.5 Use of "single wall" piping arrangement on the engine

The following clause was initially proposed:

Single wall gas piping may be accepted only for the following engines:

- engines of "pre-mixed" type (see 1.1.1)
- engines having a power per cylinder not exceeding 100 kW and supplied with gas at a pressure not exceeding 10 bar

The use of the single wall gas piping arrangement on the engine is subject to the requirements for ESD spaces in the Interim Guidelines or to the following alternative requirements:

- 1) A hood is to be provided in way of the engine, served by independent exhaust ventilation with high capacity, and fitted with means for gas detection.
- 2) The ignition hazards are to be assessed against the criteria set out in IEC standard 60079-10-1:2008 (or EN 60079-10-1:2009) and, where necessary, reduced in accordance with the guidance on design and control parameters given in the standard.

The following comments have been made by the PT members:

- PT Member 1: Propose to delete power limitation. This has been discussed in IGF Code but no agreement reached. Also propose to modify the above text as follows:

The use of the single wall gas piping arrangement on the engine, or an alternative arrangement considered equivalent, is subject to the specific requirements of the individual Society.

- PT Member 2: As the “double wall” piping arrangement is feasible and available for “large” engines, it should be made compulsory for such engines, as it prevents gas leakage from the engine and therefore increases the safety level of the installation. It is suggested to accept the “single wall” only for “small” engines and with sufficient safeguards, as proposed in the above text.
- PT Member 3: Propose to specify requirements to single walled and double walled piping separately without discussing ESD, hood or max cylinder output. This can be left to the IGF code and Societies Rules to state.

It has then been proposed to remove the reference to hood, ventilation, gas detection, assessment of the ignition hazard, and power limitation, being understood that each Society will have its own interpretations, which should anyhow comply with the relevant provisions of the IGC Code or IGF Code (as applicable).

The final text adopted by the Machinery panel just mentions that single wall arrangement is acceptable only for engines installed in ESD-protected machinery spaces of ships covered by the IGF Code.

## 5.6 Engine crankcase

The text initially proposed reads as follows:

An alarm is to be activated before the gas concentration in the crankcase reaches 100% LFL, with immediate shutdown of the engine and of the gas supply.

The following comments have been made by the PT members:

- PT Member 1: Suggest removing “with immediate shutdown of the engine and of the gas supply” as it may be taken to mean “automatic” shutdown of engine and gas supply.
- PT Member 2: We note this is the current text from the IGC Code being rewritten, however this is not to be an automatic shutdown. The usefulness of gas detection that is not automatic and set to alarm at 100% LFL is questionable. The CIMAC gas engine groups are going to look at the issue of crankcase gas concentration. Propose to delete this requirement from the UR since specific application to gas carriers can be applied by compliance with IGC Code if required. If it is to be retained then it should be clarified that gas detection in the crankcase vent pipe is acceptable since this is the only practical way of undertaking the measurement.
- PT Member 3: Propose to delete the requirement.

It has finally been decided to require, in accordance with IGF Code 10.3.1.2, an assessment of the hazard potential for crankcase fuel gas accumulation, for engines where the space below the piston is in direct communication with the crankcase. See 1.4.4 i) of the UR.



## 5.7 Gas specification for tests

The text initially proposed requires the type testing program to cover: Various gas specifications as applicable to those specifications the approval is expected to consider.

Note: The permitted range of gas characteristics (methane number, LHV) may be simulated by introducing a certain amount of LPG or Nitrogen.

The following comments have been made by the PT members:

PT Member 1: We still think this is difficult to apply and verify. This would require gas analysis. The issue of testing gas and DF engines by IMO BLG with respect to NOx certification may help. As this is listed as "guidance" this will not be interpreted or applied consistently. The use of 'normally' as well creates opportunity for inconsistency. We would prefer to see agreed requirements.

PT Member 2: Propose to maintain the requirement to test the engine with different gas fuel specifications (compositions) corresponding to those permitted by the engine manufacturer.

PT Member 3: Agree that this is difficult to apply and verify. However, the ability to use different gases from different sources may become an important issue. If a specific gas shall be required, it should be sufficient to require a gas with the lowest declared methane Number to be used.

The following text has finally been proposed:

The influence of the methane number and LHV of the fuel gas is not required to be verified during the Stage B type tests. It should however be justified by the engine designer through internal tests or calculations and documented in the type approval test report.

## 5.8 Specific tests for engines intended for high-speed vessels for tests

The text initially proposed requires the type testing program to cover: Propulsion engines for high-speed vessels that may be used for frequent load changes from idle to full speed/power are to be tested with at least 500 cycles (idle – full load – idle) using the steepest load ramp that the control system (or operation manual if not automatically controlled) permits. The duration at each end shall be sufficient for reaching stable temperatures of the hot parts.

The following comments have been made by the PT members:

- PT member 1: How do we know if an engine will be used for high speed vessel applications? In a way this is acknowledging that the type test is not rigorous enough to cover certain applications. This perhaps could be better dealt with as main body requirements such as 'testing for engines driving propellers', 'testing for engines driving generators', 'testing for engines for high-speed vessels' where an applicant must demonstrate why the testing doesn't apply to his engine approval and type approval certificates could state 'not suitable for high-speed vessels'.

- PT member 2: Again, this should follow the UR for diesel covering the same.

Again, and argument to not specify general test requirements that are applicable for both diesel and gas engines in this UR.

It has been finally decided not to introduce the text in question. It should be noted that this text is included in UR M71.5.6.

#### 5.9 Generating sets – load steps.

The initial text reads as follows:

Capability to take sudden load and loss of load in accordance with the provisions of UR M3.2.3

Where the electrical power system is fitted with a power management system the application of multiple load steps is permitted provided the total load is applied within 45 seconds. The maximum load steps are to be declared and demonstrated. For DF engines switchover to oil fuel during the test is acceptable.

The following comments have been made by the PT members:

- PT Member 1: UR M3.2.3 does not fully deal with this. Would agree that Fig 1 is very out of date (30 bar bmep engines have been around for 20 years). Would also agree that many load steps to full load are possible where matched to PMS system.

DF engines revert to oil mode if they can't handle the transient and therefore acceptance is on basis of oil engine compliance. This does not clarify the situation for pure gas engines, which can have better transient response than DF engines in gas mode. The CIMAC paper on transient response provides more detail on this.

Gas engines are usually accepted in accordance with ISO 8528 which includes a number of engine load acceptance grades. However much of this is dependent on agreement between supplier and purchaser. Have proposed text to allow multiple load steps in accordance with PMS and within a time frame. This needs further discussion. Load shedding can also be a big problem for pre-mixed engines.

- PT Member 2: Again, this is basically not a gas-specific issue. Also, diesel engines may have problems with 2 or 3 load steps, and in these cases the third part of M3.2.3 will allow if it is matched to PMS system. Propose to only refer to M3.2.3.

45 seconds as proposed above comes from requirements for emergency gensets and should not be mentioned here.

Taking into account the above comments, the text has been finalized as follows and agreed by the Machinery Panel:

Capability to take sudden load and loss of load in accordance with the provisions of UR M3.2.3

For GF and premixed engines, the influences of LHV, methane number and ambient conditions on the dynamic load response test results are to be theoretically determined and specified in the test report. Referring to the limitations as specified in 2.1.2, the margin for satisfying dynamic load response is to be determined.

Note:

1. For DF engines, switchover to oil fuel during the test is acceptable.
2. Application of electrical load in more than 2 load steps can be permitted in the conditions stated in UR M3.2.3.

#### 5.10 Gas Admission Valves

In order to address some Industry issues regarding the hazardous area classification for gas admission valves, the Panel decided to introduce the new Section 2.2.8 on "Gas Admission Valves", the initial text was as follow:

Gas admission valves shall be certified safe. However, if they are not certified for the zone they are intended for, it shall be documented that they are suitable for the applicable zone. Documentation and analysis is to be based on IEC 60079-10-1 and/or IEC 60092-502.

One Panel Member proposed to further modify the above text in order to:

- specify better which "zone" is to be applicable for the certification of the inside and the outside part of the valve; and
- specify that certification is not required for the outside of the valve in the case the valve is arranged without enclosure in accordance with the "ESD-protected machinery space" concept provided that the valve is de-energised upon gas detection in the space

After some rounds of discussion, the above proposal was finalized as follows and agreed by the Machinery Panel:

Gas admission valves shall be certified safe as follows:

- 1) The inside of the valve contains gas and shall therefore be certified for Zone 0.
- 2) When the valve is located within a pipe or duct in accordance with 2.2.2.1, the outside of the valve shall be certified for Zone 1.
- 3) When the valve is arranged without enclosure in accordance with the "ESD-protected machinery space" (see 2.2.2.2) concept, no certification is required for

the outside of the valve, provided that the valve is de-energized upon gas detection in the space.

However, if they are not rated for the zone they are intended for, it shall be documented that they are suitable for that zone. Documentation and analysis is to be based on IEC 60079-10-1 or IEC 60092-502.

**6. Attachments if any**

None

## **Technical Background (TB) document for UR M78 Rev.1 (Feb 2021)**

### **1. Scope and objectives**

The purpose of Revision 1 of this UR is to remove inconsistency between Paragraphs 4.1.4 & 4.2.1 (TA & FAT) and 4.3 (Shipboard Trials) and to specify references to IMO instruments in a consistent manner.

### **2. Engineering background for technical basis and rationale**

A) Removal of inconsistency between Paragraphs 4.1.4 & 4.2.1 (TA & FAT) and Paragraph 4.3 (Shipboard Trials)

In this Revision, inconsistency on the exemption of 110% load tests on the gas mode of dual fuel engines, which was not allowed during Shipboard Trials (Paragraph 4.3) but during TA & FAT (Paragraphs 4.1.4 & 4.2.1) was removed.

B) Format for references to Industry standards

Format:

[Standard Designation], [version/revision, if applicable], [year of publication] (Examples: API Spec 2F, 6th Edition, 1997; ISO 4624, 2002), where [version/revision, if applicable] and/or [year of publication] are decided by IACS and are not necessarily to be the current/latest version.

C) Format for references to IMO instruments (where the number of amendments is small)

Format:

regulation/paragraph x.x.x of SOLAS/MARPOL/the XXX Code, as amended by resolutions MSC/MEPC.xx(xx), (...) and MSC/MEPC.xx(xx)

### **2a. Specification of the data utilised in the development/revision of the proposed IACS Resolution, if any**

None

### **3. Source/derivation of the proposed IACS Resolution**

None

### **4. Summary of Changes intended for the revised Resolution:**

A) The exemption of 110% load tests

The exemption clauses related to 110% load testing on the gas mode of dual fuel engines which were specified in Paragraphs 4.1.4 and 4.2.1 have been moved to Paragraph 3.1.1 with required rewording.

B) Format for references to Industry standards

Paragraph 2.2.8 has been updated to specify the revision/version of the IEC standards.

as follows:

IEC Standards	Replaced by
IEC 60079-10-1	IEC 60079-10-1: 2015
IEC 60092-502	IEC 60092-502:1999

#### C) Format for references to IMO instruments

Paragraphs 1.2.11 and 1.2.13 which define the IGC Code and the IGF Code have been modified while the reference to the IGF Code could not be in line with the standard format as per the above 2.B), due to the fact that Resolution MSC.422(98) is the sole amendment to the IGF Code which had entered into force before approval of Rev.1 of this UR.

#### **5. Points of discussions or possible discussions**

It is necessary to continue to discuss the need on 110% load tests during TA, FAT and Shipboard Trials for gas engines and on the gas mode of dual fuel engines which are designed to develop its maximum continuous power up to 110 % since any consensus had not been achieved yet at the Working Group.

#### **6. Attachments if any**

None

## **Technical Background (TB) document for UR M78, Rev.2 (Jan 2024)**

### **1. Scope and objectives**

After the development of UR 78 for a 4-stroke engine supply with at relatively low pressure, it was inevitable to respond to the market for engines supply with gas at relatively high pressure.

In the IGC code, the safety of ships is classified according to the maximum working pressure for the safety of supply lines, storage, and transportation, and this has been applied as it is in the IGF code.

However, there was also an opinion that it would be unreasonable to discuss the safety of the engines or machinery itself from the perspective of low and high pressure, mainly related to the safety of storage tanks/containers or pipes.

While it is true that these 4-stroke engines are supplied with gas fuel at relatively low pressures, it is debatable whether they fall within the low-pressure category defined by the IGF and IGC Codes. Because there is no definition of the maximum working pressure, and the air supply pressure of the turbocharger increases today, in an environment where the gas supply pressure is bound to increase, generally classifying these four-stroke engines as low pressure is inevitably an expedient made by desperate measures.

Therefore, the working pressure of high or low pressure mainly acts on pipes or storage containers, and it is necessary to develop UR that acts on combustion engines for all operating principles, and we tried to clarify the gas fuel used in these engines.

In addition, the development of the IGF code was aimed at developing UR by recalling minimizing risk factors to ships, crew members and the environment, keeping in mind that the IGF Code took a Goal-based approach.

#### **1.1 Project Process**

PT read and discussed every paragraph of IGF codes, existing UR M78 and prepared a comparison table of IGC and IGF code and compared each other's, and discussed several issues, including why the safety concept and risk assessment, which are issues that can be problematic, such as matters to be verified in the IGF code, are information rather than review (approval items), and the definition of the safety concept and the definition of working pressure and working pressure in existing UR M78. Of course, discussed and thoroughly reviewed the MCR of the DF engine.

After this PT prepared an excel spread sheet of work item and discussed one by one.

## 2. Engineering background for technical basis and rationale

### 2.1 Title

Existing title was "Safety of Internal Combustion Engines Supplied with Low Pressure Gas".

There are two issues, one is using "Safety" and another one is "Low pressure gas".

#### 2.1.1 Safety

Safeguarding life, property and environment is an inherent objective of any IACS resolution and needs not be reflected in their titles. "Safety" has been deleted to align with titles of other IACS resolutions.

#### 2.1.2 Natural gas

According to the preamble of IGF Code, the current version of this Code includes regulations to meet the functional requirements for "natural gas fuel".

Regulations for other low-flashpoint fuels will be added to this Code as, and when, they are developed by the Organization.

Further the IGF Code Part A-1, SPECIFIC REQUIREMENTS FOR SHIPS USING NATURAL GAS AS FUEL specify that,

Fuel in the context of the regulations in this part means natural gas, either in its liquefied or gaseous state.

However, the PT focused on the gaseous state, not liquefied state or cryogenic gas, but extended this to cover similar fuels with main component methane such as bio-methane or synthetic methane. This direction was considered current industry trends.

Natural gas is stored and transported in the two forms. compressed and liquefied form. A special compression container or facility for liquefied gas is required for storage, but the density of compressed gas per volume is lower than that of the liquefied form. Therefore, compressed gas is not used unless the condition of the ship is prepared in advance.

**Compressed natural gas (CNG)** is a fuel gas mainly composed of methane ( $\text{CH}_4$ ), compressed to less than 1% of the volume it occupies at standard atmospheric pressure. It is stored and distributed in hard containers at a pressure of 20–25 megapascals (2,900–3,600 psi), usually in cylindrical or spherical shapes.

**Liquefied natural gas (LNG)** is natural gas (predominantly methane,  $\text{CH}_4$ , with some mixture of ethane,  $\text{C}_2\text{H}_6$ ) that has been cooled down to liquid form for ease and safety of non-pressurized storage or transport. It takes up about 1/600th the volume of natural gas in the gaseous state (at standard conditions for temperature and pressure).

**Biogas** is an environmentally friendly, renewable energy source produced by the breakdown of organic matter such as food scraps and animal waste. Biogas is a renewable fuel that's produced when organic matter,



such as food or animal waste is broken down by microorganisms in the absence of oxygen. This process is called anaerobic digestion. For this to take place, the waste material needs to be enclosed in an environment where there is no oxygen.

**Synthetic methane, or e-methane**, is a so-called electro fuel. These 'e-fuels' are made from two raw materials: hydrogen that's produced from water via electrolysis (preferably using renewable energy), and CO<sub>2</sub> captured from the air around us or exhaust gases. In this UR Synthetic methane is used for simplification.

**Ethane and others (including Natural gas plant liquids (NGPL):** Natural gas includes ethane and certain substances from these processes, but they are not covered in this project.

This UR, has been revised to cover engines using natural gas whose main component is methane and gas containing biogas and syngas, which are mainly methane but not natural gas.

## 2.2 General principles for the combustion of the engines

Combustion engines basically burn according to two principles. One is to mix air and fuel in advance and burn in a relatively short time inside the combustion chamber, and the other is to inject fuel into a place where only air is compressed and burned.

The former is called premixed combustion, where the combustion state is determined mainly by the flame propagation speed, while the latter is diffusion combustion, where the mixture state/speed of air and fuel determines the combustion state. On the market, the former is called combustion by gasoline or Otto principle, and the latter is called combustion by diesel principle.

Example – Pre-mixed combustion requires a slightly higher fuel supply pressure than supply air pressure, requiring a relatively low fuel supply pressure and more complete combustion.

As the situation develops, diffusion combustion requires high fuel supply pressure. The combustion is not perfect compared to the former, but their combustion conditions are completely different. It is academically or empirically confirmed that the compression pressure, maximum pressure, maximum temperature, and output power are completely different.

It becomes clear that the requirements for the engine do not change depending on the gas supply (working) pressure. Thus, this pressure change only relates to pipes, piping systems or storage devices.

It should be noted that land-based DF or gas engines may have gas and air mixed before the T/C. Such engines cannot be used in gas-safe machinery spaces on board vessels.

As for marine DF engines, pre-mixed combustion (Otto engine) was first applied to the 4-stroke trunk piston, and later, gas injection (Diesel principle) and premixed engines appeared in 2-stroke engines.

### 3. Source/derivation of the proposed IACS Resolution

The UR is consistent with:

- IGF Code 2016 as amended.
- Revised IGC Code 2014 as amended.
- Engine manufacturers' practices (through CIMAC).
- BS IEC 600092-502, 1999
- BS EN IEC 31010:2019, for Risk management – Risk assessment techniques
- BS ISO 5514: part2 :1988
- BS ISO 3046-2:1987:1987
- BS ISO 3036-1 2002
- ISO 8178 series (1 to 11) Reciprocating internal engines- Exhaust Emission measurement.
- BS ISO 14396 2002
- BS ISO 15550 2016
- Working paper 2020-02, The climate implications of using LNG as a marine fuel
- Fourth IMO Greenhouse Gas Study
- NOx technical Code 2008, MEPC.177 (58) as amended
- Resolution MEPC 308(73) Guidelines on method of calculation of the attained energy efficiency design index (EEDI) for new ships
- Resolution MEPC.333(76) 2021 Guidelines on method of calculation of the attained energy efficiency existing ship (EEXI)
- MSC-MEPC.2/Circ.12/Rev.2 REVISED GUIDELINES FOR FORMAL SAFETY ASSESSMENT (FSA) FOR USE IN THE IMO RULE-MAKING PROCESS
- IACS NO 138 Recommendation for the FMEA process for diesel engine control systems
- UR M9 Crankcase explosion relief valves for crankcases of internal combustion engines
- UR M10 Protection of internal combustion engines against crankcase explosions
- UR M35 Alarms, remote indications and safeguards for main reciprocating I.C. engines installed in unattended machinery spaces.
- UR M51 Factory Acceptance Test and Shipboard Trials of I.C. Engines
- UR M59 Control and Safety Systems for Dual Fuel Diesel Engines
- UR M67 Type Testing Procedure for Crankcase Oil Mist Detection and Alarm Equipment
- UR M71 Type Testing of I.C. Engines
- UR M73 Turbochargers
- MSC.1-Circ 1625 Draft MSC Circular -Unified Interpretation of the IGC Code.
- CIMAC Guideline 2013 July Guideline on the relevance of lubricant flash point in connection with crankcase explosions
- The climate implications of using LNG as a marine fuel, WORKING PAPER 2020-02, 2020 INTERNATIONAL COUNCIL ON CLEAN TRANSPORTATION, Nikita Pavlenko, Bryan Comer, PhD, Yuanrong Zhou, Nigel Clark, PhD, Dan Rutherford, PhD
- Fourth IMO GHG Study 2020, Full Report, IMO
- Application & Installation Guide, Crankcase Ventilation Systèmes. LEBW4958-04 Caterpillar

- Assessment of Fuel Oil Availability: Final report, Prepared for The International Maritime Organization. CE Delft, Stratas Advisors, UMAS, NMRI, Petromarket Research Group, & Shichi Hanayama (2016)
  - "A Study on the Performance simulation for the Small Four-Stroke Cycle Gasoline Engine" Kisoo Kwon, 1988, Journal of Korea Maritime and Ocean University
  - An application of the FSA to the Tanker Safety Operation, Kisoo Kwon, 2001, Journal of Korean Society of Marine Engineers

#### **4. Summary of Changes intended for the revised Resolution:**

Here is a summary of the work done in this revision.

- Amendments have been prepared to extend the scope of application of the UR M78 to cover all types of engines (2- and 4-stroke, gas injection and premixed gas combustion engines, trunk piston and crosshead, gas supplied with high and low pressure) from trunk piston engines with low pressure gas supply.
- In this revision the project team reviewed DF engines and GF engines using natural gas, but they also included biomethane and synthetic methane (whose main component is methane which is not natural gas). Ethane, which contains many components in natural gas, was excluded from the review.
- Although this revision extends the application to all DF and GF engines using natural gas, the structural modifications of the UR have been kept to a minimum.
- It is noteworthy that UR M59 (1996) has been withdrawn as part of this project, which was evaluated as no longer suitable for ships to which the 2016 IGC Code applies. Items necessary to maintain from UR M78 have been incorporated into UR M78.
- The PT reviewed the issues raised by CIMAC regarding IGF Section 10.3.1.2 (where CIMAC recommended further clarification of the term "piston in direct communication with the crankcase" to avoid misleading references, see PM18914\_IMa dated 17 April 2018). The PT further reviewed some additional comments including definition of "certified safe type" received from the Panel.
- The IGF and IGC code requirements for air inlet manifold, scavenging space and exhaust manifold pressure relief systems were reviewed and proposed.
- Design requirements were developed by reviewing the requirements for the design of pipes and pipe systems, including 78.2.2.1.1. in the IGF and IGC codes.

The design of the piping system includes the material grade and connection of the pipe, and the design conditions including the grade of double pipe and single pipe are stipulated.

In addition, the connection of the piping system includes the testing conditions of the expansion joint.

- The boundary line between low pressure and high pressure was defined based on the engineering unit of 1MP based on the maximum operating pressure, and this low and high pressure was used for designing pipes, piping systems, and other storage systems.
- Type testing, factory approval testing and on-board vessel testing were comprehensively reviewed and proposed by the stage and, as for the pending issue, the contents of the technical background about MCR are summarized as follows.

In the DF engine type approval, factory approval, and onboard vessel testing, attention was paid to the fact that MCR verification for gas mode could be omitted, and the problems caused by this omission were reviewed and solutions were presented.

- Among the documents to be submitted for approval of the DF engine, it was confirmed that the documents on safety concept and risk assessment were not subject to approval by the responsible organization according to the IGF code but were merely for information.
- Required inspections and certificates of various components of the DF engine were generally reviewed, and requirements for these were presented in a table by component-by-item, and necessary explanations were provided.
- Although it was not included in the scope of work of this amendment, the matters to be amended in a short time for DF or GF engines for other low flash point fuels were reviewed and confirmed.
- The technical background and data related to the above work were prepared and presented, and the title change for the first stage work was reviewed and presented.
- Some of the reviews were done with the second stage fuel in mind, as well as other fuels with low-flash point (Ethane, LPG, Methyl/ethyl alcohol, Hydrogen and Ammonia).

**The following summarizes and lists the items related to the revised work and presents the item in the order of revision.**

1. Change of title to Reciprocating Internal Combustion Engines fuelled by Natural gas from Safety of Internal Combustion Engines Supplied with Low Pressure Gas
2. Scope of Engine – from Trunk Piston internal combustion engines supplied with low pressure natural gas as fuel to marine reciprocating internal combustion engines supplied with natural gas as fuel.

3. Applied gas extended to natural gas regardless of pressure from LNG supplied by low pressure, and biogas and e-gas whose main component is methane, although it is not natural gas.
4. Change of text structure for the 1.1.1 Types of engines, adding new paragraph and change of paragraph.
5. Deletion of paragraph regarding gas introduction to the engine related to pre-mixed engine, which will be duplicated and added to new text for definition of the pre-mixed engine.
6. Deletion of 1.1.2 application because of new paragraph introduction for the application and added a paragraph related to the application of the engine, in the 1.1.1 Types of engines.
7. Change of 1.2.1 Definition of Certified safe equipment, the change of definition related to this term started from the request of the Machinery Panel member however there is another request from machinery Panel member to retain original definition. However, after long discussion of the project team, found there is no different, meaning of the definition whether keep the original test or new test. And there is another opinion that definition is not necessary since there is clear definition IGF code. Therefore, project team decided to keep a new definition and put one note like IGF code.
8. Flexibility of Definition of Certified safe equipment, this new definition gives the flexibility of the definition of Certified safe equipment and a compromise of different opinion from the machinery panel.
9. Add a note related to certified safe equipment, this note already explained in item 7.
10. Deletion of definition of existing 1.2.4 Engine room, please refer to technical background.
11. Add a new definition for Explosion relief device, which can use for the protection of exhaust system and son on.
12. Change for definition of 1.2.5 Gas for this UR and note for bio-methane or synthetic methane.
13. Change of 1.2.6 Gas admission valve to give flexibility and rationalization.
14. Deletion of Gas Valve Unit to follow the machinery panel's opinion.
15. Definition of High-pressure gas in 11.2.10 by bar and maximum working pressure. The unit bar has been intentionally used because there are more gauges displayed in bar than MPa in the engine room.
16. Change of definition for 1.2.14 Low pressure gas, please refer to the technical background and item 15 definition of high-pressure gas.

17. Change of Definition for 1.2.18 pre-mixed engine, please refer to technical background.
18. Development for additional comment for 1.2.20 Safety Concept to include the result of the risk analysis to the safety concept.
19. Modification of 1.3.1 Documents and drawings to be submitted, specially to List of certified safe equipment and relevant certification from List of certified safe equipment and evidence of relevant certification.
20. Modification of 1.3.2 Documents and drawings to be submitted for the approval of DF engine. Specially to Schematic layout or other equivalent documents of pilot fuel system from Schematic layout or other equivalent documents of fuel oil system (main and pilot fuel systems).
21. Modification of 1.3.3 Documents and drawings to be submitted for the approval of GF engine. Specially to Schematic layout or other equivalent documents of the ignition system from Ignition system.
22. Modification of footnotes 1) to If required by UR M44, see also 2.2.5.1 from If required by UR M44, for clarification.
23. Change of foot note 3) to The documentation to contain specification of design pressure, working pressure, pipe dimensions and materials from The documentation to contain specification of pressures, pipe dimensions and materials for specification of documentation to be submitted.
24. Change of paragraph, second sentences in 1.4.1 the risk analysis is to address to a gas leakage downstream of the double block and bleed valves from a gas leakage downstream of the gas valve unit.
25. Added a paragraph (see also 2.1.2) to b) in 1.4.3. procedure for the risk analysis.
26. Change of paragraph to Gas admission valves from cylinder gas supply valve in 1.4.4. a) second paragraph.
27. Change of note, to gas supply system from Gas Valve Unit (GVU) due to deletion of definition on Gas Valve Unit (GVU) 1.2.10
28. Add a word "glow plug" to 1.4.4. b) failure of the ignition system (oil fuel pilot injection, sparking plugs, glow plugs)
29. Change of paragraph 1.4.4. d) to for engines where gas is supplied upstream of the turbocharger compressor, failure of a component likely to result in a source of ignition (hot spots) from for engines where gas is injected upstream of the turbocharger compressor, failure of a component likely to result in a source of ignition (hot spots)
30. Change of paragraph 1.4.4. g) to presence of gas in engine components (e.g. air inlet manifold or scavenge space and exhaust manifold) and in the external systems connected to the engines (e.g.

exhaust duct, cooling water system, hydraulic oil system, etc.). from abnormal presence of gas in engine components (e.g. air inlet manifold and exhaust manifold of DF or GF engines) and in the external systems connected to the engines (e.g. exhaust duct).

31. Change of paragraph 1.4.4. i) to hazard potential for crankcase fuel gas accumulation, for trunk-piston engines, refer to IGF Code 10.3.1.2. and UR M 10 from hazard potential for crankcase fuel gas accumulation, for engines where the space below the piston is in direct communication with the crankcase, refer to IGF Code 10.3.1.2.
32. Adding a sentence as 1.4.4. j) risk of crankcase explosion in connection with active crankcase ventilation which produces a flow of external air into the crankcase, see UR M10.5 1)
33. Change of a word in 2.1.1 b) mitigate the consequences of a possible explosion to a level providing a tolerable degree of residual risk, due to the strength of the component(s) or the fitting of suitable explosion (from pressure) relief devices of an approved type.
34. Same as above, "pressure "changed to explosion.
35. Add a word "Explosion" before relief valve.
36. Add a paragraph end of 2.1.2 as follows; With reference to 2.1.2.b), the strength of the component(s) or the arrangement of explosion relief devices shall be documented (e.g. as part of the risk analysis) or otherwise demonstrated to be sufficient for a worst case explosion.
37. in the end of introduction paragraph of 2.2.1.1 added "as applicable "and added a few sentences as follows

Other connections as mentioned in IGF Code 7.3.6.4.4 may be accepted subject to type approval in accordance with the requirements of UR P2.7 and P2.11. All single walled or high-pressure gas pipes should be considered as Class I.

Low pressure double walled gas pipes should be considered as Class II. All secondary enclosures for gas pipes should be considered as Class II. Single walled gas vent pipes should be considered as Class I, except it is justified that the maximum built up pressure is less than 5 bar gauge, in which case it should be considered as Class II.

Gas vent pipes protected by a secondary enclosure should be considered as Class II.

38. 2.2.1.1 (cont): Added a "Table 1 for design condition for piping, piping system and components".

	Design pressure	
Gas pipe, low pressure	see IGF 7.3.3.1	see IGC Code 5.4.1
Gas pipe, high pressure	see IGF 7.3.3.1	see IGC Code 5.4.1
outer pipe, low pressure	see IGF Code 9.8.1	see IGC Code 5.4.4
outer pipe, high pressure	see IGF Code 9.8.2	see IGC Code 5.4.4
Open ended gas pipes	see IGF Code 7.3.3.2	see IGC Code 5.4.1

39. 2.2.1.1 (cont.): Added a few sentences and notes for regarding "Flexible bellows" as follows;

Flexible bellows used in the fuel gas system on the engine shall be approved based on the requirements of IGF Code 16.7.2, and IGC Code 5.13.1.2, as applicable.

The number of cycles, pressure, temperature, axial movement, rotational movement and transverse movement which the bellow will encounter in actual service on the engine should be specified by the engine designer.

Note: IGF 16.7.2.4 (fatigue test due to ship deformations) is considered not relevant for bellows which are an integral part of the engine. The EJMA calculation or equivalent should be prepared instead.

Endurance against high cycle fatigue due to vibration loads shall be verified by testing or alternatively be documented by the Expansion Joint Manufacturers Association, Inc. (EJMA) calculation or equivalent (i.e. more than  $10^7$  cycles).

40. Added a phrase 2.2.2.2 a) as follows:

for engines supplied with low pressure gas and installed in ESD protected machinery spaces, as defined in IGF Code 5.4.1.2 and in compliance with other relevant parts of the IGF Code (e.g. 5.6);

41. Modification of 2.2.3 to add a phrase "Charge air system and exhaust gas system on the engine.

The charge air system and the exhaust gas system on the engine are to be designed in accordance with 2.1.2 above.

In case of a single engine installation, the engine is to be capable of operating at sufficient load to maintain power to essential consumers after opening of the explosion relief devices caused by an explosion event. Sufficient power for propulsion capability is to be maintained.



Note: Load reduction is to be considered on a case-by-case basis, depending on engine configuration (single or multiple) and relief mechanism (self-closing valve or rupture disk).

42. Modification of 2.2.4 Exhaust system on the engine as following sentences.

Continuous relief of exhaust gas (through open rupture disc) into the engine room or other enclosed spaces is not acceptable.

Suitable pressure relief system for air inlet manifolds, scavenge spaces and exhaust system should be provided unless designed to accommodate the worst-case overpressure due to ignited gas leaks or justified by the safety concept of the engine. A detailed evaluation regarding the hazard potential of overpressure in air inlet manifolds, scavenge spaces and exhaust system should be carried out and reflected in the safety concept of the engine.

Explosion relief devices for air inlet and exhaust manifold shall be type approved according to UR M82.

The necessary total relief area and the arrangement of the explosion relief devices shall be determined taking into account:

- The worst-case explosion pressure depending on initial pressure and gas concentration,
- the volume and geometry of the component, and
- the strength of the component.

The arrangement shall be determined in the risk analysis (see 1.4.4.g) and reflected in the safety concept.

43. Added a sentence at the end of paragraph 2.2.5.1.

For engines not covered by M9, the detailed evaluation as required in 1.4.4.i is to determine if crankcase explosion relief valves are necessary.

44. Added a paragraph regarding Crankcase ventilation as 2.2.5.3.

Ventilation of crankcase (either supply or extraction), if arranged, is to comply with UR M10.5.

Relevant evidence is to be documented in Safety Concept.

Each engine shall be fitted with independent venting systems for crankcases and sumps.

45. Added a phrase in 2.2.8 before Gas admission valves as followings.

Electrically operated gas admission valves shall be certified safe as follows:

46. Added a paragraph at the end of existing 2.2.8 as followings.

Gas admission valves operated by hydraulic oil system are to be provided with sealing arrangement to prevent gas from entering the hydraulic oil system.

47. Some modification and adding a few phrases on table 2 (of revision 2) - Monitoring and safety Functions for DF and GF engine as follows.

Parameter	Alarm	Automatic activation of the double block-and-bleed valves	Automatic switching over to oil fuel mode <sup>1)</sup>	Engine shutdown
Abnormal pressures in the gas fuel supply line	X	X	X	X <sup>5)</sup>
Gas fuel supply systems - malfunction	X	X	X	X <sup>5)</sup>
Pilot fuel injection or spark ignition systems - malfunction	X	X <sup>2)</sup>	X	X <sup>2)5)</sup>
Exhaust gas temperature after each cylinder - high	X	X <sup>2)</sup>	X	X <sup>2)5)</sup>
Exhaust gas temperature after each cylinder, deviation from average – low <sup>3)</sup>	X	X <sup>2)</sup>	X	X <sup>2)5)</sup>
Cylinder pressure or ignition - failure, including misfiring, knocking and unstable combustion	X	X <sup>2)4)</sup>	X <sup>4)</sup>	X <sup>2)4)5)</sup>
Oil mist concentration in crankcase or bearing temperature <sup>6)</sup> - high	X	X		X
Pressure in the crankcase – high <sup>8)</sup>	X	X	X	
Engine stops - any cause	X	X		
Failure of the control-actuating medium of the block and bleed valves	X	X	X	
Failure of crankcase ventilation system, if applicable	X	X <sup>7)</sup>	X <sup>7)</sup>	
Footnotes:				
1) DF engine only, when running in gas mode				
2) For GF engines, the double block-and-bleed valves and the engine shutdown may not be activated in case of specific failures affecting only one cylinder, provided that the concerned cylinder can be individually shutoff and the safe operation of the engine in such conditions is demonstrated by the risk analysis.				
3) Required only if necessary for the detection of misfiring				
4) In the case where the failure can be corrected by an automatic mitigation action, only the alarm may be activated. If the failure persists after a given time, the safety actions are to be activated.				
5) GF engine only				
6) Where required by UR M10				
7) Automatic safety actions to be activated as specified by the engine manufacturer, see UR M10				
8) Only for trunk piston engines. This pressure sensor cannot replace or substitute a gas detector.				
9) Only for trunk piston engines. For crosshead engines slow down shall apply (see UR M35 Tab.1)				

48. Modification of chapter 3. Specific design Requirement as follows.  
Basically, continued the existing concept which is accepted if the engine is designed for a lower power output in a gas mode than in diesel mode, however the engine designer stated and submitted MCR for gas mode.  
The reason for the lower power output of the gas mode is not only the gas quality, but also the engine design, i.e. the premix type in general is less than the gas injection type.
49. Modification of the paragraph 3.1.1. General to clarify the MCR of the DF engine – MCR should be stated and submitted, please refer to TB.
50. Modification of 3.1.2 Starting, Changeover and stopping
51. Added a paragraph at the end of sentences as followings.  
If the power level or other conditions do not allow safe and reliable gas operation, changeover to oil fuel mode shall be automatically performed.
52. Added 3.4 for Design requirement of Two stroke engines as follows.

### **Two-stroke engines**

#### Scavenge air system

The risk analysis required in 1.4 is to cover the possible gas accumulation in a scavenge space.

#### Crankcase

The risk analysis required in 1.4 is to cover the possible failure of a piston rod stuffing box.

53. Modification of 4.1.2 Type of engine as follows for clarification.  
Gas modification method (Cylinder injection after compression stroke, Cylinder individual injection before compression stroke or pre-mixed)
54. Change the word from supply to admission (~~supply~~) as gas admission valve operation (mechanical or electrically controlled)
55. Added a Note at the end of sentences 4.1.2 Type of engine as follows.  
  
Note: Cylinder-individual injection before compression stroke may be port injection into the air inlet channel before the cylinder inlet valve, injection into the cylinder before or during compression stroke, or similar arrangements.
56. Added a phrase at the end of paragraph, 4.1.4 Test programme as following.  
  
The type testing of the engine is to be carried out in accordance with UR M71.5, taking into account the additional requirements of this UR.
57. Moved and rearranged a paragraph, 4.1.4 testing programme for better understanding.

58. Added items in 4.1.5 for pilot fuel to be measured and recorded during testing.

59. Added a Note at the end of sentences for 4.1.5. Measurements and records as follow.

Note: The gas concentration in the crankcase should normally be measured inside the crankcase or at the crankcase outlet (crankcase vent pipe).

Gas concentration measurements may be carried out as part of Stage A if the method and the results are properly documented.

60. Added a paragraph at the end of sentences, 4.1.6 Stage A- internal tests as follows.

The influence of the methane number and LHV of the fuel gas on the engine's maximum continuous power available in gas mode is to be verified.

61. Added and modified 4.1.7 Stage B – witnessed tests as follows.

- all load points must be run in both gas and diesel modes that apply for the engine type as defined by the engine designer.

The independent overspeed protection device has to be tested both in gas and diesel mode (UR M71.8.2).

- For engines with variable liquid / gas ratio, selected load tests are to be carried out at different ratios between the minimum and the maximum allowable values (most relevant and critical loads and ratios should be selected for the test).
- The maximum continuous power available in gas mode (see 3.1.1) is to be demonstrated.
- 110 % overload testing is not required in gas mode for DF engines, provided that changeover to oil fuel mode is automatically performed in case of overload.
- The load tests are to be carried out in diesel mode and in gas mode at the different percentages of the engine's MCR.

62. Added a paragraph for 4.1.7.2. Functional Tests in the middle of the sentences as follows.

For DF engines, verification of automatic changeover to diesel mode when the load demand exceeds the maximum continuous power available in gas mode (see 3.1.1 and 3.1.2)

63. 4.1.7.2 (cont): Modification of sentence as follows.

The efficiency of the ventilation arrangement or other approved principle of the double walled gas piping system is to be verified.

64. 4.1.7.2 (cont): Deletion of following sentence for feasibility and reality  
~~Simulation of a gas leakage in way of a cylinder gas supply valve.~~

65. Modification of a paragraph as follows.

Failure of a ~~cylinder~~ gas admission supply valve

66. Added a paragraph regarding Engine type approval certificate as follows.

[4.1.9] Engine type approval certificate

For DF engines, the maximum continuous power available in gas mode should be specified on the type approval certificate in addition to the maximum continuous rating in diesel mode, if differing.

67. Modification of Factory acceptance test in 4.2.1 as follows.

For DF engines, the load tests referred to in UR M51.3.3 are to be carried out in diesel mode and in gas mode at the different percentages of the engine's MCR.

The maximum continuous power available in gas mode is to be demonstrated.

68. Modification of a paragraph in 4.2.5 as follows.

Failure of a cylinder gas admission supply valve

69. Added and modified shipboard trials in 4.3 as follow.

Shipboard trials are to be carried out in accordance with the provisions of UR M51.4, considering the additional requirements below.

For DF engines, the test loads required in UR M51.4.4 are to be carried out in all operating modes (gas mode, diesel mode, etc.), as applicable (see 3.1.1).

The maximum continuous power available in gas mode is to be demonstrated.

Note:

If a test load is performed in all applicable operation modes without interruption (direct changeover at same power and speed), the duration as required in UR M51.4.4 may be considered as the total duration demonstrated in all fuel modes. However, demonstration at each mode shall not be less than one hour.

The starting maneuvers required in UR M51.4.2 are to be carried out in diesel mode and gas mode, if applicable.

For DF engines, automatic switching over to oil fuel mode is to be tested.

Further, manual change over from diesel to gas mode and vice versa is to be tested.

A leak test is to be carried out for the gas piping system (IGF Code 16.7.3.3 after assembly on board.

The efficiency of the ventilation arrangement, or other approved principle, of the double walled gas piping system is to be verified.

70. Developed and added Chapter 5 Certification of Engine Components as follows.

71. Certification of Engine Components

The principals, definitions, and general requirements of UR M72 apply. In addition to those components specified in UR M72, the engine components listed in Table 3 shall be documented as listed in the table.

**TABLE 3: Required documentation for engine components**

Part	Material properties	Non-destructive examination	Pressure testing	Visual inspection of welds	Component certificate
Gas pipe Low-pressure double walled	W(C+M)	W 2), 6)	W 4)	X	
Single walled Gas pipes	W(C+M)	W 1)	W 4)	X	SC
High-pressure gas pipes	W(C+M)	W 1)	W 4)	X	SC
Secondary enclosure for gas pipes	W(C+M)	W 2)	W 3)	X	
Gas pipe Low-pressure, Flanges*	W(C+M)	W 2), 6)		X	
Gas pipe High-pressure, Flanges*	W(C+M)	W 1)		X	SC
Gas pipe Low-pressure, Fittings and other components	W(C+M)		W 4)	X	
Gas pipe High-pressure, Fittings and other components	W(C+M)		W 4)	X	SC

Gas pipe Low-pressure Bodies of valves, 7)	W(C+M)		W 4)		
Gas pipe High-pressure Bodies of valves	W(C+M)		W 4)		SC
Gas venting pipes and flanges*, build up pressure less than 5.0bar	TR(C+M)	W 2)	W 4)	X	
Gas venting pipes and flanges*, build up pressure at 5.0bar or more with secondary enclosure	TR(C+M)	W 2)	W 4)	X	
Gas venting pipes and flanges*, build up pressure at 5.0bar or more	W(C+M)	W 1)	W 4)	X	SC
Gas venting pipes Secondary enclosure			W 5)	X	

## Footnotes:

- 1) 100 % radiographic or ultrasonic inspection of all butt-welded joints (IGF Code 16.6.3.1)
  - 2) 10 % radiographic or ultrasonic inspection of butt-welded joints (IGF Code 16.6.3.4)
  - 3) Pressure test at 1.5 x design pressure to ensure gas tight integrity, not less than the expected maximum pressure at gas pipe rupture (as per IGF 16.7.3.4, and 9.8.4)
  - 4) Pressure test at 1.5 x design pressure
  - 5) Leak test.
  - 6) If inside diameter > 75 mm or wall thickness > 10 mm: 100 % radiographic or ultrasonic inspection of all butt-welded joints (IGF Code 16.6.3.1)
  - 7) If nominal diameter > 25 mm
- (\* ) "Flanges" limited to the final connection to the engine.

## 5. Points of discussions or possible discussions

The main points of discussions are detailed below.

- CIMAC has reviewed the draft documents UR M78 Revision 2 with following notes;



*i. 1.2.4: Explosion relief device means a device to protect personnel and components against a determined overpressure in the event of a gas explosion. The device may be a valve, a rupture disc or other, as applicable.*

*ii. 1.3.1 – No.4: Arrangement of explosion relief valves (crankcase1, charge air manifold, exhaust gas manifold and exhaust gas system) as applicable.*

*iii. 2.2.3: Charge air system and exhaust gas system on and after the engine  
The charge air system and the exhaust gas system on and after the engine are to be designed in accordance with 2.1.2 above.*

Two members expressed that adding personnel in paragraph 1.2.4 may not be appropriate.

A member expressed that adding the exhaust gas system in paragraph 1.3.1 may not be necessary as the exhaust gas system may fall into scope of yards.

However, manufacturers may include certain scheme in their safety concept document.

Finally the majority in MP agreed that CIMAC comments to be incorporated into draft of UR M78 Revision 2.

- SuP has reviewed draft UR M78 Revision 2 and found that majority of panel members have no comments on surveyable items.

## **5.1 Engine room**

Engine room is a machinery space or enclosure containing gas fuelled engine(s). The term engine room was not used in the M78, and it was agreed to delete it because the new definition might lead to confusion.

Different Opinion: However, Machinery Space, which has not been used in the current M78 but is used repeatedly in the IGC and IGF codes and is used interchangeably with this term, is actually several other machinery spaces, such as space for cargo gear or other equipment. The opinion that it could be a space that means a machine space came out at the end of the final meeting, but decision was made to delete it.

## **5.2 Venting pipe issue**

Interim decision of PT is to keep as it is until IACS discuss with IMO and receive a waiver or unified interpretation.

## **5.3 maximum working pressure**

Definition [1.2.10] High pressure gas means gas with a maximum working pressure greater than 10 bar gauge.

Working pressure will be decided based on scavenge pressure plus and regulated by pressure controller.

The design pressure of the pipe is determined by IGF code 9.8.2 based on maximum working pressure. Therefore, if there is no working pressure, there is no maximum operating pressure, and if so, the design pressure cannot be determined without maximum working pressure.

The maximum working pressure should take into account the safety relief valve setting and potential failure of the pressure control system, as applicable. Refer to UR P1.2.7.

This important information should be submitted and made known to those involved, but right now this information is not expressed correctly.

#### **5.4 pre-mixed engine**

[1.2.18] A pre-mixed engine is an engine in which fuel and air are mixed before combustion begins. i.e., in the cylinder, in the air intake space or through the common manifold including mixed before the turbocharger.

Previous - Pre-mixed engine means an engine where gas is supplied in a mixture with air through a common manifold for all cylinders, e.g. mixed before the turbocharger.

For the clarification of combustion principle of gas fuel, terms of pre-mixed and gas injection are necessary.

The reason is that there is an opinion that engines such as port-injection are not pre-mixed engines, but this is not true from the point of combustion theory. Therefore, this will inform you that there are currently two opinions, and we will organize them at the next opportunity.

Because a pre-mixed combustion/engine is well defined in combustion theory to include cylinder injection, port inject and common manifold, and of course before or after turbocharger.

#### **5.5 Documents and drawings to be submitted.**

[1.3.1] Documents and drawings to be submitted for the approval of DF and GF engines.

Parts for gas admission system

The followings documents should be included- The documents to contain specification of design pressure, working pressure, pipe dimensions and materials.

#### **5.6 Safety concept and Report of the risk assessments**

As mentioned in interim report, this safety concept and risk assessment should be reviewed but these two important items are still for information document.

IGF code chapter 3 and 4, and first several sections of each chapter are related to these two issues, therefore the document should be prepared a document by engine designer and discussed with RO (responsible organization)

And understand that this safety concept definition does not make a clear connection with the goal and function requirement in chapter 3 of the IGF code, the risk assessment in the general requirements in chapter 4, and the functional requirements at the beginning of each chapter. Agree on the need for a clear redefinition. However, this issue hasn't been agreed to deal in this PT and this issue is not prepared by PT.

For to deal all the low-flash point fuel, this should be decided by machinery panel.

### **5.7 Pressure and pressure sensor in the crankcase**

Please refer to item 47 in summary of changes above and below note 8.

Footnotes:

- 1) DF engine only, when running in gas mode
- 2) For GF engines, the double block-and-bleed valves and the engine shutdown may not be activated in case of specific failures affecting only one cylinder, provided that the concerned cylinder can be individually shutoff and the safe operation of the engine in such conditions is demonstrated by the risk analysis.
- 3) Required only if necessary for the detection of misfiring
- 4) In the case where the failure can be corrected by an automatic mitigation action, only the alarm may be activated. If the failure persists after a given time, the safety actions are to be activated.
- 5) GF engine only
- 6) Where required by UR M10
- 7) Automatic safety actions to be activated as specified by the engine manufacturer, see UR M10
- 8) Only for trunk piston engines. This pressure sensor cannot replace or substitute a gas detector.
- 9) Only for trunk piston engines. For crosshead engines slow down shall apply (see UR M35 Tab.1)

Careful investigation for the related document (i.e., CIMAC Guideline 2013 July Guideline on the relevance of lubricant flash point in connection with crankcase explosions, UR M9, M10, M66 and M67) reached that ordinary pressure sensor can't replace the gas detector.

However, this pressure sensor is thought to be helpful in detecting the leakage of unburned fuel/burned gas between the piston and cylinder if this is well located, but there is a consensus that it cannot replace the gas detector and some member worried about to be used as substitute of detector.

### **6. Attachments if any**

None

## UR M79 “Towing winch emergency release Systems”

### Summary

This UR defines minimum safety standards for winch emergency release systems provided on towing winches that are used in the handling of ships within close quarters, ports or terminals.

### Part A. Revision History

Version no.	Approval date	Implementation date when applicable
Rev.1 (Feb 2020)	24 February 2020	1 July 2021
New (Oct 2018)	29 October 2018	1 January 2020

#### • Rev.1 (Feb 2020)

##### .1 Origin of Change:

- Suggestion by IACS Machinery Panel Member and Survey Panel

##### .2 Main Reason for Change:

The UR M79 (New, Oct 2018) has been revised in order to solve some requests for clarification raised by some winch manufacturers and shipyards via one member of the Machinery Panel and to solve an issue raised by the Survey Panel.

##### .3 List of non-IACS Member classification societies contributing through the TC Forum and/or participating in IACS Working Group:

None

##### .4 History of Decisions Made:

The UR M79 (Rev. 1) has been developed by correspondence and agreed at the 30<sup>th</sup> Machinery Panel Meeting (17 to 20 September 2019).

GPG decided to modify para 1.1, adding “*including those ships normally not intended for towing operation in transverse direction.*” at the end of the existing text, to provide clarification on the applicability of the UR.

GPG also decided to modify the existing text defining the term “girting”, such that the modified text states the purpose of the UR instead of defining the term “girting”. The modified text was shifted under a new section “2. Purpose” as new paragraph 2.1. Existing paragraphs coming after new para 2.1 were renumbered.

##### .5 Other Resolutions Changes

None

**6 Any hinderance to MASS, including any other new technologies:**

None

**.7 Dates:**

Original Proposal: 15 April 2019 (Ref: PM19919\_NKa)  
Panel Approval: 19/11/2019 (Ref: PM19919\_IME)  
GPG Approval: 24 February 2020 (Ref: 19235\_IGh)

**• New (Oct 2018)**

**.1 Origin of Change:**

Other (Questions from industry)

**.2 Main Reason for Change:**

MAIB Report No. 17/2008 into the loss of the tug, Flying Phantom, concluded that the emergency release of tension on the towing winch failed to prevent the tug being girted by the pull from the assisted vessel. It was also apparent that the winch had probably not payed out any towing line at all. They also observe that although the rules for tugs laid down by several Classification Societies specify a tow line emergency release system, there are varying requirements, and the towing winch is not generally regarded as equipment that should be the subject of Class surveys.

Examples of Classification Society requirements for emergency release systems include: 'able to operate at any angle of heel', or, the emergency release mechanism must be 'reliable'. There is no clear standard which specifies a time within which the emergency brake release must operate, or under what loading conditions, heel angles etc. Application of a recognized standard, in combination with a testing regime, would provide for a fully functional emergency release system when a girting event occurs.

**.3 List of non-IACS Member classification societies contributing through the TC Forum and/or participating in IACS Working Group:**

None

**.4 History of Decisions Made:**

Form A originally submitted to GPG on 4<sup>th</sup> April 2013 to complete task as a PT. Lack of experienced individuals available to form a PT led to redrafting of Form A for work to be completed via correspondence, new Form A submitted to GPG on 7<sup>th</sup> February 2014. Form A approved by GPG on 7<sup>th</sup> August 2014.

**.5 Other Resolutions Changes**

None

**.6 Dates:**

Original Proposal: 13 July 2011 (Ref: PM11909\_IMa)  
Panel Approval: 22 June 2018 (Ref: PM11909\_IMzi)  
GPG Approval: 29 October 2018 (Ref: 11098\_IGs)

## Part B. Technical Background

List of Technical Background (TB) documents for UR M79:

Annex 1. **TB for New (Oct 2018)**

See separate TB document in Annex 1

Annex 2. **TB for Rev.1 (Feb 2020)**

See separate TB document in Annex 2



## Technical Background (TB) document for UR M79 (New Oct 2018)

### 1. Scope and objectives

The scope of the work item was to inform the Machinery Panel of the recommendation in MAIB Investigation Report 17/2008 to develop a UR regarding tug towing arrangement emergency release systems and to gauge member's opinions on the need for such development.

Having determined that members agreed with the need to progress, the main objective was to develop appropriate requirements and their associated rationale. As per the MAIB recommendation, the requirements have been proposed for the performance and operational requirements for a towline emergency release system taking into account the forces under which the system needs to operate and the speed of operation necessary to maintain the safety of the tug.

It was recognised that modern towing arrangement designs may mean that an emergency release is not necessary, the scope of the UR includes provision for these arrangements where it can be demonstrated that the stability of the vessel will not be jeopardised if the maximum design load is applied to the winch.

### 2. Engineering background for technical basis and rationale

The focus of this UR is the towing arrangement 'emergency release' system. This term has been selected based upon review of the following resources:

- a) MAIB Investigation Report 17/2008
- b) Consultation with industry bodies, and
- c) Existing International standards.

Alternative references to 'quick release' or 'full release' were considered but from discussions with industry bodies, it is understood that a 'quick release' has a different function to an 'emergency release', where a quick release is a quick but controlled means of relieving tension that may be used frequently during normal operations. However, an emergency release is explicitly a safety function, letting go tension and starting to pay the line out within a designated time, and mandatorily functional under the dead ship condition. It is interesting to note that the paper DE 56/22/4 submitted by Norway refers to a 'quick emergency release'. Further, ISO 7365:2012 'Shipbuilding and marine structures — Deck machinery — Towing winches for deep sea use' refers to an 'Emergency Release'.

The requirements were developed primarily in response to MAIB Report No. 17/2008 into the loss of the tug, Flying Phantom, under an expectation by affected stakeholders that quick action would be taken to improve safety in such scenarios. Consequently, the primary area of focus was close quarters tug operations. It is also noted that MSC/Circ.884 - 'Guidelines for Safe Ocean Towing' refers to an emergency release so it was considered unnecessary to extend the scope of this UR to include other towage operations and winch types.



### 3.1 Performance requirements

As is alluded to in the MAIB report, speed of operation of the emergency release is a critical factor in respect of the requirements and the release time period was debated during development. Operation within a maximum of one second was considered because some modern winches are capable of this. However, feedback from industry bodies suggested that for other winches, especially those with more complex control arrangements, even two seconds may not be achievable. Consequently, in alignment with the proposals in DE 56/22/4, the limit was set to three seconds. It is noted that the time limit specified in ISO 7365 is 10s but this is for ocean towing tugs where the time available to react to a situation may be longer.

It is further noted that the document SSE5/10 containing in Annex 2 the IMO draft "Guidelines for Onboard Lifting Appliances and Anchor Handling Winches" states 3 seconds in 4.1.7.1 for anchor handling winches ("Within 3 seconds after activation of emergency release, the holding force caused by winch drive/brake-system should be reduced to equal maximum 20% of the BP of the vessel....."). The above is stated for ready reference only, as the UR does not apply to anchor handling winches.

It may be argued that these times are driven by the capabilities of the system rather than the need of the situation. However, it is considered difficult to derive a time limit based directly on the stability criterion of the tug because of the wide variance of tug and winch designs and the lack of information about the time taken for girting and the critical factors that affect that time.

Requirements are included to ensure that a residual load is applied to the winch drum once the brake is released to ensure that the drum doesn't freewheel and rotate faster than the line is being pulled from it, resulting in the line being wrapped back around the drum and jamming the system.

A minimum load for drum rotation is also set to ensure that the system will be able to operate and rotate the drum when not fully loaded. Two approaches are provided:

- The prescriptive approach provides for the value for the minimum load to be set at the lesser of 5 tonnes or 5% of the maximum design load with two layers of towline on the drum. This has been set following discussion with industry bodies. 10% was suggested by one party as the figure typically used but in discussions with tug owners, 5 tonnes is considered appropriate for larger tugs whilst 5% would account for smaller 'workboat' tugs.
- The alternative approach allows for a larger minimum load for rotation of 15% of the maximum design load, provided that this is less than 25% of the load that would result in listing sufficient for the immersion of the lowest unprotected opening. This is intended to provide a factor of safety to allow for friction and other losses in the system that may prevent the full load from the tow being exerted on the winch.

All emergency release systems are to be operable under dead ship conditions; consequently an alternative source of energy (e.g. a hydraulic accumulator) is required. The sizing of this accumulator is to be sufficient to allow three apply-release cycles. Where multiple winches are fitted on a tug it is permitted that they may share the alternative source of power on condition that only one winch is in operation at a

time. In this case the alternative source of energy is to be sized according to the winch with the largest demand.

Where the drum release mechanism requires continuous application of power, a requirement is included in the UR for the alternative source of energy to be sufficient to hold the brake open for a minimum of five minutes. This is intended to allow time for the tug to release tension and manoeuvre sufficiently to take up a safe position and resume towage if possible. It is not intended for this requirement to be combined with the three operations requirement resulting in 15 minutes of holding capacity.

### 3.2 Operational requirements

The activation buttons are to be located on all working positions but the requirement permitting the bridge activation location is to ensure that an emergency release can be reset without need for a crewmember to access the working deck where the winch is operating.

A requirement has been included for prioritisation of the emergency release function over all other emergency stop functions on the tug. This to ensure that the emergency release will operate no matter what other emergency functions have been activated.

Hardwired control systems are preferred over electronic systems for the activation of the emergency release because this is a safety critical system, specifically required to work in a dead ship condition. Hardwired control systems are typically more reliable and generally more appropriate to operate on emergency (battery) power.

Provision is made for electronically controlled systems where they comply with the requirements of UR E22.

The requirement for the manufacturer to identify safety critical components of the winch emergency release system has been added to ensure that periodic survey of the equipment is focussed on the critical aspects – these may vary between different winch designs so it was considered inappropriate to include a prescriptive list of items in the UR.

### Section 4 – Test requirements

In considering the design of towing winches and their emergency release arrangements it was recognised that the release mechanism needs to be capable of operating at loads up to the maximum design load and this needs to be verified.

A requirement has therefore been included to this effect. It is intended that verification would initially be undertaken by the winch design authority/manufacturer through testing to the extent that it is reasonably practicable. In this, it is recognised that there may be circumstances where testing of the complete winch system to achieve this may not be possible (e.g. due to health and safety requirements). Consequently, an allowance has been made that in such circumstances, a combination of methods may be used to verify that the winch emergency release is capable of operating at 100% of the maximum design load, (possibly by separate testing of certain components of the release system or through testing to validate a model).

It is noted that ISO 7365 allows for verification of the holding load based on theoretical calculation. It was considered inappropriate to provide for a more specific set of acceptance criteria due to the wide range of variables previously discussed.

For reference regarding alternative means of verification, please see the definitions below taken from the INCOSE systems engineering handbook:

**Inspection:** an examination of the item against applicable documentation to confirm compliance with requirements. Inspection is used to verify properties best determined by examination and observation (e.g., - paint colour, weight, etc.).

**Analysis:** use of analytical data or simulations under defined conditions to show theoretical compliance. Used where testing to realistic conditions cannot be achieved or is not cost-effective. Analysis (including simulation) may be used when such means establish that the appropriate requirement, specification, or derived requirement is met by the proposed solution.

**Demonstration:** a qualitative exhibition of functional performance, usually accomplished with no or minimal instrumentation. Demonstration (a set of test activities with system stimuli selected by the system developer) may be used to show that system or subsystem response to stimuli is suitable,. Demonstration may be appropriate when requirements or specifications are given in statistical terms (e.g., mean time to repair, average power consumption, etc.).

**Test:** an action by which the operability, supportability, or performance capability of an item is verified when subjected to controlled conditions that are real or simulated. These verifications often use special test equipment or instrumentation to obtain very accurate quantitative data for analysis.

### **3. Source / derivation of the proposed IACS Resolution**

- Existing IACS members Rules
- Industry body codes of practise
- IS Code

### **4. Summary of Changes intended for the revised Resolution**

None

### **5. Points of discussions or possible discussions**

It was noted by one member that the use of the term 'emergency release' as opposed to 'quick release' could cause confusion as most towing winches have only one release mechanism. Although the distinction between "(operational) quick release" and "emergency (quick) release" can be understood theoretically, its practical value is questionable. In this respect it was considered that referenced IS Code requirement (Ch 2, para 2.4.3.4) for providing means for quick release (with proposed amendment by SDC 3) actually refers to "emergency (quick) release" within the context of the UR (the objective of the IS Code is safety and this is how it was perceived by the SDC working group). Once the update to the IS Code is complete it may be prudent to reference the incorporated SDC 3 amendments.

The methods of verification for the performance requirements were discussed, with potential for load testing OR a combination of load testing and other analysis added at the request of one member.

This UR was developed specifically for tugs (and towing winches) used for close quarters towing operations. In recognising that the vessel types, winch types and modes of operation (e.g. towing line lengths) used for ocean towage are usually different to those for close quarters work, it is suggested that further expansion on existing requirements for ocean towing either in the UR or another document could be proposed as follow-on work.

Consideration was given to cases where the tug/towing arrangement was such that girting was not possible, in such a case it may be possible to relax the emergency release arrangements. However for this to be done further discussion would be necessary if prescriptive criteria were to be included in the requirements. In light of the wide range of ship design and winch types and configurations, and the scenarios under which they might be used, the development of criteria to address all possible scenarios would involve significantly greater investigation and further development work.

The link between maintenance and efficiency of the equipment and the operation of the emergency release was discussed, initially requirements were included that required that the towing arrangement was maintained to ensure that as much of the towline force as possible was transferred to the winch. This was initially included following findings from the Flying Phantom incident which indicated that the excess friction added to the system where the towline was led around a sharp radius of a bow shackle attached to the gog line may have substantially reduced the load applied to the winch. This may have inhibited the operation of the emergency release, preventing the towline from being paid out sufficiently quickly to stop the tug from girting. However it was decided that this was an operational issue that is outside the remit of Class so was removed from the UR.

## **6. Attachments if any**

None

## Technical Background (TB) document for UR M79 (Rev 1, Feb 2020)

### 1. Scope and objectives

To revise the UR M79 (New, Oct 2018) in order to solve some requests for clarification raised by some winch manufacturers and shipyards via one member of the Machinery Panel and to solve an issue raised by the Survey Panel.

### 2. Engineering background for technical basis and rationale

The Machinery Panel decided to revise the UR M79 (New, Oct 2018) after consideration of the following questions raised by some winch manufacturers and shipyards:

#### Question 1

Regarding paragraphs 3.1.4 and 3.1.6 (dead-ship condition requirement) of UR M79, it was found necessary to confirm whether the towline force can also be utilized to “allow the winch drum to rotate” as specified in paragraph 3.1.4.

In this regard it was confirmed that the existing phrase in the 1<sup>st</sup> sentence of paragraph 3.1.4 “The emergency release system is to allow the winch drum to rotate and the towline to pay out” is sufficient to be read that the towline force can also be utilized to “allow the winch drum to rotate” and therefore no amendment was considered necessary to improve clarity.

#### Question 2

Regarding the scope of application of dead-ship condition requirement (i.e. the definition of “Emergency release system”, and paragraphs 3.1.6 and 3.1.7), it was found necessary to confirm whether ships not necessary to have capability as mentioned in SOLAS regulation II-1/26.4 (i.e. non-SOLAS ships) need do comply with these paragraphs.

In this regard it was confirmed that the requirements concerned apply also to non-SOLAS ships but the wording “dead-ship” was found inappropriate and therefore changed to “blackout” in paragraphs 3.1.6 and 3.1.7 as well as in the definition of emergency release system.

#### Question 3

Regarding the scope of application of UR M79 (i.e. paragraph 1.1) it was found necessary to confirm whether the requirements of UR M79 would need to be applied to ships designed not to carry out operation involving transverse towage and an IACS Member proposed to add the following sentence at the end of the paragraph:

“including those ships normally not intended for towing operation in transverse direction.”

At the 30<sup>th</sup> Machinery Panel meeting (17 to 20 September 2019), Members confirmed that the ships concerned (normally not intended for towing operation in transverse direction) also need to comply with the requirements of UR M79 taking into account that risks of transverse towing of such ships in an abnormal condition cannot be eliminated.

The text proposed above was therefore not included in paragraph 1.1.

In addition to the above, it was pointed out by the Survey Panel that:

- 1) regarding paragraph 3.2.10 of the UR M79 (New), there are no indication/requirements about the responsibilities for the preparation and the review/acceptance (or approval) of the procedure required in this paragraph; in the Survey Panel's opinion, these issues need to be clarified, and this paragraph could be considered to be absorbed into paragraph 4.1.3.

In this regard it was decided to move the existing paragraph 3.2.10 to section 4 as new paragraph 4.1.4 and to modify the requirement in order to specify that the Manufacturer need to document instructions for surveys of the emergency release system to be agreed by the Society and made available on board the ship on which the winch has been installed.

- 2) regarding paragraph 3.2.11 of the UR M79 (New), the Survey Panel recommended to move this paragraph into section 4 and to update the wording to include also 'Special Survey'.

### **3. Source / derivation of the proposed IACS Resolution**

/

### **4. Summary of Changes intended for the revised Resolution**

The following modifications have been introduced:

- 1) the wording "dead-ship" was modified to read "blackout" in paragraphs 3.1.6 and 3.1.7 as well as in the definition of emergency release system.
- 2) the text of paragraph 3.1.6 has been amended as follows to improve clarity:

"3.1.6 An alternative source of energy is to be provided such that normal operation of the emergency release system can be sustained under dead-ship conditions. Emergency release of the towline is to be possible in the event of a blackout. For this purpose, where additional sources of energy are required, such sources are to comply with 3.1.7."

- 3) the existing paragraph 3.2.10 has been moved to section 4 as new paragraph 4.1.4 reading as follow:

"4.1.4 Instructions for surveys of the emergency release system are to be documented by the manufacturer, agreed by the Society and made available on board the ship on which the winch has been installed."

In a similar manner, an indication "by the manufacturer" is added in paragraph 4.1.3 with also some minor editorial changes.

- 4) the existing paragraph 3.2.11 has been moved to section 4 as new paragraph 4.1.5 reading as follow:

"4.1.5 Where necessary for conducting the annual and special surveys of the winch, adequately sized strong points are to be provided on deck."

During the revision process the following additional modifications have been agreed:

- Paragraph 3.2.1 was amended to reflect the Panel's agreement that a position in close proximity to the winch should not be regarded as "safe location", unless it is documented that the position is at least protected against towline break or winch failure; the amended text read as follow:

"3.2.1 Emergency release operation must be possible from the bridge and from the winch control station on deck. The winch control station on deck is to be in a safe location. A position in close proximity to the winch is not regarded as "safe location", unless it is documented that the position is at least protected against towline break or winch failure."

- Paragraph 3.2.2 was amended to reflect the Panel's agreement that installation of an emergency stop button for winch operation is not mandatory; the amended text read as follow:

"3.2.2 The emergency release control is to be located in close proximity to the an emergency stop button for winch operation, if provided, and both should shall be clearly identifiable, clearly visible, easily accessible and positioned to allow safe operability."

## **5. Points of discussions or possible discussions**

None

## **6. Attachments if any**

None

## UR M80 “Requirements for the AC Generating sets”

### Summary

This UR provides requirements for the AC Generating sets (prime movers, alternators and couplings) in addition to those required in UR M51, UR M3, UR E13 and UR M53.

### Part A. Revision History

Version no.	Approval date	Implementation date when applicable
New (May 2019)	15 May 2019	1 July 2020

- **New (May 2019)**

**.1 Origin for Change:**

- Other (External Query raised through IACS member)

**.2 Main Reason for Change:**

To develop IACS requirements for the AC generating sets (i.e. prime movers, alternators and couplings) in addition to those required in UR M51, UR M3, UR E13 and UR M53.

**.3 List of non-IACS Member Classification Societies contributing through the TC Forum and/or participating in IACS Working Group:**

None

**.4 History of Decisions Made:**

- Draft UR submitted to GPG under 19072\_PMa

**.5 Other Resolutions Changes**

None

**.6 Any hinderance to MASS, including any other new technologies:**

None

**.7 Dates:**

Original Proposal: February 2017 Made by: Machinery Panel  
 Panel Approval: 3 April 2019 (Ref: PM16902bIMj)  
 GPG Approval: 15 May 2019 (Ref: 19072\_IGc)



## **Part B. Technical Background**

List of Technical Background (TB) documents for UR M80:

Annex 1. **TB for New (May 2019)**

See separate TB document in Annex 1.



## **Technical Background (TB) document for UR M80 (New, May 2019)**

### **1. Scope and objectives**

The objective is the development of requirements for the AC Generating sets (i.e. prime movers, alternators and couplings) in addition to those required in UR M51, UR M3, UR E13 and UR M53.

### **2. Engineering background for technical basis and rationale**

Following an external query associated with the transient voltage response limitation (when applying the two load steps to maximum power loading), it was recognised that there were neither specific IACS requirements for testing an Engine and an Alternator together nor which included the coupling, where installed.

After discussion and based on a qualified majority, it was concluded that new requirements for AC generating sets were to be developed covering torsional vibration, coupling selection criteria, power requirement, rating plate for generator sets and testing requirements associated with engine and alternator.

### **3. Source/derivation of the proposed IACS Resolution**

- External query raised through IACS member.
- ISO 8528-1:2018 "Reciprocating internal combustion engine driven alternating current generating sets -- Part 1: Application, ratings and performance"
- ISO 8528-5:2018 "Reciprocating internal combustion engine driven alternating current generating sets -- Part 5: Generating sets"

### **4. Summary of Changes intended for the revised Resolution:**

New requirements for AC generating sets have been developed to cover torsional vibration, coupling selection criteria, power requirement, rating plate for generator sets and testing requirements associated with engine and alternator; it was finally decided that these fit better in a new UR addressing AC generating sets than in a revised UR M3.

### **5. Points of discussions or possible discussions**

The requirements for AC generating sets have been developed based on the international standards ISO 8528-1:2018 and ISO 8528-5:2018. During the discussion, the following items have been further considered.

#### **1. Coupling**

- Members had different opinion for consideration issues for coupling selection. Several members had concerned the requirement in the clause 15.9 of ISO 8528-5:2018 is too heavy. In this reason, the provision has been developed by the vote.

#### **2. Cyclic irregularity**

- The cyclic irregularity had been dropped by decision of qualified majority and replaced by frequency cyclic variations with the criterion according to IEC 60092-101:2018. Due to the lack of test method, however, the majority have agreed to delete a relevant provision for frequency cyclic variation.

### 3. Rating plate

- One member had proposed and been accepted that the generating sets which is the rated power with the prefix ESP as defined in ISO 8528-1:2018 shall be restricted to use on board. Because it means that the generating sets has a limited continuous power and no overload possibility.
- One member had proposed not to apply the performance class which is required in ISO 8528-5:2018 taken into account the consistency for requirements of the published UR E5 and E13. The required performance class in ISO 8528-5:2018 is stricter than the published resolution which had developed based on IEC standards. And the proposal have been accepted by the majority.
- One member had proposed to only require the rated power without the prefixes at rating plate. The proposal has not been accepted by the majority.

### 4. Coupling selection (paragraph 2.2 of the UR):

- A) During the discussion regarding the coupling selection for the generating set it emerged that the selection shall take into account the stresses and torques imposed on it by the torsional vibration of the system which is influenced by but not limited to the following:
- a) operation up to Reciprocating Internal Combustion (RIC) engine fuel stop power as defined in ISO 15550:2016, paragraph 3.3.6;
  - b) the inertia of the RIC engine and alternator;
  - c) the short-circuit torque;
  - d) misalignment;
  - e) RIC engine misfiring, as defined in UR M53.2.2.2

After consideration of this paragraph the qualified majority decided not to include in the UR the items listed from a) to e) (including the sentences in square brackets which were proposed by a Member).

- B) One Member proposed to require the submission for approval to Class Societies of the torsional vibration calculations when the engine power is 110 kW or above. After discussion, the qualified majority of Panel Members agreed with the proposal.
- C) One Member noted that a threshold for submission of torsional vibration calculations may be against the requirements in UR M53.2.2.2; alignment of UR M53 will be considered separately.

### 6. Attachments if any

N/A

## **UR M81 “Safety measures against chemical treatment fluids used for exhaust gas cleaning systems and the residues which have hazardous properties”**

### **Summary**

The subject UR provides minimum technical requirements for exhaust gas cleaning systems using chemical treatment fluids and the residues which have hazardous properties.

### **Part A. Revision History**

<b>Version no.</b>	<b>Approval date</b>	<b>Implementation date when applicable</b>
Rev.1 (July 2023)	28 July 2023	1 July 2024
New (Jan 2021)	21 January 2021	1 July 2022

#### **• Rev.1 (June 2023)**

##### **1 Origin of Change:**

- Suggestion by IACS member

##### **2 Main Reason for Change:**

Following recent reports of corrosion incidents in the EGCS discharge lines of washwater, particularly in distance pieces, IACS decided to amend UR M81 to add requirements for such discharge lines.

##### **3 List of non-IACS Member classification societies contributing or participating in IACS Working Group:**

None.

##### **4 History of Decisions Made:**

The revised UR was developed and agreed by correspondence within the panel.

##### **5 Other Resolutions Changes:**

None.

##### **6 Any hinderance to MASS, including any other new technologies:**

None.

## **7 Dates:**

Original Proposal : 1 February 2021 (Made by: Machinery Panel)  
Panel Approval : 20 June 2023 (Ref: PM20306aIMi)  
GPG Approval : 28 July 2023 (Ref: 18158aIGc)

## **• New (Jan 2021)**

### **1 Origin of Change:**

- Suggestion by IACS member

### **2 Main Reason for Change:**

None.

### **3 List of non-IACS Member classification societies contributing or participating in IACS Working Group:**

None.

### **4 History of Decisions Made:**

According to an IACS member, there is a trend to fit on board an increasing number of exhaust gas cleaning systems (EGCS) to ensure compliance with the 2020 global sulphur cap, due to operators' concern on quality and/or cost of low-sulphur (0.5% m/m) fuel oil. Also, taking into account of it, the necessity of developing new UR for EGCS was proposed based on IACS UR M77 for SCR systems.

As a result of the discussion, the above proposal was unanimously agreed.

### **5 Other Resolutions Changes:**

None.

### **6 Any hinderance to MASS, including any other new technologies:**

None.

## **7 Dates:**

Original Proposal: 15 December 2017 (Ref: PM17909\_IMa)  
Panel Approval: 10 December 2020 (Ref: PM17909\_IMv)  
GPG Approval: 21 January 2021 (Ref: 18158\_IGb)

\*\*\*\*\*

## **Part B. Technical Background**

List of Technical Background (TB) documents for UR M81:

Annex 1. **TB for New (Jan 2021)**

See separate TB document in Annex 1.

Annex 2. **TB for Rev.1 (July 2023)**

See separate TB document in Annex 2.

## Technical Background (TB) document for UR M81 (New Jan 2021)

### 1. Scope and objectives

The objective of this task is to develop requirements for storage and use of chemical treatment fluid such as the aqueous solution of sodium hydroxide (NaOH) or calcium hydroxide (Ca(OH)<sub>2</sub>) in exhaust gas cleaning systems (EGCS) in order to mitigate the hazards to personnel brought by the use of such systems.

### 2. Engineering background for technical basis and rationale

In IACS UR M77, the requirements for storage and use of reductants (such as Marine NO<sub>x</sub> reduction agent) in selective catalytic converters were developed. In recent years, the number of projects to fit EGCS on ship for compliance with the 2020 global sulphur CAP was increasing. In the EGCS, chemical treatment fluids such as the aqueous solutions of sodium hydroxide (NaOH) or calcium hydroxide (Ca(OH)<sub>2</sub>) were used rather than urea solutions. For this reason, taking into account of the characteristic of the EGCS, the need for a new UR regarding such chemical treatment fluids used in EGCS was recognized.

The chemical treatment fluids are considered to have hazardous property and be typically carried on board in bulk quantities like urea. So, the requirements in this UR were based on UR M77. On the other hand, further discussion was held and, as a result, additional requirements were specified as follows:

Kind of chemical treatment fluids:

In this UR "chemical treatment fluids" means the aqueous solutions of NaOH and Ca(OH)<sub>2</sub> which are widely used in EGCS. Other aqueous solutions such as magnesium hydroxide (Mg(OH)<sub>2</sub>) were not considered common for marine use, so it was only specified that, if such fluids are used in EGCS, safety measures are to be taken according to the result of a risk assessment.

Temperature alarms for storage tanks:

In cases where heating and/or cooling system is provided depending on the operational area, high and/or low temperature alarm is required to prevent the fluid temperature from becoming too high or low. In addition, it is considered that the temperature monitoring can obtain the equivalent or more information as the high/low temperature alarms, so the temperature monitoring was specified together.

Strength of the storage tanks:

It is considered that the storage tanks are to have sufficient strength against a pressure of the fluids and the density of the aqueous solution is larger than that of water. Therefore, considering the cases of water/oil tanks' strength, the above pressure is to be corresponding to the maximum height of a fluid column in the overflow pipe, with an additional height to the top plate taking into consideration the specific density of the treatment fluid. The height of 2.5m above the top plate for the pressure test, proposed by a Member that opined this height was based upon the industry practice for testing independent fuel oil tanks, was changed to 2.4m, taking into account Hull Panel's comments.

Ventilation requirements for the compartment in which the storage tank is not installed:

Even a compartment doesn't contain the storage tank, the ventilation requirements are to be applied to such spaces in cases where there are any possible leak points (e.g. manhole, fitting).

Prevention of the spread of any spillage from piping and connections:

Considering the hazardous properties of the chemical treatment fluids, it is specified that the piping systems are to comply with the requirements applicable to Class 1 piping systems and be joined by welding, and that detachable connections are to be screened and fitted with drip trays.

Tanks for residues:

The residues generated from the exhaust gas cleaning process is considered to be stored in a dedicated tank but it isn't considered dangerous to be stored in the overflow tanks for chemical treatment fluids storage tank. For the capacity of such tanks it is to be decided in consideration of the number and kinds of installed exhaust gas cleaning systems as well as the maximum number of days between ports where residue can be discharged ashore referring to other requirements of MARPOL.

### **3. Source/derivation of the proposed IACS Resolution**

IACS UR M77

### **4. Summary of Changes intended for the revised Resolution:**

None

### **5. Points of discussions or possible discussions**

Drip trays:

The aqueous solution of NaOH does not smell and appears/behaves like water, containment of leaks is thus vital for the safety of the crew, so closed drip trays (e.g. splash proof cabinets with integrated spill tray) are considered to be required for detachable connections of piping system containing the fluid. On the other hand, it is considered that an open drip tray is also acceptable provided that a screen is properly arranged and the spray is guided to the drip tray without scattering around.

Minimum sets of personnel protective equipment:

Although 3 sets is considered to be a safer number (in case one person using one set needs to be evacuated by two persons), the number of sets is based on ship's operation and owner's decisions. So, the minimum required number was specified as 2 sets.

Requirements for washwater:

Keeping in mind the recent damages on discharge piping of washwater, requirements for such piping should be further considered.



EGCS effluent line specified in UR P4:

UR P4(Rev.5) provides fire endurance requirements of plastic pipes used for EGCS effluent line. On the other hand, it was agreed that said line is not considered "chemical treatment fluid piping system" mentioned in this UR Mxx. Therefore, fire endurance requirements of plastic pipes used for "chemical treatment fluid piping system" should be further considered.

Requirements of IBC Code:

Chapter 17 of IBC Code as amended by IMO Resolution MSC.460(101) provides minimum requirements for ships carrying sodium hydroxide solution and calcium hydroxide slurry. Considering the toxicity of such chemicals, it should be further considered if said requirements are to be applied to storage tanks of chemical treatment fluid, especially requirements of tank vents, gauging, vapour detection, and specific and operational requirement (column g, j, k, and o).

Requirements for materials of pipes/piping systems

During the latest rounds of discussion, the requirement below was considered. The texts of the underlined two sets of square brackets were not accepted for the Original version of this UR, but this requirement should be reviewed during discussion of an amendment to UR M77 paragraph 2.9 in order to avoid leaving the requirement below outdated.

2.10 Storage tanks and pipes/piping systems for chemical treatment fluids [which transfer undiluted chemical treatment fluids] are to be of steel[ or other equivalent][or other equivalent material acceptable to the Classification Society].

## **6. Attachments if any**

None

## **Technical Background (TB) document for UR M81 (Rev.1 July 2023)**

### **1. Scope and objectives**

The scope is the revision of the UR M81 (New, Jan 2021) to develop the requirements for discharge lines.

### **2. Engineering background for technical basis and rationale**

The EGCS discharge line is known to be affected by corrosion, and several cases of corrosion incidents have been reported to the member society. In particular, corrosion of the overboard distance pieces installed on the hull shell plating leads to flooding of the engine room, which has necessitated the establishment of requirements for the thickness and materials of such distance pieces.

First, the distance piece must be made of steel, not plastic (GRE, etc.). Since bare carbon steel is affected by corrosion, it was decided to require protection such as sleeves and coatings. Moreover, even if such protection is provided, it is recognized that the thickness of the pipe needs to be increased in case corrosion occurs, and some members have already implemented the requirement to use pipes with minimum thickness of 15 mm or pipes of sch.160 (the largest thickness of piping standards) in their class rules and, then, it is understood that this has become an accepted minimum limit in the industry. Similarly, for distance pieces made entirely of corrosion-resistant steel instead of sleeves and coatings, a minimum thickness of 12 mm is accepted. In other words, if there is no pipe in the piping standards that have the minimum thickness of 12 mm/15 mm, it is necessary to use the tube with the maximum thickness.

Alternatively, to use the pipe of Sch.160.

#### **2a. Specification of the data utilised in the development/revision of the proposed IACS Resolution, if any**

None

### **3. Source/derivation of the proposed IACS Resolution**

None

### **4. Summary of Changes intended for the revised Resolution:**

M81.2.3: The closed compartment where a storage tank for chemical treatment fluids is installed shall have an independent ventilation system. This requirement has been amended to simplify.

M81.2.4: Among the requirements of M81.2.3, the requirements that should be applied in this clause are clarified. In addition, Wording is revised with reference to UR M77.2.4.

M81.3: The requirements for discharge lines are newly added.

### **5. Points of discussions or possible discussions**

Warning Notice:

There was an opinion that the warning notice, requiring the use of such ventilation before entering the compartment, is not necessary for the engine room since the engine room is a well-ventilated space.

Relevant industry standards:

IACS is aware that there is a activity to establish standards for EGCS discharge line in an industry associations. After the publication of this standard, this UR may also be reviewed.

**6. Attachments if any**

None

# UR M82 “Type Testing Procedure of Explosion Relief Devices for Combustion Air Inlet and Exhaust Gas Manifolds of I.C. Engines Using Gas as Fuel”

## Summary

This UR provides test requirements for pressure relief systems on air inlet and exhaust gas manifolds of internal combustion engines using gas as fuel.

## Part A. Revision History

Version no.	Approval date	Implementation date when applicable
New (Mar 2023)	08 March 2023	1 July 2024

### • New (Mar 2023)

#### 1 Origin of Change:

- Suggestion by IACS member

#### 2 Main Reason for Change:

Triggered by a member in response to varying practices by industry.

#### 3 List of non-IACS Member classification societies contributing through the TC Forum and/or participating in IACS Working Group:

None

#### 4 History of Decisions Made:

Agreed Form A was submitted to GPG by 19048\_PMa dated 7 March 2019.

#### 5 Other Resolutions Changes:

None

#### 6 Any hinderance to MASS, including any other new technologies:

None

#### 7 Dates:

Original Proposal : 28 October 2019 (Ref: PM18914aIMh)  
 Panel Approval : 12 December 2022 (Ref: PM18914aIMv)  
 GPG Approval : 08 March 2023 (Ref: 19048\_IGe)

## **Part B. Technical Background**

List of Technical Background (TB) documents for UR M82:

Annex 1. **TB for New (Mar 2023)**

See separate TB document in Annex 1.

## **Technical Background (TB) document for UR M82 (New Mar 2023)**

### **1. Scope and objectives**

To specify type testing procedure for explosion relief devices (ERDs) for combustion air inlet manifold and exhaust gas manifold of internal combustion engines using gas as fuel.

### **2. Engineering background for technical basis and rationale**

A failure or malfunction of any system or component involved in the gas operation of the engine may lead to a gas accumulation and a possible explosion in the combustion air inlet and exhaust gas manifold. M78.2.1.2 specify design requirements in this respect: Components containing or likely to contain gas are to be designed to mitigate the consequences of a possible explosion to a level providing a tolerable degree of residual risk, due to the strength of the component(s) or the fitting of suitable pressure relief devices of an approved type. The type testing procedure for the ERD is given by this UR. Suitability is assessed in terms of function and mechanical integrity of the ERD as well as the function of the flame arrestor.

The arrangement of the ERDs on the engines (required relief area, type, number and positions of the ERDs) based on the risk analysis required in M78.1.4 is part of the engine's approval and not subject of this UR.

### **3. Source/derivation of the proposed IACS Resolution**

IACS UR M78 (July 2018), Safety of Internal Combustion Engines Supplied with Low Pressure Gas

IACS UR M66 (Jan 2008), Type Testing Procedure for Crankcase Explosion Relief Valves

### **4. Summary of Changes intended for the revised Resolution:**

None

### **5. Points of discussions or possible discussions**

ERD – explosion relief device

#### 1 Scope

The general phrase "combustion air" covers all common phrases for 2- and 4-stroke engines, like scavenge air or charge air.

It was decided that extending the scope of this UR Mxx to ERDs installed downstream of the turbocharger would be considered after amendment of the UR78.

## 2 Definitions

This UR is a testing procedure for any kind of ERDs. No design requirements are specified. Functional requirements are:

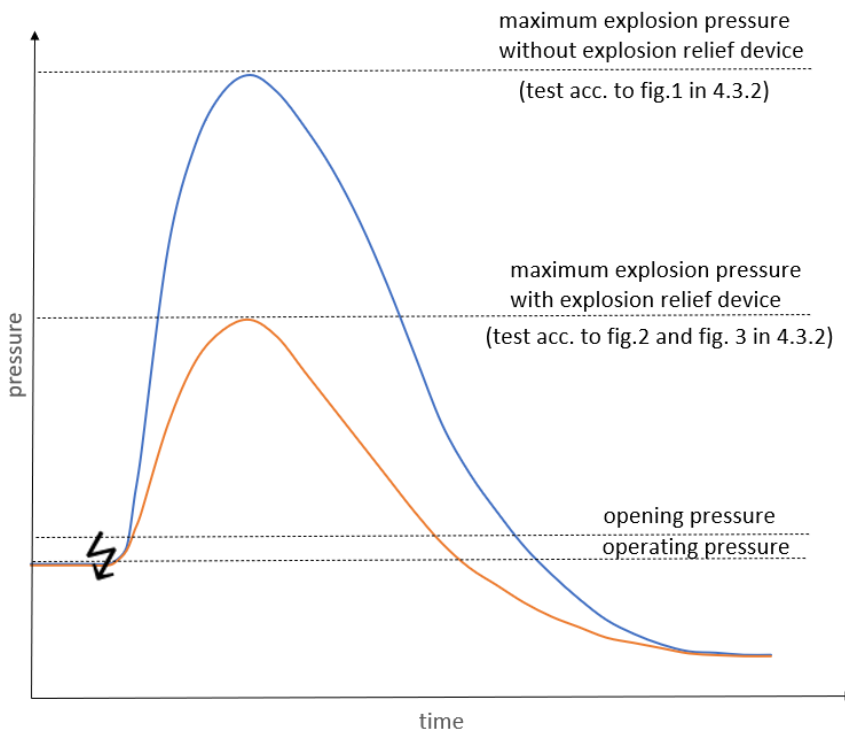
- pressure relief against a determined overpressure
- flame less pressure relief

Furthermore, the following topics are not subject of this UR:

- the arrangement and number of the ERDs on the engine
- used kind of the ERD (valve or rupture disc) for single or multi engine plants

## 3 Documents

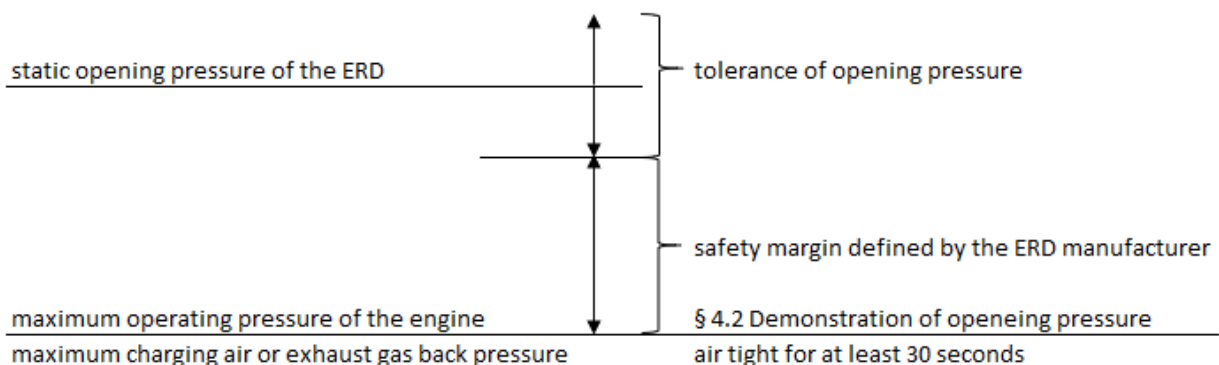
### Definition of pressures



The “maximum explosion pressure with explosion relief device” is usually designated as “reduced maximum pressure ( $p_{\max \text{ red}}$ ). “Reduced” means compared with the explosion pressure without explosion relief device

### 4.2 Demonstration of opening pressure

#### Definition of pressures



#### 4.3.2 Test vessel

Pipe shape: The definition of the pipe shape,  $L/D \geq 10$  is in accordance with EN14994.

Relief area: A ratio between the relief area of the ERD and the test vessel volume is needed for realistic test conditions and comparison of different tests. The ratio of  $700 \text{ cm}^2/\text{m}^3$  is in accordance with API 618, Reciprocating Compressors for Petroleum, Chemical, and Gas Industry Services. It is to be noted, this value is not a requirement for the arrangement and number of ERDs on the engine. This is basically different to the crankcase explosion relief valves with  $155 \text{ cm}^2/\text{m}^3$  are given for testing in M66 and arrangement in M9.

Simulation of turbocharger: The air inlet and exhaust gas manifolds are not closed vessels. A rupture disc shall represent all openings, e.g. turbocharger and by-pass. This is a simplified model to simulate the leakage from the openings and the consequent reduction of the internal pressure of the manifolds, by rupturing the rupture disc during explosion tests (i.e. reference and ERD tests).

#### 6. Assessment

The maximum explosion pressure of the ERD is to be observed at the arrangement calculation (numbers and locations of ERDs at the engine) later on.

#### **6 Attachments if any**

None



## UR M83 “Testing of the Control System of Controllable Pitch Propellers intended for Main Propulsion”

### Summary

This UR provides requirements for the testing of the control system of controllable pitch propellers intended for main propulsion.

### Part A. Revision History

Version no.	Approval date	Implementation date when applicable
NEW (October 2023)	30 October 2023	01 January 2025

#### • New (October 2023)

##### 1 Origin of Change:

- Suggestion by IACS member further to questions raised by industry on UR M25 (Rev.4)

##### 2 Main Reason for Change:

During the development of draft UR M25 Rev.4, it was pointed out that UR M25 scope was "Astern power for main propulsion" and did not refer to CPP. Accordingly, it was decided to develop a specific UR to cover the testing of CPP control systems.

##### 3 List of non-IACS Member classification societies contributing or participating in IACS Working Group:

None.

##### 4 History of Decisions Made:

The decision to issue this new UR was taken by the Panel in October 2020.

##### 5 Other Resolutions Changes:

None.

##### 6 Any hinderance to MASS, including any other new technologies:

None.

**7 Dates:**

Original Proposal	: October 2020	(Made by the MP member:PM18103a)
Panel Approval	: October 2023	(Ref: PM18103aIMk)
GPG Approval	: 30 October 2023	(Ref: 19026aIGb)

\*\*\*\*\*

## **Part B. Technical Background**

List of Technical Background (TB) documents for UR M83:

Annex 1. **TB for New (October 2023)**

See separate TB document in Annex 1.

## **Technical Background (TB) document for UR M83 (New October 2023)**

### **1. Scope and objectives**

To specify the requirements for the testing of the control system of controllable pitch propellers intended for main propulsion.

### **2. Engineering background for technical basis and rationale**

The technical background for this UR has been derived from the engineering knowledge gained by members on CPP control systems.

#### **2a. Specification of the data utilised in the development/revision of the proposed IACS Resolution, if any**

None.

### **3. Source/derivation of the proposed IACS Resolution**

- UR M25 (Rev.4): Astern power for main propulsion
- UR Z18 (Rev.9): Survey of Machinery, § 4 (Machinery Verification Runs)

### **4. Summary of Changes intended for the revised Resolution:**

None (new version).

### **5. Points of discussions or possible discussions**

Some members were of the opinion that the UR should cover astern orders only. During the ensuing discussion, it was reminded that the origin of task PM18103a was the failure of CPP control system of cargo ship Saffier, for which MAIB Report recommended *"to [...] introduce a unified requirement for controllable pitch propeller systems to be subjected to a full range of tests in both ahead and astern directions during commissioning trials of new and existing systems"*. It was finally agreed that the UR should cover both astern and ahead orders.

One member argued that it was not necessary to carry out the tests from all control positions as there are no differences in the power or functions of the propulsion system even if the control changes. This was found acceptable by the Panel, and it was decided to reflect it by introducing the following text in the UR:  
*"Tests that are not affected by the control position may be carried out from one control position only."*

One member suggested that a test of the fail-to-safe characteristics of the propeller pitch control system should be carried out to demonstrate that failures in the pitch command or feedback signals are alarmed and do not cause any change of thrust. This was agreed upon by the Panel.

As regards the “emergency operating conditions” referred to in with respect to paragraph § 3.1 of the UR, it should be noted that the emergency control from the bridge is not required, but may be arranged in addition to, and independent of, the normal control by the propulsion remote control system. However, the emergency operating condition test to be carried out at “local emergency control station” and from bridge emergency control when additionally arranged.

One member raised comments about the clarification of method and purpose for the recording of parameter “propelling thrust variation” in Para.3 on the basis of existing text with no criteria and no test procedure related to “Significantly altered” in Para.4. In addition, same member raised a view about the "Tests are to be demonstrated that the propelling thrust is not significantly altered when transferring control from one location to another one." in Para.4 that the significant alteration should be acceptable when transferring the control location from remote location (e.g. navigation bridge) to engine room with respect to prioritizing the safety of the ship over the safety of the engine considering emergency situations (e.g. risk of collision or running aground) when such transferring.

Draft UR document reviewed by SuP with a comment from one of their member as; “The surveyor may accept the test plan to be implemented under the condition of no propeller-running-test considering the scope of modification or extent of repair/re-adjustment of a control system for existing ships”. Accordingly, MP members confirmed and agreed to adopt and reflect the SuP member comment on clause 3.3 of UR.

## **6. Attachments if any**

None.

## UR M84 “Capacity and availability of compressed air for essential services”

### Summary

This UR provides requirements for the capacity and availability of compressed air required by systems, machinery and equipment providing essential services. The UR was considered necessary in order to ensure that sufficient compressed air capacity, in addition to the required starting air capacity, is ensured at all times where compressed air is essential for normal operation of the propulsion system.

### Part A. Revision History

Version no.	Approval date	Implementation date when applicable
New (February 2024)	22 February 2024	01 July 2025

- **New (February 2024)**

#### 1 Origin of Change:

- Suggestion by IACS member

#### 2 Main Reason for Change:

None.

#### 3 List of non-IACS Member classification societies contributing or participating in IACS Working Group:

None.

#### 4 History of Decisions Made:

New work item was proposed during the 37th Machinery Panel meeting and subsequently agreed as a new task by Machinery Panel members. Form A submitted to GPG on 16 June 2023 and subsequently approved. The final draft was sent to GPG on December 2023 together with the HF and TB and the Human Element Checklist.

#### 5 Other Resolutions Changes:

UR M61.1.5 (to be considered)

#### 6 Any hinderance to MASS, including any other new technologies:

None.

**7 Dates:**

Original Proposal	: 20 March 2023	(Made by: PM23200_IMa)
Panel Approval	: 04 December 2023	(Ref: PM23200_IMi)
GPG Approval	: 22 February 2024	(Ref: 23100_IGe)

## **Part B. Technical Background**

List of Technical Background (TB) documents for UR M84:

Annex 1. **TB for New (February 2024)**

See separate TB document in Annex 1.



## **Technical Background (TB) document for UR M84 (New)**

### **1. Scope and objectives**

The need for a new UR is considered necessary in order to ensure that sufficient LP air capacity, in addition to the required starting air capacity, is ensured at all times where LP air is essential for normal operation of the propulsion system.

### **2. Engineering background for technical basis and rationale**

Service feedback indicates that the onboard demand for LP compressed air has increased significantly in recent years, primarily due to the demand from SCR systems when fitted to engines but also, for certain dual fuel engine types, the demand from ventilation of the annular spaces of double wall piping for gas fuel lines.

Feedback has identified arrangements in which the increased LP air demand is supplied via single dedicated LP compressor (albeit with back-up connection to starting air reservoir) for which the maximum capacity of the LP air compressor is only marginally greater than the total LP air demand in normal operation.

Such arrangements mean that the LP compressor operates with a very high duty cycle (perhaps even continuously) and in the event of failure or during routine maintenance requires the LP air demand to be supplied by the starting air system in order to maintain propulsion. The starting air system may or may not be sized for the continuous supply of LP air in such circumstances.

### **2a. Specification of the data utilised in the development/revision of the proposed IACS Resolution, if any**

None.

### **3. Source/derivation of the proposed IACS Resolution**

Derivation of the UR is based on practical knowledge of IACS members and service feedback.

### **4. Summary of Changes intended for the revised Resolution:**

None.

### **5. Points of discussions or possible discussions**

Comment that clarification is needed with regards to 'low-pressure service air' and the 'sufficiency/capacity' requirement. Comment that although 'low-pressure service air' has been revised to 'low-pressure compressed air' this revision is insufficient as a clarification and that the scope of UR cannot be clarified without a definition such as 'less than 10 bar' or 'air system other than engine'. Comment that an alternative way is to focus on the purpose of compressed air such as compressed air for control or safety system if a definition of low-pressure cannot be provided.

In response to the comments, it was proposed to delete all references to 'low-pressure' and refer only to 'compressed air' and, as a result, to update the applicability statement in section 1 to clarify that the capacity and availability requirements in section 2 do not apply to compressed air for engine starting.

Comment regarding how to confirm and determine 'sufficient capacity'. Comment that clarification of 'sufficient' is necessary because without specific requirements such as UR M61.1.5, it is impossible to determine whether a ship meets this UR at the time of inspection.

In response to the comments, the word 'sufficient' in the UR clearly indicates that the low pressure compressed air demand for essential services onboard needs to be established and thereafter, the installed capacity needs to be capable of satisfying the demand. As such the compressed air capacity depends upon the overall demand from the individual items of equipment requiring compressed air for operation. Therefore, the demand, and therefore the capacity required to satisfy the demand, can only be determined by the ship designer/shipyard. It is therefore suggested that the ship designer/shipyard submits evidence to demonstrate that the compressed air capacity is sufficient to satisfy the compressed air demand under the conditions mentioned in 2.1 of the requirements of the draft UR.

Comment that the panel could not reach a consensus to define the essential service at the previous meeting (in relation to normal operation of the ship and safe operation of the ship as discussed under task PM23401) and therefore specific uses of compressed air should be identified instead of the expression 'essential services'. Comment that confirmation whether "essential service consumer" includes SCR operation, ventilation of double wall piping for gas fuel lines, etc.

In response to the comments, 'essential service consumers' was changed to read 'essential services' and essential services are considered to be fully addressed by UI SC134. It was intended that the 'essential services' are the same services 'essential for propulsion and steering, and safety of the ship' as currently interpreted by UI SC134. It is acknowledged that the scope of UI SC134 may change in future depending upon the outcome of the discussions within the panel for task PM 23401 however, currently, 'essential services' are as given in UI SC134.

Comment that the task was raised to address the low pressure air supply to SCR system and dual fuel engine although 'essential services' are mentioned in the UR and as such will include a fan or blower as well as a compressor, even though the fan or blower is generally not regarded as discharging compressed air. Comment that the UR may not be effective in addressing the air supply to SCR until the task considering the amendment of essential services (PM23401) is completed.

In response to the comments, the scope of the UR would not include fans or blowers since they are not generally regarded as discharging compressed air as stated and also as stated, at this point in time, the UR will be effective in ensuring the capacity and availability of compressed air for services essential for safety but not for normal operation.

Comment that it is allowed either to fit single LP air compressor continuously supplied from starting air system or to equip redundant LP air compressors with periodical supply from starting air system during maintenance or in the failure of dedicated LP air system and it is unlikely that Shipbuilders go with the latter case and therefore questions the

effectiveness of a new UR. Comment regarding clarification of when redundant arrangements are required.

In response to the comments, the UR does not intend to prescribe how redundancy is to be achieved allowing the designer flexibility e.g. the redundancy may be provided by additional air compressors, air receivers or cross connection to the engine starting air system. The wording proposed in the draft UR is deliberately 'goal based' and therefore allows the yard to propose different arrangements to meet the goal e.g. the installation of a single compressor with cross connection to the starting air system would be acceptable or the installation of redundant compressors with or without cross connection to the starting air system would be acceptable.

Comment that 'main' should be deleted from 'main engine starting air system' and UR M61.1.5 should be updated to reference the UR. Comment suggesting that air quality is addressed in the UR.

In response to comments, 'main deleted'. Consideration to given to setting up a new task or tasks to update UR M61.1.5 and to address compressed air quality following publication of the UR.

# IACS

INTERNATIONAL ASSOCIATION OF CLASSIFICATION SOCIETIES LTD.

PERMANENT SECRETARIAT: 4 Matthew Parker Street

Westminster, London SW1H 9NP, UNITED KINGDOM

TEL: +44(0)207 976 0660

INTERNET: [permsec@iacs.org.uk](mailto:permsec@iacs.org.uk) Web Site: [www.iacs.org.uk](http://www.iacs.org.uk)

---

March 2021

## History Files (HF) and Technical Background (TB) documents for URs concerning Navigation (UR N)

Res. No.	Title	Current Rev.	HF/TB?
UR N1	One man bridge operated (OMBO) ships	Deleted Mar 2021	HF

## UR N1 “One man bridge operated (OMBO) ships”

### Summary

A review of the contents of UR N1 concluded that the UR should be deleted as the majority of the requirements have been included in the other statutory instruments.

### Part A. Revision History

Version no.	Approval date	Implementation date when applicable
Del (Mar 2021)	25 March 2021	-
New (1992)	1992	1992

- **Del (Mar 2021)**

#### 1 Origin of Change:

- Suggestion by IACS member

#### 2 Main Reason for Change:

Following a detailed gap analysis and careful review, it was concluded that the contents of the UR are now contained in other statutory instruments and the UR could be deleted.

#### 3 List of non-IACS Member classification societies contributing or participating in IACS Working Group:

None

#### 4 History of Decisions Made:

Safety Panel agreed that UR N1 should be deleted in 2017.

GPG requested Safety Panel to review the decision (20081\_IGb).

A one-man project team was established (PT PS44/2020) to carry out a detailed gap analysis to determine the relevance of requirements in UR N1 in light of new and/or updated standards/instruments (see PT PS44/2020 Form A and Form 1).

The Safety Panel reviewed the outcome of the gap analysis and comments received from EG/MASS and unanimously concluded that UR N1 could be deleted.

#### 5 Other Resolutions Changes:

None

## 6 Any hinderance to MASS, including any other new technologies:

The basic principles relating to MASS have been taken into account when reaching the conclusion to delete UR N1.

## 7 Dates:

Original Proposal: 15 January 2021 (Made by: *PT PS44/2020*)  
Panel Approval: 9 March 2021 (Ref: PS17010pISo)  
GPG Approval: 25 March 2021 (Ref: 20081\_IGh)

- **New (1992)**

No details are available.

\*\*\*\*\*

## Part B. Technical Background

List of Technical Background (TB) documents:

Annex 1. **TB for Deleted (Mar 2021)**

See separate TB document in Annex 1.



**Note:** *There is no technical background document available for New (1992).*

## **Technical Background (TB) document for UR N1 (Del Mar 2021)**

### **1. Scope and objectives**

A detailed gap analysis was required to determine the relevance of requirements in UR N1 in light of new and/or updated standards/instruments.

To review UR N1 to assess the continuing relevance of the requirements taking into account:

Current SOLAS requirements  
Contents of IACS recommendation 95  
Updates to IEC standards  
Updates to ISO standards  
Updates to IACS E10

Other relevant documents developed since 1992 relating to bridge operations.

To list the UR N1 requirements and state if and where they are replicated in other instruments.

To determine extent of revision needed for UR N1.

### **2. Engineering background for technical basis and rationale**

In general most of the UR N 1 requirements are covered by other instruments, except for "OMBO Notation" and minor items. Therefore, it is recommended that the UR N 1 can be deleted as a result of this gap analysis between IACS UR N1 and other applicable instruments. For reference, requirements or parts of which are not possible to be covered by other instruments are highlighted in yellow in Appendix 1.

See Appendix 1 for the detailed gap analysis.

See Appendix 2 for the list of relevant instruments.

### **3. Source/derivation of the proposed IACS Resolution**

Not applicable

### **4. Summary of Changes intended for the revised Resolution:**

The whole of UR N1 is to be deleted.

### **5. Points of discussions or possible discussions**

The following points were taken into consideration during the review:



1. Paragraph 15 of STCW Code Part A Chapter VIII/2 still allows that the officer in charge of the navigational watch to be the sole look-out in daylight under certain conditions.
2. Based on the provisions in UR N1, some ships have been certified of relevant optional notations under individual class Society's rules for concerned classes to allow the sole look-out on ship's wheel house.
3. Since the adoption of UR N1, new navigational systems, e.g. AIS, ECDIS, BNWAS, etc., have been introduced under SOLAS Chapter V.

The detailed gap analysis (Appendix 1) details where each part of the UR has been superseded by other statutory requirements and is therefore no longer needed.

## **6. Attachments if any**

Appendix 1 – Gap Analysis.xlsx – the detailed paragraph by paragraph assessment of UR N1

Appendix 2 – Other relevant instruments since UR N1 (Nov 1992).docx – a list of relevant instruments.

## Appendix 1

Gap Analysis of IACS UR N 1			
Text (UR N 1)	Related instruments	Comment	Possible to be covered by other instruments (Yes/No)
<b>Part A-General</b>			
<p><b>Preamble</b></p> <p>It is technologically possible to operate the bridge with an officer of the navigational watch alone, acting as the sole lookout. However, the design, performance and maintenance of the equipment can have considerable effects on the safety of one man bridge operation.</p> <p>The aim of these rules is to provide technical requirements for the functionality of the bridge design and layout, the range of equipment to be installed, its performance and reliability.</p> <p>The composition and qualification of the personnel on watch remain the responsibility of the shipping companies and national authorities.</p>	N/A	General description	N/A
<b>1. Application</b>			
1.1. The following requirements apply to the classification of sea-going ships for the assignment of an optional class notation for one man bridge operation and are intended to cover all the normal sailing conditions as authorized by the relevant National Authority.	N/A	No other instruments for class notation for one man bridge operation	No
1.2 These requirements may be applied to new and existing ships.	N/A	N/A	N/A
<b>2. Operational Assumptions</b> The requirements are framed on the following assumptions:			
2.1 Plans for emergencies are specified and the conditions under which a one man watch is permitted are clearly defined in an operations manual, which is acceptable to the Administration with which the ship is registered.	<b>STCW Code Part A Chapter VIII/2</b>  16 ... The officer in charge of the navigational watch may be the <u>sole lookout in daylight</u> provided that, on each such occasion:	STCW allows OOW to sole lookout under normal operating daylight conditions.	Yes
2.2 The manning of the bridge watch is in accordance with the <b>National Regulations</b> in the country of registration and for the waters in which the ship is operating.	.1 the <u>situation has been carefully assessed and it has been established</u> without doubt that it is safe to do so; .2 full account has been taken of all relevant factors, including, but not limited to: – state of weather; – visibility; – traffic density; – proximity of dangers to navigation; and – the attention necessary when navigating in or near traffic separation schemes; and	General requirement	Yes
2.3 The requirements of the International Convention on Standards of Training Certification and Watchkeeping for seafarers ( <b>STCW</b> ) and other applicable statutory regulations are complied with.	and .3 assistance is immediately available to be summoned to the bridge when any change in the situation so requires.	N/A	Yes
<b>3. Regulations, Guidelines, Standards</b>			
3.1 IMO – The requirements are based on the understanding that the <b>applicable regulations and guidelines</b> issued by the International Maritime Organization are complied with and, in particular:	N/A	N/A	N/A
3.1.1 Regulation 12, chapter V of the 1974 "International Convention for the Safety of Life at Sea" ( <b>SOLAS</b> ) and applicable amendments;	N/A	SOLAS chapter V had been completely revised by Res.MSC.99(73) which entered into force on 1 July 2002 and this regulation moved to Regulation 19. It needs to be updated, if necessary.	N/A

3.1.2 the <b>international Regulations for Preventing Collisions at Sea</b> and all other relevant Regulations relating to Radiotelegraphy, Radiotelephony and Safety of Navigation required by Chapters <b>IV and V of SOLAS 1974</b> , as amended;	N/A	General requirement	N/A
3.1.3 the Provisional Guidelines for the Conduct of Trials in which the Officer of the Navigational Watch acts as the sole Lookout in Periods of Darkness ( <b>MSC Circular 566</b> of 2 July 1991);	N/A	Considering the result of MSC 66, it confirmed that these trials had been terminated in 1997. Therefore, it seems no more effective instrument.	N/A
3.1.4 <b>IMO Assembly Resolution A708</b> on Navigation Bridge Visibility and Functions;	N/A	Applicable IMO resolutions or circulars could be referred in Appendix 2.	N/A
3.1.5 the <b>Performance Standards for navigational equipment</b> applicable to: – magnetic compasses (Resolution A382), – gyro-compasses (Resolution A424), – radar equipment (Resolutions A222, A278, A477), – ARPA (Resolution A422), – speed and distance measuring equipment (Resolution A478) – echo sounding equipment (Resolution A224), – radio direction finder (Resolution A223), – electronic navigational aids – general requirements (Resolution A574), – VHF Radio installation (Resolution A609), – automatic pilots (Resolution A342), – rate-of-turn indicators (Resolution A526).	N/A	Since this UR released, applicable performance standards have been updated in accordance with SOLAS IV and V, as amended.  It needs to be updated referring to SOLAS IV/Reg.14 and V/Reg.18, if necessary.	N/A
3.2 <b>IEC, ISO Standards</b> – The requirements and guidelines of the following international standards are applicable: – ISO 8468 "Ships bridge layout and associated equipment – Requirements and guidelines"; – IEC 872: ARPA – Operational and performance requirements – Methods of testing and required test results; – IEC 936: Shipborne radar – Operational and performance requirements – Methods of testing and required test results; – IEC 1023: Marine speed and distance measuring equipment (SDME) – Operational and performance requirements – Methods of testing and required test results; – IEC Document 18 (Central Office) 534: Special features – Control and instrumentation.	N/A	Since this UR released, applicable international standards(ISO, IEC) have been updated.  Following standards may newly include in this para, but not limited to; (refer to Appendix 2) - ISO 14612 - IEC 60945 - IEC 61209 - IEC 61924 - IEC 60533	N/A
3.3 <b>National Authorities</b> – Additional requirements may be imposed by the National Authority with whom the ship is registered and/or by the administration within whose territorial jurisdiction it is intended to operate.	N/A	General requirement	N/A
3.4 <b>IACS</b> – The requirements of UR E10 'Unified environmental test specification for testing procedure for electrical control and instrumentation equipment, marine computers and peripherals covered by classification' are applicable.	N/A	UR E 10 rev.7 is in force.	N/A
<b>4. Definitions</b>			
Terms used in the requirements are defined below:			
Acquisition: the selection of those target ships requiring a tracking procedure and the initiation of their tracking.	N/A	General definition	N/A
Alarm: a visual and audible signal indicating an abnormal situation.	<b>Res.A.1021(26) Code on alerts and indicator, 2009</b> : Refer to 3.1.2 <b>MSC/Circ.982</b> : Refer to Appendix 1 "Definitions" <b>IACS Rec.95</b> : Refer to A.5.1 <b>ISO 8468</b> : Refer to 3.1.3	N/A	Yes
ARPA: automatic radar plotting aid.	<b>Resolution A.823(19)</b> <b>ISO 8468</b> : Refer to 3.2 Abbreviations	Commonly used definition in acronym. It is referenced in many instruments such as Performance standards.	Yes
Back-up navigator: any individual, generally an officer, who has been designated by the ship master to be on call if assistance is needed on the navigation bridge.	<b>MSC/Circ.566</b> <b>ISO 8468</b> : Refer to 3.1.6	N/A	Yes
Bridge: that area from which the navigation and control of the ship is exercised, including the wheelhouse and bridge wings.	<b>IACS Rec.95</b> : Refer to A.5.2 <b>ISO 8468</b> : 3.1.7	N/A	Yes
Bridge wings: those parts of the bridge on both sides of the ship's wheelhouse which, in general, extend to the ship's side.	<b>Res.A.468(12)</b> : Refer to 3.4.19 <b>IACS Rec.95</b> : Refer to A.5.2.1 <b>ISO 8468</b> : Refer to 3.1.13	Commonly used in various instruments.	Yes
CPA: closest point of approach, i.e. the shortest target ship-own ship calculated distance that will occur in case of no change in course and speed data.	N/A	Commonly used definition in acronym. It is referenced in many instruments such as IMO Resolutions and circulars.	N/A
Display: means by which a device presents visual information to the navigator, including conventional instrumentation.	<b>MSC/Circ.982</b> : Refer to Appendix 1 "Definitions" <b>ISO 8468</b> : Refer to 3.1.20		Yes

Ergonomics: application of the human factor in the analysis and design of equipment, work and working environment.	<u>MSC/Circ.982</u> : Refer to Appendix 1 "Definitions" <u>ISO 8468</u> : Refer to 3.1.25	General definition	Yes
Field of vision: angular size of a scene that can be observed from a position on the ship's bridge.	<u>MSC/Circ.982</u> : Refer to Appendix 1 "Definitions" <u>ISO 8468</u> : Refer to 3.1.27		Yes
Lookout: activity carried out by sight and hearing as well as by all available means appropriate in the prevailing circumstances and conditions so as to make a full appraisal of the situation and of the risk of collision.	<u>ISO 8468</u> : Refer to 3.1.32		Yes
Navigation: all tasks relevant for deciding, executing and maintaining course and speed in relation to waters and traffic.	<u>ISO 8468</u> : Refer to 3.1.38		Yes
Navigator: person navigating, operating bridge equipment and manoeuvring the ship.	<u>ISO 8468</u> : Refer to 3.1.41(operator)		Yes
Normal conditions: when all systems and equipment related to navigation operate within design limits, and environmental conditions such as weather and traffic do not cause excessive workload to the officer of the watch.	<u>ISO 8468</u> : Refer to 3.1.43		Yes
Officer of the watch: person responsible for safe navigating, operating of bridge equipment and manoeuvring of the ship.	N/A		N/A
OMBO: one man bridge operation.	<u>MSC/Circ.1014</u> Bridge Layout and Navigation Equipment	It was superseded by MSC.1/Circ.1598 resulting in deletion of OMBO	Yes
OMBO ship: one man bridge operated ship.	IACS Unified N1 requirements for One Man Bridge Operated (OMBO) Ships. International Association of Classification Societies. 1992		Yes
Radar plotting: the whole process of target detection, tracking, calculation of parameters and display of information.	<u>ISO 8468</u> : Refer to 3.1.46	General definition	Yes
Sea-going ship: ship navigating on the high seas, i.e. areas along coasts and from coast to coast.	<u>ISO 8468</u> : Refer to 3.1.50		Yes
TCPA: time to closest point of approach.	<u>Resolution A.823(19)</u>	Common definition in acronym. It is referenced in many instruments such as Performance standards.	Yes
Tracking: is the process of observing the sequential changes in the position of a target, to establish its motion.	<u>ISO 8468</u> : Refer to 3.1.55	General definition	Yes
Watch alarm: alarm that is transferred from the bridge to the master and the back-up navigator in case of any officer of the watch deficiency (absence, lack of alertness, no response to another alarm/warning, etc.).	N/A		N/A
Wheelhouse: enclosed area of the bridge.	<u>IACS Rec.95</u> ; Refer to A.5.2.4 <u>ISO 8468</u> ; Refer to 3.1.61		Yes
Workstation: position at which one, or several tasks constituting a particular activity are carried out.	<u>MSC/Circ.982</u> : Refer to Appendix 1 "Definitions" <u>IACS Rec.95</u> ; Refer to A.5.17 <u>ISO 8468</u> : Refer to 3.1.61		Yes
<b>Part B – Technical Requirements</b>			
<b>1. Bridge Layout</b>			
1.1 The <b>bridge configuration, the arrangement of consoles and equipment location</b> shall enable the officer of the watch to perform navigational duties and other functions allocated to the bridge as well as maintain a proper lookout from a convenient position on the bridge, hereafter referred to as a 'workstation'.	<u>SOLAS V/Reg.15</u> All decisions which are made for the purpose of applying the requirements of regulations 19, 22, 24, 25, 27, and 28 of this chapter and which affect bridge design, the design and arrangement of navigational systems and equipment on the bridge and bridge procedures** shall be taken with the aim of: ...  <u>MSC/Circ.982</u> Refer to 5.1 Bridge Layout  <u>IACS Rec.95</u> B 5 Workstation arrangements and required fields of vision The bridge should be designed and arranged with the aim of: ...  <u>ISO 8468</u> : Refer to 5.2.3	General requirement	Yes
1.2 A workstation for navigation and traffic surveillance/manoeuvring shall be arranged to enable		Except for MSC/Circ.566, other instruments	

<p>efficient operation <b>by one person</b> under normal operating conditions. All relevant instrumentation and controls shall be easily visible, audible and accessible from the workstation.</p>	<p><u>MSC/Circ.566</u> 11 A workstation for navigation and traffic surveillance/manoeuvring should be arranged to enable efficient operation <b>by one person</b> under normal operating conditions. All relevant instrumentation should be easily accessible from the workstation.</p> <p><u>MSC/Circ.982</u> 5.1.3.3 Passageway Dimensions The distance from the bridge front bulkhead, or from any consoles or installations placed against the front bulkhead, to any consoles or installations placed away from the bridge front should be sufficient <b>for two persons to pass</b> each other. The distance of a passageway between the front bulkhead and any consoles should preferably be at least 1 000 mm, and not less than 800 mm.</p> <p>5.3.1.1 Workstation Area The workstations for navigating and manoeuvring, monitoring and for the bridge wings should be planned, designed and placed within an area <b>spacious enough for not less than two operators</b>, but close enough for the workstations to be operated by one person.</p> <p><u>IACS Rec.95</u> B 5.1 Workstations for navigating and manoeuvring and for monitoring should be arranged within an area spacious enough for <b>two persons to carry out the tasks</b> in close cooperation, but sufficiently close together to enable the watch officer to control and safely carry out all the tasks from one working area under normal operating conditions.</p>	<p>has no assumption that the task could be carried out by one person under normal operating conditions.</p> <p>This paragraph is same as para.11 of MSC/Circ.566.</p>	<p>Yes</p>
<p>1.3 For the purpose of performing duties related to navigation, traffic surveillance and manoeuvring, <b>the field of vision from a workstation</b> shall be such as to enable observation of all objects which may affect the safe conning of the ship. The field of vision from a workstation shall be in accordance with the guidelines on navigation bridge visibility, as specified in IMO Resolution A708 as it applies to new ships.</p> <p>For other functions, other workstations may be arranged singularly or in combination, provided the field of vision complies with the foregoing.</p>	<p><u>SOLAS V/Reg.22 Navigation bridge visibility</u></p> <p><u>Res.A.708(17)</u> Refer to <u>3 Field of vision</u></p> <p><u>MSC/Circ.982</u> Refer to <u>5.1.1.1 Field of Vision</u></p> <p><u>IACS Rec.95</u> B 5 Workstation arrangements and <u>required fields of vision</u> The bridge should be designed and arranged with the aim of: .... The workstations for primary bridge functions should be arranged to serve their functions under all operating conditions and different manning of the bridge and <u>provide the fields of vision</u> required for visual observations and easy cooperation between bridge personnel, promoting effective and safe bridge resource management.</p> <p><u>ISO 8468</u> : Refer to 4.2 Field of vision</p>	<p>N/A</p>	<p>Yes</p>

<p>1.4 The bridge layout design and workstations are to enable the ship to be navigated and manoeuvred safely <b>by two navigators</b> in cooperation.</p>	<p><b>MSC/Circ.982</b>  5.1.3.3 Passageway Dimensions  The distance from the bridge front bulkhead, or from any consoles or installations placed against the front bulkhead, to any consoles or installations placed away from the bridge front should be sufficient <u>for two persons to pass</u> each other. The distance of a passageway between the front bulkhead and any consoles should preferably be at least 1 000 mm, and not less than 800 mm.</p> <p>5.3.1.1 Workstation Area  The workstations for navigating and manoeuvring, monitoring and for the bridge wings should be planned, designed and placed within an area <u>spacious enough for not less than two operators</u>, but close enough for the workstations to be operated by one person.</p> <p><b>IACS Rec.95</b>  B 5.1 Workstations for navigating and manoeuvring and for monitoring should be arranged within an area spacious enough for <u>two persons to carry out the tasks</u> in close cooperation, but sufficiently close together to enable the watch officer to control and safely carry out all the tasks from one working area under normal operating conditions.</p> <p><b>ISO 8468</b> : Refer to 5.2.3  The main workstations should be planned, designed and placed within an area spacious enough for not less than <u>two operators</u>, but close enough to allow the stations to be operated by one person.</p>	<p>N/A</p>	<p>Yes</p>
<p>1.5 <b>External sound signals</b> from ships and <b>fog signals</b> that are audible on the open deck, shall also be audible inside the wheelhouse; a transmitting device shall be provided to reproduce such signals inside the wheelhouse (recommended frequency range: 70 to 700 Hz).</p>	<p><b>SOLAS V/Reg.19.2.1.8</b>  All ships irrespective of size shall have; when the ship's bridge is totally enclosed and unless the Administration determines otherwise, <u>a sound reception system</u>, or other means, to enable the officer in charge of the navigational watch to hear sound signals and determine their direction</p> <p><b>Res.MSC.86(70) - PERFORMANCE STANDARDS FOR SOUND RECEPTION SYSTEMS</b>  2 FUNCTIONAL REQUIREMENTS  2.1 Sound reception systems should be capable of:  .1 receiving sound signals from all directions in the <u>audio band 70 Hz - 820 Hz</u>;  .2 reproducing incoming sound signals acoustically inside the bridge;  .3 indicating the approximate direction of incoming sound signals to determine at least whether the sound signal being detected is forward or abaft of the beam and from which side of the ship it is being detected; and  .4 suppressing unwanted background noise and allowing reception of meaningful sounds.</p> <p><b>ISO 8468</b>  4.4 Sound reception system  4.4.1 Sounds of interest to navigation that are audible on open deck area shall also be audible inside the wheelhouse.  4.4.2 The ship may be fitted with a technical device receiving sounds outside the wheelhouse and reproducing such sounds inside the wheelhouse after amplification.</p>	<p>For SOLAS ships, the sound reception system is required only for ships having totally enclosed bridge. Otherwise, it is deemed as optional equipment.</p>	<p>Yes</p>
<p>1.6 The requirements and guidelines of <b>ISO Standard 8468</b> should be regarded as a basic reference for the design of the bridge layout.</p>	<p>N/A</p>	<p>General requirement</p>	<p>N/A</p>
<p><b>2. Bridge Instrumentation and Controls</b></p>			
<p>2.1 Functions to be ensured  The instrumentation and controls at the workstation for navigation and traffic surveillance/manoeuvring shall be arranged to enable the officer of the watch to:</p>	<p>N/A</p>	<p>General requirement</p>	<p>Yes</p>
<p>2.1.1 determine and plot the ship's position, course, track and speed;</p>	<p>SOLAS II-1/Reg.29 "Steering gear"</p>		
<p>2.1.2 analyse the traffic situation;</p>	<p>SOLAS III/Reg.6.4 "On-board communications and alarm systems"</p>		
<p>2.1.3 decide on collision avoidance manoeuvres;</p>	<p>LSA Code 7.2.2 "Public address system"</p>		
<p>2.1.4 alter course;</p>	<p>SOLAS IV/Reg.4 "Functional requirements"</p>		
<p>2.1.5 change speed;</p>	<p>SOLAS V/Reg.19 "Carriage requirements for shipborne navigational system and equipment"</p>		
<p>2.1.6 effect internal and external communications related to navigation and manoeuvring, radio communication on the VHF;</p>		<p>IACS Rec.95 and ISO 8468 provide very similar requirements.</p>	<p>Yes</p>
<p>2.1.7 give sound signals;</p>			
<p>2.1.8 hear sound signals;</p>	<p>MSC/Circ.982 : Refer to "Appendix 2 Proposed equipment for workstation"</p>		

2.1.9 monitor course, speed, track, propeller revolutions (pitch), rudder angle and depth of water;	IACS Rec.95 : Refer to "B 1 Functions, tasks and means"		
2.1.10 record navigational data (may be manually recorded from data available at the workstation).	ISO 8468 : Refer to "5.3 Tasks to be performed"		
2.2 Equipment to be fitted			
2.2.1 Irrespective of their size, gross tonnage and date of construction, <b>all OMBO ships</b> are in any case to be equipped with the instrumentation and controls described under 2.3 to 2.5 hereafter.	N/A	Dedicated requirement for OMBO ships	No
<b>2.3 Safety of navigation: Collision-Grounding</b>			
2.3.1 The ship is to be equipped with an <b>ARPA system</b> including, or associated with, a collision avoidance system, meeting the requirements of IMO Resolution A422(XI). The ARPA function may be independent or built into the radar equipment.  The system is to be based on the assumption that all floating objects may come onto a collision course with own ship if the object's course is changed up to 45° with its speed maintained. A warning shall be given to the navigator at a time which shall be adjustable in the range of 6 to 30 minutes, having regard to the time to danger (TCPA).  The whole equipment is to feature the following capability: – true motion and relative motion modes, – daylight-visible display, – automatic acquisition and tracking of 20 radar targets, – guard zone system, featuring adjustable parameters, notably warning and alarm set for CPA and TCPA, – simulator function showing the likely effects of a course or speed change in relation to tracked targets, – incorporated self-checking properties.	<u>SOLAS V/Reg.19.2.8.1</u> 2.8 All ships of 10,000 gross tonnage and upwards shall, in addition to meeting the requirements of paragraph 2.7 with the exception of paragraph 2.7.2, have: .1 an automatic radar plotting aid, or other means, to plot automatically the range and bearing of at least 20 other targets, connected to a device to indicate speed and distance through the water, to determine collision risks and simulate a trial manoeuvre; and <u>Res.A.422(11)</u> "PERFORMANCE STANDARDS FOR AUTOMATIC RADAR PLOTTING AIDS (ARPA)" <u>Res.A.823(19)</u> "PERFORMANCE STANDARDS FOR AUTOMATIC RADAR PLOTTING AIDS (ARPAs)" <u>Res.MSC.192(79), as amended</u> "ADOPTION OF THE REVISED PERFORMANCE STANDARDS FOR RADAR EQUIPMENT" <u>IACS Rec.95</u> : Refer to "Table C 2.3" <u>ISO 8468</u> : Refer to "6.2 Distribution of equipment in workstations" <u>MSC/Circ.563</u> : Refer to "E 3.2 and 3.3" for symbol of guard zone system	Res.A.422(11) has been amended by Res.A.823(19).  ARPAs installed on or after 1 January 1997 conform to performance standards Res.A.823(19).  ARPAs installed before 1 January 1997 conform Res.A.422(11).  A guard zone is deemed as "Acquisition/activation zone" specified in Res.MSC.192(79)	Yes
2.3.2 An <b>automatic pilot</b> is to be provided and monitored by an off-course alarm addressed to the navigator, in case of malfunction. This alarm shall be derived from a system independent from the automatic steering system. An overriding control device shall be provided at the navigating and manoeuvring workstation.  Alternatively, track piloting equipment may be considered.	<u>SOLAS V/Reg.19.2.8.2</u> 2.8 All ships of 10,000 gross tonnage and upwards shall, in addition to meeting the requirements of paragraph 2.7 with the exception of paragraph 2.7.2, have: .2 a heading or track control system, or other means, to automatically control and keep to a heading and/or straight track.  <u>Res.MSC.74(69)</u> : Refer to "annex 2 for track control systems (TCS)" <u>Res.MSC.64(67)</u> : Refer to "annex 3 for heading control systems (HCS)"  <u>IACS Rec.95</u> : Refer to "Annex A 1 Table of tasks and related means for safe operations"	N/A	Yes
2.3.3 The navigator is to be given an <b>alarm</b> in case of deviation from the planned route. This alarm is to be adjustable having regard to the time to danger of grounding.	<u>Res.MSC.74(69)</u> : Refer to "annex 2 for track control systems (TCS)" <u>Res.A.817(19)</u> , as amended : Refer to "10.5.3" <u>IACS Rec.95</u> : Refer to "C 3 Bridge alarm management"	N/A	Yes
2.3.4 <b>Pre-warning</b> is to be given at the approach of a way-point.	<u>Res.MSC.74(69)</u> : annex 2 for track control systems (TCS)		
2.3.5 An alarm is to be initiated when the <b>water depth</b> beneath the ship is less than a predetermined value.	<u>SOLAS V/Reg.19.2.3.1</u> 2.3 All ships of 300 gross tonnage and upwards and passenger ships irrespective of size shall, in addition to meeting the requirements of paragraph 2.2, be fitted with: .1 an echo sounding device, or other electronic means, to measure and display the available depth of water;  <u>Res.A.817(19)</u> , as amended : Refer to "10.5.3" <u>Res.MSC.74(69)</u> : Refer to "5.3.1 Depth alarm" <u>MSC/Circ.982</u> : Refer to "Appendix 2" <u>IACS Rec.95</u> : Refer to "Annex A 1 Table of tasks and related means for safe operations"	N/A	Yes
<b>2.4 Position fixing</b>			

<p>2.4.1 Ships are to be provided with <b>position fixing systems</b> appropriate to the intended service areas.</p>	<p><b>SOLAS V/Reg.19.2.1.6</b> 2.1 All ships irrespective of size shall have: .6 a receiver for a <u>global navigation satellite system</u> or a <u>terrestrial radionavigation system</u>, or other means, suitable for use at all times throughout the intended voyage to establish and update the ship's position by automatic means;</p> <p><b>Res.MSC.112(73)</b> on ADOPTION OF THE REVISED PERFORMANCE STANDARDS FOR SHIPBORNE GLOBAL POSITIONING SYSTEM (<b>GPS</b>) RECEIVER EQUIPMENT</p> <p><b>Res.MSC.113(73)</b> on ADOPTION OF THE REVISED PERFORMANCE STANDARDS FOR SHIPBORNE <b>GLONASS</b> RECEIVER EQUIPMENT</p> <p><b>Res.MSC.114(73)</b> on ADOPTION OF THE REVISED PERFORMANCE STANDARDS FOR SHIPBORNE <b>DGPS AND DGLONASS</b> MARITIME RADIO BEACON RECEIVER EQUIPMENT</p> <p><b>Res.MSC.115(73)</b> on ADOPTION OF THE REVISED PERFORMANCE STANDARDS FOR SHIPBORNE <b>COMBINED GPS/GLONASS</b> RECEIVER EQUIPMENT</p> <p><b>Res.MSC.233(82)</b> on ADOPTION OF THE PERFORMANCE STANDARDS FOR SHIPBORNE <b>GALILEO</b> RECEIVER EQUIPMENT</p> <p><b>Res.MSC.379(93)</b> on PERFORMANCE STANDARDS FOR SHIPBORNE <b>BEIDOU</b> SATELLITE NAVIGATION SYSTEM (BDS) RECEIVER EQUIPMENT</p> <p><b>Res.MSC.449(99)</b> on PERFORMANCE STANDARDS FOR SHIPBORNE INDIAN REGIONAL NAVIGATION SATELLITE SYSTEM (<b>IRNSS</b>) RECEIVER EQUIPMENT</p>	<p>N/A</p>	<p>Yes</p>
<p>2.4.2 At least 2 independent <b>radars</b> shall be provided. One of them shall operate within the X-band.</p>	<p><b>SOLAS V/Reg.19.2.3.2</b> (X-band Radar for ships of 300 GT above)</p> <p><b>SOLAS V/Reg.19.2.7.1</b> (S-band Radar for ships of 3,000 GT above)</p> <p><b>Res.MSC.192(79)</b>, as amended "ADOPTION OF THE REVISED PERFORMANCE STANDARDS FOR RADAR EQUIPMENT"</p> <p><b>IACS Rec.95</b> : Refer to "Annex A 1 Table of tasks and related means for safe operations"</p> <p><b>MSC/Circ.982</b> : Refer to "Appendix 2"</p> <p><b>ISO 8468</b> : Refer to "6.2 Distribution of equipment in workstations"</p>	<p>N/A</p>	<p>Yes</p>
<p>2.4.3 A <b>gyro compass</b> system is to be provided.</p>	<p><b>SOLAS V/Reg.19.2.5.1</b> 2.5 All ships of 500 gross tonnage and upwards shall, in addition to meeting the requirements of paragraph 2.3 with the exception of paragraphs 2.3.3 and 2.3.5, and the requirements of paragraph 2.4, have: .1 a gyro compass, or other means, to determine and display their heading by shipborne non-magnetic means, being clearly readable by the helmsman at the main steering position. These means shall also transmit heading information for input to the equipment referred in paragraphs 2.3.2, 2.4 and 2.5.5;</p> <p><b>IACS Rec.95</b> : Refer to "Annex A 1 Table of tasks and related means for safe operations"</p> <p><b>MSC/Circ.982</b> : Refer to "Appendix 2"</p> <p><b>Res.A.424(11)</b> on PERFORMANCE STANDARDS FOR GYRO-COMPASSES</p> <p><b>ISO 8728, Ships and marine technology</b> — Marine gyro-compasses</p>	<p>N/A</p>	<p>Yes</p>



<p>2.4.4 A <b>speed log</b> system is to be provided.</p>	<p><b>SOLAS V/Reg.19.2.3.4</b>  2.3 All ships of 300 gross tonnage and upwards and passenger ships irrespective of size shall, in addition to meeting the requirements of paragraph 2.2, be fitted with:  .4 speed and distance measuring device, or other means, to indicate <u>speed and distance through the water</u>;</p> <p><b>SOLAS V/Reg.19.2.9.2</b>  2.9 All ships of 50,000 gross tonnage and upwards shall, in addition to meeting the requirements of paragraph 2.8, have:  .2 a speed and distance measuring device, or other means, to indicate <u>speed and distance over the ground</u> in the forward and athwartships direction.</p> <p><b>Resolution A.824(19)</b>, as amended on PERFORMANCE STANDARDS FOR DEVICES TO INDICATE SPEED AND DISTANCE</p> <p><b>MSC/Circ.982</b> : Refer to "Appendix 2"</p> <p><b>IACS Rec.95</b> : Refer to "Annex A 1 Table of tasks and related means for safe operations"</p> <p><b>IEC 61023, Maritime navigation and radiocommunication equipment and systems — Marine speed and distance measuring equipment (SDME)</b> — Performance requirements — Methods of testing and required test results</p>	<p>N/A</p>	<p>Yes</p>
<p>2.4.5 An <b>echo sounding</b> system is to be provided.</p>	<p><b>SOLAS V/Reg.19.2.3.1</b>  2.3 All ships of 300 gross tonnage and upwards and passenger ships irrespective of size shall, in addition to meeting the requirements of paragraph 2.2, be fitted with:  .1 an echo sounding device, or other electronic means, to measure and display the available depth of water;</p> <p><b>Res.MSC.74(69)</b> : Refer to "Annex 4"</p> <p><b>MSC/Circ.982</b> : Refer to "Appendix 2"</p> <p><b>IACS Rec.95</b> : Refer to "Annex A 1 Table of tasks and related means for safe operations"</p> <p><b>ISO 9875, Ships and marine technology</b> — Marine echo-sounding equipment</p>	<p>N/A</p>	<p>Yes</p>
<p>2.5 Controls – Communication</p>			
<p>2.5.1 A <b>propulsion plant remote control system</b> is to be provided on the bridge.</p>	<p><b>MSC/Circ.982</b> : Refer to "Appendix 2"</p> <p><b>IACS Rec.95</b> : Refer to "Annex A 1 Table of tasks and related means for safe operations"</p>	<p>N/A</p>	<p>Yes</p>
	<p><b>SOLAS III/Reg.6.4.2</b></p>		

<p>2.5.2 A <b>whistle control</b> device is to be provided.</p>	<p>4.2 A <u>general emergency alarm system</u> complying with the requirements of paragraph 7.2.1 of the Code shall be provided and shall be used for summoning passengers and crew to muster stations and to initiate the actions included in the muster list. The system shall be supplemented by either a public address system complying with the requirements of paragraph 7.2.2 of the Code or other suitable means of communication. Entertainment sound systems shall automatically be turned off when the general emergency alarm system is activated.</p> <p><b>LSA Code 7.2.1 General emergency alarm system</b></p> <p>7.2.1.1 The general emergency alarm system shall be capable of sounding the general emergency alarm signal consisting of seven or more short blasts followed by one long blast on the ship's <u>whistle</u> or siren and additionally on an electrically operated bell or klaxon or other equivalent warning system, which shall be powered from the ship's main supply and the emergency source of electrical power required by regulation II-1/42 or II-1/43, as appropriate. The system shall be capable of operation from the navigation bridge and, except for the ship's whistle, also from other strategic points. The alarm shall continue to function after it has been triggered until it is manually turned off or is temporarily interrupted by a message on the public address system.</p> <p><b>MSC/Circ.982</b> : Refer to "Appendix 2"</p> <p><b>IACS Rec.95</b> : Refer to "Annex A 1 Table of tasks and related means for safe operations"</p> <p><b>ISO 8468</b> : Refer to "5.3 Tasks to be performed a) 7)"</p>	<p>N/A</p>	<p>Yes</p>
<p>2.5.3 A <b>window wipe and wash control</b> device is to be provided.</p>	<p><b>MSC/Circ.982</b> : Refer to "Appendix 2"</p> <p><b>IACS Rec.95</b> : Refer to "Annex A 1 Table of tasks and related means for safe operations"</p> <p><b>ISO 8468</b> : Refer to "5.3 Tasks to be performed a) 14)"</p>	<p>N/A</p>	<p>Yes</p>
<p>2.5.4 A main workstation console <b>lighting control</b> device is to be provided.</p>	<p><b>MSC/Circ.982</b> : Refer to "Appendix 2"</p> <p><b>IACS Rec.95</b> : Refer to "B 3.5"</p> <p><b>ISO 8468</b> : Refer to "6.4 Illumination and individual lighting of equipment" and "7.4 Lighting"</p>	<p>N/A</p>	<p>Yes</p>
<p>2.5.5 <b>Steering pump selector/control switches</b> are to be provided.</p>	<p><b>MSC/Circ.982</b> : Refer to "Appendix 2"</p> <p><b>IACS Rec.95</b> : Refer to "Annex A 1 Table of tasks and related means for safe operations"</p> <p><b>ISO 8468</b> : Refer to "6.2 Distribution of equipment in workstations"</p>	<p>N/A</p>	<p>Yes</p>
<p>2.5.6 An <b>internal communication</b> system is to be provided.</p>	<p><b>SOLAS III/Reg.6.4.2</b></p> <p>4.2 A general emergency alarm system complying with the requirements of paragraph 7.2.1 of the Code shall be provided and shall be used for summoning passengers and crew to muster stations and to initiate the actions included in the muster list. The system shall be supplemented by either a <u>public address system</u> complying with the requirements of paragraph 7.2.2 of the Code or other suitable means of communication. Entertainment sound systems shall automatically be turned off when the general emergency alarm system is activated.</p> <p><b>LSA Code 7.2.2 Public address system</b></p> <p>7.2.2.1 The public address system shall be a loudspeaker installation enabling the broadcast of messages into all spaces where crew members or passengers, or both, are normally present, and to muster stations. It shall allow for the broadcast of messages from the navigation bridge and such other places on board the ship as the Administration deems necessary. It shall be installed with regard to acoustically marginal conditions and not require any action from the addressee. It shall be protected against unauthorized use.</p> <p><b>MSC/Circ.982</b> : Refer to "Appendix 2"</p> <p><b>IACS Rec.95</b> : Refer to "Annex A 1 Table of tasks and related means for safe operations"</p> <p><b>ISO 8468</b> : Refer to "6.2 Distribution of equipment in workstations"</p>	<p>N/A</p>	<p>Yes</p>

<p>2.5.7 A <b>V.H.F. radiotelephone</b> installation is to be provided.</p>	<p><b>SOLAS IV/Reg.6.3</b> 3 Control of the VHF radiotelephone channels, required for navigational safety, shall be immediately available on the navigating bridge convenient to the conning position and, where necessary, facilities should be available to permit radiocommunications from the wings of the navigating bridge. Portable VHF equipment may be used to meet the latter provision.</p> <p><b>SOLAS IV/Reg.7.1.1</b> 1 Every ship shall be provided with : .1 a VHF radio installation capable of transmitting and receiving ;</p> <p><b>Res.A.803(19)</b> as amended, on PERFORMANCE STANDARDS FOR SHIPBORNE VHF RADIO INSTALLATIONS CAPABLE OF VOICE COMMUNICATION AND DIGITAL SELECTIVE CALLING</p> <p><b>MSC/Circ.982</b> : Refer to "Appendix 2" <b>IACS Rec.95</b> : Refer to "Annex A 1 Table of tasks and related means for safe operations" <b>ISO 8468</b> : Refer to "6.2 Distribution of equipment in workstations"</p>	<p>N/A</p>	<p>Yes</p>
<p>2.5.8 The systems or controls under 2.5.1 to 2.5.7 are to be fitted within <b>the reach of the officer of the watch</b> when seated or standing at the main navigating and manoeuvring workstation.</p>	<p><b>MSC/Circ.982</b> 5.3.1.2 Single Operator Console Width for Seated Operations The console should be dimensioned and configured so that all relevant controls can be reached from a sitting position.</p> <p><b>IACS Rec.95</b> : Refer to "B 7 Workstation layout, consoles and chair arrangement" <b>ISO 8468</b> A.3.2.2 All the equipment to be operated at the workstation for navigation and manoeuvring shall be located within reach for a seated person with safety belt fastened. Equipment and indicators to be monitored shall be easily readable from this position.</p>	<p>N/A</p>	<p>Yes</p>
<p>2.5.9 A wheelhouse <b>heating/cooling control</b> device is to be provided.</p>	<p><b>MSC/Circ.982</b> : Refer to "5.2.2 Ventilation and Air-conditioning" and "Appendix 2" <b>IACS Rec.95</b> : Refer to "B 3.1" <b>ISO 8468</b> : Refer to "7.5 Heating, ventilation and air conditioning"</p>	<p>N/A</p>	<p>Yes</p>
<p>2.5.10 A NAVTEX automatic receiver and recorder is to be provided.</p>	<p><b>SOLAS IV/Reg.7.1.4</b> 1 Every ship shall be provided with : .4 a receiver capable of receiving International NAVTEX service broad-casts if the ship is engaged on voyages in any area in which an International NAVTEX service is provided;</p> <p><b>Res.MSC.148(77)</b> on THE REVISED PERFORMANCE STANDARDS FOR NARROW-BAND DIRECT-PRINTING TELEGRAPH EQUIPMENT FOR THE RECEPTION OF NAVIGATIONAL AND METEOROLOGICAL WARNINGS AND URGENT INFORMATION TO SHIPS (NAVTEX)</p> <p><b>MSC/Circ.982</b> : Refer to "Appendix 2" <b>IACS Rec.95</b> : Refer to "Annex A 1 Table of tasks and related means for safe operations"</p>	<p>N/A</p>	<p>Yes</p>
<p><b>3. Prevention of Accidents caused by Operator's Unfitness</b></p>			
<p>3.1 Bridge safety system</p>			

<p>3.1.1 A <b>vigilance system</b> is to be provided to indicate that an alert officer of the navigational watch is present on the bridge.</p>	<p><u>SOLAS V/Reg.19.2.2.3</u> 2.2 All ships of 150 gross tonnage and upwards and passenger ships irrespective of size shall, in addition to the requirements of paragraph 2.1, be fitted with: .3 a bridge navigational watch alarm system (<b>BNWAS</b>), as follows:  <u>Res.MSC.128(75)</u> on PERFORMANCE STANDARDS FOR A BRIDGE NAVIGATIONAL WATCH ALARM SYSTEM (<b>BNWAS</b>)  <u>IACS Rec.95</u> : Refer to "D 2 Prevention of operational errors" <u>ISO 8468</u> : Refer to "5.6.2 Bridge navigational watch alarm system (<b>BNWAS</b>)"</p>	<p>BNWAS is appropriate for this purpose</p>	<p>Yes</p>
<p>3.1.2 Any system used for verification of the officer of the navigational watch's alertness shall not cause undue interference with the performance of bridge functions.</p>	<p><u>IACS Rec.95</u> : Refer to "D 2 Prevention of operational errors" <u>ISO 8468</u> : Refer to "5.6.2 Bridge navigational watch alarm system (BNWAS)"</p>	<p>General requirement</p>	<p>Yes</p>
<p>3.1.3 The system shall be so <b>designed and arranged</b> that it could not be operated in an unauthorized manner, as far as practicable.</p>	<p><u>IACS Rec.95</u> : Refer to "D 2 Prevention of operational errors" <u>ISO 8468</u> : Refer to "5.6.2 Bridge navigational watch alarm system (BNWAS)"</p>	<p>N/A</p>	<p>Yes</p>
<p>3.1.4 Any system used for <b>periodic verification</b> of the officer of the navigational watch's alertness shall be adjustable up to 12 minute intervals and constructed, fitted and arranged so that only the ship's master has access to the component for setting the appropriate intervals.</p>	<p><u>Res.MSC.128(75)</u> on PERFORMANCE STANDARDS FOR A BRIDGE NAVIGATIONAL WATCH ALARM SYSTEM (BNWAS) 4.1.2 Operational sequence of indications and alarms 4.1.2.1 Once operational, the alarm system should remain dormant for a period of between 3 and 12 min (Td).</p>	<p>N/A</p>	<p>Yes</p>
<p>3.1.5 The system shall provide for the <b>acknowledgement</b> by the officer of the navigational watch at the navigating and traffic surveillance/manoeuvring workstation and other appropriate locations in the bridge from where a proper lookout may be kept.</p>	<p><u>ISO 8468</u> : Refer to "5.6.2 Bridge navigational watch alarm system (BNWAS)" Where a system requires manual acknowledgement by the operator, this shall be possible at the workstation for navigation and manoeuvring, and also at other appropriate locations from where a proper lookout may be kept.</p>	<p>N/A</p>	<p>Yes</p>
<p>3.1.6 Such a system shall be connected to the <b>alarm transfer system</b> described in 3.2.</p>	<p><u>ISO 8468</u> : Refer to "5.6.3 Alarm transfer system"</p>	<p>N/A</p>	<p>Yes</p>
<p>3.1.7 An alarm is to operate on the bridge in the <b>event of a failure</b> of the bridge safety systems.</p>	<p><u>ISO 8468</u> : Refer to "5.6.2 Bridge navigational watch alarm system (BNWAS)" An alarm is to operate on the bridge in the event of a failure of the watch alarm system.</p>	<p>N/A</p>	<p>Yes</p>
<p>3.1.8 The requirements of 3.1.1 to 3.1.7 do not prevent the Classification Societies from accepting any technical systems that adequately verify or help maintain the alertness of the officer of the watch at intervals up to 12 minutes.</p>	<p>N/A</p>	<p>General requirement</p>	<p>N/A</p>
<p>3.2 Alarm/warning transfer system – communications</p>			
<p>3.2.1 Any alarm/warning that requires bridge operator response shall be <b>automatically transferred</b> to the master and, if he deems it necessary, to the selected back-up navigator and to the public rooms, if not acknowledged on the bridge within 30 seconds. Such transfer is to be carried out through the systems required by 3.2.3 and 3.2.7 where applicable.</p>	<p><u>Res.MSC.128(75)</u> on PERFORMANCE STANDARDS FOR A BRIDGE NAVIGATIONAL WATCH ALARM SYSTEM (BNWAS) 4.1.2 Operational sequence of indications and alarms 4.1.2.1 Once operational, the alarm system should remain dormant for a period of between 3 and 12 min (Td). 4.1.2.2 At the end of this dormant period, the alarm system should initiate a visual indication on the bridge. 4.1.2.3 If not reset, the BNWAS should additionally sound a first stage audible alarm on the bridge 15 s after the visual indication is initiated. 4.1.2.4 If not reset, the BNWAS should additionally sound a second stage remote audible alarm in the back-up officer's and/or Master's location 15 s after the first stage audible alarm is initiated. 4.1.2.5 If not reset, the BNWAS should additionally sound a third stage remote audible alarm at the locations of further crew members capable of taking corrective actions 90 s after the second stage remote audible alarm is initiated.  <u>ISO 8468</u> : Refer to "5.6.3 Alarm transfer system" Means may be provided on the bridge to immediately activate a second, and subsequently third, stage remote audible alarms by means of an Emergency Call push button or similar.</p>	<p>N/A</p>	<p>Yes</p>

<p>3.2.2 <b>Acknowledgment of alarms/warnings</b> shall only be possible from the bridge.</p>	<p><b>Res.MSC.128(75)</b> on PERFORMANCE STANDARDS FOR A BRIDGE NAVIGATIONAL WATCH ALARM SYSTEM (BNWAS)  4.1.3 Reset function  4.1.3.1 It should not be possible to initiate the reset function or cancel any audible alarm from any device, equipment or system not physically located in areas of the bridge providing proper look out.</p> <p><b>ISO 8468</b> : Refer to "5.6.3 Alarm transfer system"  Acknowledgement and cancellation of alarms shall only be possible from fixed locations on the bridge.</p>	<p>N/A</p>	<p>Yes</p>
<p>3.2.3 The alarm/warning transfer shall be operated through a <b>fixed installation</b>.</p>	<p><b>Res.MSC.128(75)</b> on PERFORMANCE STANDARDS FOR A BRIDGE NAVIGATIONAL WATCH ALARM SYSTEM (BNWAS)  4.1.4 Emergency call facility  Means may be provided on the bridge to immediately activate the second, and subsequently third, stage remote audible alarms by means of an "Emergency Call" push button or similar.</p>	<p>N/A</p>	<p>Yes</p>
<p>3.2.4 Provision is to be made on the bridge for the operation of a navigation <b>officer call-alarm</b> to be clearly audible in the spaces of 3.2.1.</p>	<p><b>Res.MSC.128(75)</b> on PERFORMANCE STANDARDS FOR A BRIDGE NAVIGATIONAL WATCH ALARM SYSTEM (BNWAS)  6.3 Power supply  The BNWAS should be powered from the ship's main power supply. The malfunction indication, and all elements of the <u>Emergency Call facility, if incorporated, should be powered from a battery maintained supply.</u></p>	<p>N/A</p>	<p>Yes</p>
<p>3.2.5 The alarm transfer system shall be continuously powered and shall have an automatic changeover to a standby power supply in case of loss of normal power supply.</p>	<p><b>Res.MSC.128(75)</b> on PERFORMANCE STANDARDS FOR A BRIDGE NAVIGATIONAL WATCH ALARM SYSTEM (BNWAS)  6.3 Power supply  The BNWAS should be powered from the ship's main power supply. The malfunction indication, and all elements of the <u>Emergency Call facility, if incorporated, should be powered from a battery maintained supply.</u></p>	<p>N/A</p>	<p>Yes</p>
<p>3.2.6 At all times, including during blackout, the officer of the watch shall have access to facilities enabling <b>two way speech communication</b> with another qualified officer. The bridge is to have priority over the communication system.</p> <p>Note: The <b>automatic telephone network</b> is acceptable for this purpose, provided that it is automatically supplied during black-out situation and that it is available in the locations specified in 3.2.1.</p>	<p><b>SOLAS II-1/Reg.42.2.3.1 &amp; 43.2.4.1</b>  2.4 For a period of 18 h :  .1 all internal communication equipment as required in an emergency ;</p> <p><b>IACS UI SC 4</b> Emergency source of electrical power (Chapter II-1, Regulation 42.2.3.1 &amp; 43.2.4.1)  Internal communication equipment required in an emergency is generally:  1. The means of communication which is provided between the navigating bridge and the steering gear compartment  2. The means of communication which is provided between the navigating bridge and the position in the machinery space or control room from which the engines are normally controlled  3. The means of communication which is provided between the bridge and the radio telegraph or radio telephone stations.</p> <p><b>MSC/Circ.982</b> : Refer to "Appendix 2"  <b>IACS Rec.95</b> : Refer to "B 1 Functions, tasks and means"</p>	<p>It is not clear whether the common telephone network(intercom) in back-up officer's and/or Master's location or public rooms should be connected to emergency source of power.</p>	<p>No</p>
<p>3.2.7 If, depending on the shipboard work organization, the back-up navigator may attend locations not connected to the fixed installation(s) described in 3.2.1, he shall be provided with a wireless portable device enabling both the <b>alarm/warning transfer</b> and two way speech communication with the officer of the watch.</p>	<p><b>SOLAS III/Reg.6.2</b> Radio life-saving appliances  2.1 Two-way VHF radiotelephone apparatus  2.1.1 At least three <u>two-way VHF radiotelephone</u> apparatus shall be provided on every passenger ship and on every cargo ship of 500 gross tonnage and upwards. At least two two-way VHF radiotelephone apparatus shall be provided on every cargo ship of 300 gross tonnage and upwards but less than 500 gross tonnage. Such apparatus shall conform to performance standards not inferior to those adopted by the Organization. If a fixed two-way VHF radiotelephone apparatus is fitted in a survival craft it shall conform to performance standards not inferior to those adopted by Organization.</p>	<p>Alternatively, two-way VHF or walkie-talkie(transceiver) may be considered such a wireless portable device. However, these devices are generally not capable of transferring alarm/warning.</p>	<p>No</p>
<p><b>4. Equipment Design and Reliability</b></p>			
<p>4.1 Environmental conditions</p>			

<p>4.1.1 Shipborne navigational equipment specified in <b>IMO Publication 978-88-04E</b> 'PERFORMANCE STANDARDS FOR NAVIGATIONAL EQUIPMENT' shall be capable of continuous operation under the conditions of various sea states, vibration, humidity, temperature and electromagnetic interference likely to be experienced in the ship in which it is installed.</p>	<p><b>SOLAS V/Reg.17 Electromagnetic compatibility</b>  1 Administrations shall ensure that all electrical and electronic equipment on the bridge or in the vicinity of the bridge, on ships constructed on or after 1 July 2002, is tested for electromagnetic compatibility taking into account the recommendations developed by the Organization.  2 Electrical and electronic equipment shall be so installed that electromagnetic interference does not affect the proper function of navigational systems and equipment.  3 Portable electrical and electronic equipment shall not be operated on the bridge if it may affect the proper function of navigational systems and equipment.</p> <p><b>Res.A.813(19)</b> on GENERAL REQUIREMENTS FOR ELECTROMAGNETIC COMPATIBILITY (EMC) FOR ALL ELECTRICAL AND ELECTRONIC SHIP'S EQUIPMENT</p> <p><b>MSC/Circ.982</b> : Refer to "5.2 Work Environment"  <b>IACS Rec.95</b> : Refer to "B 3 Working environment"  <b>IACS UI SC 194</b> Installation of electrical and electronic appliances on the bridge and vicinity of the bridge  <b>ISO 8468</b> : Refer to "7 Bridge working environment"</p>	<p>N/A</p>	<p>Yes</p>
<p>4.1.2 Equipment which has been additionally specified in these Rules is to comply with the environmental conditions specified in <b>IACS UR E10</b>.</p>	<p><b>IACS UR E10</b> Test Specification for Type Approval</p>	<p>N/A</p>	<p>Yes</p>
<p>4.1.3 <b>Documentary evidence</b> in the form of Certification and/or test results are to be submitted to the satisfaction of the Classification Society. Where acceptable evidence is not available, the requirements of IACS UR E10 should be complied with.</p>	<p><b>SOLAS V/Reg.18</b> Approval, surveys and performance standards of navigational systems and equipment and voyage data recorder</p> <p><b>IACS UR E10</b> Test Specification for Type Approval</p> <p><b>IACS UI SC 194</b> Installation of electrical and electronic appliances on the bridge and vicinity of the bridge</p> <p><u>4. Evidence to be provided</u>  All electrical and electronic appliances installed on the bridge and vicinity of the bridge other than mandatory navigation and communication equipment having been type tested according to IEC 60945, as well as loose equipment placed on board by the builders or owners shall be listed and be provided with at least the following information. The list and the evidence of equipment are to be kept onboard.</p> <ul style="list-style-type: none"> <li>- equipment description</li> <li>- manufacturer</li> <li>- type / model</li> <li>- evidence of EMC compatibility which may be: <ul style="list-style-type: none"> <li>• type approval certificate covering EMC requirements for bridge installations;</li> <li>• test certificate or report / conformity statement; or</li> <li>• exemption statement.</li> </ul> </li> </ul>	<p>N/A</p>	<p>Yes</p>
<p>4.2 Design – reliability</p>			

<p><b>4.2.1 Power supply</b> Local distribution panels shall be arranged for all items of electrically operated navigational equipment. These panels are to be supplied by two exclusive circuits, one fed from the main source of electrical power and one fed from an emergency source of electrical power. Each item of navigational equipment is to be individually connected to its distribution panel. The power supplies to the distribution panels shall be arranged with automatic changeover facilities between the two sources. Failure of the main power supply to the distribution panels shall initiate an audible and visual alarm.</p>	<p><b>SOLAS II-1/Reg.42.7.3.2</b> Emergency source of electrical power in passenger ships 2.3 For a period of 36 h : .2 the shipborne navigational equipment as required by regulation V/12 *,where such provision is unreasonable or impracticable the Administration may waive this requirement for ships of less than 5,000 tons gross tonnage ;</p> <p><b>SOLAS II-1/Reg.43.2.4.2</b> Emergency source of electrical power in cargo ships 2.4 For a period of 18 h : .2 the shipborne navigational equipment as required by regulation V/12* ;where such provision is unreasonable or impracticable the Administration may waive this requirement for ships of less than 5,000 tons gross tonnage ;</p> <p><b>MSC/Circ.982</b> : Refer to "5.4.1.3 Failure or Reduction of Power Supply" and "5.4.1.10 Power supply" Required alarm systems should be continuously powered and should have an automatic change-over to a stand-by power supply in case of loss of normal power supply.</p> <p><b>IACS Rec.95</b> : Refer to "Table C 2.3"</p> <p><b>SN.1/Circ.288</b> : Refer to "14 Power supply"</p> <p><b>ISO 8468</b> : Refer to "6.6 Power supply requirements" Equipment required to undertake a primary bridge function should be connected, as appropriate, to a self-contained emergency source of electrical power as provided in the SOLAS convention</p>	<p>N/A</p>	<p>Yes</p>
<p><b>4.2.2 Loss of power</b> Following a loss of power which has lasted for 30 seconds or less, all primary functions are to be readily reinstated.  Following a loss of power which has lasted for more than 30 seconds, as many as practical primary functions shall be readily reinstated.</p>	<p><b>SOLAS II-1/Reg.42.3.1.2</b> Emergency source of electrical power in passenger ships 3.1 Where the emergency source of electrical power is a generator, it shall be : .2 started automatically upon failure of the electrical supply from the main source of electrical power and shall be automatically connected to the emergency switchboard; those services referred to in paragraph 4 shall then be transferred automatically to the emergency generating set. The automatic starting system and the characteristic of the prime mover shall be such as to permit the emergency generator to carry its full rated load as quickly as is safe and practicable, subject to a maximum of 45 s ;unless a second independent means of starting the emergency generating set is provided, the single source of stored energy shall be protected to preclude its complete depletion by the automatic starting system ;and</p> <p><b>SOLAS II-1/Reg.43.3.1.3</b> Emergency source of electrical power in cargo ships 3.1 Where the emergency source of electrical power is a generator, is shall be : .3 provided with a transitional source of emergency electrical power as specified in paragraph 4 unless an emergency generator is provided capable both of supplying the services mentioned in that paragraph and of being automatically started and supplying the required load as quickly as is safe and practicable subject to a maximum of 45 s.</p> <p><b>MSC.1/Circ.1464/Rev.1</b> : Refer to "5.4 SOLAS REGULATION II-1/41.5"</p> <p><b>IACS UI SC 157</b> Main Source of Electrical Power 2.2 Where the electrical power is normally supplied by one generator provision shall be made, upon loss of power, for automatic starting and connecting to the main switchboard of stand-by generator(s) of sufficient capacity with automatic restarting of the essential auxiliaries, in sequential operation if required. Starting and connection to the main switchboard of the stand-by generator is to be preferably within 30 seconds, but in any case not more than 45 seconds, after loss of power. Where prime movers with longer starting time are used, this starting and connection time may be exceeded upon approval from the society.</p>	<p>There is no definition of "primary function" and the term "primary functions" is not clear to determine which equipment or system is to be applied.</p> <p>Also, it should be identified whether the term "readily reinstated" means the equipment is reinstated or restarted automatically without manual operation such as power-on or not.</p> <p>For reference, ECDIS is automatically re-initialized when changing from one source of power supply to another, or any interruption of the supply for a period of up to 45 s. (Refer to Res.A.817(19) 15.2)</p>	<p>No</p>
<p><b>4.2.3</b> Where <b>computerized equipment</b> are interconnected through a computer network, failure of the network should not prevent individual equipment from performing their individual functions.</p>	<p>ISO 8468</p>	<p>General requirement</p>	<p>Yes</p>
<p><b>4.3</b> Ergonomical recommendations</p>			

<p><b>4.3.1 Lighting</b></p> <p>The lighting required on the bridge should be designed so as not to impair the night vision of the officer on watch. Lighting used in areas and at items of equipment requiring illumination whilst the ship is navigating is to be such that night vision adaptation is not impaired, e.g. red lighting. Such lighting is to be arranged so that it cannot be mistaken for a navigation light by another ship. It is to be noted that red lighting is not to be fitted over chart tables so that possible confusion in colour discrimination is avoided.</p>	<p><b>MSC/Circ.982</b> : Refer to "5.2.5 Illumination and Lighting" A satisfactory level of lighting should be available to enable the bridge personnel to complete such tasks as maintenance, chart and office work satisfactorily, both at sea and in port, daytime and night time.</p> <p><b>IACS Rec.95</b> : Refer to "B 3 Working environment"</p> <p><b>ISO 8468</b> : Refer to "6.4 Illumination and individual lighting of equipment" and "7.4 Lighting"</p>	<p>N/A</p>	<p>Yes</p>
<p><b>4.3.2 Noise levels</b></p> <p>The noise level on the bridge should not interfere with verbal communication, mask audible alarms or be uncomfortable to bridge personnel.</p>	<p><b>MSC/Circ.982</b> : Refer to "5.2.3 Noise and Acoustics" Workplace noise should be maintained at levels that do not: (1) interfere with necessary voice, telephone and radio communications, (2) cause fatigue or injury and (3) degrade overall system effectiveness.</p> <p><b>IACS Rec.95</b> : Refer to "B 3 Working environment"</p> <p><b>ISO 8468</b> : Refer to "7.3 Noise"</p>	<p>N/A</p>	<p>Yes</p>
<p><b>4.3.3 Vibration level</b></p> <p>The vibration level on the bridge should not be uncomfortable to the bridge personnel.</p>	<p><b>MSC/Circ.982</b> : Refer to "5.2.4 Vibration" Uncomfortable levels of vibration should be avoided on the bridge. Vibrations on the bridge should be reduced to such extent that the bridge personnel are neither hindered in their functions nor put at a health risk.</p> <p><b>IACS Rec.95</b> : Refer to "B 3 Working environment"</p> <p><b>ISO 8468</b> : Refer to "7.2 Vibration" Uncomfortable levels of vibration shall be avoided on the bridge.</p>	<p>N/A</p>	<p>Yes</p>
<p><b>4.3.4 Wheelhouse space heating/cooling</b></p> <p>Unless justified, wheelhouse spaces are to be provided with heating and air cooling systems. System controls are to be readily available to the officer of the watch.</p>	<p><b>MSC/Circ.982</b> : Refer to "5.2.2 Ventilation and Air-conditioning"</p> <p>5.2.2.1 Air-conditioning The wheelhouse should be equipped with an adequate air-conditioning or mechanical ventilation system to regulate temperature and humidity. The temperature and the humidity should be adjustable within the limits of the foregoing requirements 5.2.1, by closed wheelhouse doors and windows.</p> <p>5.2.2.2 Hot Air Discharge Heating systems should be designed so that hot air discharge is not directed at personnel.</p> <p>5.2.2.3 Cold Air Discharge Air conditioning systems should be designed such that cold air discharge is not directed at personnel.</p> <p>5.2.2.4 Air Velocities Ventilating systems should not produce air velocities exceeding 0,5 m/s. If possible, the preferred air velocity of 0,3 m/s should be used to preclude manual pages from being turned or papers from being blown off work surfaces.</p> <p><b>IACS Rec.95</b> : Refer to "B 3 Working environment"</p> <p><b>ISO 8468</b> : Refer to "7.5 Heating, ventilation and air conditioning"</p>	<p>N/A</p>	<p>Yes</p>



<p><b>4.3.5 Navigator's safety</b> There are to be no sharp edges or protuberances on the surfaces of the instruments and equipment installed on the bridge which could cause injury to the navigator.</p> <p>Sufficient <b>hand-rails</b> or equivalent thereto are to be fitted inside the wheelhouse or around instruments and equipment in the wheelhouse for safety in bad weather.</p> <p>Adequate means are to be made for <b>anti-slip</b> of the floor, whether it be dry or wet.</p> <p><b>Doors</b> to the bridge wings are to be easy to open and close. Means are to be provided to hold the doors open at any position.</p> <p>Where provision for <b>seating</b> is made in the wheelhouse, means for securing are to be provided, having regard to storm conditions.</p>	<p><b>MSC/Circ.982</b> : Refer to "5.2.6 Occupational Safety" 5.2.6.1 Non-slip Surfaces Wheelhouse, bridge wings and upper bridge decks should have non-slip surfaces. 5.2.6.2 General Wheelhouse Safety There should be no sharp edges or protuberances which could cause injury to personnel. 5.2.6.3 Hand and Grab Rails Sufficient hand- or grab-rails should be fitted to enable personnel to move or stand safely in bad weather. Protection of stairway openings should be given special consideration. 5.2.6.4 Safety Equipment Marking All safety equipment carried on the bridge should be clearly marked, be easily accessible and have its stowage position clearly indicated.</p> <p><b>IACS Rec.95</b> : Refer to "B 3 Working environment"</p> <p><b>ISO 8468</b> : Refer to "7.8 Safety of personnel" 7.8.1 The bridge area shall be free of physical hazards to bridge personnel. 7.8.2 Guidelines: There should be no sharp edges or protuberances which could cause injury to personnel. The bridge deck should be free of trip hazards such as curled up carpet edges, loose gratings, duckboards or equipment. Means should be provided for properly securing portable equipment. 7.8.3 Sufficient hand- or grab-rails shall be fitted to enable personnel to move or stand safely in bad weather. Protection of stairway openings shall be given special consideration. 7.8.4 All safety equipment carried on the bridge shall be clearly marked, be easily accessible and have its stowage position clearly indicated.</p>	<p>N/A</p>	<p>Yes</p>
<p><b>5. Tests and Surveys</b></p>			
<p>5.1 Testing of the equipment after installation onboard</p>			
<p>5.1.1 After fitting onboard, the installations are to be submitted to the tests deemed necessary to demonstrate correct operation. Some <b>tests</b> may be carried out at the quayside, while others are to be effected at sea trials.</p>	<p><b>Res.A.1140(31)</b> on SURVEY GUIDELINES UNDER THE HARMONIZED SYSTEM OF SURVEY AND CERTIFICATION (HSSC), 2019</p> <p><b>IACS Rec.95</b> : Refer to "Annex B" These elements also need to be considered by surveyors on the basis of documentation at the stage of plan approval, while the functioning of systems after installation needs to be verified by tests and trials before the ship is put in service.</p> <p><b>IACS UR E10</b> Test Specification for Type Approval</p>	<p>N/A</p>	<p>Yes</p>
<p>5.1.2 <b>On-board tests and sea trials</b> are to be carried out in accordance with the test procedures submitted in advance to the Society for approval. Tests and trials are to be performed under the <b>supervision of the Surveyors</b>.</p>	<p><b>Res.A.1140(31)</b> on SURVEY GUIDELINES UNDER THE HARMONIZED SYSTEM OF SURVEY AND CERTIFICATION (HSSC), 2019</p> <p><b>IACS Rec.95</b> : Refer to "A 6.7 Program for on board tests of equipment and systems" a) A program for the on board testing of the bridge equipment and systems required to be carried, as well as additional navigation equipment installed, should be submitted for approval at the earliest possible stage before sea trials.</p> <p><b>IACS UR E10</b> Test Specification for Type Approval</p>	<p>N/A</p>	<p>Yes</p>
<p>5.2 Surveys</p>			
<p>5.2.1 <b>Periodical surveys</b> are to be carried out to the Surveyor's satisfaction, in order to verify that the equipment and arrangements required for the <b>class notation</b> are being maintained in good working order.</p>	<p><b>SOLAS I/Reg.7 "Surveys of passenger ships"</b></p> <p><b>SOLAS I/Reg.8 "Surveys of life-saving appliances and other equipment of cargo ships"</b></p> <p><b>SOLAS I/Reg.9 "Surveys of radio installations of cargo ships"</b></p> <p><b>SOLAS V/Reg.16 "Maintenance of equipment"</b></p> <p><b>Res.A.1140(31)</b> on SURVEY GUIDELINES UNDER THE HARMONIZED SYSTEM OF SURVEY AND CERTIFICATION (HSSC), 2019</p>	<p>Most of the requirements in UR N 1 are subject to a periodical survey items which should be confirmed by surveyors under the SOLAS requirements.</p>	<p>Yes</p>

## Appendix 2

### Other relevant instruments developed since approval of UR N 1 (November 1992) relating to bridge operations

#### 1. Amendment status of SOLAS Chapter V

1994 amend (Res.MSC.31(63)) : Reg.22 - Navigation bridge visibility

1995 amend (Res.MSC.46(65)) : Reg.8 - Routeing

1995 amend (SOLAS/CONF.3/46) : Reg.10-1 - Master's discretion for safe navigation

1995 amend (SOLAS/CONF.3/46) : Reg.23 - Operational limitations

1997 amend (Res.MSC.65(68)) : Reg.8-2 - Vessel traffic services

2000 amend (Res.MSC.99(73)) : SOLAS chapter V has been completely revised.

- *Heading or Track control system*
- *Means of correcting heading and bearings*
- *Properly adjusted transmitting heading device (THD)*
- *Back up arrangements for electronic nautical publications (not mandatory)*
- *Receiver for a global navigation satellite system /terrestrial radio navigation system*
- *Automatic tracking aid*
- *Second automatic tracking aid*
- *Electronic plotting aid*
- *ECDIS (not mandatory)*
- *Automatic identification system (AIS)*
- *Voyage data recorder (VDR)*
- *Speed and distance measuring device (over the ground in the forward and athwartship direction)*
- *Rate of turn indicator*
- *Sound reception system*

2002 amend (Res.MSC.123(75)) : Reg.21 - International Code of Signals

2002 amend (SOLAS/CONF.5/32) : Reg.19 - Carriage requirements for shipborne navigational systems and equipment

2003 amend (Res.MSC.142(77)) : Reg.22 - Navigation bridge visibility

2004 amend (Res.MSC.170(79)) : Reg.19 - Carriage requirements for shipborne navigational systems and equipment and Reg.20 - Voyage data recorders

2006 amend (Res.MSC.201(81)) : Reg.22 - Navigation bridge visibility

2009 amend (Res.MSC.282(86)) : Reg.19 - Carriage requirements for shipborne navigational systems and equipment

- *ECDIS (mandatory)*

- *Back up arrangements for ECDIS*

- *BNWAS*

2013 amend (Res.MSC.350(92)) : Reg.19 - Carriage requirements for shipborne navigational systems and equipment

## **2. IMO Resolutions or Circulars**

Res.A.813(19) : GENERAL REQUIREMENTS FOR ELECTROMAGNETIC COMPATIBILITY (EMC) FOR ALL ELECTRICAL AND ELECTRONIC SHIP'S EQUIPMENT

Res.A.916(22) : GUIDELINES FOR THE RECORDING OF EVENTS RELATED TO NAVIGATION

Res.A.1046(27) : WORLDWIDE RADIONAVIGATION SYSTEM

Res.MSC.86(70) : ADOPTION OF NEW AND AMENDED PERFORMANCE STANDARDS FOR NAVIGATIONAL EQUIPMENT

Res.MSC.191(79) : Performance standards for the presentation of navigation-related information on shipborne navigational displays

Res.MSC.252(83) : Revised performance standards for Integrated Navigation Systems (INS)

Res.MSC.467(101) : GUIDANCE ON THE DEFINITION AND HARMONIZATION OF THE FORMAT AND STRUCTURE OF MARITIME SERVICES IN THE CONTEXT OF E-NAVIGATION"

MSC/Circ.982 : GUIDELINES ON ERGONOMIC CRITERIA FOR BRIDGE EQUIPMENT AND LAYOUT

MSC/Circ.1061 : GUIDANCE FOR THE OPERATIONAL USE OF INTEGRATED BRIDGE SYSTEMS (IBS)

MSC.1/Circ.1474 : GUIDANCE ON THE BRIDGE NAVIGATIONAL WATCH ALARM SYSTEM (BNWAS) AUTO FUNCTION

MSC.1/Circ.1512 : GUIDELINE ON SOFTWARE QUALITY ASSURANCE AND HUMAN-CENTRED DESIGN FOR E-NAVIGATION

MSC.1/Circ.1593 : INTERIM GUIDELINES FOR THE HARMONIZED DISPLAY OF NAVIGATION INFORMATION RECEIVED VIA COMMUNICATION EQUIPMENT

MSC.1/Circ.1609 : GUIDELINES FOR THE STANDARDIZATION OF USER INTERFACE DESIGN FOR NAVIGATION EQUIPMENT

MSC.1/Circ.1612 : GUIDANCE FOR NAVIGATION AND COMMUNICATION EQUIPMENT INTENDED FOR USE ON SHIPS OPERATING IN POLAR WATERS

SN.1-Circ.288 : Guidelines For Bridge Equipment And Systems, Their Arrangement And Integration

### **3. IACS Resolutions**

SC 95 Communication between Navigating Bridge and Machinery Space

SC 194 Installation of electrical and electronic appliances on the bridge and vicinity of the bridge

SC 203 Carriage requirements for shipborne navigational systems and equipment

SC 235 Navigation bridge visibility to ship's side

UR E 10 Test Specification for Type Approval

UR E 22 On Board Use and Application of Computer based systems

Rec.52 Power Supply to Radio Equipment required by SOLAS Chapter IV, and Electrical/ Electronic Navigation Equipment required by SOLAS Chapter V, reg. 19

Rec.95 Recommendation for the Application of SOLAS Regulation V/15; Bridge Design, Equipment Arrangement and Procedures (BDEAP)

### **4. International standards (not for specific navigation equipment)**

ISO 14612, Ships and marine technology -- Ship's bridge layout and associated equipment -- Additional requirements and guidelines for centralized and integrated bridge functions

IEC 60945, Maritime navigation and radiocommunication equipment and systems — General requirements

IEC 61209, Maritime navigation and radiocommunication equipment and systems — Integrated bridge systems (IBS)- Operational and performance requirements, methods of testing and required test results

IEC 61924, Maritime navigation and radiocommunication equipment and systems — Integrated navigation systems — Operational and performance requirements, methods of testing and required test results

IEC 60533, Electrical and electronic installations in ships. Electromagnetic compatibility (EMC). Ships with a metallic hull

---

# IACS

INTERNATIONAL ASSOCIATION OF CLASSIFICATION SOCIETIES LTD.

PERMANENT SECRETARIAT: 4 Matthew Parker Street

Westminster, London SW1H 9NP, UNITED KINGDOM

TEL: +44(0)207 976 0660

INTERNET: [permsec@iacs.org.uk](mailto:permsec@iacs.org.uk) Web Site: [www.iacs.org.uk](http://www.iacs.org.uk)

---

October 2023

## History Files (HF) and Technical Background (TB) documents for URs concerning Pipes and Pressure Vessels (UR P)

Res. No.	Title	Current Rev.	HF/TB?
UR P1	Rules for pipes	Rev.5 Nov 2001	TB
UR P2	Rules for piping design, construction and testing		HF
UR P2.1	Rules for piping design, construction and testing – Application	Rev.3 Oct 2023	HF
UR P2.2	Classes of pipes	Rev.5 Oct 2023	HF
UR P2.7.3	Types of connections	Rev.3 Oct 2023	HF
UR P2.7.4	Mechanical joints	Rev.11 Oct 2023	HF
UR P2.9	Pressure tests of piping after assembly on board	Rev.3 Oct 2023	HF
UR P2.11	Type approval of mechanical joints	Rev.6 Oct 2023	HF
UR P2.12	Flexible hoses	Rev.3 Feb 2021	HF
UR P2.13	Installation	Rev.1 Jan 2021	HF
UR P3	Air Pipe Closing Devices	Rev.5 Apr 2021	HF
UR P4	Production and Application of Plastic Piping Systems on Ships	Rev.7 June 2022	HF
UR P5	Ballast water systems. Requirements on ballast water exchange at sea.	Del Apr 2011	TB
UR P6	Shell Type Exhaust Gas Heated Economizers That May Be Isolated From The Steam Plant System	Rev.1 June 2015	HF

### **P.1.2.7 Design pressure**

The design pressure  $P$  to be considered in formula (2) of P1.2.2 is the maximum working pressure and it is not to be less than the highest set pressure of any safety valve relief valve.

For special cases, the design pressure will be specially considered. For pipes containing ~~heated~~-fuel oil heated above 60 °C the design pressure is to be taken not less than 14 bar.”

## **Technical Background Document Review of UR P1.2.7 Design Pressure**

### **Objective and scope**

At the 20<sup>th</sup> Meeting of AHG/PPV ABS informed Members that this requirement was relocated from UR F35 (Rev. 2, 1992) however, further it was preceded by first para addressing fuel oils heated above 60 °C. ABS noted that existing formulation of UR is too strict for fuel oil transfer systems and proposed to review it.

### **Source of reviewed requirement**

IACS UR F F35 and P 1.2.7

### **Points of discussion**

Members unanimously agreed amendment of P1.2.7.

## Technical Background Documents

### 1. Review of UR P1 – P3

- Objective and Scope

Review of UR P1.2, P2.1, P2.2, P2.3, P2.5, and P3 has been carried out in line with annual Task 1A. The main goal of this review was elimination of ABS' reservation. As has been noted by ABS: "P1 & P2 have not been implemented since the ABS Rules are formatted around US standards such as ANSI, ASME, USC Regulations, etc. P 1 & P2 are not conducive (sic) to incorporate in the Rules". With regard to P3, it needed to be changed editorially.

Additional ABS comments relative to the UR P:

P 1.2.7:

- Do not regard 14 bar as design pressure, otherwise, strainers, filters, heaters will have to be designed for 14 bar which may not be practicable. Also the testing pressure for these components will need to be 1.5 the design pressure which may be a contentious issue. Accordingly ABS proposed that the 14 bar pressure should be considered as a special safeguard for the joints (see MSC Circ 647 & 851).
- Working Group needed to discuss and determine whether the 14 bar pressure was applicable to valves also. Further, ABS has been informed by their office in the Pacific that pressure rating of JIS f 7399-1989 "Marine Fuel oil Tank Emergency Shut-off valves", commonly used in that region, states that "Maximum working pressure shall be 0.098 MPa [ 1kg/cm<sup>2</sup> ], although hydraulic inspection for body will be 0.686 MPa. Accordingly, it would not be possible to apply the 14 bar pressure to the suction side of the pump.

IACS Permanent Secretariat Note: After a considerable length of discussion on the design pressure for the associated fittings in P1.2.7, GPG finally agreed to the Table 8. New P1.4 was developed for valves and fittings in the piping systems. (GPG s/n 0077a)

P 2.2 Table (1):

- There was a need to define what constitutes "special safeguard". ABS observation of member societies Rules indicated that there were no provisions made for application of this in the design, construction or operational matters.
- ABS requested the WG to develop a list of provisions which may be considered "special safeguards" for various systems conveying flammable, toxic or corrosive media.
- The reference to toxic and corrosive fluids may be out of place, as such systems were invariably cargo systems, which were outside the scope of P2. Accordingly considerations should be given to deleting this.

- Source of Proposed Requirements

ABS proposals on correction the UR P1, P2 and P3 circulated by e- mail dated 13 September 2000 has



Unanimous agreement has been achieved.

## **2. Review of UR P 2.7 Types of Connections**

- Objective and Scope

Review of UR P2.7 has been carried out in view that some types of widely used for essential service pipe joints have not been covered by existing URs.

- Source of Proposed Requirements

SOLAS - 74 as amended

IMO Res. A753 (18) "Guidelines for the application of plastic pipes on ships".

ISO/NP - 15837 Standard specification for performance of gasketed mechanical couplings for use in piping systems.

DNV Type approval of pipe couplings (Part of Certification Notes No 2.9)

GL Regulations for the Performance of Type Tests, section 9 " Pipe couplings", section 10 "Pipe unions".

ASTM F 1476 Standard specification for performance of gasket mechanical couplings for use in piping application.

ASTM F1387 Standard Specification for Performance of Mechanically Attached Fittings

JIS B 0151 Iron and steel pipe fittings - Vocabulary

JIS B 2351 25mpa (25 kg/cm<sup>2</sup>) bite type tube fittings for hydraulic use

- Points of discussion

Unanimous agreement has been achieved.

## **3. Review of UR P2.10**

- Objective and Scope

Shipyards are continuously asking to omit the hydraulic test prescribed for distant pieces by alternative method such as NDT based on their successful records and current practice.

- Source of Proposed Requirements

The existing UR P 2.10 and current practice of the Members.

### **Point of discussion**

It was noted that existing requirements to pipe strength calculation as well as to selection of pipe wall thickness can not be applied for distance pieces because their wall thickness are appointed depend upon the thickness of ship's shell. Some Societies are considering it as the part of ship structure but not the part of piping system. In this regard it was unanimously agreed to exclude "distance pieces" from P 2.10.

## UR P2.2, Table 1

- Objective and Scope

Review has been carried for harmonization of piping classification with new amendments to SOLAS Reg. II/15 “Arrangements for oil fuel, lubricating oil and other flammable oils”.

- Source of Proposed Requirements

SOLAS - 74 with Amendments,  
Rules of IACS Members.

- An unanimous agreement has been achieved.



## Technical Background Documents

### 1. Review of UR P1 – P3

- Objective and Scope

Review of UR P1.2, P2.1, P2.2, P2.3, P2.5, and P3 has been carried out in line with annual Task 1A. The main goal of this review was elimination of ABS' reservation. As has been noted by ABS: "P1 & P2 have not been implemented since the ABS Rules are formatted around US standards such as ANSI, ASME, USC Regulations, etc. P 1 & P2 are not conducive (sic) to incorporate in the Rules". With regard to P3, it needed to be changed editorially.

Additional ABS comments relative to the UR P:

P 1.2.7:

- Do not regard 14 bar as design pressure, otherwise, strainers, filters, heaters will have to be designed for 14 bar which may not be practicable. Also the testing pressure for these components will need to be 1.5 the design pressure which may be a contentious issue. Accordingly ABS proposed that the 14 bar pressure should be considered as a special safeguard for the joints (see MSC Circ 647 & 851).
- Working Group needed to discuss and determine whether the 14 bar pressure was applicable to valves also. Further, ABS has been informed by their office in the Pacific that pressure rating of JIS f 7399-1989 "Marine Fuel oil Tank Emergency Shut-off valves", commonly used in that region, states that "Maximum working pressure shall be 0.098 MPa [ 1kg/cm<sup>2</sup> ], although hydraulic inspection for body will be 0.686 MPa. Accordingly, it would not be possible to apply the 14 bar pressure to the suction side of the pump.

IACS Permanent Secretariat Note: After a considerable length of discussion on the design pressure for the associated fittings in P1.2.7, GPG finally agreed to the Table 8. New P1.4 was developed for valves and fittings in the piping systems. (GPG s/n 0077a)

P 2.2 Table (1):

- There was a need to define what constitutes "special safeguard". ABS observation of member societies Rules indicated that there were no provisions made for application of this in the design, construction or operational matters.
- ABS requested the WG to develop a list of provisions which may be considered "special safeguards" for various systems conveying flammable, toxic or corrosive media.
- The reference to toxic and corrosive fluids may be out of place, as such systems were invariably cargo systems, which were outside the scope of P2. Accordingly considerations should be given to deleting this.

- Source of Proposed Requirements

ABS proposals on correction the UR P1, P2 and P3 circulated by e- mail dated 13 September 2000 has

Unanimous agreement has been achieved.

## **2. Review of UR P 2.7 Types of Connections**

- Objective and Scope

Review of UR P2.7 has been carried out in view that some types of widely used for essential service pipe joints have not been covered by existing URs.

- Source of Proposed Requirements

SOLAS - 74 as amended

IMO Res. A753 (18) "Guidelines for the application of plastic pipes on ships".

ISO/NP - 15837 Standard specification for performance of gasketed mechanical couplings for use in piping systems.

DNV Type approval of pipe couplings (Part of Certification Notes No 2.9)

GL Regulations for the Performance of Type Tests, section 9 " Pipe couplings", section 10 "Pipe unions".

ASTM F 1476 Standard specification for performance of gasket mechanical couplings for use in piping application.

ASTM F1387 Standard Specification for Performance of Mechanically Attached Fittings

JIS B 0151 Iron and steel pipe fittings - Vocabulary

JIS B 2351 25mpa (25 kg/cm<sup>2</sup>) bite type tube fittings for hydraulic use

- Points of discussion

Unanimous agreement has been achieved.

## **3. Review of UR P2.10**

- Objective and Scope

Shipyards are continuously asking to omit the hydraulic test prescribed for distant pieces by alternative method such as NDT based on their successful records and current practice.

- Source of Proposed Requirements

The existing UR P 2.10 and current practice of the Members.

### **Point of discussion**

It was noted that existing requirements to pipe strength calculation as well as to selection of pipe wall thickness can not be applied for distance pieces because their wall thickness are appointed depend upon the thickness of ship's shell. Some Societies are considering it as the part of ship structure but not the part of piping system. In this regard it was unanimously agreed to exclude "distance pieces" from P 2.10.

## Summary of comments of IACS AHG/PPV on External review of UR P2.7.4 & P2.11.

March 2001

Items of UR	Comments and proposals of external bodies on UR P 2.7.4 & P2.11 drafts	Decisions and proposed answers to external bodies developed by AHG/PPV
<b>CHIBRO COMO FAX No 235/SP/00gc dated 03.07.2000</b>		
<b>UR P2.7.4</b>		
Table 7	Include drawing of Pressfitting Type connection under heading Compression Couplings	Agree. Draft will be modified. Term Press Type will be used instead of term Pressfitting Type. Pressfitting is proprietary name and should not be included. Press Type is to be used as generic description. The use of such connections is to be restricted to Class III piping systems and is not to be accepted in steam systems. As the connections include a rubber seal ring they are to be restricted to service as for slip-on joints
Table 8	Ditto	Agree.
Table 9	Ditto	Agree.
<b>UR P 2.11</b>		
Table 10	Include “may be performed simultaneously with vibration test”	Disagree. Actual situation on board is that vibration and pressure pulsation are presented simultaneously
	Include column “pressfitting joints and similar”	Disagree. Press Type is covered by headline Compression couplings Note 2 will be modified as following: “except .press type
	Replace P2.11.5.3.8 with P2.11.5.5.8	Agree.
P2.11.2	First line. Add “pressfitting”	Disagree. Comment as comment above to Table 10.
P2.11.3	First line. Add phrase “or by delegate Company”	Disagree. This proposal contradicts with the existing procedures and common practice of the Classification Societies.

	Add phrase “linear thermal expansion related to the fluid temperature”	Disagree. Relates to specific items only. Specific items should be considered on case by case basis.
P2.11.4	Change the second phrase as following: “The manufacturer has to submit the evidence .that, <u>all the components</u> are adequately resistant to working the media at <u>declared</u> design pressure and temperature	Agree. Phrase will be changed as following: “. all the components are adequately resistant to working the media at design pressure and temperature specified.”
P2.11.5.2	Include “(maximum, minimum and intermediate sizes)”.	Disagree. This inclusion would implicitly require a test on the minimum size and on the maximum size precisely, which is not necessary. For example, range is ND20 to ND500. Size ND40, ND250 and 450 could be representative of the range. ND20 and ND500 are not necessary to be tested.
P2.11.5.3	Add as following: “Were not specified, the length of pipes/tubing to be connected by means of the joint to be tested will be long at least five time of their diameter. Before assembling the joint it shall be verified the conformity of components to the design requirements. <u>In all cases the assembly of the joint shall be carried out only according to the manufacturer’ s instructions.</u> <u>No adjustment operations on the joint assembly, other than that specified by the manufacturer, are permitted during the test.</u> ”	Agree. Phrase will be changed as following: “Where not specified, the length of pipes to be connected by means of the joint to be tested is to be at least five times of pipe diameter. Before assembling the joint, conformity of components to the design requirements, is to be verified. In all cases the assembly of the joint shall be carried out only according to the manufacturer’ s instructions. No adjustment operations on the joint assembly, other than that specified by the manufacturer, are permitted during the test.”
P2.11.5.5.1a)	Change the forth para as following: ”No visual indication leakage or slip out is permitted. In the event where there is a drop in pressure and there is visual indication of leakage or slip off, the test may be repeated.”	Disagree. To leave the initial sentence disregarding the proposal. Reason: since tests refer only to the tightness of joints.
P2.11.5.5.2a)	The first line. Add “pressfitting joints” after “pipe unions”	Disagree. Comment as in P2.11.2 above.

	The third para : add “1.5 of” before the word “design”	Disagree. Not necessary because these are tightness tests and in line with appropriated practice, tightness tests are to be carried out at design pressure.
	Change “5%” to “+5%”	Disagree. Proposal is in contradiction with the text.
P2.11.5.5.3	The first line. Add “pressfitting joints” after “pipe unions”	Disagree. Comment as in P2.11.2 above
P2.11.5.5.4	The third para, add sentence by phrases; “at the maximum pressure. Then the pressure will be increased till the breaking-off. This pressure value will be annotated.	Agree partially. Text will be added by phrase: “ ..at the maximum pressure. This pressure value will be annotated.”
	Add “with an increasing rate of 10% per minute” after words “test pressure”.	Agree. Text will be added by phrase: “with an increasing rate of 10% of test pressure per minute”.
	The second para. Delete “and the manufacturer instructions” after reference to P2.11.5.3.	Agree.
P2.11.5.5.6	The second para, first line change “30” to “60”. Add “±10%” after “800 <sup>0</sup> C”	To leave the initial wording as it is. Reference is made to IACS Unified Requirements UR F42 that is accepted as fire proof test.
P2.11.5.5.7	The second para. Add “(3 min)’ after words “is stabilized”. Change 5 to 15 in the end of sentence.	Disagree. No use in applying such changes.
P2.11.5.5.7	2 <sup>nd</sup> §: Include “test specimen” after “mechanical joint assembly”	Agree.
	Add “+5%” after “170 mbar”	Disagree. To leave the initial sentence as it is. No use in applying such changes.
<b>Tailor Kerr Engineering Ltd, FAX No? Dated 23.07.00 and 24.07.00</b>		
1	It is proposed to use definition of ASTM 1476 for	Disagreed.

	identification of different kind of pipe connections	Definition of ASTM 1476 can not be used due to contradictions both accepted classification of joints and terminology.
2	Use symbol from DIN 86128 for identification the Gripe type MJ	Disagreed. Each Society has the right to accept any National or International standard, which has not contradictions with URs.
3	Adopt fireproof test as prescribed by DIN 86230BS ISO EN 1155140:1999 accept the existing test.	Disagreed. Comment as above.
P2.11.5.5.3	Change recommended pressure pulsation test to simple on/of pump test as less expensive.	Disagree. Actual situation on board is that vibration and pressure pulsation are presented simultaneously.
P2.11.5.5.6	It is proposed to point out position of the measuring thermocouple and place it on 50 mm directly below the specimen.  Noted that specimen should be completely engulfed in the flame envelope.	Disagree. The sentence is clear enough. This temperature is temperature on the surface of joint.  The 2 <sup>nd</sup> sentence – agree. Text will be changed.
<b>Ihara Science corp., FAX No 00033 dated 16.07.00</b>		
P2.11.5.5.2	(1) Usage of oil as test fluid is proposed.	Agree. Oil, as testing fluid will be specified.
	(2) This proposal is not clear understood.	The specimen shown is not intended to depict any specific type of joint. The diagram will be changed to avoid misunderstanding.
	(3) Distance identified as 30 mm has to be differ depending upon the OD of tested specimen	Disagree. Figure 1 is to be corrected. Distance of 30 mm will be indicated as distance till nearest edge of the joint.
P2.11.5.5.3	(1) Trapezoidal waveform diagram with maximum pressure of 1.33 rated pressure in line with ISO 6803 is recommended for pressure pulsation test	Disagree. Connections are intended to marine service is to meet to stricter standard.
	(2) Reason for adoption of test pressure equal 1.5 of rated pressure is requested	Systems are required by the rules to withstand pressure $1.5 \times$ design pressure i.e. relief valves setting. Accordingly all components within a system should be designed for the same parameters.
	(3) Usage of oil as test fluid is proposed.	Agree. Oil as testing fluid will be specified



	(4) Separation of pressure pulsation and vibration test is requested	Disagree. Actual situation on board is that vibration and pressure pulsation present simultaneously.
P2.11.5.5.4	Usage of oil as test fluid is proposed	Agree. Oil as testing fluid will be specified
P2.11.5.5.5	Usage of inert gas as alternative selective option for sealed pressurized fluid is proposed	To leave the text as it is. Detection of gas leakage requires specialist equipment and the stored energy in large connections may introduce hazard.
P2.11.5.5.6	Point out acceptable level of temperature tolerance	Disagree. Reference is made to IACS Unified Requirements UR F42 that is accepted as fire proof test.
P2.11.5.5.8	Reduce number of assembling - disassembling to 8 times.	Disagree. Connections are intended to marine service are to meet stricter standard.
<b>Straube Werke, FAX dated 24.07.00</b>		
<b>UR P2.7.4</b>		
P2.7.4.2	First line. Add the phrase “or the pipe can get crushed” after “...wall thickness”	Disagree. “Crushed” implies pipe destruction, which is not the intent of the requirement.
P2.4.7	Cancel. This problem exists with every pipe joining method.	Disagree. This is contained in every Classification Society Rules.
P2.4.7.9	Cancel. If P2.7.4 is followed, there is no supplementary danger on oil systems.	Disagree Ditto.
P2.7.4.11	Change as following ”Slip-on joints can be used in pipe lines in cargo holds, tanks, and other spaces which are not easy accessible, limitation of use can be made by the Classification Society.	Disagree. Ditto.

Table 8	Change footnote 2 as following: “Has to be approved by Classification Society for use inside machinery spaces of category A. Is accepted in other Machinery spaces providing the joints are located in easily visible and accessible positions.	Disagree. Ditto
P2.11.5.5.6	Fire endurance test installation and accomplishment has to be identical to ISO 19921 respectively DIN 86232	Disagree. Ditto
<b>RASMUSSEN GMBH FAX No WB / uu dated 12.07.2000</b>		
<b>UR P2.7.4.</b>		
P2.7.1	1) Knob out test is recommended	Disagree. P2.7.1.2 is not connected with P2.7.4.
P2.7.4.9	2) Rasmussen’ s couplings are suitable for this type of application	Noted.
P2.7.4.10	3) Rasmussen’ s couplings able to compensate some defects cause by incorrect mounting	Noted.
P2.7.4.11	4) Rasmussen’ s couplings can be used in this condition provided there are fixed points and supports for each pipe lengths.	Noted.
Table 7	5) Include the drawing of Flex type connection	Agree. Table 7 will be added by the drawing under heading “Slip Type”.
Table 8	6) Make some changes in application of Slip-on joints	Disagree. To leave it as it is. Proposed changes of application of Slip-on joints are in contrary with requirements of each Society Rules.
Table 9	7) The wall thickness should be added for Class I, II and III as well as for materials steel, stainless steel and CuNi10Fe	Disagree. To leave it as it is. Comment as a.m.
<b>P2.11</b>		
P2.11.5	The axial forces should be defined by manufacturer.	Disagree. Contradicts with the common practice of IACS Members.

<b>VICTAULIC FAX dated 02.10.2000, e-mail of 29.09.2000</b>		
UR P2.7.4 & P2.7.11	To make clear distinction between Grooved Type and Grip/Slip Type joints couplings and include Grooved Type Joints in the figures contained in the drafts	Agree. Text of UR P2.7.4 and P2.11 will be corrected taking into account Victaulic' s proposals.
P2.11.5.5.6	Victaulic grooved couplings should be accepted for all areas requiring fire resistant pipe connections without additional testing	Disagree. Contradicts with the common practice of IACS Members.
<b>Parker Hanfin Corporation, e-mail of 13.10.2000</b>		
1)	<p>Parker Hannifin Corporation is submitting suggestions, questions and clarification <b>only</b> for mechanical joints falling into:</p> <p>Compression Coupling category.</p> <p>A) Bite-Type</p> <p>B) Flared Type</p> <p>No comments are targeted at the Welded/Brazed, Grip or Slip type categories.</p>	Noted
2)	<p>The document uses the terms "pipe" and "piping."</p> <p>Recommend:</p> <p>A) replace "pipe" with "tube/pipe"</p> <p>B) replace "piping" with "tubing/piping"</p> <p>Most bite-type and flared type Compression Couplings are designed for use with tube. Separation of pressure pulsation and vibration test is requested</p>	Disagree .IACS Requirements as well as Classification Society Rules do not differentiate between tubing and piping. Terminology pipe uses through out a.m. documents. Usage of another terminology in one specific documents may cause confusion

3)	It is our understanding that O-Ring Face Seal (ISO-8434-3) tube fittings and tube connection methods (Silver Braze and Mechanical Flange) would be categorized in the Compression Coupling Flared Type. O-Ring Face Seal Fittings are used extensively in hydraulic systems and are currently meet the demanding performance testing mandated by ABS and DNV classed vessels. The “Examples of Mechanical Joints” – Table 7 within P.2.7.4 is not clear as to the inclusion of aforementioned fittings.	The opinion of IACS expert group is that where joints imply flanges whether the sealing is by means of joints or O – rings, these will be considered as a non standard flange connections, which are covered by UR P2.7.2.
4)	Most manufacturers of compression and flare fittings currently rely on ISO-8434 as the governing body for dimensional, performance and testing requirements. ISO 8434-5 currently mandates performance testing of these types of mechanical connections. Many of the IACS proposed unified testing requirements are already addressed in ISO-8434-5. It is our recommendation that IACS adopt these industry standard testing requirements where appropriate. A copy has been attached for IACS technical body/expert review.	Disagree. Each Society has the right to accept any National or International standard, which has stricter testing requirements.
<b>UR P2.11</b>		
P2.11.1	1 <sup>st</sup> sentence: change “intending” to “intended”	Agree.
Table 10	Why is flare type excluded from the repeated assembly test?	Agree. Note 2 of Table 10 will be corrected.
Fig. 1 and Fig. 3	Is 150% PD considered an instantaneous spike pressure? If yes, is it a targeted spike or just a permissible aberration?	This is an instantaneous spike pressure. It is a targeted spike. Corresponding changes will be made in Fig.3.

P2.11.5.5.2 a)	S —. on 0.25 of the yield stress: change “stress” to “strength”	Disagree. “Stress” is common appropriate term when are speaking about the allowable yield stress.
P2.11.5.5.3	1 <sup>st</sup> sentence, 3 <sup>rd</sup> line: change “assembles” to “assemblies”	Agree.
P2.11.5.5.4	3 <sup>rd</sup> paragraph: change “5 minutes” to “0.5 minute”	Disagree. Time period of 0.5 min is considered as too short time for visual inspection.
P2.11.5.5.5	What is the rationale behind the equation L ?	Agree. It will be replaced with phi/4.
P2.11.5.5.7	1 <sup>st</sup> sentence, 2 <sup>nd</sup> line: change “to encounter” to “to be encountered”	Agree.
<b>DEUTSCH METAL COMPONENTS, FAX of 10.06.2000</b>		
P2.11	Question: What specification ... 10 <sup>7</sup> cycles based on ?	This value is specified by ISO 8434-5.
<b>THERMO SEALED CASTINGS/LOKRING TECH., 23.11.2000</b>		
Table 7 and 8	Include “Mechanically Attached Fittings”	Agree. Tables 7 & 8 will be modified and added by <u>Machine grooved Type connections</u> .
	“MAF” considered to be equivalent to welding.	Disagree. In accordance with IACS UR P2.7 welded connections are considered as separate type with other scope of application.
Table 9	Include separate line for “MAF”	Agree. Table 9 will be modified.
P2.11.5.5.2	Use of doc. “QUALIFICATION OF NON-STANDARD PIPING ., B31 APPLICATIONS” as an alternative for vibration tests.	Disagree. Each Society has the right to accept any National or International standard, which has stricter testing requirements.
P2.11.5.5.6	API 607 considered as alternative.	Disagree. Comments as above.
<b>TYCO FIRE PRODUCTS, FAX of 04.10.2000</b>		
P 2.7.4, Table 7	Add picture of grooved coupling connection	Agree. Tables 7 and 8 will be modified and added by Machine grooved Type connection.

P 2.7.4, Table 8	Add grooved couplings only for use with the items listed in seawater category.	Disagree. Scope of application of <u>Machine grooved</u> <del>Cut/Roll Grooved</del> Type connections are considering in long term are not to be restricted so far.
P2.11	ISO 6182-12 standard should be referenced for testing and qualification of the couplings.	Disagree. Each Society has the right to accept any National or International standard, which has stricter testing requirements.

## UR P2.1 Application

### Summary

In Rev.3 of this UR, the applicability of UR P2 has been clarified, in relation with IMO instruments such as IBC Code, IGC Code and IGF Code.

### Part A. Revision History

Version no.	Approval date	Implementation date when applicable
Rev.3 (Oct 2023)	9 October 2023	1 January 2025
Rev.2 (Nov 2001)	-	-
Rev.1 (1987)	-	-
Original version (1981)	-	-

#### • Rev.3 (Oct 2023)

##### 1 Origin of Change:

- Suggestion by IACS member

##### 2 Main Reason for Change:

To clarify the applicability of piping systems in relation to IMO instruments concerned.

##### 3 List of non-IACS Member classification societies contributing or participating in IACS Working Group:

None.

##### 4 History of Decisions Made:

- 1) In the course of work to avoid overlapping between UR P1 and IMO instruments concerned, it was observed that the last paragraph of UR P2.1 should also be amended in a similar manner to UR P1.1.
- 2) It was decided that the revision of UR P1 and P2 will be carried out under task PM20906f, taking into account the scope of work in the approved Form A for PM20906
- 3) After rounds of discussion, this Panel has fixed the amendment on applicability and for the purpose of clarity rephrased the title of P2.1 as "Applicability" and set out new paragraphs for IMO instrument concerned.

##### 5 Other Resolutions Changes:

UR P1 (Rev.6). UR P2.2 (Rev.5)

##### 6 Any hinderance to MASS, including any other new technologies:

None.

## 7 Dates:

Original Proposal : 07 September 2020 (Ref: PM20304eIMf)  
Panel Approval : 07 September 2023 (Ref: PM16301fIMzg)  
GPG Approval : 09 October 2023 (Ref: 23164\_IGc)

- **Rev.2 (Nov 2001)**

No HF is available.

- **Rev.1 (1987)**

No HF or TB is available.

- **New (1981)**

No HF or TB is available.

\*\*\*\*\*



## **Part B. Technical Background**

List of Technical Background (TB) documents for UR P2.1:

Annex 1. **TB for Rev.3 (Oct 2023)**

See separate TB document in Annex 1.

**Note:**

*No Technical Background (TB) documents are available for original version and Rev.1.*

*Technical Background (TB) for Rev.2 (Nov 2001) can be found the consolidated "Technical Background for URs".*

## **Technical Background (TB) document for UR P2.1 (Rev.3 Oct. 2023)**

### **1. Scope and objectives**

To clarify the applicability of piping systems in relation to IMO instruments concerned.

### **2. Engineering background for technical basis and rationale**

Although it is acknowledged that certain types of piping systems addressed in the related IMO instruments such as IGC Code, IGF Code are not covered by UR P1 and P2, the applicability of the URs has not been updated since 2001.

#### **2a. Specification of the data utilised in the development/revision of the proposed IACS Resolution, if any**

None.

### **3. Source/derivation of the proposed IACS Resolution**

None.

### **4. Summary of Changes intended for the revised Resolution:**

- 1) Title of P2.1 has been rephrased as "Application" to better reflect the intent of the Section.
- 2) The piping systems not falling under the UR P2 are clearly defined in a new paragraph P2.1.2, with separate sub-paragraphs dedicated to IBC Code, IGC Code/IGF Code and SOLAS regulation II-1/2.29.

### **5. Points of discussions or possible discussions**

A member opined that the term "process piping" should not be specified for ships subject to the IBC Code and after rounds of discussion it was decided to retain the term "process piping" as shipboard hydrocarbon/chemical process piping system in UR P2.1.2.1.

### **6. Attachments if any**

None

## UR P2.2 Classes of pipes

### Summary

In Rev.5 of this UR, the Table 1 has been revisited.

### Part A. Revision History

Version no.	Approval date	Implementation date when applicable
Rev.5 (Oct 2023)	9 October 2023	1 January 2025
Rev.4 (Nov 2001)	-	-
Rev.3 (May 2000)	-	-
Rev.2 (1987)	-	-
Rev.1 (1975)	-	-
Original version (1974)	-	-

#### • Rev.5 (Oct 2023)

##### 1 Origin of Change:

- Suggestion by IACS member

##### 2 Main Reason for Change:

To refine the Table 1 of UR P2.2, also investigation the request from Industry (CIMAC) on the classification of piping intended for the use of "urea".

##### 3 List of non-IACS Member classification societies contributing or participating in IACS Working Group:

None.

##### 4 History of Decisions Made:

- 1) While considering the revision of UR P2.1, it was found that the term "Liquefied Gas" in Table 1 of UR P2.2 may need to be revisited.
- 2) It was decided that the revision of UR P1 and P2 will be carried out under task PM20906f, taking into account the scope of work in the approved Form A for PM20906.
- 3) Since the Panel could not find technical rationale to regard the piping downstream from the storage tank closing valve to the SCR catalyst belonging to Class III for application of UR P2.2, MP Chair requested CIMAC to provide the technical reasons.

##### 5 Other Resolutions Changes:

UR P2.1 (Rev.3)

**6 Any hinderance to MASS, including any other new technologies:**

None.

**7 Dates:**

Original Proposal : 07 October 2020 (Ref: PM20304eIMg)  
Panel Approval : 07 September 2023 (Ref: PM16301fIMzg)  
GPG Approval : 09 October 2023 (Ref: 23164\_IGc)

• **Rev.4 (Nov 2001)**

No HF is available.

• **Rev.3 (May 2000)**

No HF or TB is available.

• **Rev.2 (1987)**

No HF or TB is available.

• **Rev.1 (1975)**

No HF or TB is available.

• **New (1974)**

No HF or TB is available.

\*\*\*\*\*

## **Part B. Technical Background**

List of Technical Background (TB) documents for UR P2.2:

Annex 1. **TB for Rev.5 (Oct 2023)**

See separate TB document in Annex 1.

**Note:**

*No Technical Background (TB) documents are available for Original version, Rev.1, Rev.2 and Rev.3.*

*Technical Background (TB) for Rev.4 (Nov 2001) can be found the consolidated "Technical Background for URs".*

## **Technical Background (TB) document for UR P2.2 (Rev.5 Oct. 2023)**

### **1. Scope and objectives**

To refine the Table 1 of UR P2.2, also investigation the request from Industry (CIMAC) on the classification of piping intended for the use of "urea".

### **2. Engineering background for technical basis and rationale**

In parallel with the clarification that certain types of piping systems addressed in the related IMO instruments such as IGC Code, IGF Code are not covered by UR P1 and P2, the Table 1 of UR P2.2 was also revisited, in particular the applicability of the term "Liquified Gas".

### **2a. Specification of the data utilised in the development/revision of the proposed IACS Resolution, if any**

None.

### **3. Source/derivation of the proposed IACS Resolution**

None.

### **4. Summary of Changes intended for the revised Resolution:**

- 1) The term "Liquefied Gas" has been removed from the Table 1, taking into account revision of UR P1 and P2.
- 2) Table 1 is modified to address the Industry (CIMAC) request concerning the piping downstream from the storage tank closing valve to the SCR catalyst (UR M77)

### **5. Points of discussions or possible discussions**

Industry (CIMAC) raised an issue related to the piping downstream from the storage tank closing valve to the SCR catalyst belonging to Class III for application of UR P2.2.

Due to lack of qualified majority support and no clear technical rationale, MP Chair requested CIMAC to provide the technical reasons.

The CIMAC rationale based on ISO 18611-3:2014 was reviewed by the Panel and reflected in Table 1 and Notes thereto which are applicable to the piping downstream from the storage tank closing valve to the SCR catalyst (UR M77).

### **6. Attachments if any**

None

## UR P2.7.3 Slip-on threaded joints

### Summary

In Rev.3 of this UR, the use of threaded joints for small bore instrumentation equipment into piping systems conveying flammable media has been investigated and clarified.

### Part A. Revision History

Version no.	Approval date	Implementation date when applicable
Rev.3 (Oct 2023)	9 Oct 2023	1 January 2025
Rev.2 (Nov 2001)	-	-
Rev.1 (1987)	-	-
Original version (1974)	-	-

#### • Rev.3 (Oct 2023)

##### 1 Origin of Change:

- Suggestion by IACS member

##### 2 Main Reason for Change:

To clarify the usage of threaded joints for small bore instrumentation equipment into piping systems conveying flammable media.

##### 3 List of non-IACS Member classification societies contributing or participating in IACS Working Group:

None.

##### 4 History of Decisions Made:

- 1) The Panel investigated the industry practice in several yards to utilize threaded joints for connecting small bore instrumentation equipment (pressure/temp. sensors) to fuel oil lines, which is now against UR P2.7.3.
- 2) After rounds of discussion, this Panel has fixed the requirement for slip-on threaded joints to the end, with limitation on maximum outside diameter of such piping and example of recognized standards.

##### 5 Other Resolutions Changes:

None.

##### 6 Any hinderance to MASS, including any other new technologies:

None.

## 7 Dates:

Original Proposal	: 10 May 2022	(Ref: PM22301_IMa)
Panel Approval	: 07 September 2023	(Ref: PM16301fIMzg)
GPG Approval	: 09 October 2023	(Ref: 23163_IGc)

- **Rev.2 (Nov 2001)**

No HF is available.

- **Rev.1 (1987)**

No HF or TB is available.

- **New (1974)**

No HF or TB is available.

\*\*\*\*\*



## **Part B. Technical Background**

List of Technical Background (TB) documents for UR P2.7.3:

Annex 1. **TB for Rev.3 (Oct 2023)**

See separate TB document in Annex 1.

**Note:**

*No Technical Background (TB) documents are available for Original version and Rev.1.*

*Technical Background (TB) for Rev.2 (Nov 2001) can be found the consolidated "Technical Background for URs".*

## **Technical Background (TB) document for UR P2.7.3 (Rev.3 Oct. 2023)**

### **1. Scope and objectives**

To clarify the usage of threaded joints for small bore instrumentation equipment into piping systems conveying flammable media.

### **2. Engineering background for technical basis and rationale**

The Panel investigated the industry practice in several yards to utilize threaded joints for connecting small bore instrumentation equipment (pressure/temp. sensors) to fuel oil lines, which is now against UR P2.7.3 but found to be permitted in international standards for slip-on threaded joints such as ASME B31.1 and ASME 31.3.

### **2a. Specification of the data utilised in the development/revision of the proposed IACS Resolution, if any**

None.

### **3. Source/derivation of the proposed IACS Resolution**

None.

### **4. Summary of Changes intended for the revised Resolution:**

- 1) this Panel has fixed the requirement for slip-on threaded joints to the end, with limitation on maximum outside diameter of such piping and example of recognized standards.

### **5. Points of discussions or possible discussions**

A member proposed to remove the size limitation of O.D 25mm, which was shared by several members but not supported by the majority.

### **6. Attachments if any**

None.

## UR P2.7.4 “Mechanical joints”

### Summary

In Rev.11 of this UR, the requirements for mechanical joints were reviewed with respect to definition, applicability and size limitation.

### Part A. Revision History

Version no.	Approval date	Implementation date when applicable
Rev.11 (Oct 2023)	09 October 2023	1 January 2025
Rev.10 (Jan 2021)	25 January 2021	1 July 2022
Rev.9 (Oct 2018)	13 October 2018	1 January 2020
Rev.8 (Mar 2016)	2 March 2016	1 January 2017
Rev.7 (Sept 2007)	21 September 2007	-
Rev.6 (May 2006)	12 May 2006	-
Rev.5 (Nov 2003)	20 November 2003	1 January 2007
Rev.4	-	-
Rev.3	-	-
Rev.2	-	-
Rev.1	-	-
Original version	-	-

#### • Rev.11 (Oct 2023)

##### 1 Origin of Change:

- Suggestion by IACS member

##### 2 Main Reason for Change:

There was a suggestion for Press type joint to extend the applicability to Class I and II piping systems, while giving a clear definition of Swage and Press type joint and possible change of the terms for the two joints. The Panel had rounds of discussion over the suggestion, together with other revision proposals such as pressure pulsation test and deletion of size limitation for certain type of joints.

##### 3 List of non-IACS Member classification societies contributing or participating in IACS Working Group:

None

#### **4 History of Decisions Made:**

The Panel prepared a draft version of the UR and decided to have an Industry Hearing, in order to listen to Industry Opinion and improve the UR in due consideration of Industry Advice and relevant International Standards etc. in practice. After thorough review of the Industry Hearing and following deliberations at the Panel, this revision of UR has been finalized.

#### **5 Other Resolutions Changes:**

P2.11 (Rev.6) is also revised under the same task number.

#### **6 Any hinderance to MASS, including any other new technologies:**

None

#### **7 Dates:**

Original Proposal:	16 April 2019	(by a Member)
Panel Approval:	07 September 2023	(Ref: PM16301fIMzg)
GPG Approval:	09 October 2023	(Ref: 23164_IGc)

#### **• Rev.10 (Jan 2021)**

##### **1 Origin of Change:**

Suggestion by IACS member

##### **2 Main Reason for Change:**

To amend UR P2.7.4 to provide a new Table 7 with a classification according to service condition for each piping system (dry, wet, dry/wet) and develop appropriate fire test requirements in P2.11.5.5.6.

##### **3 List of non-IACS Member classification societies contributing or participating in IACS Working Group:**

None

#### **4 History of Decisions Made:**

The Machinery Panel commented on revisions by correspondence and at regularly scheduled meetings.

#### **5 Other Resolutions Changes:**

None

#### **6 Any hinderance to MASS, including any other new technologies:**

None

## 7 Dates:

Original Proposal: 13 June 2016 (Made by a Member)  
Panel Approval: 12 November 2020 (Ref: PM16301\_IMzf)  
GPG Approval: 25 January 2021 (Ref: 14079aIGe)

### • Rev.9 (Oct 2018)

#### .1 Origin of Change:

Suggestion by IACS member

#### .2 Main Reason for Change:

To amend UR P2.7.4 to provide a picture for typical compression type mechanical joints and clarify applicability of limitation in use of slip on joints.

#### .3 List of non-IACS Member Classification Societies contributing through the TC Forum and/or participating in IACS Working Group:

None

#### .4 History of Decisions Made:

The Machinery Panel commented on revisions by correspondence and at regularly scheduled meetings.

#### .5 Other Resolutions Changes:

None

#### .6 Dates:

Original Proposal: 28 February 2017 made by a Member  
Panel Approval: 20 September 2018 (Ref: 28th Panel meeting)  
GPG Approval: 13 October 2018 (Ref: 18028\_IGn)

### • Rev.8 (Mar 2016)

#### .1 Origin of Change:

Suggestion by IACS member

#### .2 Main Reason for Change:

To review the application and details of fire resistant type tests for mechanical joints.

#### .3 List of non-IACS Member Classification Societies contributing through the TC Forum and/or participating in IACS Working Group:

None

**.4 History of Decisions Made:**

The Machinery Panel commented on revisions by correspondence and at regularly scheduled meetings.

**.5 Other Resolutions Changes:**

P2.11 (Rev.4) and P2.12 (Rev.2) are also revised under the same task number.

**.6 Dates:**

Original Proposal: 30 January 2012 Made by a Member  
Panel Approval: 28 December 2015 (Ref: PM11921)  
GPG Approval: 2 March 2016 (Ref: 14079\_IGe)

• **Rev.7 (Sept 2007)**

No history file or TB document available.

• **Rev.6 (May 2006)**

No history file or TB document available.

• **Rev.5 (Nov 2003)**

No history file or TB document available.

• **Rev.4**

No history file or TB document available.

• **Rev.3**

No history file or TB document available.

• **Rev.2**

No history file or TB document available.

• **Rev.1**

No history file or TB document available.

• **Original version**

No history file or TB document available.

\*\*\*\*\*

## Part B. Technical Background

List of Technical Background (TB) documents for UR P2.7.4:

Annex 1. **TB for Rev.5 (Nov 2003)**

See separate TB document in Annex 1.

Annex 2. **TB for Rev.6 (May 2006)**

See separate TB document in Annex 2.

Annex 3. **TB for Rev.7 (Sept 2007)**

See separate TB document in Annex 3.

Annex 4. **TB for Rev.8 (Mar 2016)**

See separate TB document in Annex 4.

Annex 5. **TB for Rev.9 (Oct 2018)**

See separate TB document in Annex 5.

Annex 6. **TB for Rev.10 (Jan 2021)**

See separate TB document in Annex 6.

Annex 7. **TB for Rev.11 (Oct 2023)**

See separate TB document in Annex 7.

**Note:** *There are no Technical Background (TB) documents available for Original Version, Rev.1, Rev.2, Rev.3 and Rev.4.*

## Technical Background

### UR M44 Rev.6 and P2 Rev.5

The UK MAIB report on its investigation of the causes of an engine fire in the high-speed ferry 'Stena Explorer' concluded that it was due to the incorrect reassembly of a compression fitting in a high pressure fuel line.

IACS did not concur in the MAIB recommendation to discontinue the use of such fittings, and so advised the MAIB in a letter from the GPG Chairman on 15 September 2003 (3051\_IGb).

However WP/MCH proposed amendments to UR M44 and P2 to enhance relevant requirements for approval and maintenance.

They are:

#### **UR M44:**

- i) Add suffix 7 to Item 33,*
- ii) Add FOOTNOTE 7.  
7. operation and service manuals are to contain maintenance requirements (servicing and repair) including details of any special tools and gauges that are to be used with their fitting/settings together with any test requirements on completion of maintenance.*
- iii) Add NOTE 5.  
5. Where the operation and service manuals identify special tools and gauges for maintenance purposes (see footnote 7.) refer to UR P2.7.4.14.*

#### **UR P2:**

- i) add P2.7.4.14: The installation of mechanical joints is to be in accordance with the manufacturer's assembly instructions. Where special tools and gauges are required for installation of the joints, these are to be supplied by the manufacturer.*
- ii) Add sentence above P2.7.4.1 :  
The application and pressure ratings of different mechanical joints are to be approved by the Classification Society. The approval is to be based on Type Approval procedure in P2.11.*

The amendments were approved by GPG on 30 September 2003 (3051aIGb)



## Technical Background

UR P2.7.4 (**Rev.6**, May 2006) and UR P2.11(**Rev.1**, May 2006)

### 1. Background:

ABS reported to Council on 13 Feb 06 as follows:

In reviewing the latest UR Implementation Matrix distributed by Perm Sec's 5059\_I Af, it is noted that besides ABS, three other Societies (KR, LR and IRS) had not indicated that they have implemented UR P2.7.4 (Rev. 5/Nov 2003).

It is further noted that these Societies also did not indicate an expected date of implementation on their Form 2.

Further UR P2.11 (Rev.2/Nov 2001) was adopted for type approval of mechanical (pipe) joints in 2001, but was made mandatory for all mechanical (pipe) joints by the amendment to P2.7.4.1 in 2003. Again, looking at the UR Implementation Matrix distributed by 5059\_I Af, we note that seven other Societies (BV, CCS, DNV, GL, KR, LR and IRS) had not indicated that they have implemented UR P2.11 (Rev.2/Nov 2001) and that none of these Societies, except IRS, indicated an expected date of implementation on its Form 2.

Therefore, this message is to declare an ABS reservation against UR P2.7.4 (Rev.5/Nov 2003) and P2.11 (Rev.2/Nov 2001) until such time as Members agree to a uniform implementation date for these requirements.

Council tasked GPG to establish a uniform application date for these requirements and ascertain the implementation status.

### 2. Discussion

#### 2.1 Implementation status

All GPG members provided information relative to their status of implementation for IR P2.

#### 2.2 P2.7.4.1

GPG Chairman assessed: In reading P2.7.4.1, it does not appear to me that the requirement is intended to mandatorily require Type Approval of the subject fittings; it appears to require compliance with the same type testing requirements

as would be required for type approval of the fitting, i.e., pipe unions, compression couplings and slip-on joints are not required to be type approved, but must be approved based on the Type Approval procedure in P2.11. Renewal of approval is only associated with type approval.

2.3 P2.11.1

DNV pointed out that the General Part of P2.11.1 has a vague expression (Individual Societies may specify more severe testing conditions...and also accept alternative testing...).

2.4 A uniform implementation statement was developed and approved.

Approved on 12 May 2006 (5059bICa)

Submitted by Permsec  
28 April 2006

## Technical Background

### UR P2.7.4 (Rev. 7, Sept 2007) (PM6304)

#### *Scope and objectives*

The aim of this task was to resolve the reservation by NK in respect of slip-on joints for steam pipes on deck (item 33 in Table 7) and to ensure a uniform application of this requirement.

#### *Points of discussion*

There was agreement amongst Panel members that slip type joints should be allowed on restrained pipes in steam piping systems on deck. GL and NK pointed out that the gasket material must be suitable for the temperature and pressure range in question.

A footnote 7) is added to table 7 and a corresponding entry made in item 33 'Steam' in the column for "Slip-on joints".

#### *Decision by voting (if any)*

The UR was adopted unanimously.

Machinery Panel Chairman  
Hamburg, 13 July 2007

#### *Permanent Secretariat note (October 2007):*

Approved by GPG 21 September 2007, ref. 7630\_IGb.

**Technical Background (TB) document for UR P2.7.4 (Rev.8 Mar 2016)**  
& UR P2.11 (Rev.4 Mar 2016) & UR P2.12 (Rev.2 Mar 2016)

**1. Scope and objectives**

- .1 To review the requirements regarding the application and details of pipe coupling joints and flexible hoses partly based upon IMO Resolution A.753(18) and update UR P2 accordingly.
- .2 To review the categorization of pipe coupling joints in Table 6 of P2.7.4 and update UR P2 accordingly.

**2. Engineering background for technical basis and rationale**

- .1 UR P2 required coupling joints and flexible hoses intended for installation in piping systems for flammable media and sea water systems be of a fire resistant type regardless of installation location. On the other hand, SOLAS regulations, such as II-2/Reg.4.2.4, etc., do not necessarily require that they be of a fire resistant type when a means of ignition is not present in the installation location.

In recent years, a member has received questions from various shipyards and manufacturers asking whether fire endurance tests for coupling joints or flexible hoses arranged in locations with low fire risk, e.g., open decks, are necessary.

Moreover, some members have experienced problems when conducting fire endurance tests due to test specimen size. ISO19921/22, which specifies fire endurance test procedures, requires that the specimen be completely engulfed in the flame envelope and this can be difficult to achieve in the case of very large test specimens.

- .2 A member received the following comment from a pipe coupling manufacturer which expressed their concern about a possible misinterpretation of the performance capabilities for mechanical pipe joints:
  - The illustration labelled "Machine Grooved Type" in Table 6 of P2.7.4 is not accurate.

**3. Source/derivation of the proposed IACS Resolution**

None.

**4. Summary of Changes intended for the revised Resolution:**

See attached table.

**5. Points of discussions or possible discussions**

See attached table.

**6. Attachments if any**

None.

Paragraph	Proposals and summarised comments from IACS Members	Conclusion
P2.7.4 Table 6	<p>Proposal:</p> <ul style="list-style-type: none"> <li>Since the illustration labelled “Machine Grooved Type” in Table 6 is not accurate, it should be replaced by the illustration provided by the <i>Victaulic Company</i>.</li> </ul>	<ul style="list-style-type: none"> <li>Agreed.</li> </ul>
P2.7.4 Table 7, Footnote 3.  P2.12.3.5	<p>Proposal:</p> <ul style="list-style-type: none"> <li>In consideration with SOLAS II-2/Reg. 4.2.3.1 and 4.2.4, slip-on joints and flexible hoses which are used for L.O. lines and other flammable oils, and are installed on open decks do not need to be of a fire-resistant type.</li> <li>In consideration with SOLAS II-2/Reg. 4.2.2.5.1, slip-on joints and flexible hoses used for F.O. lines should be of a fire-resistant type even when installed on open decks.</li> <li>“open decks” means areas defined in SOLAS II-2/Reg. 9.2.3.3.2.2(10) and 9.2.4.2.2.2(10). This means that cargo areas of tankers, ships carrying liquefied gases in bulk and ships carrying dangerous chemicals in bulk are not included for “open decks”.</li> </ul> <p>Comments:</p> <ul style="list-style-type: none"> <li>Consideration should be given to specific applications and media, e.g. non fire resistance types for sea water on open deck and fire resistant types for cargo oil, fuel and fire extinguishing systems. Moreover, the table should distinguish between wet and dry applications, e.g. fire extinguishing systems, bilge systems, sounding and vent pipes.</li> <li>Fire fighting systems on open deck with non-fire resistant connection may be broken by fire and putting to workless condition. Destruction of piping lines with flammable media cause deterioration of fire conditions.</li> <li>In considering the SOLAS requirements for fuel oil and other flammable liquids, there will need to be a strong technical argument as to why it only applies to fuel lines and not lubricating oil or other flammable liquid lines e.g. hydraulic actuating systems.</li> </ul>	<ul style="list-style-type: none"> <li>Some members were still in question as to why it only applies to fuel lines and not to other flammable liquid lines e.g. hydraulic actuating systems. Background of the regulations was not confirmed during discussion.</li> <li>However, following the decision by the qualified majority, proposals were agreed.</li> </ul>
P2.7.4 Table 7	<p>Proposal:</p> <ul style="list-style-type: none"> <li>Revised Table 7 was proposed in an effort to present the information clearer as is currently the case and to accommodate feedback from coupling manufacturers. In particular: <ul style="list-style-type: none"> <li>The footnotes are moved to the systems, thus making them applicable to all connection types. Complaints have received from manufacturers that the restrictions currently only apply to slip-on joints.</li> </ul> </li> </ul>	<ul style="list-style-type: none"> <li>Agreed.</li> </ul>
P2.7.4.3	<p>Proposal:</p> <ul style="list-style-type: none"> <li>Delete P2.7.4.3 because it is obvious and testing will only highlight discrepancies from this requirement.</li> </ul>	<ul style="list-style-type: none"> <li>Agreed.</li> </ul>
P2.7.4.7	<p>Proposal:</p> <ul style="list-style-type: none"> <li>Replace “sea openings” with terminology such as “ship’s side below the waterline”.</li> </ul>	<ul style="list-style-type: none"> <li>Agreed.</li> </ul>

	<p>Comment:</p> <ul style="list-style-type: none"> <li>Suggest to modify as follows: "ship's side below the <del>waterline bulkhead deck of passenger ships and freeboard deck of cargo ships</del>". This is the wording used in SOLAS, Reg. II-1 / 15 (title).</li> </ul>	
P2.7.4.8	<p>Proposal:</p> <ul style="list-style-type: none"> <li>Delete P2.7.4.8 as this is obvious.</li> </ul>	<ul style="list-style-type: none"> <li>Agreed.</li> </ul>
P2.7.4.11	<p>Proposal:</p> <ul style="list-style-type: none"> <li>Unrestrained slip-on joints are not defined and slip-on joints should not be used for compensation of lateral pipe deformation. The P2 test requirements for slip-on joints assume there is no lateral deformation.</li> </ul> <p>Comment:</p> <ul style="list-style-type: none"> <li>Chair explained that the intention of P2.7.4.11 is to minimise the use of slip-on joints where it is inevitable to compensate for lateral movements of piping. In practice, slip-on joints are frequently used for that purpose, hence to prohibit the use of slip-on joints for compensation of lateral deformation may be too rigorous. In this respect, modification is proposed by Chair.</li> </ul>	<ul style="list-style-type: none"> <li>Modification was agreed based on the Chair's proposal.</li> <li>The first figure of "Slip type slip-on joints" in Table 6 in UR P2.7.4 was also replaced.</li> </ul>
P2.11.5.3	<p>Proposal:</p> <ul style="list-style-type: none"> <li>The requirement "at least five times" should be re-considered. Classification societies do not need to specify minimum pipe length. This should be left up to manufacturers.</li> </ul>	<ul style="list-style-type: none"> <li>Did not achieve a majority.</li> <li>Keep as is.</li> </ul>
P2.11.5.5.1 (a)	<p>Proposal:</p> <ul style="list-style-type: none"> <li>Sixth paragraph. Delete "Other" and replace with "An".</li> </ul>	<ul style="list-style-type: none"> <li>Agreed.</li> </ul>
P2.11.5.5.1 (b) and (c)	<p>Proposal:</p> <ul style="list-style-type: none"> <li>Delete (b) and (c). These sections are covered in the sixth paragraph of (a)</li> </ul>	<ul style="list-style-type: none"> <li>Panel concurred that it is an additional requirement for compression coupling.</li> <li>Keep as is.</li> </ul>
P2.11.5.5.2	<p>Proposal:</p> <ul style="list-style-type: none"> <li>Delete the second paragraph as this is obvious.</li> </ul>	<ul style="list-style-type: none"> <li>Panel unanimously agreed to delete the second part of the text.</li> </ul>
P2.11.5.5.2 (a)	<p>Proposal:</p> <ul style="list-style-type: none"> <li>Delete the fifth paragraph as this is obvious.</li> </ul> <p>Comment:</p> <ul style="list-style-type: none"> <li>Visual examination of the joint assembly is to be carried out.</li> </ul>	<ul style="list-style-type: none"> <li>Panel unanimously agreed to delete the second part of the text.</li> </ul>
P2.11.5.5.3	<p>Proposal:</p> <ul style="list-style-type: none"> <li>For large diameters, tests according to Fig. 3 are difficult to perform and very expensive. As an alternative it is suggested also to refer to BS 4368: Part 4.</li> </ul> <p>Comment:</p> <ul style="list-style-type: none"> <li>Direct reference to BS, a regional standard, is not appropriate.</li> </ul>	<ul style="list-style-type: none"> <li>Direct reference to BS, a regional standard, was not supported.</li> <li>Keep as is.</li> </ul>
P2.11.5.5.4	<p>Proposal:</p> <ul style="list-style-type: none"> <li>(Burst pressure test) Third paragraph. Delete the last sentence or modify it to provide more clarity.</li> </ul>	<ul style="list-style-type: none"> <li>Agreed to delete.</li> </ul>
P2.12.3.5	<p>Proposal:</p> <ul style="list-style-type: none"> <li>(P2.12.3.5) Only water is permitted as a test medium. With a view to ensuring</li> </ul>	<ul style="list-style-type: none"> <li>Agreed by the qualified majority.</li> </ul>

	<p>maximum safety for both the operating personnel and the test bed in the event of damage to the hose during the test, the use of combustible test media is excluded. This poses an issue. All marine coupling on the market at the moment are tested to ISO 15540/41 therefore can never be used on a dry system.</p>	
P2.11.5.5.6.3	<p>Proposal:</p> <ul style="list-style-type: none"> <li>(Fire endurance test) The standard specifies a sensible method of testing pipe couplings where the flame shall envelop the test specimen. This will result in problems with very large test specimens. In such cases, alternative test methods and/or test procedures should be accepted.</li> </ul> <p>Comments:</p> <ul style="list-style-type: none"> <li>Provides practical cases in which alternative test methods has been accepted.</li> <li>A UR may allow an alternative method to be used only if a minimum set of criteria is provided to ensure the equivalency between the required method and the alternative one. Otherwise, the acceptance of the tested specimen may differ among Classification Societies.</li> </ul>	<ul style="list-style-type: none"> <li>None of members have experienced such cases in which alternative test methods have been accepted.</li> <li>Regardless of practical cases, proposal was agreed by the qualified majority.</li> </ul>
P2.11.5.5.6.4	<p>Proposal:</p> <ul style="list-style-type: none"> <li>(Fire endurance test) Define requirements for the thermal insulation materials used for the fire sleeves of couplings.</li> <li>A flammability test according to IEC 60695-11-5 is to be carried out.</li> </ul>	<ul style="list-style-type: none"> <li>Agreed with following modifications: <i>Thermal insulation materials <u>applied on used for fire sleeves of couplings</u> are to be <del>non-flammable</del><u>combustible</u> in dry condition and when subjected to oil spray. A <del>flammability</del><u>non-combustibility</u> test according to <del>IEC 60695-11-5</del><u>ISO 1182</u> is to be carried out.</i></li> </ul>
P2.11.5.5.7	<p>Proposal:</p> <ul style="list-style-type: none"> <li>(Vacuum test) Delete the third paragraph since the tests cannot be correctly carried out without monitoring the pressure.</li> </ul>	<ul style="list-style-type: none"> <li>Agreed.</li> </ul>

## **Technical Background (TB) document for UR P2.7.4 (Rev.9 Oct 2018)**

### **1. Scope and objectives**

To amend UR P2.7.4 to provide a picture for typical compression type mechanical joints and clarify applicability of limitation in use of slip on joints

### **2. Engineering background for technical basis and rationale**

- The industry asked to update and reconsider the Table 6 due to difficulty of classification for one kind of compression type mechanical joint (called as 'Swagelok').
- Note 2 in table 7 was referring to all type of coupling whereas the intention was to only apply to slip-on joints.

### **3. Source/derivation of the proposed IACS Resolution**

- The industry asked to update and reconsider the Table 6 due to difficulty of classification for one kind of compression type mechanical joint (called as 'Swagelok').
- The mistake in note 2 was noted by IACS Members

### **4. Summary of Changes intended for the revised Resolution:**

- Added a type of compression coupling in Table 6 and Table 8
- Text of note 2 modified to refer only to slip-on joints

### **5. Points of discussions or possible discussions**

UR P2.7.4 (Rev.9)

Regarding 'Typical Compression Type' in Table 6, members agreed to update Table 6 together with Table 8. Members considered that the 'Swagelok' type is not defined as specifically 'compression' type and it is nearer to normal compression type or bite type than 'swage' type fittings. This consideration was also reflected in Table 8.

### **6. Attachments if any**

None



## Technical Background (TB) document for UR P2.7.4 (Rev.10 Jan 2021)

### 1. Scope and objectives

To amend UR P2.7.4 to provide a new Table 7 with a classification according to service condition for each piping system (dry, wet, dry/wet)

### 2. Engineering background for technical basis and rationale

- The industry asked to update and reconsider the test requirements as given by Table 7 in order to extend the range of application for slip-on-joints.
- IACS members noted inconsistent fire test requirements with respect to service conditions (dry, wet, wet/dry).

### 3. Source/derivation of the proposed IACS Resolution

See paragraph 2.

### 4. Summary of Changes intended for the revised Resolution:

- Paragraph P2.7.4.9: introducing reference to MSC/Circ.734
- Added footnotes to Table 6 providing a definition for swage type and press type mechanical joints
- Amend introduction text of Table 7 with respect to considering relevant statutory requirements
- Amend Table 7 by detailed specification of fire endurance test condition wet, dry/wet, dry. Test requirements for dry/wet test specified (times are 8 min (dry)/22 min(wet)) and test exposure time greater than 30 minutes.
- Amend system specification in row 14 to "Permanent water filled ...".
- Merging old row 15 *Non water filled fire extinguishing systems, e.g. foam, drencher systems* and 16 *fire main (not permanently filled)* to new row 15 *Non-permanent water filled fire extinguishing systems, e.g. foam, drencher systems and fire main (not permanently filled)*.

### 5. Points of discussions or possible discussions

- Insertion of reference to MSC/Circ.734. One member society did not support the reference to MSC/Circ.734 in P2.7.4.9 as the expression "easily accessible" appears to relate to "other spaces" while the interpretation of same expression in the Circular relates to valves. However, the qualified majority agreed with the reference to the Circular.
- Test requirements in Table 7 may be in conflict with statutory requirements. Panel agrees to note in the introduction that statutory requirements need to be taken into consideration.

- Dry/wet test in general discussed with respect to weakening existing requirements. Panel agreed that dry/wet test is only applicable for systems flooded after fire alarm. Thus, for these systems dry/wet test is more stringent than wet test.
- Times for dry/wet test of 8/22 minutes are specified considering BS LPS1219 requiring 7.5 minutes dry and had been discussed with relevant industry.
- Difference between 925°C requirements in IMO instruments and 800°C fire resistant test applied by IACS (ISO 19921) discussed. Panel noted that these requirements relate to different objectives, IMO test focuses on properties of all materials used (melting temperature  $\geq 925^{\circ}\text{C}$ ) whereas the IACS test (flame temperature  $\geq 800^{\circ}\text{C}$ ) focuses on integrity of the component. Conflict in test temperature could not be resolved.

#### **6. Attachments if any**

None

## Technical Background (TB) document for UR P2.7.4 (Rev.11 Oct 2023)

### 1. Scope and objectives

To introduce definitions for swage type joints and press type joints in IACS UR P2, while understanding the rationale behind the requirement allowing use of press type joints only for Class III piping.

And to evaluate if there are sufficient reasons to maintain the present requirement or amend the UR to allow press type joints to be used for other classes of piping, based on investigation/tests and industry hearing.

### 2. Engineering background for technical basis and rationale

A request of Type Approval resulted in a different interpretation on the type of mechanical joint subject to type approval between a Manufacturer and a Class Society, e.g. their "Press Type" joint was interpreted as "Radial Swage Type" by the Manufacturer and, as consequence, understood acceptable for Class I and II pipes like "Swage Type", and as "Press Type" by the Class Society and therefore acceptable only for Class III piping.

Therefore, in order to have a uniform application of "Press Type" and "Swage Type" mechanical joints depending upon the class of piping, a proposal was put forward to introduce definitions in IACS UR P2 allowing to clearly distinguish swage type from press type joints.

In addition, the technical rationale (or specific feature) that caused press type joints to be considered suitable only for Class III piping, while swage type joints suitable for Class I and II piping, has been considered unclear and the opportunity to amend UR P2 to allow the use of press type joint for Class I and II piping, subject to investigation/tests on the technical factors (such as minimum thickness and shrinkage), should be evaluated.

To take this opportunity, review of existing requirements for mechanical joints should be conducted. For instance, the size limitation issue can be revisited. According to a member's understanding which was supported by the qualified majority, mechanical joints of compression couplings could be used in various piping systems and need not lower the safety of such systems. Namely, if the test requirements are sufficient to demonstrate that the mechanical joints are "fit-for-purpose" and, if the specimens cover relevant dimensions, any diameter limitation seems not to be meaningful.

The draft revision of UR P2 prepared by the Panel is presented to Industry to listen to Industry Opinion and to improve the UR with due consideration of Industry advice and relevant Standards in practice.

### 3. Source/derivation of the proposed IACS Resolution

Varying interpretation on the "Press Type" mechanical joints joint as described in item 2. Size limitation issue was originated from PM16301.

### 4. Summary of Changes intended for the revised Resolution:

Among the initially intended changes, following is finally adopted for this revision of the UR as a result of Industry Hearing and Panel deliberation:

- Deletion of size limitation on Class I and II piping systems for Compression Couplings (bite type, typical compression type and flared type);
- Applicability of pressure pulsation test to make mandatory for Class I and II.

## **5. Points of discussions or possible discussions**

It has been observed that present terms for the two mechanical joints i.e. Press type and Swage type are widely used and supported by the Industry, and the change of terms i.e. Radially Swaged type and Axially Swaged type and the extension of applicability for Press type (Radially Swaged type) to Class I & II are not well shared by the Industry and further necessitate substantive modification e.g. additional high pressure/temperature performance verification such as ASTM F1387 and EC PED Directive requirements.

In the light of above, the Panel decided not to proceed the revision of terms and extension of applicability until relevant requirement for performance verification is in ready and if such is agreed by the Panel and shared by the Industry.

Also it was considered prudent not to give a specific footnotes of definition for the two mechanical joints (Press type, Swaged type) in this revision, but to put more relevant definition in the next revision which is aligned with the terms (Radially Swaged type, Axially Swaged type) based on Mechanically Attached Fittings that were agreed by the Panel and utilized for the Industry Hearing.

For future revision work, it was proposed by a Member that qualification and testing requirements of the mechanically attached fittings as per ASTM F1387 ought to be considered as the basis for type testing and qualification of mechanically attached fittings as well as acceptance of ASTM F3226/F3226M for the press type fittings that are limited to class III piping systems as defined by IACS UR P2.

By the same Member, it was argued at the last moment and recorded here for further revision work that "the deletion of the restricted sizing of these fittings will be considered acceptable subject to successful qualification testing of the largest size fitting and availability of the installation tools for onboard installation of such fittings by ships crew. With regards to the final proposal that the classification societies will develop their own testing facilities for the future developments of these mechanical fitting and testing of the larger size fittings. We express reservations that the provision of such testing facilities is outside the scope of the class societies".

## 6. Attachments if any

The outcome of Industry Hearing is summarized below  
 Industry Hearing for task PM16301f: Proposal of amendment to UR P2 – Application of swage type and press type mechanical joints

<p><b>IACS Inquiry 1</b></p>	<p>IACS, in the process of revising UR P2.7.4, would like to hear your esteemed opinions on the further application of "press type" (which is renamed as "radially swaged type") couplings into class I and II piping system, as well as the deletion of size limitation on typical compression type, bite type and flared type. The main purpose of the hearing is to get sufficient information and agreement from industry in revising Table 6 (including the footnotes) and Table 8 of UR P2.7.4. Please find the attached copy of the draft UR.</p>	
<p>Reply from <b>Company A</b></p>	<p>the term "swaged type" and "press type" coupling are renamed as "axially swaged type" and "radially swaged type" (see Table 6 and Footnotes thereto)        the name radially swaged type is a good solution.        It represents correctly the kind of fitting.</p> <p>the changes proposed in Table 8 for "radially swaged type" coupling (i.e. accepting used for Class I and Class II piping) will be cancelled, unless sufficient information that "radially swaged type" couplings may be allowed on piping systems classes I and II is provided during this industry hearing.        We have an important experience about production and selling of press-fitting systems destined to naval applications.        We are first class supplier for the most important producers of ships and yachts in the world.        Our opinion is that the fittings "radially swaged type" must be used only for Class III applications.        The applications (media pressures and temperatures) dedicated to Class I and II are too burdensome (attached the table that we use like reference).        Using press-fitting in Class I and II could be create not safe conditions.</p> <p>concerning OD limitations proposed in Table 8 for "typical compression type", "bite type" and "flared type" intended to high pressure systems, the view of industry is sought)        we are producers of "radially swaged type" fittings, so we prefer not write our opinion.</p>	
<p>Reply from <b>Company B</b></p>	<p>Introduction:        Press Type fittings as identified on IACS UR P2.7.4 Table 7 Press Type, comprise an international defined technology that has been incorporated into multiple standards, industry articles, symposia and definitions. The change to Radially Swaged Type is inconsistent in creating a better definition as it already exists and refers to a different product/technology.</p> <p>-----omission-----        -----omission-----</p> <p>Conclusion:        The term "PRESS" is established internationally in multiple standards and is a common term for the technology. Radially Swaged Type fittings</p>	

	<p>differ to Press Type fittings by the fact that the sealing is obtained from a resilient and elastomeric sealing element instead of a metal to metal seal for the radially swaged type fittings. The PRESS TYPE designation included in IACS UR P2.7.4 Table 7 is consistent with the definitions for Press technology included in available international standards, shipbuilding symposia and industry references.</p> <p>We believe changing the Press Type designation to Radially Swaged Type does not clarify the reference to the technology consistent with existing international land and shipbuilding standards and therefore object to the change.</p>	
<p>Reply from <b>Company C</b></p>	<p>We would like to demonstrate that “radially swaged type” fittings (press fittings) are also suitable for media belonging to IACS pipe classes I, II and are also reliable for pipe diameter larger than d 60.3 mm:</p> <p>Model XXX press fittings (now stated as radially swaged type) are suitable for media belonging to piping classes I, II and III. This is proven by the German TUEV type approval “TÜV.A.271-16” (see enclosure) as well as other national and international approvals and expert assessments regarding industrial applications.</p> <ul style="list-style-type: none"> <li>• The TUEV approval refers to the European <b>Pressure Equipment Directive</b> (2014/68/EU) and allows the use of Model XXX press fitting systems for fluids of groups 1 and 2.</li> <li>• This means that dangerous, poisonous and flammable media can also be conveyed with Model XXX press fitting systems (radially swaged types).</li> <li>• With reference to the TUEV approval Model XXX press fitting systems (radially swaged types) are approved up to a nominal size of <b>DN 100</b>.</li> <li>• Model XXX press fitting systems are also approved up to <b>DN 100</b> by ABS, BV, LRS, CCS, DNV(GL), RINA, Class NK, RMRS and therefore they are tested according to the <b>IACS rules</b>.</li> </ul> <p>Based on the explanations above, we consider the use of press fitting systems (radially swaged types) also for classes I and II and for diameter <b>&gt; 60.3 mm</b> too to be suitable and applicable.</p>	
<p>Reply from <b>Company D</b></p>	<p>A1. The fact that the press type has been renamed to the radial swage type and can be used for class I and II piping systems will make it possible to use types that have been disabled for many years, expanding product development options. However, high temperature, the product performance verification test by which will be available to the high-pressure considered as important.</p> <p>A2. About the difference between compression coupling and slip-on joint. Since each product has its own strengths and weaknesses, it is important for the piping designer to make appropriate judgments (product performance, workability, safety, cost) before making a selection.</p> <p>A3. We think that there is no problem with removing the size restrictions of the bite type and flared type as long as safety can be ensured.</p>	
<p><b>IACS view</b></p>	<p>IACS deems that IACS unified requirements for mechanical joints in P2.7.4 and P2.11 are in line with ASTM F3226/F3226M (Press-Connect) rather than ASTM F1387 (Mechanically Attached Fittings) when it comes to detail testing criteria, applicability and classification etc. and as</p>	

highlighted out by some manufacturers in order to apply press type to Class I and II piping systems, high pressure/temperature performance verification such as those in ASTM F1387 or PED will be further considered and specifically set out in the UR, while the size limitation may be relieved without additional provisions.

In this respect, it would be prudent to not proceed with revision of terms (swage, press) and applicability (Class I and II) until the relevant requirement for performance verification procedure is in ready and if such is agreed by this Panel.

Ref.) classification and testing requirement (ASTM F3226 vs ASTM F1387)

ASTM F3226/F3226M (Press-Connect)

*Class 1—100 psi (0.69 MPa) maximum.*

*Class 2—200 psi (1.38 MPa) maximum.*

*Class 3—300 psi (2.07 MPa) maximum.*

*Hydrostatic Proof Testing:*

*Hydrostatic Burst Test:*

*Pull-Out Test:*

*Vacuum Test:*

*Vibration Test:*

*Fire Test:*

*Impulse Pressure Test:*

*Ammonia Vapor Test, for Copper Alloys Containing 5 % Zinc or Greater*

ASTM F1387 (Mechanically Attached Fittings)

*Class 1—1.38 MPa (200 psi) maximum.*

*Class 2—2.76 MPa (400 psi) maximum.*

*Class 3—4.83 MPa (700 psi) maximum.*

*Class 4—6.90 MPa (1000 psi) maximum.*

*Class 5—10.34 MPa (1500 psi) maximum.*

*Class 6—13.79 MPa (2000 psi) maximum.*

*Class 7—20.69 MPa (3000 psi) maximum.*

*Class 8—25.86 MPa (3750 psi) maximum.*

*Class 9—34.48 MPa (5000 psi) maximum.*

*Class 10—41.37 MPa (6000 psi) maximum.*

Description of Test	Number of Specimens		Applicability of Test	
	Permanent	Separable	Permanent	Separable
Examination of specimen	22	28	yes	yes
Pneumatic proof test	22	28	yes	yes
Hydrostatic proof test	22	28	yes	yes
Impulse test <sup>B</sup>	6	6 <sup>C</sup>	yes	yes
Flexure fatigue test <sup>B</sup>	6	6 <sup>C</sup>	yes	yes
Tensile test	6	6	yes	yes
Burst test <sup>B,D</sup>	4	4	yes	yes
Repeat assembly test <sup>B</sup>	...	<sup>C</sup>	no	yes
Rotary flexure test <sup>B</sup>	...	6	no	yes
Mercurous nitrate test	2	2	... <sup>E</sup>	... <sup>E</sup>

**IACS Inquiry 2**

Also, IACS plans to modify the applicability of pressure pulsation test to mechanical joints in pipe Class I and II (i.e. changing from the optional requirement to the mandatory requirement).

Reply from <b>Company A</b>	Nil	
Reply from <b>Company B</b>	Nil	
Reply from <b>Company C</b>	Nil	
Reply from <b>Company D</b>	<p>About changing the impact pressure test from optional requirements to mandatory requirements.</p> <p>I think it is good to make it an indispensable requirement from the situation that occurs in the piping of a ship. However, companies with ample funds can introduce new test equipment and follow suit, including the adoption of the dry test of fire resistance test revised in January 2021. However, even if they have technical capabilities, the introduction of test equipment is expensive, so companies that cannot try will be forced to withdraw from the industry.</p> <p>Since the industry itself is expected to decline, each ship class association should own test equipment and create an environment where each manufacturer can easily take on the challenge of developing new products. I think that will lead to the creation of a mechanical joint that provides sufficient safety, is reliable, and is easy to install.</p>	
<b>IACS view</b>	IACS deems that we may proceed as proposed.	



## UR P2.9 “Pressure tests of piping after assembly on board”

### Summary

This UR provides requirements for pressure tests of piping after assembly on board. This revision provides alternative pressure test as pneumatic leak testing for water sensitive system.

### Part A. Revision History

Version no.	Approval date	Implementation date when applicable
Rev.3 Oct 2023	9 October 2023	01 January 2025
Rev.2 1987	-	-
Rev.1 1975	-	-
Original version 1974	-	-

#### • Revision 3 (Oct 2023)

##### 1 Origin of Change:

- Suggestion by IACS member

##### 2 Main Reason for Change:

For hydrostatic testing of piping systems after assembly on board, this revision accepts pneumatic leak testing for water sensitive system.

##### 3 List of non-IACS Member classification societies contributing or participating in IACS Working Group:

None

##### 4 History of Decisions Made:

One member initiated an issue about a relaxation of the pressure test for piping after assembly on board. After a conversation with other WG, this revision is developed.

##### 5 Other Resolutions Changes:

None

##### 6 Any hinderance to MASS, including any other new technologies:

None

## **7 Dates:**

Original Proposal	: 01 January 2021	(Made by: PM16301f)
Panel Approval	: 07 September 2023	(Ref: PM16301fIMzg)
GPG Approval	: 09 October 2023	(Ref: 23164_IGc)

- **Rev.2 (1987)**

No HF or TB is available.

- **Rev.1 (1975)**

No HF or TB is available.

- **New (1974)**

No HF or TB is available.

\*\*\*\*\*

## Part B. Technical Background

List of Technical Background (TB) documents for UR P2.9:

### Annex 1. **TB for Rev.3 (Oct 2023)**

See separate TB document in Annex 1.

**Note:** *No Technical Background (TB) documents are available for Original version and Rev.1, Rev.2.*

## **Technical Background (TB) document for UR P2.9 (Rev.3 Oct 2023)**

### **1. Scope and objectives**

According to UR P2.9, piping systems after assembly on board are conducted pressure tests under not less than 1.5P regardless of performing pressure test before installation on board based on UR P2.8.

This revision confirms the necessity of a pressure test after assembly via TB. In addition, provides alternative pressure test as pneumatic leak testing for water sensitive system.

### **2. Engineering background for technical basis and rationale**

Based on opinions from another Working group who have the specialty of inspection, the Working group keeps requirements on hydrostatic testing. While maintaining the text, provides additionally a paragraph for water sensitive systems.

Besides, taking into account the scope of UR P2, the text about the pressure of test is updated by deleting the expression for gas pipes.

#### **2a. Specification of the data utilised in the development/revision of the proposed IACS Resolution, if any**

None

### **3. Source/derivation of the proposed IACS Resolution**

None

### **4. Summary of Changes intended for the revised Resolution:**

- Deleting the expression indicating gas pipes depending on the scope of UR P2 that gas fuel pipe is out of scope.
- Adding the paragraph on pneumatic leak testing for water sensitive systems instead of hydrostatic testing.

### **5. Points of discussions or possible discussions**

One member raised an issue of the necessity of pressure tests for pipes after assembly on board and their test pressure. Even though hydrostatic tests are conducted in 1.5P according to UR P2.8, UR P2.9 Rev.2 have required hydrostatic testing in order to check for leakage. Furthermore, IGC 5.13.2.2 and IGF code 16.7.3.2 accept waivers of pressure test for pipes completely manufactured and equipped with all fittings.

However, another working group that consists of experts in the survey has reviewed as follows :

*The working group has discussed the issue, 'whether the pressure test as per UR P2.9 can be waived if the piping system has successfully passed the hydrostatic test required by UR P2.8' and unanimously agreed to the view that the pressure test is not to be waived as per UR P2.9 because fuel systems and heating coils*

*are typically manufactured in sections in a work shop and assembled onboard the vessel, and the piping shall be pressure tested after installation.*

Depending on the above opinion, the working decided to keep the current text excluding the expression 'gas fuel lines' which is out of scope of UR P2.

In addition, the texts for pneumatic leak testing as an alternative to pressure tests are established additionally for water sensitive systems and IACS Rec.140 Part F is referred to enhance the safety during the alternative test.

**6. Attachments if any**

None.

## UR P2.11 “Type Approval of Mechanical Joints”

### Summary

In Rev.6 of this UR, the requirements for mechanical joints were reviewed to align with revision work conducted for UR P2.7.4.

### Part A. Revision History

Version no.	Approval date	Implementation date when applicable
Rev.6 (Oct 2023)	9 October 2023	1 January 2025
Rev.5 (Jan 2021)	25 January 2021	1 July 2022
Rev.4 (Mar 2016)	2 March 2016	1 January 2017
Rev.3 (Aug 2012)	9 August 2012	1 January 2014
Corr.1 (Apr 2007)	11 April 2007	-
Rev.2 (Nov 2006)	28 November 2006	-
Rev.1 (May 2006)	12 May 2006	-
Original version (Nov 2001)	17 November 2001	1 January 2007

#### • Rev.6 (Oct 2023)

##### 1 Origin of Change:

- Suggestion by IACS member

##### 2 Main Reason for Change:

There was a suggestion for Press type joint to extend the applicability to Class I and II piping systems, while giving a clear definition of Swage and Press type joint and possible change of the terms for the two joints. The Panel had rounds of discussion over the suggestion, together with other revision proposals such as pressure pulsation test and deletion of size limitation for certain type of joints.

##### 3 List of non-IACS Member classification societies contributing or participating in IACS Working Group:

None

##### 4 History of Decisions Made:

The Panel prepared a draft version of the UR and decided to have an Industry Hearing, in order to listen to Industry Opinion and improve the UR in due consideration of Industry Advice and relevant International Standards etc. in practice. After thorough review of the Industry Hearing and following deliberations at the Panel, this revision of UR has been finalized.

## **5 Other Resolutions Changes:**

P2.7.4 (Rev.11) is also revised under the same task number.

## **6 Any hinderance to MASS, including any other new technologies:**

None

## **7 Dates:**

Original Proposal:	16 April 2019	(Ref: PM16301fIMa)
Panel Approval:	07 September 2023	(Ref: PM16301fIMzg)
GPG Approval:	09 October 2023	(Ref: 23164_IGc)

## **• Rev.5 (Jan 2021)**

### **1 Origin of Change:**

Suggestion by IACS member

### **2 Main Reason for Change:**

To review the application and details of fire-resistant type tests for mechanical joints in course of revision UR P2.7.4 (Rev.10).

### **3 List of non-IACS Member classification societies contributing or participating in IACS Working Group:**

None

### **4 History of Decisions Made:**

The Machinery Panel commented on revisions by correspondence and at regularly scheduled meetings.

## **5 Other Resolutions Changes:**

UR P2.7.4 (Rev.10) are also revised under the same task number.

## **6 Any hinderance to MASS, including any other new technologies:**

None

## **7 Dates:**

Original Proposal:	13 June 2016 (Made by a Member)
Panel Approval:	12 November 2020 (Ref: PM16301_IMzf)
GPG Approval:	25 January 2021 (Ref: 14079aIGe)

- **Rev.4 (Mar 2016)**

**.1 Origin of Change:**

- Suggestion by IACS member

**.2 Main Reason for Change:**

To review the application and details of fire resistant type tests for mechanical joints.

**.3 List of non-IACS Member Classification Societies contributing through the TC Forum and/or participating in IACS Working Group:**

None

**.4 History of Decisions Made:**

The Machinery Panel commented on revisions by correspondence and at regularly scheduled meetings.

**.5 Other Resolutions Changes:**

P2.7.4 (Rev.8) and P2.12 (Rev.2) are also revised under the same task number.

**.6 Dates:**

Original Proposal: 30 January 2012 Made by a Member  
Panel Approval: 28 December 2015 (Ref: PM11921)  
GPG Approval: 2 March 2016 (Ref: 14079\_IGe)

- **Rev.3 (Aug 2012)**

**.1 Origin of Change:**

- Suggestion by IACS member

**.2 Main Reason for Change:**

To specify realistic axial forces and specify range of test objects.

**.3 List of non-IACS Member Classification Societies contributing through the TC Forum and/or participating in IACS Working Group:**

None

**.4 History of Decisions Made:**

The test 2.11.5, pull-out, is revised to reflect the industrial practice.

**.5 Other Resolutions Changes:**

None



**.6 Dates:**

Original Proposal: 02 March 2011 Made by a Member  
Panel Approval: 15 November 2011  
GPG Approval: 09 August 2012 (Ref: 11042\_IGi)

- **Corr.1 (Apr 2007)**

GPG Reference: 5059a

See TB document in Part B. No history file available.

- **Rev.2 (Nov 2006)**

GPG Reference: 5059a

See TB document in Part B. No history file available.

- **Rev.1 (May 2006)**

GPG Reference: 5059b

See TB document in Part B. No history file available.

- **Original version (Nov 2001)**

AHG/PPV submitted the draft new UR P2.11 to GPG 48 for approval. It requested GPG to refer the draft to external review (9099d). AHG completed reviewing external bodies' comments and submitted final text to GPG 50 (0077a, 18/1/2001).

No history file or TB document available.

\*\*\*\*\*

## Part B. Technical Background

List of Technical Background (TB) documents for UR P2.11:

Annex 1. **TB for Rev.1 (May 2006)**

See separate TB document in Annex 1.

Annex 2. **TB for Rev.2 (Nov 2006)**

See separate TB document in Annex 2.

Annex 3. **TB for Corr.1 (Apr 2007)**

See separate TB document in Annex 3.

Annex 4. **TB for Rev.3 (Aug 2012)**

See separate TB document in Annex 4.

Annex 5. **TB for Rev.4 (Mar 2016)**

See separate TB document in Annex 5.

Annex 6. **TB for Rev.5 (Jan 2021)**

See separate TB document in Annex 6.

Annex 7. **TB for Rev.6 (Oct 2023)**

See separate TB document in Annex 7.

**Note:** *There are no Technical Background (TB) documents available for Original version (Nov 2001).*

## Technical Background

UR P2.7.4 (**Rev.6**, May 2006) and UR P2.11(**Rev.1**, May 2006)

### 1. Background:

ABS reported to Council on 13 Feb 06 as follows:

In reviewing the latest UR Implementation Matrix distributed by Perm Sec's 5059\_I Af, it is noted that besides ABS, three other Societies (KR, LR and IRS) had not indicated that they have implemented UR P2.7.4 (Rev. 5/Nov 2003).

It is further noted that these Societies also did not indicate an expected date of implementation on their Form 2.

Further UR P2.11 (Rev.2/Nov 2001) was adopted for type approval of mechanical (pipe) joints in 2001, but was made mandatory for all mechanical (pipe) joints by the amendment to P2.7.4.1 in 2003. Again, looking at the UR Implementation Matrix distributed by 5059\_I Af, we note that seven other Societies (BV, CCS, DNV, GL, KR, LR and IRS) had not indicated that they have implemented UR P2.11 (Rev.2/Nov 2001) and that none of these Societies, except IRS, indicated an expected date of implementation on its Form 2.

Therefore, this message is to declare an ABS reservation against UR P2.7.4 (Rev.5/Nov 2003) and P2.11 (Rev.2/Nov 2001) until such time as Members agree to a uniform implementation date for these requirements.

Council tasked GPG to establish a uniform application date for these requirements and ascertain the implementation status.

### 2. Discussion

#### 2.1 Implementation status

All GPG members provided information relative to their status of implementation for IR P2.

#### 2.2 P2.7.4.1

GPG Chairman assessed: In reading P2.7.4.1, it does not appear to me that the requirement is intended to mandatorily require Type Approval of the subject fittings; it appears to require compliance with the same type testing requirements

as would be required for type approval of the fitting, i.e., pipe unions, compression couplings and slip-on joints are not required to be type approved, but must be approved based on the Type Approval procedure in P2.11. Renewal of approval is only associated with type approval.

2.3 P2.11.1

DNV pointed out that the General Part of P2.11.1 has a vague expression (Individual Societies may specify more severe testing conditions...and also accept alternative testing...).

2.4 A uniform implementation statement was developed and approved.

Approved on 12 May 2006 (5059bICa)

Submitted by Permsec  
28 April 2006

**Technical Background for Revision of UR P2.11.5.5.6 and UR P2.11.5.5.1  
(UR P2.11, rev. 2, November 2006)**

**UR P2.11.5.5.6**

For mechanical joints, the fire endurance test is to be conducted according to the procedures specified in UR P2.11.5.5.6.

The current UR P2.11.5.5.6. states that *“Mechanical joint assembly test specimen is to be subjected to fire for 30 min at a temperature of 800 degrees centigrade, while water at the design pressure of the joints is circulated inside. Specimen is to be completely engulfed in the flame envelope.”*

However, it has come to member societies’ attention that there have been cases where tests were conducted using a furnace without apparent “flame” under the consent of several member societies. Whereas other societies were insisting on the “flame engulfing the test specimen”, which often resulted in the use of increased number of flame burners, these additional burners in turn required additional fire-retardant packing due to higher heat input. This inconsistent implementation of the fire test requirements among member societies has prompted the review of the current UR P2.

Member societies agreed to remove the wording *“Specimen is to be completely engulfed in the flame envelope”* as this requirement is contained in the referenced standard ISO 19921:2005 (E), paragraph 7.1 and 7.8, and does not need to be duplicated.

Meanwhile, it was pointed out that:

- the subject UR would need to specify detailed test procedures as well as test acceptance criteria, and ISO 19922 (2005) was found to be the appropriate international standard for this purpose.
- ISO 19921 (2005) specifies nearly identical test conditions and acceptance criteria compared with the current UR, and therefore it would be best to adopt established international standard in its entirety. This reference to ISO 19921 in the UR can eliminate the current wording, i.e., *“Mechanical joint assembly test specimen is to be subjected to fire for 30 min at a temperature of 800 degrees centigrade, while water at the design pressure of the joints is circulated inside. Specimen is to be completely engulfed in the flame envelope.”*

The panel agreed with the above points, and concluded that the final draft should reflect the same.

**UR P2.11.5.5.1**

Changes to UR P2.11.5.5.1 (a) were made to bring it in line with the ISO standards referenced in UR P2.11.5.5.6.

Hamburg, 14 November 2006

IACS Machinery Panel Chairman

**Permanent Secretariat note:**

Subject no. 5059a, agreed by GPG and Council 28/11/2006 (IGf)

**Technical Background for Revision of UR P2.11.5.5.6 and UR P2.11.5.5.1  
(UR P2.11, Rev. 2, November 2006 and Corr.1, April 2007)**

**Rev.2, November 2006**

**UR P2.11.5.5.6**

For mechanical joints, the fire endurance test is to be conducted according to the procedures specified in UR P2.11.5.5.6.

The current UR P2.11.5.5.6. states that *“Mechanical joint assembly test specimen is to be subjected to fire for 30 min at a temperature of 800 degrees centigrade, while water at the design pressure of the joints is circulated inside. Specimen is to be completely engulfed in the flame envelope.”*

However, it has come to member societies’ attention that there have been cases where tests were conducted using a furnace without apparent “flame” under the consent of several member societies. Whereas other societies were insisting on the “flame engulfing the test specimen”, which often resulted in the use of increased number of flame burners, these additional burners in turn required additional fire-retardant packing due to higher heat input. This inconsistent implementation of the fire test requirements among member societies has prompted the review of the current UR P2.

Member societies agreed to remove the wording *“Specimen is to be completely engulfed in the flame envelope”* as this requirement is contained in the referenced standard ISO 19921:2005 (E), paragraph 7.1 and 7.8, and does not need to be duplicated.

Meanwhile, it was pointed out that:

- the subject UR would need to specify detailed test procedures as well as test acceptance criteria, and ISO 19922 (2005) was found to be the appropriate international standard for this purpose.
- ISO 19921 (2005) specifies nearly identical test conditions and acceptance criteria compared with the current UR, and therefore it would be best to adopt established international standard in its entirety. This reference to ISO 19921 in the UR can eliminate the current wording, i.e., *“Mechanical joint assembly test specimen is to be subjected to fire for 30 min at a temperature of 800 degrees centigrade, while water at the design pressure of the joints is circulated inside. Specimen is to be completely engulfed in the flame envelope.”*

The panel agreed with the above points, and concluded that the final draft should reflect the same.

**UR P2.11.5.5.1**

Changes to UR P2.11.5.5.1 (a) were made to bring it in line with the ISO standards referenced in UR P2.11.5.5.6.

Hamburg, 14 November 2006  
IACS Machinery Panel Chairman

Permanent Secretariat note:

Subject no. 5059a, agreed by GPG and Council 28/11/2006 (IGf)

**Correction 1, April 2007**

After publication of the revised UR the RS Panel member pointed out that the addition of the requirement in UR P2.11.5.5.1 "For services other than flammable fluids, leakage rate is not to be more than 0.2 l/min" is not appropriate as this requirement relates to the fire endurance test only. At the 5<sup>th</sup> Machinery Panel (March 2007) meeting this was considered by Panel members and it was agreed that this sentence should be deleted from UR P2.11.5.5.1.

Hamburg, 29 March 2007  
IACS Machinery Panel Chairman

Permanent Secretariat note:

During GPG discussion, ABS (5059aABc & ABd) asked Machinery Panel to confirm whether the sentence being deleted from P2.11.5.5.1 would be added to P2.11.5.5.6. Machinery Panel (5059aPMd) confirmed that they felt it was not necessary since P2.11.5.5.6 refers to ISO standard 'ISO 19921: 2005(E)', which includes a Note in Section 8 - Assessment - "For services other than flammable fluids, a leakage rate of not more than 0.2 l/min is considered acceptable".



## **Technical Background for UR P2.11 Rev.3, Aug 2012**

### **1. Scope and objectives**

Update of pull-out test in 2.11.5.5.5.

The panel is in the opinion that this test as specified, where merely the internal pressure is causing the axial force, is not sufficient for proving the coupling's ability to withstand axial forces encountered in actual service.

There is no safety factor included for situations where thermal expansion, vibrations etc. will require the coupling to have increased ability to withstand axial forces.

### **2. Engineering background for technical basis and rationale**

The test requirement is altered such that the test pressure and external axial force are to be applied simultaneously in order to achieve a more realistic situation.

According to experience this amended test procedure is what the manufacturers in the market are already enforcing on their products.

### **3. Source/derivation of the proposed IACS Resolution**

None

### **4. Summary of Changes intended for the revised Resolution:**

Update of pull-out test in 2.11.5.5.5.

### **5. Points of discussions or possible discussions**

None

### **6. Attachments if any**

None

**Technical Background (TB) document for UR P2.11 (Rev.4 Mar 2016)**  
& UR P2.7.4 (Rev.8 Mar 2016) & UR P2.12 (Rev.2 Mar 2016)

**1. Scope and objectives**

- .1 To review the requirements regarding the application and details of pipe coupling joints and flexible hoses partly based upon IMO Resolution A.753(18) and update UR P2 accordingly.
- .2 To review the categorization of pipe coupling joints in Table 6 of P2.7.4 and update UR P2 accordingly.

**2. Engineering background for technical basis and rationale**

- .1 UR P2 required coupling joints and flexible hoses intended for installation in piping systems for flammable media and sea water systems be of a fire resistant type regardless of installation location. On the other hand, SOLAS regulations, such as II-2/Reg.4.2.4, etc., do not necessarily require that they be of a fire resistant type when a means of ignition is not present in the installation location.

In recent years, a member has received questions from various shipyards and manufacturers asking whether fire endurance tests for coupling joints or flexible hoses arranged in locations with low fire risk, e.g., open decks, are necessary.

Moreover, some members have experienced problems when conducting fire endurance tests due to test specimen size. ISO19921/22, which specifies fire endurance test procedures, requires that the specimen be completely engulfed in the flame envelope and this can be difficult to achieve in the case of very large test specimens.

- .2 A member received the following comment from a pipe coupling manufacturer which expressed their concern about a possible misinterpretation of the performance capabilities for mechanical pipe joints:
  - The illustration labelled "Machine Grooved Type" in Table 6 of P2.7.4 is not accurate.

**3. Source/derivation of the proposed IACS Resolution**

None.

**4. Summary of Changes intended for the revised Resolution:**

See attached table.

**5. Points of discussions or possible discussions**

See attached table.

**6. Attachments if any**

None.

Paragraph	Proposals and summarised comments from IACS Members	Conclusion
P2.7.4 Table 6	<p>Proposal:</p> <ul style="list-style-type: none"> <li>Since the illustration labelled “Machine Grooved Type” in Table 6 is not accurate, it should be replaced by the illustration provided by the <i>Victaulic Company</i>.</li> </ul>	<ul style="list-style-type: none"> <li>Agreed.</li> </ul>
P2.7.4 Table 7, Footnote 3.  P2.12.3.5	<p>Proposal:</p> <ul style="list-style-type: none"> <li>In consideration with SOLAS II-2/Reg. 4.2.3.1 and 4.2.4, slip-on joints and flexible hoses which are used for L.O. lines and other flammable oils, and are installed on open decks do not need to be of a fire-resistant type.</li> <li>In consideration with SOLAS II-2/Reg. 4.2.2.5.1, slip-on joints and flexible hoses used for F.O. lines should be of a fire-resistant type even when installed on open decks.</li> <li>“open decks” means areas defined in SOLAS II-2/Reg. 9.2.3.3.2.2(10) and 9.2.4.2.2.2(10). This means that cargo areas of tankers, ships carrying liquefied gases in bulk and ships carrying dangerous chemicals in bulk are not included for “open decks”.</li> </ul> <p>Comments:</p> <ul style="list-style-type: none"> <li>Consideration should be given to specific applications and media, e.g. non fire resistance types for sea water on open deck and fire resistant types for cargo oil, fuel and fire extinguishing systems. Moreover, the table should distinguish between wet and dry applications, e.g. fire extinguishing systems, bilge systems, sounding and vent pipes.</li> <li>Fire fighting systems on open deck with non-fire resistant connection may be broken by fire and putting to workless condition. Destruction of piping lines with flammable media cause deterioration of fire conditions.</li> <li>In considering the SOLAS requirements for fuel oil and other flammable liquids, there will need to be a strong technical argument as to why it only applies to fuel lines and not lubricating oil or other flammable liquid lines e.g. hydraulic actuating systems.</li> </ul>	<ul style="list-style-type: none"> <li>Some members were still in question as to why it only applies to fuel lines and not to other flammable liquid lines e.g. hydraulic actuating systems. Background of the regulations was not confirmed during discussion.</li> <li>However, following the decision by the qualified majority, proposals were agreed.</li> </ul>
P2.7.4 Table 7	<p>Proposal:</p> <ul style="list-style-type: none"> <li>Revised Table 7 was proposed in an effort to present the information clearer as is currently the case and to accommodate feedback from coupling manufacturers. In particular: <ul style="list-style-type: none"> <li>The footnotes are moved to the systems, thus making them applicable to all connection types. Complaints have received from manufacturers that the restrictions currently only apply to slip-on joints.</li> </ul> </li> </ul>	<ul style="list-style-type: none"> <li>Agreed.</li> </ul>
P2.7.4.3	<p>Proposal:</p> <ul style="list-style-type: none"> <li>Delete P2.7.4.3 because it is obvious and testing will only highlight discrepancies from this requirement.</li> </ul>	<ul style="list-style-type: none"> <li>Agreed.</li> </ul>
P2.7.4.7	<p>Proposal:</p> <ul style="list-style-type: none"> <li>Replace “sea openings” with terminology such as “ship’s side below the waterline”.</li> </ul>	<ul style="list-style-type: none"> <li>Agreed.</li> </ul>

	<p>Comment:</p> <ul style="list-style-type: none"> <li>Suggest to modify as follows: "ship's side below the <del>waterline bulkhead deck of passenger ships and freeboard deck of cargo ships</del>". This is the wording used in SOLAS, Reg. II-1 / 15 (title).</li> </ul>	
P2.7.4.8	<p>Proposal:</p> <ul style="list-style-type: none"> <li>Delete P2.7.4.8 as this is obvious.</li> </ul>	<ul style="list-style-type: none"> <li>Agreed.</li> </ul>
P2.7.4.11	<p>Proposal:</p> <ul style="list-style-type: none"> <li>Unrestrained slip-on joints are not defined and slip-on joints should not be used for compensation of lateral pipe deformation. The P2 test requirements for slip-on joints assume there is no lateral deformation.</li> </ul> <p>Comment:</p> <ul style="list-style-type: none"> <li>Chair explained that the intention of P2.7.4.11 is to minimise the use of slip-on joints where it is inevitable to compensate for lateral movements of piping. In practice, slip-on joints are frequently used for that purpose, hence to prohibit the use of slip-on joints for compensation of lateral deformation may be too rigorous. In this respect, modification is proposed by Chair.</li> </ul>	<ul style="list-style-type: none"> <li>Modification was agreed based on the Chair's proposal.</li> <li>The first figure of "Slip type slip-on joints" in Table 6 in UR P2.7.4 was also replaced.</li> </ul>
P2.11.5.3	<p>Proposal:</p> <ul style="list-style-type: none"> <li>The requirement "at least five times" should be re-considered. Classification societies do not need to specify minimum pipe length. This should be left up to manufacturers.</li> </ul>	<ul style="list-style-type: none"> <li>Did not achieve a majority.</li> <li>Keep as is.</li> </ul>
P2.11.5.5.1 (a)	<p>Proposal:</p> <ul style="list-style-type: none"> <li>Sixth paragraph. Delete "Other" and replace with "An".</li> </ul>	<ul style="list-style-type: none"> <li>Agreed.</li> </ul>
P2.11.5.5.1 (b) and (c)	<p>Proposal:</p> <ul style="list-style-type: none"> <li>Delete (b) and (c). These sections are covered in the sixth paragraph of (a)</li> </ul>	<ul style="list-style-type: none"> <li>Panel concurred that it is an additional requirement for compression coupling.</li> <li>Keep as is.</li> </ul>
P2.11.5.5.2	<p>Proposal:</p> <ul style="list-style-type: none"> <li>Delete the second paragraph as this is obvious.</li> </ul>	<ul style="list-style-type: none"> <li>Panel unanimously agreed to delete the second part of the text.</li> </ul>
P2.11.5.5.2 (a)	<p>Proposal:</p> <ul style="list-style-type: none"> <li>Delete the fifth paragraph as this is obvious.</li> </ul> <p>Comment:</p> <ul style="list-style-type: none"> <li>Visual examination of the joint assembly is to be carried out.</li> </ul>	<ul style="list-style-type: none"> <li>Panel unanimously agreed to delete the second part of the text.</li> </ul>
P2.11.5.5.3	<p>Proposal:</p> <ul style="list-style-type: none"> <li>For large diameters, tests according to Fig. 3 are difficult to perform and very expensive. As an alternative it is suggested also to refer to BS 4368: Part 4.</li> </ul> <p>Comment:</p> <ul style="list-style-type: none"> <li>Direct reference to BS, a regional standard, is not appropriate.</li> </ul>	<ul style="list-style-type: none"> <li>Direct reference to BS, a regional standard, was not supported.</li> <li>Keep as is.</li> </ul>
P2.11.5.5.4	<p>Proposal:</p> <ul style="list-style-type: none"> <li>(Burst pressure test) Third paragraph. Delete the last sentence or modify it to provide more clarity.</li> </ul>	<ul style="list-style-type: none"> <li>Agreed to delete.</li> </ul>
P2.12.3.5	<p>Proposal:</p> <ul style="list-style-type: none"> <li>(P2.12.3.5) Only water is permitted as a test medium. With a view to ensuring</li> </ul>	<ul style="list-style-type: none"> <li>Agreed by the qualified majority.</li> </ul>

	<p>maximum safety for both the operating personnel and the test bed in the event of damage to the hose during the test, the use of combustible test media is excluded. This poses an issue. All marine coupling on the market at the moment are tested to ISO 15540/41 therefore can never be used on a dry system.</p>	
P2.11.5.5.6.3	<p>Proposal:</p> <ul style="list-style-type: none"> <li>(Fire endurance test) The standard specifies a sensible method of testing pipe couplings where the flame shall envelop the test specimen. This will result in problems with very large test specimens. In such cases, alternative test methods and/or test procedures should be accepted.</li> </ul> <p>Comments:</p> <ul style="list-style-type: none"> <li>Provides practical cases in which alternative test methods has been accepted.</li> <li>A UR may allow an alternative method to be used only if a minimum set of criteria is provided to ensure the equivalency between the required method and the alternative one. Otherwise, the acceptance of the tested specimen may differ among Classification Societies.</li> </ul>	<ul style="list-style-type: none"> <li>None of members have experienced such cases in which alternative test methods have been accepted.</li> <li>Regardless of practical cases, proposal was agreed by the qualified majority.</li> </ul>
P2.11.5.5.6.4	<p>Proposal:</p> <ul style="list-style-type: none"> <li>(Fire endurance test) Define requirements for the thermal insulation materials used for the fire sleeves of couplings.</li> <li>A flammability test according to IEC 60695-11-5 is to be carried out.</li> </ul>	<ul style="list-style-type: none"> <li>Agreed with following modifications: <i>Thermal insulation materials <u>applied on used for fire sleeves of couplings</u> are to be <del>non-flammable</del><u>combustible</u> in dry condition and when subjected to oil spray. A <del>flammability</del><u>non-combustibility</u> test according to <del>IEC 60695-11-5</del><u>ISO 1182</u> is to be carried out.</i></li> </ul>
P2.11.5.5.7	<p>Proposal:</p> <ul style="list-style-type: none"> <li>(Vacuum test) Delete the third paragraph since the tests cannot be correctly carried out without monitoring the pressure.</li> </ul>	<ul style="list-style-type: none"> <li>Agreed.</li> </ul>

## Technical Background (TB) document for UR P2.11 (Rev.5 Jan 2021)

### 1. Scope and objectives

To review the application and details of fire-resistant type tests for mechanical joints considering dry/wet test

### 2. Engineering background for technical basis and rationale

- The industry asked to update and reconsider the test requirements as given by Table 7 of UR P2.7.4 in order to extend the range of application for slip-on-joints.
- IACS members noted inconsistent fire test requirements with respect to service conditions (dry, wet, wet/dry).
- Accordingly, test requirements for fire testing of UR P2.11.5.5.6 are amended.

### 3. Source/derivation of the proposed IACS Resolution

None

### 4. Summary of Changes intended for the revised Resolution:

- New paragraph .6.2 (fire endurance test) for dry/wet test as well as for 30 minutes dry test.
- Inserting a note (after .6.2) providing details on the test boundary condition.
- Reviewing test requirements for insulation (ref. paragraph .6.5)
- Amend section 6 notes by explanation how to handle test requiring exposure times greater than 30 minutes
- Amending the publication year of referenced standards in the text

### 5. Points of discussions or possible discussions

- Times for dry-wet test of 8/22 minutes are specified considering BS LPS1219 requiring 7.5 minutes dry and had been discussed with relevant industry.
- One Member Society proposed to modify, as follows, the proposed text for paragraph P2.11.5.5.6.5.1 as in their understanding no IACS Member Societies require fire testing according to ISO 1182 on thermal insulation materials which are declared "non-combustible" by the FTP Code:

*"Thermal insulation materials applied on couplings are to be non-combustible according to ISO 1182 ~~referred to in~~ as required by the Fire Test Procedures Code defined in SOLAS regulation II-2/3."*

The above modification was supported by the qualified majority.

## **6. Attachments if any**

Main comments received in the industry hearing

## Main comments received in the industry hearing

Industry comments	Comments by Panel
A company appreciates the division to dry and wet fire mains. We believe that our pipe couplings are not a sufficient connector for dry fire mains and should not be installed inside this applications.	Noted
It is not clear to us why “Bilge” lines are defined as dry/wet lines. The Bilge collects all kind of media flushing out of connections (mostly flanges) caused by the permanent movement of the body of the ship. The more flange connections are used, the more “wet” is the Bilge line. Since non-leaking connectors such as our FGR pipe couplings are installed inside ships, the Bilge is becoming a more and more dry line.	
We would like to propose the conditions for the wet/dry test as 2 min dry / 28 min wet and in addition to that to delete the dry test and all applications for gasketed mechanical joints defined as “dry”.	8/22 minutes to be further considered. Noted. It is up to the manufacturer to decide on range of application.
Regarding the duration of the dry/wet test we identified several regulations and specifications for fire detection and alarming systems for land based fire-extinguishing systems that can be easily transferred to maritime vessels. DIN EN 12854 and 12259 handle fire detection and responding sprinkler systems. The VdS regulation 2100 defines the responding time of dry central fire alarm systems. Whereas for wet systems the responding time is Zero (water flushes out as soon as the sprinkler opens), there are strict time limitations for dry sprinkler systems. The detecting time of dry fire extinguishing systems must be less then 30sec and max. 5 sec until the valves will open and flushing the water with 5m/sec into the distribution lines. Referring to the experience of operating test with dry detection and alarming systems that have to be done frequently the max. responding time is less than 30 sec till the water reaches the fire area.	Safety Panel, in general, considers that without clear background provided for either the Machinery Panel proposal (8 min dry test) or for industry proposal (2 min dry test) the informed advice cannot be suggested by the Safety Panel; Safety Panel cannot agree with a dispensation from 30 min dry test, and currently is not in position to provide alternative figures for supporting this new testing approach.
When the water flushes with 5 m /s through the lines, it means that after 120 sec (2 min), it went 600 m, after 240 sec (4 min) 1,200 m and after 480 sec (8 min), it went 2,400 m. Considering the length of e.g. the “Harmony of the Seas” by 362 m, after 8 min the water passes the fire area minimum 6 times.	
In regard of the responding time of 30 sec and a 4-times safety factor we came to the conclusion to propose a change of the dry/wet test to more realistic conditions such as 2min dry/28 min wet, still considering the heat impact during the heating-up.	
Firefighting systems not filled with water should have be filled with water in a few seconds or maybe 1 minute in case of fire. The sensor (smoke or heat) or sprinkler should tiger by 70°C for land application maybe on board a little bit higher or.... Therefore we do not achieve such high temperature (800°C) before the system is 100% filled with water. We do not see any improvement of safety. If we are wrong than old type of pipe connection like flange are a danger as well. Because the pipeline will move in all directions because of the thermal expansion. In that case the only possible pipe connection is welding.....	
Regarding Fire suppression systems, what is the basis of requiring an 8 minute dry fire test + 22 minute wet fire test? Most fire protection systems are designed to deliver water in under 2 minutes when a sprinkler head has been activated. If a fire suppression system is not delivering water to the activated sprinkler head in under 2 minutes, a revision to the requirements of fire suppression system water delivery requirements would be a more justifiable revision than to create an additional test method that mandate that only mechanical joints endure an 8 minute dry burn test which is not a true representation of a timeline the fitting would be exposed to in their installed environment and then a 22 minute wet test. Fire Sprinkler installation requirements should effectively reduce the allowed time for the water to arrive at the activated sprinkler head.	



Industry comments	Comments by Panel
Taking firstly the UR P2.7.4 Rev 10 Draft I can confirm that we have successfully completed IACS witnessed testing both of the 8 minutes dry / 22 minutes wet and the 30 minutes dry proposed testing schedules. We are therefore able to comply with the proposed revisions to Table 7, should they be adopted, with modified versions of our fire resistant coupling	Noted
We do not know if flanged connections are more safe than other mechanical joints in case of fire and temperatures of 800°C.. (please consider the thermal expansion of the pipe and the heat that cause loss material strength more than 50% for steel)	Noted, not a new requirement.
There is no reason why SLIP ON JOINT have to be easily accessible. Maybe all pipe connections have to be easily accessible to be sure... If they have to be please specify what is easily accessible...	Reference to MSC/Circ.734 added in P2.7.4.9 and Table 7, Footnote 2
Just to our knowledge, what is the difference between point 9 Table 7 "Fuel oil 32" and point 10/11/12 Table 7 "Lubrication oil line 23 ". Why are the numbers reversed?	Editorial, has been aligned
Please specify dry/wet, just to avoid any endless discussions. We think for bilge lines even if they are dry, there is no higher risk or danger. Bilge lines are located on the ground never in the top floor. (Fire and heat always goes up)	Even if the scenario is unlikely the integrity of bilge lines needs to be ensured
Just be aware that ISO 19921 and 19922 is made for wet testing with a medium temperature of 80°C inside of pipe. Bilge and firefighting medium is normally +/- 20° C. That means you have to specify that more detailed. Also the test procedure is not so easy to use for a dry test. Many criteria are not easy to apply for dry tests.	Noted, reference to standards will be kept
Is not necessary for all mechanical (with parts of rubber) pipe connection. No one is able from our side of few. Even flanges not. For that system only 100% welded pipeline should be allowed. By the way at the moment no test lab in the world is able to test pipe connections under dry conditions. But for us it is important the you write in the URP THE FIRE TEST HAVE TO BE DONE WITH AN ACREDITED EXTERNAL TEST LAB.	Noted. It is up to the manufacturer to decide on range of application. Requirement for accredited test lab is considered too strict. Test bench and test procedure is to be verified and tests are to witnessed by a society surveyor.
Here it started with the objection that no flange connections are considered here. Which I regard as very important because the flange connection does not always comply with the flame protection requirements or tightness requirements due to the choice of gasket and flange design (loose flange, welding flange, etc.). (Various own inhouse tests have shown that flanges do not meet the requirements.)	Open item  Flange connections may also fail dry fire tests, extension of Table 7 for flange connections to be considered in a next step.  No change at present, to be considered in next revision.
Test standard problem 1) Since there are no international standards in the dry test, the test method is not clear. 2) The test content is only for the time classification. Therefore, the possibility of passing the test is unknown at present because it has little experience. 3) Each Classification society and company may have different interpretation of the test. 4) 30 minutes Dry test definition is missing. 5) Each Classification society and company may have different interpretation of the test.	Test method is considered to be sufficiently clearly described in ISO 19921:2005 and P2.11.5.5.6

Industry comments	Comments by Panel
<p>I would like the members to ask the question, are there any documented failures of mechanical joints due to installation in dry pipe applications or dry fire main systems due to exposure to fire that have been presented as the justification for proposing these additional test requirements? If not, what is now driving the proposed revisions?</p> <p>Have any Non Mechanically Attached Fitting pipe joining methods been tested to this requirement successfully and if so what joining methods have been found to be compliant or are we to assume that brazed and welded pipe joining methods will pass this test without having been proven?</p>	<p>Change not triggered by failures but to reflect realistic conditions w.r.t. dry and wet exposure of piping systems, such as not permanently water filled fire extinguishing systems.</p> <p>Brazed connections are not permissible where fire resistance is required (melting point below 925 deg. C).</p> <p>Welded pipe joints are considered to be fire resistant.</p>
<p>Regarding UR P2.11 Rev 5 Draft please note that P2.11.5.5.6.2 lines 9-10 should read "then maintained to at least 5 bar" for clarity.</p>	<p>Wording changed from 'above' to 'at least'</p>
<p>For clarity, we would strongly recommend that the P2.11.5.5.6.5.1 clearly and unambiguously states that the thermal insulation materials "used" (rather than "applied", which can be misleading) are to be non-combustible to SOLAS regulation II-2/3, defined by the FTP Code Annex 1, Part 1 Fire Test Procedures "The non-combustibility shall be verified in accordance with the test procedure in the appendix to this part (ISO 1182)". The previous wording "A non-combustibility test according to ISO 1182 is to be carried out" was admirably clear and unambiguous to owners, surveyors, manufacturers and shipbuilders alike and should not be excluded from the revised paragraph.</p>	<p>Reference to ISO 1182 added in P2.11.5.5.6.5.1</p>
<p>At P2.11.5.5.6.5.3 It should not be assumed that the thermal insulation is to be fitted during the installation. In the case of our product, for example, the thermal insulation is pre-installed. Therefore, it should be clearly stated, for example ".....where fire resistance is required, unless the mechanical joint is delivered already fitted with thermal insulation before installation."</p>	<p>Text added to P2.11.5.5.6.5.3</p>
<p>In paragraph 7 the time to change the term "slip-on" is long overdue. The term is used pejoratively in industry to imply that what can be "slipped- on" can also be "slipped-off" and a change would, I am sure, be welcomed. The term "joints with resilient sealing arrangements" is much better, although a little cumbersome. A more accurate and easily adopted term would be "Gasketed Mechanical Couplings" which is to be found in ASTM F1476 and is commonly abbreviated to "GMCs" by industry. GMCs are further defined as:</p> <p>Type 1 – grooved mechanical couplings</p> <p>Type 2 – plain end mechanical couplings</p> <p>And classified as:</p> <p>Class 1 - rigid and restrained</p> <p>Class 2 - flexible and restrained</p> <p>Class 3 – flexible and unrestrained</p>	<p>Open item</p> <p>To be considered in a future revision</p>
<p>Finally, the drawings in the current UR P2 Table 6 "Examples of mechanical joints" are also out of date and unrepresentative of the market. New, generic representations would be highly preferable. I have attached, by way of example only, two cross sections of a Type 2 Class 2 and a Type 2 Class 3 GMC.</p>	<p>Open item</p> <p>To be considered in a future revision</p>

<b>Industry comments</b>	<b>Comments by Panel</b>
<p>Adoption of these proposed revisions will in many cases exclude most of the popular pipe joining methods that are used in many dry pipe applications including fire suppression systems as any Mechanically Attached Fitting that utilized a sealing elements are not likely to endure an 8 minute dry fire test without leakage. The result will be an very significant increase in the cost of ship building for dry pipe applications and fire suppression systems that drastically reduce the ability for ship builders to utilize the safest flame free pipe joining installation methods.</p>	<p>Noted. It is up to the manufacturer to decide on range of application. Reference to 'safest flame free' is not understood.</p>

## **Technical Background (TB) document for UR P2.11 (Rev.6 Oct 2023)**

### **1. Scope and objectives**

To update the requirements for mechanical joint type approval, aligning with the revision introduced into UR P2.7.4, also considering other aspects peculiar to UR P2.11.

### **2. Engineering background for technical basis and rationale**

Refer to item 2 of TB for UR P2.7.4 (Rev.11).

### **3. Source/derivation of the proposed IACS Resolution**

Refer to item 3 of TB for UR P2.7.4 (Rev.11).

### **4. Summary of Changes intended for the revised Resolution:**

Among the initially intended changes, following update for Table 9 is finally adopted for this revision of the UR because of Industry Hearing and Panel deliberation:

- To reflect the revision on pressure pulsation test (mandatory for Class I and II);
- To review the applicability and adequacy of exemption note 3 to vacuum test, and to rectify it to fire endurance test.
- Note 3 added and considered apply to row 6 that fire endurance test for compression couplings and pipe unions when tightening surfaces made with metal-to-metal joint since metal-to-metal joint will remain tight in case of fire as there is no sensitive material to heat used in such joint.
- To rephrase Footnote 2 to Table 9 "except permanent joint type (e.g., press type and swage type)", considering that repeated assembly test is for "a specimen 10 cycle repetition" of dismantle, re-assemble and tightness test and thereby not required for permanent joint type such as press type and swage type.

### **5. Points of discussions or possible discussions**

Refer to item 5 of TB for UR P2.7.4 (Rev.11).

In addition, it was pointed out by a member that the footnotes no.3 to Table 9 is not relevant to vacuum test but to fire endurance test. Members could not find the background of exception for the vacuum test and decided to keep the footnote No.3 on vacuum test. Furthermore, members have also understood that fire endurance test is basically performed for metallic pipe components with resilient and elastomeric seals in accordance with the scope of ISO 19921 & 19922 and can be applied the footnote No.3 as well.

Slip on joints shall contain elastomeric seals and thereby not relevant to metal-to-metal tightening surfaces.

Note 3 of table 9 in respect of exclusion of compression couplings and pipe unions from the fire endurance testing requirements is based on the understanding that these types of fittings do not include any component which may readily deteriorate in the event of fire.

### **6. Attachments if any**

Refer to item 6 of TB for UR P2.7.4 (Rev.11).

## UR P2.12 "Flexible Hoses"

### Summary

In Rev.3 of this Resolution, the term "short length" for flexible hoses and the criteria for the selection of "different nominal diameters of hose type" for prototype tests were clarified, and the way to refer to instruments other than those specified by IACS was unified.

### Part A. Revision History

Version no.	Approval date	Implementation date when applicable
Rev.3 (Feb 2021)	16 February 2021	1 July 2022
Rev.2 (Mar 2016)	2 March 2016	1 January 2017
Corr.1 (Jan 2013)	10 January 2013	-
Rev.1 (Aug 2007)	24 August 2007	1 July 2008
New (Jan 2005)	2 January 2005	Unknown

#### • Rev.3 (Feb 2021)

##### 1 Origin of Change:

- Suggestion by a Member

##### 2 Main Reason for Change:

To clarify the expressions "short length" in UR P2.12.1.1 and the criteria for the selection of "different nominal diameters of hose type" for prototype tests in UR P2.12.5.2.

##### 3 List of non-IACS Member classification societies contributing or participating in IACS Working Group:

None

##### 4 History of Decisions Made:

Issue raised on 18 March 2019

Qualified majority on 24 June 2019 in favor of developing:

- a definition of the "short length" in UR P2.12.1.1
- criteria for the selection of "different nominal diameters of hose type" in UR P2.12.5.2.

The Machinery Panel commented on drafts by correspondence during the second half of 2019.

In the latest rounds of discussion, an additional modification was made to comply with the following format when industry standards are referred to:

*[Standard Designation], [version/revision, if applicable], [year of publication] (examples: API Spec 2F, 6th Edition, 1997; ISO 4624, 2002), where [version/revision, if applicable] and/or [year of publication] are decided by IACS and are not necessarily to be the current/latest version.*

To take this opportunity, references to IMO instruments have been specified in the following format (in case where the number of amendments is large) based upon confirmation of amendments up to the latest one:

*regulation/paragraph x.x.x of SOLAS Chapter X/MARPOL Annex X/the XXX Code, as amended by IMO resolutions up to MSC.xx(xx)/MEPC.xx(xx)*

## **5 Other Resolutions Changes:**

None

## **6 Any hinderance to MASS, including any other new technologies:**

None

## **7 Dates:**

Original Proposal: 18 March 2019 (Message following 29th MP Meeting  
Made by: Machinery Panel Member)  
Panel Approval: 16 December 2020 (Ref: PM16301g\_IMj)  
GPG Approval: 16 February 2021 (Ref: 19200\_IGd)

## **• Rev.2 (Mar 2016)**

### **1 Origin for Change:**

Suggestion by IACS member

### **2 Main Reason for Change:**

To review the application and details of fire resistant type tests for flexible hoses.

### **3 List of non-IACS Member Classification Societies contributing through the TC Forum and/or participating in IACS Working Group:**

None

### **4 History of Decisions Made:**

The Machinery Panel commented on revisions by correspondence and at regularly scheduled meetings.

## 5 Other Resolutions Changes

P2.7.4 (Rev.8) and P2.11 (Rev.4) are also revised under the same task number.

### 6 Dates:

Original Proposal: 30 January 2012 Made by a Member  
Panel Approval: 28 December 2015 (Ref: PM11921)  
GPG Approval: 2 March 2016 (Ref: 14079\_IGe)

- **Corr.1 (Jan 2013)**

#### 1 Origin of Change:

Suggestion by an IACS member

#### 2 Main Reason for Change:

To correct the namings of ISO 6802 and ISO 6803.

#### 3 List of non-IACS Member classification societies contributing through the TC Forum and/or participating in IACS Working Group:

None

#### 4 History of Decisions Made:

Machinery Panel Chairman informed GPG of this correction, which was raised by a Machinery Panel member. Noting that this is a straightforward correction, GPG Chairman requested Permanent Secretariat to issue a correction to the UR. A simple history file was made to record this correction.

## 5 Other Resolutions Changes

None

### 6 Dates:

Original Proposal: 09 January 2013 Made by Machinery Panel Chairman  
GPG Approval: 10 January 2013 (Ref: 13008\_IGa)

- **Rev.1 (Aug 2007)**

GPG Reference: 6216

See TB document in Part B.

- **New (Jan 2005)**

See TB document in Part B.

\*\*\*\*\*

## Part B. Technical Background

List of Technical Background (TB) documents for UR P2.12:

Annex 1. **TB for New (Jan 2005)**

See separate TB document in Annex 1.

Annex 2. **TB for Rev.1 (Aug 2007)**

See separate TB document in Annex 2.

Annex 3. **TB for Rev.2 (Mar 2016)**

See separate TB document in Annex 3.

Annex 4. **TB for Rev.3 (Feb 2021)**

See separate TB document in Annex 4.



**Note:** *There is no separate Technical Background (TB) document available for the Corr.1 (Jan 2013)*



## **Technical Background document for draft UR P2.8 on Flexible hoses (WP/MCH task 12)**

### **1. Scope and objective**

The Flexible Hoses both metallic and non-metallic materials widely used in machinery spaces of ships for connection between fixed piping system and items of machinery or equipment that is subject to movement. Taking into account that use of non-standard hoses or their improper installation connect with risk of fire or flooding at the 19<sup>th</sup> Meeting of AHG/PPV it was decided to unify the requirements and test procedures for flexible hoses.

### **2. Points of discussion**

Permissible of use the Flexible Hoses for thermal oil systems, requirements to end connections as well as requirements to fire resistant and pressure impulse testing have been discussed. The draft UR was accepted by the WP without reservations.

### **3. Source of proposed requirements**

1. Reg. II-2/2.2.5.1, II-2/2.3.1, II-2/2.4
2. Rules in force of IACS Members
3. ISO 6802 - Rubber and plastic hoses and hose assemblies - Hydraulic pressure impulse test without flexing
4. ISO 6308 - Rubber and plastic hoses and hose assemblies - Hydraulic pressure impulse test with flexing
5. ISO 15540 - Ships and marine technology - Fire resistance of hose assemblies – Test method
6. ISO 15540 - Ships and marine technology - Fire resistance of hose assemblies - Requirements for test bench
7. ISO 7840- Small craft - Fire resistant of fuel hoses
8. ISO 10380 Pipework- Corrugated metal hoses and hose assemblies

### **4. Notes by the Permanent Secretariat**

GPG added the following changes to the draft UR P2.12:

1) P2.12.2.2: The following new sentence was added:

“Flexible hoses in high pressure fuel oil injection systems are not to be accepted”

2) P2.12.5.3: With regard to the “5 minutes” testing period, the following reference to the international standards was added:

“The international standards, e.g. EN or SAE for burst testing of non-metallic hoses, require the pressure to be increased until burst without any holding period at 4 x MWP”

TB submitted by the WP/MCH Chairman.

IACS Machinery Panel Task PM6303

**Technical Background**  
**UR P2.12 (Rev.1) – August 2007**  
***Revision of UR P2.12.3.1***

In the current UR P2.12.3.1, it is prescribed that "Flexible hoses constructed of rubber or plastics materials and intended for use in bilge, ballast, compressed air, oil fuel, lubricating, hydraulic and thermal oil systems are to incorporate a single, double or more, closely woven integral wire braid or other suitable material reinforcement".

However, according to flexible hose manufacturers, flexible hoses made of plastic materials such as Teflon and Nylon are not able to be incorporated by closely woven integral wire braid or other suitable material reinforcement.

Because, fluorine rein has property of bad wet ability and bad adhesion to other substances, therefore, the incorporated woven wire braid easily peels off from fluorine rein.

UR P2.12 was established in order for the use of non-standard hoses or improper installation not to cause the fire or flooding. Member societies agreed that it was sufficient as flexible hose that plastic hoses such as Teflon and Nylon hoses were satisfied with National or International standard, e.g. ISO mentioned in UR P2.12, even if closely woven integral wire braid or other suitable material reinforcement was not incorporated.

The changes to UR P2.12.3.1 were adopted unanimously by Panel members.

Hamburg, 3 July 2007  
IACS Machinery Panel Chairman

**Permanent Secretariat note (September 2007):**

The changes to UR P2.12.3.1 were approved by GPG on 24 August 2007 (ref. 6216\_IGe) with an implementation date of 1 July 2008.

**Technical Background (TB) document for UR P2.12 (Rev.2 Mar 2016)**  
& UR P2.7.4 (Rev.8 Mar 2016) & UR P2.11 (Rev.4 Mar 2016)

**1. Scope and objectives**

- .1 To review the requirements regarding the application and details of pipe coupling joints and flexible hoses partly based upon IMO Resolution A.753(18) and update UR P2 accordingly.
- .2 To review the categorization of pipe coupling joints in Table 6 of P2.7.4 and update UR P2 accordingly.

**2. Engineering background for technical basis and rationale**

- .1 UR P2 required coupling joints and flexible hoses intended for installation in piping systems for flammable media and sea water systems be of a fire resistant type regardless of installation location. On the other hand, SOLAS regulations, such as II-2/Reg.4.2.4, etc., do not necessarily require that they be of a fire resistant type when a means of ignition is not present in the installation location.

In recent years, a member has received questions from various shipyards and manufacturers asking whether fire endurance tests for coupling joints or flexible hoses arranged in locations with low fire risk, e.g., open decks, are necessary.

Moreover, some members have experienced problems when conducting fire endurance tests due to test specimen size. ISO19921/22, which specifies fire endurance test procedures, requires that the specimen be completely engulfed in the flame envelope and this can be difficult to achieve in the case of very large test specimens.

- .2 A member received the following comment from a pipe coupling manufacturer which expressed their concern about a possible misinterpretation of the performance capabilities for mechanical pipe joints:
  - The illustration labelled "Machine Grooved Type" in Table 6 of P2.7.4 is not accurate.

**3. Source/derivation of the proposed IACS Resolution**

None.

**4. Summary of Changes intended for the revised Resolution:**

See attached table.

**5. Points of discussions or possible discussions**

See attached table.

**6. Attachments if any**

None.

Paragraph	Proposals and summarised comments from IACS Members	Conclusion
P2.7.4 Table 6	<p>Proposal:</p> <ul style="list-style-type: none"> <li>Since the illustration labelled “Machine Grooved Type” in Table 6 is not accurate, it should be replaced by the illustration provided by the <i>Victaulic Company</i>.</li> </ul>	<ul style="list-style-type: none"> <li>Agreed.</li> </ul>
P2.7.4 Table 7, Footnote 3.  P2.12.3.5	<p>Proposal:</p> <ul style="list-style-type: none"> <li>In consideration with SOLAS II-2/Reg. 4.2.3.1 and 4.2.4, slip-on joints and flexible hoses which are used for L.O. lines and other flammable oils, and are installed on open decks do not need to be of a fire-resistant type.</li> <li>In consideration with SOLAS II-2/Reg. 4.2.2.5.1, slip-on joints and flexible hoses used for F.O. lines should be of a fire-resistant type even when installed on open decks.</li> <li>“open decks” means areas defined in SOLAS II-2/Reg. 9.2.3.3.2.2(10) and 9.2.4.2.2.2(10). This means that cargo areas of tankers, ships carrying liquefied gases in bulk and ships carrying dangerous chemicals in bulk are not included for “open decks”.</li> </ul> <p>Comments:</p> <ul style="list-style-type: none"> <li>Consideration should be given to specific applications and media, e.g. non fire resistance types for sea water on open deck and fire resistant types for cargo oil, fuel and fire extinguishing systems. Moreover, the table should distinguish between wet and dry applications, e.g. fire extinguishing systems, bilge systems, sounding and vent pipes.</li> <li>Fire fighting systems on open deck with non-fire resistant connection may be broken by fire and putting to workless condition. Destruction of piping lines with flammable media cause deterioration of fire conditions.</li> <li>In considering the SOLAS requirements for fuel oil and other flammable liquids, there will need to be a strong technical argument as to why it only applies to fuel lines and not lubricating oil or other flammable liquid lines e.g. hydraulic actuating systems.</li> </ul>	<ul style="list-style-type: none"> <li>Some members were still in question as to why it only applies to fuel lines and not to other flammable liquid lines e.g. hydraulic actuating systems. Background of the regulations was not confirmed during discussion.</li> <li>However, following the decision by the qualified majority, proposals were agreed.</li> </ul>
P2.7.4 Table 7	<p>Proposal:</p> <ul style="list-style-type: none"> <li>Revised Table 7 was proposed in an effort to present the information clearer as is currently the case and to accommodate feedback from coupling manufacturers. In particular: <ul style="list-style-type: none"> <li>The footnotes are moved to the systems, thus making them applicable to all connection types. Complaints have received from manufacturers that the restrictions currently only apply to slip-on joints.</li> </ul> </li> </ul>	<ul style="list-style-type: none"> <li>Agreed.</li> </ul>
P2.7.4.3	<p>Proposal:</p> <ul style="list-style-type: none"> <li>Delete P2.7.4.3 because it is obvious and testing will only highlight discrepancies from this requirement.</li> </ul>	<ul style="list-style-type: none"> <li>Agreed.</li> </ul>
P2.7.4.7	<p>Proposal:</p> <ul style="list-style-type: none"> <li>Replace “sea openings” with terminology such as “ship’s side below the waterline”.</li> </ul>	<ul style="list-style-type: none"> <li>Agreed.</li> </ul>

	<p>Comment:</p> <ul style="list-style-type: none"> <li>Suggest to modify as follows: "ship's side below the <del>waterline bulkhead deck of passenger ships and freeboard deck of cargo ships</del>". This is the wording used in SOLAS, Reg. II-1 / 15 (title).</li> </ul>	
P2.7.4.8	<p>Proposal:</p> <ul style="list-style-type: none"> <li>Delete P2.7.4.8 as this is obvious.</li> </ul>	<ul style="list-style-type: none"> <li>Agreed.</li> </ul>
P2.7.4.11	<p>Proposal:</p> <ul style="list-style-type: none"> <li>Unrestrained slip-on joints are not defined and slip-on joints should not be used for compensation of lateral pipe deformation. The P2 test requirements for slip-on joints assume there is no lateral deformation.</li> </ul> <p>Comment:</p> <ul style="list-style-type: none"> <li>Chair explained that the intention of P2.7.4.11 is to minimise the use of slip-on joints where it is inevitable to compensate for lateral movements of piping. In practice, slip-on joints are frequently used for that purpose, hence to prohibit the use of slip-on joints for compensation of lateral deformation may be too rigorous. In this respect, modification is proposed by Chair.</li> </ul>	<ul style="list-style-type: none"> <li>Modification was agreed based on the Chair's proposal.</li> <li>The first figure of "Slip type slip-on joints" in Table 6 in UR P2.7.4 was also replaced.</li> </ul>
P2.11.5.3	<p>Proposal:</p> <ul style="list-style-type: none"> <li>The requirement "at least five times" should be re-considered. Classification societies do not need to specify minimum pipe length. This should be left up to manufacturers.</li> </ul>	<ul style="list-style-type: none"> <li>Did not achieve a majority.</li> <li>Keep as is.</li> </ul>
P2.11.5.5.1 (a)	<p>Proposal:</p> <ul style="list-style-type: none"> <li>Sixth paragraph. Delete "Other" and replace with "An".</li> </ul>	<ul style="list-style-type: none"> <li>Agreed.</li> </ul>
P2.11.5.5.1 (b) and (c)	<p>Proposal:</p> <ul style="list-style-type: none"> <li>Delete (b) and (c). These sections are covered in the sixth paragraph of (a)</li> </ul>	<ul style="list-style-type: none"> <li>Panel concurred that it is an additional requirement for compression coupling.</li> <li>Keep as is.</li> </ul>
P2.11.5.5.2	<p>Proposal:</p> <ul style="list-style-type: none"> <li>Delete the second paragraph as this is obvious.</li> </ul>	<ul style="list-style-type: none"> <li>Panel unanimously agreed to delete the second part of the text.</li> </ul>
P2.11.5.5.2 (a)	<p>Proposal:</p> <ul style="list-style-type: none"> <li>Delete the fifth paragraph as this is obvious.</li> </ul> <p>Comment:</p> <ul style="list-style-type: none"> <li>Visual examination of the joint assembly is to be carried out.</li> </ul>	<ul style="list-style-type: none"> <li>Panel unanimously agreed to delete the second part of the text.</li> </ul>
P2.11.5.5.3	<p>Proposal:</p> <ul style="list-style-type: none"> <li>For large diameters, tests according to Fig. 3 are difficult to perform and very expensive. As an alternative it is suggested also to refer to BS 4368: Part 4.</li> </ul> <p>Comment:</p> <ul style="list-style-type: none"> <li>Direct reference to BS, a regional standard, is not appropriate.</li> </ul>	<ul style="list-style-type: none"> <li>Direct reference to BS, a regional standard, was not supported.</li> <li>Keep as is.</li> </ul>
P2.11.5.5.4	<p>Proposal:</p> <ul style="list-style-type: none"> <li>(Burst pressure test) Third paragraph. Delete the last sentence or modify it to provide more clarity.</li> </ul>	<ul style="list-style-type: none"> <li>Agreed to delete.</li> </ul>
P2.12.3.5	<p>Proposal:</p> <ul style="list-style-type: none"> <li>(P2.12.3.5) Only water is permitted as a test medium. With a view to ensuring</li> </ul>	<ul style="list-style-type: none"> <li>Agreed by the qualified majority.</li> </ul>

	<p>maximum safety for both the operating personnel and the test bed in the event of damage to the hose during the test, the use of combustible test media is excluded. This poses an issue. All marine coupling on the market at the moment are tested to ISO 15540/41 therefore can never be used on a dry system.</p>	
P2.11.5.5.6.3	<p>Proposal:</p> <ul style="list-style-type: none"> <li>(Fire endurance test) The standard specifies a sensible method of testing pipe couplings where the flame shall envelop the test specimen. This will result in problems with very large test specimens. In such cases, alternative test methods and/or test procedures should be accepted.</li> </ul> <p>Comments:</p> <ul style="list-style-type: none"> <li>Provides practical cases in which alternative test methods has been accepted.</li> <li>A UR may allow an alternative method to be used only if a minimum set of criteria is provided to ensure the equivalency between the required method and the alternative one. Otherwise, the acceptance of the tested specimen may differ among Classification Societies.</li> </ul>	<ul style="list-style-type: none"> <li>None of members have experienced such cases in which alternative test methods have been accepted.</li> <li>Regardless of practical cases, proposal was agreed by the qualified majority.</li> </ul>
P2.11.5.5.6.4	<p>Proposal:</p> <ul style="list-style-type: none"> <li>(Fire endurance test) Define requirements for the thermal insulation materials used for the fire sleeves of couplings.</li> <li>A flammability test according to IEC 60695-11-5 is to be carried out.</li> </ul>	<ul style="list-style-type: none"> <li>Agreed with following modifications: <i>Thermal insulation materials <u>applied on used for fire sleeves of couplings</u> are to be <del>non-flammable</del><u>combustible</u> in dry condition and when subjected to oil spray. A <del>flammability</del><u>non-combustibility</u> test according to <del>IEC 60695-11-5</del><u>ISO 1182</u> is to be carried out.</i></li> </ul>
P2.11.5.5.7	<p>Proposal:</p> <ul style="list-style-type: none"> <li>(Vacuum test) Delete the third paragraph since the tests cannot be correctly carried out without monitoring the pressure.</li> </ul>	<ul style="list-style-type: none"> <li>Agreed.</li> </ul>

## Technical Background (TB) document for UR P2.12 (Rev.3 Feb 2021)

### 1. Scope and objectives

As set out in GPG 87 FUA 2, UR P2.12, Rev.3 of this UR is to cite the year of publication of the standards referenced in the text of the UR.

### 2. Engineering background for technical basis and rationale

#### Clarification on the term “short length” for flexible hoses and the criteria for the selection of “different nominal diameters of hose type” for prototype tests

.1 UR P2.12.1.1 defines a flexible hose assembly as a “short length of metallic or non-metallic hose normally with prefabricated end fittings ready for installation”. In addition, according to IMO Circular MSC.1/Circ.1321, for flammable oil systems, “Flexible pipes, hoses and hose assemblies – which are flexible hoses with end fittings attached – should be in as short lengths as practicable, but should not, in general, exceed 1.5 m in length, and only be used where necessary to accommodate relative movement between fixed piping and machinery parts”.

It was agreed to introduce this maximum length criteria in the UR P2.12.1.1.

.2 UR P2.12.5.2 requires the tests, “as applicable, to be carried out on different nominal diameters of hose type complete with end fittings for pressure, burst, impulse resistance and fire resistance in accordance with the requirements of the relevant standard”. It was agreed to follow the approach of ISO 15540 - Ships and marine technology - Fire resistance of hose assemblies – Test methods, paragraph 6, which requires the tests to be carried out on a minimum of three hose diameters and the smallest, the middle and the largest nominal diameters to be tested for each series. It was also considered that a test on a hose with a diameter D qualifies a hose for the range 0.5D – 2D.

#### Format for references to Industry standards

*[Standard Designation], [version/revision, if applicable], [year of publication]*  
(examples: API Spec 2F, 6th Edition, 1997; ISO 4624, 2002), where [version/revision, if applicable] and/or [year of publication] are decided by IACS and are not necessarily to be the current/latest version.

### 3. Source/derivation of the proposed IACS Resolution

See paragraph .2 above.

### 4. Summary of Changes intended for the revised Resolution:

See paragraph .2 above. For Industry standards, UR P2.12 has been updated to specify the revision/version of the ISO standards as follows:

ISO standards	Replaced by
ISO 6802	ISO 6802:2018
ISO 6803	ISO 6803:2017
ISO 10380	ISO 10380:2012
ISO 15540	ISO 15540:2016
ISO 15541	ISO 15541:2016

### 5. Points of discussions or possible discussions

#### Clarification on the term “short length” for flexible hoses

The initial draft for Revision of UR P2.12.1.1 was worded as follows:

*Note: Flexible hose assemblies for flammable oil systems should not, in general, exceed 1.5 m in length. See IMO Circular MSC.1/Circ.1321, paragraph 2.1.*

One member opined that the reference to the IMO Circular was not necessary.

Some members proposed to introduce the criteria for the length of flexible hoses to be < 1.5 m as a mandatory requirement and not as a recommendation.

One member also proposed to include flammable and toxic media in the scope of the Note, in addition to essential services.

All proposals were supported by a majority of the members and reflected in the final version of the revision.

### **Criteria for the selection of "different nominal diameters of hose type" for prototype tests**

The initial draft for Revision of UR )2.12.5.2 was worded as follows:

*Note:*

*Prototype tests are to be carried out for each size of hose assembly. However, for ranges with more than 3 different diameters, the prototype tests may be carried out only for:*

- *the smallest diameter,*
- *the largest diameter,*
- *Intermediate diameters selected based on the principle that prototype tests carried out for a hose assembly with a diameter  $D$  are considered valid only for the diameters ranging between  $0.5 D$  and  $2 D$ .*

One member proposed the following modification:

*"However, for ranges with more than 3 different diameters, at least the following samples are to be tested ~~the prototype tests may to be carried out only for~~".*

One member opined that, in order to avoid conflict with the requirements of ISO 15540:2016 in the case of fire resistance tests, the following text should be added at the end of the Note.

"For fire resistance tests the specimens shall be selected in accordance with ISO 15540:2016."

Both modifications were agreed by a majority of the members and reflected in the final version of the revision.

### **Other proposals**

At the final stage of discussion, the following modification was proposed by a Member, but the qualified majority agreement has not been achieved:

Note \* The international standards, e.g. EN or SAE for burst testing of non-metallic hoses, require the pressure to be increased until burst without any holding period at minimum of 4 x MAWP/Design pressure.

MAWP =Maximum Allowable Pressure or Design Pressure.

## **6. Attachments if any**

None



## UR P2.13 “Installation”

### Summary

In the Revision 1 of UR P2.13, the examples in the round brackets in paragraph P2.13.1.1 have been deleted as they are considered not appropriate/useful for the purpose of this requirement (in fact a chain locker is designed to be open to seawater and fish holds may also contain seawater) and the cargo holds to which this UR is to be applied have been clarified.

### Part A. Revision History

Version no.	Approval date	Implementation date when applicable
Rev.1 (Jan 2021)	21 January 2021	1 July 2022
New (Oct 2018)	13 October 2018	1 January 2020

- **Rev.1 (Jan 2021)**

#### 1 Origin for Change:

- Suggestion by IACS member

#### 2 Main Reason for Change:

To revise the UR P2.13 (New, Oct. 2018) in order to delete the requirement of protection of seawater pipes in other spaces where pipes may be subject to impacts as it is considered vague, and the examples in the round brackets in paragraph P2.13.1.1 as they are considered not appropriate/useful for the purpose of this requirement (in fact a chain locker is designed to be open to seawater and fish holds may also contain seawater).

#### 3 List of non-IACS Member Classification Societies contributing or participating in IACS Working Group:

None

#### 4 History of Decisions Made:

Machinery Panel by correspondence

#### 5 Other Resolutions Changes

None

#### 6 Any hinderance to MASS, including any other new technologies:

None

**7 Dates:**

Original Proposal: 21 February 2019 (Ref: PM16301dIMa)  
Panel Approval: 24 December 2020 (Ref: PM20305\_IMi)  
GPG Approval: 21 January 2021 (Ref: 19141\_IGi)

• **New (Oct 2018)**

**1 Origin for Change:**

Suggestion by IACS member

**2 Main Reason for Change:**

Triggered by an NTSB recommendation towards IACS, members agreed to add a new section 13 to UR P2.

**3 List of non-IACS Member Classification Societies contributing through the TC Forum and/or participating in IACS Working Group:**

None

**4 History of Decisions Made:**

Machinery Panel by correspondence

**5 Other Resolutions Changes**

N/A

**6 Dates:**

Original Proposal: 12 June 2018 made by a GPG Member  
Panel Approval: 07 September (Ref: PM16301b)  
GPG Approval: 13 October 2018 (Ref: 18028\_IGn)

## **Part B. Technical Background**

List of Technical Background (TB) documents for UR P2.13:

Annex 1. **TB for New (Oct 2018)**

See separate TB document in Annex 1.

Annex 2. **TB for Rev.1 (Jan 2021)**

See separate TB document in Annex 2.



## Technical Background (TB) document for UR P2.13 (New Oct 2018)

### 1. Scope and objectives

- To develop new installation requirements for seawater supply pipes located in cargo holds

### 2. Engineering background for technical basis and rationale

UR P2.13 (New)

UR P2.13.1 has been developed to protect seawater supply piping located in cargo holds from mechanical damage. IACS found it appropriate to apply this provision to new vessels with contracts on or after 1 January 2020.

It is noted that for plastic piping, a similar yet generalized provision is included in UR P4.6.3.3.

### 3. Source/derivation of the proposed IACS Resolution

- P2.13.1 was developed based on a US NTSB recommendation following the sinking of the vessel 'El Faro'. The NTSB report opined that "It is likely that the seawater piping below the waterline to the vessel's emergency fire pump in cargo hold 3 was inadequately protected from impact and was struck by one or more cars that had broken free of their lashings" (NTSB Report). The recommendation made to IACS was that "your members to require that on new and existing vessels, seawater supply piping below the waterline in all cargo holds be protected from impact" (Rec M-17-56).

### 4. Summary of Changes intended for the revised Resolution:

- Add new section P2.13.1 in respect of protection of piping in cargo holds

### 5. Points of discussions or possible discussions

UR P2.13 (New)

It should also be noted that although the NTSB recommendation to IACS (see the HF-TB) suggests this be implemented for new and existing ships, it is proposed to not retroactively apply this new provision in UR P2 to existing ships. This is because, although the new proposal to UR P2 specifically points out this topic to improve awareness, it is generally noted that existing designer's practice and some Rules may generally include this subject already and has been applied on existing vessels

### 6. Attachments if any

None

## **Technical Background (TB) document for UR P2.13 (Rev.1, Jan 2021)**

### **1. Scope and objectives**

To revise the UR P2.13 (New, Oct. 2018) in order to delete the requirement of protection of seawater pipes in other spaces where pipes may be subject to impacts as it is considered vague, and the examples in the round brackets in paragraph P2.13.1.1 as they are considered not appropriate/useful for the purpose of this requirement.

### **2. Engineering background for technical basis and rationale**

The examples in the round brackets in paragraph P2.13.1.1 were considered not appropriate/useful for the purpose of this requirement for the reason that a chain locker is designed to be open to seawater and fish holds may also contain seawater.

### **3. Source/derivation of the proposed IACS Resolution**

P2.13.1 was developed based on a US NTSB recommendation following the sinking of the vessel 'El Faro'. The NTSB report opined that "It is likely that the seawater piping below the waterline to the vessel's emergency fire pump in cargo hold 3 was inadequately protected from impact and was struck by one or more cars that had broken free of their lashings" (NTSB Report). The recommendation made to IACS was that "your members to require that on new and existing vessels, seawater supply piping below the waterline in all cargo holds be protected from impact" (Rec M-17-56).

### **4. Summary of Changes intended for the revised Resolution:**

The wording "and in other spaces where pipes may be subject to impacts (e.g. fish holds, chain lockers)" has been deleted.

The whole P2.13.1.1. has been reworded to read: "P2.13.1.1 Seawater pipes in cargo holds for dry cargoes, including cargo spaces of container ships, ro-ro ships, are to be protected from impact of cargo where they are liable to be damaged."

### **5. Points of discussions or possible discussions**

After a first consideration by the Panel the qualified majority agreed to delete the examples in the round brackets but regarding the text of the requirement the following four (4) Options were proposed to the Panel attention:

#### **Option 1**

"P2.13.1.1 Seawater pipes located in cargo holds are to be protected from impact where they are liable to be damaged by cargo."

#### **Option 2**

"P2.13.1.1 Seawater pipes located in cargo holds and in other spaces where pipes may be subject to impacts are to be protected from mechanical damage."

#### **Option 3**

"P2.13.1.1 Seawater pipes located in cargo and service spaces below the waterline where pipe failure could cause flooding are to be protected from mechanical damage."

#### Option 4

"P2.13.1.1 Seawater pipes below freeboard deck located in cargo holds and in other compartments where pipes may be subject to impacts are to be protected from mechanical damage."

The qualified majority of Panel Members agreed to **Option 1 and 2**, with preference for Option 2.

Following discussion at GPG, the OPTION 2 was not accepted by the qualified majority and the UR was reverted back to the Panel, which developed and approved the new text, without reference to "other places where pipes may be subject to impacts" nor relevant examples, and with limitation to pipes below the freeboard deck.

- In the latest rounds, a discussion was also carried out as to whether "cargo holds" should include hold spaces as normally provided on gas carriers/oil and/or chemical tankers or cargo tanks, and it was confirmed that the intention of this UR is to cover spaces for the carriage of cargo where mechanical damage by cargo can occur, and does not include spaces like hold spaces of gas carriers/oil and/or chemical tankers or cargo tanks.

In this regard an IACS Member proposed to modify the UR to read as follow: "...are to be protected from impact only where they are liable to be damaged by cargo..."; the proposal was however not supported by the qualified majority.

- An IACS Member proposed to extend the field of application of UR P2.13.1.1 in order to consider not only seawater pipes but also other pipes, like those containing dangerous substances (e.g. ammonia), that can be damaged by an impact; the proposal was however not supported by the qualified majority.
- An IACS Member proposed to modify the requirement in UR P2.13.1.1, as follows, for the reason that in their understanding the pipes can be also damaged during the loading or unloading operations of cargoes:

*"Seawater pipes located in cargo holds are to be protected from impact where they are liable to be damaged during cargo handling or by cargo."*

The proposal was however not supported by the qualified majority.

- Based upon GPG instruction, Machinery Panel received Safety Panel provided the modified text as follows:

*"Seawater pipes in cargo holds are to be protected from impact where they are liable to be damaged by cargo"*

- During a further review by Machinery Panel, draft amendments to SOLAS Chapter II-1 were also taken into account. The text to be specified in UR P2.13.1.1 has been updated as follows:

*"Seawater pipes in cargo holds for dry cargoes, including cargo spaces of container ships and car carriers, etc. are to be protected from impact where they are liable to be damaged by cargo".*

- Among the following proposals raised at GPG, Machinery Panel agreement has not been achieved on the last proposal:
  - deletion of the word "etc."

- replacement of the term "*car carriers*" with "*ro-ro ships*"
- a change of the phrase "*protected from impact of cargo where they are liable to be damaged ~~by cargo~~*" which may result that seawater pipes in cargo holds need to be protected in all cases, when other damages (e.g. damages of such pipes occurred in the event of hull damages) shall be taken into account; and
- a change of the term "*cargo holds for dry cargoes*" to "*cargo holds of dry cargo ships*" which may result that cargo holds of combination carriers are excluded from the scope of application of Rev.1 of UR P2.13.

**6. Attachments if any**

None

## UR P3 “Air Pipe Closing Devices”

### Summary

In Rev.5 of this UR, changes have been made to address numerical analysis using CFD (computational fluid dynamics) as an alternative means to undertake reverse flow test.

### Part A. Revision History

Version no.	Approval date	Implementation date when applicable
Rev.5 (Apr 2021)	13 April 2021	1 July 2022
Rev.4 (Jan 2016)	22 January 2016	1 January 2017
Rev.3 (Nov2012)	2 November 2012	1 January 2014
Rev.2 (March2004)	4 March 2004	-
Corr.1 (April2002)	30 April 2002	-
Rev.1 (May2001)	17 May 2001	-
Corr1 (May1998)	20 May 1998	-
New (1991)	-	-

- **Rev.5 (Apr 2021)**

#### 1 Origin of Change:

- Suggestion by IACS member

#### 2 Main Reason for Change:

As per IACS UR P3 Rev 4 2016, para 3.4.1.c, Reverse flow test shall be performed in order to Type approve Air pipe automatic closing devices/ the air vent valves. This test may require very high flow velocity depending on the geometry of the valve and hence would require manufacturers to use vacuum pumps of very high capacity to conduct the test. This poses practical difficulty for the manufacturer to conduct the test in case of large diameter vents. To overcome this difficulty, Rev. 5 is proposed to include CFD simulation as an alternative means for determining permissible reverse flow.

To take this opportunity, references to IMO instruments have been specified in the following format based upon confirmation of amendments up to the latest one:

*regulation/paragraph x.x.x of SOLAS Chapter X/MARPOL Annex X/the XXX Code, as amended by IMO resolutions up to MSC.xx(xx)/MEPC.xx(xx)*

#### 3 List of non-IACS Member classification societies contributing or participating in IACS Working Group:

None



#### **4 History of Decisions Made:**

Form A was approved on 06/02/2019 by Machinery Panel.

A Member proposed an initial draft to Panel on 27/02/2019:

The discussion on the initial draft led to the following conclusions:

- Consideration of CFD for air pipe heads up to twice the size of the validated CFD model is unanimously agreed to be deleted.
- Intended CFD simulations are applicable for pipe heads of 400 mm nominal diameter and above

As per the concerns and comments received from the panel additional points are discussed and following outcome from the same are obtained

- The information about using of CFD modelling is not needed to be stated in the certificate.
- Paragraph 3.2.5 regarding the clear area through an air pipe closing device in the open position to be retained.

Based on the discussions following is summarized

- Mesh convergence studies are to be carried out and documented.
- Exclusive mention of carrying out CFD simulations as an alternative means of reverse flow test 'in case of inability of physical tests' is considered not necessary in UR text.
- Para 3.2.5 is qualified to be retained as a general requirement

#### **5 Other Resolutions Changes:**

None

#### **6 Any hinderance to MASS, including any other new technologies:**

None

#### **7 Dates:**

Original Proposal: 13 August 2018 (Made by Machinery Panel)  
Panel Approval: 29 March 2021 (Ref: 19039\_PMb)  
GPG Approval: 13 April 2021 (Ref: 19039\_IGb)

- **Rev.4 (Jan 2016)**

**.1 Origin of Change:**

- Suggestion by an IACS member

**.2 Main Reason for Change:**

This revision of UR P3 is done to clarify the definition of the term "chambers" in UR P3.2.9 for its uniform application as per the agreed IACS common understanding, more specifically whether the side covers of air pipe head is also part of chamber to be of minimum thickness of 6 mm.

**3 List of non-IACS Member classification societies contributing through the TC Forum and/or participating in IACS Working Group:**

None

**.4 History of Decisions Made:**

Agreed Form A was submitted to GPG by 15132\_PMa dated 31 July 2015.

**.5 Other Resolutions Changes**

None

**.6 Dates:**

Original Proposal: 8 April 2015 Made by a Member  
Panel Approval: 22nd Panel Meeting  
GPG Approval: 22 January 2016 (Ref: 15132\_IGe)

- **Rev.3 (Nov 2012)**

**.1 Origin of Change:**

- Suggestion by an IACS member

**.2 Main Reason for Change:**

To clarify the type-test method of P3 for tightness test and to evaluate tests to prove the ability to handle vacuum and criteria for the relationship area requirement and flow characteristics.

**.3 List of non-IACS Member classification societies contributing through the TC Forum and/or participating in IACS Working Group:**

None

**.4 History of Decisions Made:**

Form A was agreed in May 2011.

## **.5 Other Resolutions Changes**

None

## **.6 Dates:**

Original Proposal: *10 March 2011 Made by a Member*

Panel Approval: *24 September 2012*

GPG Approval: *02 November 2012 (Ref: 11068\_IGd)*

- **Rev.2 (March 2004)**

The review by AHG/FDG of BEA/mer technical report on air vent arrangements recommended amending the UR P3.

All recommendations arising from AHG/FDF review were accepted by the WP and introduced into the draft revision.

Original Proposal was made on 12 February 2004 and GPG Approval was given on 04 March 2004 (GPG subject No: 3003cIGb).

See separate TB document in Part B Annex 2.

- **Corr.1 (April 2002)**

A member suggested editorial refinements to the UR P3 on 29 April 2002 and done on 30 April 2002.

No TB document available.

- **Rev.1 (May 2001)**

AHG/PPV submitted proposed revision replacing the existing P3 to GPG 50 (0077a, 18/1/2001).

Review of UR P1.2, P2.1, P2.2, P2.3, P2.5, and P3 has been carried out in line with annual Task 1A. The main goal of this review was elimination of IACS member reservation. As has been noted that: "P1 & P2 have not been implemented since the Rules are formatted around US standards such as ANSI, ASME, USC Regulations, etc. P 1 & P2 are not conducive (sic) to incorporate in the Rules". With regard to P3, it needed to be changed editorially.

Members unanimously agreed to the revision.

See separate TB document in Part B Annex 1.

- **Corr.1 (May 1998)**

P.3.2.1 contained editorial error i.e. inclination of  $\pm 40$  deg. C, which should read  $\pm 40$  degrees. The error was corrected

No TB document available.

- **New (1991)**

No HF file or TB document available.

\*\*\*\*\*

## Part B. Technical Background

List of Technical Background (TB) documents for UR P3:

Annex 1. **TB for Rev.1 (May 2001)**

See separate TB document in Annex 1.

Annex 2. **TB for Rev.2 (Mar 2004)**

See separate TB document in Annex 2.

Annex 3. **TB for Rev.3 (Nov 2012)**

See separate TB document in Annex 3.

Annex 4. **TB for Rev.4 (Jan 2016)**

See separate TB document in Annex 4.

Annex 5. **TB for Rev.5 (Apr 2021)**

See separate TB document in Annex 5.



**Note:** *There are no separate Technical Background (TB) documents for the original resolution (1991), Corr.1 (May 1998) and Corr.1 (April 2002).*

TB submitted on 6 Feb 2001 by AHG/PPV Chairman

## **P 3 (Rev.1)**

### **Technical Background Documents**

#### **1. Review of UR P1 – P3**

- Objective and Scope

Review of UR P1.2, P2.1, P2.2, P2.3, P2.5, and P3 has been carried out in line with annual Task 1A. The main goal of this review was elimination of a Member's reservation. As has been noted by the Member: "P1 & P2 have not been implemented since the Rules are formatted around US standards such as ANSI, ASME, USC Regulations, etc. P 1 & P2 are not conducive (sic) to incorporate in the Rules". With regard **to P3**, it needed to be changed editorially.

Member's additional comments relative to the UR P:

#### P 1.2.7:

- Do not regard 14 bar as design pressure, otherwise, strainers, filters, heaters will have to be designed for 14 bar which may not be practicable. Also the testing pressure for these components will need to 1.5 the design pressure which may be a contentious issue. Accordingly the Member proposed that the 14 bar pressure should be considered as a special safeguard for the joints (see MSC Circ 647 & 851).
- Working Group needed to discuss and determine whether the 14 bar pressure was applicable to valves also. Further, the Member has been informed by their office in the Pacific that pressure rating of JIS f 7399-1989 "Marine Fuel oil Tank Emergency Shut-off valves", commonly used in that region, states that "Maximum working pressure shall be 0.098 MPa [ 1kg/cm<sup>2</sup> ], although hydraulic inspection for body will be 0.686 MPa. Accordingly, it would not be possible to apply the 14 bar pressure to the suction side of the pump.

#### P 2.2 Table (1):

- There was a need to define what constitutes "special safeguard". A Member's observation of other Member societies Rules indicated that there were no provisions made for application of this in the design, construction or operational matters.
- Member requested the WG to develop a list of provisions which may be considered "special safeguards" for various systems conveying flammable, toxic or corrosive media.
- The reference to toxic and corrosive fluids may be out of place, as such systems were invariably cargo systems, which were outside the scope of P2. Accordingly considerations should be given to deleting this.

- Source of Proposed Requirements

A Member's proposals on correction the UR P1, P2 and **P3** circulated by e- mail dated 13 September 2000 has been used as a basis document for revision.

- Points of discussion

**Unanimous agreement has been achieved.**

## **Technical Background document for the revision of UR P3**

### **1. Scope and Objective**

The review by AHG/FDF of BEA/mer technical report on air vent arrangements recommended to amend the UR P3.

### **2. Points of discussion**

All recommendations arising from AHG/FDF review were accepted by the WP and introduced into the draft revision.

### **3. Source/derivation of proposed amendments**

AHG/FDF Report to GPG as attached.

### **4. Decision**

The draft was agreed by consensus. No Member requested any issue to be reflected in the TB.

KP 12/02/04

### **5. GPG**

Approved by GPG 4 March 2004, 3003cIGb, as submitted.

## IACS AHG/FDF

Report dated 27<sup>th</sup> May 2002 to IACS on:

### **Task 03: Review of the BEA/mer technical report on air vent arrangements**

#### **1. IACS Directive**

Following discussion on the FRAMO system installed on the IEVOLI SUN, GPG decided to task AHG/FDF to review the recommendations contained in the BEA/mer technical report on air vent arrangements and advise GPG. (0233\_Igc, 29 August 2001). No Form A.

#### **2. The BEA/mer Recommendations**

A free translation of the recommendations contained within the BEA/mer report "Technical note on vent arrangements in ballast tanks and other spaces", dated 7 may 2001 is as follows.

- ∞ IACS and classification societies should circulate a technical note about the problems identified on automatic vent arrangements, installation precautions, frequency of inspections, maintenance and replacement of elements subject to deterioration.
- ∞ Include the inspection of vent arrangements in the technical specification of the shipowner for repair works during ship stops.
- ∞ Frequency of inspections.  
Follow instructions assigned by manufacturers (it is recommended to make an inspection every two years and a complete replacement of the vent arrangement between 8 to 10 years).
- ∞ For new ships, take into account a better protection of the vent arrangements against green seas at the time of their installation on board.
- ∞ Improve the means of protection against corrosion (treatment, coating) and ensure proper preparation of sampling.
- ∞ Improve the seal between the vent arrangement and seat (appropriate floating ball / joint coupling) and smooth the seating arrangements of the ball.
- ∞ Improve the design to facilitate inspection and maintenance of the parts mostly exposed to corrosion (the connecting pipe inside of the casing and the air vent pipe, which should be as short as possible).

It seems that some manufacturers have already taken into account some modifications.

#### **3. Review of the BEA/mer recommendations**

The seven recommendations listed above have been considered by AHG/FDF and are commented as below:

- i) The first recommendation calls for IACS to circulate a technical note describing problems identified with automatic air pipe heads, installation, inspection and maintenance. Members of AHG/FDF reported that many



types of problems had been found on survey, but that the most prevalent were those due to corrosion and/or lack of maintenance. Air pipe heads constructed from galvanised steel were considered to be more prone to problems caused by corrosion. It was therefore concluded that the most effective approach to combat these problems was through a defined survey regime. A draft UR Z[ ] for automatic air pipe heads is in development.

- ii) Include the inspection of vent arrangements in the technical specification of the ship owner for repair works during ship stops.  
This is interpreted to refer to the owners/managers repair specification for docking/dry docking. Deficiencies should be identified and reported, ISM paragraph 5.1.5 refers.
- iii) Frequency of inspections.  
AHG/FDF agreed that annual external inspections should continue as at present. In addition the draft UR Z[ ] is proposing requirements for the dismantling and survey of air pipe heads at each Special (Renewal) Survey. This is to provide for the internal inspection of air pipe heads, which for some types requires its removal from the air pipe.
- iv) Better protection against green seas.  
Members considered those proposals for strength requirements under Task 01 if extended to the remainder of the ship length could address this item.
- v) Improve the means of protection against corrosion.  
The meaning of 'ensure proper preparation for sampling' is not clear, but is interpreted as a reference to the quality control for the corrosion protection (e.g. galvanising).

As for the mechanism that may have caused the particular type of corrosion found in the air pipe head from the Ievoli Sun, AHG/FDF postulated the following.

During the ballasting of tanks, it is common practice to press the tanks up by filling until water is flowing through the air pipe heads onto the deck. This means that quite a high velocity of water is impacting on the lower part of the inner chamber for some types of head. As ballast is usually taken on in fairly shallow water it is quite likely to contain some sediment. The action of water containing particles of sand, earth, etc will then tend to erode the zinc coating particularly over the area where the flow up the pipe is diverted around the outer chamber. This is the area where heavy corrosion was found on the recovered air pipe head from the Ievoli Sun. Once the thin coating has worn through, the steel is locally exposed and corrosion commences.

AHG/FDF also found from results of surveys that corrosion can occur beneath the ball where this is normally resting on a galvanised steel surface. This may also be attributed to erosion. It is therefore recommended that a resting bar or bars or other device be introduced such as to prevent the ball from touching the inner chamber in its normal position.

AHG/FDF considered that zinc coating should be deposited on the air pipe head by the hot method, and should have a thickness of 70 - 100 microns.

For heads constructed from cast iron, a suitable epoxy or equivalent coating should be applied. For both types it was considered that a harder coating should be used in areas which could be susceptible to erosion when ballast water is pumped through.

AHG/FDF further considered that a minimum thickness of 6 mm should be specified for the inner and outer chambers of an automatic air pipe head.

- vi) Improve the seal between the vent arrangement and seat.  
Members considered UR P3.2.3 and P3.2.7 covered this.
- vii) Improve the design to facilitate inspection and maintenance.  
Members considered UR P3.2.2 covered this.

#### 4. **Recommendations for consideration into UR P3**

AHG/FDF suggest that consideration be given to the following items for possible inclusion into UR P3:

- i) provision of bars or cage or other device for preventing the ball or float from contacting the inner chamber in its normal state,
- ii) for galvanised steel air pipe heads, the zinc coating to be applied by the hot method, and the thickness to be 70 to 100 microns.
- iii) for areas of the head susceptible to erosion (e.g. those parts directly subjected to ballast water impact when the tank is being pressed up, for example the inner chamber area above the air pipe, plus an overlap of 10° or more either side) an additional harder coating should be applied. This may be an aluminium bearing epoxy, or other equivalent, coating, applied over the zinc, and
- iv) a minimum thickness of 6 mm for the inner and outer chambers of an automatic air pipe head.

## Technical Background for UR P3 Rev.3, Nov 2012

### 1. Scope and objectives

To clarify the type-test method of P3 for tightness test and to evaluate tests to prove the ability to handle vacuum and criteria for the relationship area requirement and flow characteristics.

### 2. Engineering background for technical basis and rationale

- 2.1 With respect to the type tests of air pipe closing devices, the tightness tests for such devices, in principle, should be performed under strict conditions such as having the opening facing upward, etc. based upon design requirements. Since the UR does not clarify any test method regarding the above, certain classification societies only require type test examinations to be carried out at an inclination of 40 degrees in a single fixed direction. However, performing the required testing for the device under such less restrictive conditions might influence the test outcome in a negative way.

Therefore, in order to carry out unified type tests for such devices under strict conditions, new specific type test conditions based upon the direction in which the opening of the device faces are needed as shown in Figure 1 to 4.

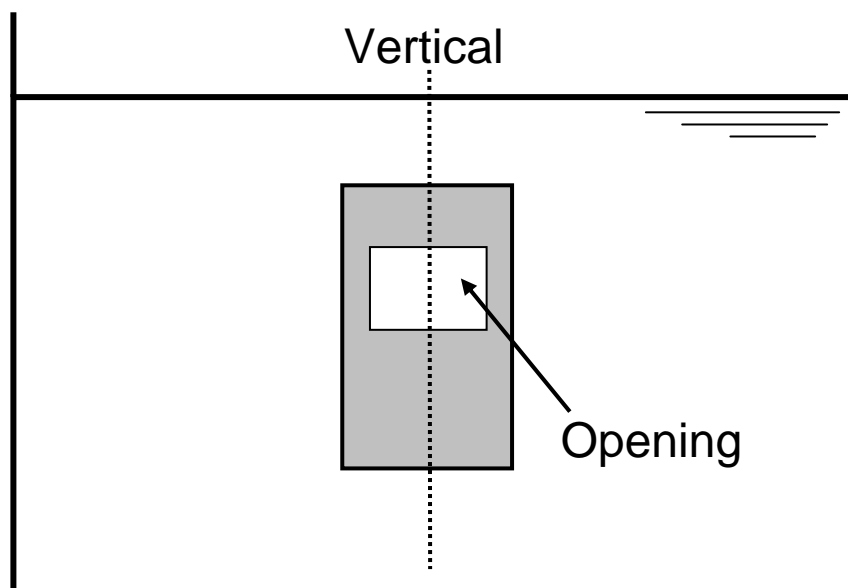
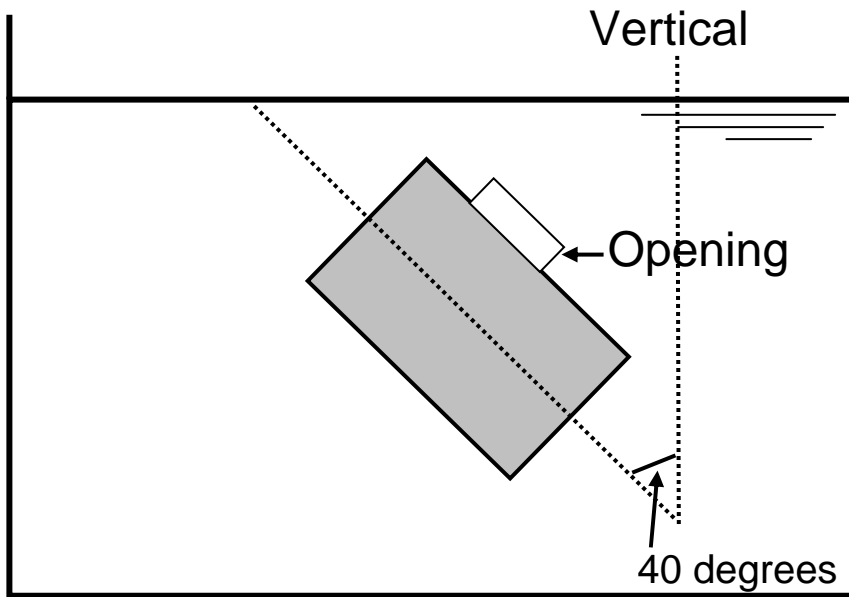
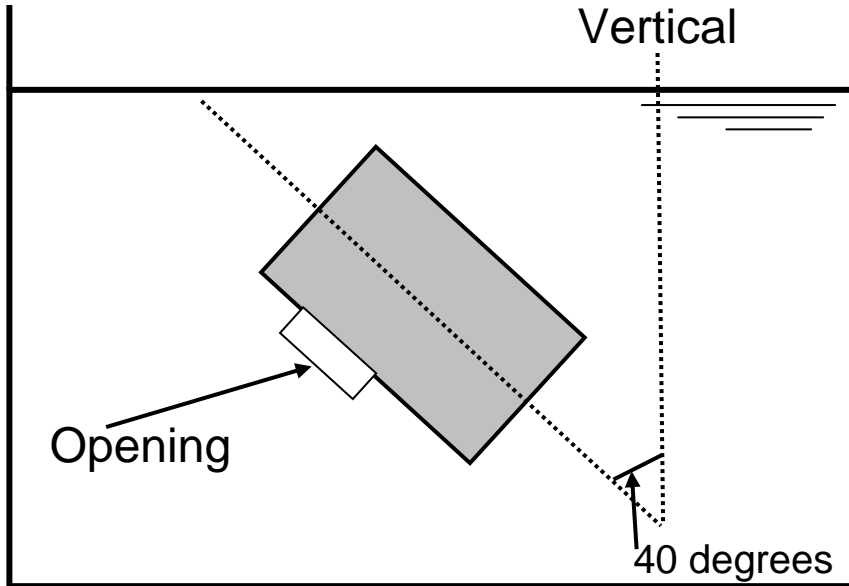


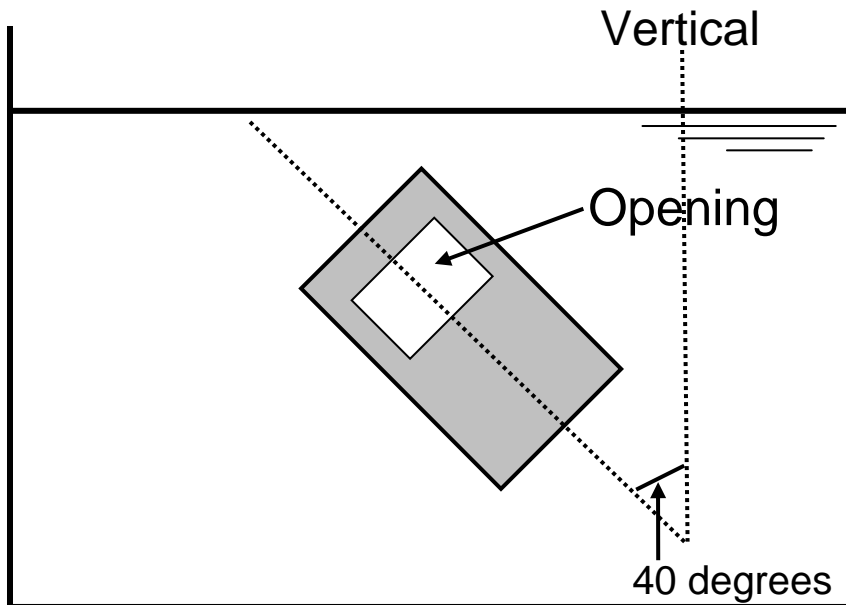
Fig 1: Normal position



**Fig 2: Inclination 40 degrees opening facing upward**



**Fig 3: Inclination 40 degrees opening facing downward**



**Fig 4: Inclination 40 degrees opening facing sideways**

2.2 A problem exists in which the float of an air pipe closing device is sucked into the opening by the negative pressure in the tank. As a result, the float is blocking the flow of air resulting from the typical emptying of tanks and may become damaged under these conditions.

Therefore, a new test item related to reverse flow is needed.

These are reflected in the revision of P3.

### **3. Source/derivation of the proposed IACS Resolution**

None

### **4. Summary of Changes intended for the revised Resolution:**

The original requirement in UR P3 is to be amended by revising the original paragraph P3.4.1 b) iii) and adding a new paragraph P3.4.1 c) as follows:

Discharge / Reverse flow test is added

The air pipe shall allow the passage of air to prevent excessive vacuum developing in to the tank. A reverse flow test shall be performed. A vacuum pump or another suitable device shall be connected to the opening of the air pipe leading to the tank. The flow velocity shall be applied gradually at a constant rate until the float gets sucked into the inlet of the air pipe and blocks the flow. The velocity at the point of blocking shall be recorded. 80% of the value recorded will be stated in the certificate.

### **5. Points of discussions or possible discussions**

All of the proposals were agreed to unanimously except for deleting P3.2.5, where several members argued that this general criterion which has been working well should be kept in order not to carry out the flow characteristic evaluation on each air pipe.

One member argued that as P3.2.5 does not take into consideration the effect of grids and the inner geometry of the vent head it was proposed to delete P3.2.5 and include the following under P3.5. Product documentation:

“Every vent head shall be delivered with the flow characteristic curve recorded during Type Testing (ref P3.4.1.a)”.

However, this was not supported by the majority of the members.

**6. Attachments if any**

None

## **Technical Background (TB) document for UR P3 (Rev.4 Jan 2016)**

### **1. Scope and objectives**

This revision of UR P3 is done to clarify the definition of the term "chambers" in UR P3.2.9 for its uniform application as per the agreed IACS common understanding, more specifically whether the side covers of air pipe head is also part of chamber to be of minimum thickness of 6 mm.

### **2. Engineering background for technical basis and rationale**

Keeping in mind that the understanding of "chambers" proposed by an IACS Member has received strong support from the Statutory Panel Member, it was decided to develop an IACS common understanding to clarify UR P3.2.9 based on Member's practical experience on application of UR P3.

The requirement in UR P3.2.9 "The inner and the outer chambers of an automatic air pipe head is to be of a minimum thickness of 6 mm" is provided to take into account any erosion caused by high velocity ballast water containing sediment flowing through the inner and outer chambers of automatic air pipe heads.

As per LL Convention Reg. 20(1), the point where water may have access below shall be at least 760 mm on the freeboard deck and 450 mm on the superstructure deck.

The part of air pipe below this point shall be of substantial construction.

Therefore, as far as the mentioned covers are below the point where water may have access below and their function is integral to providing functions of the closing device, they shall be of substantial construction.

For this reason, there is a fear of such erosion occurring to side covers.

Furthermore, if the side cover is dented by a mechanical damage or wave, it may have a bad effect on the performance of an air pipe due to the reduction of total flow area; accordingly, it seems necessary that the side cover should be as strong as the housing and the minimum wall thickness of 6 mm should apply.

Therefore, in order to improve overall robustness of the air pipe head, if its function is integral to providing functions of the closing device, the side cover is considered as a part of chambers where the minimum wall thickness shall be not less than 6 mm.

This is reflected in the revision of P3.2.9.

### **3. Source/derivation of the proposed IACS Resolution**

None.

### **4. Summary of Changes intended for the revised Resolution:**

The original requirement in UR P3 is to be amended by revising the original paragraph P3.2.9 as follows:

P3.2.9 The inner and the outer chambers of an automatic air pipe head is to be of a minimum thickness of 6 mm. Where side covers are provided and their function is

integral to providing functions of the closing device as outlined in P3.2.6, they shall have a minimum wall thickness of 6 mm.

**5. Points of discussions or possible discussions**

None.

**6. Attachments if any**

None.



## Technical Background (TB) document for UR P3 (Rev.5 Apr 2021)

### 1. Scope and objectives

This revision of UR P3 is done to include CFD as an alternative method to carry out reverse flow test for very high flow velocity depending on the geometry of the valve as per the agreed IACS member society.

### 2. Engineering background for technical basis and rationale

As a feedback from industry in some cases reverse flow test at high speed are very difficult to conduct due the requirement of high capacity pumps. In accordance to this an alternative means utilizing CFD simulation to carry out reverse flow test is proposed.

In general, it is noted that in case of inability to carry reverse flow test for bigger size valves, the highest velocity observed during the actual test is noted for certification. Thus, a reasonably bigger size of 400mm and above is decided for the purpose of CFD simulation.

Following is to be adopted for such CFD simulations –

1. Any CFD solver of user choice is acceptable.
2. The flow velocity at which the float of the valve rises up and blocks the outflow is to be noted as the threshold velocity.
3. Mesh convergence is an essential step to be undertaken.
4. The mesh convergence studies with at least two mesh sizes are suggested to be carried out. The convergence to be checked for parameters like the pressure (or force) on float of the valve. The initial base mesh size can be equal to (nominal diameter of pipe/100) as a maximum. Further, this mesh can be refined keeping the mesh refinement ratio of  $\geq 1.3$ . The results can be accepted if the difference in the converged values of the considered mesh sizes are less than or equal to  $\sim 5\%$  (as a generalized CFD practice).
5. The result found (threshold velocity) can be compared with available experimental results of same size and type of valve for validation.
6. Post validation of the model developed for the simulation this methodology can be applied for higher size & type of valves and the obtained results can be accepted.

### 3. Source/derivation of the proposed IACS Resolution

Request from a member society

### 4. Summary of Changes intended for the revised Resolution:

1. The first paragraph of P3.4.1.c is divided into P3.4.1.c.i and P3.4.1.c. ii. Text of Rev 4 is retained in P3.4.1. c.i. New text is proposed in P3.4.1.c. ii to include the

proposal for CFD inclusion for reverse flow test. It defines the applicability of the numerical test as well as the validation technique to be undertaken for the test. The need for mesh convergence study for the accuracy of the simulation are also defined in the modification.

2. The second paragraph of P3.4.1.c is shifted to the end of P3.4.1.b

#### **5. Points of discussions or possible discussions**

The UR was reviewed and discussed within IACS Machinery Panel via email correspondence. Having not been able to find the technically valid rationale to delete Requirement 3.2.5, it was agreed that this Requirement should be retained in this revision and that Machinery Panel should continue the review of this Requirement in 2021.

At the stage of finalizing Rev.5, Machinery Panel confirmed that the intention of the existing requirement related to the limitation of the max. flow to 80% of the tested flow (to be recorded in the certificate) was to provide a safety margin and therefore decided that this should be applied in the case of numerical simulation testing based on computational fluid dynamics (CFD).

#### **6. Attachments if any**

None

## UR P4 “Production and Application of Plastic Piping Systems on Ships”

### Summary

In Rev.7 of this Resolution, clear specification of the specimen size and number to be used in fire endurance testing on flange connections in plastic piping systems were included.

### Part A. Revision History

Version no.	Approval date	Implementation date when applicable
Rev.7 (June 2022)	14 June 2022	1 July 2023
Rev.6 (Feb 2021)	15 February 2021	1 July 2022
Rev.5 (Dec 2018)	17 Dec. 2018	1 January 2020
Rev.4 (Dec 2008)	Dec. 2008	1 January 2010
Rev.3 (Feb 2005)	Feb. 2005	1 January 2007
Rev.2 (July 1999)	July 1999	Unknown
Rev.1 (May 1998)	May 1998	Unknown
Corr.1 (1997)	1997	Unknown
New (1996)	1996	Unknown

#### • Rev.7 (June 2022)

##### 1 Origin of Change:

- Suggestion by IACS member

##### 2 Main Reason for Change:

To provide for clear specification of the specimen size and number to be used in fire endurance testing on flange connections in plastic piping systems relating to IMO Res. A.753(18).

To take this opportunity, references to IMO instruments have been slightly modified, taking into account the latest Format according to IACS Procedures Volume 1 (Rev.16).

##### 3 List of non-IACS Member classification societies contributing or participating in IACS Working Group:

None

##### 4 History of Decisions Made:

None

## 5 Other Resolutions Changes:

None

## 6 Any hinderance to MASS, including any other new technologies:

None

## 7 Dates:

Original Proposal : 01 October 2021 (Ref: PM20303aIMb)  
Panel Approval : 13 May 2022 (Ref: PM20303aIMk)  
GPG Approval : 14 June 2022 (Ref: 22080\_IGb)

### • Rev.6 (Feb 2021)

#### 1 Origin of Change:

- Other (Update to comply with the required format when industry standards are referred to)

#### 2 Main Reason for Change:

There was a need to update this UR to comply with the following format when industry standards are referred to:

*[Standard Designation], [version/revision, if applicable], [year of publication] (examples: API Spec 2F, 6th Edition, 1997; ISO 4624, 2002), where [version/revision, if applicable] and/or [year of publication] are decided by IACS and are not necessarily to be the current/latest version.*

To take this opportunity, references to IMO instruments have been specified in the following format based upon confirmation of amendments up to the latest one:

*In case where the number of amendments is large:*

*regulation/paragraph x.x.x of SOLAS Chapter X/MARPOL Annex X/the XXX Code, as amended by IMO resolutions up to MSC.xx(xx)/MEPC.xx(xx)*

*In case where the number of amendments is small:*

*regulation/paragraph x.x.x of SOLAS/MARPOL/the XXX Code, as amended by resolutions MSC/MEPC.xx(xx), (...) and MSC/MEPC.xx(xx)*

#### 3 List of non-IACS Member classification societies contributing or participating in IACS Working Group:

None

#### 4 History of Decisions Made:

None

**5 Other Resolutions Changes:**

None

**6 Any hinderance to MASS, including any other new technologies:**

None

**7 Dates:**

Original Proposal : 28 October 2019 (Ref: PM18939\_IMd)  
Panel Approval : 09 November 2020 (Ref: PM20906\_IMf)  
GPG Approval : 15 February 2021 (Ref: 20206bIGb)

**• Rev.5 (Dec. 2018)**

**.1 Origin for Change:**

- Query by the industry on collapse pressure and Suggestion by IACS member

**.2 Main Reason for Change:**

To align UR P4 with IMO Res. A.753(18) as amended by Res. MSC.313(88) and MSC.399(95) and consider the extent of application of the collapse pressure requirements based on a query submitted by a pipe maker. Consideration for inclusion of urea supply system and Exhaust Gas Cleaning System effluent line in the pertinent Fire Endurance matrix.

**.3 List of non-IACS Member Classification Societies contributing through the TC Forum and/or participating in IACS Working Group:**

None

**.4 History of Decisions Made:**

None

**.5 Other Resolutions Changes**

None

**.6 Dates:**

Original proposal : 12 May 2016 (Form A for PM15907)  
Panel approval : 21 November 2018 (Ref: PM15907aIMq)  
GPG approval : 17 December 2018 (Ref:16035aIGb)

- **Rev.4 (Dec 2008)**

Refer to the TB document in Annex 3. No history file available.

- **Rev.3 (Feb 2005)**

Refer to the TB document in Annex 2. No history file available.

- **Rev.2 (July 1999)**

Refer to the TB document in Annex 1. No history file available.

- **Rev.1 (May 1998)**

No history file or TB document available.

- **Corr.1 (1997)**

No history file or TB document available.

- **New (1996)**

No history file or TB document available.

\*\*\*\*\*

## **Part B. Technical Background**

List of Technical Background (TB) documents for UR P4:

Annex 1. **TB for Rev.2 (July 1999)**

See separate TB document in Annex 1.

Annex 2. **TB for Rev.3 (Feb 2005)**

See separate TB document in Annex 2.

Annex 3. **TB for Rev.4 (Dec 2008)**

See separate TB document in Annex 3.

Annex 4. **TB for Rev.5 (Dec 2018)**

See separate TB document in Annex 4.

Annex 5. **TB for Rev.6 (Feb 2021)**

See separate TB document in Annex 5.

Annex 6. **TB for Rev.7 (June 2022)**

See separate TB document in Annex 6.

**Note:** *There are no Technical Background (TB) documents available for New (1996), Corr.1 (1997) and Rev.1 (May 1998).*

## **Technical Background (TB) document for UR P4 (Rev.2 July 1999)**

### **P4.3.3 Impact Resistance**

#### Objective and Scope

- Review of UR P4.3.3 has been carried out in view of the test method stipulated by ASTM D2444 - 93 is not applicable in Classification Society practice.

#### Source of Proposed Requirements

- IMO Res. A 753 (18) "Guidelines for the application of plastic pipes on ships".
- ASTM D2444 - 93 "Standard test method for determination of the impact resistance of thermoplastic pipe and fittings by means of a tup (falling weight)".
- ASTM F 1173 - 95 "Standard specification for thermosetting resin fibreglass pipe and fittings to be used for marine application".

A unanimous agreement has been achieved.

Date of submission: 13 May 1999  
By AHG/PPV Chairman



## **Technical Background (TB) document for UR P4 (Rev.3 Feb 2005)**

### **1. Technical background for revision of P4.1, 4.2 and 4.5**

In conjunction with the approval of polyethylene (PE), polypropylene (PP) and polybutylene (PB) plastic pipes it was realized that there appears to be a discrepancy between the requirements in UR P4.3.4 and common industrial practice.

These types plastic pipes are well established and have been widely used for many years, for service temperatures up to 80°C, in potable, sanitary and water heating systems in shore and marine applications. Many of the Member Societies have issued type approvals for these pipe types and services.

However, by the nature of PE, PP and PB materials these pipe types cannot comply with the requirements of UR P4.3.4. Actually, the heat distortion temperatures (HDT) of such pipe materials, as determined by ISO 75 A or equivalent, and specified in UR P4.3.4, would be much less than 80°C. Plastic pipe manufacturers commonly claim that the raw materials' heat distortion temperatures according to these standards are usually not even determined since they are not considered relevant in order to justify plastic pipes' long-term hydrostatic strength under relevant service temperatures. These HDT values would, at best, be indicative of plastic materials' short-term behaviour related to stiffness and relevant plastic pipe standards, as DIN 8077/ 8078, do not even refer to HDT.

Rather, the methods commonly used in this regard are specified in industry established, dedicated standards, as predominately ISO 9080 (Determination of long-term hydrostatic strength of thermoplastic materials in pipe form by extrapolation) or ISO 15874 (Plastic piping systems for hot and cold water installations, PP). Results of long term endurance tests, usually carried out in accordance with these standards, show that PE, PP or PB type plastic pipes could last for more than twenty years under specified pressure and temperature loads, while under the current UR P4.3.4 they would not even be acceptable.

### **2. Technical background for new UR P4.7 (Test Specification For Plastic Pipes)**

#### **1. Scope and objective**

Development of Unified Requirements / Recommendation and Type Test Procedure for Plastic Pipes has been initiated by LR and supported by IXX AHG/PPV Meeting and GPG. The main goal of development was to unified test requirements and testing procedures of plastic pipes.

#### **2. Points of discussion or possible discussion**

Relevant provisions of IMO Res. A753(18), national and international standards have been discussed.

### **3. Source/derivation of proposed requirements**

- .1 IMO Res. A 753(18) Guidelines for the application of plastic pipes on ships.
- .2 ISO 15493:2003 Plastic piping systems for industrial applications.
  
- .3 ISO 75: 2004 Plastics. Determination of temperature of deflection under load.
- .4 ISO 2507: 1995 Thermoplastic pipes and fittings. Vicat softening temperature.
- .5 ISO 8361:1991 Thermoplastic pipes and fittings. Water absorption.
- .6 ISO 9142:1991 Adhesives. Guide to the selection of the standard laboratory ageing conditions for testing bonded joints.
  
- .7 ISO 9653:1998 Adhesives. Test method for shear impact strength of adhesive.
  
- .8 ISO 9854: 1994 Thermoplastic pipes for the transport of fluids. Determination of pendulum impact strength by the Charpy method.
  
- .9 ASTM C 581-03 Standard practice for determination chemical resistance of thermosetting resins used in glass fiber reinforced structures intended for liquid service
  
- .10 ASTM D 257-99 Standard test method for DC resistance of conductance of insulating materials
  
- .11 ASTM D 1599-99 Standard test method for resistance to short time hydraulic pressure of plastic pipe, tubings and fittings.
  
- .12 ASTM D 2412-02 Standard test method for determination of external loading characteristics of plastic pipe by parallel plate loading
  
- .13 ASTM D 2444-99 Standard test method for determination of impact resistance of thermosetting pipe and fittings by means of a tup (falling weight)
  
- .14 ASTM D 2992-01 Standard practice hydrostatic or pressure design basis for fiberglass (glass fiber reinforced thermosetting resin) pipe and fittings
  
- .15 ASTM F 1173-95 Thermosetting resin fiberglass pipe and fittings to be used for marine application

*Note: Refer to REC 86.*

Notes by the Permanent Secretariat

## **Implementation Date**

### **1.1 P4.2.3**

Members agreed: The changes in P4.2.3 are being made to correct a problem, so Members will want to effect changes to their rules/procedures in line with P4.2.3 as quickly as possible. Therefore, a uniform application date is not needed.

### **1.2 P4.7**

ABS proposed: P4.7 is new and should have a uniform application date agreed by Members so as to obviate problems were Members to try to start implementing P4.7 at different times and run into resistance. Therefore, we propose that the requirements of UR P4.7 be uniformly implemented by IACS Societies from 1 Jan 2007.

However, One Member disagreed and advised that:

It should not be compulsory for existing type approved plastic pipes to be re-evaluated in accordance with P4 (Rev.3) not later than 1 Jan 2007. Member has already issued the type approval certificates for existing plastic pipes with 5 year validity (4069nNKb, 18/02/2005).

Finally, Members agreed to the following statement:

*"The requirements of UR P4.7 are to be uniformly implemented by all IACS Societies to any new plastic pipe submitted for approval from 1 January 2007 and to any existing plastic pipe from the date of the first renewal of approval after 1 January 2007.*

\* \* \*

Submitted by WP/MCH Chairman  
20/12/2004

## Technical Background (TB) document for UR P4 (Rev.4 Dec 2008)

### Machinery Panel Task PM7302 - Revision of UR P4.5.4

1. Clause P4.3 of the UR P4 Rev.3 (February 2005), stipulates as follows:  
 "The specification of piping is to be in accordance with a recognised national or international standard acceptable to Classification Society. In addition, the following requirements apply:"

P4.3 then lists "additional requirements". These additional requirements are related to the application of pipes, rather than the manufacturing process of pipes itself. Therefore these additional requirements may not contradict that of selected national or international standards to which the pipes are manufactured.

2. Whereas P4.5.4 stipulates as follows:

"P4.5 Material approval and Quality Control During Manufacture

.4 Each pipe and fitting is to be tested by the manufacturer at a hydrostatic pressure not less than 1.5 times the normal pressure."

Contrary to the requirements of the P4.3, in many cases, the requirement of P4.5.4 (i.e., 100% hydrostatic pressure test at 1.5 times the rated pressure as a routine test) is not consistent with the selected national or international standard to which pipes are manufactured. The hydrostatic pressure test requirement of P4.5.4 is thought to be over and above the industry standards. However, the rationale for such an additional requirement is not apparent.

The following table shows the requirements of hydrostatic pressure test during manufacturing stipulated in five industry standards that the present study cited.

Standard	Manufacturing process	Test Requirements
ASTM D 1785 Standard specification for Poly(Vinyl Chloride) (PVC) Plastic Pipe, Schedule 40, 80 and 120	Continuously-extruded pipe	1. Prototype test: Sustained pressure test at 2.1 times the pipe pressure rating for 1000 hours, and Burst pressure test: 3.2 times the pipe pressure rating.  2. No routine hydrostatic pressure test requirement during production.
ASTM F 441/F 441M Standard specification for Chlorinated Poly(Vinyl Chloride) (CPVC) Plastic Pipe, Schedule 40 and 80	Continuously - extruded pipe	1. Prototype test: Sustained pressure test at 2.1 times the pipe pressure rating for 1000 hours, and Burst pressure test: 3.2 times the pipe pressure rating.  2. No routine hydrostatic pressure test requirement during production.

<b>Standard</b>	<b>Manufacturing process</b>	<b>Test Requirements</b>
ASTM F 1412 Standard specification for Polyolefin Pipe and Fittings for Corrosive Waste Drainage Systems	Continuously-extruded pipe	1. As prototype test, randomly selected fused joints are to be tested to 50 psi for 5 minutes. No pressure test requirements for pipe itself.  2. No routine hydrostatic pressure test requirement during production.
ASTM F 1173 Standard specification for thermosetting Resin Fiberglass Pipe Systems to Be Used for Marine Applications	Filament wound and centrifugally cast	1. Burst test, one sample per 150 joints during production.  2. 5% of pipe joints to be tested to 1.5 times the rated pressure during production.
API 15LR Specification for Low Pressure Fiberglass Line Pipe and Fittings	Filament wound and centrifugally cast	1. As prototype test, long-term cyclic hydrostatic pressure test.  2. One sample per lot (5,000 feet) to be tested to 1.5 times the rated pressure during production.

While routine pressure testing is imposed on produced FRP pipes on a sampling basis, no routine pressure test is required for PVC or CPVC pipes.

3. The level of quality assurance and quality control in production is as follows. Typically, pipes and fittings are made automatically by computerized processes, including optical measurements on line and automatic rejection of products out of tolerance. Furthermore scheduled spot checks and additional mechanical tests are made manually several times per shift to control the process itself. Typically these pipes and fittings are designed for at least a short term hydrostatic failure pressure at 4 times the MAWP, and a long term hydrostatic failure pressure at 2.5 times the MAWP.

It should be noted that the production processes based on continuous extrusion (as in PVC and CPVC pipes) and those based on centrifugal casting with wound filament (as in FRP pipe) are very different. It is thought that the difference in the testing requirements for these two manufacturing processes is simply reflecting the fact that the chance of quality failure of continuously extruded PVC or CPVC pipes is remote, and also the fact that the 100% hydrostatic test on every produced pipe, even FRP pipes, may not be warranted.

From the historically satisfactory testing results that are reported, it seems that 100% hydrostatic pressure testing at the factory on every pipe produced is not necessary.

4. Note that IMO Resolution A.753(18) "Guidelines for the application of plastic pipes on Ships" has a similar requirement to that currently in IACS UR P4. Clause 3.5 of this resolution however reads as follows:

"Each length of pipe should be tested at the manufacturer's production facility to a hydrostatic pressure not less than 1.5 times the rated pressure of the pipe. Other test criteria may be accepted by the Administration."

It seems that the last sentence "Other test criteria may be accepted by the Administration" is echoing the view expressed in 2 and 3 above.

5. In conclusion, IACS Members have agreed that when plastic pipes are designed and manufactured to recognized industry standards acceptable to the Society, the requirement of 100% hydrostatic test for every produced pipe as per the UR P4.5.4 may not be necessary, accordingly the following wording has been added at the end of the clause P4.5.4:

"Alternatively, for pipes and fittings not employing hand lay up techniques, the hydrostatic pressure test may be carried out in accordance with the hydrostatic testing requirements stipulated in the recognized national or international standard to which the pipe or fittings are manufactured, provided that there is an effective quality system in place."<sup>41</sup>

Submitted by Machinery Panel Chairman  
1 December 2008

**Permanent Secretariat note (January 2009):**

Rev.4 of UR P4 was approved by GPG on 22 December 2008 with an implementation date of 1 January 2010 (ref. 7761\_IGc).

## **Technical Background (TB) document for UR P4 (Rev.5 Dec 2018)**

### **1. Scope and objectives**

Task PM15907a was initiated in continuation to PM15907 (pertaining to a query from a plastic pipe manufacturer on collapse pressure of P4.3.1.4, Rev.4) considering the IMO amendments to Res. A.753(18) together with member suggestions for clarifications of ambiguously worded text and addition of exhaust emission abatement piping systems in the fire endurance matrix.

### **2. Engineering background for technical basis and rationale**

- a. The previous editions of the UR were based on sections of the IMO Guidelines for the application of plastic pipes on ships (Res. A.753(18)). IMO amended Res.A.753(18) by Res. MSC.313(88) to introduce two (2) additional fire endurance test levels (L1W and L2W), and by Res. MSC.399(95) to take into account technological developments and the 2010 FTP Code requirements. Therefore a revision of the UR was needed so that the UR does not lag behind the IMO publications.
- b. The Panel received a query by a plastic pipe manufacturer about the extent of application of the requirements in UR P4.3.1.4, Rev.4 (Machinery Panel Task no. PM15907). It appears that the aforementioned paragraph of the UR can be read as a standalone requirement, while IMO Res.A.753(18), as amended, considers collapse test pressure only under "External pressure" (2.1.3 of the Annex to the Resolution), specifying in 2.1.3.1 that external pressure should be taken into account in the design of piping for any installation "which may be subject to vacuum conditions inside the pipe or a head of liquid acting on the outside of the pipe". In addition, clause 2.1.3.2 of the Resolution ("Piping should be designed for a nominal external pressure"... ) could be interpreted as "applicable to all piping systems" (according to the title of Article 2.1) and not only to those piping systems actually subjected to an external pressure.
- c. Some parts of the UR appeared to be ambiguously worded, as for example P4.2.3 for plastic pipes of thermoplastic materials such as PE, PP, PB, and intended for non-essential services.
- d. Technological developments in exhaust emission abatement systems allow the use of plastic pipes, accordingly the fire endurance matrix should also consider urea supply or exhaust gas cleaning effluent pipelines in connection with their location/routing.

### **3. Source/derivation of the proposed IACS Resolution**

The text of the UR is derived from the background given in 2 above.

#### 4. Summary of Changes intended for the revised Resolution:

UR P4 Rev.5	Revisions
Title	"Plastic Pipes" has been replaced by "Plastic Piping Systems".
P4.1.1	Paragraph has been revised per item 2 of the Annex to IMO Res. MSC.313(88).
P4.1.3	Definition of "joint" has been further clarified.
P4.2.1 & P4.2.2	Paragraphs have been revised per item 1 of the Annex to IMO Res. MSC.313(88).
P4.2.3	The applicable sections for pipes intended for non-essential systems have been clarified. The reference to thermoplastic materials PE, PP and PB has been removed.
Footnote (asterisk)	Reference to IMO Res. MSC.313(88) and MSC.399(95) has been added.
P4.3.1.3	Clarification for external pressure has been added. Previous paragraphs 4 and 5 have been incorporated in the section for external pressure.
P4.3.1.4 (new numbering)	New paragraph on wall thickness has been added.
P4.3.1.5 (new numbering)	Previous paragraph number P4.3.1.6 has been renumbered.
P4.3.4.1 & P4.3.4.2	"Distortion" reads now "Distortion/deflection"; ASTM D648 has been added as equivalent to ISO 75 method A.
P4.4.1.1, P4.4.1.2(i), P4.4.1.2(ii)	Reference to IMO Res. MSC.313(88) and MSC.399(95) has been added.
P4.4.1.2(i)	Paragraph has been revised per item 3 of the Annex to IMO Res. MSC.313(88).
P4.4.1.2(ii)	Paragraph has been revised per item 4 of the Annex to IMO Res. MSC.313(88).
P4.4.1.4	New paragraph on safe return to port has been added.
Table 1 Fire Endurance Requirements Matrix	<ul style="list-style-type: none"> <li>- L1 has been replaced by L1W in rows 14, 15 and 23 per item 8 of the Annex to IMO Res. MSC.313(88);</li> <li>- L2 has been replaced by L2W in rows 16, 17 and 31 per item 8 of the Annex to IMO Res. MSC.313(88);</li> <li>- Row no. 32 has been added per item 24 of the Annex to IMO Res. MSC.399(95);</li> <li>- New rows no. 33 and 34 have been added to address exhaust gas cleaning system effluent line and urea supply system;</li> <li>- Abbreviations and Footnotes 1-10 have been revised for alignment with the Annex to IMO Res. MSC.313(88) and MARPOL Regulation numbering;</li> <li>- New Footnotes 11, 12 and 13 have been added;</li> <li>- Location definitions have been revised as regards SOLAS regulation numbering.</li> </ul>



P4.4.2.1 & P4.4.2.2	The paragraphs have been revised per items 8, 9, 11 and 12 of the Annex to IMO Res. MSC.399(95)
P4.4.2.3	A criterion for ASTM D635 has been added together with a reference to national standards.
P4.5.1	A clarification for exception as required in P4.2.3 has been added.
P4.6.1.1	The paragraph has been revised per item 5 of the Annex to IMO Res. MSC.313(88).
P4.6.3.2	The reference to Classification society has been removed.
P4.6.7.1	The paragraph has been revised to refer to the 2010 FTP Code.
P4.6.7.2	Clarification for a metallic shut-off valve has been added.
P4.7.1	The paragraph has been revised per item 1 of the Annex to IMO Res. MSC.313(88).
P4.7.2.III	New row 7 has been added; Title has been revised by the addition of "as applicable".
P4.7.3	Footnote has been revised to refer to amendments to Res. A.753(18).

## 5. Points of discussions or possible discussions

- A query was sent to IACS by a plastic pipe manufacturer stating that paragraph P4.3.1.4 (Rev.4) "in no case is the collapse pressure to be less than 3 bar" is interpreted differently by class societies in connection with IMO Res. A.753(18). In particular, same maker asked IACS opinion whether plastic pipes of a scrubber system need to meet P4.3.1.4. Due to split views between member societies, IACS advised the maker that the matter is under study and will advise on its conclusions. Furthermore, the reply stated that "Unified Requirements (UR) are minimum technical requirements adopted by IACS which, subject to ratification by the governing body of each IACS Member, are to be incorporated in their Rules and practices. URs set forth minimum requirements; each IACS Member remains free to set more stringent requirements or express a reservation if it cannot agree to a UR or parts thereof. UR P4 (Rev.4) is applied by IACS Societies ever since its implementation from 1 January 2010".
- During the discussion within the Panel (PM15907) on whether the collapse pressure applies to all pipes or only to those under external pressure, it was agreed to remove the paragraph numbering in P4.3.1.4 so that that the requirement in the UR falls under the section "external pressure"; however in order to cover piping systems other than those that are normally subject to external pressure, the requirement has been extended to all pipe installations which are to remain operational in case of flooding damage or pipes that would allow progressive flooding to other compartments through damaged piping or through open ended pipes in the compartment (P4.3.1.3ii).
- Apparently a standard specifying a minimum wall thickness of plastic pipes is not available contrasting with steel pipes which have a minimum wall thickness. It would appear in this regard that pipes that are not subject to vacuum or external pressure may have a wall thickness and fibre reinforcement suitable for internal

pressure only. In this regard a new paragraph has been added clarifying that in the absence of standards for pipes not subject to external pressure, the requirements of P4.3.1.3ii apply.

- A member society suggested that applications in temperatures below -25deg.C should be also addressed. The suggestion was not followed based on the understanding that low temperature applications may be considered on a case-by-case basis.
- According to a member society N/A in the fire endurance matrix needs further clarification; it was clarified in this regard that N/A is not to be interpreted as "0" or "X".
- A suggestion to add a reference to the "operating temperature" to P4.1.6 was not finally followed based on the understanding that "under operating conditions" covers the specific suggestion.
- The 60mm/min maximum flame spread criteria in P4.4.2.3 when using the procedure of ASTM D635 has been agreed based on the already agreed EU RO Mutual Recognition Technical Requirements.
- The urea piping requirement and associated footnote 12 was introduced based on discussions within the panel on UR M77.2.8 and Panel decision (PM16912). Furthermore, at a member's suggestion, a new row for Exhaust Gas Cleaning System effluent line has been inserted in the Fire Endurance Matrix with associated footnotes.
- With regard to P4.2.3 (Rev.4), there seem no reason for limiting the paragraph to thermoplastic materials, therefore the reference to materials such as polyethylene(PE), polypropylene(PP), polybutylene(PB) has been deleted.
- The previous wording of P4.2.3 in conjunction with P4.5.1 raised questions on the applicability of sections for plastic pipes for non-essential services. In this regard the specific sections that apply for such pipes have been clarified in the revised P4.2.3.
- A new suggested paragraph addressing safe return to port purposes under P4.6.7 was agreed to be transferred under the Fire Endurance Matrix as Footnote 13.
- It has been agreed that the application statement follows the scheme discussed during the revision of UR E10, i.e. differentiating between application for type approval by a maker and installation on new ships (based on the contract for construction date).
- During the discussion, a member society suggested that "In case of specifying the requirement that clarifies requirements to be applied to non-essential plastic pipes (e.g.: pipes for drinking water, domestic water and sanitary water, etc.), which requirements are not clear whether to be applied to such pipes in UR P4 Rev.4 (especially, test for flame spread specified in P4.4.2), it may become difficult to use standardized products (e.g.: plastic pipe meets ISO standard ) that have been used so far.". However, as a result of discussion, Machinery Panel member concluded that at least P4.3.1.3 (ii), P4.4.2, P4.5.2 to P4.5.7 and P4.6 are

necessary for safety of non-essential plastic pipes and it should be clearly specified in P4.2.3.

- One Member Society asked Members agreement to their understanding that a valve which can be closed remotely, but cannot be opened remotely is acceptable as "remotely controlled valves" according to UR P4, Table1, Footnote 1; Panel Members advised of their agreement in general this understanding. A proposal for modification of UR P4, Table1, Footnote 1 according to this understanding was offered to Panel Members but after discussion the qualified majority agreed to keep the existing text "Where non-metallic piping is used, remotely controlled valves to be provided at ship's side (valve is to be controlled from outside space)" in order to be aligned with the text used in Footnote 1 of Appendix 4 of Res. A.753(18) as amended.

## **6. Attachments if any**

None

## Technical Background (TB) document for UR P4 (Rev.6 Feb 2021)

### 1. Scope and objectives

UR P4 (Rev.5) does not reflect the agreed format for referencing the ISO and ASTM standards. Rev.6 has been developed to comply with the agreed format.

### 2. Engineering background for technical basis and rationale

#### A) Format for references to Industry standards

**Format:**

*[Standard Designation], [version/revision, if applicable], [year of publication] (examples: API Spec 2F, 6th Edition, 1997; ISO 4624, 2002), where [version/revision, if applicable] and/or [year of publication] are decided by IACS and are not necessarily to be the current/latest version.*

#### B1) Format for references to IMO instruments (where the number of amendments is large)

**Format:**

*regulation/paragraph x.x.x of SOLAS Chapter X/MARPOL Annex X/the XXX Code, as amended by IMO resolutions up to MSC.xx(xx)/MEPC.xx(xx)*

#### B2) Format for references to IMO instruments (where the number of amendments is small)

**Format:**

*regulation/paragraph x.x.x of SOLAS/MARPOL/the XXX Code, as amended by resolutions MSC/MEPC.xx(xx), (...) and MSC/MEPC.xx(xx)*

### 3. Source/derivation of the proposed IACS Resolution

None

### 4. Summary of Changes intended for the revised Resolution:

UR P4 has been updated to specify the revision/version of the ISO and ASTM standards as follows:

ISO and ASTM standards	Replaced by
ISO 75	ISO 75-2:2013
ASTM D648	ASTM D648-18
ASTM D635	ASTM D635-18

### 5. Points of discussions or possible discussions

None

### 6. Attachments if any

None

## **Technical Background (TB) document for UR P4 (Rev.7 June 2022)**

### **1. Scope and objectives**

Task PM20303a was initiated by member suggestions for clarifications of ambiguously worded text regarding fire endurance test on flange connections with respect to considering joints as well as number, type and dimensions of specimen. In context of this review minor corrections were made.

### **2. Engineering background for technical basis and rationale**

- a. The section 4.4. "Requirements for Pipes/Piping Systems Depending on Service and/or Locations" of the UR appeared to be ambiguously worded compared to IMO Res. A.753(18), as amended by IMO Res. MSC.313(88) and IMO Res. MSC.399(95).
- b. Existing fire endurance can be read that only pipes and their associated fittings needs to be tested. According to Appendix 1 of Res. A.753(18) test specimen "should be prepared with the joints and fittings intended for use". In order to better align UR P4 and Res. A.753(18) Paragraph 4.4.1.1 has been amended by introducing the term "joints", i.e. test consider pipe, fittings and joints.
- c. Section 4.4. does not contain any specification regarding number and type of specimen to be tested. Likewise, the specifications in Res. A.753(18) are vague. In order to assure safety of plastic pipe system tests need to consider representative specimens, i.e. having lowest fire resistance. For pipes test conditions are most demanding for minimum wall thickness, respectively for minimum diameter for given t/D ratio. (Minimum diameter provides most unfavourable ratio between surface and internal volume, i.e. smallest cooling effect.) For fittings most demanding test conditions 0 are for the specimens tee and/or reducer both with minimal wall thickness.
- d. Section 4.4: for selection of pipe specimen two categories specified, i.e. pipes below 200 mm outer diameter and pipes with a diameter equal to or greater than 200 mm. The threshold of 200 mm was specified on typical t/D ratios that show relative constant values for pipes  $\geq 200$  mm (see Attachment 1). In order to avoid discussion on small variation in t/D ratio a tolerance band of  $\pm 10\%$  was set.
- e. Fittings were not considered because wall thickness of fittings is not lower than for pipes respectively joints.
- f. The significance of fire endurance test shall not be impaired by unintentional cooling during the tests. Accordingly, test condition specification is amended to prohibit any replacement of fluid loss by fresh water or nitrogen.
- g. It was clarified in Para. 4.6.10.1 that for pressure test after installation open ended pipes in essential services may be treated as pipes of non-essential services.

### **3. Source/derivation of the proposed IACS Resolution**

The text of the UR is derived from the background given in 2 above.

#### 4. Summary of Changes

UR P4 Rev.6	Revisions
4.1.8	UR amended by definition for "essential for the safety of ship"
4.1.8	Footnote specifying some piping systems essential for the safety of ship
4.1.9	UR amended by a definition for "essential services" referring to UI SC134 as used in Table 1.
4.2.2	Paragraph revised excluding mechanical joints approved for metallic systems, i.e. joints need to be tested for usage with plastic pipe
4.4.1.1	Paragraph amended by the term "joints"
4.4.1.2	New paragraph for specification of test specimens considering pipes, joints and fittings. Additional explanatory footnotes. Two categories for selection of pipe specimen.
4.4.1.2	Due to a comment made by a member on the fire endurance testing sizes of 46CFR141-3, the expression "Unless instructed otherwise by the Flag Administration" has been inserted
4.4.1.3	New paragraph for specification of test conditions regarding constant test pressure. Further, reference to Res. A.753(18) including amendments by IMO Resolutions MSC.313(88) and MSC.399(95)
	Previous Para. 4.4.1.2 to 4.4.1.4 renumbered accordingly
4.6.10.1	Amended so that open ended pipes in essential services need not to be pressure tested after installation

#### 5. Points of discussions or possible discussions

- A member of the panel asked for the interpretation of UR P4.4 and subsequently the panel identified the need for revising this part in view of improve clarity.
- Specification of test specimen (type, dimensions respectively dimension ratio) including dimensions of specimen. Specimen dimensions leading to highest demands in testing.

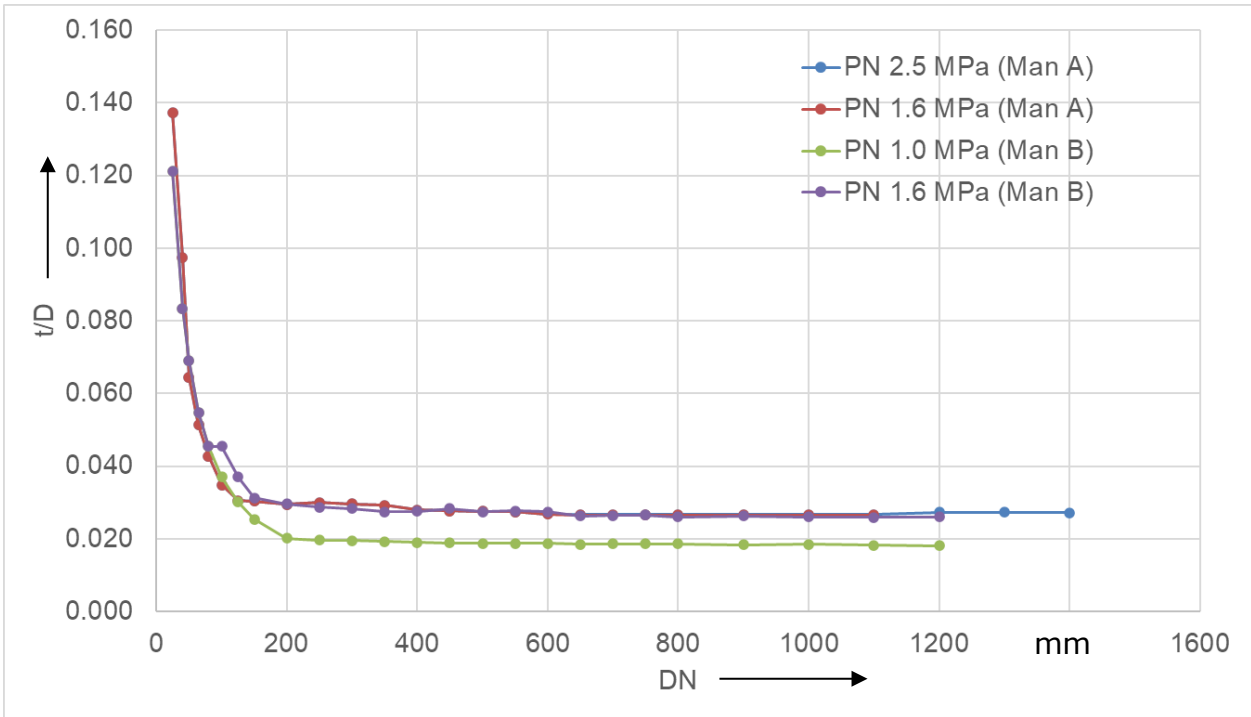
#### 6. Attachments if any

Attachment including an example – Manufacturer A & Manufacturer B

<b>Manufacturer A</b>						
<b>Nominal Diameter DN</b>	<b>PN2.5 MPa</b>			<b>PN1.6 MPa</b>		
	<b>Structural wall thickness t mm</b>	<b>Outer Diameter Do mm</b>	<b>t/Do</b>	<b>Structural wall thickness t mm</b>	<b>Outer Diameter Do mm</b>	<b>t/Do</b>
25	5	36.4	0.137	5	36.4	0.137
40	5	51.4	0.097	5	51.4	0.097
50	3.8	59	0.064	3.8	59	0.064
65	3.8	74	0.051	3.8	74	0.051
80	3.8	89	0.043	3.8	89	0.043
100	3.8	109	0.035	3.8	109	0.035
125	4.1	134.6	0.030	4.1	134.6	0.030
150	4.9	161.2	0.030	4.9	161.2	0.030
200	6.3	214	0.029	6.3	214	0.029
250	8	267.4	0.030	8	267.4	0.030
300	9.5	320.4	0.030	9.5	320.4	0.030
350	10.9	373.2	0.029	10.9	373.2	0.029
400	11.9	425.2	0.028	11.9	425.2	0.028
450	13.2	477.8	0.028	13.2	477.8	0.028
500	14.6	530.6	0.028	14.6	530.6	0.028
550	16	583.4	0.027	16	583.4	0.027
600	17	635.4	0.027	17	635.4	0.027
650	18.35	688.1	0.027	18.22	687.84	0.026
700	19.75	740.9	0.027	19.63	740.66	0.027
750	21.15	793.7	0.027	21.03	793.46	0.027
800	22.55	846.5	0.027	22.43	846.26	0.027
900	25.4	952.2	0.027	25.2	951.8	0.026
1000	28.2	1057.8	0.027	28.03	1057.46	0.027
1100	31	1163.4	0.027	30.8	1163	0.026
1200	34.6	1270.6	0.027			
1300	37.5	1376.4	0.027			
1400	40.3	1482	0.027			

<b>Manufacturer B</b>						
<b>Nominal Diameter DN</b>	<b>PN1.0 MPa</b>			<b>PN1.6 MPa</b>		
	<b>Structural wall thickness t mm</b>	<b>Outer Diameter Do mm</b>	<b>t/Do</b>	<b>Structural wall thickness t mm</b>	<b>Outer Diameter Do mm</b>	<b>t/Do</b>
25	4	33.0	0.121	4	33.0	0.121
40	4	48.0	0.083	4	48.0	0.083
50	4	58.0	0.069	4	58.0	0.069
65	4	73.0	0.055	4	73.0	0.055
80	4	88.0	0.045	4	88.0	0.045
100	4	108.0	0.037	5	110.0	0.045
125	4	133.0	0.030	5	135.0	0.037
150	4	158.0	0.025	5	160.0	0.031
200	4.2	208.4	0.020	6.3	212.6	0.030
250	5.1	260.2	0.020	7.6	265.2	0.029
300	6.1	312.2	0.020	9	318.0	0.028
350	6.9	358.8	0.019	10	365.0	0.027
400	7.8	410.6	0.019	11.5	418.0	0.028
450	8.5	451.0	0.019	13	460.0	0.028
500	9.4	500.8	0.019	14	510.0	0.027
550	10.3	550.6	0.019	15.5	561.0	0.028
600	11.3	602.6	0.019	16.8	613.6	0.027
650	12.5	675.0	0.019	18	686.0	0.026
700	13.5	727.0	0.019	19.5	739.0	0.026
750	14.5	779.0	0.019	21	792.0	0.027
800	15.5	831.0	0.019	22	844.0	0.026
900	17.2	934.4	0.018	25	950.0	0.026
1000	19.2	1038.4	0.018	27.5	1055.0	0.026
1100	20.8	1141.6	0.018	30	1160.0	0.026
1200	22.6	1245.2	0.018	33	1266.0	0.026





## UR P5 Ballast water systems. Requirements on ballast water exchange at sea.

### 1. Scope and objectives

Draft of UR on ballast water systems suitable for providing for the exchange of ballast water at sea has been developed in accordance with Task 62 and 69 of WP/MCH Work Programme.

Presented UR contains measures ensuring safe operation of ballast systems that used for BWE at sea. UR includes requirements to main components of ballast system such as piping, pumps, ballast tanks, sea chests and openings, as well as to control features.

### 2. Points of discussion

Focus of discussion was concentrate on evaluation of acceptable requirements to the sizes of air pipes and ballast water escapes from ballast tanks as well as on evaluation of capacity of pumping equipment. The draft was approved by Members unanimously and submitted to GPG.

GPG have returned the draft to WP to address concerns expressed by ABS and BV GPG Members. The WP carried out a review of the draft and accommodated these concerns. To assure ourselves of the completeness of the work, the draft was given to ABS and BV Members to liaise with their GPG Members for their comments. ABS accepted the draft with minor amendments. BV have not responded. With this status of agreements the WP approved the draft for submission to GPG.

In GPG discussion, BV proposed and GPG agreed an addition to para 3.1 "*.....and/or emptying purposes.*" A further proposed amendment "*The number of valves and the arrangement shall be suitable for the BWE method which will be applied.*" was not agreed, being considered unsuitable for a UR.

Approved by GPG 16 April 2004, 8067\_IGs (TB corr 13/05/04).

### 3. Source of proposed requirements

Reference is made to the following relevant documents:

Rules of the Classification Societies – IACS Members

IACS Hazard Identification (HAZID) of Ballast Water Exchange at Sea – Bulk Carrier.

IACS Requirements Concerning Mobile Offshore Units.

MEPC 42/11/1 Technical Analysis of the Dilution Method by the Experts on Ship Design, Safety and Environmental Aspects

MEPC 45/2/10 Evaluation of Safety Aspects in Relation to Ballast Water Exchange

MEPC 46/3/2 Draft Consolidated Text of International Convention for Control and Management of Ships, Ballast Water and Sediments.

MSC 74/WP.14 Design Suggestion for Ballast Water and Sediment Management Options.

IMO Res. A.868(20) Guidelines for the Control and Management of Ship's Ballast Water to Minimize the Transfer of Harmful Aquatic Organisms and Pathogens.

MEPC 49/INF.6 Harmful Aquatic Organisms in Ballast Water. Draft International Convention for the Control and Management of Ships Ballast Water and Sediments

MEPS/Circ.389 MSC/CIRC.1021 Design suggestion or ballast water and sediments management options in new ships

MEPS49/2/8 Guidelines for Ballast Water Exchange. Submitted by UK

## **TB for UR P5 Del (April 2011)**

Machinery panel report to GPG70 states that:

### PM5301 (4069f)

a) The 12th Machinery Panel Meeting agreed to close this task and establish a new task with the aim of developing a UI related to unclear items related to ballast water exchange at sea in the MO Resolution MEPC.124(53) Guidelines for Ballast Water Exchange (G6).

b) On IACS home page under Unified Requirement is stated:  
"P5 (May 2004) Ballast water systems. Requirements on ballast water exchange at sea.  
Withdrawn (Dec 2004), pending revision to take further account of operational matters."

Actions from GPG:

1. The Panel request that P5 is removed from the list of Unified Requirement
2. The Panel requests that task 4069f is closed.

GPG70 accepted the report from Machinery Panel during GPG70 and hence, approved UR P5 Del (April 2011)

# UR P6 "SHELL TYPE EXHAUST GAS HEATED ECONOMIZERS THAT MAY BE ISOLATED FROM THE STEAM PLANT SYSTEM"

## Part A. Revision History

Version no.	Approval date	Implementation date when applicable
Rev. 1 (June 2015)	09 June 2015	1 July 2016
New (May 2005)	May 2005	1 January 2007

### • Rev.1 (June 2015)

#### 1 Origin of Change:

- Suggestion by IACS member

#### 2 Main Reason for Change:

- UR P6 was developed in response to a serious accident at a steam boiler which was mainly the result of several human mistakes; P6.3.2 to P6.3.4 seem to be trying to ensure that the valve operates even in case of poor maintenance.

However, no sufficient experience is available on construction and installation of special design safety valves or bursting discs, and experience shows that the satisfactory operation of systems can be achieved only on the condition that proper maintenance is done and the equipment is operated by competent personnel.

- To reduce the reservations on IACS URs

#### 3 List of non-IACS Member classification societies contributing through the TC Forum and/or participating in IACS Working Group:

None

#### 4 History of Decisions Made:

The issue was raised within the Machinery Panel. After hearing on the member's experience and requirements it was agreed to amend the IACS UI and associated HF and TB.

#### 5 Other Resolutions Changes:

None

**6 Dates:**

Original Proposal: 19 March 2014 made by Machinery Panel (Form A submitted to GPG under 14159\_PMa dated 13 Oct. 2014)

Panel Approval: 18 May 2015

GPG Approval: 09 June 2015 (Ref: 14159\_IGb)

- **New (May 2005)**

See TB document in Part B.

## **Part B. Technical Background**

List of Technical Background (TB) documents:

Annex 1. **TB for NEW (May 2005)**

See separate TB document in Annex 1.

Annex 2. **TB for Rev.1 (June 2015)**

See separate TB document in Annex 2.

## Annex 1 Technical Background to UR P6 (New, May 2005)

### SHELL TYPE EXHAUST GAS HEATED ECONOMIZERS THAT MAY BE ISOLATED FROM THE STEAM PLANT SYSTEM WP/MCH Task 66

#### 1. Background:

Following an incident involving a severe explosion on an exhaust gas heated economiser on the Island Princess, the UK MAIB issued a Report with recommendations to IACS, LRS, MCA and IMO.

1. Develop guidelines for the examination of crack defects in shell-to-flat-endplate and furnace-to-flat endplate welded joints in shell-type boilers, similar to the guidelines published by the Safety Assessment Federation Ltd. The guidelines should be submitted to ship owners associations and IMO.
2. Extend the scope of periodical surveys to cover examination for cracking in the region of circumferential weld joints between shell and flat-end plates.
3. Require classification surveyors and ship owners to report:

- (i) Cases where shell boiler or economiser repairs are necessary because of cracking;
- (ii) Cases where boiler or economiser safety valves are found to have seized.

The above should be submitted to IACS for the purpose of trend analysis and the identification of problem types.

4. Review procedures and frequency of testing of safety valves of fully flooded economisers.
5. Review the requirements for remote monitoring of economiser's pressure.
6. Encourage ship owners to develop a boiler installation portfolio.

#### 2. Issues addressed by WP/MCH:

All classification societies were requested to review their records of similar installations. The following points were addressed in the development of requirements.

- The design and construction details with particular reference to the welding, heat treatment and inspection arrangements at the tube plate connection to shell.
- Design of safety relief devices for shell type exhaust gas heated economisers that can be isolated from the steam plant system and that be subject to the accumulation of solid matter in-way of the relief valves.
- Requirements for pressure indication.
- Requirements for removable lagging to enable ultrasonic examination of the tube plate to shell connection.
- Requirements for feed water arrangements to address pre-heating and deaeration.
- Requirements operating instructions covering feed water treatment and sampling periodic checks on the system.
- Classification survey requirements.

The draft unified requirements incorporate all these points.

(Ref:: The Survey Panel Task no.7 "Amend Z18 to consider surveys of Exhaust Gas Heated Economizers". Target date 4Q-2005. UK MAIB REC nos 1, 2 and 4(Island Princess) will be addressed)

(Submitted by WP/MCH, 2004)

**Annex to TB.**

**GPG comments:**

**1. General**

DNV, on 31 January 2005, invited GPG to further consider the draft UR P6, stating that operational aspects and/or consequences thereof seemed not to have been included in the original draft. DNV provided GPG with a modified draft. Following a considerable length of discussion, ABS provided a summary of GPG comments on 11 March 2005 as follows (4069jABi). Most of the ABS proposals was agreed.

**4069jABi is copied hereunder:**

**“Quote”**

1. P6.1 – CCe (25 Feb) and NKd (3 Mar) recommended that the practicability of applying UR P6 to shell economizers fitted on existing ships should be evaluated before its implementation. ABS agrees with this recommendation and requests other members' opinions. This statement has been placed in square brackets.

2. P6.1 – With the delays in finalizing this UR, ABS will now not be able to implement this UR from 1 January 2006. We suggest a new implementation date of 1 January 2007 (which will also allow for the practicability of application to existing ships, raised above, to be dealt with.)

3. P6.3.1 – There appears to be agreement with NVh (1 Mar) that one safety valve must be provided if the total heating surface is less than 50 m<sup>2</sup> and two safety valves must be provided if the total heating surface is 50m<sup>2</sup> or more. This should satisfy item 4 of CCe (25 Feb). ABS supports this proposal.

4. P6.3.2 – NKe (3 Mar) and LRj (7 Mar) added a requirement for the guide bush of safety valves, which was not supported by Rle (7 Mar). ABS agrees with Rle that such a requirement cannot be uniformly enforced and should be deleted. This statement is included in square brackets.

**(GPG: deleted. However, an additional item was added to P6.7 “Procedures for maintenance and overhaul of safety valves)**

5. a) P6.3.1 – CCe (25 Feb) further suggested that the two safety valves should not be installed in one chest. This was not supported by NKe (3 Mar) since the bursting disk would provide an additional level of protection. However, resolution of this item is dependent upon item (b) below. This statement is included in square brackets.

b) P6.3.3 – CCe (25 Feb) contends that a bursting disk or alternative means is redundant if the economizer is fitted with two safety valves. ABS suggests a revision to apply P6.3.3 only for cases where a single safety valves is provided (i.e., total heating surface below 50 m<sup>2</sup>). This revision is shown in square brackets.

c) If members agree that a bursting disk is only required when a single safety valve is fitted, then a case may be made for the suggestion in CCe that the safety valves should not be installed in one chest since there would be no bursting disk. If, however, members decide to require a bursting disk even when two safety valves are fitted, then the comments raised in NKe would be valid and the bursting disk would provide suitable protection, permitting the two safety valves to be fitted on the same chest.



d) ABS supports the idea that a bursting disk is not required if there are two safety valves. Accordingly, we recommend that the text in square brackets in P6.3.1 shown in attached file, should be deleted and that the text in square brackets at the beginning of P6.3.3 should be retained.

6. P6.3.3.2 – BVe (23 Feb) has advised that they do not consider a high pressure warning device to be an acceptable alternative to a bursting disk or additional safety valve. Further, R1e does not support the automatic reduction of engine load. The entire P6.3.3.2 is included in square brackets. ABS recommends that the entire P6.3.3.2 be deleted.

7. P6.3.8 - CCe (25 Feb) proposed new text concerning acceptance of exceptions, alterations or equivalence. ABS does not believe that this additional text can be uniformly applied. It has not been included in the draft UR.

ABS suggests that the Chairman invite members' positions on each of the points raised above with a view to finding for which items at least 2/3 majority support exists.

Regards,  
S. R. McIntyre  
ABS IACS GPG Member

**“Unquote”**

## **2. Council decided that:**

- P6.1: Delete both options and task MCH Panel to evaluate the applicability of this UR to existing economizers(MCH Panel was so tasked);
- P6.3.3: Where no safety valves incorporating the features described in P6.3.2 are fitted, a bursting disc according to P6.3.3 is to be provided.

**End**

## **Technical Background to UR P6 (Rev.1, June 2015)**

### **1. Scope and objectives**

To revise the UR P6 by removing P6.3.2 and P6.3.3, due to:

- lack of availability or experience in using special design safety valves
- lack of experience in using bursting discs on steam boilers
- objection from members concerning the use of bursting discs

The application of the UR P6 (Rev. 0) is seen as problematic and reservations have arisen.

### **2. Engineering background for technical basis and rationale**

No sufficient experience is available with the construction and installation of special design safety valves (bellows or shear pin) or bursting discs.

The UR seems to be trying to ensure that the valve operates even in case of poor maintenance, but experience shows that satisfactory operation of systems can be achieved only on the condition that proper maintenance is done and the equipment is operated by competent personnel.

### **3. Source/derivation of the proposed IACS Resolution**

N/A

### **4. Summary of Changes intended for the revised Resolution:**

- Deletion of P6.3.2 (requirement for special design safety valves)
- Deletion of P6.3.3 (requirement of bursting disc in way of special design safety valves)
- Replacement of “solid matter deposits” in P6.3.4 with “condensate”  
: It is considered that the primary function of the drain is to prevent a preload on the safety valve exerted by the static head of water in the steam exhaust pipe. The requirement for the drain itself is therefore to prevent the accumulation of condensate as opposed to preventing the build-up of solid matter deposits, which could be one cause of an accumulation of condensate. A separate requirement would be needed to prevent the accumulation of solid matter deposits through appropriate sizing of the drain.

### **5. Points of discussions or possible discussions**

N/A

**6. Attachments if any**

N/A

# IACS

INTERNATIONAL ASSOCIATION OF CLASSIFICATION SOCIETIES LTD.

PERMANENT SECRETARIAT: 4 Matthew Parker Street

Westminster, London SW1H 9NP, UNITED KINGDOM

TEL: +44(0)207 976 0660

INTERNET: [permsec@iacs.org.uk](mailto:permsec@iacs.org.uk) Web Site: [www.iacs.org.uk](http://www.iacs.org.uk)

May 2024

## History Files (HF) and Technical Background (TB) documents for URs concerning Strength of Ships (UR S)

Res. No.	Title	Current Rev.	HF/TB?
UR S1	Requirements for Loading Conditions, Loading Manuals and Loading Instruments	Rev.7 May 2010	HF
UR S1A	Additional Requirements for Loading Conditions, Loading Manuals and Loading Instruments for Bulk Carriers, Ore Carriers and Combination Carriers	Rev.6 May 2010	HF
UR S2	Definition of ship's length L and of block coefficient $C_b$	Rev.2 June 2019	HF
UR S3	Strength of end bulkheads of superstructures and deckhouses	Rev.2 June 2023	HF
UR S4	Criteria for the use of high tensile steel with minimum yield stress of 315 N/mm <sup>2</sup> , 355 N/mm <sup>2</sup> and 390 N/mm <sup>2</sup>	Rev.4 Apr 2017	HF
UR S5	Calculation of midship section moduli for conventional ship for ship's scantlings	Corr.1 June 2019	HF
UR S6	Use of steel grades for various hull members - ships of 90m in length and above	Corr.2 Mar 2021	HF
UR S7	Minimum longitudinal strength standards	Rev.4 May 2010	HF
UR S8	Bow doors and inner doors	Rev.4 Dec 2010	HF
UR S9	Side shell doors and stern doors	Rev.6 Dec 2010	HF
UR S10	Rudders, sole pieces and rudder horns	Rev.7 Corr.2 May 2024	HF
UR S11	Longitudinal strength standard	Rev.10 Dec 2020	HF
UR S11A	Longitudinal Strength Standard for Container Ships	June 2015	HF
UR S12	Side Structures in Single Side Skin Bulk Carriers	Rev.5 May 2010	HF

<b>Res. No.</b>	<b>Title</b>	<b>Current Rev.</b>	<b>HF/TB?</b>
UR S13	Strength of bottom forward in oil tankers	Corr.1 May 2014	HF
UR S14	Testing Procedures of Watertight Compartments	Rev.7 Dec 2022	HF
UR S15	Side shell doors and stern doors - Retrospective application of UR-S9 to existing ro-ro passenger ships	Rev.1 Nov. 2003	No
UR S16	Bow Doors and Inner Doors - Retrospective Application of UR-S8, as amended to 1995, to existing Ro-Ro Passenger Ships	Rev.1, Corr.1 Aug 2004	No
UR S17	Longitudinal Strength of Hull Girder in Flooded Condition for Non-CSR Bulk Carriers	Rev.10 Mar 2019	HF
UR S18	Evaluation of Scantlings of Corrugated Transverse Watertight Bulkheads in Non-CSR Bulk Carriers Considering Hold Flooding	Rev.10 Mar 2019	HF
UR S19	Evaluation of Scantlings of the Transverse Watertight Corrugated Bulkhead between Cargo Holds Nos. 1 and 2, with Cargo Hold No. 1 flooded, for Existing Bulk Carriers	Rev.5 July 2004	TB
UR S20	Evaluation of Allowable Hold Loading for Non-CSR Bulk Carriers Considering Hold Flooding	Rev.6 Apr 2014	HF
UR S21	Evaluation of Scantlings of Hatch Covers and Hatch Coamings of Cargo Holds of Bulk Carriers, Ore Carriers and Combination Carriers	Rev.6 Jan 2023	HF
UR S21A	Evaluation of Scantlings of Hatch Covers and Hatch Coamings and Closing Arrangements of Cargo Holds of Ships	Del Jan 2023	HF
UR S22	Evaluation of Allowable Hold Loading of Cargo Hold No.1 with Cargo Hold No.1 Flooded, for Existing Bulk Carriers	Rev.3 July 2004	TB
UR S23	Implementation of IACS Unified Requirements S19 and S22 for Existing Single Side Skin Bulk Carriers	Rev.4 Aug 2007	TB
UR S24	Detection of Water Ingress into Cargo Holds	Deleted (Jan 2004) Superseded by UI SC179 & SC180	TB
UR S25	Harmonised Notations and Corresponding Design Loading Conditions for Bulk Carriers	Deleted (May 2010)	HF
UR S26	Strength and Securing of Small Hatches on the Exposed Fore Deck	Rev.5 May 2023	HF
UR S27	Strength Requirements for Fore Deck Fittings and Equipment	Rev.6 Jun 2013 (Mar 2021 Updated)	HF
UR S28	Requirements for the Fitting of a Forecastle for Bulk Carriers, Ore Carriers and Combination Carriers	Rev.3 May 2010	HF

<b>Res. No.</b>	<b>Title</b>	<b>Current Rev.</b>	<b>HF/TB?</b>
UR S29	No record		
UR S30	Cargo Hatch Cover Securing Arrangements for Bulk Carriers not Built in Accordance with UR S21(Rev.3)	Corr.1 Mar 2019	TB
UR S31	Renewal Criteria for Side Shell Frames and Brackets in Single Side Skin Bulk Carriers and Single Side Skin OBO Carriers not Built in accordance with UR S12 Rev.1 or subsequent revisions	Rev.4 April 2007	TB
UR S32	Local Scantlings of Double Side Skin Structure of Bulk Carriers (DRAFT)	DRAFT Deleted (May 2010)	HF
UR S33	Requirements for Use of Extremely Thick Steel Plates in Container Ships	Rev.3 Feb 2020 (Jan 2021 updated)	HF
UR S34	Functional Requirements on Load Cases for Strength Assessment of Container Ships by Finite Element Analysis	May 2015	HF
UR S35	Buckling Strength Assessment of Ship Structural Elements	Feb 2023	HF

## UR S1 “Requirements for Loading Conditions, Loading Manuals and Loading Instruments”

### Part A. Revision History

Version no.	Approval date	Implementation date when applicable
Rev.7 (May 2010)	24 May 2010	-
Rev.6 (July 2004)	5 July 2004	-
Rev.5 (June 2001)	4 June 2001	-
Rev.4 (1997)	28 May 1997	1 July 1998
Rev.3 (1995)	<i>No record</i>	-
Rev.2 (1983)	<i>No record</i>	-
Rev.1 (1981)	<i>No record</i>	-
NEW (1971)	<i>No record</i>	-

- **Rev.7 (May 2010)**

**.1 Origin for Change:**

- Based on IACS Requirement (*Common Structural Rules for Bulk Carriers and Double Hull Oil Tankers*)

**.2 Main Reason for Change:**

Following the introduction of the IACS Common Structural Rules for Bulk Carriers and Double Hull Oil Tankers, Hull Panel were tasked to review all the UR S files to consider whether or not they are applicable to ships covered by the CSR.

**.3 List of non-IACS Member classification societies contributing through the TC Forum and/or participating in IACS Working Group:**

None.

**.4 History of Decisions Made:**

After review it was decided that the requirements of UR S1 apply to CSR ships in addition to those of the Common Structural Rules.

**.5 Other Resolutions Changes**

All UR S files, except UR S8, S9, S15, S16, S19, S22, S23, S30 and S31.

**.6 Dates:**

Original proposal: 2007, made by Hull Panel Task 50  
 Panel submission to GPG: 19 April 2010  
 GPG Approval: 24 May 2010 (Ref. 10051\_IGd)

- **Rev.6 (July 2004)**

Addition of 'Contracted for Construction' footnote – no TB document available.

- **Rev.5 (June 2001)**

See TB document in Part B.

- **Rev.4 (1997)**

No TB document available.

- **Rev.3 (1995)**

No TB document available.

- **Rev.2 (1983)**

No TB document available.

- **Rev.1 (1981)**

No TB document available.

- **NEW (1971)**

No TB document available.



## Part B. Technical Background

List of Technical Background (TB) documents for UR S1:

Annex 1. **TB for Rev.5 (June 2001)**

See separate TB document in Annex 1.



**Note:** *There are no separate Technical Background (TB) documents for the original resolution (1971), Rev.1 (1981), Rev.2 (1983), Rev.3 (1994), Rev.4 (1997), Rev.6 (July 2004) and Rev.7 (May 2010).*

IACS Unified Requirement S 1 (Rev.5 June 2001)

## **Requirements for Loading Conditions, Loading Manuals and Loading Instruments**

### **Technical Backgrounds:**

#### **a) Objective/Scope**

The objective was to eliminate Members' reservations:

#### **b) Source of Proposed Requirements**

WP/S was not able to find a way to accommodate Members' reservations in S 1 and invited GPG to consider the matter which was seen to be a policy issue.

#### **c) Points of Discussion**

- NK's reservation against S1.2.1 (NK did not consider that a loading instrument should be required for existing Chemical and Gas Carriers.
- ABS and others' reservation (ABS did not require a loading instrument for Category I ships less than 122 meters in length built before the last revision of UR S 1 was issued (Rev.4 1997).

In particular, S 1 (Rev.2, 1983) required loading instruments for certain categories of ships subject to ILLC 1966 regardless of length for which class request was received on or after 1 July 1984. However, Members' implementation of S 1 (Rev.2, 1983) was not in uniform.

- GPG decided that
  - to remove NK's reservation, the application length required for Category I ships shall be changed to "100 m in length" in S1.2.1.
  - to resolve Members' inconsistent implementation of the prior edition of S 1 (Rev.3, 1983), the following wording shall be added to the Note:  
"For ships constructed before 1 July 1988, the relevant revisions of this UR as well as Members reservations to those revisions of this UR apply."

## UR S1A “Additional Requirements for Loading Conditions, Loading Manuals and Loading Instruments for Bulk Carriers, Ore Carriers and Combination Carriers”

### Part A. Revision History

Version no.	Approval date	Implementation date when applicable
Rev.6 (May 2010)	24 May 2010	-
Rev.5 (Jul 2004)	5 July 2004	-
Rev.4 (Nov 2001)	9 November 2001	-
Rev.3 (Sept 2000)	7 September 2000	1 July 2001
Rev.2 (May 1998)	28 May 1998	-
Rev.1 (Apr 1998)	17 April 1998	1 January 1999/1 July 1999* <sup>1, 2</sup>
NEW (1997)	28 May 1997	1 July 1998* <sup>1</sup>

**\* Notes:**

1. The latest date for implementation of requirements in S1A.2.1(f), S1A.2.2(b) and S1A.4(d) is 1 July 1999.
2. See resolution for full details of implementation dates.

#### • Rev.6 (May 2010)

##### .1 Origin for Change:

- Based on IACS Requirement (*Common Structural Rules for Bulk Carriers and Double Hull Oil Tankers*)

##### .2 Main Reason for Change:

Following the introduction of the IACS Common Structural Rules for Bulk Carriers and Double Hull Oil Tankers, Hull Panel were tasked to review all the UR S files to consider whether or not they are applicable to ships covered by the CSR.

##### .3 List of non-IACS Member classification societies contributing through the TC Forum and/or participating in IACS Working Group:

None.

##### .4 History of Decisions Made:

After review it was decided that for CSR bulk carriers the requirements of UR S1A are superseded by those of the Common Structural Rules and therefore do not apply.

UR S1A is not applicable for CSR oil tankers.

## **.5 Other Resolutions Changes**

All UR S files, except UR S8, S9, S15, S16, S19, S22, S23, S30 and S31.

## **.6 Dates:**

Original proposal: *2007, made by Hull Panel Task 50*

Panel submission to GPG: *19 April 2010*

GPG Approval: *24 May 2010 (Ref. 10051\_IGd)*

- **Rev.5 (Jul 2004)**

Addition of 'Contracted for Construction' footnote – no TB document available.

- **Rev. 4 (Nov 2001)**

See TB document in Part B.

- **Rev.3 (Sept 2000)**

See TB document in Part B.

- **Rev.2 (May 1998)**

No TB document available.

- **Rev.1 (Apr 1998)**

No TB document available.

- **NEW (1997)**

No TB document available.

## Part B. Technical Background

List of Technical Background (TB) documents for UR S1A:

Annex 1. **TB for Rev.3 (Sept 2000)**

See separate TB document in Annex 1.



Annex 2. **TB for Rev.4 (Nov 2001)**

See separate TB document in Annex 2.



**Note:** *There are no separate Technical Background (TB) documents for the original resolution (1997), Rev.1 (Apr 1998), Rev.2 (May 1998), Rev.5 (July 2004) and Rev.6 (May 2010).*

## **Technical Background to changes proposed in respect of UR's S1A, Annex 2 to S1A, S12, S17, S18, S19, S20 and S22**

The objective of the proposal is to reflect the IMO interpretation of 'single side skin construction' in the above mentioned Unified Requirements for bulk carriers. The Working Party on Strength discussions were unable to yield unanimous agreement and the following matters remain unresolved:

- The titles for UR's S17, S18, S19, S20 and S22 include the wording 'single side skin'. It was generally considered that this wording should now be deleted as the text clearly defines the scope of application and refers additionally to arrangements with double side skin construction. The GL Member does not support this view on the basis that the expression 'single side skin' appears in the text of SOLAS Chapter XII. In view of this difference, the wording 'single side skin' has been enclosed in square brackets pending further consideration by GPG.
- In order to clarify how the breadth of the side shell should be measured, the phrase 'between topside tank and hopper tank' has been used in S17.1(ii) and (iii), S18.1(ii) and (iii), S19.1(ii), S20.1(ii) and (iii), and S22(ii). This was not supported by the ABS member who considers that the IMO definition of single side skin construction does not necessarily refer only to the location between topside and hopper tanks. Also this was not supported by the CRS Member who considers that MSC 89(71), which identifies that measurements are to be made perpendicular to the side shell, provides sufficient guidance. For these reasons, the text has been enclosed in square brackets pending further consideration by GPG.

In addition to the above, two other issues have been raised as follows:

- The ABS Member has requested that the following be considered in respect of the deletion of reference to damage stability requirements from paragraph S17.1 of URS17. It is noted that the reference was originally included in order to cover a six months difference in implementation timetables between SOLAS and IACS. Although both implementation dates have now passed and the need for this provision is limited, there could still be cases where it is relevant due to a change of Class from a non-IACS Society to an IACS Society. It is, therefore, proposed that the present clause in URS17 be replaced by an alternative clause within a unified requirement more specifically related to stability requirements. Support for this proposal has been indicated by PRS, DNV, KR, RINA, CRS and LR.
- The GL Member has requested that consideration be given to amending URS20 and URS22 such that these requirements are only applicable when corrugated bulkheads are fitted. This matter has not received support from the other WP/S Members and is considered to be outside the scope of the present Task.

Submitted by WP/S Chair on 31 May 2000

(Note: For GPG action, refer to GPG Chair's message 0064dIGa, 31/7/00)

**Technical Background to changes proposed with respect to UR S1A & S11**

The objective of the attached proposals is to prohibit the practice of using partially filled ballast tanks, in design conditions, to control longitudinal strength. To accomplish this, it is proposed that appropriate changes be incorporated into the portion of UR S11.2.1.2 that describes items related to the load conditions that are considered in longitudinal strength calculations. This change also necessitates deletion of a conflicting reference in S1A.3c), which deals with partial filling of peak tanks.

The change was agreed unanimously and no unresolved issues remain.

Submitted by WP/S Chairman on 28 August 2001.

## UR S2 “Definition of ship’s length $L$ and of block coefficient $C_b$ ”

### Summary

The length definition has been aligned on the CSR BC & OT definition for avoiding discrepancies between IACS resolutions and CSR.

### Part A. Revision History

Version no.	Approval date	Implementation date when applicable
Rev.2 (June 2019)	27 June 2019	01 July 2020
Rev.1 (May 2010)	24 May 2010	-
NEW (1973)	<i>No record</i>	-

- **Rev.2 (June 2019)**

**1 Origin for Change:**

- Based on IACS Requirement (*Common Structural Rules for Bulk Carriers and Double Hull Oil Tankers*)

**2 Main Reason for Change:**

Alignment of the definition of the length  $L$  between IACS Common Structural Rules for Bulk Carriers and Double Hull Oil Tankers and the UR S resolutions.

**3 List of non-IACS Member classification societies contributing through the TC Forum and/or participating in IACS Working Group:**

None

**4 History of Decisions Made:**

The review of UR S highlighted the need for harmonizing the length definition between the UR S requirement and the length definition in the CSR BC & OT. The Hull Panel agreed unanimously to update this UR S2 during the HP29 meeting.

**5 Other Resolutions Changes**

None

**6 Any hindrance to MASS, including any other new technologies:**

None



## 7 Dates:

Original proposal: Sept 2018, made by Hull Panel  
Panel approval: 11 June 2019 (Ref: 19093\_PHb)  
GPG Approval: 27 June 2019 (Ref: 19093\_IGd)

### • **Rev.1 (May 2010)**

#### **.1 Origin for Change:**

- Based on IACS Requirement (*Common Structural Rules for Bulk Carriers and Double Hull Oil Tankers*)

#### **.2 Main Reason for Change:**

Following the introduction of the IACS Common Structural Rules for Bulk Carriers and Double Hull Oil Tankers, Hull Panel were tasked to review all the UR S files to consider whether or not they are applicable to ships covered by the CSR.

#### **.3 List of non-IACS Member classification societies contributing through the TC Forum and/or participating in IACS Working Group:**

None.

#### **.4 History of Decisions Made:**

- Based on IACS Requirement (*Common Structural Rules for Bulk Carriers and Double Hull Oil Tankers*)

#### **.5 Main Reason for Change:**

Following the introduction of the IACS Common Structural Rules for Bulk Carriers and Double Hull Oil Tankers, Hull Panel were tasked to review all the UR S files to consider whether or not they are applicable to ships covered by the CSR.

#### **.6 List of non-IACS Member classification societies contributing through the TC Forum and/or participating in IACS Working Group:**

None.

#### **.7 History of Decisions Made:**

After review it was decided that for CSR ships the requirements of UR S2 are superseded by those of the Common Structural Rules and therefore do not apply.

#### **.8 Other Resolutions Changes**

All UR S files, except UR S8, S9, S15, S16, S19, S22, S23, S30 and S31.

**.9 Dates:**

Original proposal: *2007, made by Hull Panel Task 50*

Panel submission to GPG: *19 April 2010*

GPG Approval: *24 May 2010 (Ref. 10051\_IGd)*

- **NEW (1973)**

No TB document available.

## Part B. Technical Background

List of Technical Background (TB) documents for UR S2:

Annex 1. **TB for Rev.2 (June 2019)**

See separate TB document in Annex 1.



**Note:** *There are no separate Technical Background (TB) documents for the original resolution (1973) and Rev. 1 (May 2010)*

---

**Technical Background document for UR S2 (Rev.2 June 2019)****1. Scope and objectives**

This revision intends to provide a definition of the Rule length and the block coefficient harmonised between the UR S resolutions and the CSR.

**2. Engineering background for technical basis and rationale**

The CSR definition of the Rule length is based on the scantling draught of the ship instead of the summer load waterline draught corresponding to the freeboard assigned to the ship.

The design draught is a scantling parameter well known at design stage while the summer load waterline draught could be selected at a later stage of the ship design. This summer load waterline draught could not be higher than the design draught, the draught corresponding to the geometric freeboard and the maximum draught complying with the stability requirements. This summer load waterline draught could result from an owner decision based on port fees to pay, could vary during the ship's life or could be different between sisterships.

The selection of length based on the scantling draught avoids those variations and consequently is more stable.

The  $C_b$  definition follows the Rule length definition as regard to the draught. The displacement, the moulded breadth  $B$  and the draught correspond to the scantling draught  $T_s$ .

**3. Source/derivation of the proposed IACS Resolution**

Comparison of lengths resulting to the current and proposed definitions has been performed on ships of different sizes and types: Gas carrier, Chemical tanker, Passenger ship.

The figure 1 gives the length variation considering the scantling draught ( $T_s$ ) of the summer freeboard draught ( $T_{swl}$ ). The figure 2 shows the comparison between the following ratios:

$$L \text{ Ratio} = \frac{L \text{ at } T_s}{L \text{ at } T_{swl}} \quad C_b \text{ Ratio} = \frac{C_b \text{ at } T_s}{C_b \text{ at } T_{swl}}$$

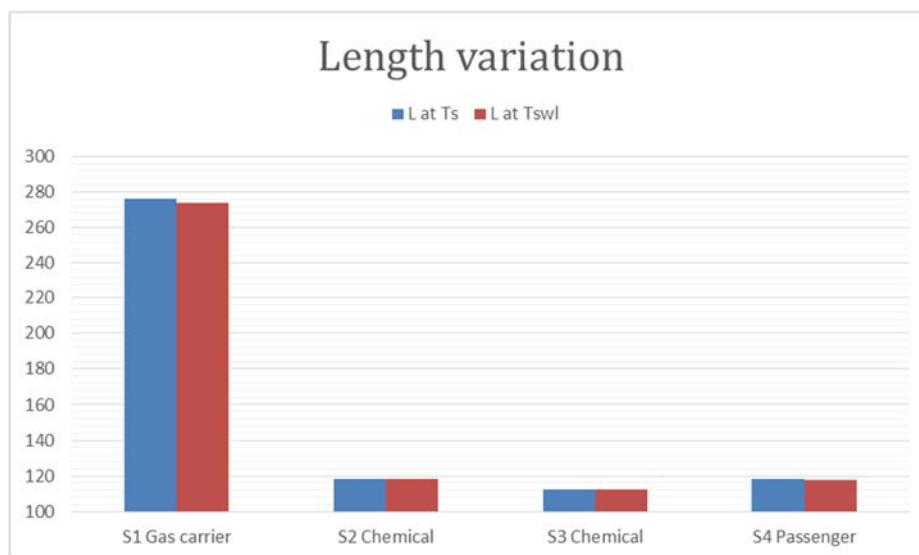


Figure 1

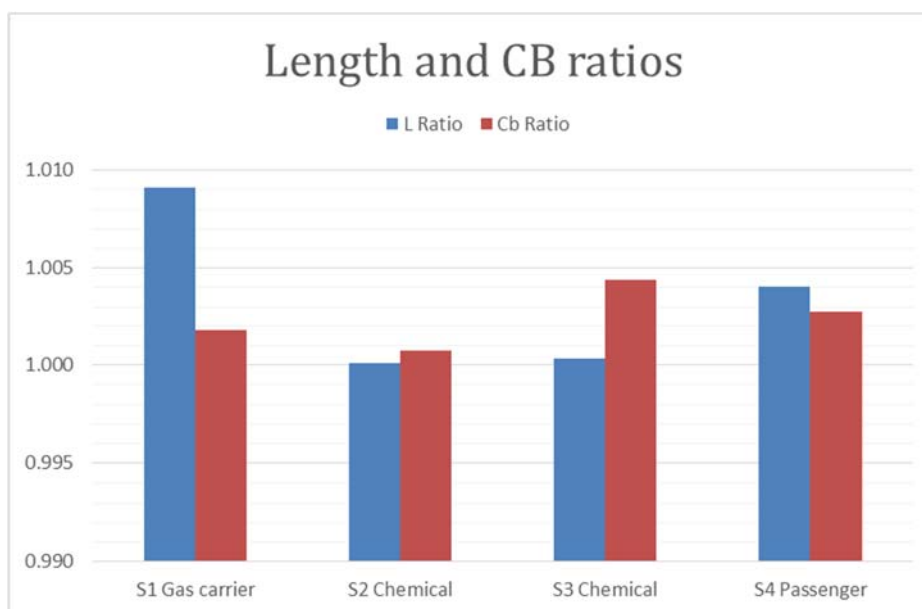


Figure 2

#### 4. Summary of Changes intended for the revised Resolution:

Replacement of the draught at summer load waterline by scantling draught.  
 Addition of a method to evaluate the length for ships without rudderstock (e.g. ships fitted with azimuth thrusters).

#### 5. Points of discussions or possible discussions

The Hull Panel agreed unanimously to update this UR S2 during the HP29 meeting and the data presented in this TB during the HP30 meeting.

#### 6. Attachments if any

N/A

## UR S3 “Strength of end bulkheads of superstructures and deckhouses”

### Summary

The Revision 2 of UR S3 has been developed to consider the minimum thickness of plating for ships with  $L_1 < 65\text{m}$  stipulated in S3.4.

### Part A. Revision History

Version no.	Approval date	Implementation date when applicable
Rev.2 (June 2023)	26 June 2023	01 July 2024
Rev.1 (May 2010)	24 May 2010	-
NEW (1973)	<i>No record</i>	-

#### • Rev.2 (June 2023)

##### 1 Origin for Change:

- Suggestion by IACS Members

##### 2 Main Reason for Change:

IACS Hull Panel members had a discussion for application of IACS resolutions to small vessels. A small group of 3 members was formed within Hull Panel and they identified that the minimum thickness in S3.4 is too onerous to apply to small vessel. They developed the requirement for small ships.

##### 3 List of non-IACS Member Classification Societies contributing or participating in IACS Working Group:

None

##### 4 History of Decisions Made:

A small group within Hull Panel proposed to amend the requirements in S3.4 for ships with  $L_1 < 65\text{m}$ . HP members provided comments to elaborate the phrase of the requirement for more clarification and agreed the updated proposal.

##### 5 Other Resolutions Changes

None

##### 6 Any hinderance to MASS, including any other new technologies:

None

## 7 Dates:

Original proposal : 25 April 2022 (Ref: PH18020\_IHag)  
Panel Approval : 08 June 2023 (Ref: PH18020\_IHag)  
GPG Approval : 26 Jne 2023 (Ref: 22183cIGb)

### • **Rev.1 (May 2010)**

#### **.1 Origin for Change:**

- Based on IACS Requirement (*Common Structural Rules for Bulk Carriers and Double Hull Oil Tankers*)

#### **.2 Main Reason for Change:**

Following the introduction of the IACS Common Structural Rules for Bulk Carriers and Double Hull Oil Tankers, Hull Panel were tasked to review all the UR S files to consider whether or not they are applicable to ships covered by the CSR.

#### **.3 List of non-IACS Member classification societies contributing through the TC Forum and/or participating in IACS Working Group:**

None.

#### **.4 History of Decisions Made:**

After review it was decided that for CSR bulk carriers the requirements of UR S3 are superseded by those of the Common Structural Rules and therefore do not apply. However for CSR oil tankers the requirements of UR S3 are still valid.

Additionally the opportunity was taken to correct a couple of typos in the equations in S3.2.

#### **.5 Other Resolutions Changes**

All UR S files, except UR S8, S9, S15, S16, S19, S22, S23, S30 and S31.

#### **.6 Dates:**

Original proposal: 2007, made by Hull Panel Task 50  
Panel submission to GPG: 19 April 2010  
GPG Approval: 24 May 2010 (Ref. 10051\_IGd)

### • **NEW (1973)**

No TB document available.

## Part B. Technical Background

List of Technical Background (TB) documents for UR S3:



**Note:** *There are no separate Technical Background (TB) documents for the original resolution (1973), Rev.1 (May 2010) and Rev.2 (June 2023).*



## UR S4 “Criteria for the use of high tensile steel with minimum yield stress of 315 N/mm<sup>2</sup>, 355 N/mm<sup>2</sup> and 390 N/mm<sup>2</sup>”

### Part A. Revision History

Version no.	Approval date	Implementation date when applicable
Rev 4 (Apr 2017)	21 April 2017	-
Rev.3 (May 2010)	24 May 2010	-
Rev.2 (Apr 2007)	2 April 2007	-
Rev.1 (1974)	No record	-
New (1973)	No record	-

#### • Rev.4 (Apr 2017)

##### .1 Origin for Change:

- Based on GPG request 10158jIGo dated 20/12/2016 (GPG81 FUA13)

##### .2 Main Reason for Change:

IACS GPG requests to modify the UR S4 in view to remove the reservations made by 7 Members.

##### .3 List of non-IACS Member classification societies contributing through the TC Forum and/or participating in IACS Working Group:

None.

##### .4 History of Decisions Made:

Based on a proposal made by a GPG Member, Hull Panel reviewed the text. Some modifications were made:

- $I_{min}$  : The condition on  $I_{min}$  parameter is already covered by UR S11 (Rev 8, S11.3.1.2)
- L : This parameter was used in the  $I_{min}$  definition. This definition is no more needed.
- $W_{min}$  : This parameter (defined in UR S7) was used in the  $I_{min}$  definition. This definition is no more needed.
- Replacement of Y: For consistency with other UR S, the Y parameter was replaced by  $R_{eH}$ .

##### .5 Other Resolutions Changes

None.

**.6 Dates:**

Original proposal: 2017 made by Hull Panel  
Panel submission to GPG: 27 March 2017 (Ref: PH9008)  
GPG Approval: 21 April 2017 (Ref: 10158jIGq)

- **Rev.3 (May 2010)**

**.1 Origin for Change:**

- Based on IACS Requirement (*Common Structural Rules for Bulk Carriers and Double Hull Oil Tankers*)

**.2 Main Reason for Change:**

Following the introduction of the IACS Common Structural Rules for Bulk Carriers and Double Hull Oil Tankers, Hull Panel were tasked to review all the UR S files to consider whether or not they are applicable to ships covered by the CSR.

**.3 List of non-IACS Member classification societies contributing through the TC Forum and/or participating in IACS Working Group:**

None.

**.4 History of Decisions Made:**

After review it was decided that for CSR ships the requirements of UR S4 are superseded by those of the Common Structural Rules and therefore do not apply.

**.5 Other Resolutions Changes**

All UR S files, except UR S8, S9, S15, S16, S19, S22, S23, S30 and S31.

**.6 Dates:**

Original proposal: 2007, made by Hull Panel Task 50  
Panel submission to GPG: 19 April 2010  
GPG Approval: 24 May 2010 (Ref. 10051\_IGd)

- **Rev.2 (Apr 2007)**

Addition of criteria for HTS with min yield Stress of 390N/mm<sup>2</sup> – see TB document in Part B.

- **Rev.1 (1974)**

No TB document available.

- **NEW (1973)**

No TB document available.

## Part B. Technical Background

List of Technical Background (TB) documents for UR S4:

Annex 1. **TB for Rev.2 (Apr 2007)**

See separate TB document in Annex 1.

Annex 2. **TB for Rev.4 (Apr 2017)**

See separate TB document in Annex 2.



**Note:** *There are no separate Technical Background (TB) documents for the original resolution (1973), Rev.1 (1974) and Rev.3 (May 2010).*

## TECHNICAL BACKGROUND OF UR S4 (REV.2)

### 1. Scope and objective

To revise UR S4 to give criteria for high tensile steel with specified minimum yield stress of 390 N/mm<sup>2</sup>

### 2. Background

Raised by NK in PH6018bNKa of 6 October 2006. Different values of the material factor “*k*” for high tensile steel with specified minimum yield stress of 390 N/mm<sup>2</sup> are used among IACS member societies, although one unified value has been implemented into the Common Structural Rules for Bulk Carriers and Double Hull Oil Tankers. To obtain a unified criterion for the use of such high tensile steel, it was agreed to revise UR S4 during the 5th Hull Panel meeting without any objection.

In addition, LR pointed out the inconsistency of terminology regarding ‘Yield stress’:

- URS4 uses the term *Minimum Upper Yield Point* ;
- CSR Oil Tankers uses the term *Specified Minimum Yield Stress* ; and
- CSR Bulk Carriers uses the term *Minimum Yield Stress*.

### 3. Points of discussions

1. It is recognized that IACS member societies have used different values varied between 0,66 to 0,70 as a material factor “*k*” for high tensile steel with specified minimum yield stress of 390 N/mm<sup>2</sup> in the application of the hull girder bending strength standard specified in UR S11.3, which would be based on technical and experimental backgrounds of each societies.
2. On the other hand, it is unanimously agreed by all IACS member societies that the unified material factor of 0,68 should be used for such high tensile steel as specified in Ch.3 Sec.1 2.2.1 of the Common Structural Rules for Bulk Carriers and Sec.6/1.1.4 of the Common Structural Rules for Double Hull Tankers.
3. It is considered therefore that UR S4 should be revised for the uniform application of the hull girder bending strength standard and also being in line with the Common Structural Rules for Bulk Carriers and Double Hull Oil Tankers.
4. Regarding the consideration for the usage of such high tensile steel in other IACS URs, it is also agreed that the material factor of 0,68 is applied to the following URs which have already used the material factor “*k*”. (Any amendment is not necessary.)
  - S7 : Minimum longitudinal strength standards
  - S8 : Bow doors and inner doors
  - S9 : Side shell doors and stern doors
  - S10 : Rudders, sole pieces and rudder horns (except for non-welded part as specified in S10.1.3.1 which uses material factor “*K*” (capitol letter))
  - S11 : Longitudinal strength standard
  - S12 : Side Structures in Single Side Skin Bulk Carriers (only for web height to thickness ratio and flange width to thickness ratio)
  - S31 : Renewal Criteria for Side Shell Frames and Brackets in Single Side Skin Bulk Carriers and Single Side Skin OBO Carriers not Built in accordance with UR S12 Rev.1 or subsequent revisions (only for web height to thickness ratio)

5. It is recognized that for other URs such as S18, S20, S21, etc., material characteristics for high-tensile steels are considered by using the yield stress of the material directly, and for future developed UR such consideration will be discussed separately from the agreed material factor.
6. The consideration for the local strength requirements in the usage of such high tensile steel, other than those specified in the above, still remains at each society's discretion.
7. For the terminology regarding "Yield stress", it is agreed that those in S4 are changed to "minimum yield stress" which is used in the most of URs concerning Strength of Ships (S) and Materials and Welding (W), including UR S11, temporarily, those used in all URs of "S" Series should be reviewed and corrected if necessary, after the harmonization of CSR.

#### **4. Amendment.**

The Hull Panel agreed to revise UR S4 so as to implement new material factor  $k$  of 0,68 for high tensile steel with minimum yield stress of 390 N/mm<sup>2</sup>.

#### **5. Source/Derivation of proposed interpretation**

N.A.

#### **6. Decision by voting**

N.A.

Submitted by Hull Panel Chairman  
13 March 2007

#### **Permanent Secretariat Note (3 April 2007):**

During GPG discussion KR reminded GPG of a previous proposal to delete 'with respect to longitudinal strength' from the title of UR S4 and this was agreed.

UR S4 (Rev.2) was adopted on 2 April 2007 (6221\_IGd).

## **Technical Background (TB) document for UR S4 (Rev.4 Apr 2017)**

### **1. Scope and objectives**

To revise UR S4 to remove reservation made by 7 IACS Members.

### **2. Engineering background for technical basis and rationale**

GPG requests Hull Panel to review the UR S4 based on a GPG member proposal.

### **3. Source/derivation of the proposed IACS Resolution**

None.

### **4. Summary of Changes intended for the revised Resolution**

The Hull Panel agreed to revise UR S4 according to the text proposed for the Rev 4.

### **5. Points of discussions or possible discussions**

The draft text was discussed during the HP26 meeting.

During the discussions, it was pointed that the conditions linking the application of  $k = 0.68$  with the moment of Inertia at the midship section was not relevant. The sentence "provided that the moment of inertia of the midship section is not less than:" and the subsequent parameter definitions ( $I_{min}$ ,  $L$ ,  $W_{min}$ ) were removed. The minimum inertia and the minimum section modulus conditions are respectively covered by UR S11 (Rev 8) and UR S7 (Rev 4) respectively.

For applying a consistency for the minimum yield strength, it was decided to replace  $Y$  with  $ReH$  which is used in other UR S.

Finally, LR confirmed they are satisfied with the wording relative to the fatigue assessment request for using a  $k$  value equal to 0.66, as this assessment is made according to the requirements of the Society.

### **6. Attachments if any**

None.

## UR S5 "Calculation of midship section moduli for conventional ship for ship's scantlings"

### Summary

Editorial correction of a unit.

### Part A. Revision History

Version no.	Approval date	Implementation date when applicable
Corr.1 (June 2019)	27 June 2019	-
Rev.1 (May 2010)	24 May 2010	-
NEW (1975)	<i>No record</i>	-

- **Corr.1 (June 2019)**

#### .1 Origin for Change:

- Suggestion by IACS member (PT56)

#### .2 Main Reason for Change:

Editorial error of the angle unit identified by PT56 and passed to Hull Panel. (Degree instead of degree Celsius)

#### .3 List of non-IACS Member classification societies contributing through the TC Forum and/or participating in IACS Working Group:

None.

#### .4 History of Decisions Made:

Unanimous agreement at HP29 meeting.

#### .5 Other Resolutions Changes

None

#### .6 Any hinderance to MASS, including any other new technologies:

None

#### .7 Dates:

Original proposal: *May 2015,* *made by Hull Panel PT56*  
 Panel Approval: 11 June 2019 (Ref: 19093\_PHb)  
 GPG Approval: 27 June 2019 (Ref: 19093\_IGd)

- **Rev.1 (May 2010)**

**.1 Origin for Change:**

- Based on IACS Requirement (*Common Structural Rules for Bulk Carriers and Double Hull Oil Tankers*)

**.2 Main Reason for Change:**

Following the introduction of the IACS Common Structural Rules for Bulk Carriers and Double Hull Oil Tankers, Hull Panel were tasked to review all the UR S files to consider whether or not they are applicable to ships covered by the CSR.

**.3 List of non-IACS Member classification societies contributing through the TC Forum and/or participating in IACS Working Group:**

None.

**.4 History of Decisions Made:**

After review it was decided that for CSR ships the requirements of UR S5 are superseded by those of the Common Structural Rules and therefore do not apply.

**.5 Other Resolutions Changes**

All UR S files, except UR S8, S9, S15, S16, S19, S22, S23, S30 and S31.

**.6 Dates:**

Original proposal: 2007, made by Hull Panel Task 50  
Panel submission to GPG: 19 April 2010  
GPG Approval: 24 May 2010 (Ref. 10051\_IGd)

- **NEW (1975)**

No TB document available.



## Part B. Technical Background

List of Technical Background (TB) documents for UR S5:



**Note:** *There are no separate Technical Background (TB) documents for the original resolution (1975), Rev. 1 (May 2010) and Corr. 1 (June 2019).*

## UR S6 "Use of Steel Grades for Various Hull Members - Ships of 90 m in Length and Above"

### Summary

Table 4 has been corrected, misspelling of 'sheer strake' and footnote for 'bilge strake'. Figure 1 has been improved.

### Part A. Revision History

Version no.	Approval date	Implementation date when applicable
Corr.2 (Nov 2021)	05 November 2021	-
Corr.1 (Mar 2021)	10 March 2021	-
Rev.9 (July 2018)	06 July 2018	1 July 2019
Rev.8 (Dec 2015)	11 December 2015	1 January 2017
Rev.7 (Apr 2013)	18 April 2013	1 July 2014
Rev.6 (May 2010)	24 May 2010	-
Rev.5 (Sept 2007)	18 September 2007	1 July 2008
Rev.4 (July 2003)	16 July 2003	-
Rev.3 (May 2002)	6 May 2002	-
Rev.2 (1996)	No record	-
Rev.1 (1980)	No record	-
New (1978)	No record	-

#### • Corr.2 (Nov 2021)

##### .1 Origin of Change:

Suggestion by HP-Chair

##### .2 Main Reason for Change:

A misspelling of 'sheer strake' in Table 4 has been corrected. Also, the footnote in Table 4 has been corrected so as to reflect the use of the correct grade for various strakes/plates ('stringer plate', 'sheer strake' and 'bilge strake'). The locations of 'stringer plate', 'sheer strake' and 'bilge strake' have been indicated in Figure 1.

##### .3 List of non-IACS Member Classification Societies contributing or participating in IACS Working Group:

None

##### .4 History of Decisions Made:

Correction was prepared by HP Chair and distributed to Hull Panel for Approval.

## **.5 Other Resolutions Changes**

None

## **.6 Any hinderance to MASS, including any other new technologies:**

None

## **.7 Dates:**

Original proposal : 04 October 2021 by Hull Panel  
Panel Approval : 20 October 2021 (Ref: PH21020\_IHd)  
GPG Approval : 05 November 2021 (Ref: 21025\_IGd)

## **• Corr.1 (Mar 2021)**

### **.1 Origin of Change:**

Suggestion by HP-Chair

### **.2 Main Reason for Change:**

The reference in description of Table 5 to SOLAS XII/6.5.3 needs to be updated based on changes in SOLAS via resolution MSC.216(82). In MSC.216/82) SOLAS XII/6.3 is deleted and the subsequent paragraphs renumbered so that the correct reference will become SOLAS XII/6.4.3.

### **.3 List of non-IACS Member Classification Societies contributing or participating in IACS Working Group:**

None

### **.4 History of Decisions Made:**

Correction was prepared by HP Chair and distributed to Hull Panel for Approval. To be more general, the reference is shortened to SOLAS XII/6.4

## **.5 Other Resolutions Changes**

None

## **.6 Any hinderance to MASS, including any other new technologies:**

None

## **.7 Dates:**

Original proposal : January 2021  
Panel Approval : 22 February 2021 (Ref: PH21003\_IHb)  
GPG Approval : 10 March 2021 (Ref: 21025\_IGb)

- **Rev.9 (July 2018)**

**.1 Origin of Change:**

- Suggestion by IACS Members

**.2 Main Reason for Change:**

This revision of UR S6 addresses two topics handled by the hull panel upon request from members.

UR S6.1 and 6.2 Limiting temperature:

The material requirements in CSR and UR S6.1 apply for design temperature down to -10°C and low temperature requirements in S6.2 apply for design temperature below -20°C. This leaves a gap with no clear requirements to material for ships having a design ambient temperature between -10°C and -20°C degrees. It was agreed to develop unified requirements to close to this gap. (Hull Panel ref PH16010)

UR S6.4 Cold Cargo for ships other than liquefied gas carriers:

CSR OT and CSR BC&OT includes an assumption about cargo temperature between 0°C and 80°C, ref. CSR Pt 1 Ch 1 Sec 1 [1.3.2]. In general bulk carriers and tankers are occasionally loading cargos with temperature below 0°C, and it has been questioned if additional requirements should apply. The Hull Panel therefore agreed to develop unified requirements for cold cargoes for introduction in UR S6 (Hull Panel ref. PH14005) for ships other than liquefied gas carriers.

**.3 List of non-IACS Member Classification Societies contributing through the TC Forum and/or participating in IACS Working Group:**

None.

**.4 History of Decisions Made:**

This update address the identified gap in the requirements covering the temperature range between -10°C and -20°C.

In addition, material requirements are introduced for cargo tank boundaries on tanks designed for carriage of cold cargo.

The technical background for these changes is included in Annex 6.

**.5 Other Resolutions Changes**

None.

**.6 Dates:**

Original proposal: September 2017  
Panel Approval: 13 June 2018 (Ref: PH14005)  
GPG Approval: 06 July 2018 ( 18083\_IGd)

- **Rev.8 (Dec 2015)**

**.1 Origin for Change:**

- Suggestion by IACS Member

**.2 Main Reason for Change:**

The Polar Code defines the Polar Service Temperature using lowest mean daily low temperature whereas the design temperature defined in UR S6 is based on the lowest mean daily average temperature. Hence the relationship between the design temperature in UR S6 and the Polar Service Temperature needs to be established.

In addition, a question was raised in the Hull Panel regarding the need to clarify which structures are exposed to low air temperatures when applying the material classes and grades given in Table 8.

**.3 List of non-IACS Member classification societies contributing through the TC Forum and/or participating in IACS Working Group:**

None.

**.4 History of Decisions Made:**

PT61 carried out an investigation to determine the statistical difference between the lowest mean daily average temperature and the lowest mean daily low temperature. This was then related to the Polar Service Temperature which is to be taken as 10 degrees below the lowest mean daily low temperature. Hence, the design temperature is to be taken as being no greater than 13 degrees Celsius higher than the Polar Service Temperature.

Regarding internal structure exposed to low air temperatures, after discussion within the Hull Panel, it was decided that it is only necessary to consider the outermost stake of plating of internal structure connected with the hull envelope as being exposed to low air temperatures.

**.5 Other Resolutions Changes**

None

**.6 Dates:**

Original proposal: 21 August 2015, made by PT61 & Hull Panel Chairman  
Panel submission to GPG: 23 November 2015 (Ref: PH15005)  
GPG Approval: 11 December 2015 (Ref: 13180a)

- **Rev.7 (Apr 2013)**

**.1 Origin for Change:**

- Suggestion by IACS Member

## **.2 Main Reason for Change:**

A question was raised in the Hull Panel regarding the applicability of Table 2 of UR S6 to Liquefied Natural Gas (LNG) Carriers.

See TB document in Part B.

## **.3 List of non-IACS Member classification societies contributing through the TC Forum and/or participating in IACS Working Group:**

None.

## **.4 History of Decisions Made:**

After discussion within the Hull Panel, it was decided that Table 2 of UR S6 could lead to inconsistencies when applied to LNG Carriers. Therefore, a new Table was added to provide the minimum material grades for LNG Carriers and an addition was made to Table 1, item C5.1. In addition, Table 1, items B3 and C8 were clarified and editorial changes were made to the text in UR S6.1.

## **.5 Other Resolutions Changes**

None

## **.6 Dates:**

Original proposal: *23 October 2012, made by Hull Panel Chairman*  
Panel submission to GPG: *25 January 2013*  
GPG Approval: *18 April 2013 (Ref. 13039\_IGe)*

## **• Rev.6 (May 2010)**

### **.1 Origin for Change:**

- Based on IACS Requirement (*Common Structural Rules for Bulk Carriers and Double Hull Oil Tankers*)

### **.2 Main Reason for Change:**

Following the introduction of the IACS Common Structural Rules for Bulk Carriers and Double Hull Oil Tankers, Hull Panel were tasked to review all the UR S files to consider whether or not they are applicable to ships covered by the CSR.

### **.3 List of non-IACS Member classification societies contributing through the TC Forum and/or participating in IACS Working Group:**

None.

### **.4 History of Decisions Made:**

After review it was decided that for CSR ships the requirements of UR S6 are superseded by those of the Common Structural Rules and therefore do not apply.

## **.5 Other Resolutions Changes**

All UR S files, except UR S8, S9, S15, S16, S19, S22, S23, S30 and S31.

## **.6 Dates:**

Original proposal: *2007, made by Hull Panel Task 50*  
Panel submission to GPG: *19 April 2010*  
GPG Approval: *24 May 2010 (Ref. 10051\_IGd)*

- **Rev.5 (Sept 2007)**

Hull Panel Task 17 – *Review of UR S6 for side shell plating exposed to low temperatures.*

See TB document in Part B.

- **Rev.4 (July 2003)**

See TB document in Part B.

- **Rev.3 (May 2002)**

See TB document in Part B.

- **Rev.2 (1996)**

No TB document available.

- **Rev.1 (1980)**

No TB document available.

- **New (1978)**

No TB document available.

## Part B. Technical Background

List of Technical Background (TB) documents for UR S6:

Annex 1. **TB for Rev.3 (May 2002)**

See separate TB document in Annex 1.

Annex 2. **TB for Rev.4 (July 2003)**

See separate TB document in Annex 2.

Annex 3. **TB for Rev.5 (Sept 2007)**

See separate TB document in Annex 3.

Annex 4. **TB for Rev.7 (Apr 2013)**

See separate TB document in Annex 4.

Annex 5. **TB for Rev.8 (Dec 2015)**

See separate TB document in Annex 5.

Annex 6. **TB for Rev.9 (July 2018)**

See separate TB document in Annex 6.



**Note:** *There are no separate Technical Background (TB) documents for New (1978), Rev.1 (1980), Rev.2 (1996), Rev.6 (May 2010), Corr.1 (Mar 2021) and Corr.2 (Nov 2021)*



**(UR S6, Rev.3, May 2002)**  
**Technical Background to changes proposed with respect to Table 1 of UR S6**

The objective of the attached proposal is to clarify the application of the Notes of Table 1 in UR S6, in order to avoid different interpretations on their application, in particular for what concerns the plating at corners of large hatch openings.

It is now clarified that “large hatch openings” are to be intended as the “cargo hatch openings” in the strength deck and the relevant requirements are now specified. A distinction is made between ships such as container carriers and bulk/ore carriers. For these latter, less stringent requirements may be applied in the region outside 0,6L amidships based on the fact that lower hull girder stresses occur in this area.

The application to continuous hatch coamings has been clarified by introducing a length criterium (0,15L, above which coamings are considered as being subjected to hull girder stresses). Requirements for the steel grades of end brackets and deck house transition of longitudinal cargo hatch coamings have been introduced, based on damage statistics results.

The change was agreed unanimously and no unresolved issues remain..

Submitted by WP/S Chairman  
Date: 14 March 2002

**Technical Background**  
**S6.1 in Rev. 4 of UR S6**

The objective of the attached proposal is to clarify that the minimum width requirement of single strakes ( $800 + 5 \cdot L$  mm, need not be greater than 1800 mm) applies to those strakes located at the four corners of the ship's cross section, plus deck strakes on top of longitudinal bulkheads.

In addition, the fact that ship's geometry may impose limitations to the width of the above strakes (e.g. in some containerships), is taken into account.

## TECHNICAL BACKGROUND

### UR S6, REV.5 (SEPT 2007)

#### *IACS HULL PANEL TASK 17 - 'Review of UR S6 for side shell plating exposed to low temperatures'*

#### **1. Scope and objective**

Consider requirements on selection of steel grades, with a view to preventing brittle fracture in the side shell plating of ships operating in areas with low air temperatures.

#### **2. Background**

Transportation Safety Board of Canada reports and correspondence with IACS concerning hull fractures in the 'Lake Carling' and its sister ship 'Ziemia Gornoslaska'. The TSB expressed concern over the current requirements of UR S6 for side shell plating which it did not consider adequate for ships operating near or below 0°C.

#### **3. Points of discussions/Analysis**

##### **3.1 General**

The brittle fracture damage of MV 'Lake Carling' and analyses done in connection to this incident have been pointing at the following main issues:

- Application of material for side shell
- Material grade requirements for materials subjected to lower temperatures
- Stress level
- Consequence of brittle failure

##### **3.2 Analysis**

The issue of steel toughness requirements, or to be more accurate lack of measured steel toughness requirements for normal strength ship steel grade A ship steel, has been raised as a major issue within both IACS and IMO by the Transport Safety Board of Canada. They based their assumptions on the brittle fracture that occurred in 19 mm grade A plate of the side shell of MV 'Lake Carling' which initiated at a temperature of approximately 0°C (fracture initiated below the water line and is therefore assumed to be near 0°C, air temperature was minus 6°C).

Earlier, IACS WP/MW was asked to review the IACS testing requirements for normal strength ship steel grade A, which presently has no requirement for Charpy V-notch impact testing the steel mill. The working party reported back and quite rightly confirmed that there is no need to change the current test arrangements. It is more correct to consider changes to the requirements selecting the grade of material to be used, in this case IACS UR S6.

Lloyd's Register has recently taken the opportunity, with the kind permission of the Transport Safety Board of Canada, to carry out further tests on steel plate taken from the 'Lake Carling' and its sister ship the 'Ziemia Gornoslaska'; these have not been too encouraging, see the table shown below.

Steel Source	Lake Carling	Z Gornoslaska <sup>1</sup>
Charpy V-notch 27J transition temperature	L= +10°C T= +10°C	L= +20°C
Fracture appearance transition temperature FATT (50% Crystalline)	L= +10°C T= +15°C	L= +15°C
FATT (70% Crystalline)	L= -5°C	L= +5°C
Minimum CTOD (BS 7448) @ -19°C	0.01 mm	
Minimum CTOD (BS 7448) @ 0°C	0.25 mm	
Note 1, Z Gornoslaska is a sister ship to the Lake Carling.		

IACS UR S6.1 was developed based on world wide service using a lowest mean daily average temperature of -10°C. Areas of navigation to this temperature are given in statistical tables and charts such as the "Pilot" series of publications published by Hydrographer of the Navy or other authoritative reference, see Figure 1 as an example. This temperature for example, allows for navigation in the Northern Baltic and the St. Lawrence.

Therefore IACS UR S6, will allow the use of grade A steel as follows;

*Class I, grade A up to 30 mm at temperatures down to -10°C*

*Class II, grade A up to 20 mm at temperatures down to -10°C and grade B up to 25 mm at temperatures down to -10°C*

*Class III, grade A up to 15 mm at temperatures down to -10°C and grade B up to 20 mm at temperatures down to -10°C.*

This indicates that the current rule IACS UR S6 allows the use of non-impact tested steel in **greater** thicknesses and to a **lower** temperature than that involved in the Lake Carling incident. Thickness increase and lower temperature each increase the risk of brittle fracture.

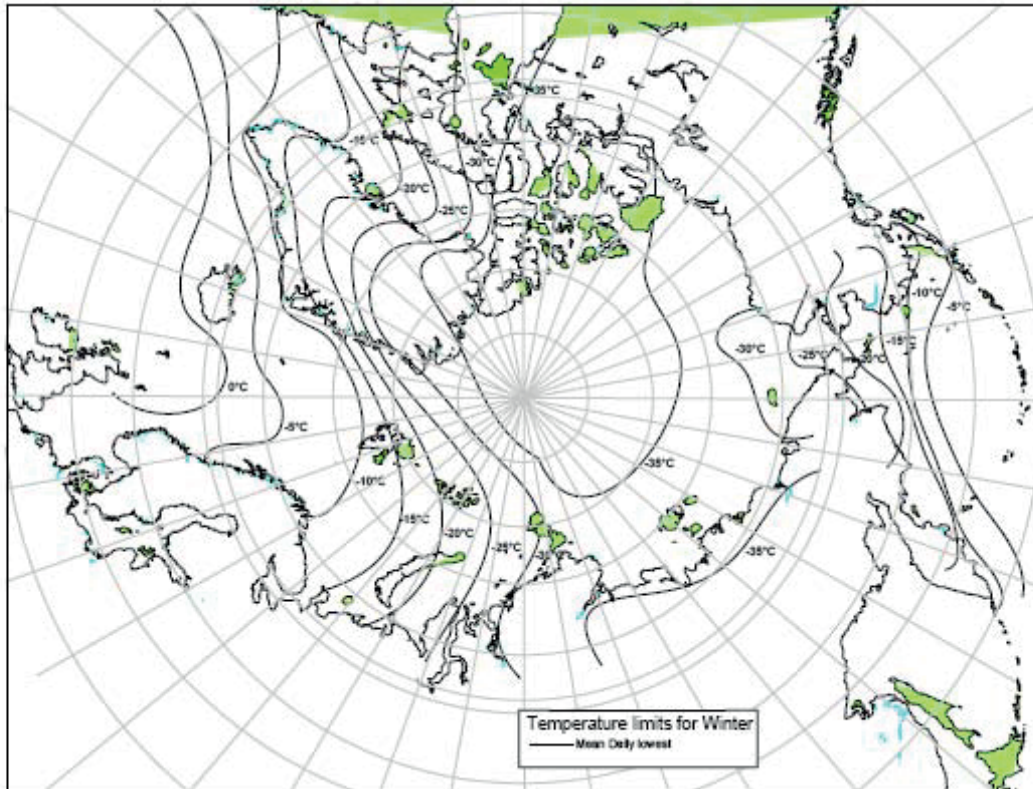


Chart based on temperature data points from Admiralty Pilot Books, published by HMSO

Figure 1 – Example of Navigation Chart based on Temperature

#### 4. Proposed upgrading

In the proposed revision Table 1 is revised into Tables 1 to 5 for easier interpretation.

The following areas are upgraded to minimum grade B/AH regardless of Class:

a) For ships with length exceeding 150 m and with single strength deck and without inner continuous longitudinal bulkhead(s) between bottom and the strength deck, single side strakes in way of cargo hold:

- High shear stresses
- Serious consequences (flooding/reduced hull girder capacity) of brittle failure

b) Shell strakes in way of ice strengthening:

- High ice pressures and impacts from collision with ice resulting in high stresses, high strain rates and possible plastic deformation at temperatures close to (below or equal) 0° C.

c) For vessels with length exceeding 150 m and with single strength deck, within 0.4L amidships, for longitudinal strength members of strength deck plating and continuous longitudinal members above strength deck, excluding hatch coamings, as these members may be:

- Subjected to high hull girder tensile stresses
- Subjected to temperatures down to -10° C
- critical / brittle fracture may have serious consequences for the hull girder integrity

In addition is the new requirement for single side shell strakes and lower bracket in way of single side (D/DH) as given in CSR for bulk carriers also included.

**“S6.1 Ships in normal world wide service**

Materials in the various strength members are not to be of lower grade than those corresponding to the material classes and grades specified in Table 1 through Table 6. General requirements are given in Table 1, while additional minimum requirements for ships with length exceeding 150m and 250m, bulk carriers subject to the requirements of SOLAS regulation XII/6.5.3, and ships with ice strengthening are given in Table 2 through Table 5. The material grade requirements for hull members of each class depending on the thickness are defined in Table 6.

**Table 1 – Material Classes and Grades for ships in general**

<b>Structural member category</b>	<b>Material class/grade</b>
<u>SECONDARY:</u> A1. Longitudinal bulkhead strakes, other than that belonging to the Primary category A2. Deck plating exposed to weather, other than that belonging to the Primary or Special category A3. Side plating	- Class I within 0.4L amidships - Grade A/AH outside 0.4L amidships
<u>PRIMARY:</u> B1. Bottom plating, including keel plate B2. Strength deck plating, excluding that belonging to the Special category B3. Continuous longitudinal members above strength deck, excluding hatch coamings B4. Uppermost strake in longitudinal bulkhead B5. Vertical strake (hatch side girder) and uppermost sloped strake in top wing tank	- Class II within 0.4L amidships - Grade A/AH outside 0.4L amidships
<u>SPECIAL:</u> C1. Sheer strake at strength deck (*) C2. Stringer plate in strength deck (*) C3. Deck strake at longitudinal bulkhead, excluding deck plating in way of inner-skin bulkhead of double-hull ships (*)	- Class III within 0.4L amidships - Class II outside 0.4L amidships - Class I outside 0.6L amidships
C4. Strength deck plating at outboard corners of cargo hatch openings in container carriers and other ships with similar hatch opening configurations	- Class III within 0.4L amidships - Class II outside 0.4L amidships - Class I outside 0.6L amidships - Min. Class III within cargo region
C5. Strength deck plating at corners of cargo hatch openings in bulk carriers, ore carriers, combination carriers and other ships with similar hatch opening configurations	- Class III within 0.6L amidships - Class II within rest of cargo region

C6. Bilge strake in ships with double bottom over the full breadth and length less than 150m (*)	- Class II within 0.6L amidships - Class I outside 0.6L amidships
C7. Bilge strake in other ships (*)	- Class III within 0.4L amidships - Class II outside 0.4L amidships - Class I outside 0.6L amidships
C8. Longitudinal hatch coamings of length greater than 0.15L C9. End brackets and deck house transition of longitudinal cargo hatch coamings	- Class III within 0.4L amidships - Class II outside 0.4L amidships - Class I outside 0.6L amidships - Not to be less than Grade D/DH

(\*) Single strakes required to be of class III within 0.4L amidships are to have breadths not less than  $800+5L$  (mm), need not be greater than 1800 (mm), unless limited by the geometry of the ship's design.

**Table 2 – Minimum Material Grades for ships with length exceeding 150m and single strength deck**

<b>Structural member category</b>	<b>Material grade</b>
<u>Longitudinal strength members of strength deck plating</u>	<u>Grade B/AH within 0.4L amidships</u>
<u>Continuous longitudinal strength members above strength deck</u>	<u>Grade B/AH within 0.4L amidships</u>
<u>Single side strakes for ships without inner continuous longitudinal bulkhead(s) between bottom and the strength deck</u>	<u>Grade B/AH within cargo region</u>

**Table 3 – Minimum Material Grades for ships with length exceeding 250m**

<b>Structural member category</b>	<b>Material grade</b>
Shear strake at strength deck (*)	Grade E/EH within 0.4L amidships
Stringer plate in strength deck (*)	Grade E/EH within 0.4L amidships
Bilge strake (*)	Grade D/DH within 0.4L amidships

(\*) Single strakes required to be of grade E/EH and within 0.4L amidships are to have breadths not less than  $800+5L$  (mm), need not be greater than 1800 (mm), unless limited by the geometry of the ship's design.

**Table 4 – Minimum Material Grades for single-side skin bulk carriers subjected to SOLAS regulation XII/6.5.3**

<b>Structural member category</b>	<b>Material grade</b>
<u>Lower bracket of ordinary side frame (*),(**)</u>	<u>Grade D/DH</u>
<u>Side shell strakes included totally or partially</u>	<u>Grade D/DH</u>



<u>between the two points located to 0.125 ℓ above and below the intersection of side shell and bilge hopper sloping plate or inner bottom plate (**)</u>	
---	--

(\*) The term of "lower bracket" means webs of lower brackets and webs of the lower part of side frames up to the point of 0.125 ℓ above the intersection of side shell and bilge hopper sloping plate or inner bottom plate.

(\*\*) The span of the side frame, ℓ, is defined as the distance between the supporting structures.

**Table 5 – Minimum Material Grades for ships with ice strengthening**

<b>Structural member category</b>	<b>Material grade</b>
<u>Shell strakes in way of ice strengthening area for plates</u>	<u>Grade B/AH</u>

**Table 6 – Material Grades Requirements for Classes I, II and III**

.....”

**5. Source/Derivation of proposed interpretation**

N.A.

**6. Decision by voting**

N.A.

Submitted by Hull Panel Chairman  
20 July 2007

**Permanent Secretariat note (September 2007):**

Adopted by GPG 18 September 2007, ref. 7632\_IGb, with an effective date of 1 July 2008.



## Technical Background Document for UR S6 (Rev. 7 Apr 2013)

### 1. Objective/Scope

The objective of this revision is to clarify the scope of application with regard to LNG Carriers, and to identify the minimum steel grades for selected structures on LNG Carriers. Table 2 is clarified and a new Table 3 is added for LNG Carriers.

### 2. Source of Proposed Requirements

The proposed requirements are based on the technical justifications for the current requirements, current practice within industry, and discussion within the Hull Panel (via correspondence and at Hull Panel Meetings).

### 3. Technical Basis and Rationale

In general, the proposed revisions reflect the industry practice.

Regarding Table 2, the current practice is to not apply Table 2 to the longitudinal strength members located above the strength deck of LNG carriers. Four (4) LNG carriers with lengths greater than 150 meters were examined and a table of the material grades for plating of the strength deck and above is shown in as follows. These LNG carriers have higher grade steel in the strength deck, inner deck and deck girders that can be attributed to the need for higher grade steel along the tank boundary. However, most of the vessels have low grade steel in the trunk deck that is lower than the minimum material grade in Table 2. This indicates that Table 2 is not being applied in way of the "double deck" area.

Vessel		A	B	C	D
Length (m)		332	278	266	205
Material Grade	Strength Deck Plating	E	E	E	E
	Trunk Deck Plating	A, B	A,D	A	D
	Inner Deck Plating	DH, E	E	E <sup>2</sup>	E
	Deck Girders	E	E, E <sup>1</sup>	E, E <sup>2</sup>	E

Notes:

1. Steel Quality Z25
2. Grade E Steel having improved weld toughness.

Therefore, the proposal is based on the following:

- 1) Although LNG carriers have a single strength deck, the trunk deck and inner deck can be considered a "double deck" and therefore Table 2 does not apply.
- 2) The inner deck will have a high material grade due to its nature as a cargo tank boundary. Similar to the inner deck, the deck girders are generally of a higher grade steel. However, in case of an unusual design, a minimum material grade should be set for the inner deck and deck girders.
- 3) A minimum material grade is required for the portions of the strength deck contributing to the longitudinal strength to provide a level of toughness to reduce the likelihood of crack initiation, as indicated in the Technical Background to Rev. 5.
- 4) As the material class indicated in Item B3 of Table 1 is acceptable and common practice, an additional minimum material grade is not required for the trunk deck.

- 5) The higher grade of the strength deck and deck girders may provide some crack arresting for the trunk deck.

An additional review of twenty-eight LNG carriers with delivery dates from 2005 to 2013 showed that the material of the trunk deck and inner deck plating at corners of liquid dome openings is E or EH grade in all vessels due to these corners being high stress areas. Therefore, a new item was added to Table 1 to account for this.

#### 4. Summary of Changes

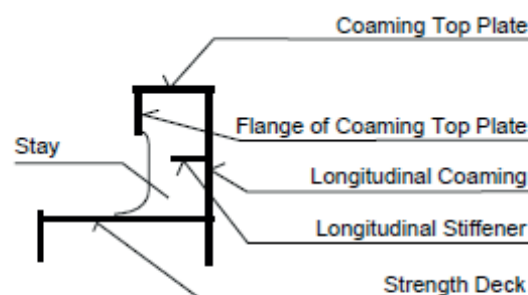
##### 4.1 Clarification of the scope of application for Table 2

A note is added for Table 2, indicating that it does not apply LNG carriers which are covered by a new Table 3 (mainly membrane-type LNG carriers).

##### 4.2 Clarification of the Structural member category

Structural member categories were modified in Tables 1 (item B3) and 2 to clarify that the steel grade applies to the plating only. The detail requirements in all Tables of UR S6 are only applicable to plating and not to the attached stiffeners. Note, the material grade requirements for stiffeners fall under the statement in UR S6 "For strength members not mentioned in Tables 1 to 6, Grade A/AH may generally be used." The only exceptions where stiffeners are explicitly covered in UR S6 are follows:

- (a) Table 1, C8, the hatch coaming consist of the vertical coaming plating and the horizontal coaming top plate and the top plate flange. See the following figure.



Transverse Section of Longitudinal Coaming for Container Vessels

- (b) Table 5 (of Rev 7), for "Lower bracket of ordinary side frame", clearly applies to vertical "stiffeners" that make up the side frame of bulk carriers.

##### 4.3 Insertion of new table and figure

As a result of the clarification to the scope of application of Table 2 as indicated in 4.1 and 4.2 above, a new table was added to identify the minimum steel grades of LNG carriers (mainly membrane-type LNG carriers). This table has been inserted as a new Table 3. In addition, a figure was added to identify the three decks used in Table 3 to define the structural member categories. This figure has been inserted as a new Figure 1.

##### 4.4 Addition to Table 1, item C5.1

A new item was added as item C5.1 to indicate that the highly stressed corners of the trunk deck and inner deck plating of the liquid dome openings of LNG carriers requires a higher class/grade of steel, similar to how higher grade steel is need at the corners of cargo hatch openings on bulk carriers.

#### 4.5 Removal of footnote mark (\*) from Table 1, item C6

The reference in Table 1, item C6 to the footnote was removed since the footnote is not applicable to this item.

#### 4.6 Clarification of Table 1, item C8

Text was added to Table 1, item C8 to clarify that that the minimum material grade or class is also applicable to the coaming top plate and flange of longitudinal hatch coamings.

#### 4.7 Reorganization of text for UR S6.1

Two paragraphs of UR S6.1, which were previously located after the Tables 1-7, were moved ahead of the tables to make them more visible. The first paragraph was reorganized into a list to clearly identify each table and text was added to identify the new Table 3. For clarify, the second sentence in the third paragraph of S6.1 was amended.

#### 4.8 Correction of table and figure numbering and references

The table and figure numbering and references through the UR S6 were corrected as necessary.

### 5. Points of Discussion

Prior to the proposed revision, points of discussion were:

- (a) The applicability (or non-applicability) of Table 2 to LNG carriers
- (b) Technical justification of Table 2 (for ships with  $L > 150\text{m}$ )
- (c) Technical justification of Table 3 (for ships with  $L > 250\text{m}$ )

Following the proposed revision, points of discussion were:

- (a) Structural member category
  - The original wording is not clear and could be confusing. It is intended that the material grade requirements in UR S6 are applicable to the plating and not the longitudinal stiffeners. The reason for requiring the enhanced material grade of plating in certain locations is to act as crack arresters within the hull girder of the vessel.
- (b) Application of Table 3
  - Table 3 is applicable to membrane type gas carriers only. Gas Carriers with other containment designs, such as the MOSS spherical tank design, would apply Table 2.
- (c) Scope of new Item C5.1 in table 1
- (d) Minimum material grade for Stiffeners on longitudinal hatch coamings of length greater than  $0.15L$

**6. Attachments, if any**

None

Submitted by Hull Panel Chairman  
*25-Jan-2013*

\*\*\*

## **Technical Background (TB) document for UR S6 (Rev.8 Dec 2015)**

### **1. Scope and objectives**

The objective of this revision is to establish the relationship between the Polar Service Temperature and the IACS design temperature defined in UR S6.

In addition, a question was raised in the Hull Panel regarding the need to clarify which structures are exposed to low air temperatures when applying the material classes and grades given in Table 8.

### **2. Engineering background for technical basis and rationale**

See attachment for basis of revisions to design temperature.

It was decided that while internal structure is not directly exposed to low air temperatures, it is affected by low air temperatures where it is connected to the hull envelope. Hence, the strake of plating which is attached to the hull envelope is to be considered as being exposed to low air temperatures. However, in order to prevent a very narrow strake being used, it was considered prudent to include a minimum requirement for the width of the strake under consideration. 600 mm was chosen as this minimum requirement as UR I2 uses 600 mm when determining whether a contiguous inboard framing member in the vicinity of inboard framing members exposed to the environment should be required to be material class I.

### **3. Source/derivation of the proposed IACS Resolution**

The proposed requirements are based on an investigation carried out by PT61 based on temperature data which was submitted to the IMO during the development of the Polar Code.

The issue of internal structures being exposed to low air temperatures was discussed within the Hull Panel.

### **4. Summary of Changes intended for the revised Resolution:**

S6.2 Clarification of the scope of application for Table 8

A note has been added to Table 8 indicating that only the outermost strake of internal plating is to be considered as being exposed to low air temperatures.

S6.3 Re-definition of design temperature

For the purpose of assigning a Polar Class certificate in accordance with the Polar Code, the design temperature has been re-defined such that it relates to the Polar Service Temperature.

In addition, the statistical mean observation period used to derive the temperature has been aligned with the Polar Code.

Figure 2 has been updated.

## **5. Points of discussions or possible discussions**

The amendments relating to temperature were discussed within PT61 and reviewed by the Hull Panel.

The amendments relating to internal structure exposed to low air temperature were discussed within the Hull Panel with the main discussion point as follows:

- a) Under what circumstances internal structure would be exposed to low air temperatures. In Rev. 7, the internal bulkheads above the ballast waterline were considered to be exposed but this was considered to be unrealistic and unnecessarily onerous. Following consultation with the Chair of EG/M&W who was of the opinion that there would be some thermal transfer between the hull envelope plating and the internal structure, it was decided that the strake of plating attached to the hull envelope should be considered as being exposed to low air temperatures but that the requirements could be relaxed for the rest of the internal structure.

## **6. Attachments, if any**

Recommended Changes of IACS Standards to incorporate the Polar Service Temperature defined in Polar Code

**Recommended Changes of IACS Standards to incorporate  
the Polar Service Temperature defined in Polar Code**

**August 2015**

IACS Hull Panel PT61

## Contents

1.	Overview .....	3
2.	Objective .....	3
3.	Temperature Referenced in Polar Code IACS UR S6 .....	4
A.	Definition of Temperatures in Polar Code .....	4
B.	Additional Guidance to the Definition of Temperatures in Polar Code .....	4
C.	Polar Code Clauses which Refer to the Polar Service Temperature (PST) .....	5
D.	Current IACS UR S6 Use of steel grades for various hull members - ships of 90 m in length and above .....	7
4.	Relationship between MDAT and MDLT .....	8
A.	Temperature data of Polar and Sub-polar Regions Submitted by Canada .....	8
B.	Temperature data of Antarctic Station Submitted by Argentina .....	13
C.	Temperature data from ABS Guide for Vessels Operating in Low Temperature Environments (2015) .....	15
5.	Conclusion and Recommendations .....	19
A.	Recommendation for changes of UR S6.3 .....	19
B.	Recommendations to IACS panels and working groups .....	19

## List of Figures

Figure 1	Location of weather monitoring stations .....	8
Figure 2	Difference of MDAT and MDLT at Reporting Stations, calculated using temperature data from SDC 1/INF.12 .....	11
Figure 3	Geographical Variation of Difference between MDAT and MDLT, calculated using temperature data from SDC 1/INF.12 .....	12
Figure 4	Monthly variation of difference between MDAT and MDLT, calculated using temperature data from SDC 1/INF.12 .....	12
Figure 5	Location of Carlini Base in the Antarctic .....	13
Figure 6	Difference of monthly average MDAT and MDLT at Carlini Base (2001-2010) .....	14
Figure 7	Location of the selected Arctic stations .....	15
Figure 8	Difference between MDAT and MDLT at Reporting Stations, ABS LTE Guide .....	17
Figure 9	Geographical Variation of the Difference between MDAT and MDLT, ABS LTE Guide .....	17
Figure 10	Seasonal variation of difference between MDAT and MDLT, ABS LTE Guide .....	18

## List of Tables

Table 1	Temperature Data submitted by Canada, from SDC 1/INF.12 .....	9
Table 2	Difference between the MDAT and MDLT at reporting stations, calculated using temperature data from SDC 1/INF.12 .....	11
Table 3	Monthly Average MDAT, MDLT and the difference at Carlini Base (2001-2010) .....	13
Table 4	Difference of MDAT and MDLT on the 1st and 15th of each month, ABS LTE Guide .....	16



# Recommended Changes of IACS Standards to incorporate the Polar Service Temperature defined in Polar Code

## 1. Overview

The International Code for Ships Operating in Polar Waters (Polar Code) has been developed to supplement existing IMO instruments. The goal of the Polar Code is to provide for safe ship operation and the protection of the polar environment by addressing risks present in polar waters and not adequately mitigated by other IMO instruments. The Polar Code is to be implemented by adopting changes to the existing requirements of the International Convention for the Safety of Life at Sea (SOLAS), the International Convention for the Prevention of Pollution from Ships (MARPOL) and other relevant binding IMO instruments.

The key principles for developing the Polar Code have been to use a risk-based approach in determining scope and to adopt a holistic approach in reducing identified risks. The Polar Code considers hazards which may lead to elevated levels of risk. The risk level within polar waters may differ depending on the geographical location, time of the year with respect to daylight, ice-coverage, etc. Thus, the mitigating measures required to address the above specific hazards may vary within polar waters.

Low air temperature is identified as a hazard as it affects the working environment and human performance, maintenance and emergency preparedness tasks, material properties and equipment efficiency, survival time and performance of safety equipment and systems.

The Polar Code defines Polar Service Temperature (PST) as a temperature specified at least 10°C below the lowest mean daily low temperature (MDLT) for the intended area and season of operation in polar waters. Ships will be required to list the PST on the Polar Ship Certificate if intending to operate in polar water areas and seasons where the MDLT is less than 10°C and materials of hull structures and machinery are to be certified according to the PST. Furthermore ship systems and equipment are required by the code to be fully functional at the polar service temperature. IACS, as a recognized organization approved by the Administration, needs to incorporate the PST into its standards such that as its member societies can provide consistent classification and certification for Polar Code compliant ships.

This document is prepared to establish the relationship between the MDLT and IACS design temperature,  $t_D$ , defined in UR S6, and to make recommendations how the PST can be introduced to the existing IACS requirements for ships operating in Polar waters.

## 2. Objective

The main objective of this study is to prepare the recommendation for changes to IACS UR S6.3 to incorporate the Polar Service Temperature (PST) that can be used in selecting the required steel grade for ships operating in low air temperature environments.

The Polar Code also requires ship system and equipment to be fully functional at the PST. A complete list of clauses of Polar Code is compiled that make reference to Polar Service Temperature (PST). This list is to be reviewed by relevant IACS Panel or working group to develop the implementation plans, if necessary.

### 3. Temperature Referenced in Polar Code IACS UR S6

#### A. Definition of Temperatures in Polar Code

The following terminologies are defined in the Polar Code.

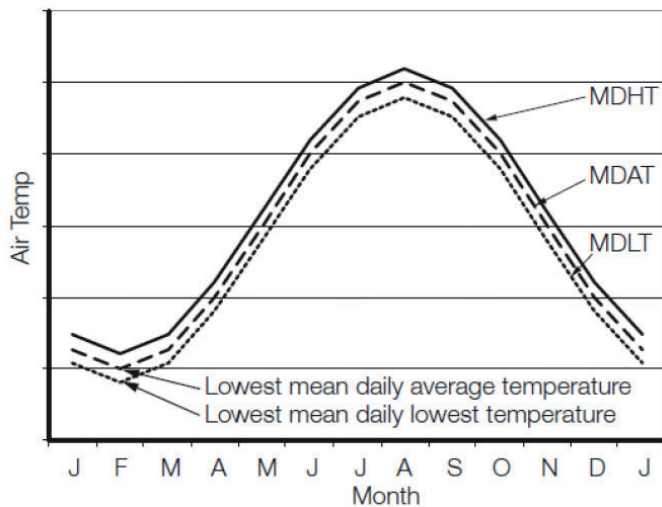
1.2.9 *Mean Daily Low Temperature (MDLT)* means the mean value of the daily low temperature for each day of the year over a minimum 10 year period. A data set acceptable to the Administration may be used if 10 years of data is not available.

1.2.11 *Polar Service Temperature (PST)* means a temperature specified for a ship which is intended to operate in low air temperature, which shall be set at least 10°C below the lowest MDLT for the intended area and season of operation in polar waters.

1.2.12 *Ship intended to operate in low air temperature* means a ship which is intended to undertake voyages to or through areas where the lowest Mean Daily Low Temperature (MDLT) is below -10°C.

#### B. Additional Guidance to the Definition of Temperatures in Polar Code

##### PART I-B ADDITIONAL GUIDANCE REGARDING THE PROVISIONS OF THE INTRODUCTION AND PART I-A 1 ADDITIONAL GUIDANCE TO SECTION 2 (DEFINITIONS) OF THE INTRODUCTION



Definitions used in the figure above

- MDHT – Mean Daily High Temperature
- MDAT – Mean Daily Average Temperature
- MDLT – Mean Daily Low Temperature

Guidance instructions for determining MDLT:

- 1 Determine the daily low temperature for each day for a 10 year period.
- 2 Determine the average of the values over the 10 year period for each day.
- 3 Plot the daily averages over the year.
- 4 Take the lowest of the averages for the season of operation.

## C. Polar Code Clauses which Refer to the Polar Service Temperature (PST)

The following list provides the relevant section heading and clauses that make reference to the polar service temperature (PST).

### PART I-A, SAFETY MEASURES,

#### CHAPTER 1 – GENERAL

##### 1.4 Performance standards

- 1.4.1 Unless expressly provided otherwise, ship systems and equipment addressed in this Code shall satisfy at least the same performance standards referred to in SOLAS.
- 1.4.2 For ships operating in low air temperature, a polar service temperature (PST) shall be specified and shall be at least 10°C below the lowest MDLT for the intended area and season of operation in polar waters. Systems and equipment required by this Code shall be fully functional at the polar service temperature.
- 1.4.3 For ships operating in low air temperature, survival systems and equipment shall be fully operational at the polar service temperature during the maximum expected rescue time.

#### CHAPTER 3 – SHIP STRUCTURE

##### 3.2 Functional requirements

In order to achieve the goal set out in paragraph 3.1 above, the following functional requirements are embodied in the regulations of this chapter:

- .1 for ships intended to operate in low air temperature, materials used shall be suitable for operation at the ships polar service temperature; and
- .2 in ice strengthened ships, the structure of the ship shall be designed to resist both global and local structural loads anticipated under the foreseen ice conditions.

##### 3.3 Regulations

3.3.1 In order to comply with the functional requirements of paragraph 3.2.1 above, materials of exposed structures in ships shall be approved by the Administration, or a recognized organization accepted by it, taking into account standards acceptable to the Organization<sup>6</sup> or other standards offering an equivalent level of safety based on the polar service temperature.

Foot Note 6 Refer to IACS UR S6 Use of Steel Grades for Various Hull Members – Ships of 90 m in Length and Above (latest version) or IACS URI Requirements concerning Polar Class (latest version), as applicable.

#### CHAPTER 6 – MACHINERY INSTALLATIONS

##### 6.2 Functional requirements

- 6.2.1.2 In addition, for ships intended to operate in low air temperatures:
  - .2 materials used shall be suitable for operation at the ships polar service temperature.
- 6.3.2 In addition, for ships intended to operate in low air temperatures, the following apply:
  - .1 in order to comply with the functional requirement of paragraph 6.2.1.2 above, exposed machinery and electrical installation and appliances shall function at the polar service temperature;

- .3 in order to comply with the functional requirements of paragraph 6.2.1.2.2 above, materials of exposed machinery and foundations shall be approved by the Administration, or a recognized organization accepted by it, taking into account standards acceptable to the Organization<sup>10, 11</sup> or other standards offering an equivalent level of safety based on the polar service temperature.

Foot Note 10 Refer to Polar Class 1-5 of IACS URI Requirements concerning Polar Class (2011)

Foot Note 11 Refer to Polar Class 6-7 of IACS URI Requirements concerning Polar Class (2011)

*[Author's note: These footnotes in the latest Polar Code (MSC 94/21/Add.1, Annex 6) are incorrect. It should have referred to IACS UR S6 since this clause addresses material of exposed machinery and foundations.]*

## **CHAPTER 7 – FIRE SAFETY/PROTECTION**

### **7.2 Functional requirements**

- 7.2.2 In addition, for ships intended to operate in low air temperature, the following apply:
- .1 all components of fire safety systems and appliances shall be designed to ensure availability and effectiveness under the polar service temperature; and
  - .2 materials used in exposed fire safety systems shall be suitable for operation at the polar service temperature.

### **7.3 Regulations**

- 7.3.1 In order to comply with the requirement of paragraph 7.2.1.1, the following apply:
- .1 isolating and pressure/vacuum valves in exposed locations are to be protected from ice accretion and remain accessible at all time; and
  - .2 all two-way portable radio communication equipment shall be operable at the polar service temperature.
- 7.3.3 In addition, for ships intended to operate in low air temperature, the following apply:
- .1 In order to comply with the requirement of paragraph 7.2.2.1, portable and semi-portable extinguishers shall be located in positions protected from freezing temperatures, as far as practical. Locations subject to freezing are to be provided with extinguishers capable of operation under the polar service temperature.
  - .2 In order to comply with the functional requirements of paragraph 7.2.2.2 above, materials of exposed fire safety systems shall be approved by the Administration, or a recognized organization accepted by it, taking into account standards acceptable to the Organization<sup>12</sup> or other standards offering an equivalent level of safety based on the polar service temperature.

Foot Note 12 Refer to IACS UR S6 Use of Steel Grades for Various Hull Members – Ships of 90 m in Length and Above (2013) or IACS URI Requirements concerning Polar Class (2011).

## **APPENDIX 1 Form of Certificate for Ships operating in Polar Waters**

### **POLAR SHIP CERTIFICATE**

2.3.1 Polar Service Temperature: .....°C/Not Applicable

## APPENDIX 2 Model Table of Contents for the Polar Water Operational Manual (PWOM)

### SAFETY MEASURES

#### Division 3 – Risk management

#### Chapter 1 Risk mitigation in limiting environmental condition

##### 1.2 Measures to be considered in adverse temperature conditions

**Guidance:** The PWOM should contain guidance on operational restrictions in the event that temperatures below the ships polar service temperature are encountered or forecast. These may include delaying the ship, postponing the conduct of certain types of operation, using temporary heating, and other risk mitigation measures.

### D. Current IACS UR S6 Use of steel grades for various hull members - ships of 90 m in length and above

The current IACS UR S6.3 (Rev. 7, April 2013) defines the design temperature that shall be used in selecting material grade for various strength members including those for vessels operating in low temperature environments. The design temperature is defined as follows:

#### S6.3 Design temperature $t_D$

The design temperature  $t_D$  is to be taken as the lowest mean daily average air temperature in the area of operation.

Mean: Statistical mean over observation period (at least 20 years)

Average: Average during one day and night

Lowest: Lowest during year

For seasonally restricted service the lowest value within the period of operation applies.

Fig. 1 illustrates the temperature definition.

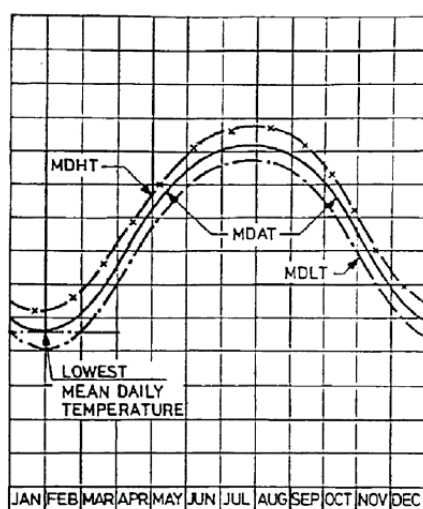


Fig. 1 Commonly used definitions of temperatures

MDHT = Mean Daily High (or maximum) Temperature

MDAT = Mean Daily Average Temperature

MDLT = Mean Daily Low (or minimum) Temperature

#### 4. Relationship between MDAT and MDLT

It is noted that the Polar Service Temperature (PST) is defined at least 10°C below the lowest Mean Daily Low Temperature (MDLT).

IACS UR S6.3 references both the lowest Mean Daily Low Temperature (MDLT) and the lowest Mean Daily Average Temperature (MDAT) while the latter is defined as the design temperature,  $t_D$ . The design temperature,  $t_D$ , is to be used in selecting the material grade in various operational conditions.

The following analysis is carried out to establish the relationship between the lowest Mean Daily Low Temperature (MDLT) and the lowest Mean Daily Average Temperature (MDAT) in various Polar regions.

The temperature data submitted to IMO Ship Design Committee meeting by Canada and Argentina are reanalyzed for this study. In addition, the temperature data in the Arctic regions published by ABS is also used for this study.

##### A. Temperature data of Polar and Sub-polar Regions Submitted by Canada

The government of Canada submitted “Statistical data on temperature in polar and sub-polar regions” at the IMO Ship Design Committee meeting in November 2013, SDC 1/INF.12. This submission provides information on statistical temperature data for polar and sub-polar regions.

This data set includes temperature data from 13 weather monitoring stations: ten Arctic and Sub-Arctic stations and three Antarctic stations. The reporting stations are Barrow, Churchill, Dutch Harbour, Helsinki, Iqualuit, Montreal, Murmansk, Base Esperanza, Nogliki (Sakhalin East), Resolute, Dudinka, Dumont Durville, and Byrd station. The location of the weather reporting stations are shown in **Figure 1**

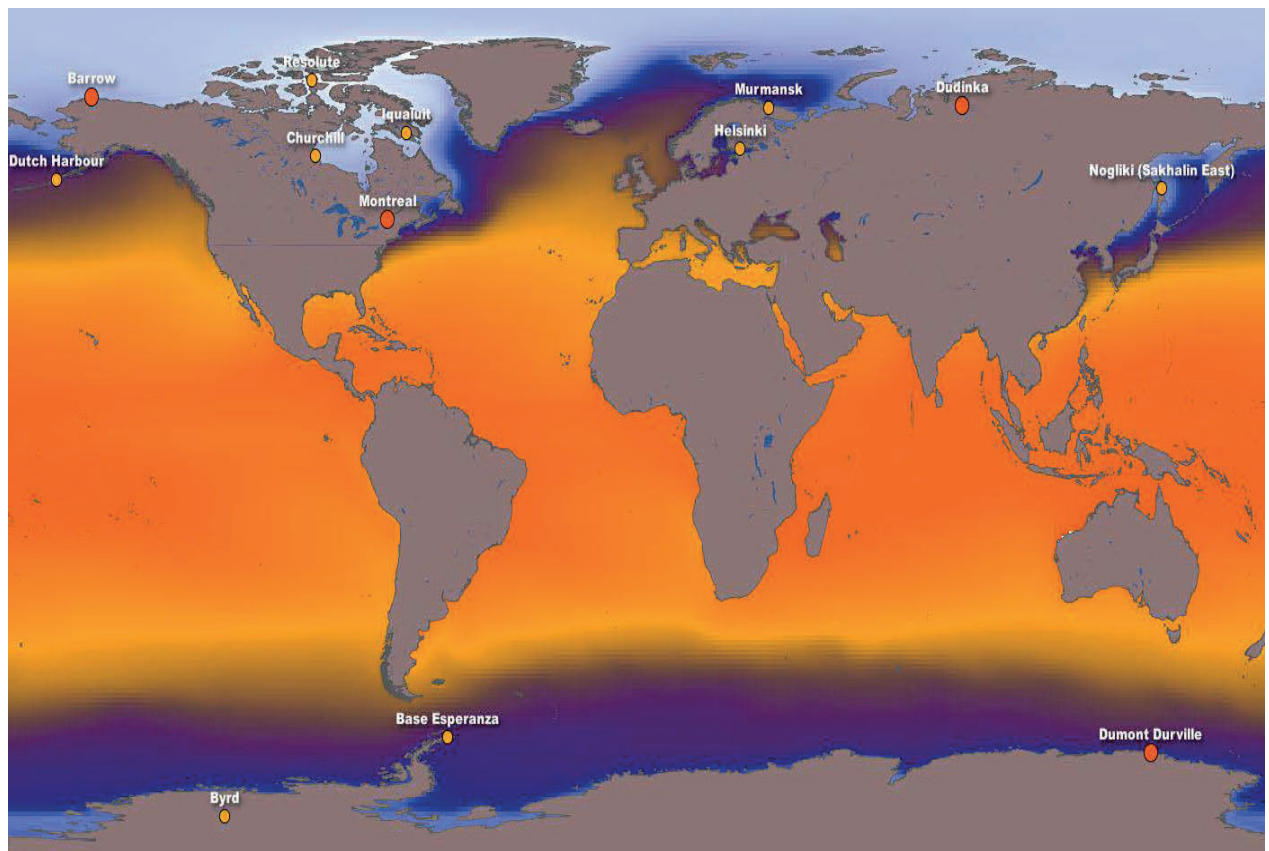


Figure 1 Location of weather monitoring stations



The temperature data was included a table of monthly MDAT and MDLT for 13 stations and various statistics to establish the reference temperature in the Polar regions. The submittal, however, did not include the relationship between the MDLT and MDAT. The data set submitted by Canada was reanalyzed in this report to establish the relationship between the MDLT and MDAT. It was found that the data from Byrd station had errors, and was therefore excluded from this study

The original data set from the Canada submittal SDC 1/INF.12 is provided in

**Table 1.**

**Table 1 Temperature Data submitted by Canada, from SDC 1/INF.12**

STATION	ANALYSIS	JAN	FEB	MAR	APR	MAY	JUN	JUL	AUG	SEP	OCT	NOV	DEC	MIN	MEAN
Barrow	Lowest Record	-43.0	-48.3	-43.3	-32.8	-24.0	-6.0	-3.0	-3.0	-13.9	-20.0	-33.3	-41.1	-48.3	-26.0
	Mean	-21.7	-22.0	-22.2	-14.3	-4.7	1.4	4.2	4.5	1.5	-3.9	-14.4	-19.8	-22.2	-9.3
	Mean - 20 degrees	-41.7	-42.0	-42.2	-34.3	-24.7	-18.6	-15.8	-15.5	-18.5	-23.9	-34.4	-39.8	-42.2	-29.3
	Mean - 2 StdDev	-33.8	-33.8	-32.0	-24.9	-13.3	-3.9	-1.9	-1.2	-3.1	-9.4	-25.4	-31.7	-33.8	-17.9
	Mean Low	-25.6	-25.5	-25.6	-17.4	-6.9	0.0	2.4	2.9	0.1	-5.7	-18.0	-23.8	-25.6	-11.9
	Mean Low - 10 degrees	-35.6	-35.5	-35.6	-27.4	-16.9	-10.0	-7.6	-7.1	-9.9	-15.7	-28.0	-33.8	-35.6	-21.9
	Mean Low - 2 StdDev	-37.7	-37.3	-35.4	-28.1	-15.4	-5.3	-3.7	-2.8	-4.5	-11.2	-29.0	-35.7	-37.7	-20.5
Churchill	Lowest Record	-40.0	-39.0	-35.6	-26.0	-20.0	-3.0	0.0	0.0	-0.5	-15.0	-28.0	-36.0	-40.0	-20.3
	Mean	-11.2	-10.1	-7.2	-2.3	2.3	6.2	8.5	7.6	7.3	1.8	-4.0	-8.9	-11.2	-0.8
	Mean - 20 degrees	-31.2	-30.1	-27.2	-22.3	-17.7	-13.8	-11.5	-12.4	-12.7	-18.2	-24.0	-28.9	-31.2	-20.8
	Mean - 2 StdDev	-20.8	-18.3	-16.5	-10.0	-3.8	0.0	3.7	3.4	1.9	-3.7	-12.2	-17.8	-20.8	-7.8
	Mean Low	-12.5	-12.2	-9.3	-4.6	0.4	4.1	6.6	5.9	4.5	0.7	-4.9	-11.1	-12.5	-2.7
	Mean Low - 10 degrees	-22.5	-22.2	-19.3	-14.6	-9.6	-5.9	-3.4	-4.1	-5.5	-9.3	-14.9	-21.1	-22.5	-12.7
	Mean Low - 2 StdDev	-22.1	-20.4	-18.6	-12.3	-5.6	-2.1	1.9	1.8	-1.0	-4.9	-13.1	-20.0	-22.1	-9.7
Dutch Harbour	Lowest Record	-9.0	-12.0	-9.4	-6.0	-3.3	0.0	0.0	0.0	0.0	-1.0	-6.0	-7.0	-12.0	-4.5
	Mean	0.3	1.0	0.2	2.0	4.4	7.0	9.2	10.4	8.7	6.3	3.0	1.6	0.2	4.5
	Mean - 20 degrees	-19.7	-19.0	-19.8	-18.0	-15.6	-13.0	-10.8	-9.6	-11.3	-13.7	-17.0	-18.4	-19.8	-15.5
	Mean - 2 StdDev	-4.9	-3.9	-5.2	-2.7	0.5	3.9	5.3	6.4	5.1	2.3	-2.0	-3.6	-5.2	0.1
	Mean Low	-1.0	-0.5	-1.2	0.6	2.9	5.7	7.6	8.7	7.3	4.2	1.4	0.1	-1.2	3.0
	Mean Low - 10 degrees	-11.0	-10.5	-11.2	-9.4	-7.1	-4.3	-2.4	-1.3	-2.7	-5.8	-8.6	-9.9	-11.2	-7.0
	Mean Low - 2 StdDev	-6.2	-5.3	-6.6	-4.1	-1.0	2.6	3.7	4.8	3.7	0.1	-3.7	-5.0	-6.6	-1.4
Helsinki	Lowest Record	-27.0	-29.0	-22.0	-10.0	-3.0	0.0	0.0	0.0	-2.0	-14.0	-20.0	-25.0	-29.0	-12.7
	Mean	-4.0	-5.6	-2.0	4.2	9.9	13.6	16.7	15.1	12.4	5.8	2.3	-1.3	-5.6	5.6
	Mean - 20 degrees	-24.0	-25.6	-22.0	-15.8	-10.1	-6.4	-3.3	-4.9	-7.6	-14.2	-17.7	-21.3	-25.6	-14.4
	Mean - 2 StdDev	-13.4	-15.3	-10.2	-3.6	1.0	6.1	9.9	7.9	5.1	-1.8	-6.6	-9.5	-15.3	-2.5
	Mean Low	-6.9	-8.9	-6.3	-0.3	4.7	8.5	11.7	10.4	7.0	2.4	-0.2	-4.1	-8.9	1.5
	Mean Low - 10 degrees	-16.9	-18.9	-16.3	-10.3	-5.3	-1.5	1.7	0.4	-3.0	-7.6	-10.2	-14.1	-18.9	-8.5
	Mean Low - 2 StdDev	-16.4	-18.6	-14.5	-8.2	-4.2	1.0	4.9	3.2	-0.3	-5.1	-9.1	-12.2	-18.6	-6.6
Iqualuit	Lowest Record	-41.0	-40.6	-41.0	-31.0	-18.0	-6.5	-5.7	-1.9	-7.0	-20.5	-27.0	-38.0	-41.0	-23.2
	Mean	-22.6	-21.2	-18.8	-11.0	-2.5	3.5	7.8	6.8	3.4	-1.9	-9.1	-18.0	-22.6	-7.0
	Mean - 20 degrees	-42.6	-41.2	-38.8	-31.0	-22.5	-16.5	-12.2	-13.2	-16.6	-21.9	-29.1	-38.0	-42.6	-27.0
	Mean - 2 StdDev	-34.7	-32.8	-32.0	-22.1	-9.1	-2.1	0.5	1.6	-1.8	-8.3	-20.3	-33.0	-34.7	-16.2
	Mean Low	-25.6	-24.4	-22.3	-14.5	-4.6	1.2	4.9	4.4	1.1	-4.0	-12.3	-21.7	-25.6	-9.8
	Mean Low - 10 degrees	-35.6	-34.4	-32.3	-24.5	-14.6	-8.8	-5.1	-5.6	-8.9	-14.0	-22.3	-31.7	-35.6	-19.8
	Mean Low - 2 StdDev	-37.8	-36.1	-35.5	-25.6	-11.2	-4.4	-2.5	-0.9	-4.0	-10.5	-23.5	-36.7	-37.8	-19.1
Montreal	Lowest Record	-27.5	-23.0	-24.0	-7.0	0.0	0.0	0.0	0.0	0.0	-3.0	-14.0	-21.0	-27.5	-10.0
	Mean	-5.9	-5.0	-0.5	6.0	11.6	15.8	18.1	17.1	14.2	7.0	2.7	-3.1	-5.9	6.5
	Mean - 20 degrees	-25.9	-25.0	-20.5	-14.0	-8.4	-4.2	-1.9	-2.9	-5.8	-13.0	-17.3	-23.1	-25.9	-13.5
	Mean - 2 StdDev	-16.8	-14.0	-9.7	-2.9	3.1	8.3	11.9	10.8	7.0	0.3	-4.9	-12.2	-16.8	-1.6
	Mean Low	-9.3	-8.2	-3.7	2.4	7.8	12.5	14.6	13.7	9.2	4.4	-0.1	-5.9	-9.3	3.1
	Mean Low - 10 degrees	-19.3	-18.2	-13.7	-7.6	-2.2	2.5	4.6	3.7	-0.8	-5.6	-10.1	-15.9	-19.3	-6.9
	Mean Low - 2 StdDev	-20.2	-17.1	-13.0	-6.5	-0.7	5.0	8.4	7.4	2.0	-2.3	-7.7	-14.9	-20.2	-5.0
Murmansk	Lowest Record	-36.0	-41.0	-32.0	-26.0	-12.0	-3.0	0.0	-5.0	-5.0	-23.0	-32.0	-37.0	-41.0	-21.0
	Mean	-9.6	-12.3	-6.7	-0.2	4.8	9.4	12.1	10.4	7.4	1.6	-4.5	-7.7	-12.3	0.4
	Mean - 20 degrees	-29.6	-32.3	-26.7	-20.2	-15.2	-10.6	-7.9	-9.6	-12.6	-18.4	-24.5	-27.7	-32.3	-19.6
	Mean - 2 StdDev	-23.2	-26.4	-18.8	-8.8	-4.3	-0.1	3.2	2.0	0.1	-6.0	-16.8	-20.1	-26.4	-9.9
	Mean Low	-14.4	-18.2	-13.4	-5.6	0.6	4.9	7.5	5.5	2.7	-1.2	-8.6	-12.6	-18.2	-4.4
	Mean Low - 10 degrees	-24.4	-28.2	-23.4	-15.6	-9.4	-5.1	-2.5	-4.5	-7.3	-11.2	-18.6	-22.6	-28.2	-14.4
	Mean Low - 2 StdDev	-28.0	-32.4	-25.4	-14.2	-8.5	-4.6	-1.4	-2.9	-4.6	-8.8	-21.0	-24.9	-32.4	-14.7

Base Esperanza	Lowest Record	-5.1	-9.0	-16.8	-25.7	-21.5	-26.3	-31.0	-27.9	-25.2	-18.6	-18.0	-7.2	-31.0	-19.4
	Mean	1.6	0.9	-1.9	-6.5	-7.7	-11.0	-11.5	-9.4	-6.4	-2.6	-1.0	0.7	-11.5	-4.6
	Mean - 20 degrees	-18.4	-19.1	-21.9	-26.5	-27.7	-31.0	-31.5	-29.4	-26.4	-22.6	-21.0	-19.3	-31.5	-24.6
	Mean - 2 StdDev	-3.0	-4.9	-11.4	-18.1	-20.0	-23.7	-26.2	-23.2	-19.0	-11.6	-8.0	-4.4	-26.2	-14.5
	Mean Low	-0.3	-1.0	-4.1	-8.9	-10.7	-13.7	-14.6	-12.4	-9.4	-5.4	-3.2	-1.3	-14.6	-7.1
	Mean Low - 10 degrees	-10.3	-11.0	-14.1	-18.9	-20.7	-23.7	-24.6	-22.4	-19.4	-15.4	-13.2	-11.3	-24.6	-17.1
	Mean Low - 2 StdDev	-4.9	-6.9	-13.6	-20.5	-23.0	-26.4	-29.3	-26.2	-22.0	-14.4	-10.2	-6.4	-29.3	-17.0
Nogliki (Sakhalin East)	Lowest Record	-33.8	-33.4	-29.3	-21.0	-5.8	-1.0	0.0	0.0	-2.1	-13.5	-24.5	-31.1	-33.8	-16.3
	Mean	-15.6	-14.9	-7.8	-1.7	3.3	10.1	12.7	14.3	11.9	3.6	-5.8	-14.2	-15.6	-0.3
	Mean - 20 degrees	-35.6	-34.9	-27.8	-21.7	-16.7	-9.9	-7.3	-5.7	-8.1	-16.4	-25.8	-34.2	-35.6	-20.3
	Mean - 2 StdDev	-26.7	-25.3	-17.4	-9.1	-4.9	-0.6	4.4	6.3	2.6	-5.1	-18.0	-27.2	-27.2	-10.1
	Mean Low	-18.8	-18.8	-11.5	-4.2	0.6	6.4	9.6	11.2	7.6	0.8	-8.9	-17.4	-18.8	-3.6
	Mean Low - 10 degrees	-28.8	-28.8	-21.5	-14.2	-9.4	-3.6	-0.4	1.2	-2.4	-9.2	-18.9	-27.4	-28.8	-13.6
	Mean Low - 2 StdDev	-30.0	-29.2	-21.1	-11.7	-7.7	-4.3	1.4	3.2	-1.7	-7.9	-21.0	-30.4	-30.4	-13.4
Resolute	Lowest Record	-44.2	-43.3	-46.1	-37.3	-26.0	-10.0	-2.1	-7.9	-27.3	-36.7	-37.0	-42.0	-46.1	-30.0
	Mean	-24.6	-25.4	-23.5	-16.2	-7.6	1.0	4.6	3.0	-4.3	-9.8	-18.6	-23.9	-25.4	-12.1
	Mean - 20 degrees	-44.6	-45.4	-43.5	-36.2	-27.6	-19.0	-15.4	-17.0	-24.3	-29.8	-38.6	-43.9	-45.4	-32.1
	Mean - 2 StdDev	-32.3	-33.2	-33.7	-24.0	-15.9	-4.2	-1.1	-2.5	-9.3	-17.8	-27.8	-33.4	-33.7	-19.6
	Mean Low	-26.8	-27.5	-25.6	-18.6	-9.6	-0.5	2.6	1.3	-5.1	-11.6	-21.2	-26.0	-27.5	-14.0
	Mean Low - 10 degrees	-36.8	-37.5	-35.6	-28.6	-19.6	-10.5	-7.4	-8.7	-15.1	-21.6	-31.2	-36.0	-37.5	-24.0
	Mean Low - 2 StdDev	-34.5	-35.3	-35.8	-26.3	-17.8	-5.7	-3.1	-4.2	-10.1	-19.6	-30.4	-35.5	-35.8	-21.5
Dudinka	Lowest Record	-52.1	-47.5	-51.2	-37.2	-23.8	-4.8	0.0	-1.8	-6.1	-30.1	-43.6	-48.5	-52.1	-28.9
	Mean	-20.6	-22.8	-17.2	-10.3	-3.3	6.9	13.9	9.0	4.5	-4.8	-17.9	-21.2	-22.8	-7.0
	Mean - 20 degrees	-40.6	-42.8	-37.2	-30.3	-23.3	-13.1	-6.1	-11.0	-15.5	-24.8	-37.9	-41.2	-42.8	-27.0
	Mean - 2 StdDev	-34.4	-36.0	-33.3	-23.8	-12.3	-1.7	6.0	2.6	-1.8	-16.6	-34.4	-36.6	-36.6	-18.5
	Mean Low	-23.3	-25.8	-21.5	-14.6	-6.2	4.1	8.7	5.3	2.1	-7.0	-21.1	-23.9	-25.8	-10.3
	Mean Low - 10 degrees	-33.3	-35.8	-31.5	-24.6	-16.2	-5.9	-1.3	-4.7	-7.9	-17.0	-31.1	-33.9	-35.8	-20.3
	Mean Low - 2 StdDev	-37.1	-39.0	-37.6	-28.2	-15.1	-4.5	0.8	-1.2	-4.3	-18.8	-37.6	-39.2	-39.2	-21.8
Byrd	Lowest Record	-25.1	-37.6	-48.2	-54.2	-51.8	-56.6	-58.6	-54.9	-61.5	-47.8	-38.4	-24.3	-61.5	-46.6
	Mean	-8.0	-10.5	-15.2	-18.6	-19.7	-21.2	-17.7	-21.1	-24.8	-19.1	-13.9	-7.7	-24.8	-16.4
	Mean - 20 degrees	-28.0	-30.5	-35.2	-38.6	-39.7	-41.2	-37.7	-41.1	-44.8	-39.1	-33.9	-27.7	-44.8	-36.4
	Mean - 2 StdDev	-12.8	-16.9	-23.3	-28.2	-29.6	-31.4	-26.7	-31.5	-35.6	-26.1	-21.1	-12.2	-35.6	-24.6
	Mean Low	-8.3	-11.8	-14.6	-19.6	-21.6	-22.1	-19.2	-22.3	-22.5	-16.9	-15.1	-9.6	-22.5	-17.0
	Mean Low - 10 degrees	-18.3	-21.8	-24.6	-29.6	-31.6	-32.1	-29.2	-32.3	-32.5	-26.9	-25.1	-19.6	-32.5	-27.0
	Mean Low - 2 StdDev	-13.1	-18.1	-22.7	-29.2	-31.5	-32.2	-28.2	-32.7	-33.3	-23.8	-22.4	-14.1	-33.3	-25.1
Dumont Durville	Lowest Record	-7.8	-16.2	-19.4	-25.3	-30.8	-31.0	-32.8	-31.8	-32.3	-24.6	-20.4	-10.2	-32.8	-23.6
	Mean	-0.4	-4.0	-8.4	-12.5	-14.1	-14.9	-16.1	-13.0	-12.6	-12.7	-6.2	-1.3	-16.1	-9.7
	Mean - 20 degrees	-20.4	-24.0	-28.4	-32.5	-34.1	-34.9	-36.1	-33.0	-32.6	-32.7	-26.2	-21.3	-36.1	-29.7
	Mean - 2 StdDev	-3.9	-9.0	-14.7	-19.2	-22.7	-23.1	-24.7	-21.8	-20.0	-19.7	-13.0	-5.5	-24.7	-16.4
	Mean Low	-1.9	-5.8	-10.0	-14.1	-15.2	-16.4	-16.6	-14.5	-14.3	-12.7	-8.5	-3.0	-16.6	-11.1
	Mean Low - 10 degrees	-11.9	-15.8	-20.0	-24.1	-25.2	-26.4	-26.6	-24.5	-24.3	-22.7	-18.5	-13.0	-26.6	-21.1
	Mean Low - 2 StdDev	-5.4	-10.9	-16.3	-20.8	-23.8	-24.5	-25.2	-23.3	-21.7	-19.7	-15.3	-7.2	-25.2	-17.9

STATION	ANALYSIS	JAN	FEB	MAR	APR	MAY	JUN	JUL	AUG	SEP	OCT	NOV	DEC	MIN	MEAN
---------	----------	-----	-----	-----	-----	-----	-----	-----	-----	-----	-----	-----	-----	-----	------

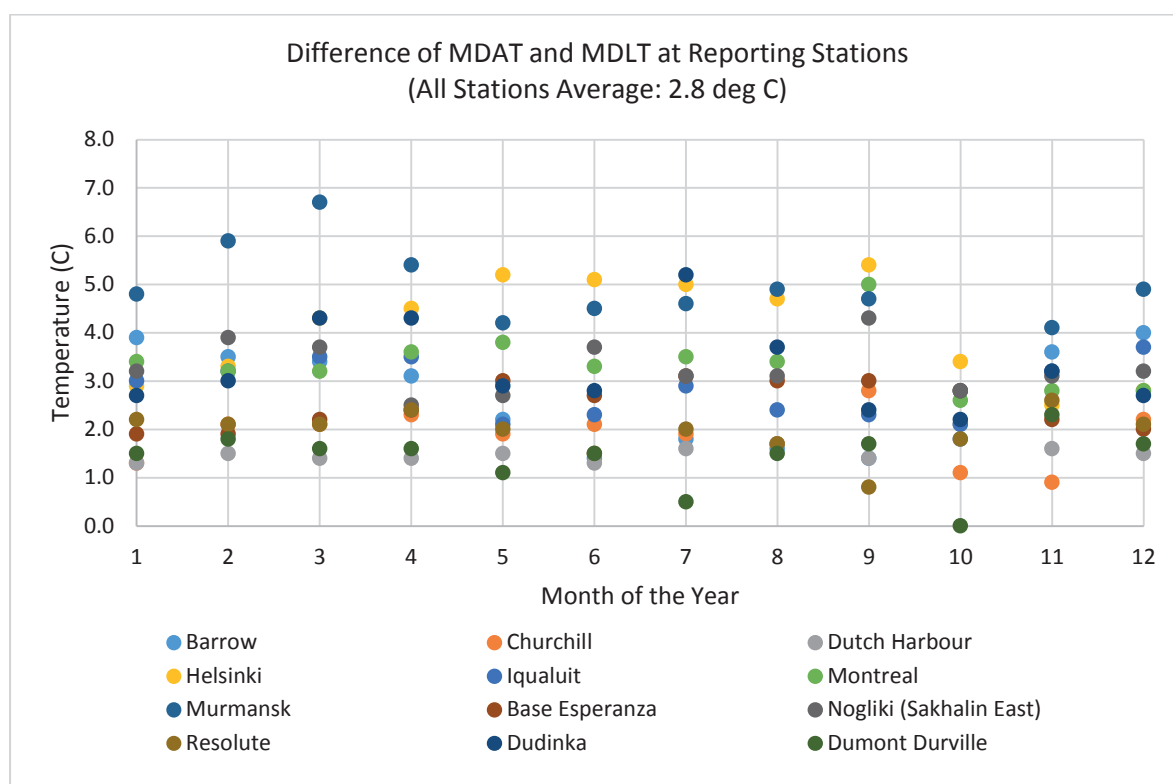
Table 1 includes mean (MDAT), mean low (MDLT), lowest recorded temperatures and various statistics. The difference between the MDAT and MDLT are calculated for each station and provided in Table 2.



**Table 2 Difference between the MDAT and MDLT at reporting stations, calculated using temperature data from SDC 1/INF.12**

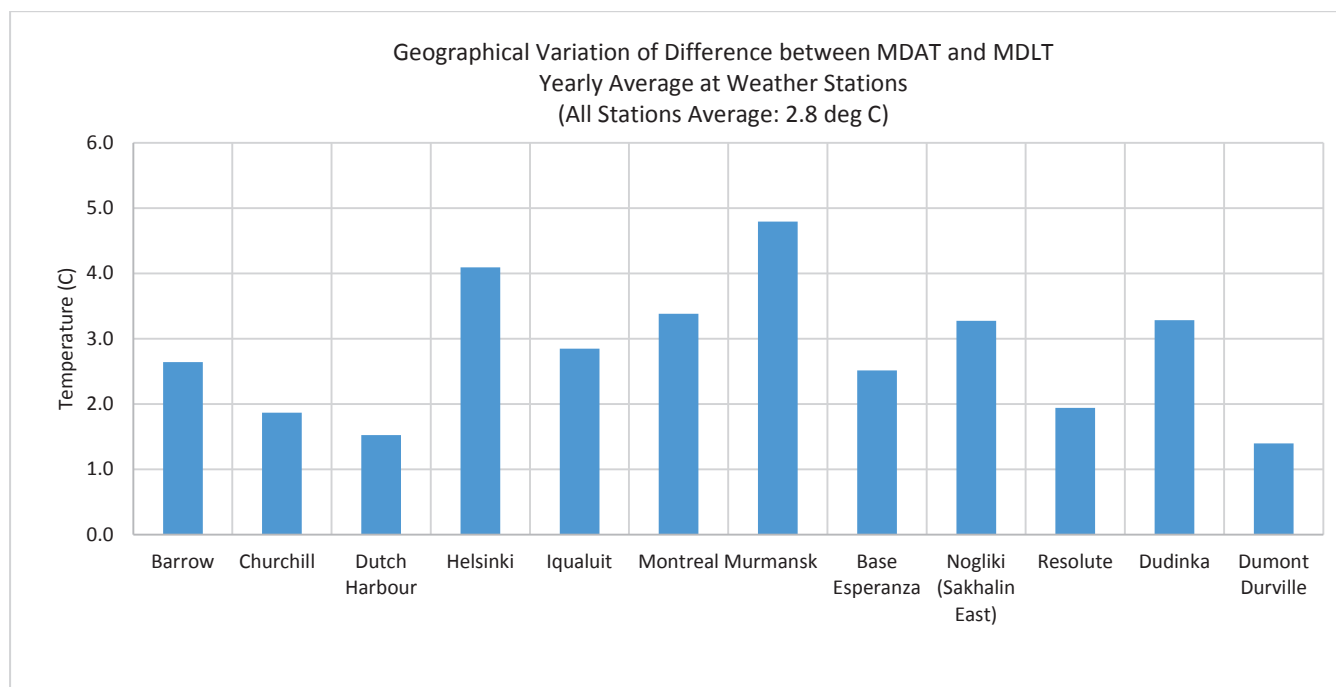
	JAN	FEB	MAR	APR	MAY	JUN	JUL	AUG	SEP	OCT	NOV	DEC	Yearly Mean	STD
Barrow	3.9	3.5	3.4	3.1	2.2	1.4	1.8	1.6	1.4	1.8	3.6	4.0	<b>2.6</b>	<b>1.0</b>
Churchill	1.3	2.1	2.1	2.3	1.9	2.1	1.9	1.7	2.8	1.1	0.9	2.2	<b>1.9</b>	<b>0.5</b>
Dutch Harbour	1.3	1.5	1.4	1.4	1.5	1.3	1.6	1.7	1.4	2.1	1.6	1.5	<b>1.5</b>	<b>0.2</b>
Helsinki	2.9	3.3	4.3	4.5	5.2	5.1	5.0	4.7	5.4	3.4	2.5	2.8	<b>4.1</b>	<b>1.0</b>
Iqaluit	3.0	3.2	3.5	3.5	2.1	2.3	2.9	2.4	2.3	2.1	3.2	3.7	<b>2.9</b>	<b>0.6</b>
Montreal	3.4	3.2	3.2	3.6	3.8	3.3	3.5	3.4	5.0	2.6	2.8	2.8	<b>3.4</b>	<b>0.6</b>
Murmansk	4.8	5.9	6.7	5.4	4.2	4.5	4.6	4.9	4.7	2.8	4.1	4.9	<b>4.8</b>	<b>1.0</b>
Base Esperanza	1.9	1.9	2.2	2.4	3.0	2.7	3.1	3.0	3.0	2.8	2.2	2.0	<b>2.5</b>	<b>0.5</b>
Nogliki (Sakhalin East)	3.2	3.9	3.7	2.5	2.7	3.7	3.1	3.1	4.3	2.8	3.1	3.2	<b>3.3</b>	<b>0.5</b>
Resolute	2.2	2.1	2.1	2.4	2.0	1.5	2.0	1.7	0.8	1.8	2.6	2.1	<b>1.9</b>	<b>0.5</b>
Dudinka	2.7	3.0	4.3	4.3	2.9	2.8	5.2	3.7	2.4	2.2	3.2	2.7	<b>3.3</b>	<b>0.9</b>
Dumont Durville	1.5	1.8	1.6	1.6	1.1	1.5	0.5	1.5	1.7	0.0	2.3	1.7	<b>1.4</b>	<b>0.6</b>
<b>Monthly Mean</b>	<b>2.7</b>	<b>3.0</b>	<b>3.2</b>	<b>3.1</b>	<b>2.7</b>	<b>2.7</b>	<b>2.9</b>	<b>2.8</b>	<b>2.9</b>	<b>2.1</b>	<b>2.7</b>	<b>2.8</b>	<b>2.8</b>	<b>0.7</b>

Figure 2 is the scatter plot of the monthly mean of difference between the MDAT and MDLT at reporting stations throughout the year.



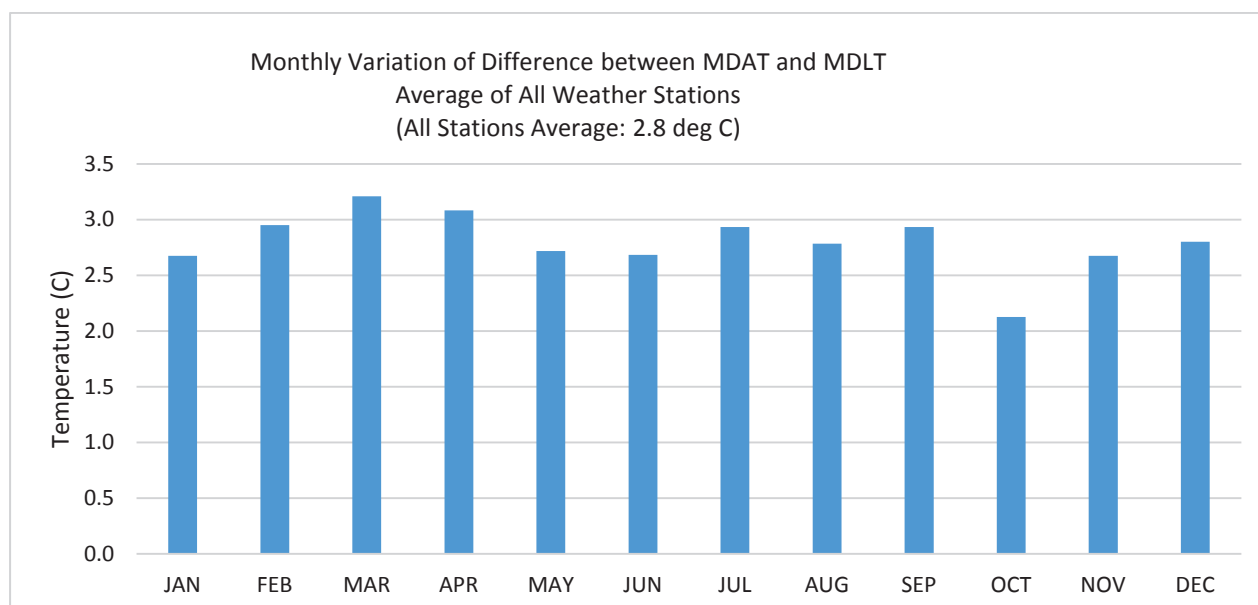
**Figure 2 Difference of MDAT and MDLT at Reporting Stations, calculated using temperature data from SDC 1/INF.12**

Figure 3 is the plot of the difference of MDAT and MDLT at various geographical regions. It is noted that sub-Arctic stations, Murmansk, Helsinki and Montreal, show relatively greater difference than those of Arctic and Antarctic stations.



**Figure 3 Geographical Variation of Difference between MDAT and MDLT, calculated using temperature data from SDC 1/INF.12**

Figure 4 show the monthly average of the difference between MDAT and NDLT of all reporting station for each month of the year.



**Figure 4 Monthly variation of difference between MDAT and MDLT, calculated using temperature data from SDC 1/INF.12**

## B. Temperature data of Antarctic Station Submitted by Argentina

The government of Argentina submitted “Result of a statistical analysis of temperature variations” at the IMO Ship Design Committee meeting in November 2013, SDC 1/13/14. This document presents the results of a statistical analysis of temperature variations obtained from Carlini Base in the Antarctic with a view to determining design temperatures.

The submitted document included the monthly average MDAT and monthly average MDLT for the period 2001-2010 at Carlini Base, located at 62° 14' S; 58° 40' W. The location of Carlini Base is shown in Figure 5

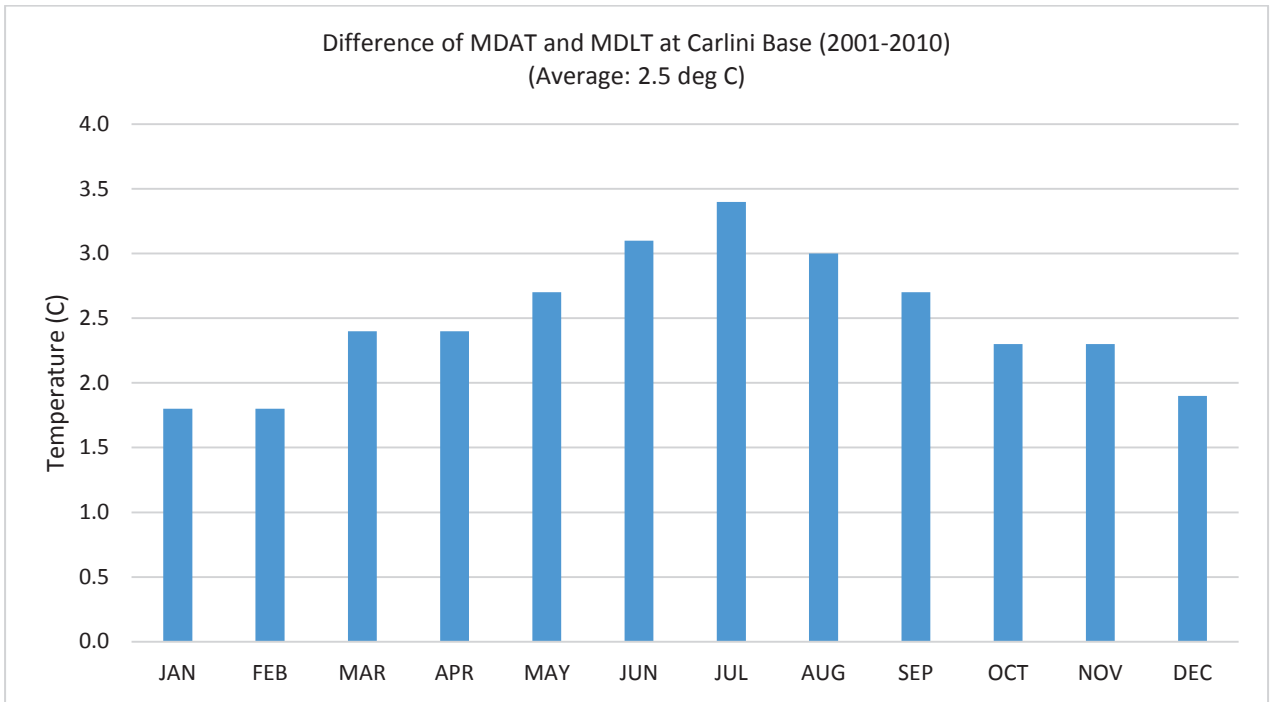


**Figure 5 Location of Carlini Base in the Antarctic**

**Table 3** shows the monthly average MDAT, MDLT and the difference at Carlini Base. Figure 6 shows the difference of monthly average MDAT and MDLT for each month.

**Table 3 Monthly Average MDAT, MDLT and the difference at Carlini Base (2001-2010)**

	JAN	FEB	MAR	APR	MAY	JUN	JUL	AUG	SEP	OCT	NOV	DEC	Mean	STD
MDAT	2.3	2.0	0.7	-1.6	-2.7	-5.8	-6.0	-4.5	-2.5	-1.6	0.1	1.1		
MDLT	0.5	0.2	-1.7	-4.0	-5.4	-8.9	-9.4	-7.5	-5.2	-3.9	-2.2	-0.8		
Difference	1.8	1.8	2.4	2.4	2.7	3.1	3.4	3.0	2.7	2.3	2.3	1.9	2.5	0.5



**Figure 6 Difference of monthly average MDAT and MDLT at Carlini Base (2001-2010)**

### C. Temperature data from ABS Guide for Vessels Operating in Low Temperature Environments (2015)

The operation of merchant vessels in low temperature environments presents many challenges for designers, builders, Owners, and Operators. These challenges include both hardware issues related directly to the construction, outfitting, and operation of vessels, as well as those issues pertaining to the ability of the crew to function in a difficult environment. To assist the marine industry, ABS issued the Guide for Vessels Operating in Low Temperature Environments (ABS LTE Guide) and the latest update is published in 2015.

The ABS LTE Guide includes year-round temperature data obtained for selected coastal sites throughout the Arctic. Temperatures at sea are on average slightly higher than those on the adjacent land. Therefore, land based temperature data will normally represent more severe conditions (i.e. colder temperature statistics). The selected eleven Arctic stations are: Aasiaat, Greenland; Alazeja River, Russia; Barrow, USA; Clyde, Canada; Golomjannyj, Russia; Malye Karmakuly, Russia; Ostrov Kotelnyj, Russia; Pelly Island, Canada; Resolute, Canada; Reykjavik, Iceland; Tromso, Norway. The location of the selected Arctic stations are provided in Figure 7. The MDAT and MDLT for the location are given for the 1st and the 15th day of the month.



Figure 7 Location of the selected Arctic stations

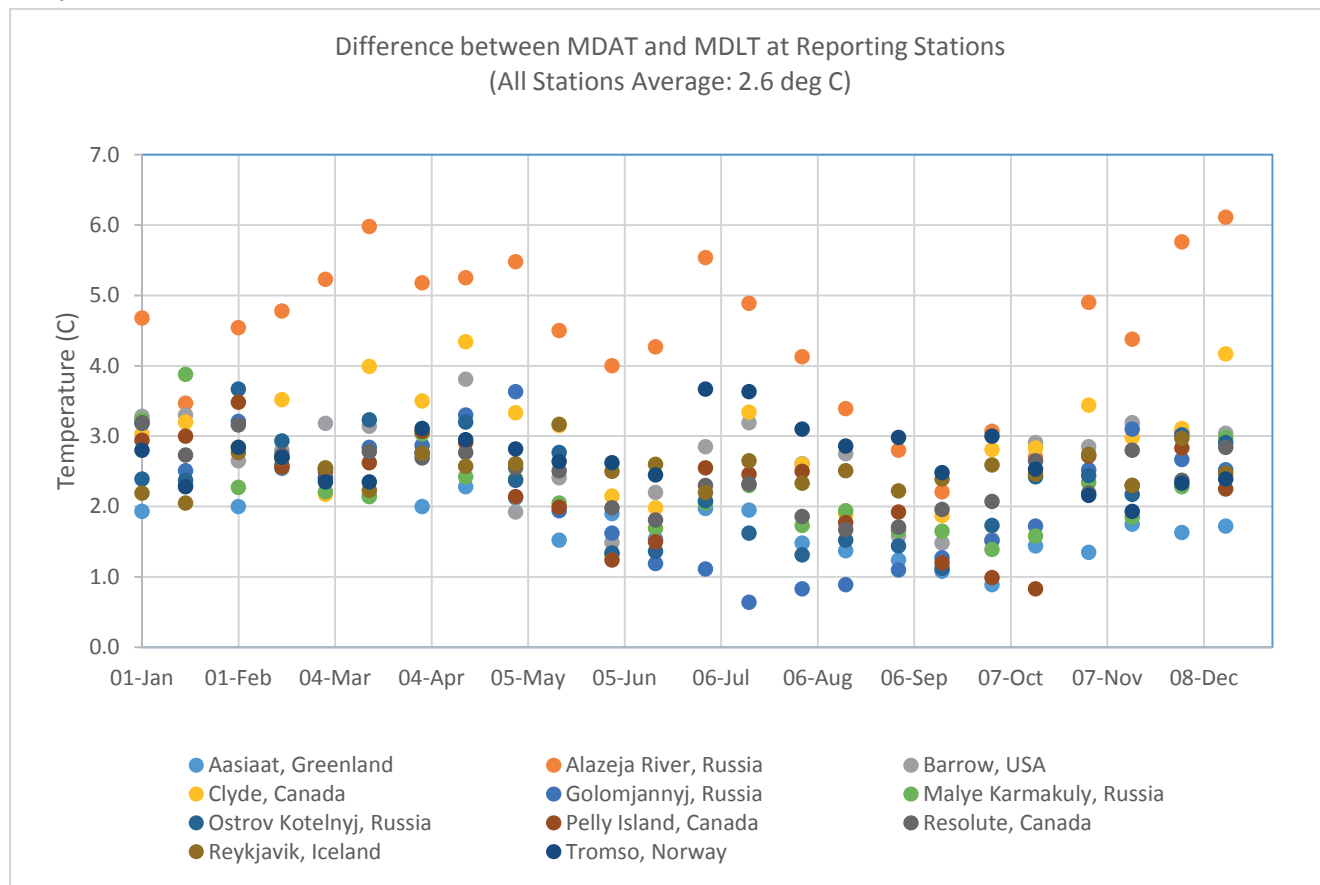
Table 4 is the difference of MDAT and MDLT on the 1<sup>st</sup> and 15<sup>th</sup> day of each month at the selected locations.

**Table 4 Difference of MDAT and MDLT on the 1st and 15th of each month, ABS LTE Guide**

	Jan		Feb		Mar		Apr		May		Jun	
	1st	15th	1st	15th	1st	15th	1st	15th	1 <sup>st</sup>	15th	1 <sup>st</sup>	15th
Aasiaat, Greenland	1.9	2.3	2.0	2.5	2.4	2.2	2.0	2.3	2.1	1.5	1.9	1.5
Alazeja River, Russia	4.7	3.5	4.5	4.8	5.2	6.0	5.2	5.3	5.5	4.5	4.0	4.3
Barrow, USA	3.3	3.3	2.7	2.8	3.2	3.1	2.8	3.8	1.9	2.4	1.5	2.2
Clyde, Canada	3.0	3.2	2.8	3.5	2.2	4.0	3.5	4.3	3.3	3.2	2.2	2.0
Golomjannyj, Russia	3.2	2.5	3.2	2.6	2.5	2.8	2.9	3.3	3.6	1.9	1.6	1.2
Malye Karmakuly, Russia	3.2	3.9	2.3	2.7	2.2	2.1	3.0	2.4	2.4	2.1	1.3	1.7
Ostrov Kotelnyj, Russia	2.4	2.4	3.7	2.9	2.4	3.2	2.8	3.2	2.4	2.8	1.3	1.4
Pelly Island, Canada	2.9	3.0	3.5	2.6	2.5	2.6	3.1	2.9	2.1	2.0	1.2	1.5
Resolute, Canada	3.2	2.7	3.2	2.7	2.5	2.8	2.7	2.8	2.6	2.5	2.0	1.8
Reykjavik, Iceland	2.2	2.1	2.8	2.7	2.6	2.2	2.8	2.6	2.6	3.2	2.5	2.6
Tromso, Norway	2.8	2.3	2.8	2.7	2.4	2.4	3.1	3.0	2.8	2.6	2.6	2.5
<b>Mean, All Station</b>	<b>3.0</b>	<b>2.8</b>	<b>3.0</b>	<b>3.0</b>	<b>2.7</b>	<b>3.0</b>	<b>3.1</b>	<b>3.3</b>	<b>2.9</b>	<b>2.6</b>	<b>2.0</b>	<b>2.1</b>

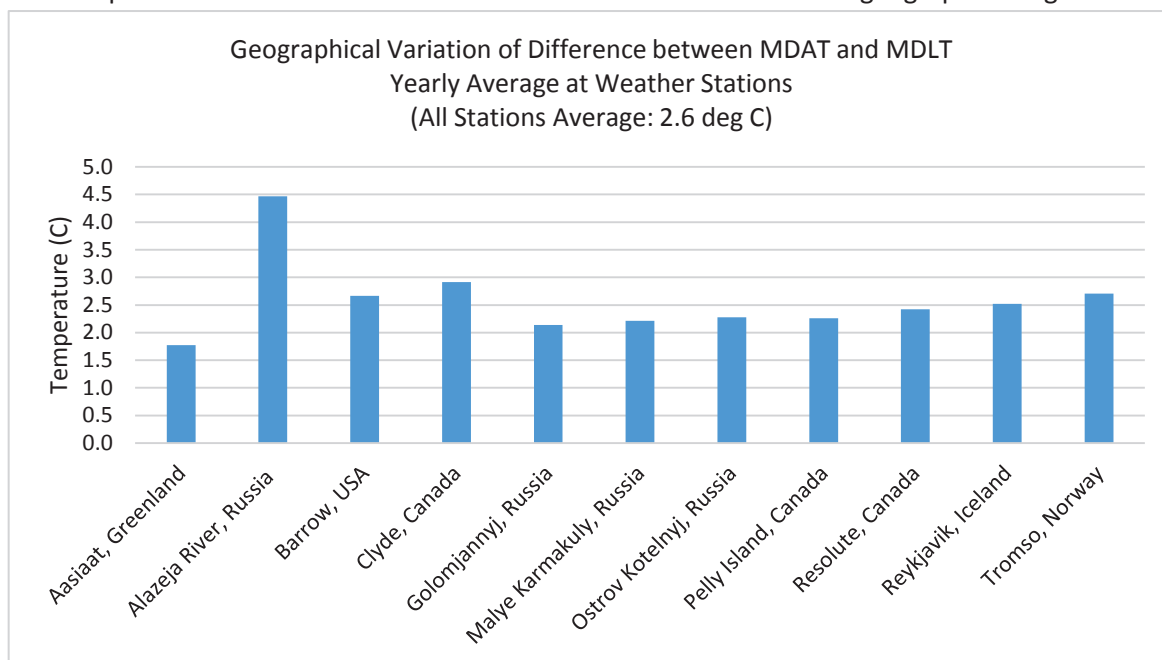
	Jul		Aug		Sep		Oct		Nov		Dec		All Year	
	1st	15th	1st	15th	1st	15th	1st	15th	1st	15th	1st	15th	Mean	STD
Aasiaat, Greenland	2.0	2.0	1.5	1.4	1.2	1.1	0.9	1.4	1.4	1.8	1.6	1.7	<b>1.8</b>	<b>0.4</b>
Alazeja River, Russia	5.5	4.9	4.1	3.4	2.8	2.2	3.1	2.7	4.9	4.4	5.8	6.1	<b>4.5</b>	<b>1.1</b>
Barrow, USA	2.9	3.2	2.6	2.8	1.6	1.5	1.5	2.9	2.9	3.2	3.1	3.0	<b>2.7</b>	<b>0.6</b>
Clyde, Canada	2.1	3.3	2.6	1.9	1.7	1.9	2.8	2.8	3.4	3.0	3.1	4.2	<b>2.9</b>	<b>0.7</b>
Golomjannyj, Russia	1.1	0.6	0.8	0.9	1.1	1.3	1.5	1.7	2.5	3.1	2.7	2.5	<b>2.1</b>	<b>0.9</b>
Malye Karmakuly, Russia	2.1	2.3	1.7	1.9	1.7	1.7	1.4	1.6	2.3	1.9	2.3	3.0	<b>2.2</b>	<b>0.6</b>
Ostrov Kotelnyj, Russia	2.1	1.6	1.3	1.5	1.4	1.1	1.7	2.4	2.4	2.2	3.0	2.9	<b>2.3</b>	<b>0.7</b>
Pelly Island, Canada	2.6	2.5	2.5	1.8	1.9	1.2	1.0	0.8	2.7	2.3	2.8	2.3	<b>2.3</b>	<b>0.7</b>
Resolute, Canada	2.3	2.3	1.9	1.7	1.7	2.0	2.1	2.7	2.2	2.8	2.4	2.8	<b>2.4</b>	<b>0.4</b>
Reykjavik, Iceland	2.2	2.7	2.3	2.5	2.2	2.4	2.6	2.5	2.7	2.3	3.0	2.5	<b>2.5</b>	<b>0.3</b>
Tromso, Norway	3.7	3.6	3.1	2.9	3.0	2.5	3.0	2.5	2.2	1.9	2.3	2.4	<b>2.7</b>	<b>0.4</b>
<b>Mean, All Station</b>	<b>2.6</b>	<b>2.6</b>	<b>2.2</b>	<b>2.1</b>	<b>1.8</b>	<b>1.7</b>	<b>2.0</b>	<b>2.2</b>	<b>2.7</b>	<b>2.6</b>	<b>2.9</b>	<b>3.0</b>	<b>2.6</b>	<b>0.6</b>

Figure 8 is the scatter plot of the monthly difference between the MDAT and MDLT at all stations throughout the year.



**Figure 8 Difference between MDAT and MDLT at Reporting Stations, ABS LTE Guide**

Figure 9 is the plot of the difference between the MDAT and MDLT at various geographical regions.



**Figure 9 Geographical Variation of the Difference between MDAT and MDLT, ABS LTE Guide**

Figure 1010 shows the seasonal variation of the difference between MDAT and MDLT throughout the year.

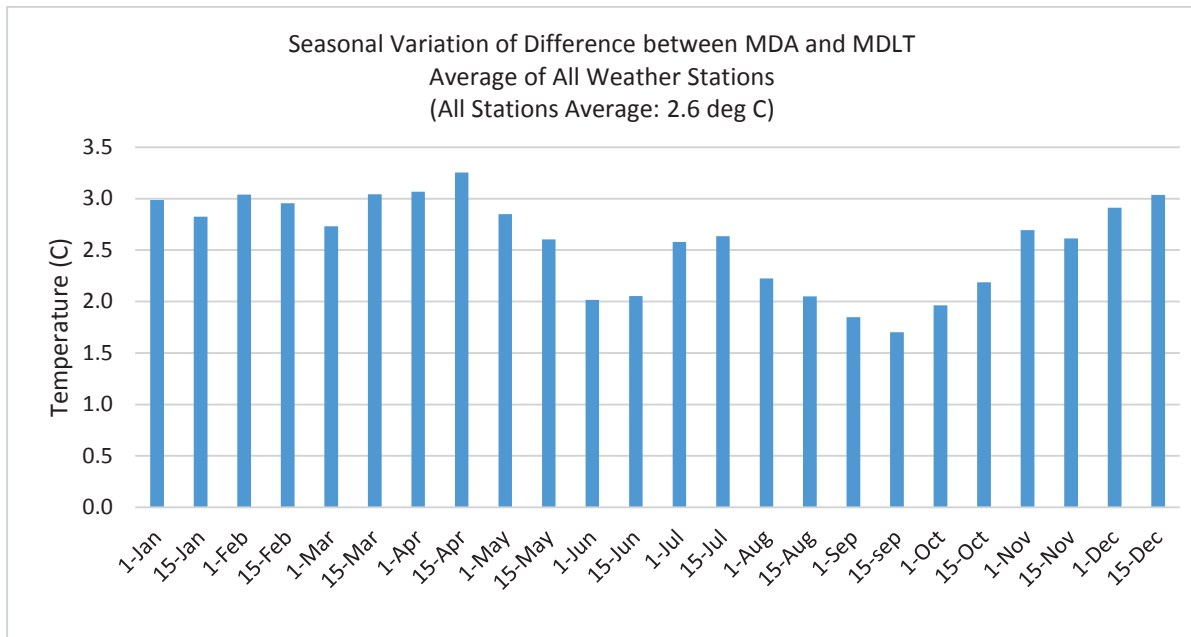


Figure 10 Seasonal variation of difference between MDAT and MDLT, ABS LTE Guide



## 5. Conclusion and Recommendations

Results from all three data sources, Canadian, Argentinian and ABS, showed the difference between the mean daily average temperature (MDAT) and the mean daily low temperature (MDLT) is in the range of 2.5°C to 3.0°C

- 2.8°C – Canadian Data
- 2.5°C – Argentinian Data
- 2.6°C – ABS Data

It has been demonstrated that the nominal difference between the MDAT and MDLT in the Polar regions can be considered 3°C. This implies that the MDAT can be 13°C higher than the Polar Service Temperature (PST).

### A. Recommendation for changes of UR S6.3

It is recommended to add the following statement in UR S6.3.

- 1) “For the purpose of issuing the Polar Ship Certificate in accordance with the Polar Code, the design temperature  $t_D$  shall be no more than 13°C higher than the Polar Service Temperature (PST) of the ship”.
- 2) “In the Arctic region, the statistical mean over observation period is to be determined for a period of at least 10 years”.

Associated with point 2) above it is recommended that the requirement for a statistical mean of at least 20 years in S6.3 be removed by deleting “at least 20 years” in the parenthesis at the end of the Mean definition.

Furthermore, it is recommended that Fig 2. of UR S6.3 be updated to include identification of the lowest mean daily lowest temperature. It is recommended that the figure contained in Part IB of the Polar Code be used for consistency.

### B. Recommendations to IACS panels and working groups

- 1) The list of Polar Service Temperature (PST) related clauses in Section 3. C of this report should be reviewed by relevant IACS Panel or working group to develop the implementation plans, if necessary. Specific attention should be given to the reference to UR S6.3 for approval of materials of machinery systems and materials used in fire protection systems
- 2) It should be noted that the polar code makes reference to UR S6.3 for materials of hull structures, machinery, and fire protection systems. UR S6.3 was originally only intended for materials of steel hull structures. The application to machinery and FP systems may fall out of the intended scope of the UR. This issue should be raised with other IACS safety and machinery panels.
- 3) In addition, IACS should be prepared to assign a Polar Service Temperature (PST) on the Polar Ship Certificate for existing vessels of which materials have been certified under UR S6.

End of Document

## Technical Background (TB) document for UR S6 (Rev.9 July 2018)

### 1. Scope and objectives

This revision of UR S6 addresses two topics handled by the hull panel upon request from members.

Limiting temperature UR S6.1:

The material requirements in CSR and UR S6.1 apply for design temperature down to  $-10^{\circ}\text{C}$  and low temperature requirements in S6.2 apply for design temperature below  $-20^{\circ}\text{C}$ . This leaves a gap with no clear requirements to material for ships having a design ambient temperature between  $-10^{\circ}\text{C}$  and  $-20^{\circ}\text{C}$  degrees. It was agreed to develop unified requirements to close this gap. (Hull Panel ref PH16010)

Cold Cargo:

CSR OT and CSR BC&OT include an assumption about cargo temperature between  $0^{\circ}\text{C}$  and  $80^{\circ}\text{C}$ , ref. CSR Pt 1 Ch 1 Sec 1 [1.3.2]. In general bulk carriers and tankers are occasionally loading cargoes with temperature below  $0^{\circ}\text{C}$ , and it has been questioned if additional requirements should apply. The Hull Panel therefore agreed to develop unified requirements for cold cargoes for introduction in UR S6 (Hull Panel ref. PH14005)

### 2. Engineering background for technical basis and rationale

UR S6.1& S6.2 Limiting temperature:

It was decided to update UR S6 to be consistent with CSR and clarify that S6.1 applies for temperature  $-10^{\circ}\text{C}$  and above. In addition it was decided to close the gap between S6.1 and S6.2 by expanding the low temperature requirements in S6.2 to cover temperatures in the range between  $-10^{\circ}\text{C}$  and  $-20^{\circ}\text{C}$ .

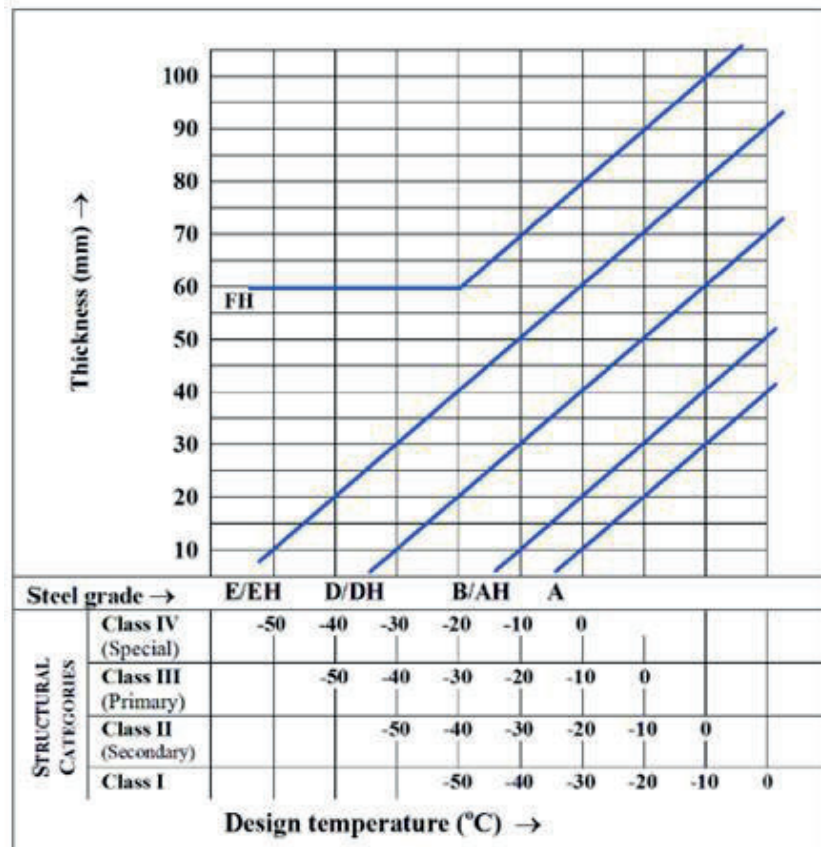
The column which previously covered  $-20^{\circ}\text{C}/-25^{\circ}\text{C}$  has been expanded to cover the temperature range  $-16^{\circ}\text{C}/-25^{\circ}\text{C}$ , 10 degrees difference, similar to columns for lower design temperatures.

In addition a column was added to cover the range  $-11^{\circ}\text{C}/-15^{\circ}\text{C}$ . The applicable material grades were determined using the diagram from DNV Rules for Ships Pt.3 Ch.5 Sec.7 Jan 2015 version as inserted below. The diagram is based on IACS Rec.7 (Guide for the use of hull structural steels for prolonged exposure to low service temperatures - Deleted July 2003). The low temperature requirements in UR S6 are found consistent with the diagram.

It is clarified that S6.2 is applicable to ships intended to operate in low air temperature (below  $-10^{\circ}\text{C}$ ) and the cargo tank boundary of ships intended to carry cargo at low temperature as defined in S6.4.

The S6.2 covers:

- the external structural members directly exposed to low air temperature,
- the internal members made of the plating of longitudinal or transvers bulkheads attached to hull envelope plating exposed to low air temperature (At least one strake is to be considered in the same way as exposed plating and the strake width is to be at least 600 mm.)
- The cargo tank boundary plating of cold cargo as defined in S6.4.



The diagram above is based on DNV rules having 4 different material classes. The "Special", "Primary" and "Secondary" structural categories correspond to Class III, II and I respectively in UR S6.

UR S6.4 Cold Cargo for ships other than liquefied gas carriers:

The design basis in CSR assumes cargo temperature between 0°C and 80°C. It was not part of scope when developing CSR to consider possible carriage of cargoes with temperatures outside of this range. Such temperatures should trigger additional considerations and do not mean that ships other than liquefied gas carriers are not fit for loading cargoes with temperature outside of this range.

Some class societies accept cargo temperature down to -10°C without further consideration and cargoes with even lower temperatures have been loaded based on operator's judgement. Operational precautions may sometimes be taken like e.g.

filling of adjacent ballast tanks before commencement of loading in case of cold cargos.

Carriage of cargo with temperature less than 0°C is not new and operational experience is available. Hull Panel members were therefore requested to collect damage experience related to cold cargo from ships in their class. None of the members could trace information about damages which can be related to cold cargo and this leaves some confidence that ships built according to current rules may be used for this purpose.

When determining the material requirement for cold cargo, comparison was done with the requirements already in place in S6.2. These requirements have been verified through extensive service experience and apply to outer shell. Comparing tank boundaries with the outer shell it may be noted that outer shell:

- Will experience a wider range of temperatures (Polar service temperature is 13 degrees lower than the design temperature)
- Is more prone to impact loads from ice, tug, quay, falling objects etc.
- Has higher hull girder stresses
- Is assigned Class I, II or III in UR S6 Table 1 while no class is assigned to inner bottom, transverse bulkhead or longitudinal bulkhead outside of 0.4L

On the other hand, cargo hold boundaries are exposed to low temperature for a long time. Still comparing with outer shell for which cold temperature requirements are available, the low temperature on cargo tank boundaries is considered less critical. It was therefore concluded that we are on the conservative side making temperature requirements equivalent to requirements for outer shell using "Category I" which apply for structure with moderate hull girder loads.

The requirement to cold cargo is only applied for liquid cargo which will efficiently cool down the tank boundaries. Additional material requirement for loading of cold bulk cargo is not found necessary as the heat transfer between the cargo hold boundary plating and the dry cargo is considered to be less than for liquids. It will also be less dynamic loading on dry cargo hold boundaries than on cargo tank boundaries during voyage.

It is advisable that before the loading operation, the Master pays attention to the possible risk of thermal shock the cargo hold structural members may suffer resulting from the temperature difference between the liquid cargo and the cargo hold surface.

### **3. Source/derivation of the proposed IACS Resolution**

None

### **4. Summary of Changes intended for the revised Resolution:**

S6.2 Table 8 : Cargo tank boundaries include in Category I and footnote 6 added.

S6.2 Table 9 : Updated to include -11/-15°C degrees and -16/-25°C

S6.4 : New paragraph added to address cold cargo

## **5. Points of discussions or possible discussions**

It was discussed to introduce an operational requirement to max temperature difference, 30 degrees, between the cargo and the tank boundary plating. Some considered this requirement to be not satisfactorily justified and therefore not necessary. This point is mentioned in this TB for the paragraph relative to UR S6.4.

## **6. Attachments if any**

None

## UR S7 “Minimum longitudinal strength standards”

### Part A. Revision History

Version no.	Approval date	Implementation date when applicable
Rev.4 (May 2010)	24 May2010	-
Rev.3 (1989)	<i>No record</i>	-
Rev.2 (1978)	<i>No record</i>	-
Rev.1 (1976)	<i>No record</i>	-
NEW (1973)	<i>No record</i>	-

#### • Rev.4 (May 2010)

##### .1 Origin for Change:

- Based on IACS Requirement (*Common Structural Rules for Bulk Carriers and Double Hull Oil Tankers*)

##### .2 Main Reason for Change:

Following the introduction of the IACS Common Structural Rules for Bulk Carriers and Double Hull Oil Tankers, Hull Panel were tasked to review all the UR S files to consider whether or not they are applicable to ships covered by the CSR.

##### .3 List of non-IACS Member classification societies contributing through the TC Forum and/or participating in IACS Working Group:

None.

##### .4 History of Decisions Made:

After review it was decided that for CSR ships the requirements of UR S7 are superseded by those of the Common Structural Rules and therefore do not apply.

Additionally the opportunity was taken to correct an alignment error in S7.1.

##### .5 Other Resolutions Changes

All UR S files, except UR S8, S9, S15, S16, S19, S22, S23, S30 and S31.

##### .6 Dates:

Original proposal: 2007, made by Hull Panel Task 50  
 Panel submission to GPG: 19 April 2010  
 GPG Approval: 24 May 2010 (Ref. 10051\_IGd)

- **Rev.3 (1989)**

No TB document available.

- **Rev.2 (1978)**

No TB document available.

- **Rev.1 (1976)**

No TB document available.

- **NEW (1973)**

No TB document available.

## Part B. Technical Background

List of Technical Background (TB) documents for UR S7:



**Note:** *There are no separate Technical Background (TB) documents for the original resolution (1973), Rev. 1 (1976), Rev. 2 (1978), Rev. 3 (1989) and Rev. 4 (May 2010).*



## UR S8 “Bow Doors and Inner Doors”

### Part A. Revision History

Version no.	Approval date	Implementation date when applicable
Rev. 4 (Dec. 2010)	13 December 2010	1 January 2012
Rev. 3 (Nov 2003)	7 November 2003	-
Corr. (1997)	<i>No record</i>	-
Rev. 2 (1995)	<i>No record</i>	-
New (1982)	<i>No record</i>	-

#### • Rev.4 (Dec 2010)

##### .1 Origin of Change:

- Request by Hull Panel

##### .2 Main Reason for Change:

Since the manual mentioned in Rev.3 S8.8.1 to be kept on board the vessel was required to include a copy of the certificate, each time the certificate was renewed the whole manual also had to be updated. However, noting that the vessel also has to have a copy of the certificate on board it was deemed to be a duplication of information and not necessary to keep updating the whole manual just to include a copy of the certificate that is already available on board.

In addition, Statutory Panel Chairman suggested the editorial amendment to UR S8.1.2b, to make it in line with the SOLAS 2005 Amendments adopted by MSC.194(80).

##### .3 List of non-IACS Member classification societies contributing through the TC Forum and/or participating in IACS Working Group:

None

##### .4 History of Decisions Made:

The Hull Panel agreed to the proposal and created the modifications to no longer require a copy of the certificate in the manuals. This was in turn agreed by the GPG.

Editorial amendment to UR S8.1.2b, which was unanimously agreed by Statutory Panel members was approved by GPG

##### .5 Other Resolutions Changes

UR S9

## **.6 Dates:**

Original Proposal: *14 November 2008*

Panel Approval: *14 October 2010*

GPG Approval: *13 December 2010 (Ref: 10146\_IGc)*

- **Rev. 3 (Nov. 2003)**

According to CG/RRS Task 98-1, CG/RRS prepared draft amendments to S8 /S9 /S15 /S16 (also IG No.8) which were then revised by WP/S. The scope of application in S8 /S9 /S15 /S16 were revised and confirmed by GPG and Council (2081a).

No TB document available.

- **Corr. (1997)**

Minor editorial corrections - S.8.2.1c 'normal' to 'nominal'; S8.7.2d 'indiction' to 'indication'.

No TB document available.

- **Rev.2 (1995)**

No TB document available.

- **New (1982)**

No TB document available.

## **Part B. Technical Background**

List of Technical Background (TB) documents for UR S8:

Annex 1. **TB for Rev.4 (Dec 2010)**

See separate TB document in Annex 1.



*Note: There are no separate Technical Background (TB) documents available for New (1982), Rev.2 (1995), Corr.1 (1997) and Rev.3 (Nov 2003).*

## Technical Background for UR S8 Rev.4, Dec 2010

### 1. Scope and objectives

To address the issue that since the list of information to be placed in the Manual for bow, inner, side and stern doors includes the Certificate, if the Certificate change then the Manual has to be updated.

In addition, Statutory Panel Chairman suggested the editorial amendment to UR S8.1.2b, to make it in line with the SOLAS 2005 Amendments adopted by MSC.194(80).

### 2. Engineering background for technical basis and rationale

Since the manual mentioned in Rev.3 S8.8.1 to be kept on board the vessel was required to include a copy of the certificate, each time the certificate was renewed the whole manual also had to be updated. However, noting that the vessel also has to have a copy of the certificate on board it was deemed to be a duplication of information and not necessary to keep updating the whole manual just to include a copy of the certificate that is already available on board. The Hull Panel agreed to the proposal and created the modifications to no longer require a copy of the certificate in the manuals.

### 3. Source/derivation of the proposed IACS Resolution

UR S8 Rev.3 (Nov 2003)  
SOLAS 2005 Amendments adopted by MSC.194(80).

### 4. Summary of Changes intended for the revised Resolution:

*S8.1.2b An inner door is to be fitted. The inner door is to be part of the collision bulkhead. The inner door needs not be fitted directly above the bulkhead below, provided it is located within the limits specified for the position of the collision bulkhead, refer to regulation II-1/12 ~~II-1/10 or II-1/11~~ of the SOLAS Convention, ~~as appropriate to the type of ship~~. A vehicle ramp may be arranged for this purpose, provided its position complies with regulation II-1/12 ~~II-1/10 or II-1/11~~ of the SOLAS Convention, ~~as appropriate to the type of ship~~. If this is not possible a separate inner weathertight door is to be installed, as far as practicable within the limits specified for the position of the collision bulkhead.*

*S8.8.1 An Operating and Maintenance Manual for the bow door and inner door is to be provided on board and is to contain necessary information on:*

- *main particulars and design drawings*
- *special safety precautions*
- *details of vessel, ~~class, statutory certificates~~*
- *equipment and design loading (for ramps)*
- *key plan of equipment (doors and ramps)*
- *manufacturer's recommended testing for equipment*
- *description of equipment for*

*bow doors*  
*inner bow doors*  
*bow ramp/doors*  
*side doors*  
*stern doors*  
*central power pack*  
*bridge panel*  
*engine control room panel*

## **5. Points of discussions or possible discussions**

The necessity of reporting the revision to IMO was considered since IMO resolutions and documents referred to IACS URs S8 and S9. Finally it was agreed not to submit the revision to URs S8 and S9 to IMO.

## **6. Attachments if any**

None

## UR S9 "Side Shell Doors and Stern Doors"

### Part A. Revision History

Version no.	Approval date	Implementation date when applicable
Rev. 6 (Dec. 2010)	13 December 2010	1 January 2012
Rev. 5 (Nov. 2003)	7 November 2003	-
Rev. 4 (1996)	-	1 July 1997
Rev. 3 (1996)	-	-
Rev. 2 (1993)	-	-
Rev. 1 (1990)	-	-
New (1984)	-	-

- **Rev.6 (Dec 2010)**

**.1 Origin of Change:**

- Request by Hull Panel

**.2 Main Reason for Change:**

Since the manual mentioned in Rev.5 S9.7.1 to be kept on board the vessel was required to include a copy of the certificate, each time the certificate was renewed the whole manual also had to be updated. However, noting that the vessel also has to have a copy of the certificate on board it was deemed to be a duplication of information and not necessary to keep updating the whole manual just to include a copy of the certificate that is already available on board.

**.3 List of non-IACS Member classification societies contributing through the TC Forum and/or participating in IACS Working Group:**

None

**.4 History of Decisions Made:**

The Hull Panel agreed to the proposal and created the modifications to no longer require a copy of the certificate in the manuals. This was in turn agreed by the GPG.

**.5 Other Resolutions Changes**

UR S8

**.6 Dates:**

Original Proposal: 14 November 2008  
 Panel Approval: 14 October 2010  
 GPG Approval: 13 December 2010 (Ref: 10146\_IGc)

- **Rev. 5 (Nov. 2003)**

According to CG/RRS Task 98-1, CG/RRS prepared draft amendments to S8 /S9 /S15 /S16 (also IG No.8) which were then revised by WP/S. The scope of application in S8 /S9 /S15 /S16 were revised and confirmed by GPG and Council (2081a).

No TB document available.

- **Rev.4 (1996)**

No TB document available.

- **Rev.3 (1996)**

No TB document available.

- **Rev.2 (1993)**

No TB document available.

- **Rev.1 (1990)**

No TB document available.

- **New (1984)**

No TB document available.

## Part B. Technical Background

List of Technical Background (TB) documents for UR S9:

Annex 1. **TB for Rev.6 (Dec 2010)**

See separate TB document in Annex 1.



*Note: There are no separate Technical Background (TB) documents available for New (1984), Rev.1 (1990), Rev.2 (1993), Rev.3 (1996), Rev.4 (1996) and Rev.5 (Nov 2003).*



## Technical Background for UR S9 Rev.6, Dec 2010

### 1. Scope and objectives

To address the issue that since the list of information to be placed in the Manual for bow, inner, side and stern doors includes the Certificate, if the Certificate change then the Manual has to be updated.

### 2. Engineering background for technical basis and rationale

Since the manual mentioned in Rev.5 S9.7.1 to be kept on board the vessel was required to include a copy of the certificate, each time the certificate was renewed the whole manual also had to be updated. However, noting that the vessel also has to have a copy of the certificate on board it was deemed to be a duplication of information and not necessary to keep updating the whole manual just to include a copy of the certificate that is already available on board. The Hull Panel agreed to the proposal and created the modifications to no longer require a copy of the certificate in the manuals.

### 3. Source/derivation of the proposed IACS Resolution

UR S9 Rev.5 (Nov 2003)

### 4. Summary of Changes intended for the revised Resolution:

*S9.7.1 An Operating and Maintenance Manual for the side shell doors and stern doors is to be provided on board and is to contain the necessary information on:*

- *main particulars and design drawings*
- *special safety precautions*
- *details of vessel, ~~class, statutory certificates~~*
- *equipment and design loading (for ramps)*
- *key plan of equipment (doors and ramps)*
- *manufacturer's recommended testing for equipment*
- *description of equipment for*
  - *bow doors*
  - *inner bow doors*
  - *bow ramp/doors*
  - *side doors*
  - *stern doors*
  - *central power pack*
  - *bridge panel*
  - *engine control room panel*

### 5. Points of discussions or possible discussions

The necessity of reporting the revision to IMO was considered since IMO resolutions and documents referred to IACS URs S8 and S9. Finally it was agreed not to submit the revision to URs S8 and S9 to IMO.

### 6. Attachments if any

None

## UR S11 “Longitudinal Strength Standard”

### Summary

Based on original document Rec.97, this UR S11 Annex 1 is formulated considering few technical changes and clarifications keeping the application scope same as of UR S11, i.e. excluding CSR BC&OT vessels and container ships. This UR S11 Annex is considered to replace the Rec.97.

### Part A. Revision History

Version no.	Approval date	Implementation date when applicable
Rev.10 (Dec 2020)	10 December 2020	1 January 2022
Rev.9 (June 2019)	27 June 2019	1 July 2020
Rev.8 (June 2015)	02 June 2015	1 July 2016
Rev.7 (Nov 2010)	16 November 2010	1 July 2011
Rev.6 (May 2010)	24 May 2010	-
Rev.5 (Jan 2006)	26 January 2006	1 July 2006
Rev.4 (July 2004)	5 July 2004	-
Rev.3 (June 2003)	20 June 2003	1 July 2003 / 1 July 2004*
Rev.2 (Nov 2001)	9 November 2001	-
Rev.1 (1993)	<i>No record</i>	-
NEW (1989)	<i>No record</i>	-

**\* Note:**

For bulk carriers with notation BC-A, BC-B or BC-C, as defined in UR S25, UR S11 is to be complied with by ships contracted for construction on or after 1 July 2003. For other ships, this revision of UR S11 is to be complied with by ships contracted for construction on or after 1 July 2004.

#### • Rev.10 (Dec 2020)

##### .1 Origin of Change:

- Suggestion by IACS member

##### .2 Main Reason for Change:

The GPG tasked the Hull Panel to identify the IACS resolutions & recommendations, which have not been updated in the past ten years and to determine the documents that need revision.

The Hull Panel concluded that Rec.97 provides a recommendation to designers for obtaining operational flexibility as regards to the filling level of WBT for the application of UR S11.2.1.3. However, UR S11 is applicable to steel ships over 90m in length excluding CSR BC&OT vessels and container ships. Accordingly, Rec.97 should have the same scope of application as S11 and so, should not be applicable to CSR BC&OT and container ships. In view of this, the CSR BC&OT and the container ships cannot refer to Rec.97 giving interpretation of a requirement that is not applicable to them.

This recommendation is not applicable to passenger ships and is not useful for ro-ro ships for which the ballast loading conditions are not generally the most critical ones from the structural point of view.

Currently, typical conventional ore carriers are arranged with 7 cargo holds. In order to meet the technical changes, the illustrations related to ore carriers in relevant Figures are updated with 7 cargo holds and bow shapes are also corrected to be representative of ore carriers.

**.3 List of non-IACS Member classification societies contributing or participating in IACS Working Group:**

N/A

**.4 History of Decisions Made:**

During the HP30 Meeting, the Hull Panel Members confirmed their agreement to update the Rec 97.

One Member proposed updating the references made to the IACS Resolutions since these resolutions were amended.

The Hull Panel discussed the subject via correspondence and unanimously agreed to delete the revision numbers of the relevant URs in order to avoid updates due to simple revisions of these resolutions.

In addition, the references to the "Common Structural Rules for Bulk Carriers" and "Common Structural Rules for Oil Tankers" were superseded by the "Common Structural Rules for Bulk Carriers and Oil Tankers". Therefore, the references in the text were updated accordingly.

Noting that Rec 97 content is also applicable to CSR, one Member proposed to modify the recommendation title. This proposal has been agreed by the Hull Panel.

During the HP31 Meeting, the Hull Panel decided that Rec.97 should have the same scope of application as S11 and so, should not be applicable to CSR BC&OT and container ships. In view of this, the CSR BC&OT and the container ships cannot refer to Rec.97 giving interpretation of a requirement which is not applicable to them. In addition, the definition of Case A, B and C for ship type should be clarified and the figures with scenarios of conventional ore carriers should be amended.

**.5 Other Resolutions Changes:**

None

**.6 Any hindrance to MASS, including any other new technologies:**

None

**.7 Dates:**

Original Proposal: June 2019 (Made by: Hull Panel)

Panel Approval: 16 November 2020 (Ref: 19232\_PHd)  
GPG Approval: 10 December 2020 (Ref: 19232\_IGg)

- **Rev.9 (June 2019)**

**.1 Origin for Change:**

- Suggestion by IACS member (PT56)

**.2 Main Reason for Change:**

References to UR S25 for BC-A, B and C remained in the text while UR S25 has been deleted in May 2010. UR S11A has been developed for covering the Longitudinal Strength Standard for containerhips. However, some requirements of UR S11 were still referring to containerhips; those references are removed. For text simplicity (to avoid text repetitions), the update of S11A in progress will refer to particular paragraphs of S11. For allowing this exception, the scope of application of S11 has been modified by adding the expression "except otherwise mentioned".

Correction of a typo in S11.5.2.1: a square is missing in the  $\square$  expression of the ideal elastic buckling stress in compression of plates.

**.3 List of non-IACS Member classification societies contributing through the TC Forum and/or participating in IACS Working Group:**

None

**.4 History of Decisions Made:**

The decision to revise UR S11 is an outcome of the work of PT56.

**.5 Other Resolutions Changes**

UR S11A (newly introduced)

**.6 Any hindrance to MASS, including any other new technologies:**

None

**.7 Dates:**

Original proposal:	April 2015	Made by: IACS PT56
Panel Approval:	11 June 2019 (Ref: 19093_PHb)	
GPG Approval:	27 June 2019 (Ref: 19093_IGd)	

- **Rev.8 (June 2015)**

**.1 Origin for Change:**

- Suggestion by an IACS member

## **.2 Main Reason for Change:**

UR S11A "Longitudinal Strength Standard for Container Ships" has been introduced which supersedes the requirements of UR S11 with respect to container ships. Hence, the application of UR S11 has been amended such that it does not apply to container ships to which UR S11A is applicable.

## **.3 List of non-IACS Member classification societies contributing through the TC Forum and/or participating in IACS Working Group:**

None

## **.4 History of Decisions Made:**

The decision to revise UR S11 is an outcome of the work of PT56.

## **.5 Other Resolutions Changes**

UR S11A (newly introduced)

## **.6 Dates:**

Original proposal: April 2015 Made by: An IACS member  
Panel Approval: 21 May 2015 by Hull Panel  
GPG Approval: 02 June 2015 (Ref: 8566\_IGzn)

- **Rev.7 (Nov 2010)**

## **.1 Origin for Change:**

- Suggestion by an IACS member (*Action initiated to address UK MAIB recommendations following the MSC Napoli incident*)

## **.2 Main Reason for Change:**

The main technical reason for the change is to clarify strength requirements during sequential ballast water exchange and to include recommendations made in the UK MAIB report on the MSC Napoli incident.

## **.3 List of non-IACS Member classification societies contributing through the TC Forum and/or participating in IACS Working Group:**

None

## **.4 History of Decisions Made:**

The revisions were made through discussions and e-mails within the Hull Panel. ABS incorporated the comments and drafted a final revision. The remainder of the Hull Panel members reviewed and accepted the revisions.

## **.5 Other Resolutions Changes**

None

**.6 Dates:**

Original proposal: *12 April 2010 Made by: An IACS member*  
Panel Approval: *5 October 2010*  
GPG Approval: *16 November 2010 (Ref. 8566\_IGq)*

- **Rev.6 (May 2010)**

**.1 Origin for Change:**

- Based on IACS Requirement (*Common Structural Rules for Bulk Carriers and Double Hull Oil Tankers*)

**.2 Main Reason for Change:**

Following the introduction of the IACS Common Structural Rules for Bulk Carriers and Double Hull Oil Tankers, Hull Panel were tasked to review all the UR S files to consider whether or not they are applicable to ships covered by the CSR.

**.3 List of non-IACS Member classification societies contributing through the TC Forum and/or participating in IACS Working Group:**

None.

**.4 History of Decisions Made:**

After review it was decided that for CSR ships the requirements of UR S11 are superseded by those of the Common Structural Rules and therefore do not apply.

**.5 Other Resolutions Changes**

All UR S files, except UR S8, S9, S15, S16, S19, S22, S23, S30 and S31.

**.6 Dates:**

Original proposal: *2007, made by Hull Panel Task 50*  
Panel submission to GPG: *19 April 2010*  
GPG Approval: *24 May 2010 (Ref. 10051\_IGd)*

- **Rev.5 (Jan 2006)**

See TB document in Part B.

- **Rev.4 (July 2004)**

Addition of 'Contracted for Construction' footnote – no TB document available.

- **Rev.3 (June 2003)**

See TB document in Part B.

- **Rev.2 (Nov 2001)**

See TB document in Part B.

- **Rev.1 (1993)**

No TB document available.

- **NEW (1989)**

No TB document available.

## **Part B. Technical Background**

List of Technical Background (TB) documents for UR S11:

Annex 1. **TB for Rev.2 (Nov 2001)**

See separate TB document in Annex 1.

Annex 2. **TB for Rev.3 (June 2003)**

See separate TB document in Annex 2.

Annex 3. **TB for Rev.5 (Jan 2006)**

See separate TB document in Annex 3.

Annex 4. **TB for Rev.7 (Nov 2010)**

See separate TB document in Annex 4.

Annex 5. **TB for Rev.10 (Dec 2020)**

See separate TB document in Annex 5.

**Note:** *There are no separate Technical Background (TB) documents for the original resolution (1989), Rev.1 (1993), Rev.4 (July 2004), Rev.6 (May 2010), Rev.8 (June 2015) and Rev.9 (June 2019).*



**Technical Background to changes proposed with respect to UR S1A & S11**

The objective of the attached proposals is to prohibit the practice of using partially filled ballast tanks, in design conditions, to control longitudinal strength. To accomplish this, it is proposed that appropriate changes be incorporated into the portion of UR S11.2.1.2 that describes items related to the load conditions that are considered in longitudinal strength calculations. This change also necessitates deletion of a conflicting reference in S1A.3c), which deals with partial filling of peak tanks.

The change was agreed unanimously and no unresolved issues remain.

Submitted by WP/S Chairman on 28 August 2001.

## Technical background of UR S11 rev. 3(June 2003)

### S11.1 Application

As S11 applies to other ship types than bulk carriers with notation BC-A, BC-B or BC-C, two application dates are specified for the requirements in the new revision of UR S11: for the bulks with notation BC-A, BC-B or BC-C, the application date is 1 July 2003, for other ships is 1 July 2004.

#### *S11.2.1.2 Design loading Conditions*

In addition to departure and arrival conditions, transitory conditions are to be considered, where the amount and disposition of consumables are considered more severe.

The objective is to increase the safety at the design stage, reducing the risk to have loading conditions during the voyage that could be critical for the longitudinal strength.

The WP/S agreed that, as the possibilities of transitory loading conditions can be very many, only those supposed to be more critical are to be checked at the design stage. The matter of safe operations must be left to the ship staff after ensuring that the operational limits fixed at the design stage are not too narrow or impractical.

Nevertheless, the safety at the design stage can be increased, requiring checks and planning of ballast change during the transitory conditions between the departure and arrival conditions. Therefore calculations of longitudinal strength of the intermediate conditions just before and just after ballasting and/or deballasting any ballast tank are required.

Loading conditions according to UR S25 are explicitly included.

#### *S11.2.1.3 Partially filled ballast tanks in ballast loading conditions*

The old revision was not clear about the applicability of UR S17 to the ballast conditions, involving partially filling tanks. The text in revision 3 clarifies that these conditions can be used as design conditions provided that UR S17, as applicable, is complied with.

It is also clarified that the ballast conditions, involving partially filling tanks, can be used as design conditions, provided that calculations of longitudinal strength are performed for all filling levels between empty and full

In order to have a manageable number of investigations, for the purpose of design, it is sufficient that the partially filled tanks are assumed to be empty and full, in departure, arrival conditions and any other condition required in S11.2.1.2.

#### *S11.2.1.4 Partially filled ballast tanks in cargo loading conditions*

The requirements for the partial filling are extended to cargo loading condition and not only to ballast condition, as cargo loading conditions involving partially filled peak tanks are to be well controlled in terms of hull girder strength.

Notes by the IACS Permanent Secretariat.

- 1) Council agreed that the last sentence of S11.1 be revised to read for clarity:  
“For other ships ~~types~~, this revision of this UR is to be....”.
- 2) Council decided that the implementation date of S11(Rev.3) and S17(Rev.5) should be aligned with that of UR S25 – 1 July 2003. NK will implement UR S25 from 1 January 2004. In the interim period between 1 July 2003 and 1 January 2004 NK will recommend that Owners/Builders stipulate in their contract compliance with URs S11 Rev.3 and S17 Rev.5 when UR S25 is applied.

**Adopted on 20 June 2003.**

## Technical Background

### UR S11 (**Rev.5**, Jan 2006)

#### **1. Scope and objective**

##### 1.1 Application of UR S11.2.1.3 and S11.2.1.4 to Ballast Water Exchange

Ballast water exchange sequences are to be included in the LM as per UR S1, UR S1A and S11.2.1.2 and are to be approved. However there is no need to check that the longitudinal strength is complied with for any filling levels between full and empty.

Therefore IACS Hull Panel proposes to insert a new sub-section S11.2.1.5 in order to clarify the application of UR S11.2.1.3 and UR S11.2.1.4 with regard to sequential ballast water exchange.

##### 1.2 Application of UR S11.2.1.3 and S11.2.1.4 to Ore carrier

In case of ore carriers defined in UR Z11.2.3 as given below, which have large wing ballast tanks, design loading conditions may include two pairs of partially filled ballast tanks. There are loading limits, other than full and empty, due to reasons other than longitudinal strength such as propeller immersion and bridge visibility. Where these limits exist, they will serve as alternate limits to full or empty condition in S11.2.1.3. The current text of S11.2.1.3 and S11.2.1.4 might require longitudinal strength check for the unrealistic virtual ballast/cargo loading conditions, which are far beyond the above-mentioned limits. Therefore IACS Hull Panel proposes to modify sub-section S11.2.1.3 to solve this problem by introducing criteria which give the thresholds of loading conditions.

### Z11.2.3 Ore Carrier

The ship type notation "ORE CARRIER", or equivalent, and the notation "ESP" shall be assigned to sea going self-propelled single deck ships having two longitudinal bulkheads and a double bottom throughout the cargo region and intended for the carriage of ore cargoes in the centre holds only. A typical midship section is given in Figure 3.



Fig. 3

## 2. Points of discussions or possible discussions

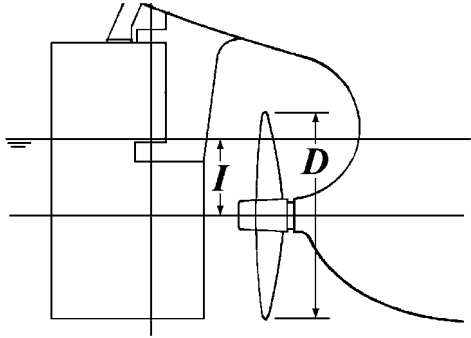
### 2.1 Application of UR S11.2.1.3 and S11.2.1.4 to Ballast Water Exchange

Review the applicability of S11.2.1.3 and S11.2.1.4 to ballast tank during ballast water exchange and resolve the problem arising from the current text.

### 2.2 Application of UR S11.2.1.3 and S11.2.1.4 to Ore carrier

When the design stress limit cannot be achieved with empty / full condition for one or two pairs of Wing Ballast Tanks, the longitudinal strength check is performed for partial filling of these tanks within the filling limitations. The pair of tanks is understood to be similar and symmetrical along the centre line. The filling limitations correspond to 3 extreme conditions of trim as follows:

- Trim by stern of 3% of ship's length
- Trim by bow of 1.5% of ship's length
- Any trim that cannot maintain propeller immersion ( $I/D$ ) not less than 25%, where;  
I = the distance from propeller centerline to the waterline  
D = propeller diameter  
(see the following figure)



**3. Source/ derivation of proposed requirement**

Hull Panel

**4. Decision by voting**

N.A.

Submitted by Hull Panel Chairman

26 Oct 2005

## **Technical Background for UR S11 Rev.7, Nov 2010**

### **1. Scope and objectives**

Revisions are being made to clarify documentation of hull girder strength during sequential ballast water exchange and to incorporate recommendations made by the UK MAIB in their report on the investigation into the structural failure of the MSC Napoli.

### **2. Engineering background for technical basis and rationale**

Evaluation of hull girder longitudinal strength during a sequential ballast water exchange process and the inclusion of this information in the loading manual or ballast water management plan are considered important and necessary.

Among the recommendations from the UK MAIB investigations into the MSC Napoli incident, it asks for a review of UR S11 to ensure that hull girder and buckling strength checks are carried out at all critical sections along the entire length of a vessel.

### **3. Source/derivation of the proposed IACS Resolution**

The source of the information was obtained through the input of the Hull Panel members.

### **4. Summary of Changes intended for the revised Resolution:**

New text describing requirements covering items mentioned in 2 above are introduced in this revision of the UR.

### **5. Points of discussions or possible discussions**

The revisions were made through discussions and e-mails within the Hull Panel which involved mainly incorporating individual comments and accepting the consolidated text.

### **6. Attachments if any**

None

## Technical Background (TB) document of UR S11 (Rev.10 Dec 2020)

### Addition of Annex 1 Recommendation for UR S11.2.1.3 for cargo vessels

#### 1 Scope and objectives

Original version(Rec.97,2007) was made to provide the guidance and interpretation of UR S11.2.1.3 "Partially filled ballast tanks in ballast loading conditions" for the cargo ships including CSR BC & OT and Ore Carriers & container ships. During technical review within the Hull Panel it was concluded that Rec.97 should be applicable for only Steel ships which are under the scope of application of UR S11 and should not be applicable to CSR BC & OT and container vessels. In this regard, the contents of Rec.97 should be updated and the document will be replaced with new Annex 1 of UR S11 accordingly.

#### 2 Engineering background for technical basis and rationale

##### 2.1 Identify ships needing recommendation on "Partially filled ballast tanks in ballast loading conditions" stated in S11.2.1.3

Technically, any cargo vessel (such as general cargo ships, bulk carriers and oil & chemical tankers as well as ore carriers etc.), which might have one BW Tank (or one pair of BW Tanks) partially filled, might have the loading scenarios of "Partially filled ballast tanks in ballast loading conditions" for adjusting its real draught. Therefore, this recommendation applies to any cargo vessel with one BW Tank (or one pair of BW Tanks) partially filled, which might operate with "partially filled ballast tanks in ballast loading conditions".

##### 2.2 The definition of Case A, B and C

From 2.1 above, the original text for describing Case A and B are suggested to be kept, i.e. "Case A and B are generally applicable for ballast loading conditions for any cargo vessel which might have one BW Tank (or one pair of BW Tanks) partially filled."

Case A has no limitation on % consumables for filling the partial ballast tank, whereas Case B has limitation to fill partial ballast tank in terms of certain % of consumables.

For Case C, i.e. "no partial filling of ballast tank is allowed during ballast voyage", it might be misleading since it is out of the scope of this recommendation concerning "partially filled ballast tanks". In addition, Case C can be also referred to UR S11.2.1.2. In view of that, Case C is suggested to be deleted in this recommendation, and original Case D will be changed as new Case C in the new document due to renumbering.

##### 2.3 Update for conventional ore carrier with two pairs of partially filled ballast water tanks

Currently, typical conventional ore carriers are arranged with 7 cargo holds. In order to meet the technical changes, the illustrations related to ore carriers in relevant Figures are updated with 7 cargo holds and bow shapes are also corrected to be representative of ore carriers'.

#### 3 Source/derivation of the proposed IACS Resolution

The source of the information was obtained through the working group from some IACS members supervised by the Hull Panel.

#### 4 Summary of Changes intended for the revised Resolution

New Annex 1 added.

#### 5 Points of discussions or possible discussions

- 1) The definition of Case A, B and C (objective or purpose and the scope of application;
- 2) Update the type of conventional ore carriers (increase the number of cargo holds in relevant Figures and modify bow shape for ore carriers' etc, );
- 3) Delete original Case C;
- 4) Give the requirement for "peak tank" instead of referring to CSR.

#### 6 Attachments if any

None.



## UR S10 “Rudders, sole pieces and rudder horns”

### Summary

The Rev. 7 Corr.2 of UR S10 has been prepared to correct the editorial errors with respect to formulas for semi spade rudder with 2-conjugate elastic support stipulated in Annex S10.6.

### Part A. Revision History

Version no.	Approval date	Implementation date when applicable
Corr.2 (May 2024)	14 May 2024	-
Corr.1 (June 2023)	20 June 2023	-
Rev.7 (Feb 2023)	16 February 2023	1 July 2024
Rev.6 (Sep 2019)	20 Sep 2019	1 January 2021
Rev.5 (May 2018)	16 May 2018	1 July 2019
Corr.1 (Dec 2015)	22 December 2015	-
Rev.4 (Apr 2015)	3 April 2015	1 July 2016
Corr.1 (Apr 2015)	14 April 2015	-
Rev.3 (Mar 2012)	15 March 2012	1 January 2013
Rev.2 (May 2010)	24 May 2010	-
Corr.2 (July 2003)	16 July 2003	-
Corr.1 (July 1999)	13 July 1999	-
Rev.1 (1990)	<i>No record</i>	-
NEW (1986)	<i>No record</i>	-

#### • Rev.7 Corr.2 (May 2024)

##### 1 Origin for Change:

- Suggestion by IACS Members

##### 2 Main Reason for Change:

An IACS member found editorial errors on formulas for semi spade rudder with 2-conjugate elastic support stipulated in Annex S10.6.

Having compared with the formulas of  $k_{12}$  and  $k_{22}$  in the UR S10 TB as shown below, it should be modified that the first formula above is for  $K_{12}$ , and the second one for  $K_{22}$ .

$$k_{12} = k_{21} = 1.3 \cdot \left[ \frac{l_1^3}{3EJ_{1h}} + \frac{l_1^2 \cdot (d - l_1)}{2EJ_{1h}} \right] + \frac{l_1 \cdot e^2}{GJ_{th}} \quad (18b)$$

$$k_{22} = 1.3 \cdot \left[ \frac{l_1^3}{3EJ_{1h}} + \frac{l_1^2 \cdot (d - l_1)}{EJ_{1h}} + \frac{l_1 \cdot (d - l_1)^2}{EJ_{1h}} + \frac{(d - l_1)^3}{3EJ_{2h}} \right] + \frac{d \cdot e^2}{GJ_{th}} \quad (18c)$$

In this regard, Hull Panel confirmed that it should be corrected, and the formulas are modified as below.

$$K_{\frac{22}{12}} = 1.3 \left[ \frac{\lambda^3}{3EJ_{1h}} + \frac{\lambda^2(d - \lambda)}{2EJ_{1h}} \right] + \frac{e^2 \lambda}{GJ_{th}}$$

$$K_{\frac{12}{22}} = 1.3 \left[ \frac{\lambda^3}{3EJ_{1h}} + \frac{\lambda^2(d - \lambda)}{EJ_{1h}} + \frac{\lambda(d - \lambda)^2}{EJ_{1h}} + \frac{(d - \lambda)^3}{3EJ_{2h}} \right] + \frac{e^2 d}{GJ_{th}}$$

### 3 Surveyability review of UR and Auditability review of PR

None

### 4 List of non-IACS Member Classification Societies contributing or participating in IACS Working Group:

None

### 5 History of Decisions Made:

Editorial errors with respect to the formulas for semi spade rudder with 2-conjugate elastic support in Annex S10.6 are found by an IACS member. The corrected formulas are checked by the member as well as Hull Panel Chair.

It is proposed to be corrected as a corrigendum and it is confirmed through discussion within hull panel.

### 6 Other Resolutions Changes:

None

### 7 Any hinderance to MASS, including any other new technologies:

None

### 8 Dates:

Original proposal	: 27 February 2024	(Made by IACS Member)
Panel Approval	: 26 April 2024	(Ref: PH24008_IHd)
GPG Approval	: 14 May 2024	(Ref: 22203_IGg)

• **Rev.7 Corr.1 (June 2023)**

**1 Origin for Change:**

- Suggestion by IACS Members

**2 Main Reason for Change:**

An IACS member found an editorial error about the rudder stock diameter's formula stipulated in S10.4.2.

The Rev.7 stipulates the following formula.

$$d_c = d_t \sqrt[6]{1 + \frac{4}{3(M/Q_R)^2}} \quad [\text{mm}]$$

On the other hand, the previous version Rev.6 stipulates the following formula.

$$d_c = d_t \sqrt[6]{1 + 4/3(M/Q_R)^2} \quad [\text{mm}]$$

Though this part is not modified in the rev.7, this formula is changed.

And it considers that the following formula is correct intention in this UR.

$$d_c = d_t \sqrt[6]{1 + \frac{4}{3} \left(\frac{M}{Q_R}\right)^2} \quad [\text{mm}]$$

It is regarded as an editorial error and is corrected as a corrigendum.

**3 List of non-IACS Member Classification Societies contributing or participating in IACS Working Group:**

None

**4 History of Decisions Made:**

An editorial error with respect to the rudder stock diameter's formula in S10.4.2 is found by an IACS member. The corrected formula is checked by the member as well as Hull Panel Chair.

It is proposed to be corrected as a corrigendum and it is confirmed through discussion within hull panel.

**5 Other Resolutions Changes:**

None

**6 Any hinderance to MASS, including any other new technologies:**

None

## **7 Dates:**

Original proposal	: 21 April 2021	(Made by IACS Member)
Panel Approval	: 05 June 2023	(Ref: PH21023_IHt)
GPG Approval	: 20 June 2023	(Ref: 22203_IGe)

## **• Rev.7 (Feb 2023)**

### **1 Origin for Change:**

- Suggestion by IACS Members

### **2 Main Reason for Change:**

IACS Members have been contacted by industry partners in view of the requirements to sealing equipment and the requirements related to the push-up lengths in case of cone couplings mainly for pintles.

Additionally, the Hull Panel considered further input of its members in view of improving the IACS requirements.

### **3 List of non-IACS Member Classification Societies contributing through the TC Forum and/or participating in IACS Working Group:**

None

### **4 History of Decisions Made:**

Discussion related to changes of UR S10 started in August 2021 related to the formulations regarding sealing requirements in UR S10 1.2.3.

During the following discussions further issues with the requirements in UR S10 were identified and change proposals were discussed. The Hull Panel decided via correspondence and discussion during the regular HP meetings to implement the following modifications:

- clarify the application of UR in 1.1.2 (for ships with  $L \geq 24m$ )
- clarify the requirement regarding sealing equipment in 1.2.3 including the definition of the waterline to be applied
- clarify the welding requirements for rudder side plating and between plates and heavy pieces in 1.4.3
- clarify and align the speed in astern condition with SOLAS II-1/3.15
- clarify the bending forces and moments for spade rudder with trunk extending inside the rudder in Annex S10.3 and subsequent requirements n 4.2 and 6.4.2
- clarify and improve the push-up pressure and push-up length requirements for pintle cone couplings in 7.2.2
- Clarify the requirements of fittings of liners for rudder stocks having diameter less than 200 mm in 8.1.1

- clarification for the requirements for fillet shoulder radius in case of trunks extending below shell or skeg in 9.3
- furthermore, editorial changes and renumbering of figures

## 5 Other Resolutions Changes

None

## 6 Any hinderance to MASS, including any other new technologies:

None

## 7 Dates:

Original proposal	: 16 August 2021	(Made by IACS Member)
Panel Approval	: 20 December 2022	(Ref: PH21023_IHq)
GPG Approval	: 16 February 2023	(22203_IGc)

## • Rev.6 (Sep 2019)

### 1 Origin for Change:

- Suggestion by IACS Members

### 2 Main Reason for Change:

IACS Members have been contacted by industry partners in view of updating the UR S10 considering the ultimate technology applied to the construction of rudder, sole pieces and horns.

Additionally the Hull Panel considered the practical experience of its Members damage reports in view of improving the IACS requirements.

### 3 List of non-IACS Member Classification Societies contributing through the TC Forum and/or participating in IACS Working Group:

None

### 4 History of Decisions Made:

During Hull Panel Meeting 30<sup>th</sup> the Members decided to evaluate the UR S10 in view of identifying possible modifications to be implemented in this resolution.

The Hull Panel decided via correspondence to implement the following modifications:

- clarify the application of the required radii in way of the solid part in cast steel
- address vague text "to be specially considered; if not known:" in Table 1
- clarify the definition of Rudder areas "A<sub>1</sub> and A<sub>2</sub>" used for calculating the rudder forces and torques

- indicate the radius in the critical corners of cover plates in figure 3
- make the definition “ $l$ ” used for calculating the push-up pressure of cone coupling more appropriate
- clarify the definition of outer diameter of gudgeon ( $d_a$ ) used in the permissible push up pressure
- clarify that synthetic material with hardness greater than 70 Shore D is accepted as a rudder bearing material
- correct a misprint in figure 7
- make the application of rudder trunk requirements more appropriate
- the minimum specified yield stress  $\sigma_F$  symbol has been replaced by  $R_{eH}$  adopting a consistent approach within the different IACS documents
- the different symbols utilized in the formulas have been modified to Italic font and the text updated where appropriate

## 5 Other Resolutions Changes

None

## 6 Any hinderance to MASS, including any other new technologies:

None

## 7 Dates:

Original proposal: 9 November 2018 made by IACS Member

Panel Approval: 22 August 2019 (Ref: PH18023\_IHp)

GPG Approval: 20 September 2019 (Ref: 19158\_IGb)

## • Rev.5 (May 2018)

### .1 Origin for Change:

- Suggestion by IACS Members

### .2 Main Reason for Change:

To correct inconsistencies and/or clarify requirements identified in the text of Rev. 4 and Annexes.

To improve the requirements for dimension of gudgeon and cone coupling push-up length.

### .3 List of non-IACS Member Classification Societies contributing through the TC Forum and/or participating in IACS Working Group:

None.

### .4 History of Decisions Made:

Some corrections, missing definitions and clarifications have been identified in the UR text Rev. 4 Corr.1 and the Hull Panel decided to issue a new Revision to solve these

issues, namely: S.10.5.1a), S.10.5.3.1, S.10.5.3.3, S.10.6.4.3, S.10.7.2.2, S.10.9.3.1, Annexes S10.3 and S10.6.

Additionally, improvement of gudgeon and cone push-up length dimensioning formulas have been introduced in S.10.6.4.2, S.10.6.4.3.  
Removal of the minimum push-up length further to a Member request.

For detailed information regarding the different modifications introduced in this revision please refer to the TB section (Annex 3).

#### **.5 Other Resolutions Changes**

None.

#### **.6 Dates:**

Original proposal: 18 August 2016 made by IACS Member  
Panel Approval: 19 April 2018 (Ref: PH16025)  
GPG Approval: 16 May 2018 (Ref: 12121aIGh)

### **• Rev.4 Corr.1 (Dec 2015)**

#### **.1 Origin for Change:**

Suggestion by IACS member

#### **.2 Main Reason for Change:**

To correct the identified inconsistencies and errata in Rev.4 of the document.

#### **.3 List of non-IACS Member classification societies contributing through the TC Forum and/or participating in IACS Working Group:**

None.

#### **.4 History of Decisions Made:**

PM of the PT62 and Hull Panel Members identified some consistencies and errata in Rev.4 of UR S10. It was decided to issue a Corr.1 of the document. Implementation date of version will be aligned with the implementation date of Rev. 4, i.e. 1 July 2016.

#### **.5 Other Resolutions Changes**

None.

#### **.6 Dates:**

Original proposal: 13 August 2015

Panel Approval: 30 November 2015 (Ref: PH11031)  
GPG Approval: 22 December 2015 (Ref: 12121\_IGn)

- **Rev.4 (Apr 2015)**

**.1 Origin for Change:**

Suggestion by IACS member

**.2 Main Reason for Change:**

Since UR S10 was first issued in 1986, only minor changes have been carried out. In 2006, more comprehensive and modern rudder requirements were introduced for CSR-BC. It was subsequently decided that the rudder requirements in CSR-BC would not be continued in CSR-BC & OT but that it was desirable to retain the improvements introduced in CSR-BC by updating UR S10.

**.3 List of non-IACS Member classification societies contributing through the TC Forum and/or participating in IACS Working Group:**

None.

**.4 History of Decisions Made:**

Please see Part B, Technical Background, Annex 2 for a detailed summary table of the decisions made.

**.5 Other Resolutions Changes**

None.

**.6 Dates:**

Original proposal: 05 July 2012  
Panel submission to GPG: 10 Feb 2015 by Hull Panel  
GPG Approval: 3 April 2015 (Ref: 12121\_IGk)

- **Rev.3 Corr.1 (Apr 2015)**

**.1 Origin for Change:**

Suggestion by IACS member

**.2 Main Reason for Change:**

To clarify that bulk carriers contracted for construction between 1 July 2015 and 30 June 2016 are subject to CSR-BC.

**.3 List of non-IACS Member classification societies contributing through the TC Forum and/or participating in IACS Working Group:**

None.



#### **.4 History of Decisions Made:**

A Member proposed to add a footnote "Bulk carriers contracted for construction between 1 July 2015 and 30 June 2016 are subject to CSR-BC" into UR S10 Rev .4. However, Rev. 4 will be applicable only from 1 July 2016 and the users of the UR will not be able to see the footnote until 1 July 2016. It was proposed that the footnote could be included in UR S10 Rev. 3 through a corrigendum (Ref: 12121\_RId). GPG agreed to this proposal and tasked the Permanent Secretariat to issue a Corrigendum for UR S10 (Rev.3).

#### **.5 Other Resolutions Changes**

None.

#### **.6 Dates:**

Original proposal: 7 April 2015 by a Member  
GPG Approval: 14 April 2015 (Ref. 12121\_IGI)

#### **• Rev.3 (Mar 2012)**

##### **.1 Origin for Change:**

Suggestion by IACS member

##### **.2 Main Reason for Change:**

Members have been contacted a number of times by designers who asked if the bearing clearance of S10.8.3 could be smaller for non-metallic bearings. Designers noted that some IACS societies had approved smaller clearances based on special considerations.

##### **.3 List of non-IACS Member classification societies contributing through the TC Forum and/or participating in IACS Working Group:**

None.

##### **.4 History of Decisions Made:**

After review it was decided by the Hull Panel that for non-metallic bearing materials a smaller clearance could be considered.

##### **.5 Other Resolutions Changes**

None.

##### **.6 Dates:**

Original proposal: 15<sup>th</sup> Hull Panel meeting (October 2011)

Panel submission to GPG: 02 December 2011  
GPG Approval: 15 March 2012 (Ref. 12027\_IGc)

- **Rev.2 (May 2010)**

**.1 Origin for Change:**

- Based on IACS Requirement (*Common Structural Rules for Bulk Carriers and Double Hull Oil Tankers*)

**.2 Main Reason for Change:**

Following the introduction of the IACS Common Structural Rules for Bulk Carriers and Double Hull Oil Tankers, Hull Panel were tasked to review all the UR S files to consider whether or not they are applicable to ships covered by the CSR.

**.3 List of non-IACS Member classification societies contributing through the TC Forum and/or participating in IACS Working Group:**

None.

**.4 History of Decisions Made:**

After review it was decided that for CSR bulk carriers the requirements of UR S10 are superseded by those of the Common Structural Rules and therefore do not apply. However for CSR oil tankers the requirements of UR S10 are still valid.

Additionally the opportunity was taken to correct a couple of equations in S10.1 and S10.3.

**.5 Other Resolutions Changes**

All UR S files, except UR S8, S9, S15, S16, S19, S22, S23, S30 and S31.

**.6 Dates:**

Original proposal: 2007, made by Hull Panel Task 50  
Panel submission to GPG: 19 April 2010  
GPG Approval: 24 May 2010 (Ref. 10051\_IGd)

- **Corr.2 (July 2003)**

No TB document available.

- **Corr.1 (July 1999)**

Editorial correction to equation for  $d_t$  in Section S10.3 – no TB document available.

- **Rev.1 (1990)**

No TB document available.

- **New (1986)**

No TB document available.

## **Part B. Technical Background**

List of Technical Background (TB) documents for UR S10:

Annex 1. **TB for Rev.3 (Mar 2012)**

See separate TB document in Annex 1.

Annex 2. **TB for Rev.4 (Apr 2015)**

See separate TB document in Annex 2.

Annex 3 **TB for Rev.5 (May 2018)**

See separate TB document in Annex 3.

Annex 4 **TB for Rev.6 (Sep 2019)**

See separate TB document in Annex 4.

Annex 5 **TB for Rev.7 (Feb 2023)**

See separate TB document in Annex 5.

**Note:** *There are no separate Technical Background (TB) documents for the original resolution (1986), Rev.1 (1990), Corr.1 (July 1999), Corr.2 (July 2003), Rev.2 (May 2010), Corr.1 (Apr 2015), Corr.1 (Dec 2015), Corr.1 (June 2023) and Corr.2 (May 2024).*

## **Technical Background for UR S10 Rev.3, March 2012**

### **1. Scope and objectives**

This revision is limited to S10.8.3 and the change in bearing clearance associated with non-metallic bearing materials. The consequence of this change is that reduced bearing clearances may be seen for non-metallic bearings.

### **2. Engineering background for technical basis and rationale**

As stated in the S10.8.3, smaller clearances may be permitted considering the material's swelling and thermal expansion properties upon the discretion of the Society, when supported by the manufacturer's recommendation and documented evidence of satisfactory service history with reduced clearances.

### **3. Source/derivation of the proposed IACS Resolution**

None.

### **4. Summary of Changes intended for the revised Resolution:**

The change to S10.8.3 entails deleting the text "in no way" from the third sentence and adding the fourth sentence.

### **5. Points of discussions or possible discussions**

This change was agreed by the Hull Panel during the 13th and 14th meetings which took place in late 2010 and early 2011.

### **6. Attachments if any**

None

## **Technical Background for UR S10 Rev.4, Apr 2015**

### **1. Scope and objectives**

UR S10 shall be updated based on more modern and comprehensive requirements in CSR BC.

### **2. Engineering background for technical basis and rationale**

Please refer to detailed technical background document.

### **3. Source/derivation of the proposed IACS Resolution**

The source of the information was obtained through work performed by a dedicated project team.

### **4. Summary of Changes intended for the revised Resolution:**

Please refer to attached Summary of changes in table format.

### **5. Points of discussions or possible discussions**

None

### **6. Attachments if any**

- a) Summary of changes in table format
- b) Detailed technical background document

## Summary of changes in table format

Sec	Sec Name	Art	Art Name	Sub-Art	Sub-Art Name	Basis	Reference	Comment	Type of modification (to UR S10 Rev.3 or CSR BC respectively)
10.1	General								
		1.1	Basic assumptions						
				1.1.1		S10 Rev.3	1.1.1	Copy	
				1.1.2		New	-	New requirement	Editorial
		1.2	Design considerations						
				1.2.1		S10 Rev.3	1.2.1	Copy	
				1.2.2		S10 Rev.3	1.2.2	Copy	
				1.2.3		S10 Rev.3	1.2.3	Copy	
		1.3	Materials						
				1.3.1		S10 Rev.3	1.3.3	Item split. Copy of first sentence	Editorial
				1.3.2		S10 Rev.4	1.3.3	Rephrased	Editorial
				1.3.3		New	-	Reference to UR S6	Editorial
				1.3.4		S10 Rev.3	1.3.1	Copy of first part	Editorial
				1.3.5		S10 Rev.3	1.3.1	Copy of second part	Editorial
		1.4	Welding and design details						
				1.4.1		New	-	New requirement	Technical
				1.4.2		CSR BC	Ch10 Sec1 [5.1.4]	Based on CSR BC, with additional requirements	Technical
				1.4.3		New	-	New requirement	Technical
				1.4.4		New	-	Reference to rule	Editorial
				1.4.5		New	-	Reference to rule	Editorial
				1.4.6		New	-	Reference to rule	Editorial
		1.5	Equivalence						

				1.5.1		New	-	New requirement	Technical
				1.5.2		New	-	New requirement	Technical
				1.5.3		New	-	New requirement	Technical
<b>10.2</b>	<b>Rudder force and rudder torque</b>								
		<b>2.1</b>	<b>Rudder blades without cut-outs (Fig. 1)</b>						
				2.1.1		S10 Rev.3	2.1.1	New profile types added. Thrust coefficient deleted.	Technical
				2.1.2		S10 Rev.3	2.1.2	Slightly rephrased	Editorial
		<b>2.2</b>	<b>Rudder blades with cut-outs (semi-spade rudders)</b>			S10 Rev.3	2.2	Corrected $K_1$ and $K_2$ to $k_1$ and $k_2$ respectively, otherwise copy	Editorial
<b>10.3</b>	<b>Rudder strength calculation</b>								
		<b>3.1</b>				S10 Rev.3	4.1	Copy	
		<b>3.2</b>				S10 Rev.3	4.2	Copy	
<b>10.4</b>	<b>Rudder stock scantlings</b>							Modified heading	Editorial
		<b>4.1</b>				S10 Rev.3	3.1	Copy	
		<b>4.2</b>	<b>Rudder stock scantlings due to combined loads</b>			S10 Rev.3	4.3	Definition of material factor added, otherwise copy	Editorial
		<b>4.3</b>	<b>Reduction in rudder stock diameter</b>			S10 Rev.3	1.3.2	Slightly rephrased	Editorial
<b>10.5</b>	<b>Rudder blade</b>							Modified heading	Editorial
		<b>5.1</b>	<b>Permissible stresses</b>			S10 Rev.3	5.1	Material factor included in the formulas. Clarification of	Editorial and technical



								allowable stress for semi spade rudders	
		<b>5.2</b>	<b>Rudder plating</b>		S10 Rev.3	5.2		Material factor included in the formula	Editorial
		<b>5.3</b>	<b>Connections of rudder blade structure with solid parts</b>						
				5.3.1		CSR BC	Ch10 Sec1 [5.3.6]	Rephrased. Welding requirement covered by S10 1.4	Editorial
				5.3.2		CSR BC	Ch10 Sec1 [5.3.1]	Rephrased	Editorial
				5.3.3		CSR BC	Ch10 Sec1 [5.3.2] Ch10 Sec1 [5.3.3]	Merged and copy.	Editorial
				5.3.4		CSR BC	Ch10 Sec1 [5.3.4]	Last sentence moved to 5.3.5. Some rephrasing, otherwise copy	Editorial
				5.3.5		CSR BC	Ch10 Sec1 [5.3.5]	Extent of reinforcement clarified, otherwise copy	Editorial
		<b>5.4</b>	<b>Single plate rudders</b>						
				5.4.1	Mainpiece diameter	S10 Rev.3	5.3.1	Copy	
				5.4.2	Blade thickness	S10 Rev.3	5.3.2	Material factor included in the formula	Editorial
				5.4.3	Arms	S10 Rev.3	5.3.3	Material factor included in the formula	Editorial
<b>10.6</b>	<b>Rudder stock couplings</b>								
		<b>6.1</b>	<b>Horizontal flange couplings</b>						

				6.1.1		S10 Rev.3	6.1.1	Copy		
				6.1.2		S10 Rev.3	6.1.2	Rephrased	Editorial	
				6.1.3		S10 Rev.3	6.1.3	Rephrased	Editorial	
				6.1.4		CSR BC	Ch10 Sec1 [10.1.3]	Rephrased	Editorial	
				6.1.5		New	-	New requirement	Technical	
		<b>6.2</b>	<b>Vertical flange couplings</b>							
				6.2.1		S10 Rev.3	6.3.1	<i>d</i> clarified, otherwise copy	Editorial	
				6.2.2		S10 Rev.3	6.3.2	Unit clarified, otherwise copy	Editorial	
				6.2.3		S10 Rev.3	6.3.3	Rephrased	Editorial	
				6.2.4		New	-	New requirement	Technical	
		<b>6.3</b>	<b>Cone couplings with key</b>							
				6.3.1	Tapering and coupling length	S10 Rev.3	6.2.1	Rephrased	Editorial	
				6.3.2	Dimensions of key	CSR BC CSR BC	Ch10 Sec1 [4.4.3] Ch10 Sec1 [4.4.4]	Text clarified.	Editorial	
				6.3.3		S10 Rev.3	6.2.2	Copy		
				6.3.4	Push up	CSR BC	Ch10 Sec1 [4.4.6]	Copy		
				6.3.5		New		New requirement	Technical	
		<b>6.4</b>	<b>Cone couplings with special arrangements for mounting and dismounting the couplings</b>							
				6.4.1	General	S10 Rev.3 CSR BC CSR BC CSR BC	6.2.3 Ch10 Sec1 [4.5.1] Ch10 Sec1 [4.5.2] Ch10 Sec1 [4.5.3]	Text copied from CSR BC, covering also S10 6.2.3	Editorial	
				6.4.2	Push up pressure	CSR BC	Ch10 Sec1 [4.5.4]	Copy		
				6.4.3	Push up length	CSR BC	Ch10 Sec1 [4.5.5]	Minimum push up length added, otherwise copy	Technical	

<b>10.7</b>	<b>Pintles</b>							
	<b>7.1</b>	<b>Scantlings</b>			S10 Rev.3	7.1	Rule item split in two.	Editorial
	<b>7.2</b>	<b>Couplings</b>						
			7.2.1	Tapering	S10 Rev.3	7.1	Copy.	
			7.2.2	Push up pressure	CSR BC	Ch10 Sec1 [4.5.6]	Copy	
	<b>7.3</b>	<b>Threads and nuts</b>			S10 Rev.3	7.2	Copy	
	<b>7.4</b>	<b>Pintle housing</b>			S10 Rev.3	9.3	Rule item split in two.	Editorial
<b>10.8</b>	<b>Rudder stock bearing, rudder shaft bearing and pintle bearing</b>							
	<b>8.1</b>	<b>Liners and bushes</b>						
			8.1.1	Rudder stock bearing	CSR BC	Ch10 Sec1 [5.4.1]	Slightly rephrased Sentence regarding small ships removed	Editorial
			8.1.2	Pintle bearing	CSR BC	Ch10 Sec1 [5.5.2]	Copy	
	<b>8.2</b>	<b>Minimum bearing surface</b>			S10 Rev.3	8.1	Added footnote regarding maximum surface pressure for synthetic material	Editorial
	<b>8.3</b>	<b>Bearing dimensions</b>			S10 Rev.3 S10 Rev.3	8.2 9.3	8.2 and first paragraph of 9.3 copied and merged	Editorial
	<b>8.4</b>	<b>Bearing clearances</b>			S10 Rev.3	8.3	Copy	
<b>10.9</b>	<b>Sole pieces, rudder horns, and rudder trunks</b>							
	<b>9.1</b>	<b>Sole piece</b>			S10 Rev.3	9.1	Copy	
			9.1.1	Equivalent stress	S10 Rev.3	9.1.1	Copy	
	<b>9.2</b>	<b>Rudder horn</b>			S10 Rev.3	9.2	Load calculation	Editorial

								moved to annex, otherwise copy within d deleted	
				9.2.1	Equivalent stress	S10 Rev.3	9.2.1		Editorial
				9.2.2	Rudder horn plating	CSR BC	Ch10 Sec1 [9.2.5]	Reference to rudder plating deleted	Technical
				9.2.3	Connection to hull structure	CSR BC	Ch10 Sec1 [9.2.6] Ch10 Sec1 [9.2.7] Ch10 Sec1 [9.2.8] Ch10 Sec1 [9.2.9]	The following requirements added: - internal brackets and stringers - scallops - welding Requirement to floor thickness deleted, otherwise copy	Technical
		<b>9.3</b>	<b>Rudder trunk</b>						
				9.3.1	Materials, welding and connection to hull	CSR BC CSR BC CSR BC	Ch10 Sec1 [3.4.3] Ch10 Sec1 [3.4.4] Ch10 Sec1 [3.4.7]	Rule items merged. Clarification that Class II plating material required	Editorial
				9.3.2	Scantlings	CSR BC CSR BC	Ch10 Sec1 [3.4.1] Ch10 Sec1 [3.4.2]	Rule items merged	Editorial
<b>Annex</b>	<b>Guidelines for calculation of bending moment and shear force distribution</b>								
		<b>1</b>	<b>General</b>			S10 Rev.3	Annex		Editorial
		<b>2</b>	<b>Spade rudder</b>			S10 Rev.3	Annex		Editorial
		<b>3</b>	<b>Spade rudder with trunk</b>			S10 Rev.3 CSR BC	Annex Ch10 Sec1 [3.3]		Editorial
		<b>4</b>	<b>Rudder supported by sole piece</b>			S10 Rev.3	Annex		Editorial
		<b>5</b>	<b>Semi spade rudder with one elastic support</b>			S10 Rev.3	Annex		Editorial

		<b>6</b>	<b>Semi spade rudder with 2-conjugate elastic support</b>	S10 Rev.3 CSR BC CSR BC	Annex Ch10 Sec1 [3.3] Ch10 Sec1 [9.3]		Editorial
--	--	----------	---	-------------------------------	---	--	-----------

## Detailed technical background

The following provides technical background to the rule modifications identified as "technical" in the summary of changes, and the items that are new or based on CSR BC rules.

### 1.4.1

Slot welds are to be avoided in highly stressed areas, since the area of the plate material will be reduced due to the slots. Slots shall not be filled with weld, since this will make it difficult to detect cracks or loss of contact with the inside web.

### 1.4.2

The rudder horn recess is prone to cracking. The requirements have been introduced to make a design standard with less stress concentrations and hence less fatigue problems.

### 1.4.3

Welding requirement has been introduced to provide a good connection between plates and castings or very thick plating.

### 1.5

1.5.1 to 1.5.4 specify principles for equivalence considerations.

### 2.1.1

The thrust factor  $K_{th}$  has been deleted, since the thrust coefficient is normally not known in the approval phase. Taking account of  $K_{th}$  larger than 1 should be the responsibility of the designer.

Coefficients for high lift rudders, fish tail, single plate and mixed profiles (e.g. HSVA) have been added in line with CSR BC rules.

Coefficients for High lift rudders and Fish tail are from the comparison between High lift rudder, the fish tail type schilling rudder and a conventional rudder (NACA0020) based on circulatory water tunnel tests and strain gauge readings on actual rudders. According to the test results, it has shown that the CL lift coefficients are:

High Lift Rudders(Rudder with flaps)	-	1.77
Schilling rudder	-	1.30
Conventional NACA0020	-	1.15

It indicates that "y" peak force on the high lift rudders and the schilling rudder is about 54 (1.77/1.15) and 13 (1.30/1.15) per cent higher than force on a conventional rudder of the NACA 0020 form. Considering the above with safety factor, coefficients  $K_2$  are given as below

High Lift Rudders(Rudder with flaps)	$K_2 = 1.1(NACA-00) \times 1.54 = 1.69 \Rightarrow 1.7$
Fish tail(Schilling rudder)	$K_2 = 1.1(NACA-00) \times 1.13 = 1.24 \Rightarrow 1.4$

Coefficients for Mixed side profiles are taken from C.1.1, Sec.14, Chapter 1, Part 1 of the GL Rules.

Coefficients for Single plate are standard basis.

### 5.1

It has been clarified that material factor  $k$  should be included in the stress criteria. However, in way of the recess for the rudder horn pintle on semi-spade rudders no credit for high tensile steel is given, since the given stress criteria are considered necessary to avoid fatigue cracks. The fatigue resistance properties of high tensile steel are similar to mild steel.

Reference is made to Appendix 1.

### 5.3.1

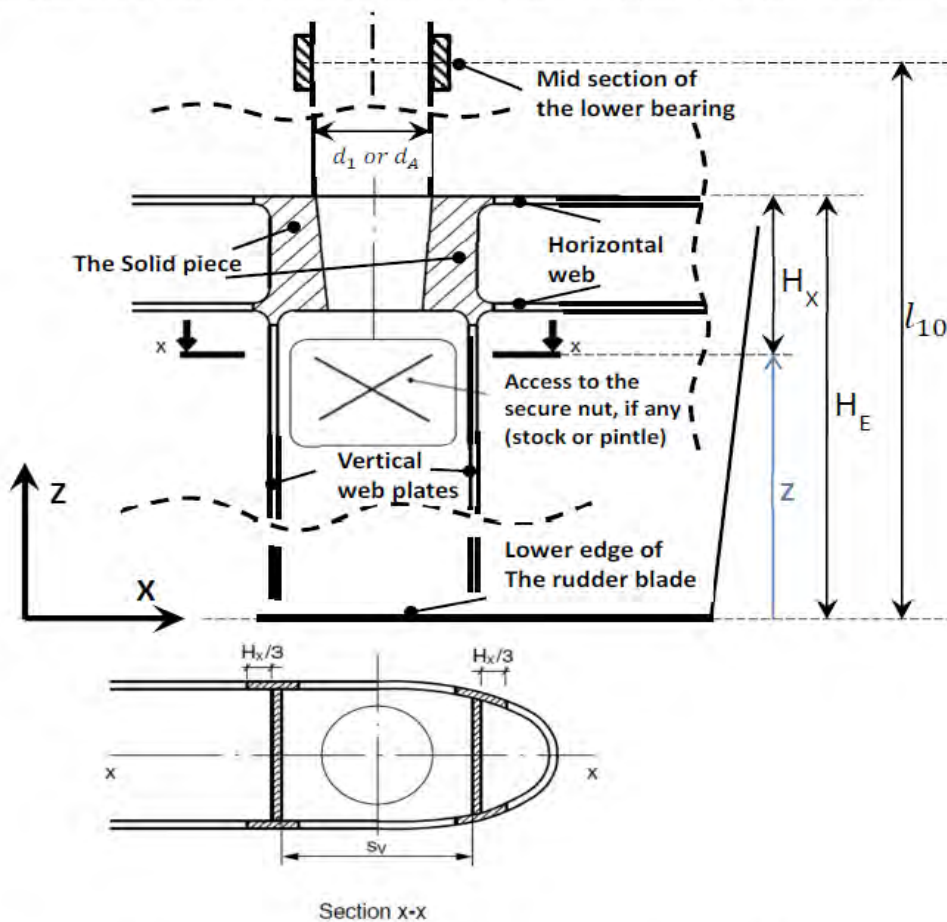
Based on CSR BC. No TB available.

### 5.3.2

Based on CSR BC. No TB available.

### 5.3.3

Solid parts, in forged or cast steel, used for the housing of either the rudder stock or of the rudder pintle are connected to the rudder blade by means of horizontal and vertical web plates, as shown in figure 1, here below. The solid part is located either below the lower rudder stock-bearing, or below the lower pintle-bearing.



**Figure 1 : Section modulus in the area below stock or pintle**

The section modulus of the cross-section of the structure of the rudder blade, formed by vertical web plates and rudder body plating, is to be enough stiff to withstand bending moment acting on this area.

The objective is to provide the technical background for the following formula:

$$W_s = c_s d_1^3 \left( \frac{H_E - H_X}{H_E} \right)^2 \frac{k}{k_1} 10^{-4} \quad (1)$$

**Bending moment acting below the solid part:**

Two rudder systems are considered in the scope of this technical note: spade rudders and semi-spade rudders. Bending moment diagrams from the lower edge of the blade till the lower bearing area of the rudder system can be written, as follows:

- For spade rudders

$$M_z = -p_{R10} \frac{z^2}{2} - \left( \frac{p_{R20} - p_{R10}}{l_{10}} \right) \frac{z^3}{6} \quad (2a)$$

- For semi-spade rudders:

$$M_z = -p_{R10} \frac{z^2}{2} \quad (2b)$$

where:

$z$  is the distance, in m, from the lower edge of the rudder blade till its cross-section submitted to the bending moment  $M_z$

$p_{R10}$  is the force per unit length, in N/m, obtained for  $z$  equal to zero (at rudder-blade bottom edge)

$p_{R20}$  is the force per unit length, in N/m, obtained for  $z$  equal to  $l_{10}$  (location of the lower bearing, mid-section)

Note that in case of spade-rudders,  $p_{R10} = p_{R20} = \text{constant}$ , and the cubic term of equation (2a), becomes zero.

For both formulae (2a) and (2b), the minimum bending moment,  $M_z = 0$  is obtained for  $z = 0$  and the maximum bending moment,  $M_z$  is obtained for  $z = l_{10}$ .

At the lower bearing position, for  $z = l_{10}$ , the section modulus of the structure is mainly given either by:

- Cross-section of the rudder stock, with diameter  $d_1$ , in mm, calculated for a solid circle, as follows:

$$W_s = \frac{I}{\left(\frac{d_1}{2}\right)} = \frac{\pi d_1^3}{32} \approx \frac{d_1^3}{10}, \text{ which is valid for a material with a coefficient} = k_1 \quad (2c)$$

or by

- Cross-section of the rudder pintle, with diameter  $d_A$ , in mm, calculated for a solid circle, as follows:

$$W_p = \frac{I}{\left(\frac{d_A}{2}\right)} = \frac{\pi d_A^3}{32} \approx \frac{d_A^3}{10}, \text{ which is valid for a material with a coefficient} = k_1 \quad (2d)$$

Equations (2c) and (2d) may be written in  $\text{cm}^3$ , as follows:

$$W_s = d_1^3 10^{-4} \text{ cm}^3 \quad (2e)$$

$$W_p = d_A^3 10^{-4} \text{ cm}^3 \quad (2f)$$

The axial bending stress,  $\sigma_z$ , generated by the bending moment,  $M_z$ , is given by:



$$\sigma_z = \frac{M_z}{W_{sect}} \quad (3a)$$

The normalized variable  $u_z = \left(\frac{H_E - H_X}{H_E}\right)$  is defined, from figure 1, here above. By using it inside of equations (2a) and (2b), it can be seen that the bending moment will be decreasing from the value  $M_{H_E}$  till zero, when  $H_X$  varies from zero to  $H_E$ .

#### Section modulus below the solid part:

At  $z = H_E$  or  $u_z = 1$ , it can be said that, for a section modulus  $W_{mec} = W_s$  or  $W_p$ , the level of stress  $\sigma_{H_E}$ , acting on this section is acceptable, either based on the scantling of the rudder stock or on the scantling of the rudder pintle.

Based on the equation (3a), and assuming that the axial bending stress should be kept at most equal to  $\sigma_{H_E}$  inside of this transition zone, through the solid part thickness and beneath the lower edge of this part, the following can be written:

$$\sigma_{H_E} = \frac{M_{H_E} u_z^2}{W_{mec} u_z^2} = constant \quad (3b)$$

where  $W_{mec} = d_v^3 10^{-4} \text{ cm}^3$ , with  $d_v$  either =  $d_1$ (rudder stock) or  $d_A$ (rudder pintle)

Equation (3b) will make sure that the level of stress acting on a cross section (see figure 1, section at X-X) of the rudder blade is less than or equal to  $\sigma_{H_E}$ . Based on equation (3b), the section modulus at any cross section X-X, below the solid part, should be of a value, at least equal to  $W_{sect}$ , defined as follows:

$$W_{sect} = W_{mec} u_z^2 = d_v^3 10^{-4} \left(\frac{H_E - H_X}{H_E}\right)^2 \quad (3c)$$

Equation (1) can be obtained from equation (3c) by adding:

1. a safety factor,  $c_s$ , to compensate the existence, or not of an opening in the considered cross section<sup>(\*)</sup>
2. the ratio  $\frac{k}{k_1}$ , to make the difference of material properties of the stock (or pintle) with the web plates

From equation (3c), and considering the two above remarks, it can be written:

$$W_{sect} = c_s d_v^3 \left(\frac{H_E - H_X}{H_E}\right)^2 \frac{k}{k_1} 10^{-4} \text{ cm}^3 \quad (3d)$$

<sup>(\*)</sup>Note that, the  $c_s$  coefficient is also considered to make possible the use of the same formula for the calculation of the actual section modulus for any cross section X-X, just in the region below the lower edge of the solid part (for both cases with or without an opening in the rudder plating). The breadth of the rudder plating to be considered for the calculation of this actual section modulus is to be not greater than that obtained, in m, from the following formula:

$$b = s_v + 2 \frac{H_X}{m} \quad (4)$$

where:

$s_v$  = spacing, in m, between the two vertical webs (see figure 1)

$H_X$  = distance defined according to figure 1

$m$  = coefficient to be taken, in general, equal to 3.

#### 5.3.4

Based on CSR BC. (No TB available.)

### 5.3.5

Based on CSR BC. (No TB available.)

### 6.1.5

The bolts are to be of fitted type in order to efficiently transfer shear forces.

### 6.2.4

The bolts are to be of fitted type in order to efficiently transfer shear forces.

### 6.3.2

Based on CSR BC. (No TB available.)

### 6.3

Reference is made to Appendix 2.

### 6.3.5

There are designs where the key transmits all of the rudder torque, and in this case push-up pressure and length should be considered properly. However, it is considered outside the scope of this UR S10 update to develop detailed requirements.

### 6.3.4

Based on CSR BC. (No TB available.)

### 6.4

Reference is made to Appendix 2.

### 6.4.1

Based on CSR BC. (No TB available.)

### 6.4.2

Based on CSR BC. (No TB available.)

### 6.4.3

Based on CSR BC, with no TB available. In addition a push up length minimum requirement has been added

### 8.1.1

Based on CSR BC. (No TB available.)

Sentence regarding small ships deleted, since normally bushes are required, there is no definition for "small ships", and "suitably increased" is very vague.

### 8.1.2

Based on CSR BC. (No TB available.)

### 8.2

Maximum surface pressure for synthetic material has been limited to 10 N/mm<sup>2</sup>.

### 9.2.2

Based on CSR BC. (No TB available.) Reference to rudder side plating removed, since the requirement based on length will normally be governing.

### 9.2.3

Based on CSR BC. (No TB available.) The following sentence is deleted, since the requirement is difficult to justify: "The thickness of these plate floors is to be increased by 50% above the bottom thickness determined according to Ch 6, Sec 1 or Ch 9, Sec 2."

Requirement to scallops added, in order to avoid crack initiation points in areas with high shear stress.

In order to achieve better connection with the hull structure brackets or stringers are to be fitted internally in horn in line with outside shell plate

Requirement to full penetration welding added to avoid cracking.

### 9.3.1

Based on CSR BC. (No TB available.)

### 9.3.2

Based on CSR BC. (No TB available.)

### Annex 10.3

Reference is made to Appendix 3.

### Annex 10.6

Reference is made to Appendix 4.

# Appendix 1 Scantling of rudder blades with cut-outs (bending stress criterion)

## GENERAL

The scantling of rudder blades takes into consideration bending and shear stresses, for both cases of rudder blades with and without cut-outs. It is noted that the presence of cut-outs will introduce geometrical discontinuities on the surface of the rudder blade, and will also decrease the real section area withstanding bending stress generated by the bending moment. An illustration of this is depicted in figures 1a, 1b, 1c and 1d, here below, which ones represent simplified views of plates and rudder blades, with and without cut-outs, subjected to a total force  $F$  uniformly distributed along the upper and bottom edges of the piece.

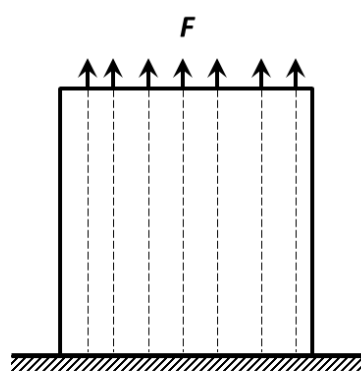


Figure 1a: Force flow-lines through a plate without cut-outs

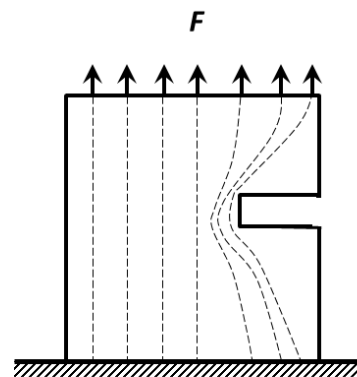


Figure 1b: Force flow-lines through a plate with cut-outs

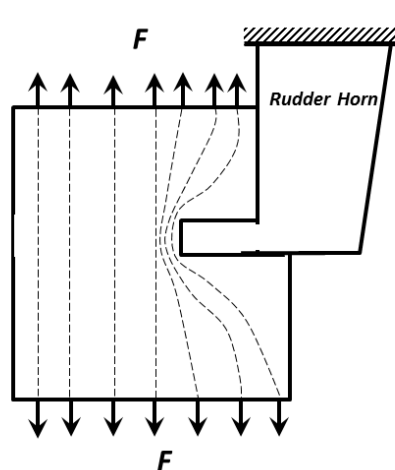


Figure 1c: Force flow-lines through a rudder blade with cut-outs

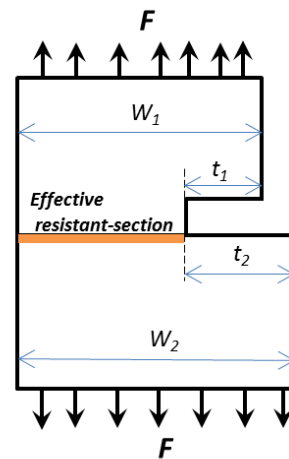


Figure 1d: Main dimensions of the rudder blade and its effective resistant-section to the applied bending stress

In addition to the section area reduction, these geometrical discontinuities also work as stress raisers, producing local stresses much higher than the nominal net section stress that would be calculated without considering stress concentration effects. The question addressed inside of this technical note is just referring to the value of “stress amplification” factor,  $sA_f$ , to be adopted in view of estimating the level of bending stress acting on a rudder blade with cut-outs. This note brings technical argumentation to be used on the choice of this “stress amplification” coefficient.

It is reminded that the bending stress scantling criterion of the rudder blade with cut-outs, according to URS10, can be considered as being a percentage of the maximum allowable bending stress for the rudder blade without cut-outs. That is why the “stress amplification-factor” may be considered, to make possible the definition of the maximum allowable bending stress of a rudder blade with cut-outs,  $\sigma_{allow\_cut}$ , as a function of the maximum allowable bending stress of a rudder blade without cut-outs,  $\sigma_{allow\_uncut}$ , as follows:

$$\sigma_{allow\_cut} = \frac{\sigma_{allow\_uncut}}{sA_f} \quad (1a)$$

## OBJECTIVE

To provide the technical background for the scantling criterion applicable for the bending stresses on the rudder blades with cut-outs. In other words, to justify the choice of the allowable bending stress for a rudder blade with cut-outs, based on:

- either:

$$sA_f = 1.22 \text{ or } \sigma_{allow\_cut} = \frac{\sigma_{allow\_uncut}}{sA_f} = \frac{110}{1.22} = 90. \text{ N/mm}^2 \quad (2a)$$

- or:

$$sA_f = 1.47 \text{ or } \sigma_{allow\_cut} = \frac{\sigma_{allow\_uncut}}{sA_f} = \frac{110}{1.47} = 75. \text{ N/mm}^2 \quad (2b)$$

## STRESS FACTOR WITHOUT THE NOTCH EFFECT

The stress amplification factor,  $sA_f$ , can be calculated based on the effective resistant-section, as illustrated in the figure 1d here above, by using formulae as follows:

- Lower limit of  $sA_f$ :

$$sA_{fL} = \left( \frac{W_1}{W_1 - t_1} \right) \quad (3a)$$

- Upper limit of  $sA_f$ :

$$sA_{fU} = \left( \frac{W_2}{W_2 - t_2} \right) \quad (3b)$$

- Average value of  $sA_f$ :

$$sA_{fA} = \left( \frac{0.5 * [W_2 + W_1]}{W_1 - t_1} \right) = \left( \frac{0.5 * [W_2 + W_1]}{W_2 - t_2} \right) \quad (3c)$$

This is a coarse and simplified approach which only takes into consideration the reduction of the effective resistant-section, due to the presence of the cut-out on the surface of the rudder blade.

Although this simplified method does:

- neither take into consideration the existence of several vertical and horizontal web plates, which reinforce different regions of the rudder blade, changing locally the section modulus of the blade
- nor considers any notch effect, very dependent on the smoothness of edges in the cut-out areas,

this approach can give a coarse estimation of the nominal stress acting on the resistant-section of the rudder-blade.

## CASE SAMPLE

We have considered a case sample based on a very big rudder blade from our records, having a mean height of 13 m, and with the following geometrical parameters, as per figure 1d:

$$W_1 = 5.38 \text{ m}; \quad W_2 = 6.90 \text{ m}; \quad t_1 = 1.27 \text{ m}; \quad t_2 = 2.79 \text{ m};$$

Based on formulae (3a), (3b) and (3c), the following values are obtained:

$$sA_{fL} = 1.31; \quad sA_{fU} = 1.68; \quad \text{and} \quad sA_{fA} = 1.49$$

The acceptance criteria can be obtained, as follows:

$$\sigma_{allowcut\_Max} = \frac{\sigma_{allowuncut}}{sA_{fL}} = \frac{110}{1.31} = 84. \text{ N/mm}^2 \quad (3d)$$

$$\sigma_{allowcut\_Average} = \frac{\sigma_{allowuncut}}{sA_{fA}} = \frac{110}{1.49} = 74. \approx 75. \text{ N/mm}^2 \quad (3e)$$

$$\sigma_{allowcut\_Min} = \frac{\sigma_{allowuncut}}{sA_{fU}} = \frac{110}{1.68} = 65.5 \text{ N/mm}^2 \quad (3f)$$

## CONCLUSION

Considering the results given for the case sample here above, the value of  $\sigma_{allowcut} = 75. \text{ N/mm}^2$ , as the scantling criterion applicable for the bending stresses on the rudder blades with cut-outs, is more appropriated than the one of  $90.0 \text{ N/mm}^2$ .

As a general criterion, the value of  $75.0 \text{ N/mm}^2$  is to be considered inside of the URS10. Of course, the designer of the rudder system may always submit for approval, a FE calculation based on the real structure of the rudder blade, considering all horizontal and vertical web plates, and modeling in detail the cut-areas of the part. This FE analysis can provide a more relevant value for the stress amplification factor,  $sA_f$ , to consider on the evaluation of the allowable bending stress.

# Appendix 2 Cone coupling assembly of steel rudder stock with the massive part

## 1. Introduction

### 1.1. General

The assembly process based on the tight tolerance fit of two mechanical parts, with axi-symmetrical geometries, assumes that relevant stress tensor is acting in a plane defined by the radial and circumferential directions. The strain component,  $\varepsilon_z$ , may be not negligible, and can be calculated from radial and circumferential stress-components, and engineering material constants.

### 1.2. Stress – strain relations, in a state of plane stress

In case of isotropic materials in plane stress, defined by the Young's Modulus, E, and the Poisson's ratio,  $\nu$ , the following equation can be written:

$$\begin{Bmatrix} \varepsilon_r \\ \varepsilon_\theta \\ \varepsilon_z \\ \gamma_{r\theta} \\ 0 \\ 0 \end{Bmatrix} = \begin{bmatrix} \frac{1}{E} & \frac{-\nu}{E} & \frac{-\nu}{E} & 0 & 0 & 0 \\ \frac{-\nu}{E} & \frac{1}{E} & \frac{-\nu}{E} & 0 & 0 & 0 \\ \frac{-\nu}{E} & \frac{-\nu}{E} & \frac{1}{E} & 0 & 0 & 0 \\ 0 & 0 & 0 & \frac{1}{G} & 0 & 0 \\ 0 & 0 & 0 & 0 & \frac{1}{G} & 0 \\ 0 & 0 & 0 & 0 & 0 & \frac{1}{G} \end{bmatrix} \begin{Bmatrix} \sigma_r \\ \sigma_\theta \\ 0 \\ \tau_{r\theta} \\ 0 \\ 0 \end{Bmatrix} \quad (1)$$

For each orthogonal direction, strain values can be calculated, as follows:

$$\varepsilon_r = \frac{1}{E}(\sigma_r - \nu\sigma_\theta) \quad (1a)$$

$$\varepsilon_\theta = \frac{1}{E}(\sigma_\theta - \nu\sigma_r) \quad (1b)$$

$$\varepsilon_z = -\frac{\nu}{E}(\sigma_r + \sigma_\theta) = -\frac{\nu}{1-\nu}(\varepsilon_r + \varepsilon_\theta) \quad (1c)$$

$$\gamma = \left(\frac{1+\nu}{E}\right)\tau_{r\theta} \quad (1d)$$

For the case of shrinking fit between two axi-symmetric parts (axi-symmetry related with geometry and loads), the following is also true:

$$\gamma_{r\theta} = \tau_{r\theta} = 0 \quad (1e)$$

## 2. Objective of the study

The objective of this note is to describe the cone coupling assembly process for both key and keyless processes, by, amongst others, evaluating the contact pressure between the outer surface of the rudder stock and the inner surface of the massive part, at the end of the cone coupling assembly process. Relevant calculations are based on elastic formulae of thick-walled cylinders submitted to both internal and external pressures,  $p_i$  and  $p_e$ , respectively. Friction forces may be calculated at the contact surface between the rudder stock and the outer cone (massive part) by using a Coulomb friction model. Knowing the friction coefficient existing between contact surfaces, the contact pressure is adjusted in view of producing friction forces enough high to withstand bending and torsion moments in way of the cone coupling joint.

## 3. Formulae for thick-walled cylinders

### 3.1. Thick cylinders under internal and external loadings

Figure 1 shows a thick cylinder submitted to internal and external pressures.

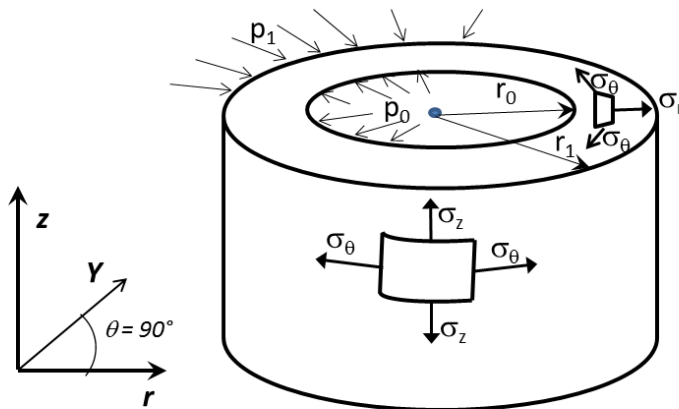


Figure 1 : Thick cylinder under internal and external pressure

The cylinder of figure 1 is submitted to:

- uniform internal radial pressure,  $p_0$
- uniform external radial pressure,  $p_1$

The longitudinal (OZ axis) component of stress,  $\sigma_z$ , is made equal to zero (end free condition).

Main stress axes, according to figure 1, are defined, as follows:

- radial direction,  $r$
- circumferential direction,  $Y$  (or  $\theta$  axis)
- longitudinal direction,  $Z$

For  $\sigma_z = 0$ , the radial and circumferential components of stress, at a radial position,  $r$ , are given by the following formulae:



$$\sigma_r = p_0 \frac{r_0^2}{(r_1^2 - r_0^2)} \left[ \frac{r^2 - r_1^2}{r^2} \right] - p_1 \frac{r_1^2}{(r_1^2 - r_0^2)} \left[ \frac{r^2 - r_0^2}{r^2} \right] \quad (3a)$$

$$\sigma_\theta = p_0 \frac{r_0^2}{(r_1^2 - r_0^2)} \left[ \frac{r^2 + r_1^2}{r^2} \right] - p_1 \frac{r_1^2}{(r_1^2 - r_0^2)} \left[ \frac{r^2 + r_0^2}{r^2} \right] \quad (3b)$$

Where:

- $r_0$  = inner radius of the cylinder
- $r_1$  = outer radius of the cylinder
- $r$  = radial position, where stress components,  $\sigma_r$  and  $\sigma_\theta$ , are calculated

For the case of cylinders submitted only to an internal pressure, equations (3a) and (3b) would become:

$$\sigma_r = p_0 \frac{r_0^2}{(r_1^2 - r_0^2)} \left[ 1 - \left( \frac{r_1}{r} \right)^2 \right] \quad (< 0, \text{compression}) \quad (3c)$$

$$\sigma_\theta = p_0 \frac{r_0^2}{(r_1^2 - r_0^2)} \left[ 1 + \left( \frac{r_1}{r} \right)^2 \right] \quad (> 0, \text{tension}) \quad (3d)$$

For the case of cylinders submitted only to an external pressure, equations (3a) and (3b) would become:

$$\sigma_r = -p_1 \frac{r_1^2}{(r_1^2 - r_0^2)} \left[ 1 - \left( \frac{r_0}{r} \right)^2 \right] \quad (< 0, \text{compression}) \quad (3e)$$

$$\sigma_\theta = -p_1 \frac{r_1^2}{(r_1^2 - r_0^2)} \left[ 1 + \left( \frac{r_0}{r} \right)^2 \right] \quad (< 0, \text{compression}) \quad (3f)$$

For the case of full section cylinders ( $r_0 = 0$ ), both stresses become identical ( $\sigma_r = \sigma_\theta = -p_1$ ).

#### 4. Shrinking fit of a hole shaft with a hub

##### 4.1. General

Figure 2, here below, shows two cylindrical steel parts, to be assembled together, by a shrinking fit process.

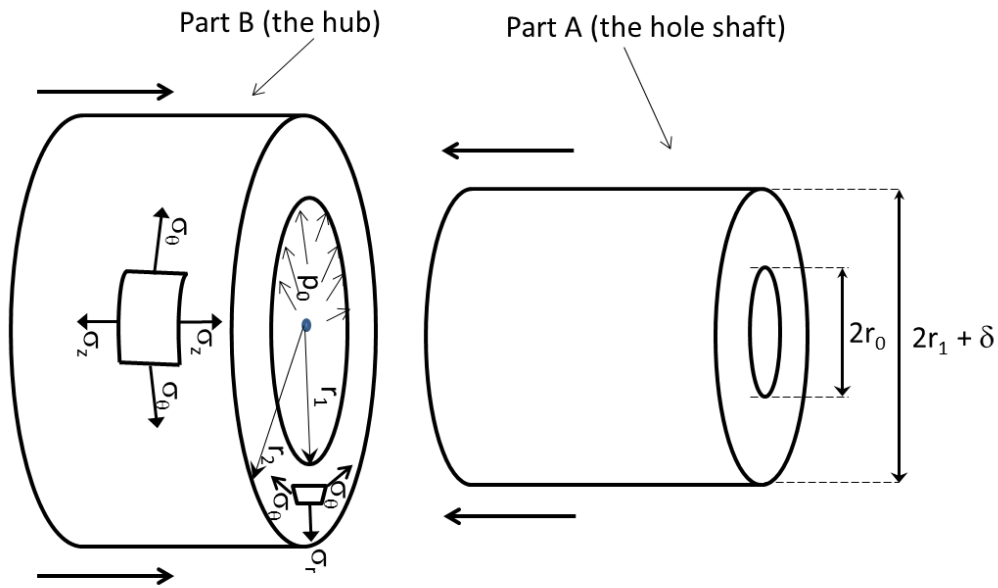


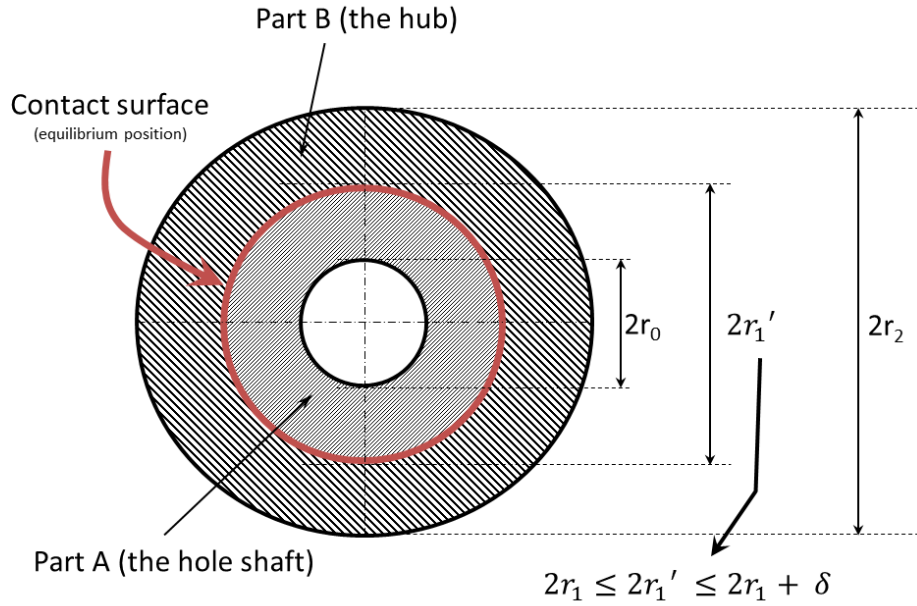
Figure 2 : Two thick cylindrical parts to be assembled by shrinking fit

At the equilibrium position, the outer surface of part A and the inner surface of part B will be in contact. The contact pressure at this equilibrium position,  $p_{eq}$ , is a function of the initial radial interference,  $\delta$ .

The problem will consist on the calculation of a relevant value of  $\delta$  necessary to generate a pressure,  $p_{eq}$ , required to withstand torque or both torque and bending moments to be transferred from B to A, or vice-versa.

#### 4.2. The radial interference as a function of the contact pressure

Figure 3 shows a cut view of parts A and B of figure 2, at the final equilibrium position, after the assembly process.



**Figure 3 : Equilibrium position after assembly (shrinking fit)**

It is assumed that, at the end of the shrinking fit process, radii  $r_0$  and  $r_2$  remain constant. At the equilibrium position, the radius of the contact surface between parts A and B can be calculated, as follows:

- For part A:

$$2r_1'\pi = (2r_1 + \delta)\pi + \varepsilon_{\theta(r=r_2)}^A (2r_1 + \delta)\pi \quad (4a)$$

Where the second term on the right side of equation (4a) represents the circumferential deformation of the “part A”, over the length  $(2r_1 + \delta)\pi$ , and caused by the external pressure,  $p_{eq}$ .

- For part B:

$$2r_1'\pi = 2r_1\pi + \varepsilon_{\theta(r=r_2)}^B 2r_1\pi \quad (4b)$$

Where the second term at the right side of equation (4b) represents the circumferential deformation of the “part B”, over the length  $2r_1\pi$ , and caused by the internal pressure,  $p_{eq}$ .

From equations (4a) and (4b), and assuming that the term  $\varepsilon_{\theta}^A \cdot \delta$  can be neglected, it follows:

$$\frac{\delta}{2r_1} = \varepsilon_{\theta}^B - \varepsilon_{\theta}^A \quad (4c)$$

Assuming that parts A and B are made of materials A and B, respectively, and by using equation (1b) for these materials, it can be written:

$$\varepsilon_{\theta}^A = \frac{1}{E^A} (\sigma_{\theta}^A - \nu^A \sigma_r^A) \quad (4c_1)$$

$$\varepsilon_{\theta}^B = \frac{1}{E^B} (\sigma_{\theta}^B - \nu^B \sigma_r^B) \quad (4c_2)$$

Where:

- $E^j$  and  $\nu^j$ , for  $j = A$  or  $B$ , are engineering constants,  $E$  and  $\nu$ , for the materials A and B, respectively.
- $\sigma_i^j$ , for  $i = r$  or  $\theta$ , and  $j = A$  or  $B$ , are radial or circumferential stresses acting on either part A or on part B.

The values of  $\sigma_i^j$  can be calculated for materials A and B at  $r = r_1$ , by using equations (3a) and (3b), as follows:

- For part A, by making  $p_0 = 0$  and  $p_1 = p_{eq}$
- For part B, by making  $p_0 = p_{eq}$  and  $p_1 = 0$

By replacing the calculated values of  $\sigma_i^j$ , on equations (4c<sub>1</sub>) and (4c<sub>2</sub>),  $\varepsilon_\theta^A$  and  $\varepsilon_\theta^B$  can be expressed, as follows:

$$\varepsilon_\theta^A = \frac{-p_{eq}}{E^A} \left[ \frac{(r_1^2 + r_0^2)}{(r_1^2 - r_0^2)} - \nu^A \right] \quad (4c_3)$$

$$\varepsilon_\theta^B = \frac{p_{eq}}{E^B} \left[ \frac{(r_1^2 + r_2^2)}{(r_2^2 - r_1^2)} + \nu^B \right] \quad (4c_4)$$

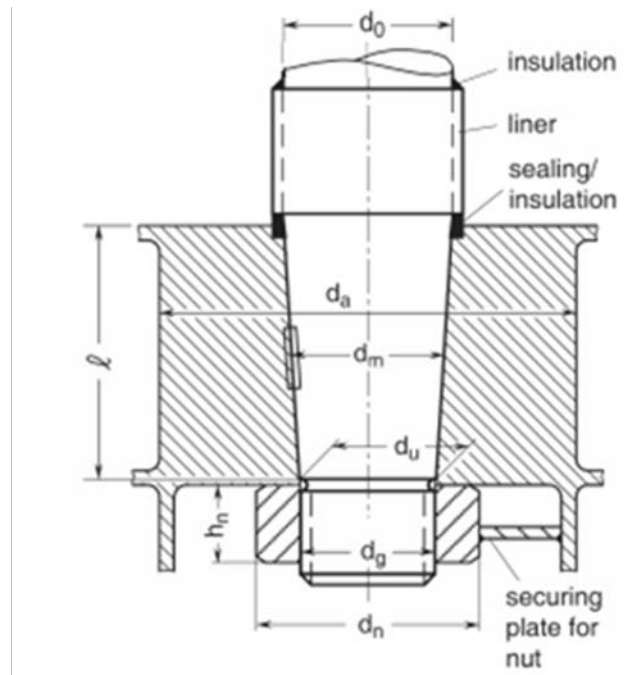
By replacing the values of  $\varepsilon_\theta^A$  and  $\varepsilon_\theta^B$  from equations (4c<sub>3</sub>) and (4c<sub>4</sub>) on to equation (4c), the following can be written:

$$\frac{\delta}{2r_1} = p_{eq} \left\{ \frac{1}{E^B} \left[ \frac{(r_1^2 + r_2^2)}{(r_2^2 - r_1^2)} + \nu^B \right] + \frac{1}{E^A} \left[ \frac{(r_1^2 + r_0^2)}{(r_1^2 - r_0^2)} - \nu^A \right] \right\} \quad (4d)$$

Equation (4d) relates the radial interference  $\delta$  with the contact pressure,  $p_{eq}$ , at the end of the shrinking fit process. In other words, the contact pressure obtained at the end of the shrinking fit process can be adjusted based on equation (4d), by changing the value of  $\delta$ . In case of tapered contact surfaces, an axial movement of part A against part B, by simply pushing part A on to part B, will induce variations of the radial interference, and consequently will change the contact pressure,  $p_{eq}$ . This is at the origin of the variable named "push-up" length, which associates the radial interference  $\delta$ , to the axial relative displacement of parts A and B.

### 4.3. Relating radial shrinkage to push-up length

In the elastic domain, radial shrinkage of the rudder shaft may be associated to the push up length based on geometrical data, such as: the taper of conical coupling",  $c$ , measured on diameter, and the "slope" in this area, given by  $c/2$ ).



**Figure 4: Geometry of cone coupling**

These geometric data, according to figure 4, are defined, here below, as follows:

- *taper of conical coupling* =  $c = \frac{(d_0 - d_u)}{l}$  (4e)

- *slope in the conical coupling area* =  $\tan(\text{angle}) = \frac{\left(\frac{(d_0 - d_u)}{2}\right)}{l} = \frac{c}{2}$  (4f)

The "push up" length may be expressed as a function of the "shrinkage diameter" (radial interference,  $\delta$ , of equation (4d), above), as follows:

$$\text{push-up length} = \Delta = \frac{\text{diametral shrinkage } (\delta)}{\text{taper of conical coupling } (c)} \quad (4g)$$

## 5. Principles for Cone coupling design

### 5.1. Design basis

The cone coupling joint is designed to transmit loads from the rudder blade through the rudder stock, and vice-versa, by using friction forces to be generated between contact surfaces. The push-up pressure (related to a push-up length) has to be enough high to generate necessary friction forces able to withstand torsion and bending efforts passing through this joint, for both cases of keyed or keyless assemblies. These efforts are to be evaluated in the way of the cone coupling joint for the rudder mechanical system, on a case by case basis.

The term "push-up pressure"(or push-up length) is referring to the "equilibrium pressure" (or equilibrium "relative position of assembled parts") obtained at the end of cone coupling assembly process. The "push-up" pressure is the required pressure existing between contact surfaces to keep the rudder blade fully tied to the rudder stock, allowing the "cone

coupling joint" to withstand designed bending and torsion moments. The "equilibrium pressure" is valid only for a given friction coefficient (assumed as 0.15 for steel-steel surfaces and 0.13 for steel-SG iron surfaces).

A safety coefficient is included on the design of a cone coupling joint, by either considering a key as a safety device, or by designing a higher value of "push-up pressure". For both cases, friction forces have to be generated at contact surfaces to a level sufficiently high to ensure the safety transmission of bending and torsion efforts from the rudder blade to the rudder stock, and vice-versa.

Special care is to be drawn for the calculation of threshold limit stress acting on the outer cone of the cone coupling joint, to avoid this part to burst, and being definitely damaged.

## **5.2. Scantling the cone coupling joint**

The design of the cone coupling assembly is based on the calculation of:

1. minimum values of push-up pressure and push-up length based on either design yield moment of the rudder stock or the bending moment in the cone coupling (the one producing maximum 'push-up' pressure, and push-up length, as well, is taken)
2. the torsion moment, expressed by  $Q_F$ , also known as the design yield moment of the stock, which is calculated based on the rudder torque value,  $Q_R$
3. key dimensions required for the cone coupling joints with a key, by assuming that 50% of  $Q_F$  is supported by friction force and remaining 50% by the key. In this case the safety margin is provided by the key. Under normal conditions, the key is not designed to ensure the transmission of the torsion: it is supposed to work only when friction forces are not enough high to withstand the rudder torque,  $Q_R$
4. friction forces required for the cone coupling joints without key, by assuming that 100% of  $Q_F$  is supported by friction forces acting between contact surfaces of the rudder body and rudder stock. In this case the safety margin is ensured by the increase of the friction forces, which are taken twice those calculated for cone coupling joints with key)
5. maximum acceptable values of push-up pressure and push-up length to avoid any damage caused to the massive part (the outer cone)

Cone coupling push-up pressure and push-up length are calculated based on a plane state of stress acting between the rudder stock and the massive part of the rudder blade, as previously described inside of chapters 1, 3 and 4 of this document.

## **5.3. Bases for calculating the design yield moment**

For the cross section of a round shaft the maximum shear stress acting on the cylindrical surface of the shaft may be calculated, as follows:

$$\tau = \frac{16 Q_F}{\pi d_{shaft}^3} \quad (5.1a)$$

Where:

$Q_F$

: is the twisting or torsion moment, in  $N \cdot mm$  (also known as the design yield moment)

$d_{shaft}$  : is the diameter of the shaft, in mm

The maximum shear stress may also be written as a function of the material yield stress based on the von Mises criterion (also known as the distortion-energy theory of yielding), as follows:

$$\tau = \frac{R_{eH}}{\sqrt{3}} \quad (5.1b)$$

Based on equations (5.1a) and (5.1b), the design yield moment,  $Q_F$ , can be expressed by:

$$Q_F = \frac{\pi d_{shaft}^3}{16 \sqrt{3}} R_{eH} \approx 0.2 d_{shaft}^3 \frac{R_{eH}}{\sqrt{3}} \quad (5.1c)$$

By introducing the material factor,  $k_s$ , and assuming the reference value

$R_{eH} = 235 \frac{N}{mm^2}$ , equation (5.1c) becomes:

$$Q_F = 26.64 d_{shaft}^3 \cdot k_s \text{ in } N \cdot mm \quad (5.1d) \text{ or}$$

$$Q_F = 0.02664 d_{shaft}^3 \cdot k_s \text{ in } N \cdot m \quad (5.1e)$$

For safety reasons, the design yield moment  $Q_F$ , is taken twice the value of  $Q_R$ , the torsion moment taken for the design of the rudder stock, in such way to have the following relation:  $Q_F = 2 \cdot Q_R$

By using the above relation between  $Q_F$  and  $Q_R$  and equation (5.1d), the rudder stock diameter, in mm, may be calculated from equations (5.2a) and (5.2b), as follows:

$$2 Q_R = 26.64 d_{shaft}^3 \cdot k_s \quad (5.1f) \text{ , or}$$

$$Q_R = 13.32 d_{shaft}^3 \cdot k_s \text{ in } N \cdot mm \quad (5.1g)$$

$$Q_R = 0.01332 d_{shaft}^3 \cdot k_s \text{ in } N \cdot m \quad (5.1g_{bis})$$

$$d_{shaft} = \sqrt[3]{\frac{Q_R}{13.32 k_s}} = 0.42 \sqrt[3]{\frac{Q_R}{k_s}}, \quad \text{with } Q_R \text{ expressed in } N \cdot mm \quad (5.2a)$$

By expressing the torsion moment  $Q_R$ , in  $N \cdot m$ , equation (5.2a) becomes:

$$d_{shaft} = 4.2 \sqrt[3]{\frac{Q_R}{k_s}}, \quad \text{with } Q_R \text{ expressed in } N \cdot m \quad (5.2b)$$

#### 5.4. Design yield moment and its maximum value

The design yield moment of the rudder stock  $Q_F$ , in  $N \cdot m$ , is to be calculated by using equation (5.1e), as follows:

$$Q_F = 0.02664 d_{tActual}^3 \cdot k_s \text{ in } N \cdot m \quad (5.2c)$$

Where:

$d_{tActual}$  : is the actual value of the rudder stock diameter, in mm, which must be  $\geq d_{shaft}$ .

$d_{shaft}$  : is the rudder stock diameter, in mm, calculated based on the rudder stock torsion moment  $Q_R$ , according to equation (5.2b).

For the calculation of  $Q_F$  according to equation (5.2c), the actual value of the rudder stock diameter  $d_{tActual}$ , shall not be taken greater than  $1.145 d_{shaft}$ . According to equation (5.3d) here below, this upper limit value is obtained by adopting the following procedure:



1. Definition of  $Q_{Fmax}$ , by using equation (5.1g\_bis):

$$Q_{Fmax} = 3 \cdot Q_R = 3 \cdot 0.01332 d_{tActual}^3 \cdot k_s = 0.03996 d_{tActual}^3 \cdot k_s \quad (5.3a)$$

2. Calculating the “highest” value  $d_{tMax}$ , to be used in “the modified” equation (5.2c) in such way to obtain:

$$Q_{Fmax} = 3 \cdot Q_R = 0.02664 d_{tMax}^3 \cdot k_s \quad (5.3b)$$

3. Dividing equation (5.3a) by equation (5.3b):

$$\frac{Eq. (5.3a)}{Eq. (5.3b)} = \frac{Q_{Fmax}}{Q_{Fmax}} = \frac{0.03996 d_{tActual}^3 \cdot k_s}{0.02664 d_{tMax}^3 \cdot k_s} \quad (5.3c)$$

4. To obtain:

$$\frac{d_{tMax}}{d_{tActual}} = \sqrt[3]{\frac{0.03996}{0.02664}} = \sqrt[3]{1.5} = 1.145 \quad (5.3d)$$

## 6. Cone coupling with key

### 6.1. Push-up pressure and friction forces to withstand $0.5 Q_F$

The required friction force acting between contact surfaces may be calculated based on the “equilibrium” pressure  $p_{req1}$  required to generate a friction force  $F_{fric\_Key}$  able to withstand 50% of the design yield moment,  $Q_F$ , in  $N \cdot m$ . Based on this statement following equations may be written:

$$F_{fric\_Key} \cdot \frac{d_m}{2} = \frac{Q_F}{2} \quad (6.1a)$$

$$F_{fric\_Key} = F_N \cdot \mu_0 = p_{req1} \cdot Area_{Contact} \cdot \mu_0 \quad (6.1b)$$

$$Area_{Contact} = 2\pi \cdot \frac{d_m}{2} \cdot l \quad (6.1c)$$

To obtain:

$$p_{req1} = \frac{F_{fric\_Key}}{Area_{Contact} \cdot \mu_0} = \frac{Q_F}{d_m^2 \cdot \pi \cdot l \cdot \mu_0} \cdot 10^3 \quad (6.1d)$$

$$F_{fric\_Key} = \frac{Q_F}{d_m} \quad (6.1e)$$

Where:

$d_m$  : Mean cone diameter, in mm, as shown in figure 4

$F_N$  : Normal force to the contact surface between the rudder stock and outer cone, in N

$F_{fric\_Key}$  : Required friction force, in N, for a cone coupling connection with key

$Area_{Contact}$  : Area of contact surface between the rudder stock and outer cone,  $mm^2$

$\mu_0$  : Friction coefficient, equal to about 0.15

$l$  : Height, in mm, of the massive part (the outer cone, according to figure 4)

### 6.2. Push-up length to withstand $0.5 Q_F$



The minimum push-up length necessary to withstand  $0.5 * Q_F$ , may be calculated by using equations (4g), (4d) and (4e), as follows:

1. Calculation of taper of conical coupling,  $c$ , with equation (4e) and geometrical data, in accordance to figure 4.

$$\text{taper of conical coupling} = c = \frac{(d_0 - d_u)}{l} \quad (4e) \text{ or } (6.2a)$$

2. Calculation of diametrical shrinkage,  $\delta$ , based on equation (4d) by using: geometrical data from figures 2, 3 and 4; material properties with  $\nu^B = \nu^A = \nu = 0.3$ ,  $E^A = E^B = E$ , and  $p_{eq} = p_{req1}$ , calculated according to equation (6.1d), here above.

$$\frac{\delta}{2r_1} = p_{eq} \left\{ \frac{1}{E^B} \left[ \frac{(r_1^2 + r_2^2)}{(r_2^2 - r_1^2)} + \nu^B \right] + \frac{1}{E^A} \left[ \frac{(r_1^2 + r_0^2)}{(r_1^2 - r_0^2)} - \nu^A \right] \right\} \quad (4d) \text{ or } (6.2b)$$

3. Calculation of push-up length by replacing values of  $\delta$  and  $c$ , calculated in 2 and 1, respectively, on the equation (4g)

$$\text{push-up length} = \Delta_{req1} = \frac{\text{diametral shrinkage } (\delta)}{\text{taper of conical coupling } (c)} \quad (4g) \text{ or } (6.2c)$$

### 6.3. Push-up pressure & push length to withstand bending moment

The minimum push-up pressure,  $p_{req2}$ , in  $N/mm^2$  necessary to withstand the bending moment,  $M_B$ , in  $N.m$ , is taken equal to the axial bending stress in way of the cone coupling joint, calculated, as follows:

$$p_{req2} = \sigma_{axial} = \frac{M_B}{W_{sect}} \quad (6.3a)$$

Where  $W_{sect}$  = the section modulus of the massive part in way of the cone coupling joint, calculated based on geometrical data shown in figure 4:

$$W_{sect} = \frac{l^2 * d_m}{6} \quad (6.3b)$$

To obtain:

$$p_{req2} = \frac{6 * M_B}{l^2 * d_m} 10^3, \quad \text{in } N/mm^2 \quad (6.3c)$$

The calculation of push-up length,  $\Delta_{req2}$ , associated to the push-up pressure may be performed by following the same procedure presented under [6.2], *push-up length necessary to withstand  $0.5 * Q_F$* , by only changing the value of  $p_{eq}$ , by  $p_{req2}$ .

### 6.4. Minimum push-up pressure and push-up length

The minimum value of push-up pressure is selected by taking the maximum of  $p_{req1}$  and  $p_{req2}$ :

$$p_{req} = \text{Max}(p_{req1}, p_{req2}) \quad (6.4a)$$

The minimum value of push-up length is selected by taking the maximum of  $\Delta_{req1}$  and  $\Delta_{req2}$ :

$$\Delta_{req} = \text{Max}(\Delta_{req1}, \Delta_{req2}) \quad (6.4b)$$

### 6.5. Maximum push-up pressure and push-up length

The maximum allowable push-up pressure acting on the inner surface of the outer cone (the massive part) in the way of the cone coupling is based on von Mises equivalent stress, calculated for a biaxial state of stress  $\sigma_r$  and  $\sigma_\theta$ , as follows:

$$\sigma_{eq} = \sqrt{(\sigma_r - \sigma_\theta)^2 + \sigma_r^2 + \sigma_\theta^2} = \sqrt{2 * \sigma_r^2 + 2 * \sigma_\theta^2 - 2 * \sigma_r * \sigma_\theta} \leq 0.8 * R_{eH} \quad (6.5a)$$

Where  $\sigma_r$  and  $\sigma_\theta$  are the radial and circumferential normal stresses acting on the inner surface of a thick walled cylinder, as described in chapter [3].

The upper stress limit of equation (6.5a) is taken  $\leq 0.8 * R_{eH}$  and values of  $\sigma_r$  and  $\sigma_\theta$  at the inner surface of the massive part may be calculated from equations (3c) and (3d) of chapter [3], by making  $p_0 = p_{max}$ , and  $r = r_1$ , as follows:

$$\sigma_r = p_{max} \frac{r_1^2}{(r_2^2 - r_1^2)} \left[ 1 - \left( \frac{r_2}{r_1} \right)^2 \right] = -p_{max} \quad (< 0, \text{compression}) \quad (6.5b)$$

$$\begin{aligned} \sigma_\theta &= p_{max} \frac{r_1^2}{(r_2^2 - r_1^2)} \left[ 1 + \left( \frac{r_2}{r_1} \right)^2 \right] \\ &= p_{max} * \frac{r_1^2 + r_2^2}{(r_2^2 - r_1^2)} \quad (> 0, \text{tension}) \end{aligned} \quad (6.5c)$$

By making  $r_1 = \frac{d_m}{2}$ , and  $r_2 = \frac{d_a}{2}$ , in equation (6.5c)  $\sigma_\theta$  may be written:

$$\sigma_\theta = p_{max} * \frac{(d_m^2 + d_a^2)}{(d_a^2 - d_m^2)} \quad (> 0, \text{tension}) \quad (6.5d)$$

The maximum allowable push-up pressure,  $p_{max}$ , may be calculated from equation (6.5a) by using equations (6.4b) and (6.4d), to obtain:

$$p_{max} \leq \frac{0.8 * R_{eH}}{\sqrt{2} * \sqrt{1 + \left[ \frac{(d_m^2 + d_a^2)}{(d_a^2 - d_m^2)} \right]^2 + \left[ \frac{(d_m^2 + d_a^2)}{(d_a^2 - d_m^2)} \right]}} \quad (6.5e)$$

The calculation of the maximum push-up length,  $\Delta_{max}$ , associated to the maximum push-up pressure,  $p_{max}$ , may be performed by following the same procedure presented under [6.2], by only changing the value of  $p_{eq}$ , by  $p_{max}$ .

### 6.6. Dimensions of key

A top cut view of the contact area of the cone coupling joint pointing out a rudder stock section with diameter  $d_K$ , which is designed a key as shown in figure 5a, here below. Figure 5b corresponds to a vertical cut view of the key, pointing out its shear section.

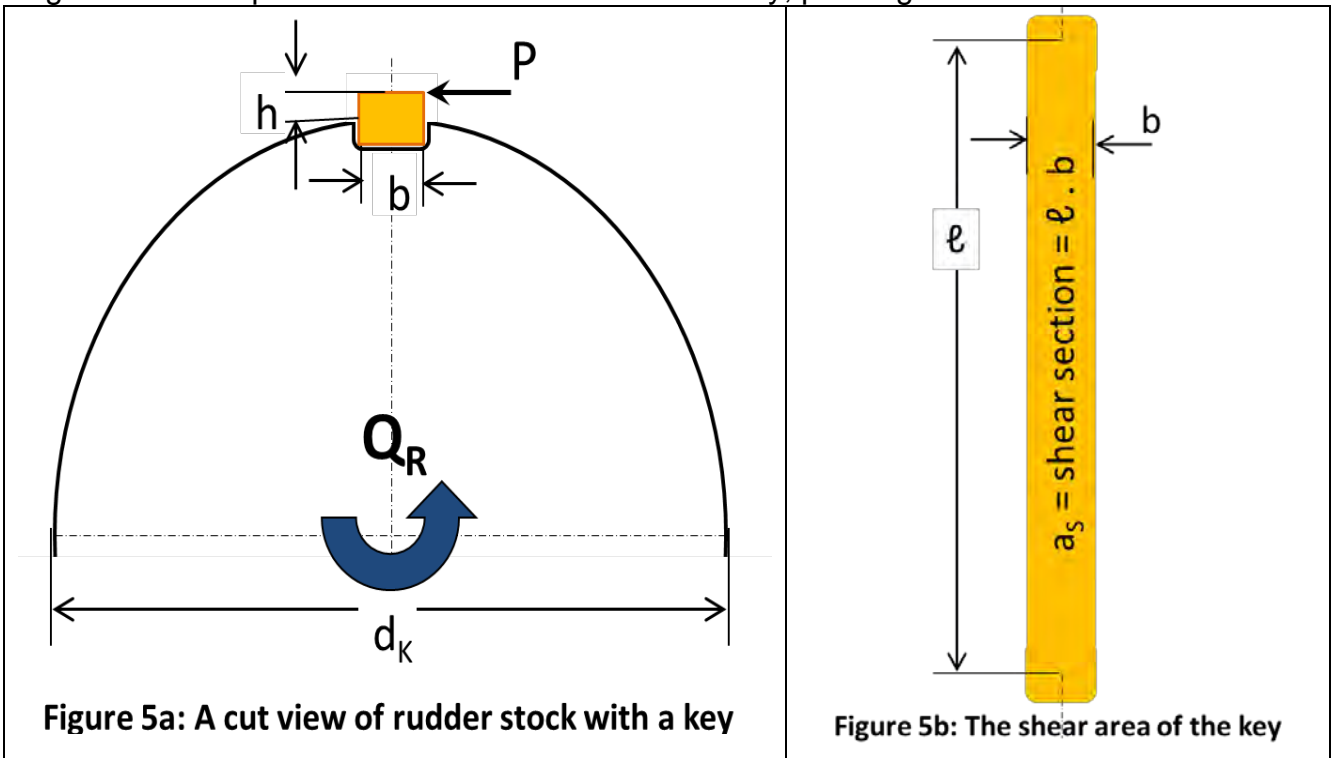


Figure 5a: A cut view of rudder stock with a key

Figure 5b: The shear area of the key

The key is designed to support the shear force,  $P$ , in  $N$ , produced by,  $Q_R$ , in the way of the cone coupling joint. ( $Q_R$ , is the torsion moment taken for the design of the rudder stock, expressed in  $N\ m$ ). The following relations between  $Q_R$  and  $P$ , and between  $\tau_P$  and  $P$ , exist:

$$P [N] * \frac{d_K [mm]}{2} = Q_R [N\ m] * 10^3 \left[ \frac{mm}{m} \right] \quad (6.5a)$$

$$\tau_P \left[ \frac{N}{mm^2} \right] = \frac{P [N]}{a_s [cm^2] * 10^2 \left[ \frac{mm^2}{cm^2} \right]} \quad (6.5b)$$

$$R_{eH\_min} \left[ \frac{N}{mm^2} \right] = \frac{P [N]}{a_K [cm^2] * 10^2 \left[ \frac{mm^2}{cm^2} \right]} \quad (6.5c)$$

Where:

$d_K$  : is the rudder stock diameter taken at the cut plane, in  $mm$  (for a conical surface, the mean diameter is taken)

$a_s$  : is the minimum key shear area, in  $cm^2$ , required to resist the shear force,  $P$ , generated by the torsion moment,  $Q_R$ , in  $N\ m$ .

$a_K$  : is the minimum normal section area, in  $cm^2$ , required to resist the force,  $P$ . This force, is first transmitted from the rudder stock to the key, and then from the key to the outer cone.

$R_{eH\_min} = \text{Min} (R_{eH\_key}, R_{eH\_stock}, R_{eH\_outerCone})$  : is the minimum yield stress, in  $N/mm^2$ , among the yield stress values obtained for the relevant materials.

The minimum shear area of the key may be calculated by using equations (6.5a) and (6.5b), the relation  $Q_F = 2 \cdot Q_R$ , and by assuming the von Mises quadratic theory to relate the maximum shear to the yield stress value, as follows:

$$\tau_P = \frac{R_{eH\_key}}{2 \cdot \sqrt{3}} \quad (6.5d): \text{ according to Mises theory with a safety factor of 2}$$

$$a_s = \frac{2 \cdot Q_R [N \cdot m] \cdot 10^3 \left[ \frac{mm}{m} \right]}{d_K \cdot \tau_P \left[ \frac{N}{mm^2} \right] \cdot 10^2 \left[ \frac{mm^2}{cm^2} \right]} = \frac{2 \cdot Q_R \cdot 10}{d_K \cdot \frac{R_{eH\_key}}{2 \cdot \sqrt{3}}} = \frac{Q_F \cdot 34.64}{d_K \cdot R_{eH\_key}} \quad (6.5e)$$

The minimum normal section area,  $a_K$ , in  $cm^2$ , may be calculated by using equations (6.5c) and (6.5a) and the relation  $Q_F = 2 \cdot Q_R$ , to obtain:

$$a_K = \frac{2 \cdot Q_R [N \cdot m] \cdot 10^3 \left[ \frac{mm}{m} \right]}{d_K \cdot R_{eH\_min} \left[ \frac{N}{mm^2} \right] \cdot 10^2 \left[ \frac{mm^2}{cm^2} \right]} = \frac{Q_F \cdot 10}{d_K \cdot R_{eH\_min}} \quad (6.5f)$$

According to design basis for cone coupling joints with a key, it is assumed that 50% of  $Q_F$  is supported by friction force and remaining 50% by the key. Consequently previous equations (6.5e) and (6.5f) may be rewritten for  $0.50 \cdot Q_F$ , as follows:

$$a_s = \frac{0.50 \cdot Q_F \cdot 34.64}{d_K \cdot R_{eH\_key}} \approx \frac{Q_F \cdot 17.32}{d_K \cdot R_{eH\_key}} \quad (6.5e\_bis)$$

$$a_K = \frac{0.50 \cdot Q_F \cdot 10}{d_K \cdot R_{eH\_min}} = \frac{Q_F \cdot 5}{d_K \cdot R_{eH\_min}} \quad (6.5f\_bis)$$

## 7. Cone coupling without key

### 7.1. Push-up pressure and push-up length to withstand $Q_F$

The same calculation procedure used under [6.1] may be adopted for the calculation of  $P_{req1\_kLess}$ , for a cone coupling connection without key, by just replacing  $Q_F$  by  $2Q_F$  inside of equation (6.1d), to obtain:

$$P_{req1\_kLess} = \frac{F_{fric}}{Area_{Contact} \cdot \mu_0} = \frac{2Q_F}{d_m^2 \cdot \pi \cdot l \cdot \mu_0} \cdot 10^3 \quad (7.1a)$$

The calculation of push-up length,  $\Delta_{req1\_kLess}$ , associated to the push-up pressure may be performed by following the same procedure presented under [6.2], by only changing the value of  $P_{eq}$ , by  $P_{req1\_kLess}$ , to obtain:

$$\Delta_{req1\_kLess} = \frac{\delta_{P_{req1\_kLess}}}{c} \quad (7.1b)$$

### 7.2. Push-up pressure and push-up length to withstand $M_B$

The same calculation procedure used under [6.3] may be adopted for the calculation of  $p_{req2\_kLess}$ , for a cone coupling connection without key. The push-up pressure for a keyless cone coupling assembly to resist the bending moment may be calculated by the same formula (6.3c) by just inputting the right geometric data and the  $M_B$  value, to obtain:

$$p_{req2\_kLess} = \frac{6 * M_B}{l^2 * d_m} 10^3, \quad \text{in } N/mm^2 \quad (7.2a)$$

The calculation of push-up length,  $\Delta_{req2\_kLess}$ , associated to the push-up pressure may be performed by following the same procedure presented under [6.2], but using  $p_{req2\_kLess}$  as a substitute for  $p_{req}$ , to obtain:

$$\Delta_{req2\_kLess} = \frac{\delta_{p_{req2\_kLess}}}{c}, \quad \text{in } mm \quad (7.2b)$$

### 7.3. Minimum push-up pressure and push-up length

The minimum value of push-up pressure is selected by taking the maximum of  $p_{req1\_kLess}$  and  $p_{req2\_kLess}$ , to obtain:

$$p_{req\_kLess} = \text{Max}(p_{req1\_kLess}, p_{req2\_kLess}) \quad (7.3a)$$

The minimum value of push-up length is selected by taking the maximum of  $\Delta_{req1\_kLess}$  and  $\Delta_{req2\_kLess}$ , to obtain:

$$\Delta_{req\_kLess} = \text{Max}(\Delta_{req1\_kLess}, \Delta_{req2\_kLess}) \quad (7.3b)$$

### 7.4. Maximum push-up pressure and push-up length

The maximum allowable push-up pressure,  $p_{max\_kLess}$ , may be calculated from equation (6.5e) by using relevant material properties and geometric data, to obtain:

$$p_{max\_kLess} \leq \frac{0.8 * R_{eH}}{\sqrt{2} * \sqrt{1 + \left[ \frac{(d_m^2 + d_a^2)}{(d_a^2 - d_m^2)} \right]^2 + \left[ \frac{(d_m^2 + d_a^2)}{(d_a^2 - d_m^2)} \right]}} \quad (7.4)$$

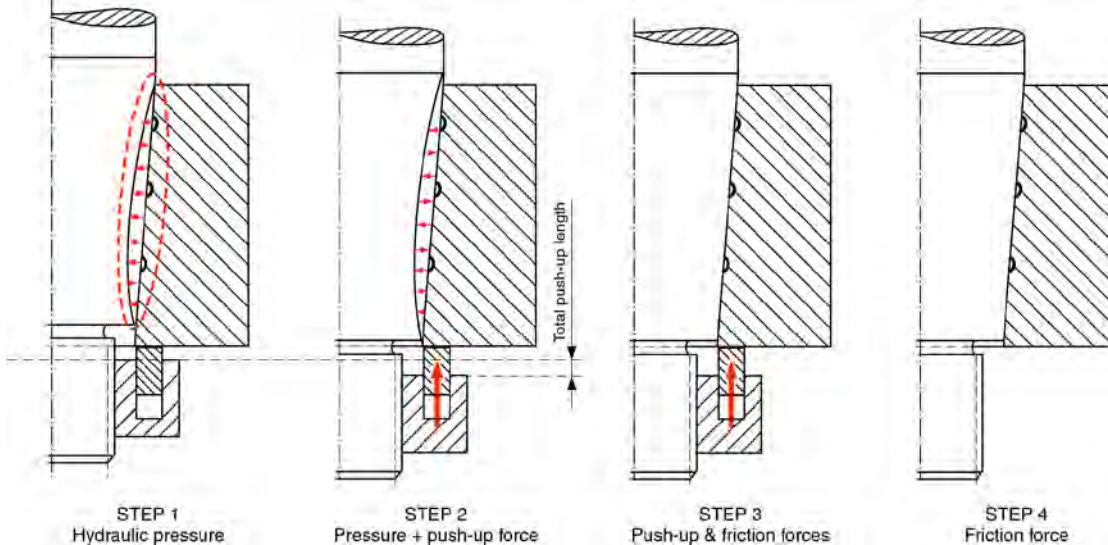
The calculation of the maximum push-up length,  $\Delta_{max\_kLess}$ , associated to the maximum push-up pressure,  $p_{max\_kLess}$ , may be performed by following the same procedure presented under [6.2], by only changing the value of  $p_{req}$ , by  $p_{max\_kLess}$ .

## 8. Cone coupling by Direct calculation

### 8.1. FE analyses with axisymmetric models

A schematic view illustrating the cone coupling assembly process based on axisymmetric elements, with twist, is shown in figure 6. The assembly procedure of figure 6 refers to a

cone coupling assembly process using hydraulic pressure. The FE analysis may be run by splitting the problem into 4 steps, as follows:



**Figure 6: Steps for the numerical simulation of cone coupling process (with oil pressure)**

These steps are listed here below:

Step 1: Hydraulic pressure allowing the increase of gap between contact surfaces of stock and hub (no friction coefficient is taken into account, during this step).

Step 2: Additional axial force is applied to generate a relative movement between parts, until a push-up distance is reached. A very low friction coefficient is used.

Step 3: The hydraulic pressure is removed and the friction coefficient is set to a value being close to reality.

Step 4: The push-up force is removed.

The assembled joint, at the end of step 4, can be tested against a torsion moment, by constraining the outer surface of the hub (the outer cone) against rotation around its longitudinal axis and by applying a torsion moment (around this same axis) to the rudder stock.

Only torsion moment may be tested based on axisymmetric approach

## **8.2. FE analyses with 3D continuum elements**

FE modelling based on 3D continuum elements can also permit the application of bending moment at the end of the cone coupling assembly process, in view of testing the capacity of the joint to withstand the bending effort.

In case of the numerical simulation of a cone coupling with hydraulic arrangements, the same sketch presented in figure 6 can be used. When dealing with 3D models, some new challenges are to be considered, such as:

- The increase of the model size requiring huge computer capabilities
- Convergence problems, related to contact interactions between 3D surfaces
- Increase of complexities for pre and post treatment operations.

Direct calculations can be adapted on a case by case basis, to make possible the modelling of any specific procedure for the cone coupling assembly process.

# **Appendix 3 Spade Direct calculations of spade rudders with a rudder trunk - accounting for stiffness of the neck bearing-support**

## **1. General**

This technical background is dedicated to the direct calculations of spade rudders with a rudder trunk, by considering the following configuration for the mechanical system:

1. A simply supported beam, with 1-rigid support in way of the steering gear and a “spring-support” in the way of the neck-bearing.

The configuration assuming 2-rigid bearing supports corresponds to a simply supported isostatic beam, and may be calculated directly by considering the equilibrium of forces and moments. The solution of this problem does not depend on the geometrical properties of rudder stock beam sections. For this approach, named as “classical approach”, the trunk is assumed infinitely rigid (no displacements in way of supports).

The approach considered inside of this technical note is named an “alternative approach” and requires further calculations to evaluate, for example, the support-stiffness in way of neck-bearing, calculated based on displacements of the rudder trunk at this location. The steering gear-support is assumed as completely rigid. It is assumed that the theory of small displacements and small rotations remains valid inside of this technical background.

## **2. Objective of the study**

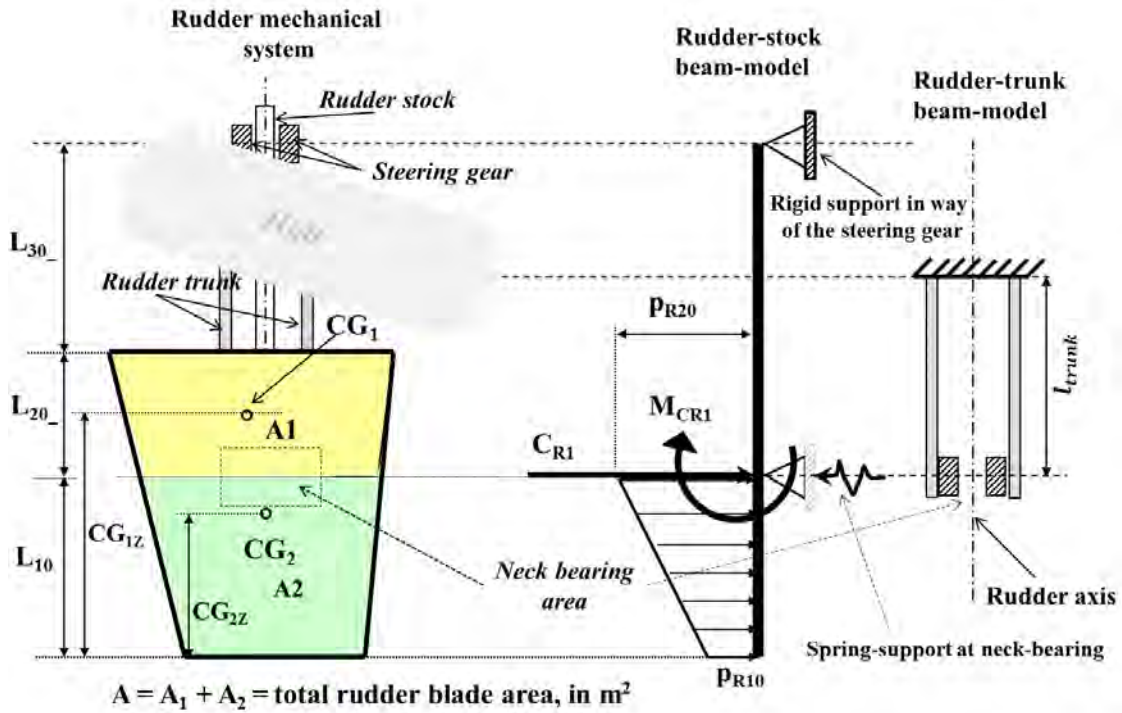
The objective of this technical note is to present an alternative method, as compared with the “classical method”, for direct calculations of spade rudder mechanical systems.

## **3. Forces, bending moment, slopes and deflections**

### ***3.1. Overview of main components of the rudder system***

Figure 1, here below shows a schematic view of the rudder mechanical system, with its main components, such as: the rudder blade, the rudder stock, the trunk and supports (at steering gear and neck bearing).





**Figure 1: forces and bending moment on the rudder system**

Resultant forces acting on areas  $A_1$  and  $A_2$  of the rudder blade (see figure 1, in yellow and green colors) are calculated, as follows:

$$C_{R1} = C_R \frac{A_1}{A_1 + A_2} \quad (1a)$$

$$C_{R2} = C_R \frac{A_2}{A_1 + A_2} \quad (1b)$$

where  $C_R$  is the rudder total rudder-force, in N, acting on rudder blade area,  $A = A_1 + A_2$  expressed in  $m^2$ .

### 3.2. Forces per unit length on the rudder body

The force per unit length  $p_{Rz}$ , acting on the lower part of the rudder body (area  $A_2$  of figure 1), is to be obtained, in N/m, from the following formula:

$$p_{Rz} = p_{R10} + \left( \frac{p_{R20} - p_{R10}}{l_{10}} \right) z \quad (1c)$$

where:

$z$  is the position of the rudder blade section, in m, taken over the rudder blade height

$p_{Rz}$  is the force per unit length, in N/m, obtained at the  $z$  position

$p_{R10}$  is the force per unit length, in N/m, obtained for  $z$  equal to zero (rudder-blade bottom level)

$p_{R20}$  is the force per unit length, in N/m, obtained for  $z$  equal to  $l_{10}$

NOTA – Equation (1c) is defined for the range  $0 \leq z \leq l_{10}$ . However, for the rudder blade scantlings it could also be extended for the range  $l_{10} \leq z \leq l_{10} + l_{20}$ , if the slope of the straight line defined in equation (1c) remains constant inside of the range  $0 \leq z \leq l_{10} + l_{20}$ .



### 3.3. Calculating $p_{R10}$ and $p_{R20}$ values

Forces per unit length,  $p_{R10}$  and  $p_{R20}$ , are calculated based on the following formulae:

$$C_{R2} = \frac{(p_{R10} + p_{R20})}{2} l_{10} \quad (2a)$$

$$\frac{(p_{R10} + p_{R20})}{2} l_{10} (l_{10} - CG_{2Z}) = (p_{R20} - p_{R10}) \frac{l_{10}}{2} \frac{l_{10}}{3} + p_{R10} l_{10} \frac{l_{10}}{2} \quad (2b)$$

Equation (2a) is related to the area of a trapezoid with parallel sides equal to  $p_{R10}$  and  $p_{R20}$ , and a height  $l_{10}$ .

Equation (2b) comes from the statement that the global static moment about an axis is equal to the sum of static moments of all constitutive 'elementary components' about the same axis. Figure 2 here below, presents schematic explanations for these 2-formulae.

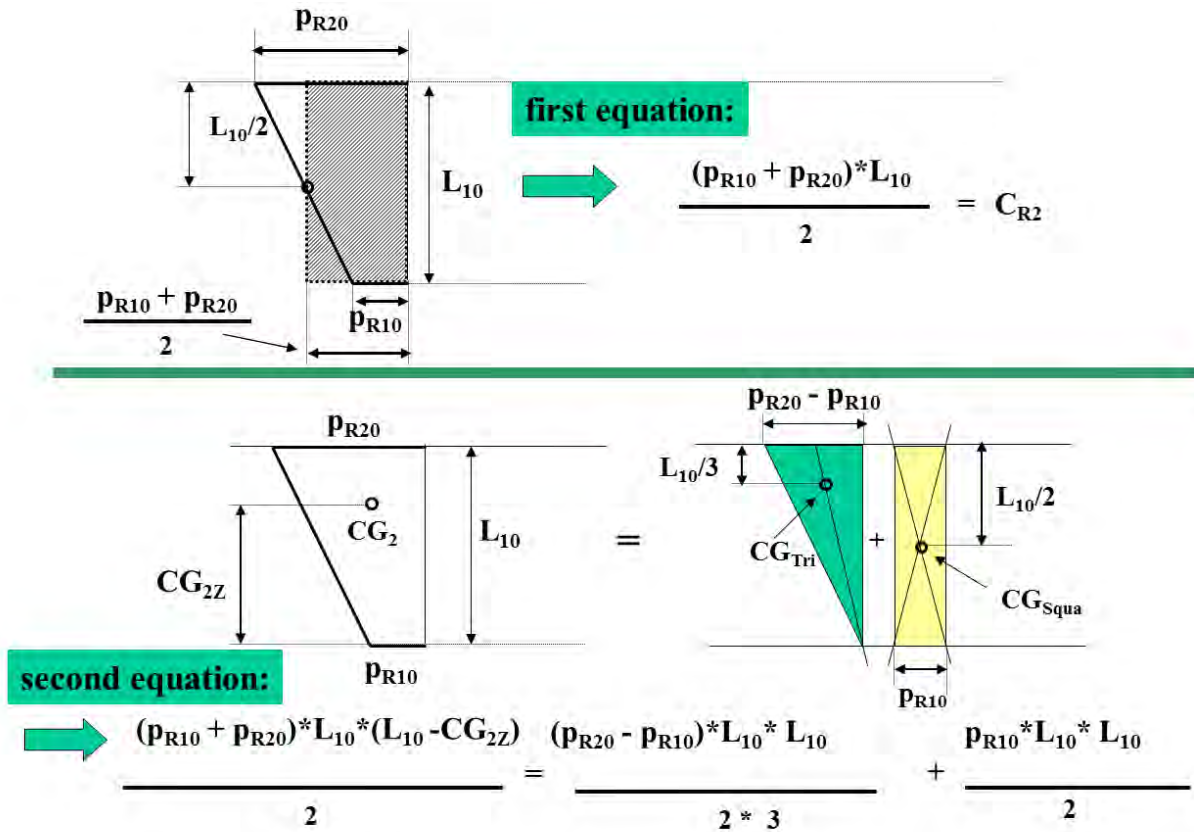


Figure 2: calculation of  $p_{R10}$  and  $p_{R20}$  - schematic explanation

Final expressions for  $p_{R10}$  and  $p_{R20}$  are obtained from equations (2a) and (2b), and are written as follows:

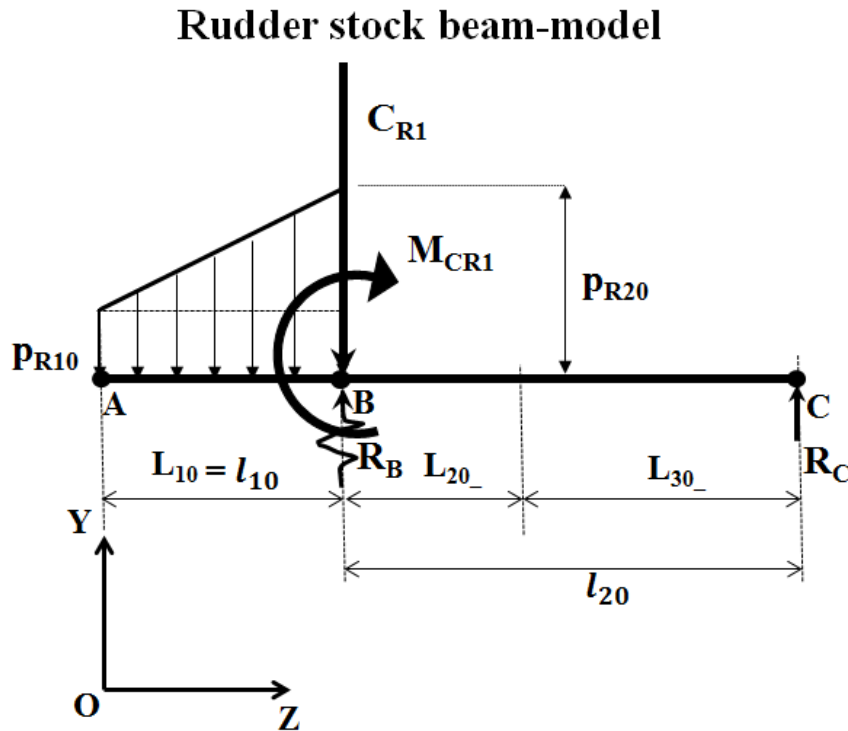
$$p_{R10} = \frac{2C_{R2}(2l_{10} - 3CG_{2Z})}{l_{10}^2} \quad (2c)$$

$$p_{R20} = \frac{2C_{R2}(3CG_{2Z} - l_{10})}{l_{10}^2} \quad (2d)$$

### 3.4. Rudder stock with a spring-support: general calculation formulae

Figure 3 here below is extracted from figure 1 to represent the rudder-stock beam model in terms of 2-basic spans that will be used for direct calculations of the rudder stock (spans AB and BC). For any cross section of the beam shown in figure 3, as a general condition of equilibrium, the following assumptions are to be true:

1. the sum of tensile stresses in Z direction = sum of compressive stresses in Z direction
2. the resisting shear force = sum of shear forces
3. the resisting bending moment = sum of bending moments
4. there should be continuity of:
  - slopes at points shared by 2 adjacent-spans
  - displacements (deflections) at points shared by 2 adjacent-spans



**Figure 3: shear forces and bending moment**

From figure 3 here above, shear forces can be written from the most left-side of the model, till its most right-side, for every span of the beam, as follows:

- for the span AB (  $0 \leq Z < l_{10}$  or  $0 \leq z < l_{10}$  )
 
$$S_z = S_A - p_{R10}z - \left[ \left( \frac{p_{R20} - p_{R10}}{l_{10}} \right) \frac{z^2}{2} \right] z \quad (3a)$$

- for the span BC (  $l_{10} < Z \leq l_{10} + l_{20}$  or  $0 < z \leq l_{20}$  )
 
$$S_z = S_{B-} - C_{R1} + R_B \quad (3b)$$

The reaction force  $R_B$  is calculated based on the stiffness of the trunk in way of the neck-bearing, by using the following formulae:

$$R_B = -K_{trunk} y_B \quad (3a_1)$$

$$K_{trunk} = \frac{3EJ_{trunk}}{1.3l_{trunk}^3} \quad (3a_2)$$

where:

$K_{trunk}$  is the spring constant, in N/m, at the cross section of the trunk in way of the neck bearing

$y_B$  is the deflection of the rudder stock beam, in m, calculated at point B

$l_{trunk}$  is the length of the trunk, in m, from its built-in section till the neck bearing mid-section

$J_{trunk}$  is the moment of inertia of the trunk, in  $m^4$ , and E is the Young's modulus, in  $N/m^2$

$S_z$  is the shear force, in N, acting on a cross section located at a distance Z from the origin O

$S_A$  is the shear force, in N, acting on a cross section located at point A ( $Z = 0$ )

$S_{B-}$  is the shear force, in N, inside of span AB, acting on a cross section close to point B ( $Z \approx l_{10}$ )

$R_B$  is the reaction force, in N, at point B ( $Z = l_{10}$ ), which depends on the support stiffness

$R_C$  is the reaction force, in N, acting at point C ( $Z = l_{10} + l_{20}$ )

Expressions for bending moments, in N.m, acting on any cross-section of the beam, from the most-left to the right, may be obtained by integrating equations (3a) and (3b) from 0 to z (inside of each span):

- for the span AB:

$$M_z = M_A + S_A z - p_{R10} \frac{z^2}{2} - \left( \frac{p_{R20} - p_{R10}}{l_{10}} \right) \frac{z^3}{6} \quad (3c0)$$

By assuming  $S_A = M_A = 0$ , equation (3c0) becomes:

$$M_z = -p_{R10} \frac{z^2}{2} - \left( \frac{p_{R20} - p_{R10}}{l_{10}} \right) \frac{z^3}{6} \quad (3c)$$

- for the span BC:

$$M_z = M_{B-} + M_{CR1} + \int_0^z (S_{B-} - C_{R1} + R_B) dz \quad (3d0) \quad or$$

$$M_z = M_{B-} + M_{CR1} + S_{B-} z - C_{R1} z + R_B z \quad (3d)$$

where:

$M_{B-}$  = the bending moment at the end of span AB (equation 3c, for  $z = Z \approx l_{10}$ )

$M_{CR1}$  = the bending moment at the beginning of span BC ( $C_{R1}$ , with a lever arm =  $CG_{1Z} - l_{10}$ )

In the elastic domain, and for small deflections of the beam, the following differential equations (4a) and (4b), may apply at any section of the elastic beam:

$$EJ \left( \frac{d^2 y}{dz^2} \right) = M \quad (4a) ;$$

$$or \quad \left( \frac{d^2 y}{dz^2} \right) = \frac{M}{EJ} \quad (4b) ;$$

Where:  $E$  = modulus of elasticity of the material, in  $N/m^2$ ,  $J$  = moment of inertia of the cross section, in  $m^4$ ,  $M$  is the bending moment, in  $N.m$ , and  $y$  is the deflection of the beam cross-section at a position  $z$ .

Expressions of slopes,  $\theta_z$ , for any cross section of the beam, may be calculated by substituting equations (3c) and (3d), expressing bending moments over spans AB and BC, respectively, in equation (4b), and by integrating these resultant equations inside of each span:

- for span AB:

$$\theta_z = \left( \frac{dy}{dz} \right)_z = \theta_A - p_{R10} \frac{z^3}{6EJ_1} - \left( \frac{p_{R20} - p_{R10}}{l_{10}} \right) \frac{z^4}{24EJ_1} \quad (5a)$$

- for span BC:

$$\theta_z = \left( \frac{dy}{dz} \right)_z = \theta_B + \frac{M_{E_-} z}{EJ_2} + \frac{M_{CR1} z}{EJ_2} + \frac{S_{E_-} z^2}{2EJ_2} - \frac{C_{R1} z^2}{2EJ_2} + \frac{R_B z^2}{2EJ_2} \quad (5b)$$

where:

$\theta_{z_-} = \theta_{z_+} = \theta_z$  is the beam slope at any cross section (continuity of slopes)

$J_1$  is the moment of inertia of the cross section for the span AB

$J_2$  is the moment of inertia of the cross section for the span BC

Deflections of the beam cross section,  $y_z$  (where  $y_{z_-} = y_{z_+} = y_z$ : continuity of deflections), in m, may be calculated at the neutral fiber of the beam, by integrating equations (5a) and (5b) inside of spans AB and BC, respectively:

- for span AB:

$$y_z = y_A + \theta_A z - p_{R10} \frac{z^4}{24EJ_1} - \left( \frac{p_{R20} - p_{R10}}{l_{10}} \right) \frac{z^5}{120EJ_1} \quad (6a)$$

- for span BC:

$$y_z = y_B + \theta_B z + \frac{M_{E_-} z^2}{2EJ_2} + \frac{M_{CR1} z^2}{2EJ_2} + \frac{S_{E_-} z^3}{6EJ_2} - \frac{C_{R1} z^3}{6EJ_2} + \frac{R_B z^3}{6EJ_2} \quad (6b)$$

### 3.5. Rudder stock beam-model: calculation formulae close to supports

Based on general calculation formulae described in 3.4, shear forces, bending moments, slopes and deflection at points B and C of figure 3 may be defined.

- from equation 3a, for  $z = Z \approx l_{10}$ , it follows:

$$S_{E_-} = -p_{R10} l_{10} - \left[ \left( \frac{p_{R20} - p_{R10}}{2} \right) l_{10} \right] \quad (7a)$$

- from equation 3b, for  $z = l_{20}$  or  $Z = l_{10} + l_{20}$ , it follows:

$$S_C = S_{E_-} - C_{R1} + R_B \quad (7b)$$

According to equations 3b and 7b it can be noted that shear forces all along BC span have a constant value with  $z$ , equal to  $S_C$ . Consequently,  $R_C = S_C$  (7b<sub>1</sub>)

- from equation 3c, for  $z = Z \approx l_{10}$ , it follows:

$$M_{B_-} = -\left(\frac{2p_{R10} + p_{R20}}{6}\right)l_{10}^2 \quad \text{and} \quad M_{CR1} = C_{R1}(CG_{1Z} - l_{10}) \quad (7c)$$

- from equation 3d, for  $z = l_{20}$  (or  $Z = l_{10} + l_{20}$ ), it follows:

$$M_C = M_{B_-} + M_{CR1} + S_{B_-}l_{20} - C_{R1}l_{20} + R_B l_{20} \quad (7d)$$

- from equations 5a and 6a, for  $z = Z \approx l_{10}$ , it follows (span AB):

$$\theta_B = \theta_A - p_{R10} \frac{l_{10}^3}{6EJ_1} - \left(\frac{p_{R20} - p_{R10}}{24}\right) \frac{l_{10}^3}{EJ_1} \quad (7e0) \quad \text{or}$$

$$\theta_B = \theta_A - \frac{3p_{R10}l_{10}^3 + p_{R20}l_{10}^3}{24EJ_1} \quad (7e1)$$

$$y_B = y_A + \theta_A l_{10} - p_{R10} \frac{l_{10}^4}{24EJ_1} - \left(\frac{p_{R20} - p_{R10}}{l_{10}}\right) \frac{l_{10}^5}{120EJ_1} \quad (7e2) \quad \text{or}$$

$$\theta_A = \frac{y_B - y_A}{l_{10}} + \frac{4p_{R10}l_{10}^3}{120EJ_1} + \frac{p_{R20}l_{10}^3}{120EJ_1} \quad (7e3)$$

- from equations 5b and 6b, for  $z = l_{20}$  (or  $Z = l_{10} + l_{20}$ ), it follows:

$$\theta_C = \theta_B + \frac{M_{B_-}l_{20}}{EJ_2} + \frac{M_{CR1}l_{20}}{EJ_2} + \frac{S_{B_-}l_{20}^2}{2EJ_2} - \frac{C_{R1}l_{20}^2}{2EJ_2} + \frac{R_B l_{20}^2}{2EJ_2} \quad (7e4)$$

$$y_C = y_B + \theta_B l_{20} + \frac{M_{B_-}l_{20}^2}{2EJ_2} + \frac{M_{CR1}l_{20}^2}{2EJ_2} + \frac{S_{B_-}l_{20}^3}{6EJ_2} - \frac{C_{R1}l_{20}^3}{6EJ_2} + \frac{R_B l_{20}^3}{6EJ_2} \quad (7e5)$$

$$\theta_B = \frac{y_C - y_B}{l_{20}} - \frac{M_{B_-}l_{20}}{2EJ_2} - \frac{M_{CR1}l_{20}}{2EJ_2} - \frac{S_{B_-}l_{20}^2}{6EJ_2} + \frac{C_{R1}l_{20}^2}{6EJ_2} - \frac{R_B l_{20}^2}{6EJ_2} \quad (7e6)$$

## 4. Reaction forces, slopes and displacements at points A, B and C

### 4.1. Calculation of reaction forces at points B and C

Assuming that the bending moment  $M_C = 0$ , the reaction force,  $R_B$ , can be calculated from equation 7d, as follows:

$$R_B = \frac{-(M_{B_-} + M_{CR1})}{l_{20}} - S_{B_-} + C_{R1} \quad (8a)$$

where:

$M_{B_-}$  and  $M_{CR1}$  are calculated from equations given in 7c

$C_{R1}$  and  $C_{R2}$  are calculated from equations 1a and 1b

$p_{R10}$  and  $p_{R20}$  are calculated from equations 2c and 2d

$S_{B_-}$  is calculated from equation 7a

After the calculation of  $R_B$ , the reaction force  $R_C$ , can be obtained directly from equations 7b and 7b<sub>1</sub>.

## 4.2. Slopes and displacements at points A, B and C

From equations 3a<sub>1</sub> and 3a<sub>2</sub>, the displacement at point B,  $y_B$ , can be calculated, as follows:

$$y_B = -\frac{R_B}{K_{trunk}} \quad (8b)$$

where:

$K_{trunk}$  is calculated, in N/m, from equation 3a<sub>2</sub>

The moment of inertia of the rudder trunk,  $I_{trunk}$ , in m<sup>4</sup>, is calculated, as follows:

$$I_{trunk} = \frac{\pi(d_{out}^4 - d_{in}^4)}{64} \quad (8c)$$

where:

$d_{out}$  and  $d_{in}$  are the outer and inner diameters of the rudder trunk, in m

The slope at point B,  $\theta_B$ , can be calculated from equation 7e<sub>6</sub>, by making the displacement at point C,  $y_C = 0$ .

The slope at point A,  $\theta_A$ , can be calculated from equation 7e<sub>1</sub>, by assuming the continuity of slopes at point B of the beam,  $\theta_{B-(span AB)} = \theta_{B+(span BC)} = \theta_B$ .

Finally, based on all calculated values of slopes and displacements, the displacement at point A,  $y_A$ , can be calculated from equation 7e<sub>2</sub>.

## Appendix 4 Concept of 2-conjugate elastic supports

### 1. General

This concept is applicable to semi-spade rudders with two pintle bearings, shared by both the rudder beam and the rudder horn.

The rudder beam is a mechanical system constituted by the rudder stock and the rudder blade, represented as a simply supported beam model, with three supports as follows:

- A rigid top bearing (in way of the steering gear),
- 2-pintle bearings, with stiffnesses calculated based on the rudder-horn section properties

The rudder horn is represented by a cantilever beam, with the top side completely built-in on the ship hull.

Torsion and bending effects are considered separately, and superposition principle is applied at the end, to account for these two effects.

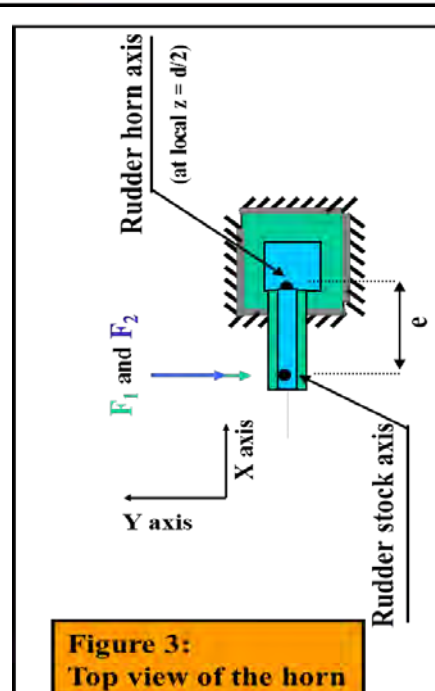
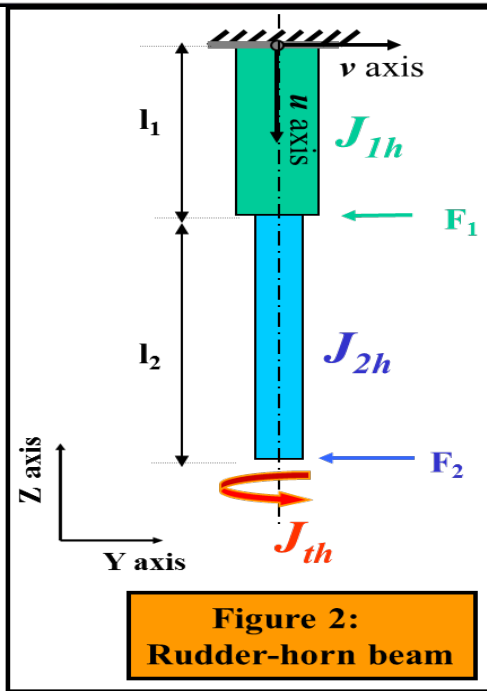
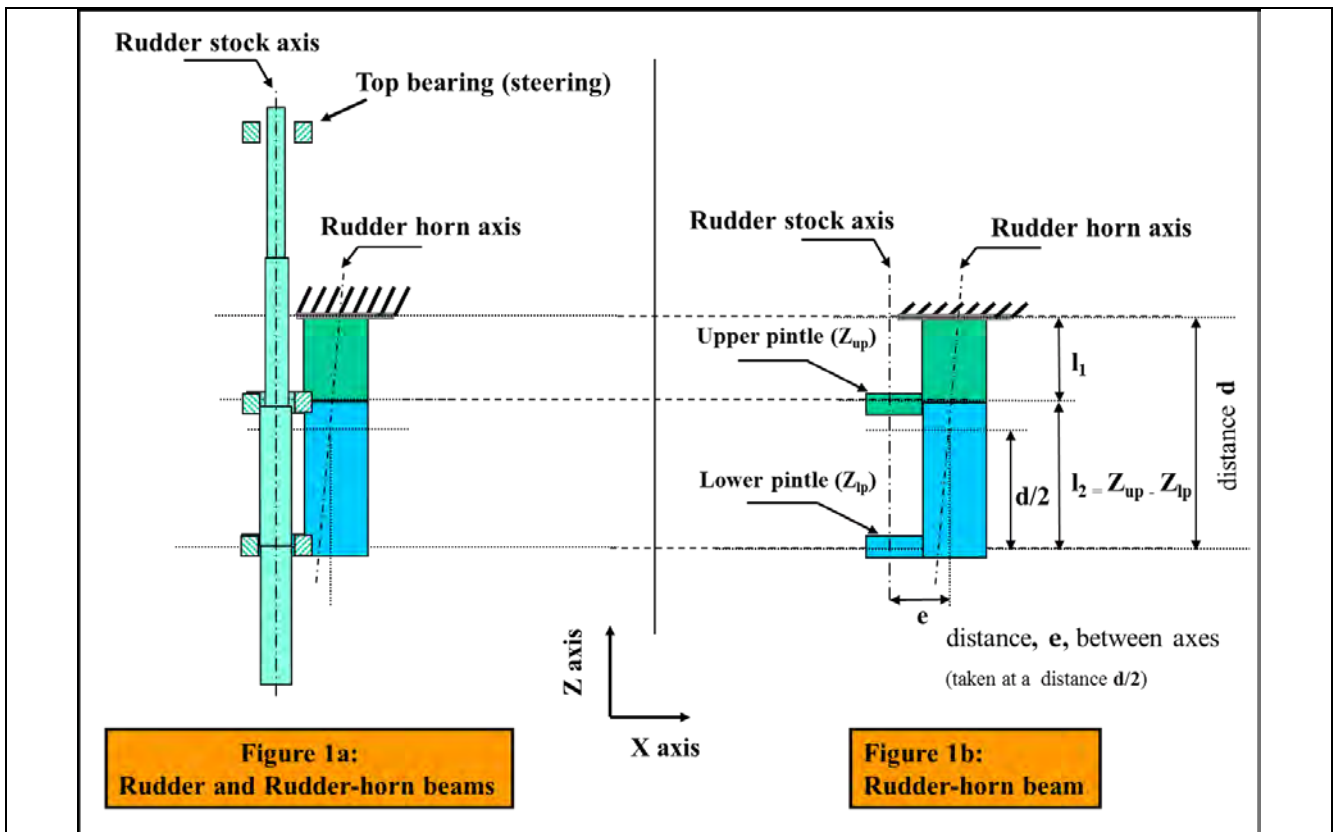
### 2. Objective of the study

The objective of this technical note is to express the stiffness of 2-pintle supports in terms of section properties of the rudder horn. The final expression will take into consideration both bending and torsion terms.

### 3. Beam models

#### 3.1. Models overview

Figures 1a and 1b illustrate the rudder and rudder-horn beams that are used for the modeling of both the rudder beam and the rudder-horn mechanical systems. They also show how beam models are connected between themselves. Figures 2 and 3 are showing different views of the rudder-horn mechanical system.



According to figures 1 to 3 the rudder-horn structure is submitted to bending and torsion caused by forces  $F_1$  and  $F_2$ , which are support forces acting on the upper and lower pintle-bearings, respectively. These support forces are obtained from direct calculation of the rudder beam, by considering the unit length forces acting on the lower and upper areas of the rudder blade, as described in 3.2.

The following parameters are required for the calculation of the “support-stiffnesses”:

- the moment of inertia of the rudder-horn about the x-axis,  $J_{1h}$ , for the 1st span, given in  $m^4$
- the moment of inertia of the rudder-horn about the x-axis,  $J_{2h}$ , for the 2nd span, given in  $m^4$



- the torsional stiffness factor of the rudder-horn,  $J_{th}$ , in  $m^4$ , which depends on the shape and dimensions of the rudder-horn cross section
- geometric parameters, in m, such as: distances d and e, span lengths  $l_1$  and  $l_2$ , etc.

### 3.2. Forces per unit length on the rudder body

The forces per unit length  $P_{R10}$  and  $P_{R20}$  acting on the rudder body are to be obtained, in N/m, from the following formulae:

- for the rudder blade area below the lower pintle, defined as area  $A_2$

$$P_{R10} = \frac{C_{R2}}{l_{lower}} \quad (1a)$$

- for the rudder blade area above the lower pintle, defined as area  $A_1$

$$P_{R20} = \frac{C_{R1}}{l_{upper}} \quad (1b)$$

where:

$C_{R1}$  and  $C_{R2}$  are rudder forces, in N, acting on each part  $A_1$  and  $A_2$  of the rudder blade, respectively

$l_{lower}$  is the relevant height, in m, of the lower rudder blade area,  $A_2$

$l_{upper}$  is the relevant height, in m, of the upper rudder blade area,  $A_1$

## 4. Calculation procedure

### 4.1. Displacements and forces in way of pintle-bearings

A local system of axes, with unit vectors  $\mathbf{u}$  and  $\mathbf{v}$ , is defined for the cantilever beam of figure 2, as follows:

- origin of the system is taken at the built-in point of the rudder-horn axis
- $\mathbf{u}$  vector taken parallel to  $-Z$  axis
- $\mathbf{v}$  vector taken parallel to  $Y$  axis

Displacements of the rudder-horn beam,  $\mathbf{v}_{upper}$  and  $\mathbf{v}_{lower}$ , in way of upper and lower pintle-bearings, are related to support forces  $F_1$  and  $F_2$ , at upper and lower pintle-bearings, respectively, by the following matrix expression:

$$\begin{Bmatrix} \mathbf{v}_{upper} \\ \mathbf{v}_{lower} \end{Bmatrix} = [Compli]_{horn} \begin{Bmatrix} F_1 \\ F_2 \end{Bmatrix} \quad (2a)$$

The compliance matrix of the rudder-horn is written, as follows:

$$[Compli]_{horn} = \begin{bmatrix} -k_{11} & -k_{12} \\ -k_{21} & -k_{22} \end{bmatrix} \quad (2b)$$

Equation (2a) may also be written, as follows:

$$\begin{Bmatrix} \mathbf{v}_{upper} \\ \mathbf{v}_{lower} \end{Bmatrix} = \begin{bmatrix} -k_{11} & -k_{12} \\ -k_{21} & -k_{22} \end{bmatrix} \begin{Bmatrix} F_1 \\ F_2 \end{Bmatrix} \quad (2c)$$

The following remarks apply to the rudder-horn matrix-terms:

- $k_{11}$  and  $k_{21}$  relate to components of displacements on points 1 and 2, respectively, caused by force  $F_1$

- $k_{12}$  and  $k_{22}$  relate to components of displacements on points 1 and 2, respectively, caused by force  $F_2$

The negative signs of compliance matrix-terms are to compensate opposite signs of forces acting on the rudder blade when compared with those of support forces (reaction forces).

Every compliance matrix-term has 2 categories of components: those referring to bending effects and those related with torsion (axes of the rudder beam and rudder-horn beam are considered as parallel, at a distance of “e” meters, as shown in figure 3). As the superposition principle applies for elastic beams, submitted to small displacements, the bending and torsion contributions will be first considered separately, under 4.2 and 4.3., respectively. Final expressions of compliance matrix-terms, including both bending and torsion effects, are presented under 4.4.

## 4.2. Components of compliance matrix-terms due to bending

The algebraic sum of the moments of the external forces that lie to the “bottom” side of any cross section of the cantilever “rudder-horn” beam of figure 2 is accounted for each beam span, starting from the built-in cross-section till the free end cross-section of this beam.

Adopting a local system of axes based on the unit vectors  $\mathbf{u}$  and  $\mathbf{v}$ , as defined in 4.1, the bending moment equation for any cross-section taken within the first beam span ( $0 \leq u \leq l_1$ ), may be written as follows:

$$M_u = -F_1(l_1 - u) - F_2(l_1 + l_2 - u) \quad (3)$$

In the elastic domain, and for small deflections of the beam, the following differential equations (4a) and (4b), may apply at any section of the elastic beam:

$$EJ \left( \frac{d^2 v}{du^2} \right) = M \quad (4a); \quad \text{or} \quad \left( \frac{d^2 v}{du^2} \right) = \frac{M}{EJ} \quad (4b);$$

Where: E = modulus of elasticity of the material, J = moment of inertia of the cross section, M is the bending moment, and v is the deflection of the beam cross-section at a position u.

By substituting equation (3) in equation (4b), and by integrating this resultant equation, it lies:

$$\frac{dv}{du} = -\frac{1}{EJ_{1h}} \int [F_1(l_1 - u) + F_2(l_1 + l_2 - u)] du + C_{11} \quad (5a)$$

$$\frac{dv}{du} = -\frac{1}{EJ_{1h}} \left[ F_1 \left( l_1 u - \frac{u^2}{2} \right) + F_2 \left( l_1 u + l_2 u - \frac{u^2}{2} \right) \right] + C_{11} \quad (5b)$$

$\frac{dv}{du}$  is the slope of the beam at position u ( $0 \leq u \leq l_1$ ). At  $u = 0$ , the slope is zero, and consequently,  $C_{11} = 0$ , and equation (5b) becomes equation (5c), as follows:

$$\frac{dv}{du} = -\frac{1}{EJ_{1h}} \left[ F_1 \left( l_1 u - \frac{u^2}{2} \right) + F_2 \left( l_1 u + l_2 u - \frac{u^2}{2} \right) \right] \quad (5c)$$

Equation (5d) is obtained by taking  $u = l_1$  in equation (5c), as follows:

$$\left. \frac{dv}{du} \right|_{l_1} = -\frac{l_1}{EJ_{1h}} \left[ F_1 \left( l_1 - \frac{l_1}{2} \right) + F_2 \left( l_1 + l_2 - \frac{l_1}{2} \right) \right] \quad (5d)$$

The integration of equation (5c) gives the expression of the beam deflection at position  $u$ , as follows:

$$v_u = -\frac{1}{EJ_{1h}} \left[ F_1 \left( l_1 \frac{u^2}{2} - \frac{u^3}{6} \right) + F_2 \left( l_1 \frac{u^2}{2} + l_2 \frac{u^2}{2} - \frac{u^3}{6} \right) \right] + C_{12} \quad (6a)$$

At  $u = 0$ , the deflection of the beam,  $v_0 = 0$ ., and consequently,  $C_{12} = 0$ .

Equation (6a) can be written for  $u = l_1$ , as follows:

$$v_{l_1} = -\frac{l_1^2}{2EJ_{1h}} \left[ F_1 \left( l_1 - \frac{l_1}{3} \right) + F_2 \left( l_1 + l_2 - \frac{l_1}{3} \right) \right] \quad (6b)$$

For the second beam span ( $l_1 \leq u \leq l_1 + l_2$ ) the algebraic sum of the moments of the external forces that lie to the “bottom” side of any cross section of the cantilever “rudder-horn” beam of figure 2 is written, as follows:

$$M_u = -F_2 \cdot (l_1 + l_2 - u) \quad (7)$$

By repeating operations from equation (3) to equation (5b), but now starting from equation (7), the following expression can be written for  $l_1 \leq u \leq l_1 + l_2$ :

$$\frac{dv}{du} = -\frac{1}{EJ_{2h}} \left[ F_2 \left( l_1 u + l_2 u - \frac{u^2}{2} \right) \right] + C_{21} \quad (8b)$$

$C_{21}$  can be calculated by making  $u = l_1$  in equation (8b), and by comparing this resultant equation with equation (5d), to obtain the following expression:

$$C_{21} = -\frac{l_1}{EJ_{1h}} \left[ F_1 \left( l_1 - \frac{l_1}{2} \right) + F_2 \left( l_1 + l_2 - \frac{l_1}{2} \right) \right] - \frac{l_1}{EJ_{2h}} \left[ F_2 \left( -l_1 - l_2 + \frac{l_1}{2} \right) \right] \quad (8c)$$

By substituting equation (8c) in equation (8b), and by integrating the resultant equation, the expression of beam deflection can be written, as follows:

$$v_u = -\frac{1}{EJ_{1h}} \left\{ \sum_{i=1}^2 F_i \left[ \left( \sum_{k=1}^i l_k \right) l_1 u - \frac{l_1^2}{2} u \right] \right\} - \frac{1}{EJ_{2h}} \left\{ F_2 \left[ \left( \sum_{k=1}^2 l_k \right) \left( \frac{u^2}{2} - l_1 u \right) + \frac{l_1^2}{2} u - \frac{u^3}{6} \right] \right\} + C_{22} \quad (9a)$$

Equation (9a) can be written for  $u = l_1$ , as follows:

$$v_{l_1} = -\frac{l_1^2}{EJ_{1h}} \left\{ \sum_{i=1}^2 F_i \left[ \left( \sum_{k=1}^i l_k \right) - \frac{l_1}{2} \right] \right\} - \frac{l_1^2}{EJ_{2h}} \left\{ F_2 \left[ \left( \sum_{k=1}^2 \frac{-l_k}{2} \right) + \frac{2l_1}{3} \right] \right\} + C_{22} \quad (9b)$$

$C_{22}$  is calculated by substituting equation (9b) in equation (6b), to obtain:

$$C_{22} = -\frac{l_1^2}{EJ_{1h}} \left\{ \sum_{i=1}^2 F_i \left[ \left( \sum_{k=1}^i \frac{-l_k}{2} \right) + \frac{l_1}{3} \right] \right\} - \frac{l_1^2}{EJ_{2h}} \left\{ F_2 \left[ \left( \sum_{k=1}^2 \frac{l_k}{2} \right) - \frac{l_1}{3} \right] \right\} \quad (9c)$$

$$C_{22} = -\frac{1}{EJ_{1h}} \left\{ \sum_{i=1}^2 F_i \left[ \left( \sum_{k=1}^i \frac{-l_k \cdot l_1^2}{2} \right) + \frac{l_1^3}{3} \right] \right\} - \frac{1}{EJ_{2h}} \left\{ F_2 \left[ \left( \sum_{k=1}^2 \frac{l_k \cdot l_1^2}{2} \right) - \frac{l_1^3}{3} \right] \right\} \quad (9d)$$

By replacing  $C_{22}$  in equation (9a), it can be written:

- For terms multiplying  $\frac{1}{EJ_{1h}}$ :

$$v_u = -\frac{1}{EJ_{1h}} \left\{ \sum_{i=1}^2 F_i \left[ \left( \sum_{k=1}^i l_k \right) \left( l_1 u - \frac{l_1^2}{2} \right) - \frac{l_1^2}{2} u + \frac{l_1^3}{3} \right] \right\} \quad (10a)$$

- For terms multiplying  $\frac{1}{EJ_{2h}}$ :

$$v_u = -\frac{1}{EJ_{2h}} \left\{ F_2 \left[ \left( \sum_{k=1}^2 l_k \right) \left( \frac{u^2}{2} - l_1 u + \frac{l_1^2}{2} \right) + \frac{l_1^2}{2} u - \frac{u^3}{6} - \frac{l_1^3}{3} \right] \right\} \quad (10b)$$

For  $u = l_1 + l_2$ , equations (10a) and (10b) become equations (11a) and (11b), respectively:

- For terms multiplying  $\frac{1}{EJ_{1h}}$ :

$$v_{l_1+l_2} = -\frac{1}{EJ_{1h}} \left\{ \sum_{i=1}^2 F_i \left[ \left( \sum_{k=1}^i l_k \right) \left( l_1 (l_1 + l_2) - \frac{l_1^2}{2} \right) - \frac{l_1^2}{2} (l_1 + l_2) + \frac{l_1^3}{3} \right] \right\} \quad (11a)$$

- For terms multiplying  $\frac{1}{EJ_{2h}}$ :

$$v_{l_1+l_2} = -\frac{1}{EJ_{2h}} \left\{ F_2 \left[ \left( \sum_{k=1}^2 l_k \right) \left( \frac{(l_1 + l_2)^2}{2} - l_1 (l_1 + l_2) + \frac{l_1^2}{2} \right) + \frac{l_1^2}{2} (l_1 + l_2) - \frac{(l_1 + l_2)^3}{6} - \frac{l_1^3}{3} \right] \right\} \quad (11b)$$

Compliance matrix-terms due to bending may be calculated based on equation (2c), by associating this equation with:

- equation (6b), for the calculation of  $k_{11}$  and  $k_{12}$ , which are related to displacements of point 1 caused by forces  $F_1$  and  $F_2$ , respectively
- equations (11a) and (11b), for the calculation of  $k_{21}$  and  $k_{22}$ , which are related to displacements of point 2 caused by forces  $F_1$  and  $F_2$ , respectively.

Bending components are written, as follows:

$$k_{11_{bend}} = \frac{l_1^3}{3EJ_{1h}} \quad (12a)$$

$$k_{12_{\text{bend}}} = k_{21_{\text{bend}}} = \frac{l_1^3}{3EJ_{1h}} + \frac{l_1^2(d-l_1)}{2EJ_{1h}} \quad (12b)$$

$$k_{22_{\text{bend}}} = \frac{l_1^3}{3EJ_{1h}} + \frac{l_1^2(d-l_1)}{EJ_{1h}} + \frac{l_1(d-l_1)^2}{EJ_{1h}} + \frac{(d-l_1)^3}{3EJ_{2h}} \quad (12c)$$

where  $l_2 = (d - l_1)$ , can be read from figure 1b.

For  $l_1 = 0$ , the 2-conjugate elastic support becomes the 1-elastic support. To keep consistency between formulae given in equations (12a), (12b), (12c) and that one of the spring constant of 1-elastic support, the factor of 1.3 is applied to equations (12..), to obtain:

$$k_{11_{\text{bend}}} = 1.3 \frac{l_1^3}{3EJ_{1h}} \quad (13a)$$

$$k_{12_{\text{bend}}} = k_{21_{\text{bend}}} = 1.3 \left[ \frac{l_1^3}{3EJ_{1h}} + \frac{l_1^2(d-l_1)}{2EJ_{1h}} \right] \quad (13b)$$

$$k_{22_{\text{bend}}} = 1.3 \left[ \frac{l_1^3}{3EJ_{1h}} + \frac{l_1^2(d-l_1)}{EJ_{1h}} + \frac{l_1(d-l_1)^2}{EJ_{1h}} + \frac{(d-l_1)^3}{3EJ_{2h}} \right] \quad (13c)$$

### 4.3. Components of compliance matrix-terms due to torsion

The compliance matrix-terms due to torsion are calculated by assuming the rudder beam axis is parallel to the rudder-horn axis, and is located at a distance “e”, in m, of the latter axis. Calculations are based on the following equation, which are valid for the torsion of thin-wall closed sections:

$$\frac{\theta}{L} = \frac{T}{GJ} \quad (14a) \quad \text{or} \quad \theta = \frac{LT}{GJ} \quad (14b)$$

Where:

$\theta$  = angle of twist, in radians;  $L$  = length in axial direction, in m;  
 $T$  = twisting moment, in N.m;  $G$  = shear elasticity modulus, in N/m<sup>2</sup>;  
 $J$  = polar moment of inertia, in m<sup>4</sup>;

The equation (14c) is obtained from equation (14b) by considering the thin-wall closed section of the rudder horn illustrated in figures 2 and 3:

$$\theta_i = \frac{L_i F_i e}{G J_{th}} \quad (14c)$$

Where:

$L_i = l_1$  or  $l_1 + l_2$ , in m;  $F_i = F_1$  or  $F_2$ , in N;  $e$  = distance between axes, in m

Displacements of the rudder horn caused by torsion are calculated based on the product of the angle of twist by the gyration radius, e, as follows:

$$v_{torsion} = v_{t_i} = e \cdot \theta_i \quad (15a)$$

By replacing equation (14c) in equation (15a), displacements of the rudder horn by torsion may be calculated, as follows:

$$v_{t_i} = \frac{L_i F_i e^2}{G J_{th}} \quad (15b)$$

Compliance matrix-terms due to torsion may be calculated based on equations (2c) and (15b), as follows:

$$v_{t_1} = \frac{l_1 F_1 e^2}{G J_{th}} + \frac{l_1 F_2 e^2}{G J_{th}} \quad (16a)$$

$$k_{11_{tors}} = \frac{l_1 \cdot e^2}{G J_{th}} \quad (16b)$$

$$k_{12_{tors}} = \frac{l_1 \cdot e^2}{G J_{th}} \quad (16c)$$

$$v_{t_2} = \frac{l_1 F_1 e^2}{G J_{th}} + \frac{(l_1 + l_2) F_2 e^2}{G J_{th}} \quad (17a)$$

$$k_{21_{tors}} = \frac{l_1 \cdot e^2}{G J_{th}} \quad (17b)$$

$$k_{22_{tors}} = \frac{(l_1 + l_2) \cdot e^2}{G J_{th}} \quad (17c)$$

From equations (16c) and (17b), we notice that:  $k_{12_{tors}} = k_{21_{tors}}$  (17d)

#### 4.4. Compliance matrix-terms, including bending and torsion

Based on results presented under 4.2 and 4.3, the compliance matrix-terms, for both bending and torsion, are the following:

$$k_{11} = 1.3 \cdot \frac{l_1^3}{3EJ_{1h}} + \frac{l_1 \cdot e^2}{GJ_{th}} \quad (18a)$$

$$k_{12} = k_{21} = 1.3 \cdot \left[ \frac{l_1^3}{3EJ_{1h}} + \frac{l_1^2 \cdot (d - l_1)}{2EJ_{1h}} \right] + \frac{l_1 \cdot e^2}{GJ_{th}} \quad (18b)$$

$$k_{22} = 1.3 \cdot \left[ \frac{l_1^3}{3EJ_{1h}} + \frac{l_1^2 \cdot (d - l_1)}{EJ_{1h}} + \frac{l_1 \cdot (d - l_1)^2}{EJ_{1h}} + \frac{(d - l_1)^3}{3EJ_{2h}} \right] + \frac{d \cdot e^2}{GJ_{th}} \quad (18c)$$

In equation (18c), the term due to torsion is expressed with  $d$ , as  $l_1 + l_2 = d$ , according to figure 1b.

## Technical Background (TB) document for UR S10 (Rev.5 May 2018)

### Requirement S10.5.1a and S10.5.3.1

#### 1. Scope and objectives

The scope of this revision is the clarification of the formulas utilization in S.10.5.1 a) and b); clarification of applicability of protrusions in the connections of rudder blade structures with solid parts in S.10.5.3.1.

#### 2. Engineering background for technical basis and rationale

S.10.5.1 a) – Clarification in the text has been introduced in order to reflect the exclusive nature of the requirements a) and b) as originally proposed in this UR and the application by IACS Members and Industry.

S.10.5.3.1 – IACS Members have reported rudder causalities in rudder constructions where protrusions have not been applied.

#### 3. Source/derivation of the proposed IACS Resolution

None.

#### 4. Summary of Changes intended for the revised Resolution:

S.10.5.1 a) – “a) In general except in way of rudder recess sections where b) applies.”

S.10.5.3.1 – “Solid parts in forged or cast steel, which house the rudder stock or the pintle, are ~~normally~~ to be provided with protrusions, except where not required as indicated below.”

#### 5. Points of discussions or possible discussions

Regarding the clarifications applied in S.10.5.1, two Members proposed to introduce a material factor coefficient (k) in subparagraph b) for cast steel materials with yield stress below 235 N/mm<sup>2</sup> which has not been supported by the other Members since the nature of subparagraph b) is explained in the TB Appendix 1 Scantling of rudder blades with cut-outs (bending stress criterion) as derived simply from an average stress amplification factor.

#### 6. Attachments, if any

None.



### Requirement S10.5.3.3

#### 1. Scope and objectives

The scope of this revision is to correct a typo in the minimum section modulus formulation. The term between brackets shall be squared.

#### 2. Engineering background for technical basis and rationale

The TB Annex 2 for Rev.4 (Apr 2015) remains valid for this formula.

$$W_s = c_s d_c^3 \left( \frac{H_E - H_x}{H_E} \right)^2 \frac{k}{k_s} 10^{-4} \text{ [cm}^3\text{]}$$

Solid parts, in forged or cast steel, used for the housing of either the rudder stock or of the rudder pintle are connected to the rudder blade by means of horizontal and vertical web plates, as shown in figure 1, here below. The solid part is located either below the lower rudder stock-bearing, or below the lower pintle-bearing.

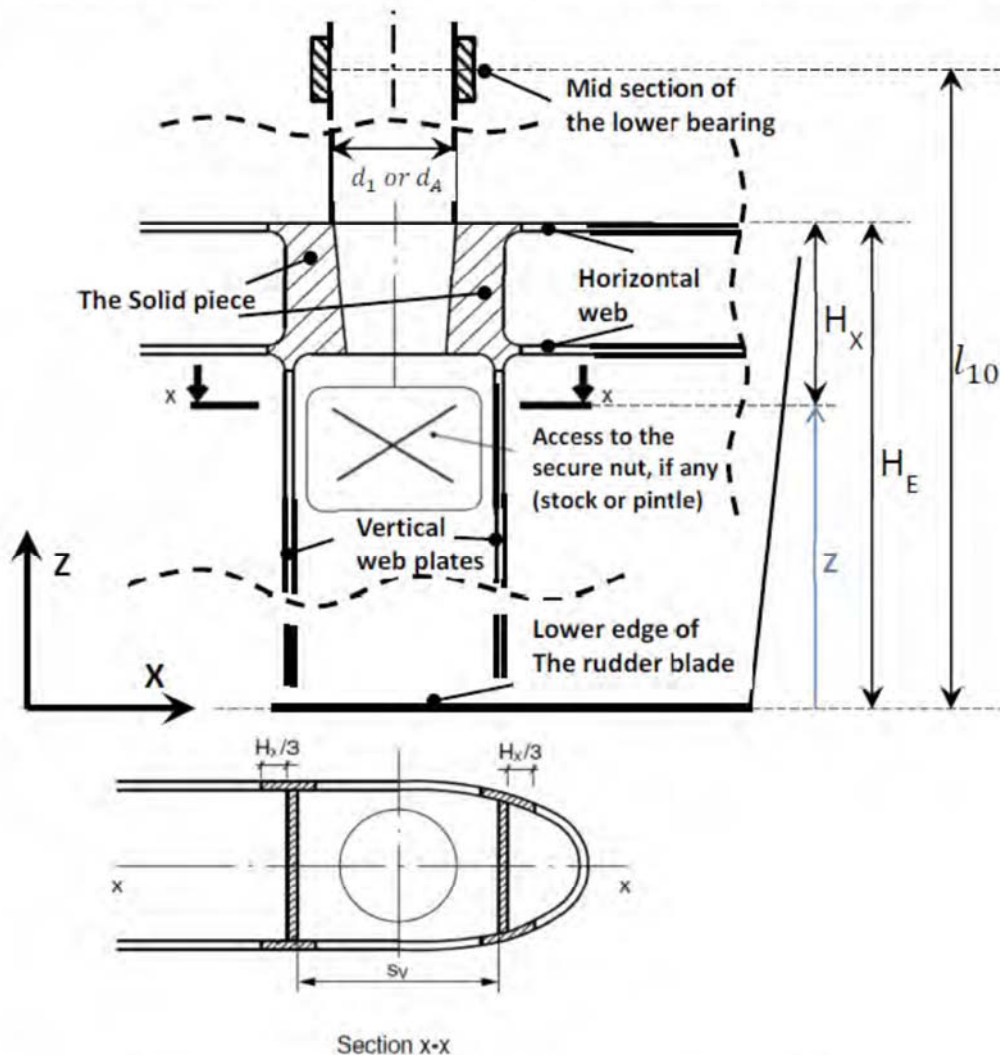


Figure 1 : Section modulus in the area below stock or pintle

The section modulus of the cross-section of the structure of the rudder blade, formed by vertical web plates and rudder body plating, is to be enough stiff to withstand bending moment acting on this area.

The objective is to provide the technical background for the following formula:

$$W_s = c_s d_1^3 \left( \frac{H_E - H_X}{H_E} \right)^2 \frac{k}{k_1} 10^{-4} \quad (1)$$

Bending moment acting below the solid part:

Two rudder systems are considered in the scope of this technical note: spade rudders and semi-spade rudders. Bending moment diagrams from the lower edge of the blade till the lower bearing area of the rudder system can be written, as follows:

- For spade rudders

$$M_z = -p_{R10} \frac{z^2}{2} - \left( \frac{p_{R20} - p_{R10}}{l_{10}} \right) \frac{z^3}{6} \quad (2a)$$

- For semi-spade rudders:

$$M_z = -p_{R10} \frac{z^2}{2} \quad (2b)$$

where:

$z$  is the distance, in m, from the lower edge of the rudder blade till its cross-section submitted to the bending moment  $M_z$

$p_{R10}$  is the force per unit length, in N/m, obtained for  $z$  equal to zero (at rudder-blade bottom edge)

$p_{R20}$  is the force per unit length, in N/m, obtained for  $z$  equal to  $l_{10}$  (location of the lower bearing, mid-section)

Note that in case of spade-rudders,  $p_{R10} = p_{R20} = \text{constant}$ , and the cubic term of equation (2a), becomes zero.

For both formulae (2a) and (2b), the minimum bending moment,  $M_z = 0$  is obtained for  $z = 0$  and the maximum bending moment,  $M_z$  is obtained for  $z = l_{10}$ .

At the lower bearing position, for  $z = l_{10}$ , the section modulus of the structure is mainly given either by:

- Cross-section of the rudder stock, with diameter  $d_1$ , in mm, calculated for a solid circle, as follows:

$$W_s = \frac{I}{\left( \frac{d_1}{2} \right)} = \frac{\pi d_1^3}{32} \approx \frac{d_1^3}{10}, \text{ which is valid for a material with a coefficient} = k_1 \quad (2c)$$

or by

- Cross-section of the rudder pintle, with diameter  $d_A$ , in mm, calculated for a solid circle, as follows:

$$W_p = \frac{I}{\left( \frac{d_A}{2} \right)} = \frac{\pi d_A^3}{32} \approx \frac{d_A^3}{10}, \text{ which is valid for a material with a coefficient} = k_1 \quad (2d)$$

Equations (2c) and (2d) may be written in  $\text{cm}^3$ , as follows:

$$W_s = d_1^3 10^{-4} \text{ cm}^3 \quad (2e)$$

$$W_p = d_A^3 10^{-4} \text{ cm}^3 \quad (2f)$$

The axial bending stress,  $\sigma_z$ , generated by the bending moment,  $M_z$ , is given by:

$$\sigma_z = \frac{M_z}{W_{sect}} \quad (3a)$$

The normalized variable  $u_z = \left(\frac{H_E - H_X}{H_E}\right)$  is defined, from figure 1, here above. By using it inside of equations (2a) and (2b), it can be seen that the bending moment will be decreasing from the value  $M_{H_E}$  till zero, when  $H_X$  varies from zero to  $H_E$ .

Section modulus below the solid part:

At  $z = H_E$  or  $u_z = 1$ , it can be said that, for a section modulus  $W_{mec} = W_s$  or  $W_p$ , the level of stress  $\sigma_{H_E}$ , acting on this section is acceptable, either based on the scantling of the rudder stock or on the scantling of the rudder pintle.

Based on the equation (3a), and assuming that the axial bending stress should be kept at most equal to  $\sigma_{H_E}$  inside of this transition zone, through the solid part thickness and beneath the lower edge of this part, the following can be written:

$$\sigma_{H_E} = \frac{M_{H_E} u_z^2}{W_{mec} u_z^2} = constant \quad (3b)$$

where  $W_{mec} = d_v^3 10^{-4} \text{ cm}^3$ , with  $d_v$  either =  $d_1$  (rudder stock) or  $d_A$  (rudder pintle)

Equation (3b) will make sure that the level of stress acting on a cross section (see figure 1, section at X-X) of the rudder blade is less than or equal to  $\sigma_{H_E}$ . Based on equation (3b), the section modulus at any cross section X-X, below the solid part, should be of a value, at least equal to  $W_{sect}$ , defined as follows:

$$W_{sect} = W_{mec} u_z^2 = d_v^3 10^{-4} \left(\frac{H_E - H_X}{H_E}\right)^2 \quad (3c)$$

Equation (1) can be obtained from equation (3c) by adding:

1. a safety factor,  $c_s$ , to compensate the existence, or not of an opening in the considered cross section<sup>(\*)</sup>
2. the ratio  $\frac{k}{k_1}$ , to make the difference of material properties of the stock (or pintle) with the web plates

From equation (3c), and considering the two above remarks, it can be written:

$$W_{sect} = c_s d_v^3 \left(\frac{H_E - H_X}{H_E}\right)^2 \frac{k}{k_1} 10^{-4} \text{ cm}^3 \quad (3d)$$

<sup>(\*)</sup>Note that, the  $c_s$  coefficient is also considered to make possible the use of the same formula for the calculation of the actual section modulus for any cross section X-X, just in the region below the lower edge of the solid part (for both cases with or without an opening in the rudder plating). The breadth of the rudder plating to be considered for the calculation of this actual section modulus is to be not greater than that obtained, in m, from the following formula:

$$b = s_v + 2 \frac{H_X}{m} \quad (4)$$

where:

$s_v$  = spacing, in m, between the two vertical webs (see figure 1)

$H_X$  = distance defined according to figure 1

$m$  = coefficient to be taken, in general, equal to 3.

In conclusion, it is clear established in the above (3d) formula the square of the term between bracket.

### 3. Source/derivation of the proposed IACS Resolution

None.

#### 4. Summary of Changes intended for the revised Resolution:

The Rev.4 contain this following formula with the missing square coefficient of the bracket term:

$$W_s = c_s d_c^3 \left( \frac{H_E - H_x}{H_E} \right) \frac{k}{k_s} 10^{-4}$$

The missing square symbol shall be introduced in the formulation of the rev.5:

$$W_s = c_s d_c^3 \left( \frac{H_E - H_x}{H_E} \right)^2 \frac{k}{k_s} 10^{-4} \text{ [cm}^3\text{]}$$

#### 5. Points of discussions or possible discussions

None

#### 6. Attachments, if any

None.



## Requirements S10.6.4.2 and S10.6.4.3

### 1. Scope and objectives

The scope of this revision is a modification to UR S10 6.4.2 and 6.4.3. The objective is to improve the requirements for dimension of gudgeon and cone coupling push-up length.

### 2. Engineering background for technical basis and rationale

In UR S10 Rev.4 it was introduced a requirement, copied from CSR BC, saying that the outer diameter of the gudgeon was not to be less than 1.5 times the mean cone diameter.

After applying UR S10 Rev.4 to other vessel types than Bulk Carriers, the feedback from the industry is that it is necessary to increase the breadth of standard rudder designs to comply with the gudgeon diameter requirement, and this will result in increased fuel consumption. It is argued that the experience with gudgeon in current designs is positive. From DNV GL side it is confirmed that there are no registered rudder damages which can justify the gudgeon diameter requirement. To avoid having to modify existing rudder designs, UR S10 is updated in line with previous DNV rules, which had a more relaxed requirement to the gudgeon diameter, but a more accurate and conservative calculation of the loads on the gudgeon.

The additional push-up length limitation has been introduced in the Rev.3. However, there is no technical justification in the appendix 2 "Cone coupling assembly of steel rudder stock with the massive part" of this revision for this minimum push-up length of 2 mm.

### 3. Source/derivation of the proposed IACS Resolution

The proposed modifications are based on DNV Rules for ships, January 2015, Part 3 Chapter 3 Section 2 G200.

The formula for allowable surface pressure  $p_{perm}$  in 6.4.2 is modified to include the contribution to the surface pressure from bending of the rudder stock. As the surface pressure calculation is including more load components, the allowable stress is increased from  $0.8 R_{eH}$  to  $0.95 R_{eH}$ .

For cylinder-cylinder contact where the clearance is negligible, there are two common calculation models to estimate the bearing pressure.

The first model assumes that the parts are rigid bodies. In this model the pressure is a uniform, radial pressure given by the following equation:

$$p = \frac{F}{d_m \ell}$$

where F is the force.

The second model assumes that the parts are elastic bodies. The pressure is now sinusoidal, and may be written as:

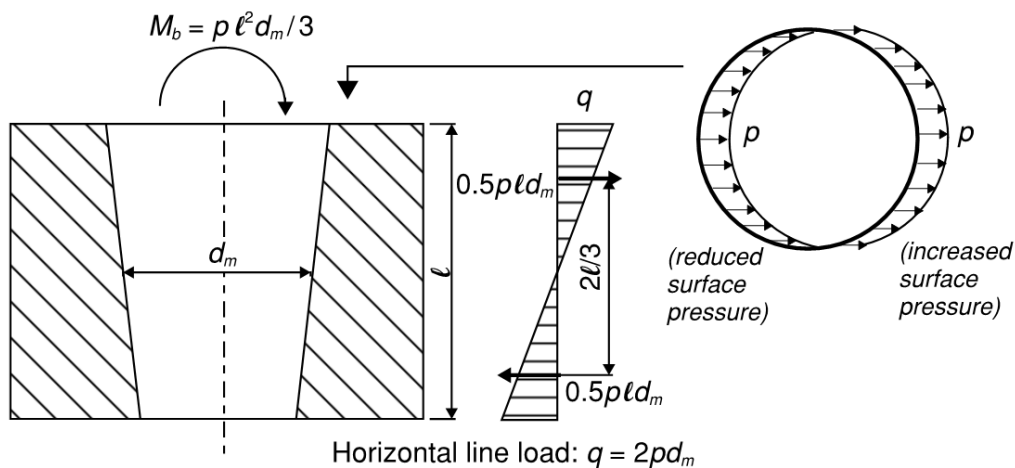
$$p(\theta) = \frac{4}{\pi} \frac{F}{d_m \ell} \cos \theta$$

The maximum pressure is  $4/\pi \approx 1.27$  times bigger than with the rigid body assumption.

The conical coupling of rudder stock with rudder gudgeon is assumed to be neither fully rigid nor fully elastic, but something in between. As shown below, in the rule formula for  $p_b$  the local pressure  $p_b$  correspond to 1.17 times the pressure with rigid body assumption and uniform distribution.

Along the length of the cone, the surface pressure due to a bending moment in the stock has been assumed to have a triangular distribution with maximum pressure at the ends of the bore.

Figure 1 shows the principles of the assumed model of the connection. Please note that only a projection of the radial pressure is shown.



**Figure 1 Bending moment in the stock assuming uniform surface pressure  $p$**

Thus, considering a ratio between uniform to peak pressure of  $p_b = 1.17p$ , the bending moment given by this pressure is approximated to:

$$M_b = \frac{p_b}{1.17} d_m \frac{\ell}{2} \frac{2\ell}{3}$$

Rearranging and correcting for units:

$$p_b = \frac{3.5 M_b}{d_m \ell^2} 10^3$$

In the boss, which may be considered as a hollow cylinder with an internal pressure  $p = p_r + p_b$ , using formulas for thick-walled cylinder the maximum tangential stress

will be:  $\sigma_t = p \frac{1+\alpha^2}{1-\alpha^2}$  and the radial stress will be:  $\sigma_r = -p$ . Thus, the equivalent stress becomes:

$$\sigma_e = \sqrt{\sigma_t^2 + \sigma_r^2 - \sigma_t \sigma_r} = (p_r + p_b) \frac{\sqrt{3+\alpha^4}}{1-\alpha^2}$$

With allowable stress of  $0.95R_{eH}$  the formula for the allowable push-up pressure  $p_{perm}$  becomes:

$$p_{perm} = \frac{0.95R_{eH}(1-\alpha^2)}{\sqrt{3+\alpha^4}} - p_b$$

For a solid shaft in a boss of the same material the effective grip (mutual compression of the mating surfaces) is given by:

$$\delta = \frac{2p_r d_m}{E(1-\alpha^2)}$$

The push-up length is given by:

$$\Delta l = \frac{\delta + 0.8R_{im}}{c}$$

where  $0.8R_{im}$  represents the compression of the surface irregularities.

Rearranging:

$$\delta = \Delta l c - 0.8R_{im}$$

Equating  $\delta$  and rearranging gives the following equation for the maximum permissible push-up length:

$$\Delta l_2 = \frac{p_{perm} d_m}{E \left( \frac{1-\alpha^2}{2} \right) c} + \frac{0.8R_{im}}{c}$$

The minimum push-up length of 2 mm has been introduced in the Rev.3 without technical justification. A rudder manufacturer raised the question. Moreover, in the Rev.3 Appendix 2, paragraph 5.2, the user attention is drawn on the risk related to a push-up value over the maximum acceptable pressure or length: "maximum acceptable values of push-up pressure and push-up length to avoid any damage caused to the massive part (the outer cone)". This is the reason why the sentence "Notwithstanding the above, the push up length is not to be less than 2 mm." is removed.

#### 4. Summary of Changes intended for the revised Resolution:

The prescriptive requirement for outer diameter of the gudgeon is reduced from 1.5 times the mean diameter to 1.25 times the maximum cone diameter which means the minimum diameter will normally be limited by the yield strength criteria. The formula for allowable surface pressure  $p_{perm}$  in 6.4.2 is modified to include the contribution to the surface pressure from bending of the rudder stock. As the surface pressure calculation is including more load components, the allowable stress is increased from  $0.8 R_{eH}$  to  $0.95 R_{eH}$ .

The formula for  $\Delta I_2$  is simplified to use  $p_{perm}$  as input.

#### 5. Points of discussions or possible discussions

None

#### 6. Attachments, if any

Calculation examples

Revision	semispade handymax bulk		spade with trunk 5400 TEU CV		spade with trunk Supply vessel	
	original	modified	original	modified	original	modified
ReH	255	255	340	340	450	450
dm	400	400	735	735	310	310
da	1100	1100	1265	1265	445	445
alpha	0,36	0,36	0,58	0,58	0,70	0,70
$p_{int}^{1)}$	NA	121,0	NA	121,2	NA	122,3
Mb	NA	522	NA	8458	NA	510
l	NA	850	NA	1022	NA	510
$p_b$	NA	6,3	NA	38,6	NA	22,1
$p_{perm}$	101,9	114,7	102,1	82,7	103,0	100,2
E	2,06E+05	2,06E+05	2,06E+05	2,06E+05	2,06E+05	2,06E+05
Rtm	0,01	0,01	0,01	0,01	0,01	0,01
c	0,067	0,066667	0,067	0,066667	0,067	0,066667
Delta_I2	6,96	7,82	16,62	13,48	9,16	8,91

The pressure " $p_{int}$ " is intermediate calculation of surface pressure caused by push-up

$$\frac{0.95R_{eH}(1-\alpha^2)}{\sqrt{3+\alpha^4}}$$



## Requirement S10.7.2.2

### 1. Scope and objectives

The scope of this revision is the clarification of coupling and push-up requirements in S.7.2.2.

### 2. Engineering background for technical basis and rationale

Noting that bearing" means not a coupling part but a sliding part the word bearing may be deleted from "pintle bearing".

### 3. Source/derivation of the proposed IACS Resolution

None.

### 4. Summary of Changes intended for the revised Resolution:

7.2.2 Push-up pressure for pintle ~~bearings~~

The required push-up pressure for pintle ~~bearing~~, in N/mm<sup>2</sup>, is to be determined by the following formula:

$$p_{req} = 0.4 \frac{B_1 d_0}{d_m^2 \ell} \quad [\text{N/mm}^2]$$

where:

$B_1$  = Supporting force in the pintle ~~bearing~~, in [N]

$d_0$  = Pintle diameter, in [mm], see Figure 5

The push-up length is to be calculated similarly as in S10.6.4.3, using required push-up pressure and properties for the pintle ~~bearing~~.

### 5. Points of discussions or possible discussions

None

### 6. Attachments, if any

None.

## Requirement S10.9.3.1

### 1. Scope and objectives

The scope of this revision is the clarification of rudder trunk material chemical composition in S.10.9.3.1.

### 2. Engineering background for technical basis and rationale

S.10.9.3.1 – Clarification on materials chemical composition have been introduced to align this UR with other IACS unified requirements.

### 3. Source/derivation of the proposed IACS Resolution

None.

### 4. Summary of Changes intended for the revised Resolution:

S.10.9.3.1 – “The steel used for the rudder trunk is to be of weldable quality, with a carbon content not exceeding 0.23% on ladle analysis ~~and~~ or a carbon equivalent CEQ not exceeding 0.41%.”

### 5. Points of discussions or possible discussions

None

### 6. Attachments, if any

None.

## Requirement in Annex S10.3 and Annex S10.6

### 1 Scope and objectives

Annex S10.3, spade rudder with trunk and Annex S10.6 for the rudder horn shear stress calculation.

The objective is to bring clarification in some equations and the corresponding figure A2 for better understanding for Annex S10.3 and to correct magnitude of the torsional stress in Annex S10.6.

### 2 Engineering background for technical basis and rationale

#### 2.1 Annex S10.3, spade rudder with trunk

2.1.1 Clarification is brought by detailing the subscript of bending moments acting in the upper ( $A_1$ ) and lower ( $A_2$ ) parts of the rudder blade,  $M_{CR1}$  and  $M_{CR2}$  respectively.

2.1.2 It is clarified that the total force acting on the blade,  $C_R$ , is the sum of the forces acting on the upper and lower parts,  $C_{R1}$  and  $C_{R2}$ .

2.1.3 The bending moment and shear force acting on the rudder blade at the level of the lower bearing are defined respectively as:

- For the upper part ( $A_1$ )  
 $M_{CR1} = C_{R1} (CG_{1Z} - l_{10})$   
 $C_{R1}$  = Rudder force over the rudder blade area  $A_1$ .
- For the lower part ( $A_2$ )  
 $M_{CR2} = C_{R2} (l_{10} - CG_{2Z})$   
 $C_{R2}$  = Rudder force over the rudder blade area  $A_2$

2.1.4 The bending moment acting on the rudderstock at the level of the lower bearing is  $M_{CR2} - M_{CR1}$  and the correspondent shear force in the rudder stock is defined as  
 $B_3 = (M_{CR2} - M_{CR1}) / (l_{20} + l_{30})$

2.1.5 The definitions of  $CG_{1Z}$  and  $CG_{2Z}$  have been clarified by adding from which point the distance is measured.

2.1.6 The Figure A2 shows for simplicity the equivalent pressure, a distributed load acting on the upper part of the rudder blade, i.e. on the  $l_{20}$  part is represented as a concentrated load and moment acting on the rudder blade at the level of the lower bearing, although they are considered in the equations for the correct forces balance on the complete system.

#### 2.2 Annex S10.6, rudder horn shear stress calculation

In the formulae of the torsional stress a coefficient of  $10^3$  was introduced instead of  $10^{-3}$ . This editorial correction was made to correct the magnitude of the stress.

### **3 Source/derivation of the proposed IACS Resolution**

None.

### **4 Summary of Changes intended for the revised Resolution:**

- In Annex S10.3:

The formulae of  $M_{CR1}$ ,  $M_{CR2}$  and  $B_3$  have been modified.

The definitions of  $CG_{1Z}$  and  $CG_{2Z}$  have been modified

The Figure A2 has been modified to correspond to the equations.

- In annex S10.6:

The 2 torsion stress formulae were corrected with coefficient  $10^{-3}$ .

### **5 Points of discussions or possible discussions**

These changes were agreed by the Hull Panel in 2017 and the figure by GPG in July 2017.

### **6 Attachments if any**

None

## Technical Background for UR S10 Rev.6 Sep 2019

### Requirements S10.1.4.2

#### 1. Scope and objectives

The scope of this revision is to clarify the application of the required radii in way of the solid part in cast steel.

#### 2. Engineering background for technical basis and rationale

The required radii of 100mm is not applicable to solid parts in cast steel and smaller radii may be accepted. As shown in Recommendation No.76 IACS Guidelines for Surveys, Assessment and Repair of Hull Structure – Bulk Carriers, Example Nos. 4, 5 & 6 of structural detail failures and repairs - Area 3, fractures occurred in way of small radii in plating or welding seam. Where steel cast pieces having three-dimensional smooth profile are extended beyond the end of radii, fractures in way of radii have not been reported.

#### 3. Source/derivation of the proposed IACS Resolution

None.

#### 4. Summary of Changes intended for the revised Resolution:

The underlined phrase is added:

[quote]

1.4.2 In way of the rudder horn recess of semi-spade rudders, the radii in the rudder plating except in way of solid part in cast steel are not to be less than 5 times the plate thickness, but in no case less than 100 mm. Welding in side plate is to be avoided in or at the end of the radii. Edges of side plate and weld adjacent to radii are to be ground smooth.

[unquote]

#### 5. Points of discussions or possible discussions

The last sentence in item 2 above should be confirmed by Hull Panel Members, i.e.:

[quote]

Where steel cast pieces having three-dimensional smooth profile are extended beyond the end of radii, fractures in way of radii have not been reported.

[unquote]

#### 6. Attachments, if any

None.

### Requirements S10.2.1.1

#### 1. Scope and objectives

The scope of this revision is to address the vague text "to be specially considered; if not known:" in Table 1.

#### 2. Engineering background for technical basis and rationale

Text "to be specially considered; if not known:" for high lift rudders in Table 1 is

vague and lacks details.

For rudder torque:  $Q_R = C_R \cdot r = C_R \cdot c(\alpha - k_f)$ , where  $C_R = K_1 \cdot K_2 \cdot K_3 \cdot 132 \cdot A \cdot V^2$ ,  $\alpha = 0.33$  for ahead condition while  $\alpha = 0.66$  for astern condition. It is noted that the flap rudder balance coefficient  $k_f$  is normally around 0.33~0.46, then  $(\alpha - k_f)$  ratio for astern/ahead will be less than 4. Considering  $C_R$  at the astern is quarter of the ahead  $C_R$  since the astern speed is half of ahead speed normally, the rudder torque at ahead is larger than astern which is same as rudder force. Hence, there is no need to give special consideration for at astern conditions.

### 3. Source/derivation of the proposed IACS Resolution

None.

### 4. Summary of Changes intended for the revised Resolution:

Remove the vague text "to be specially considered; if not known:" in Table 1 of UR S10.2.1.1.

### 5. Points of discussions or possible discussions

None

### 6. Attachments, if any

None.

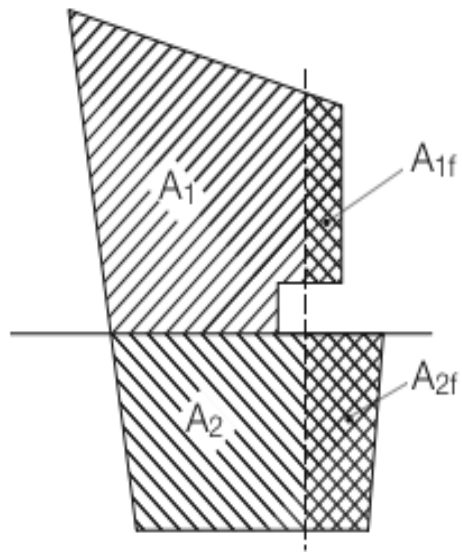
## Requirements S10.2.2

### 1. Scope and objectives

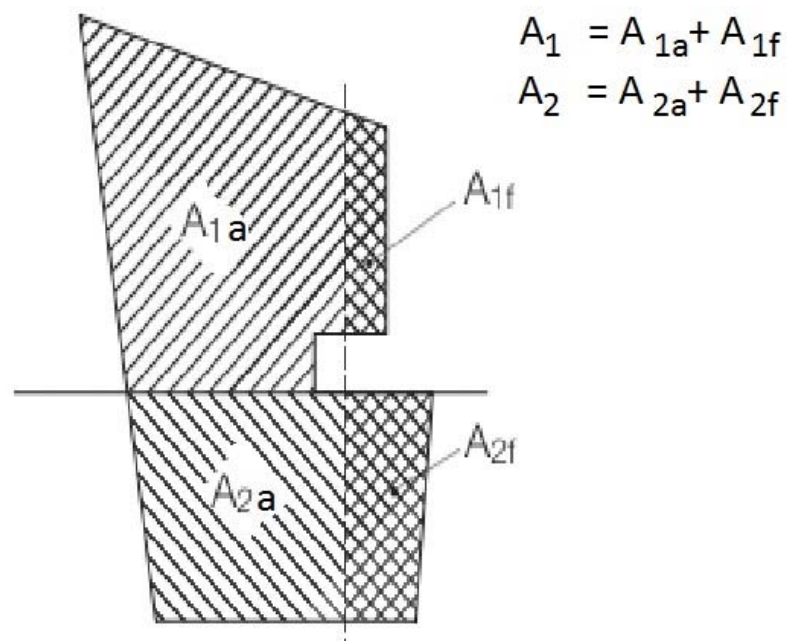
The scope of this revision is to make the definition of Rudder areas "A<sub>1</sub> and A<sub>2</sub>" clearer, which are used for calculating the rudder forces and torques of semi-spade rudders.

### 2. Engineering background for technical basis and rationale

The rudder area A is defined as the sum of two rectangular or trapezoidal parts A<sub>1</sub> and A<sub>2</sub> for a semi-spade rudder. The original figure given in Rev. 5 (2018) of this UR is as given below:



It is not clear from the above figure, whether  $A_{1f}$  and  $A_{2f}$  are part of  $A_1$  and  $A_2$ . Hence it is suggested to include the following figure and the definitions in the UR for more clarity.



$A_{1f}$  = portion of  $A_1$  situated ahead of the centre line of the rudder stock

$A_{1a}$  = portion of  $A_1$  situated aft of the centre line of the rudder stock

$A_{2f}$  = portion of  $A_2$  situated ahead of the centre line of the rudder stock

$A_{2a}$  = portion of  $A_2$  situated aft of the centre line of the rudder stock

### 3. Source/derivation of the proposed IACS Resolution

None

### 4. Summary of Changes intended for the revised Resolution:

The figure 2 in UR S10 is edited for more clarity

### 5. Points of discussions or possible discussions

None

### 6. Attachments, if any

None

## Requirements S10.5.3 Fig.3

### 1. Scope and objectives

The scope of this revision is to indicate the radius in the critical corners of cover



plates or openings in rudder plates as shown in figure 3.

## 2. Engineering background for technical basis and rationale

Cover plate - One side welding against permanent steel backing

Welding against permanent steel backing:

- 1) Often root defects are not possible/difficult to detect;
- 2) Sometimes serious weld defects are found during operation;
- 3) Fatigue cracking from cover plate welding may propagate over the width of the blade causing serious damage
- 4) Removing and re-welding the cover plates in service will increase the crack probability
- 5) Poor fatigue strength, i.e. low SN-curve

Bolted cover and radius corners are considered better solutions for cover plates  
In any case all cover plates and openings need to have radiused corners.

## 3. Source/derivation of the proposed IACS Resolution

None.

## 4. Summary of Changes intended for the revised Resolution:

The current figure 3 provided in UR S10 Rev 5 has been replaced by the following updated figure 3.

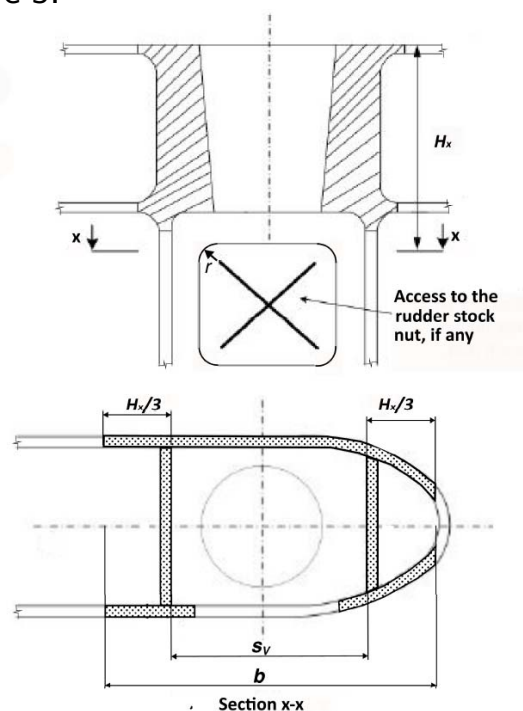


Figure 3 Cross-section of the connection between rudder blade structure and rudder stock housing, example with opening in only one side shown

## 5. Points of discussions or possible discussions

None.

## 6. Attachments, if any

None.

## Requirements S10.6.4.2 and S10.7.2.2

### 1. Scope and objectives

The scope of this revision is to make the definition " $l$ " used for calculating the push-up pressure of cone coupling more appropriate.

In addition to clarify the definition of outer diameter of Gudgeon ( $d_a$ ) used in the permissible push up pressure clearer.

### 2. Engineering background for technical basis and rationale

The length " $l$ " is defined in S10.6.4.2 as a cone length and this parameter is used to calculate a taper " $c$ " in S10.6.3.1 and push-up pressure in S10.6.4.2 and S10.7.2.2.

To use a cone length for calculation of a taper " $c$ " is considered appropriate.

On the other hand, in the equation of the push-up pressure, area of contact surface between a cone and gudgeon is taken into consideration. Therefore, it is considered that the contact length of a cone and gudgeon should be used instead of the cone length when calculating the push-up pressure (See below figure). As a cone length is generally greater than a contact length, the result of push-up pressure calculation with cone length may be dangerous side by overestimating the area of contact surface.

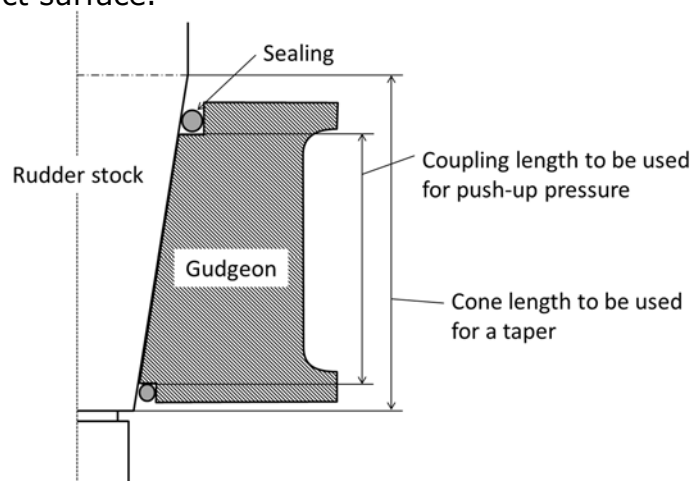
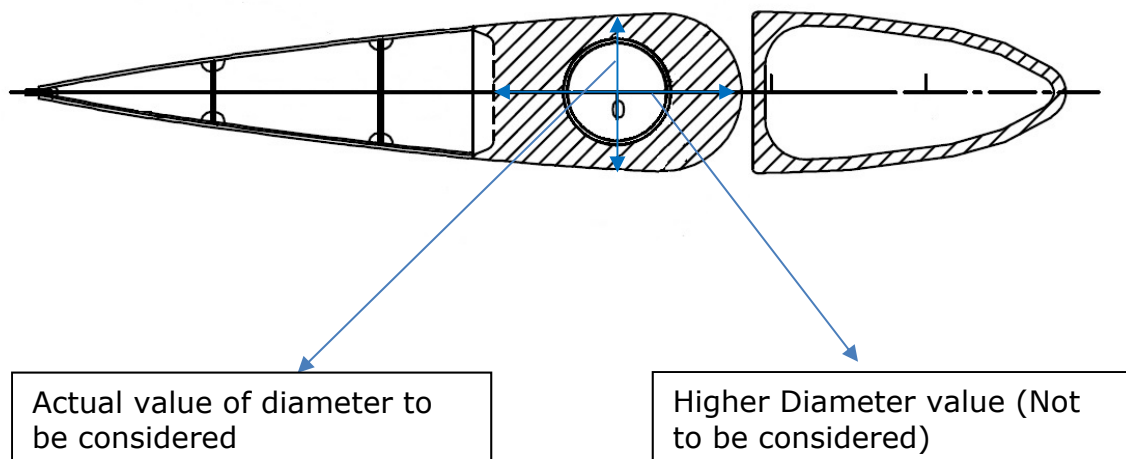
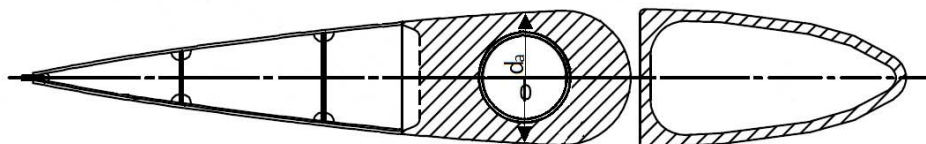


Figure 5 of UR S10 Rev 5 shows  $d_a$  as the outer diameter of Gudgeon. However, it is not clear whether it is to be measured along the breadth of the rudder or along the transverse direction. A typical configuration like below, may mislead the designer/class societies to take the largest diameter/distance:



Considering a higher diameter would result in a higher permissible surface pressure value, where the actual highest permissible pressure is as calculated for the least diameter in the transverse direction. It is recommended to take this value at the same plane in which the value of  $d_m$  is measured.

The following editorial corrections are proposed:



**Figure 5a – Gudgeon outer diameter( $d_a$ ) measurement**

$d_a$  = outer diameter of the gudgeon, in [mm], see Figure 5 and Figure 5a.  
(The least diameter is to be considered).

### 3. Source/derivation of the proposed IACS Resolution

None

### 4. Summary of Changes intended for the revised Resolution:

A new coefficient " $l_c$ " is introduced as a cone length and just used to calculate a taper " $c$ ". A coupling length " $l$ " used as a contact length mentioned above to calculate a push-up pressure is clearly determined by Figure 5b.

A new figure (Figure 5a) is proposed for more clarity on the definition of the outer diameter of the gudgeon.

**5. Points of discussions or possible discussions**

None

**6. Attachments, if any**

None

**Requirements S10.8.2 Table 3****1. Scope and objectives**

The scope of this revision is the clarification of use of synthetic materials with hardness greater than 70 Shore D.

**2. Engineering background for technical basis and rationale**

The description "with hardness between 60 and 70 Shore D" seems to limit the hardness of the synthetic materials but no member found the background of the description which has been incorporated since Rev.1 (1990). Synthetic bearing materials are required to be approved type, so it is considered that safety of the materials can be ensured even with hardness exceeding 70 Shore D.

**3. Source/derivation of the proposed IACS Resolution**

None.

**4. Summary of Changes intended for the revised Resolution:**

The actual modified text is indicated as follows:

**Table 3 ~~Maximum~~ Allowable surface pressure  $q_a$**

Bearing material	$q_a$ [N/mm <sup>2</sup> ]
lignum vitae	2.5
white metal, oil lubricated	4.5
synthetic material with hardness <del>between 60 and 70</del> greater than 60 Shore D <sup>1)</sup>	5.5 <sup>2)</sup>
steel <sup>3)</sup> and bronze and hot-pressed bronze-graphite materials	7.0

**5. Points of discussions or possible discussions**

An IACS member pointed out that the interpretation of the specification "synthetic material with hardness between 60 and 70 Shore D" in Table 3 is not clear, whether synthetic materials with hardness greater than 70 Shore D may be accepted or not.

Some members advised that synthetic materials with high hardness will be prone to cracking but this is not considered as a problem anymore for fibre reinforced synthetic materials since the mid 90'ies.

Considering the member's opinion and implementation, Hull Panel concluded that synthetic materials with hardness greater than 70 Shore D may be accepted.

**6. Attachments, if any**

None.

**Requirements S10.9.1 Fig. 7****1. Scope and objectives**

The scope of this revision is to correct a misprint in figure 7.

**2. Engineering background for technical basis and rationale**

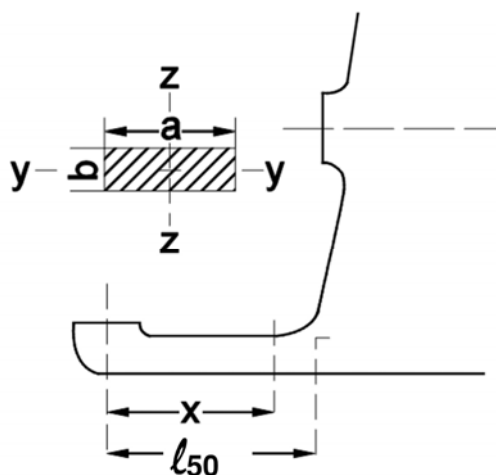
IACS Member identified a misprint in the figure 7 where  $l_{50}$  was represented as  $l_{50}$  in UR S10 Rev. 5. The typo has been corrected in this new revision.

**3. Source/derivation of the proposed IACS Resolution**

None.

**4. Summary of Changes intended for the revised Resolution:**

The current figure 7 provided in UR S10 Rev 5 has been replaced by the following new figure 7.

**5. Points of discussions or possible discussions**

None.

**6. Attachments, if any**

None.

**Requirement S10.9.3.1****1. Scope and objectives**

The scope of this revision is to make the application of rudder trunk requirements more appropriate.

**2. Engineering background for technical basis and rationale**

The rudder trunk requirements in 9.3.1 of UR S10 are based on 3.4.3 and 3.4.4, Ch.10 Sec.1 of CSR-BC. These CSR-BC requirements are applied only to a rudder trunk supporting rudder stock such as specified in Fig.7, Ch.10 Sec.1 of CSR-BC, which construction is same as Figure A2, Annex S10.3 of UR S10.

When the requirements were incorporated into UR S10 (Rev.4), the scope of application of the requirements were extended without technical justification to other rudder trunk configurations as specified in 9.3.1 of UR S10 that "This requirement applies to both trunk configurations (extending or not below stern frame)." (See below Figure 1 and Figure 2)

However, since the rudder trunk not extending below stern frame is not subject to considerable bending moment, the requirements in 9.3.1 of UR S10 are too strict for such rudder trunk configuration.

Taking into account above consideration, Hull Panel concluded that 9.3.1 of UR S10 should apply only to a rudder trunk configuration extending below stern frame.

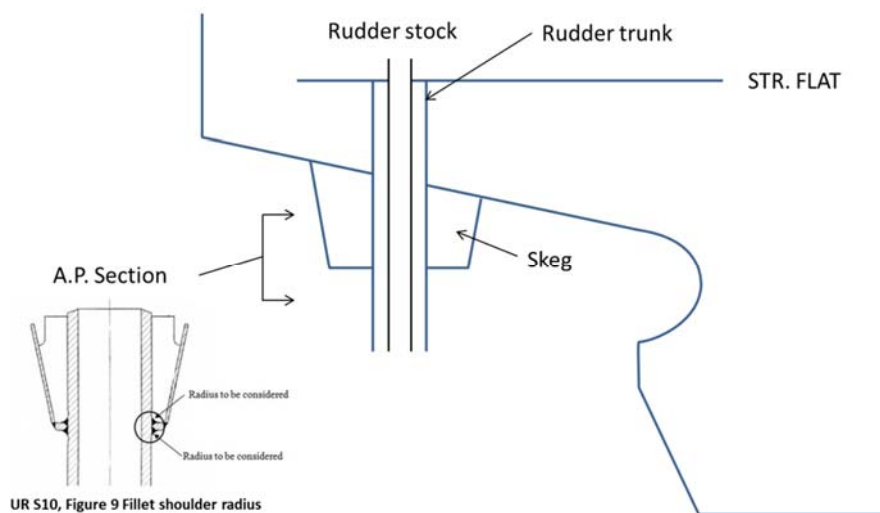


Figure 1: Rudder trunk extending below stern frame

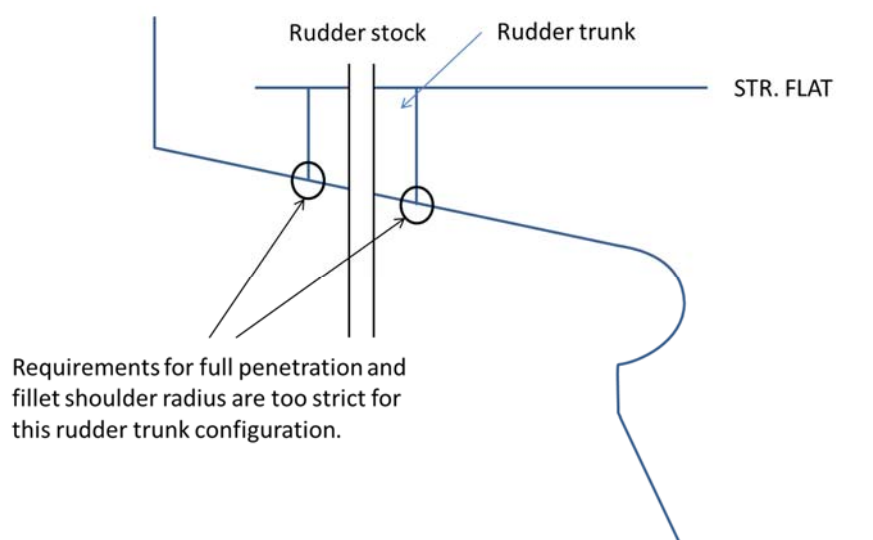


Figure 2: Rudder trunk not extending below stern frame

The radius for trunks with stresses above 40 N/mm<sup>2</sup> should be the same

or higher than the radius for trunks with stress level below 40 N/mm<sup>2</sup>. An error is corrected so that this is intention is obtained also for rudder stock diameter above 600mm.

**3. Source/derivation of the proposed IACS Resolution**

None

**4. Summary of Changes intended for the revised Resolution:**

The scope of application of 9.3.1 is modified to apply only to a rudder trunk configuration extending below stern frame as same as 9.3.2.

**5. Points of discussions or possible discussions**

None

**6. Attachments, if any**

None

## Technical Background document for UR S10 Rev.7 (Feb 2023)

### Requirements S10.1.2.3

#### 1. Scope and objectives

Improvement of clarity of requirement S10.1.2.3 related to sealing arrangement.

#### 2. Engineering background for technical basis and rationale

A manufacturer asked that if two separate seals can be considered as equivalent devices to two separate stuffing boxes. It is the manufacturer's opinion that considering the performance of the sealing device in recent years, two seal devices serve a function to have a sufficient redundancy.

In addition, in the first sentence of 1.2.3 a seal is accepted as equivalent to a stuffing box, while in the second sentence of 1.2.3 explicitly two separate stuffing boxes are required.

This question was discussed in Hull Panel and agreed. Furthermore, the meaning of "deepest waterline" was discussed, as during the design stage of the rudder a "deepest waterline" with respect to possible loading conditions might not be available. To clarify this issue, it was agreed to define the waterline at scantling draught as basis for rudder design and sealing arrangement.

#### 3. Source / derivation of the proposed IACS Resolution

None

#### 4. Summary of Changes intended for the revised Resolution

Modification of UR S10.1.2.3 as below:

1.2.3 In rudder trunks which are open to the sea, a seal or stuffing box is to be fitted above the deepest load waterline, to prevent water from entering the steering gear compartment and the lubricant from being washed away from the rudder carrier. If the top of the rudder trunk is below the ~~deepest-waterline~~ at scantling draught (without trim), two separate watertight seals / stuffing boxes are to be provided.

Accordingly, the summer loadline draught  $T_d$  to be considered for the scantlings of the rudder plating in UR S10.5.2 was replaced by the scantling draught  $T_{SC}$ .

#### 5. Points of discussions or possible discussions

None

#### 6. Attachments, if any

None



### Requirements S10.1.4.3

#### 1. Scope and objectives

Improvement of clarity of requirement S10.1.4.3 related to welding of rudder plating.

#### 2. Engineering background for technical basis and rationale

Cracking in way of one-sided welding against steel backing bars have in some cases occurred in areas experiencing significant stresses from rudder bending, e.g. at connection weld between rudder side plating and closing plate as well as between heavy pieces and rudder plating. Hence it is proposed to make this requirement generally applicable for rudder side plating subjected to rudder bending, not only the connection between heavy pieces and plating.

Fitting steel backing strip by continuous weld at the bevelled edge instead of a separate fillet weld at the edge of the steel backing strip have two benefits:

- a) By avoiding tack welding and/or separate weld on the edge of the steel backing bar, the fatigue performance will be improved, typically from a G-curve to a F-curve, ref. T.R. Gurney: Fatigue Design Rules for Welded Steel Joints. The Welding Institute Research Bulletin no. 177 (1976).
- b) The initial weld between the steel backing bar and the plating will be a part of the full penetration weld.

#### 3. Source / derivation of the proposed IACS Resolution

None

#### 4. Summary of Changes intended for the revised Resolution

Modification of UR S10.1.4.3 as below, in addition new Figure 1 added and the following figures are re-numbered.

1.4.3 Welds in the rudder side plating subjected to significant stresses from rudder bending and welds between plates and heavy pieces (solid parts in forged or cast steel or very thick plating) are to be made as full penetration welds. In way of highly stressed areas e.g. cut-out of semi-spade rudder and upper part of spade rudder, cast or welding on ribs is to be arranged. Two sided full penetration welding is normally to be arranged. Where back welding is impossible welding is to be performed against ceramic backing bars or equivalent. Steel backing bars may be used and are to be fitted with continuously welded on one side to the heavy piece bevelled edge, see Figure 1. The bevel angle is to be at least 15° for one sided welding.

#### 5. Points of discussions or possible discussions

None

#### 6. Attachments, if any

None

## Requirements S10.2.1.1

### 1. Scope and objectives

Clarify and align definition of astern speed.

### 2. Engineering background for technical basis and rationale

Machinery Panel amended UR M25 and found disparities between the requirement in UR M25 and the design astern speed as stated in UR S10. HP reviewed the definition of the design astern speed in revised UR M25 and found that this definition is equivalent to the definition given in SOLAS II-1/3.15 which reads as follows:

“15 Maximum astern speed is the speed which it is estimated the ship can attain at the designed maximum astern power at the deepest sea-going draught.”

HP decided to make reference to SOLAS but keep the current requirement as a minimum for rudder and steering gear design.

### 3. Source / derivation of the proposed IACS Resolution

N/A

### 4. Summary of Changes intended for the revised Resolution

Modification of definition of astern speed in UR S10.2.1.1 as below:

For the astern condition the maximum astern speed as defined in SOLAS Regulation II-1/3.15 is to be used, however, in no case taken less than:

$$V_{astern} = 0.5 V$$

### 5. Points of discussions or possible discussions

None

### 6. Attachments, if any

None

## Requirements S10.4.2, S10.6.4.2 and Annex S10.2 and S10.3

### 1. Scope and objectives

Clarify of determination of bending moments and bearing forces was found necessary in the Annex S10.2 and S10.3. In addition, it was found necessary to consider a second case for loading of spade rudders with trunk extending inside the rudder. The additional case is covering partly submerged rudders, which may yield to increased bending moment.

### 2. Engineering background for technical basis and rationale

Spade rudder with trunk extending inside the rudder may have, due to the special arrangement of the bearings, higher bending moment and higher moment at the cone coupling in partly submerged condition compared to the fully submerged condition. Therefore, it is decided to consider the partly submerged condition for the scantlings of rudder stock and the cone coupling.

Comparisons were calculated for four examples as summarised in the below table, indicating that in some cases impact on scantlings might occur.

item		Ship A	Ship B	Ship C	Ship D
A (fully submerged) [m <sup>2</sup> ]		69.1	40.3	38.8	50.2
A <sub>2</sub> (below middle of neck bearing) [%]		71 %	58 %	72 %	72 %
Moment at neck	Percentage of fully submerged condition	118 %	125 %	118 %	118 %
Torque	Percentage of fully submerged condition	71 %	58 %	72 %	72 %
Rudder stock diameter for torque [mm]		No change	No change	No change	No change
Rudder stock scantling combined loads (neck) [mm]		99.4%	100.3%	102%	100.7%
Minimum section modulus of rudder blade		72%	71%	50%	78%
Horizontal web (thickness) [mm]		74%	64%	74%	94%
Connection length of cone coupling (with key) [mm]	Due to increase of rudder stock diameter (neck)	97%	98%	102%	100.6%
Gudgeon diameter [mm]		73%	78%	91%	87%
Required push up length $\Delta\ell_1$ [mm]		91%	98%	90%	102.5%
Permissible push up length $\Delta\ell_2$ [mm]		104%	117%	87%	87%

### 3. Source / derivation of the proposed IACS Resolution

None

#### **4. Summary of Changes intended for the revised Resolution**

UR S10.4.2 the following sentence is added:

For a spade rudder with trunk extending inside the rudder, the rudder stock scantlings shall be checked against the two cases defined in Annex S10.3.

UR S10.6.4 the requirement for the determination of the push-up pressure, the following sentence is added:

For spade rudder with trunk extending inside the rudder, the coupling shall be checked against the two cases defined in Annex S10.3

In AnnexS10.3 Figure A2 is modified and renumbered as Fgure A2 a) and a figure A2 b) is added, showing moment and force distribution for a partly submerged spade rudder. The description for determination of Moments and forces is modified as below:

For a spade rudder with trunk extending inside the rudder, the strength shall be checked against the following two cases:

- a) pressure applied on the entire rudder area
- b) pressure applied only on rudder area below the middle of neck bearing.

~~For spade rudders with rudder trunks t~~The moments, in Nm, and forces, in N, for the two cases defined above may be determined according to Figure A2 a) and b), respectively.

#### **5. Points of discussions or possible discussions**

None

#### **6. Attachments, if any**

None

## Requirements S10.7.2.2

### 1. Scope and objectives

IACS Members have been contacted by industry partners in view of the requirements related to the push-up lengths in case of cone couplings mainly for pintles. The changes are made to clarify the requirements of the push-up pressure for pintles and to align with rudder stock requirements

### 2. Engineering background for technical basis and rationale

In Rev.6 in case of the pintle cone coupling the required push up pressure is to be calculated following UR S10.7.2.2 This formulation considers the required push up pressure related to the torsion that needs to be taken by the cone coupling.

In contrast to that, in case of the rudder stock, two formulations for the required pressure are given in UR S10.6.4.2. considering the torsion as well as the bending moment in the cone coupling. In addition to that a permissible push up pressure for the rudder stock is to be calculated by UR S10.6.4.2. to avoid damage to the gudgeon. However, a permissible pressure is not required to be calculated for the pintle connection. In UR S10.6.4.3 a minimum and maximum push-up length shall be calculated for the rudder stock connection based on the required and permissible push-up pressure respectively. Following the reference in UR S10 7.2.2 this would not be possible for the pintle connection as only a required push-up pressure is calculated.

In the TB information to Rev. 5 and Rev.6 there is no difference given between the design and calculation of cone coupling for rudder stock and pintle, however, the requirements in UR S10 for cone coupling of rudder stock and pintle differ.

The current  $p_{req}$  under UR S10 7.2.2 Rev.6 is obviously based on a torsion moment that will appear in case the pintle bearing will fail and steel-to-steel friction will occur with a friction factor similar to what is assumed for steel-to-steel surfaces e.g. in hatch cover supports (friction factor about 0.35 to 0.38).

A formulation calculating a  $p_{req}$  for the cone coupling under bending effect, similar to what is required for the rudder stock was established. For that purpose the bending moment  $M_{bp}$  to be considered needs to be defined. The proposal is to determine the bending moment by multiplying the pintle force  $B$  by the distance between the middle of the bearing and the top of the pintle cone  $l_a$ .

The required push-up-pressure for calculation of the required push-up-length was defined by using the maximum of the calculated required push-up-pressures related to the torque and the bending at the cone connection.

Furthermore it was proposed to require a permissible push-up-pressure based on the dimensions and material of the gudgeon for the pintle and based on the bending moment as defined above (similar as for the rudder stock in UR S10 6.4.2)

The permissible push-up-length for the pintle-cone-coupling considering the above was then defined similar to  $\Delta l_2$  in URS 10 6.4.3 for the rudder stock.

To check the expected impact, existing pintle designs were recalculated using the above procedure and the results were compared with target values for the push-up length provided by the manufacturer.

For 24 designs target values could be provided and the re-calculations showed the results given in the table below. Required push-up lengths following the procedure in Rev.6 and the new proposal, considering the bending moment are given and compared with the target value. If the required push-up length following the new proposal found still below the target value, the check is marked "ok", otherwise "not ok". The last column contains the permissible push-up length acc. to the new proposal.

No	Pintle diameter [mm]	Bearing force [kN]	Bending moment [kNm]	$\Delta e_1$ Rev.6 [mm]	$\Delta e_1$ Rev.7 [mm]	Target value [mm]	check	$\Delta e_2$ Rev.7 [mm]
1	640	4261	1726	0.642	4.49	5.00	ok	10.55
2	700	4914	2199	1.061	7.25	3.00	Not ok	12.67
3	680	3725	1620	0.439	2.28	5.00	ok	11.03
4	820	6532	3429	0.589	3.36	5.00	ok	14.27
5	470	2080	728	0.407	2.82	4.00	ok	7.50
6	650	3453	1623	0.401	2.29	2.50	ok	11.46
7	800	4932	2577	0.614	4.71	2.00	Not ok	11.40
8	720	3992	2126	0.447	2.86	1.50	Not ok	11.38
9	630	3024	1285	0.565	4.41	5.60	ok	11.59
10	250	445	100	0.195	0.75	2.00	ok	4.14
11	550	1706	341	0.303	0.76	1.50	ok	10.45
12	520	2343	826	0.393	2.50	5.00	ok	9.20
13	420	1566	533	0.411	3.60	5.00	ok	6.45
14	490	2312	798	0.479	3.74	5.00	ok	8.84
15	280	755	174	0.303	2.37	2.50	Not ok	3.48
16	610	3558	1441	0.351	1.69	0.50	Not ok	8.99
17	530	2396	882	0.300	1.77	2.06	ok	5.31
18	610	3179	1208	0.549	4.11	3.00	Not ok	10.60
19	490	2050	656	0.423	2.99	5.00	ok	8.77
20	530	2646	926	0.397	2.79	0.50	Not ok	4.96
21	740	4174	2024	0.444	3.28	0.78	Not ok	8.57
22	620	3154	1230	0.429	3.13	0.68	Not ok	6.61
23	870	7188	3882	0.755	5.48	5.00	Not ok	12.24
24	540	2698	1066	0.484	3.98	4.50	ok	9.25

Based on the results the following conclusions were drawn.

- a) The permissible push-up lengths in the last column are always well above the target values. It was therefore decided to not require assessment of the permissible push-up length in UR S10.
- b) In general, the calculated required push-up length using the new proposal (considering the bending) are more inline with the target values. However, in case of dry fitting (target push-up values below 1mm as indicated by light blue background in the table) the calculated required push-up values

are too high. It was decided to keep in case of dry fitting the required push-up length as defined in Rev.6.

- c) In four cases (No. 2, 7, 8 and 18) the calculated required push-up lengths were significantly larger than the target values. In some of these cases unusual design (taper) was applied, some other reasons might be dry fitting with unusual design parameters or mistakes in the collected input data.

Finally, HP agreed on the changes as summarised in section 4 below.

### 3. Source / derivation of the proposed IACS Resolution

None

### 4. Summary of Changes intended for the revised Resolution

Modification of the requirements in UR S10.7.2.2 as below:

Quote:

The required push-up pressure for pintle in case of dry fitting, in N/mm<sup>2</sup>, is to be determined by  $p_{req1}$  as given below.

The required push-up pressure for pintle in case of oil injection fitting, in N/mm<sup>2</sup>, is to be determined by the maximum pressure of  $p_{req1}$  and  $p_{req2}$  as given below following formula:

$$p_{req1} = 0.4 \frac{B d_0}{d_m^2 \ell} [\text{N/mm}^2]$$

$$p_{req2} = \frac{6 M_{bp}}{\ell^2 d_m} 10^3 [\text{N/mm}^2]$$

where:

$B$  = Supporting force in the pintle, in N, e.g.  $B_1$  as defined in figure A4 for semi-spade rudder.

$d_0$  = Pintle diameter, in mm, see Figure 9.

$M_{bp}$  = bending moment in the pintle cone coupling to be determined by:

$$M_{bp} = B \ell_a [\text{Nm}]$$

$\ell_a$  = length between middle of pintle-bearing and top of contact surface between cone coupling and pintle in m, see Figure 9)

The required push-up length,  $\Delta \ell_{i,r}$ , is to be calculated similarly as in S10.6.4.3, using the required push-up pressure as defined above, and properties for the pintle.

Unquote:

In addition, Figure 9 was newly introduced to indicate the length  $l_a$ . The following figures in UR S10 have been re-numbered.

## **5. Points of discussions or possible discussions**

None

## **6. Attachments, if any**

None

### **Requirements S10.8.1.1**

#### **1. Scope and objectives**

Clarify the requirement to fit liners in way of bearings.

#### **2. Engineering background for technical basis and rationale**

A member was approached by industry regarding the requirement UR S10.8.1.1 in which liners and bushes need to be fitted in way of bearings. Shipyards and ship repairers have indicated that replacement of worn-out liners is difficult especially in small diameter rudder stocks, i.e. the fitting of liners on rudder stocks with diameter below 200mm is found to have limited value, if any. It is generally understood that the purpose of a liner is to facilitate replacement of the same (when worn out), instead of replacing the whole stock or repair if no liner is fitted.

I) There are several options available for repairing a worn-out rudder stock without liner, depending on the extent of damage and the resources available. Some of the common methods are:

a) Repairing by welding built up and then machining. This is done if the damage is not so severe, and the facilities are adequate and available.

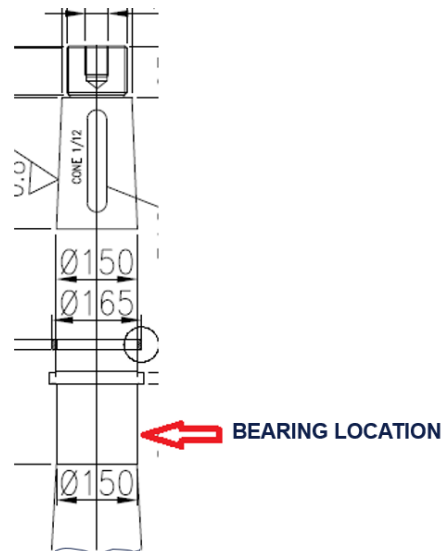
b) Repairing by machining the rudder stock and providing the bush with a lower inner diameter to suit the machined stock. This is possible only if the provided diameter of the rudder stock in way of the bush is in excess to that required by Rules.

c) Replacing the rudder stock – This is done if the damage of the stock is beyond repair.

II) Shipyards and ship repairers find the above methods more convenient for smaller size rudder stocks and suggested to keep the liner's requirement mandatory only for larger diameter (above 200mm), which makes the above-mentioned repairs difficult.

III) In few cases the rudder stock geometry is complex as indicated in the figure below. The rudder stock needs to be tapered from bottom to top to insert the liner.





HP discussed this industry input and decided to modify the requirement as given in section 4 below.

### 3. Source / derivation of the proposed IACS Resolution

None

### 4. Summary of Changes intended for the revised Resolution

UR S10.8.1.1 has been modified as below:

Liners and bushes are to be fitted in way of bearings. For rudder stocks and pintles having diameter less than 200 mm, liners in way of bushes may be provided optionally. The minimum thickness of liners and bushes is to be equal to:

...

### 5. Points of discussions or possible discussions

None

### 6. Attachments, if any

None

## Requirements S10.9.3.1

### 1. Scope and objectives

Clarify the requirement in UR S10.9.3.1 regarding the fillet shoulder radius.

### 2. Engineering background for technical basis and rationale

One member drew the attention of the hull panel to the fact that the requirement for the fillet shoulder radius in UR S10.9.3.1 should be dependent from the material used for the trunk. Hull panel discussed and agreed to that proposal. In addition, it was made clear that this requirement is only applicable to trunks which are extending below the shell or the skeg as shown in figure 12 already.

### 3. Source / derivation of the proposed IACS Resolution

None

### 4. Summary of Changes intended for the revised Resolution

UR S10.9.3.1 was modified as below:

...

For rudder trunks extending below shell or skeg, The the fillet shoulder radius  $r$ , in mm, (see Figure 9-12) is to be as large as practicable and to comply with the following formulae:

$$r = 0.1d_c / k$$

...

$k$  = material factor for the rudder trunk as given in S10.1.3.2 or S10.1.3.5 respectively.

...

### 5. Points of discussions or possible discussions

None

### 6. Attachments, if any

None

# UR S11A “Longitudinal Strength Standard for Container Ships”

## Part A. Revision History

Version no.	Approval date	Implementation date when applicable
New (June 2015)	02 June 2015	1 July 2016

### • New (June 2015)

#### .1 Origin for Change:

Action initiated to address UK MAIB recommendations following the MSC Napoli incident

#### .2 Main Reason for Change:

The main technical reason for the change is to clarify longitudinal strength requirements for container ships and to include recommendations made in the UK MAIB report on the MSC Napoli incident and recommendations made by the IACS EG/Containerships with respect to the safety of large container ships..

#### .3 List of non-IACS Member classification societies contributing through the TC Forum and/or participating in IACS Working Group:

None

#### .4 History of Decisions Made:

The original version was made through project work of a project team under the Hull Panel. The original version, drafted by the project team was reviewed and accepted by the Hull Panel.

#### .5 Other Resolutions Changes

UR S34

#### .6 Dates:

Original Proposal: 23 March 2015 Made by: PT56

Panel Approval: 14 May 2015 by Hull Panel

GPG Approval: 02 June 2015 (Ref: 8566\_IGzo)

## **Part B. Technical Background**

List of Technical Background (TB) documents of UR S11A:

Annex 1. **TB for New (June 2015)**

See separate TB document in Annex 1.



**Technical Background (TB) document for UR S11A (New, June 2015)**

**1 Scope and objectives**

Original version is made to clarify documentation of hull girder strength of large container ships and to incorporate recommendations made by the UK MAIB in their report on the investigation into the structural failure of the MSC Napoli.

**2 Engineering background for technical basis and rationale**

Evaluation of hull girder longitudinal strength for large containerships was investigated and revised based on the existing requirements of UR S11 and the recommendations from the UK MAIB investigations into the MSC Napoli incident. Furthermore the recommendations given by the IACS EG/Containerships and the outcome of the IACS work shop on Container ship safety held in October 2014 were taken into consideration.

A complete new version of the longitudinal strength requirements for Container ships was developed using direct non-linear load computations as a basis for the development of the load (vertical wave bending moment and shear forces) requirements and using the IACS Common Structural Rules for Bulk Carriers and Oil Tankers strength requirements (buckling of plates and stiffeners and ultimate hull girder capacity check) as a basis for the strength requirements of this UR. Consequence studies were carried out to investigate the impact of the new requirements to well-known and accepted designs. Detailed information is given in the attachments.

**3 Source/derivation of the proposed IACS Resolution**

The source of the information was obtained through the work of a project team supervised by the Hull Panel.

**4 Summary of Changes intended for the revised Resolution**

Original version of the UR.

**5 Points of discussions or possible discussions**

The original version was made through discussions of the draft version provided by the project team within the Hull Panel which involved mainly incorporating individual comments and accepting the consolidated text.

**6 Attachments if any**

Detailed technical background document is attached.



## **Attachment 1**

# **Detailed Technical Background for UR S11A (New, June 2015)**

## **Longitudinal Strength Standard for Container Ships**

## **TB S11A.1 General**

UR S11A was developed to incorporate recommendations made by the UK MAIB in their report on the investigation into the structural failure of the MSC Napoli back in 2007. In addition the recommendations given by the IACS EG/Containerships and the outcome of the IACS work shop on Container ship safety held in October 2014 were taken into account.

The philosophy behind the new requirements follows as far as possible the idea of the IACS Common Structural Rules for Bulk Carriers and Oil Tankers (CSR). The loads were determined based on non-linear load computations of more than 120 ships and two loading conditions for each ship as described in more detail below. The strength assessment is based on stress checks for the yielding failure mode, a local check of the buckling failure mode following the prescriptive approach in CSR and the check of the global ultimate limit state in bending, also based on the CSR approach.

Net scantlings have to be taken into account when carrying out the strength assessment. The corrosion margins defined are based on the CSR-values for similar structural elements. In addition the selection of corrosion margins is supported by statistical analysis of measured data as described in more detail below.

The permissible stresses for the yield assessment are set to the same values as in CSR for the mid-ship region. A decrease of these stresses towards the ship ends is not defined, however the strength assessment according to the new requirements is limited for the region between  $0.2L$  and  $0.75L$ . Areas outside this region have to be assessed according to the requirements of the individual society.

The decrease of the section modulus caused by the net-scantling approach (deduction of 50% of the corrosion margin) for Container ships is in general smaller than for Bulk Carriers of Tankers. While at the bottom area of Containerships the difference between the gross and net-50 section modulus is about 7%, the difference at the upper flange area is only about 4%, caused by the very thick plates within that area. However corrosion effects and corrosion rates obviously are ship-type dependent, therefore using the same permissible stress level and the same philosophy regarding the determination of net-scantlings should lead to a comparable level of safety in general.

Regarding the ultimate limit state a local (buckling assessment of longitudinal structural members) and a global check (ultimate hull girder strength) is introduced in the new requirement.

The local buckling check for the longitudinal strength members follows the prescriptive approach as implemented in the CSR. Due to the limitation of Container ships and the consideration of only the longitudinal normal hull girder stress induced by vertical bending moment and the shear stress induced by the vertical shear force, the formulations given in the CSR could be simplified as in detail described below.

The ultimate hull girder strength check follows the iterative-incremental approach as defined in the CSR. Only changes were made with respect to the partial safety factors as described in detail below. While it would be desirable to recalibrate these factors for other ship-types as

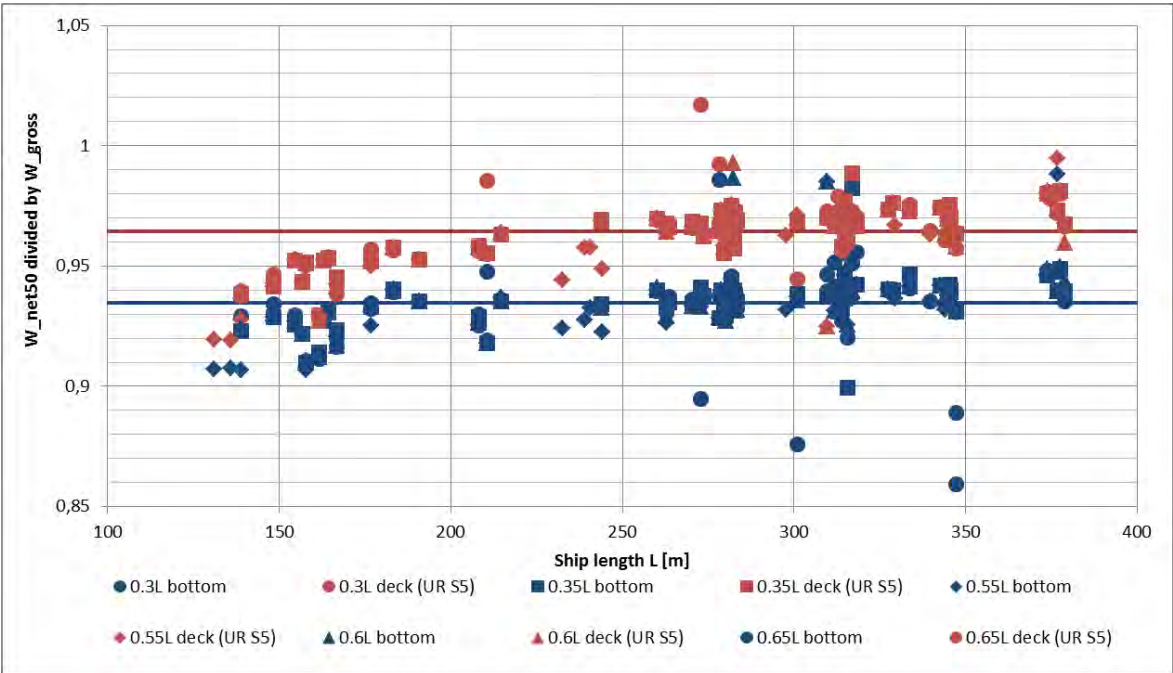
Bulk Carriers and Oil Tankers by means of Structural Reliability Analysis (SRA), the selection of the PSF for the new requirement was done by comparison of results obtained during a consequence assessment with well-known designs, considering the experience of class societies that carry out this checks for long time and taking into account information public available, like the report of NK with respect to the MOL Comfort accident.

Therefore the new requirement is based on a technical sound and transparent concept following basically the same philosophy as the CSR, establishing rationally based load formulations and applying general and harmonized methods for the strength assessments.

**TB S11A.1.3 Corrosion margin and net thickness**

Net thickness approach is consistent with CSR (reference is also made to technical background for CSR). Even in the existing UR S11 net thicknesses (a certain percentage of gross thickness deducted as corrosion margin) is implemented for the buckling check.

The net thickness approach affects the permissible stress level compared to UR S11, and is used in checks of buckling, yield, ultimate capacity and moment of inertia. The effect of the net thickness approach for an open cross section (container ship) differs from a closed cross section (tanker) with respect to the change of the section modulus in deck and bottom due to the corrosion margins (refer to Figure 1).



**Figure 1: Relation between section modulus obtained by applying  $t_{net}$  and  $t_{gross}$  for 5 different sections of container ships at bottom level and at equivalent deck level according to UR S5.**

In case of Tanker and Bulk carrier cross sections the difference between the section moduli obtained at gross scantlings and at net scantlings is of about 10%, while in case of Container ships the change from gross to net gives a change in section moduli of about 7% at bottom level and of about 3 to 4% at deck level, see Figure 1. However, because the corrosion effects are ship type dependent, the permissible stresses are set to the same values than in CSR.



The proposed corrosion margins are regarded as minimum values, and the individual class society may require higher corrosion margins, if statistical data of corrosion measured during operation is supporting this.

### Detailed corrosion addition values

The corrosion addition for each of the two sides of a structural member as listed in Table 1 is simplified compared to CSR. In addition to the corrosions additions on each surface, a reserve thickness of 0.5mm should be added. The corrosion additions have been rounded to the nearest 0.5mm for simplification (to avoid rounding rule).

The total corrosion addition,  $t_c$ , in mm, for both sides of the structural member is obtained by the following formula:

$$t_c = (t_{c1} + t_{c2}) + t_{res}$$

With  $t_{res}$  the reserve thickness of 0.5mm as explained above.

The formulations below consider ships in general, and not everything is regarded relevant for Container ships.

#### *Ballast water tank*

$t_c$  has been rounded down to nearest 0.5mm. Increased corrosion margin in 3m zone below deck and increased corrosion in way of heated surfaces are generally not followed up in ship in service evaluation and are removed for simplicity.

#### *Tanks for cargo oil, liquid chemicals*

The criteria are simplified compared to CSR and values rounded down considering these are ships not covered by CSR and typically less than 150m.

#### *Cargo holds of dry bulk, container and general cargo holds*

$t_c$  reduced due to higher coating standard than what was used in the investigation for CSR. In addition the CSR corrosion additions are considered too large.  $t_c$  is increased in lower area due to mechanical wear and tear, and water/moisture.

#### *Exposed to sea water*

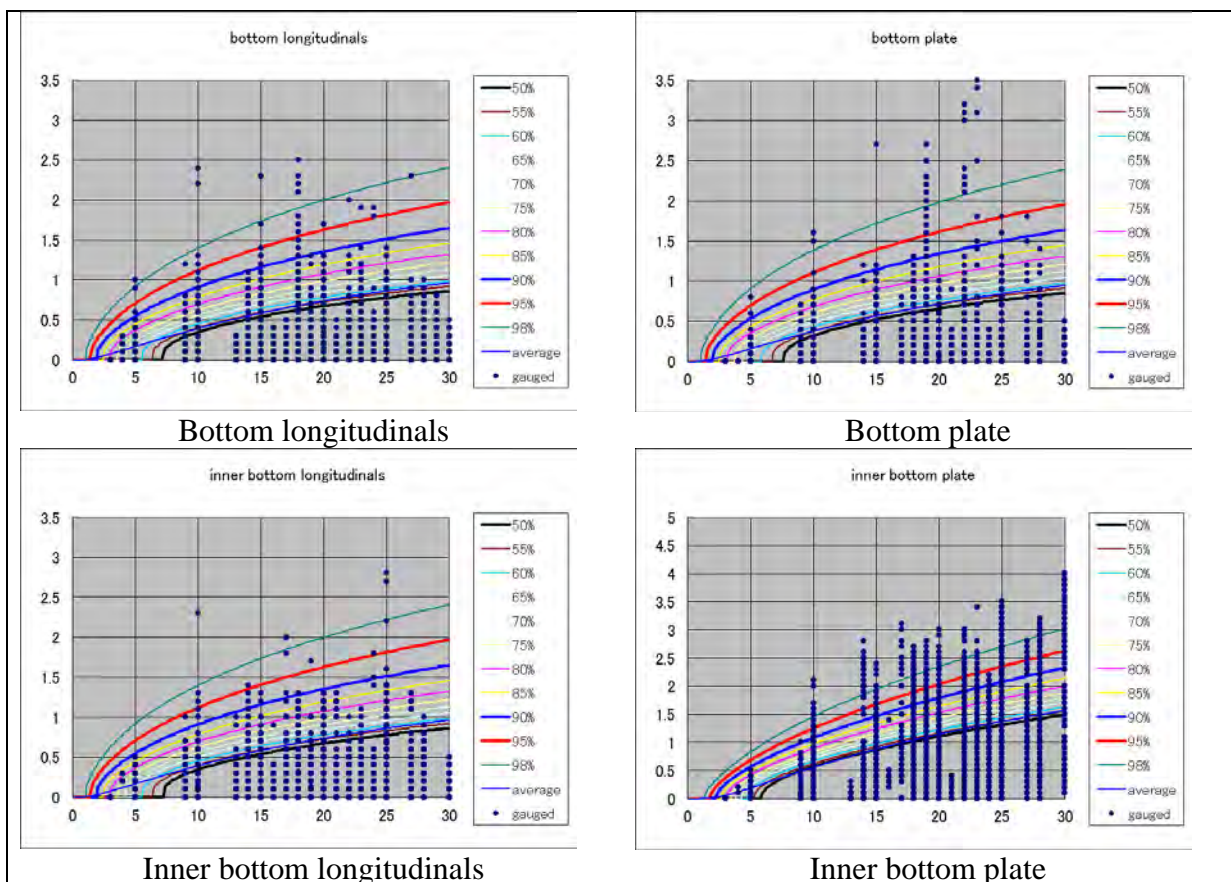
Addition between scantling draught and ballast draught is removed for simplicity and because 20% corrosion margin is typically used for ships in operation.

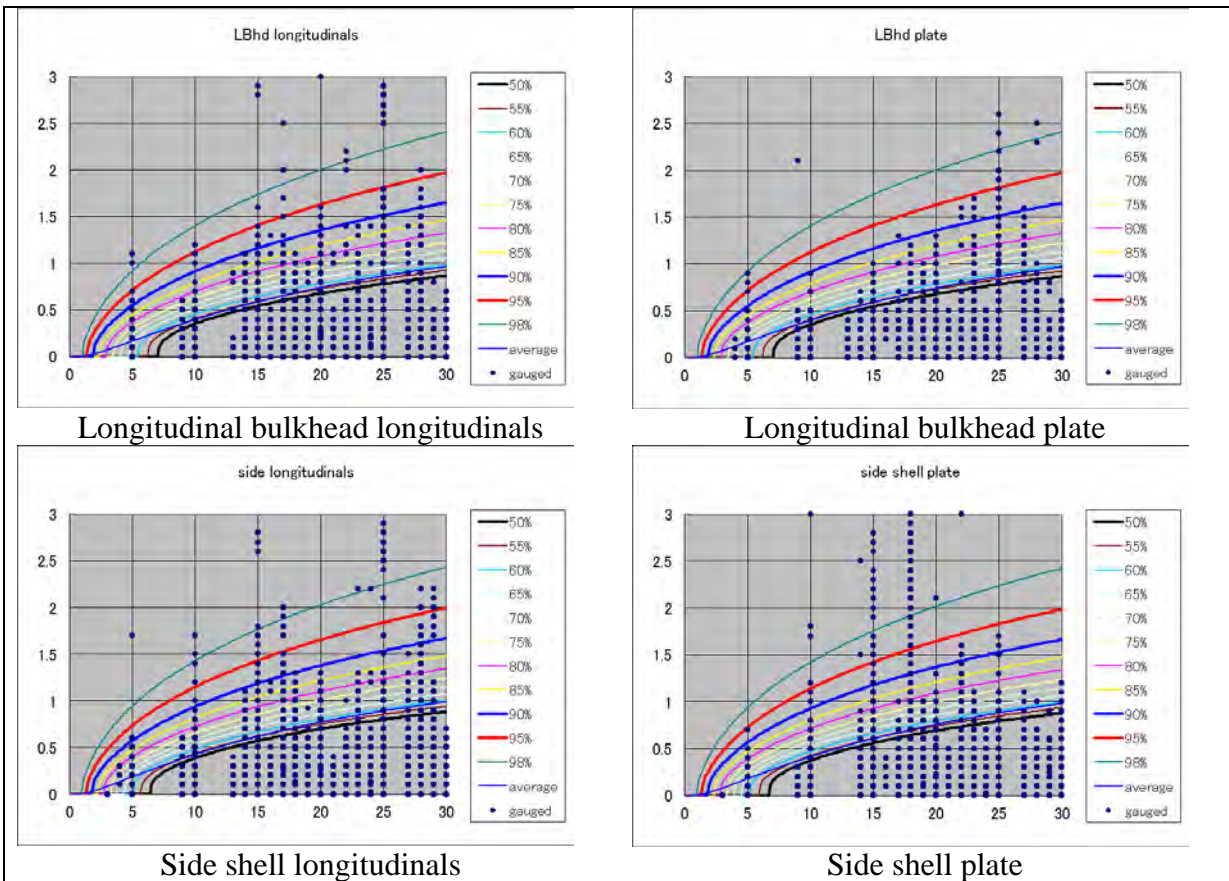
**Table 1: corrosion addition for one side of structural member**

Compartment type	One side corrosion addition $t_{c1}$ or $t_{c2}$ [mm]
Exposed to sea water	1.0
Exposed to atmosphere	1.0

Ballast water tank	1.0
Void and dry spaces	0.5
Fresh water, fuel oil and lube oil tank	0.5
Accommodation spaces	0.0
Container holds	1.0
Compartment types not mentioned above	0.5

The values above are in addition supported by approximately 210,000 thickness measurement data sampled from 22 thickness measurements for Container ships with an age from 3 to 30 years. Corrosion behavior is estimated by the probabilistic theory and thickness measurement data of each structure member of Container ships. Evaluation results for each structure member are shown in Figure 2.





**Figure 2: Evaluation results of measured data for structural members**

The lines shown in the above figures represent expected values of thickness diminution corresponding to the ship's ages and the different levels of cumulative probabilities, and the dots in the above figures represent thickness measurement data.

Adopting the same approach for corrosion addition of CSR, the expected values at the cumulative probability of 90% for 25 years are used as corrosion additions for the measured structural members. They are summarized in Table 2.

**Table 2: Summary of corrosion data**

Structural member	Compartment type	Corrosion addition (mm)	Number of samples
Bottom longitudinal	BWT / BWT	1.51	35260
Bottom plate	BWT / Exposed to sea water	1.50	14640
Inner bottom longitudinal	BWT / BWT	1.51	35061
Inner bottom plate	BWT / Container cargo area	2.07	15540
LBhd longitudinal	BWT / BWT	1.52	36598
LBhd plate	BWT / Container cargo area	1.52	11787
Side longitudinal	BWT / BWT	1.54	43581
Side shell plate	BWT / Exposed to sea water	1.53	16309

In order to determine the corrosion additions for corrosive environments for each side one by one, the following steps have been carried out.

Since the bottom longitudinal, the inner bottom longitudinal, the LBhd longitudinal and the side longitudinal are exposed to the water ballast tank in both sides, the each corrosion addition of them ( $t_{bl}$ ,  $t_{ibl}$ ,  $t_{Ll}$  and  $t_{sl}$ ) can be obtained respectively as follows:

$$2t_{bl}=1.51(\text{bottom longitudinal})$$

$$t_{bl}=0.755 \text{ (mm)}$$

$$2t_{ibl}=1.51(\text{inner bottom longitudinal})$$

$$t_{ibl}=0.755 \text{ (mm)}$$

$$2t_{Ll}=1.52(\text{LBhd longitudinal})$$

$$t_{Ll}=0.76 \text{ (mm)}$$

$$2t_{sl}=1.54 \text{ (side longitudinal)}$$

$$t_{sl}=0.77 \text{ (mm)}$$

The obtained four types of longitudinal corrosion additions are in good agreement, and can be appropriate values as the corrosion addition for water ballast tank. Thus, the corrosion addition for water ballast tank ( $t_{ballast}$ ) has been determined from their weighted average values as follows:

$$t_{ballast} = \frac{t_{bl} \times 35260 + t_{ibl} \times 35061 + t_{Ll} \times 36598 + t_{sl} \times 43581}{35260 + 35061 + 36598 + 43581}$$

$$t_{ballast} = 0.76 \text{ (mm)}$$

The inner bottom plate and the LBhd plate are exposed to the water ballast tank in one side and container cargo area in the other side. We attempt to determine the corrosion additions for container cargo area from those of the inner bottom plate and the LBhd plate ( $t_{ibp}$  and  $t_{Lp}$ ) as follows:

$$t_{ibp} + t_{ballast} = 2.07 \text{ (inner bottom plate)}$$

$$t_{ibp} + 0.76 = 2.07$$

$$t_{ibp} = 1.31 \text{ (mm)}$$

$$t_{Lp} + t_{ballast} = 1.52 \text{ (LBhd plate)}$$

$$t_{Lp} + 0.76 = 1.52$$

$$t_{Lp} = 0.76 \text{ (mm)}$$

The difference between the two corrosion additions obtained above seems even reasonable because the corrosion additions for bulk cargo hold and cargo tank are given different values for upper part and lower part in the CSR. Therefore, it is determined that the corrosion additions for lower part and upper part of container cargo area are set separate values based on the measured data as follows.

Corrosion addition for lower part of container cargo area: 1.30 (mm)

Corrosion addition for upper part of container cargo area: 0.75 (mm)

Keeping in mind, that the selected corrosion margins, see Table 1, are minimum values, the selected values are supported by the measured data as demonstrated above.

## Application for strength assessments

### *Hull girder yield strength*

UR S11A yield check is proposed to be carried out on net scantlings with 190/k N/mm<sup>2</sup> allowable bending stress, and 120/k N/mm<sup>2</sup> shear stress.

### *Local strength*

Buckling capacity of longitudinal strength members should be calculated based on full corrosion addition, and hull girder stresses should be calculated based on half corrosion margin.

The corrosion addition factor is implemented to determine the net thickness to be applied for the strength assessment under consideration. The net thickness,  $t_{net}$ , for the plates, webs and flanges is obtained by subtracting the voluntary addition  $t_{vol\_add}$  and the factored corrosion addition  $t_c$  from the as built thickness  $t_{as\_built}$ , as follows:

$$t_{net} = t_{as\_built} - t_{vol\_add} - \alpha t_c$$

where  $\alpha$  is a corrosion addition factor whose values are defined in Table 3.

**Table 3: Values of corrosion addition factor**

<b>Structural requirement</b>	<b>Property / analysis type</b>	<b><math>\alpha</math></b>
Strength assessment(S11A.3)	Section properties	0.5
Buckling strength (S11A.4)	Section properties (stress determination)	0.5
	Buckling capacity	1.0
Hull girder ultimate strength (S11A.5)	Section properties	0.5
	Buckling / collapse capacity	0.5

## TB S11A.2 Loads

## **TB S11A.2.2 Still water bending moments and shear forces**

The requirements regarding the still water bending moments and shear forces were developed based on existing unified requirements. For the strength assessment according to the S11A it is important to combine the still water loads that envelope the vertical bending moment and shear forces in possible seagoing loading conditions with the envelope values for the wave loads.

Therefore the design loading conditions have to envelope the maximum and minimum still water bending moments and shear forces for the seagoing loading conditions defined in the Loading Manual and additional maximum and minimum still water bending moments and shear forces that are specified by the designer, if any (S11A.2.2.2).

This includes the in more detail described loading conditions of the current S11, including the requirements with respect to intermediate conditions of ballasting and deballasting, if applicable, as well as the requirements with respect to partially filled ballast tanks in ballast loading conditions, as required under S11.2.1.3 and S11.2.1.4.

Other particular mentioned loading conditions in the current S11.2.1.2 as

- Homogeneous loading conditions at maximum draught;
- Ballast conditions;
- Special loading conditions e.g., container or light load conditions at less than the maximum draught, non-homogeneous cargo conditions, deck cargo conditions, etc., where applicable

as well as additional loading conditions mentioned in Annex 1 of UR S1 as:

- Short voyage or harbour conditions, where applicable
- Docking condition afloat
- Loading and unloading transitory conditions, where applicable

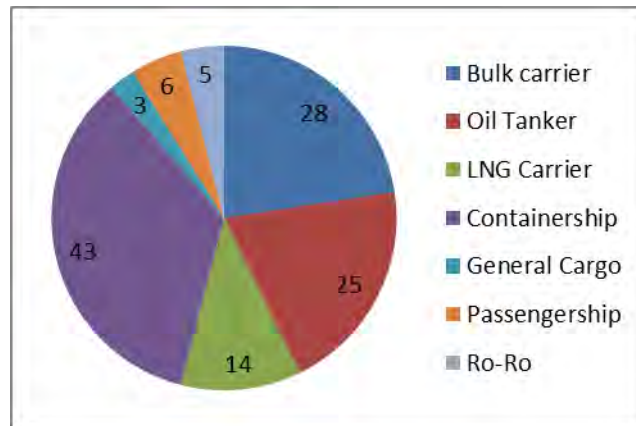
are seen to be covered by the formulations in the new S11A. It has to be mentioned that for the checks in S11A only seagoing conditions are of relevance.

In principle all relevant seagoing loading conditions, including ballast conditions and ballast exchange conditions and intermediate conditions, if necessary should be included in the Loading Manual. Because a unified requirement for the loading conditions that has to be included in the Loading Manual already exists (UR S1), reference to that UR was made for the definition of the still water loads (S11A.2.2.2).

## **TB S11A.2.3 Vertical wave bending moments and shear forces**

### **Ship database used for direct calculations**

All the new formulations were derived by comparison with direct computations results. For this purpose a database of 124 ships was built, including slender ships and blunt ships for comparison. For each ship two different loading conditions were considered (full load / ballast, or maximum hogging / minimum hogging).



**Figure 3: Distribution of ship types in the database**

For each ship and each loading conditions the design hull girder loads have been computed at 21 sections along the ship (every 0.05 L), with the following assumptions

- Sea states described by the North Atlantic scatter diagram from IACS Rec. no. 34
- All headings with a step of 15 degrees and even probability distribution
- Ship speed equal to 5 knots (instead of 0 knots from IACS Rec. no. 34)
- Extreme response corresponding to one exceedance every 25 years (probability of exceedance of about  $10^{-8}$ )

The ships were characterized by their rule length L and by the following dimensionless parameters:

- B/L: Ratio beam over length
- T/L: Ratio draft over length
- $C_B$ : Block coefficient
- $C_W$ : Waterplane coefficient (waterplane area divided by B.L)
- Trim: static trim of the ship (not used in the formulations)
- LCG/L: longitudinal position of the center of gravity (not used in the formulations)
- kyy/L: dimensionless radius of gyration in pitch (not used in the formulations)
- GM/B: dimensionless vertical position of the center of gravity (not used in the formulations)
- $f_{\text{bow}}$ : bow flare coefficient (used for the nonlinear sagging coefficient)

The block coefficient and the water plane coefficient depend on the draft of the loading condition.

The limitations in the application of the load formulations are directly derived from the range of parameters of the ship database. In the following figures, the plain dots are for the full load conditions, the hollow dots are for the ballast conditions. Whenever possible, all the formulations have been developed to be applicable to any type of ship, and any loading condition (draft), even if in the scope of S11A they are applied only to containerships at design draft. It was also found difficult to make a clear definition of slender and blunt ships based on the block coefficient and it was found unreasonable to end up with two different formulations for slender and blunt ships, which would have a step at a certain block coefficient. This would also make the formulation inconsistent with URS11 for other ship types.



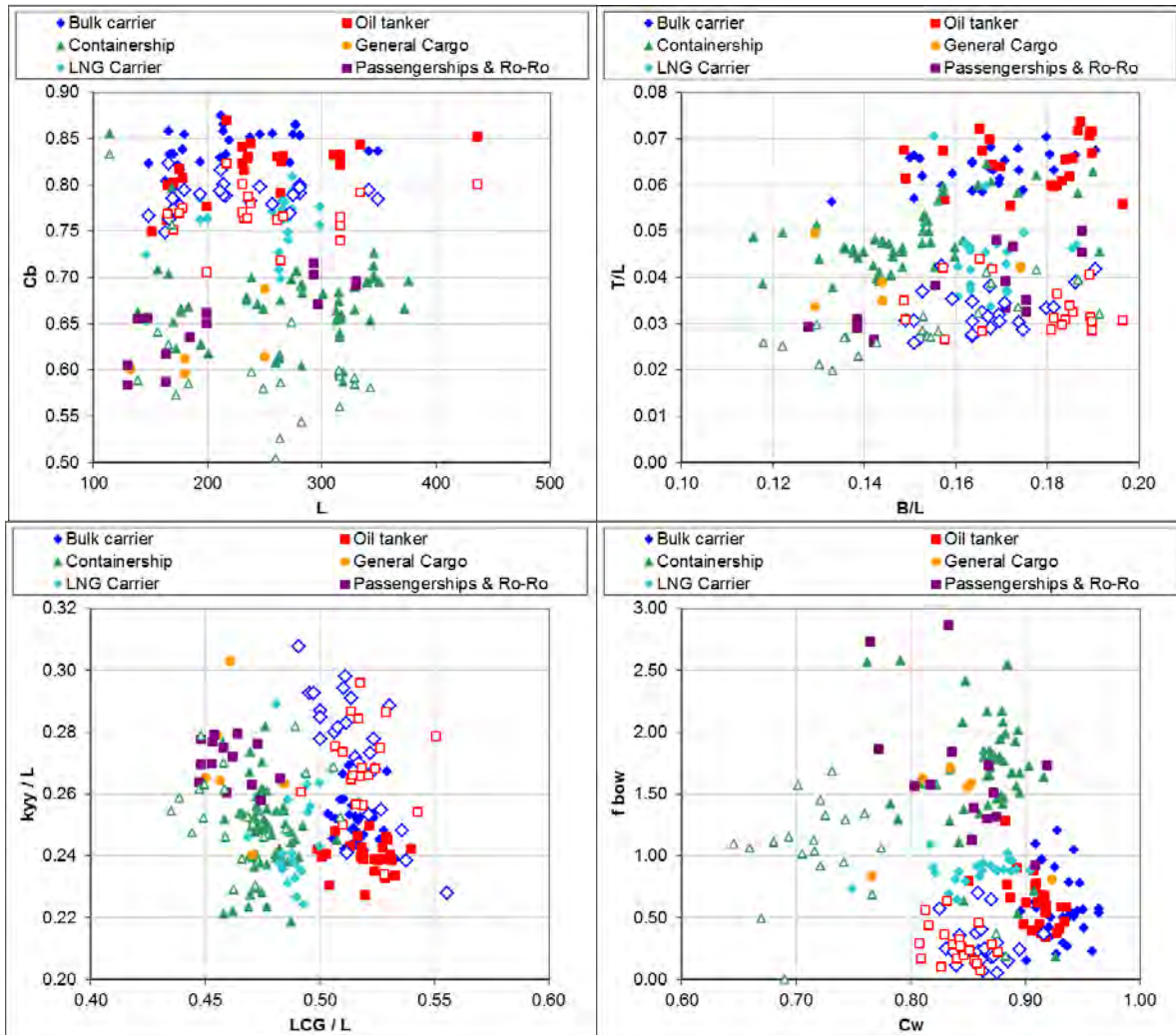


Figure 4: Main dimension parameters of the ships in the database

### Comparison of the software from each class society

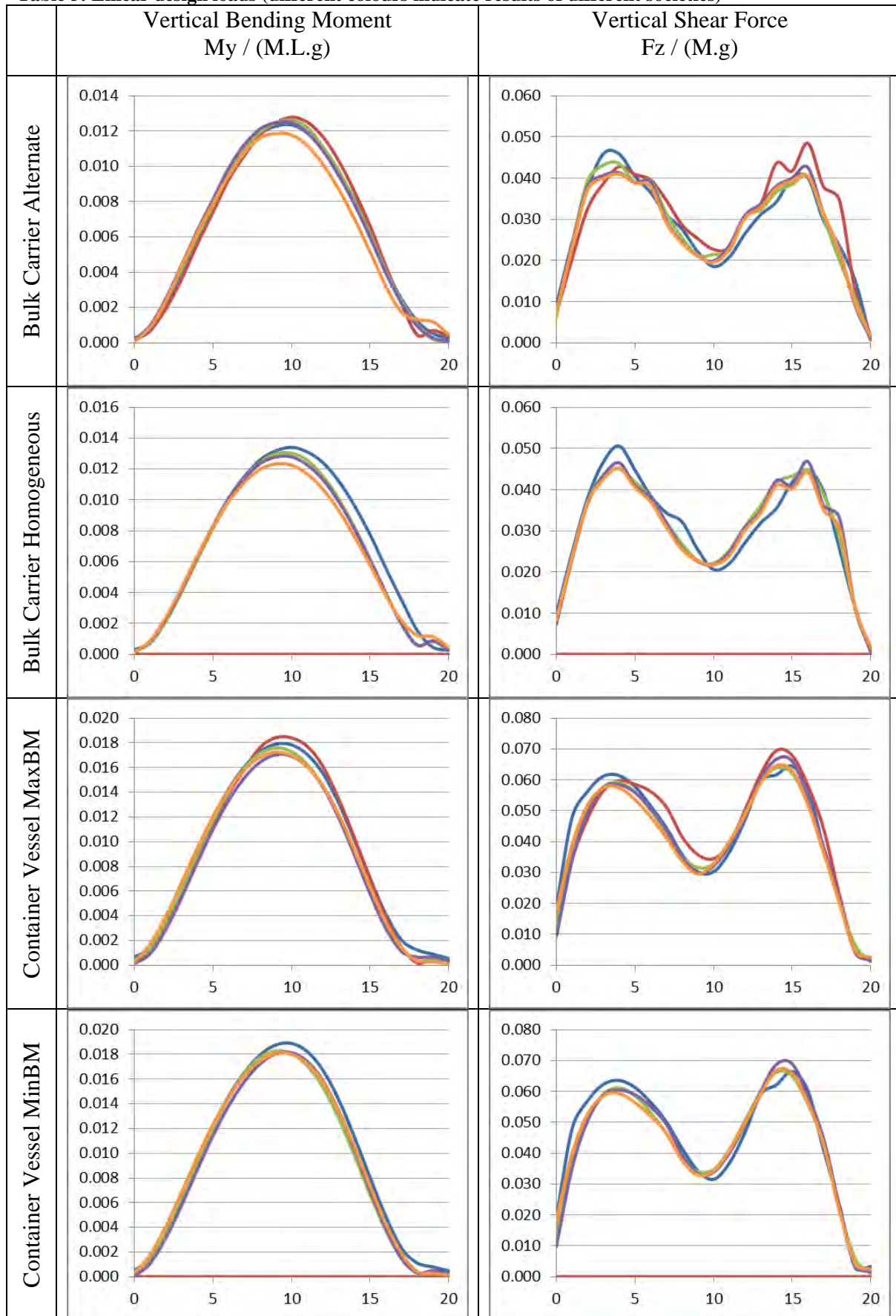
3 ships have been selected for a comparison of the results given by the different class society software. The main characteristics of these ships are given below.

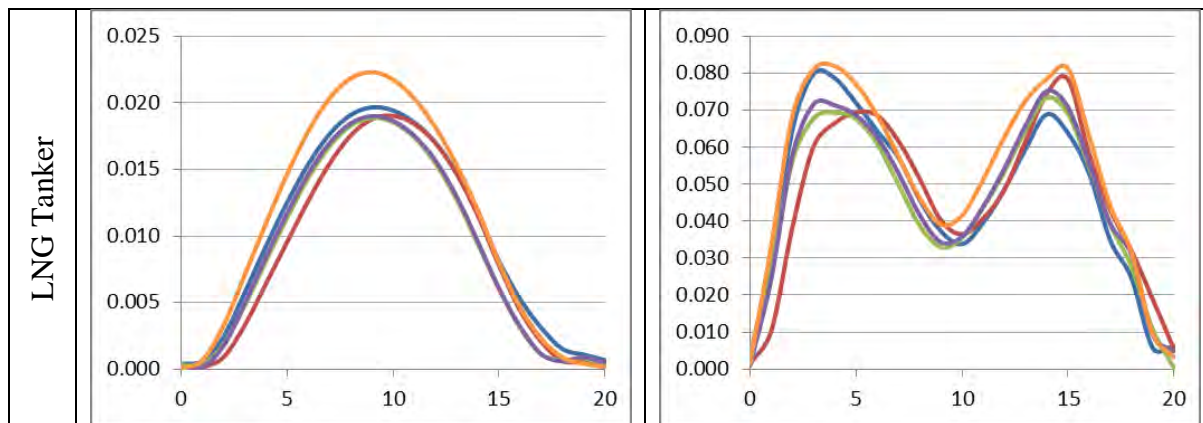
Table 4: Main characteristics of ships used for comparison calculations between the societies

		L	B	$\Delta$	LCG/L	Kyy/L	TM	GM	Cb	Cw
		m	m	t	-	-	m	m	-	-
LNG Tanker	Full	268.0	47.0	98610	0.505	0.260	11.00	4.05	0.69	0.80
Container	MaxBM	350.7	51.4	210374	0.489	0.261	16.62	0.65	0.68	0.88
Container	MinBM	350.7	51.4	210378	0.489	0.237	16.63	3.54	0.68	0.88
Bulk	Alternate	277.3	46.6	200751	0.544	0.267	17.67	9.61	0.86	0.93
Bulk	Homogenous	277.3	46.6	200750	0.538	0.252	17.65	5.76	0.86	0.93

The methodologies and tools used by each classification societies to compute the linear design loads are very similar. Hull girder loads RAOs are computed using 3D Boundary Element Method seakeeping software (with Rankine or Kelvin sources). The linear long-term analysis is performed using the IACS scatter diagram, and the linear long-term design loads corresponding to a 25 year return period are computed. The results from each class society are very consistent.

**Table 5: Linear design loads (different colours indicate results of different societies)**





The methodologies and tools used by each classification societies to compute the non-linear design loads are very different.

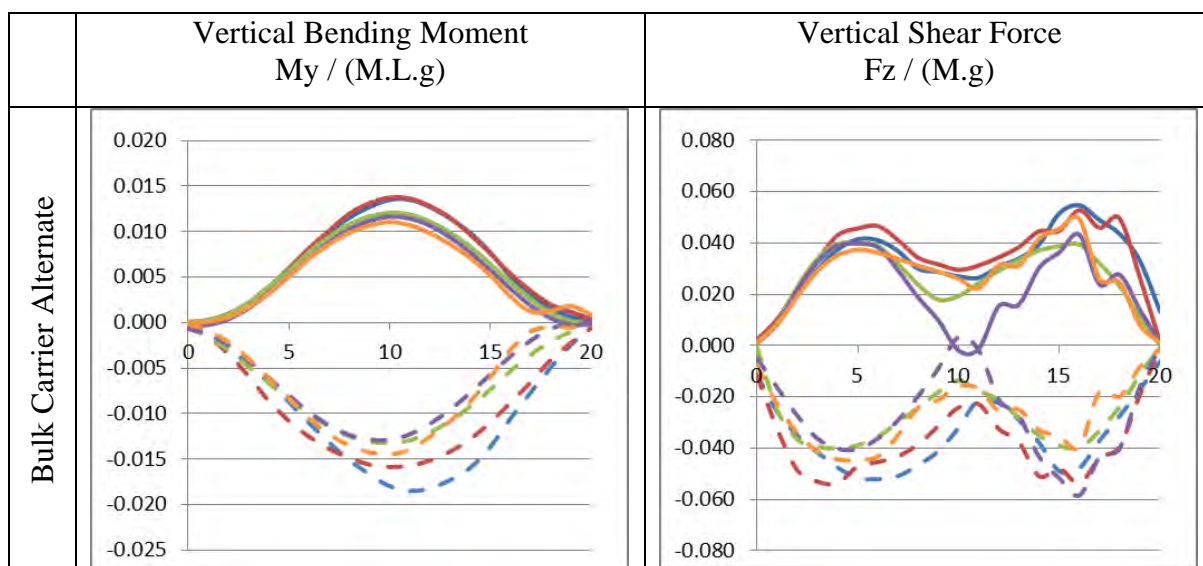
Different types of seakeeping codes are used to compute the hull girder loads:

- Some codes are based on a simple pressure correction (pressure added above the mean free surface under the wave crest, and set to zero above the wave trough). The equilibrium is achieved either by adjusting the ship position, or by changing the acceleration.
- Some codes are time domain codes based on hydrostatic and Froude-Krylov pressure correction. Ship position and acceleration are computed at each time step.

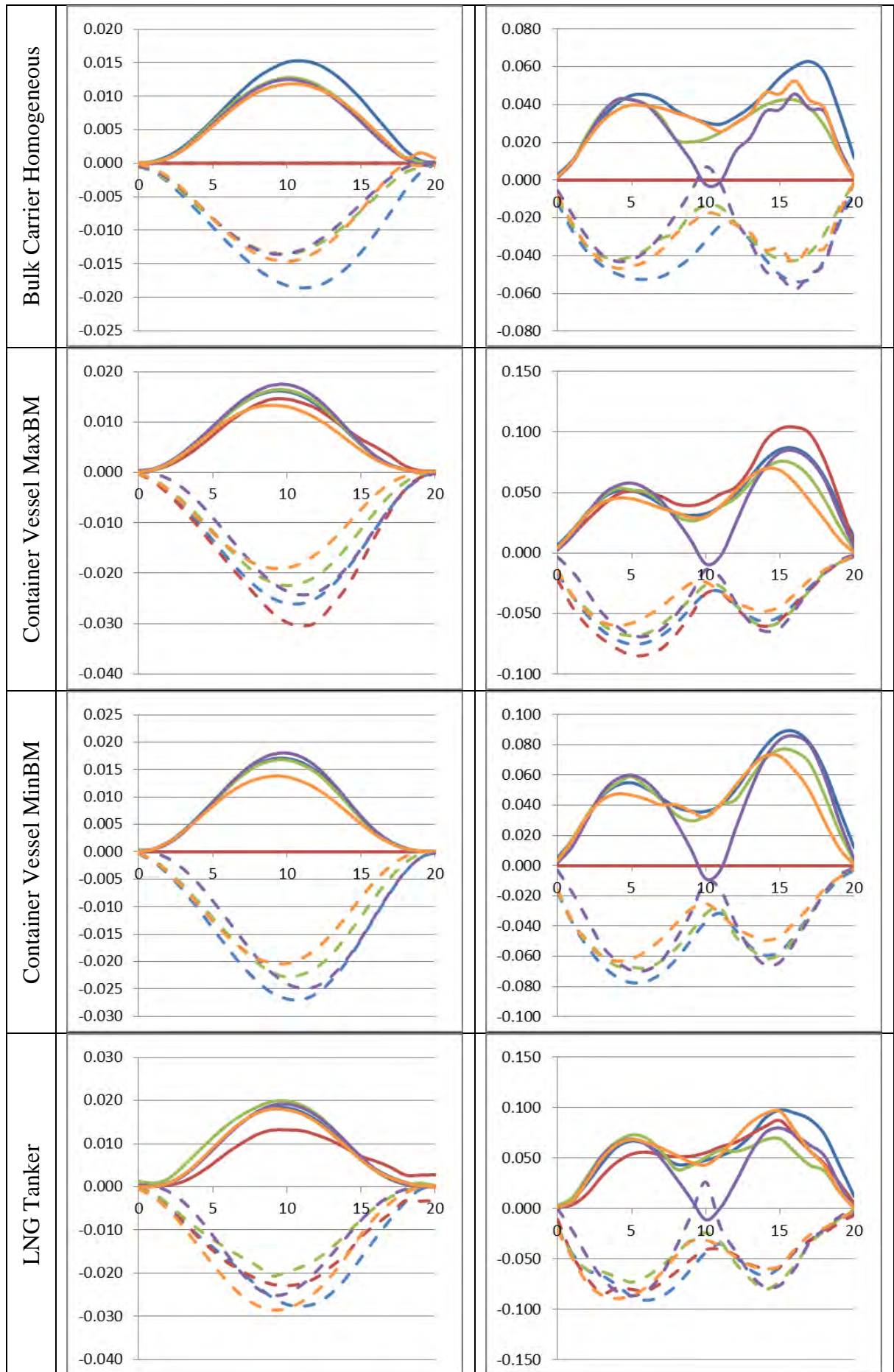
Different types of wave conditions are used: Regular Design Waves, or a Design Sea States of several hours from which short-term statistics are extracted.

The following non-linear envelopes are obtained for each ship. Even if the methods used by the different class societies represent state of the art methods, the differences in results are quite large.

**Table 6: Non-linear design loads (different colours indicate results of different societies)**







## Format of the rule formulations

The rule formulation for the hull girder loads is split in four parts:

- Scale factor
- Wave parameter
- Non-dimensional formulation
- Non-linear factor

This split was not explicit in the UR S11 formulation, but the same four terms can be easily identified. For example the formulation for the sagging moment can be rewritten as:

$$M_{Sag} = 0.11CL^2B(Cb + 0.7) = L^3 \cdot C \cdot \left(0.19 \frac{B}{L} Cb\right) \cdot \left(\frac{11 Cb + 0.7}{19 Cb}\right)$$

- Scale factor:  $L^3$
- Wave parameter (representative for the scatter diagram used):  $C$
- Non-dimensional formulation:  $0.19 \frac{B}{L} Cb$
- Non-linear factor:  $\frac{11 Cb + 0.7}{19 Cb}$

The scale factor depends only on the dimension of the load. It is equal to  $L^3$  for bending moment and to  $L^2$  for shear force.

Linear seakeeping computations have been used to calibrate the linear part of the rule formulations (wave parameter and non-dimensional formulation). Non-linear computations have been used to calibrate the non-linear factors. The computations have been done for all the ships in the database, and the rule formulations have been fitted to cover all ship types, and all loading conditions.

## Wave parameter

The wave parameter  $C$  is given in S11 as:

$$C = 10.75 - \left(\frac{300 - L}{100}\right)^{1.5} \quad 90 \leq L \leq 300$$

$$C = 10.75 \quad 300 \leq L \leq 350$$

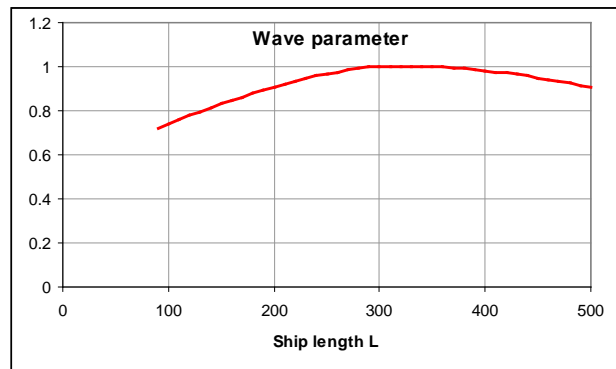
$$C = 10.75 - \left(\frac{L - 350}{150}\right)^{1.5} \quad 350 \leq L \leq 500$$

It can be rewritten as:

$$C = 1 - 0.48 \left(1 - \frac{L}{300}\right)^{1.5} \quad 90 \leq L \leq 300$$

$$C = 1.0 \quad 300 \leq L \leq 350$$

$$C = 1 - 0.33 \left(\frac{L}{350} - 1\right)^{1.5} \quad 350 \leq L \leq 500$$



Note that the constant 10.75 has been removed from the wave parameter and has to be included in the non-dimensional formulation.

If we have two ships of different length  $L_1$  and  $L_2$ , but with the same hull form, then the block coefficient, the ratio  $B/L$  and all other non-dimensional coefficients are the same. The ratio between the design loads of ship 1 and 2 is:

$$\frac{VBM_1}{VBM_2} = \left(\frac{L_1}{L_2}\right)^3 \frac{C_1}{C_2}$$

For each ship of the database, some homothetic ships have been derived, ranging from  $L=90\text{m}$  to  $L=740\text{m}$ . Those virtual ships have been derived through a pure homothetic scaling of all dimensions; hence the non-dimensional parameters such as  $C_b$ ,  $C_w$  or  $B/L$  have not been changed.

For all those homothetic ships, the long-term vertical bending moment at midship section is computed and then divided by  $L^3$  to remove the scale effect. For each homothetic family, the length corresponding to the maximum of this ratio is determined and called the reference length ( $L_{ref}$ ). The wave parameter for all the other lengths can then be computed as:

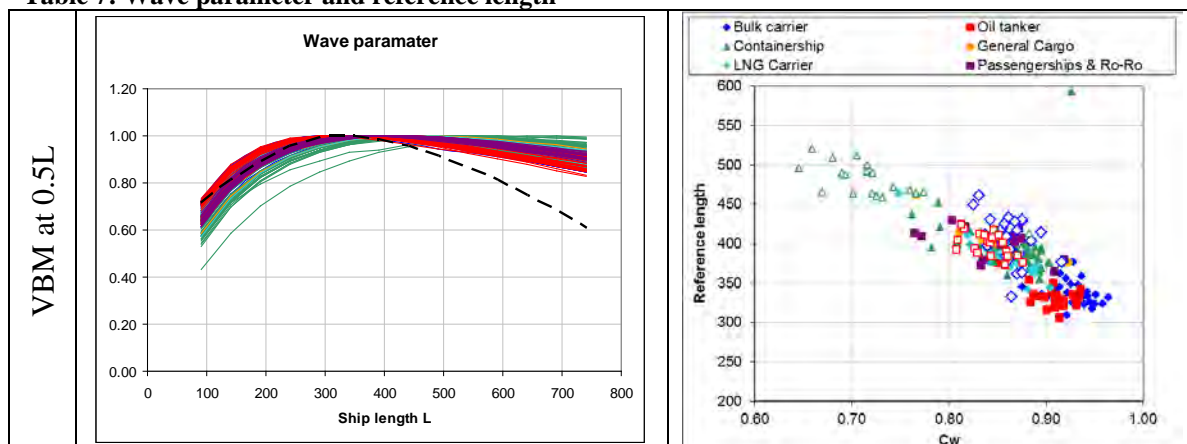
$$C = \frac{VBM / L^3}{VBM_{ref} / L_{ref}^3}$$

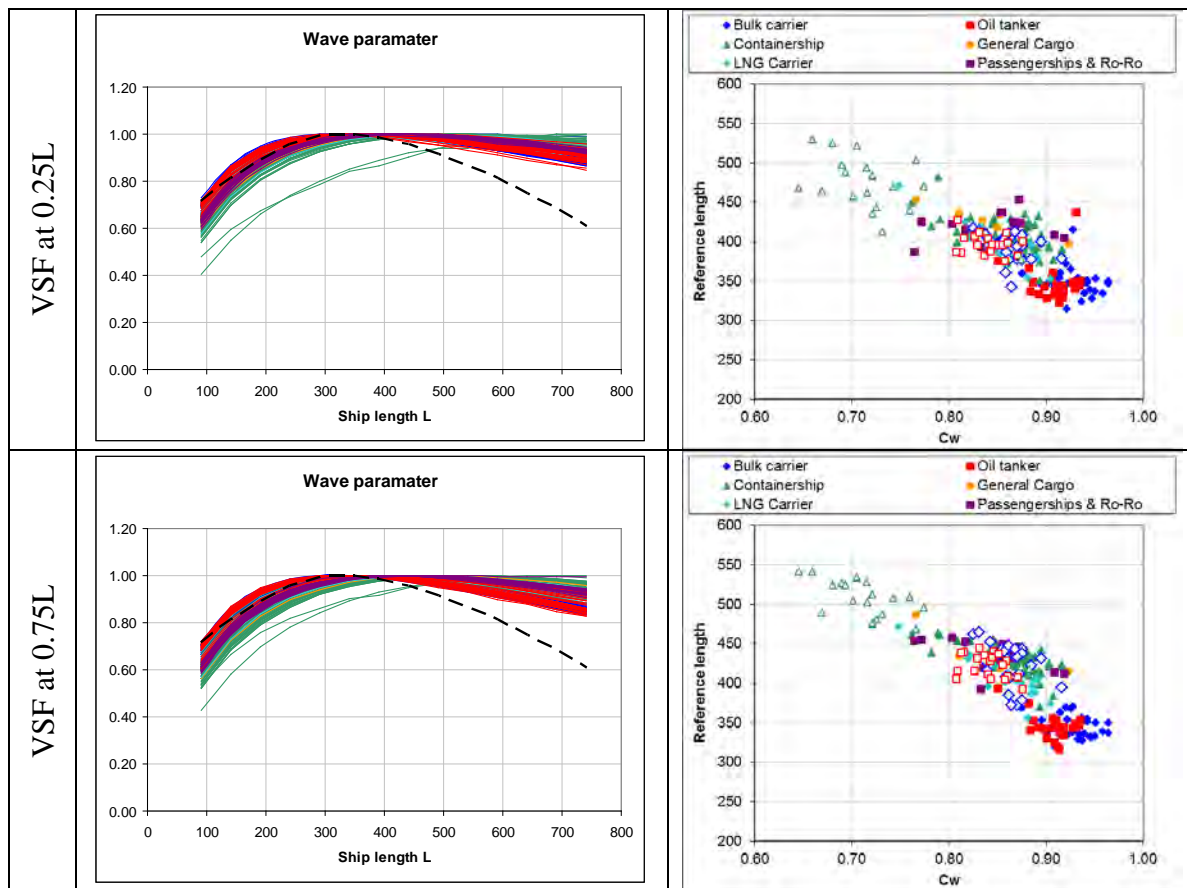
The procedure is done again using the long-term vertical shear force at  $0.25L$  and at  $0.75L$ . Note that for the shear force, the long-term value is divided by  $L^2$ . Three wave parameters are then defined: for VBM at  $0.5L$ , VSF at  $0.25L$  and VSF at  $0.75L$ .

The results shown in the following figures show that:

- the wave parameters for bending moment and shear forces are nearly the same
- The reference length is ranging from 300m to more than 500m, and seems to depend on the ship type
- The current formulation for the wave parameter doesn't perform very well for the longest ships.
- The reference length is greater for containerships than for blunt ships

**Table 7: Wave parameter and reference length**





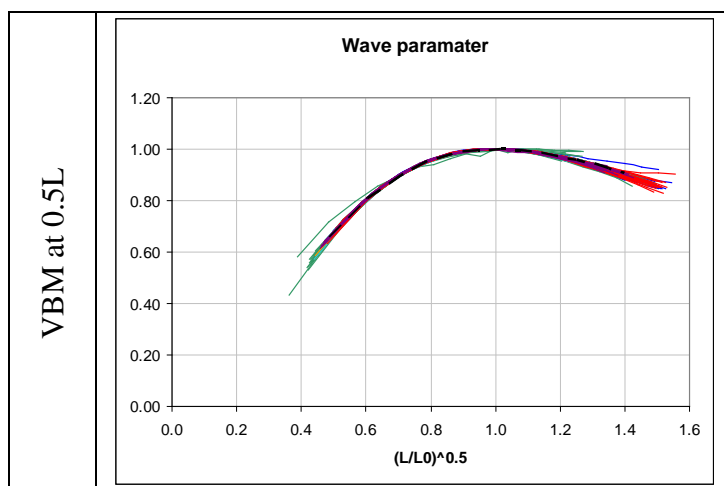
It is interesting to see that when the reference length  $L_{ref}$  is taken into account, it is possible to formulate a very accurate wave parameter. The following figures are showing the computed wave parameter plotted with respect to  $\sqrt{L/L_{ref}}$ , where  $L_{ref}$  is the computed reference length.

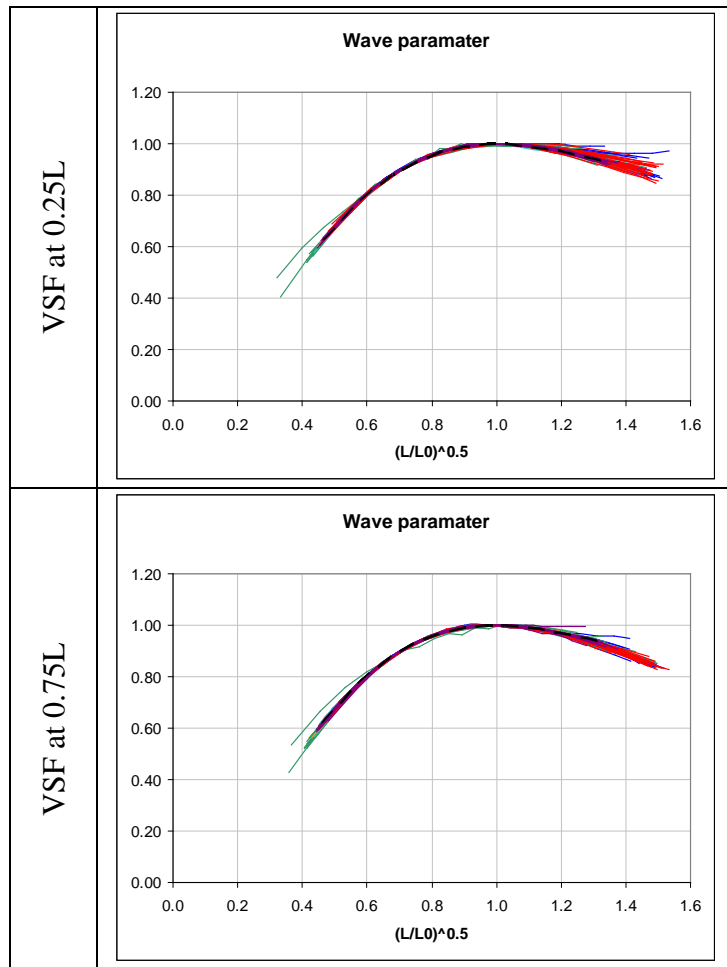
The black dotted line in these figures is the proposed formulation:

$$C = 1 - 1.50 \left( 1 - \sqrt{\frac{L}{L_{ref}}} \right)^{2.2} \quad \text{for } L \leq L_{ref}$$

$$C = 1 - 0.45 \left( \sqrt{\frac{L}{L_{ref}}} - 1 \right)^{1.7} \quad \text{for } L > L_{ref}$$

**Table 8: Wave parameter function of  $(L/L_{ref})^{0.5}$**





The following formulations are proposed for the reference length, which depends on the water plane coefficient  $C_W$ . Note that this coefficient is draft dependent.

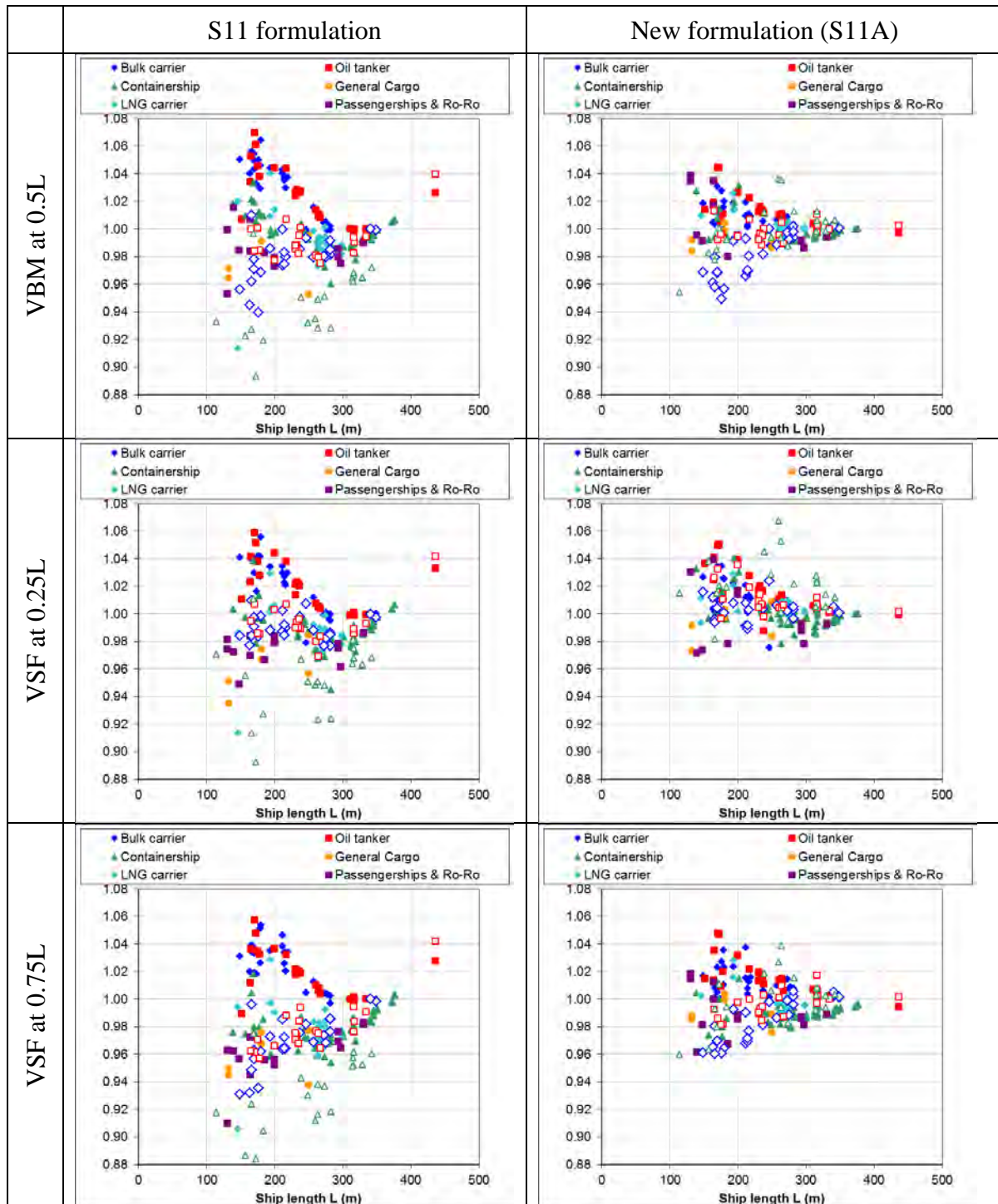
$$L_{\text{ref}} = 315 C_W^{-1.3} \quad \text{for wave bending moment}$$

$$L_{\text{ref}} = 330 C_W^{-1.3} \quad \text{for wave shear force}$$

The following figures show the ratio between the computed wave parameter and the rule formulation. The comparison is better with the proposed formulation than it was with the S11 formulation.



**Table 9: Ratio between the computed wave parameter and the proposed formulation**



The accuracy of the formulation is defined as the coefficient of variation (ratio between the standard deviation and the average) of the ratios between the computed wave parameter and the formulation. The accuracy of the new formulation is twice better than the S11 formulation.

$$\frac{STDEV\left(\frac{C_{Computed}}{C_{Rule}}\right)}{Average\left(\frac{C_{Computed}}{C_{Rule}}\right)}$$

**Table 10: Accuracy of the S11 and S11A formulations for the wave parameter (entire database)**

	<b>VBM</b>	<b>VSF aft</b>	<b>VSF fore</b>
<b>UR S11 formulation</b>	<b>3.4%</b>	<b>3.4%</b>	<b>3.6%</b>
<b>UR S11A formulation</b>	<b>2.0%</b>	<b>2.3%</b>	<b>2.0%</b>

**Table 11: Accuracy of the S11 and S11A formulations for the wave parameter (containership in full load only)**

	<b>VBM</b>	<b>VSF aft</b>	<b>VSF fore</b>
<b>UR S11 formulation</b>	<b>1.2%</b>	<b>1.4%</b>	<b>1.3%</b>
<b>UR S11A formulation</b>	<b>0.8%</b>	<b>1.1%</b>	<b>0.8%</b>

### **Non-dimensional formulation**

For each ship of the database the linear long-term vertical bending moment has been computed for every section. The maximum VBM over the ship length is taken (this maximum may not occur exactly at 0.5L). The wave coefficient has been computed for the midship section 0.5L only, but is supposed to be the same for all the midpart of the ship, hence for the location of the maximum. The adimensional part of the bending moment is computed by dividing the long-term VBM by the scale parameter  $L^3$ , and by the wave parameter.

For each ship of the database the linear long-term vertical shear force has been computed for every section. The maximum VSF over the aft part of the ship ( $x/L < 0.5$ ) and over the fore part of the ship ( $x/L > 0.5$ ) are taken (these maxima may not occur exactly at 0.25L and 0.75L). Two wave coefficients have been computed at 0.25L and 0.75L. They are supposed to be valid for the location of the aft maximum and the forward maximum respectively. Two non-dimensional vertical shear forces are computed by dividing the long-term VSF by the scale parameter  $L^2$ , and by the wave parameter, for the fore and aft parts.

The adimensional part of the vertical bending moment and the vertical shear forces (aft and fore) are compared with the current UR S11 formulation. For all the ships of the database the ratio between the computed wave value and the rule value is calculated:

- For blunt ships (bulk carriers, tankers and even LNG) the mean value of this ratio is about 1.17 for VBM and 1.60 for VSF: bending moment is slightly underestimated by the rules, whereas shear forces are largely underestimated.
- For slender ships (Containerships, General cargo, Passenger ships and Ro-Ro), the difference is much higher: 1.35 for VBM and 1.90 for VSF

The non-dimensional formulations have been derived to minimise the difference between the linear direct computation results and the formulation. However a compromise has always been chosen between a little more accurate formulation and a more simple formulation (with less coefficients). It is found that both for bending moment and shear force, the waterplane coefficient  $C_W$  and the ratio B/L are the most important parameters. The new formulations for the non-dimensional part are:

$$1.5 C_W \left(\frac{B}{L}\right)^{0.8} \quad \text{for wave bending moment}$$

- 5.2  $C_W \left(\frac{B}{L}\right)^{0.8}$  for wave shear force at aft location
- 4.0  $C_W \left(\frac{B}{L}\right)^{0.8}$  for wave shear force at midship
- 5.7  $C_W \left(\frac{B}{L}\right)^{0.8}$  for wave shear force at fore location

With the new formulation, the mean values of the ratios are equal to 1.0, and the scatters around the mean have been reduced. Again, the accuracy of the formulation has been improved.

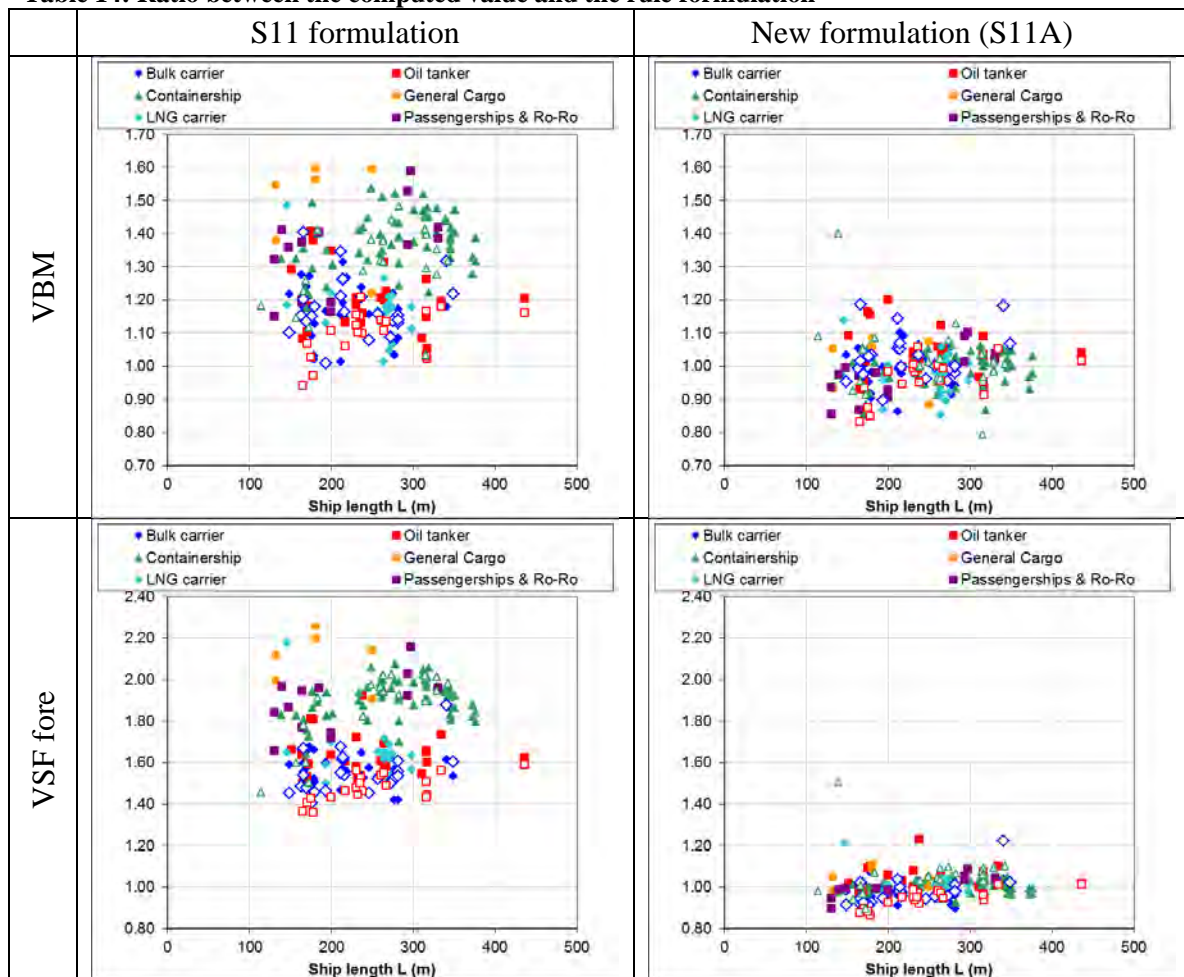
**Table 12: Accuracy of the S11 and S11A formulations for the non-dimensional part (entire database)**

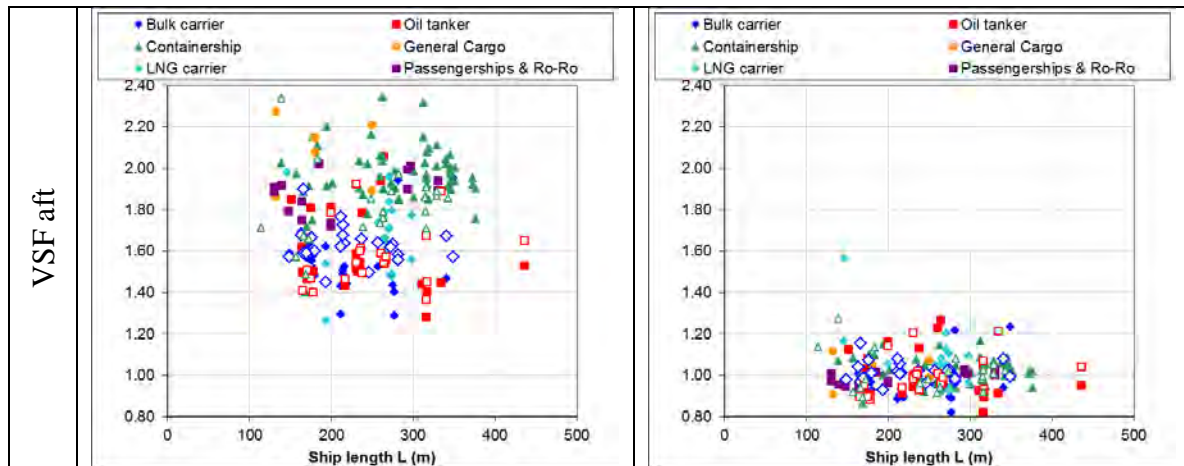
	VBM	VSF aft	VSF fore
UR S11 formulation	11.7%	12.5%	13.5%
UR S11A formulation	7.1%	6.4%	8.9%

**Table 13: Accuracy of the S11 and S11A formulations for the non-dimensional part (containership in full load only)**

	VBM	VSF aft	VSF fore
UR S11 formulation	5.9%	4.7%	7.3%
UR S11A formulation	5.2%	3.3%	6.0%

**Table 14: Ratio between the computed value and the rule formulation**





Because the use of the waterplane coefficient  $C_W$  is new, it has been suggested to propose an approximation, to be used in case this coefficient is not available in the drawings. This approximation is based on the block coefficient, and is valid only for design draft or full load draft. It should not be used for a ballast draft.

$$C_W = C_B + 0.09 \quad \text{for } C_B > 0.73$$

$$C_W = 0.7C_B + 0.4 \quad \text{for } C_B < 0.73$$

For containerships, only the second part of the formulation is to be used, as the block coefficient is always below 0.73. The following figure shows the strong correlation between the block coefficient and the water-plane coefficient that justify the previous approximation:

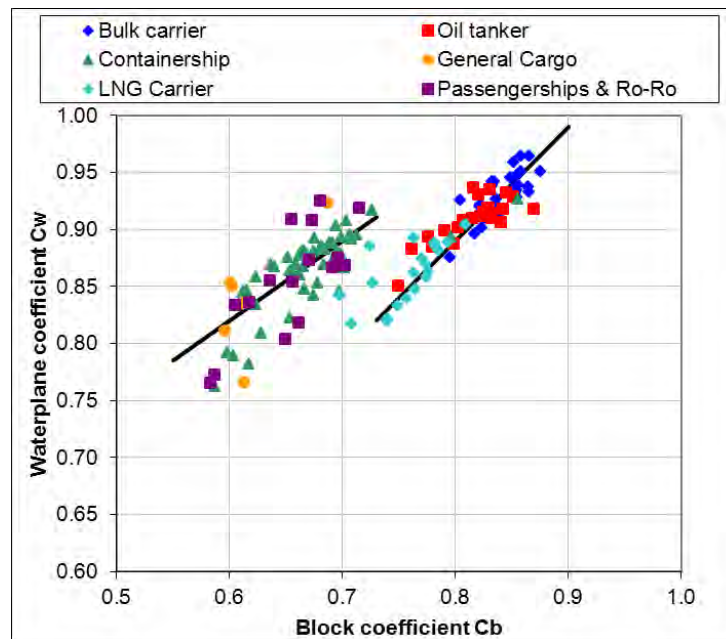


Figure 5: Correlation between the waterplane coefficient and the block coefficient

This formulation has been validated with the 157 ships in full load condition from the common database

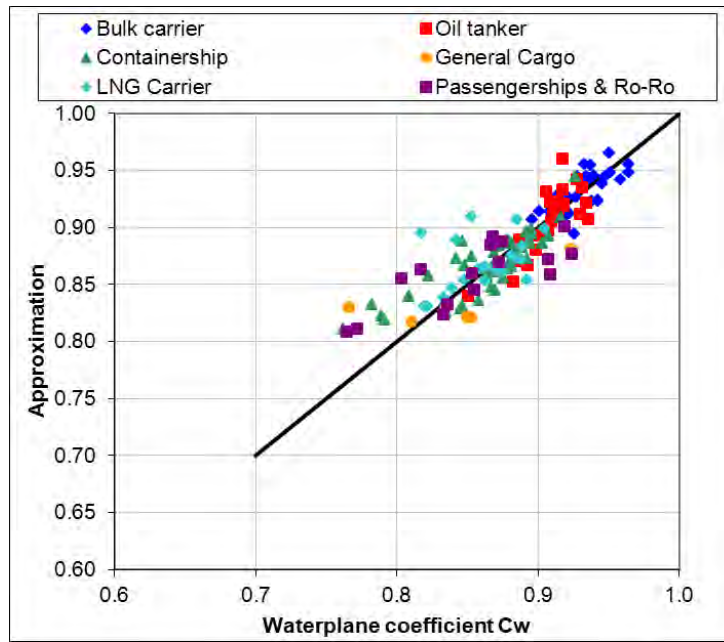


Figure 6: Comparison of the approximation and the exact water-plane coefficient



### Non-linear factors

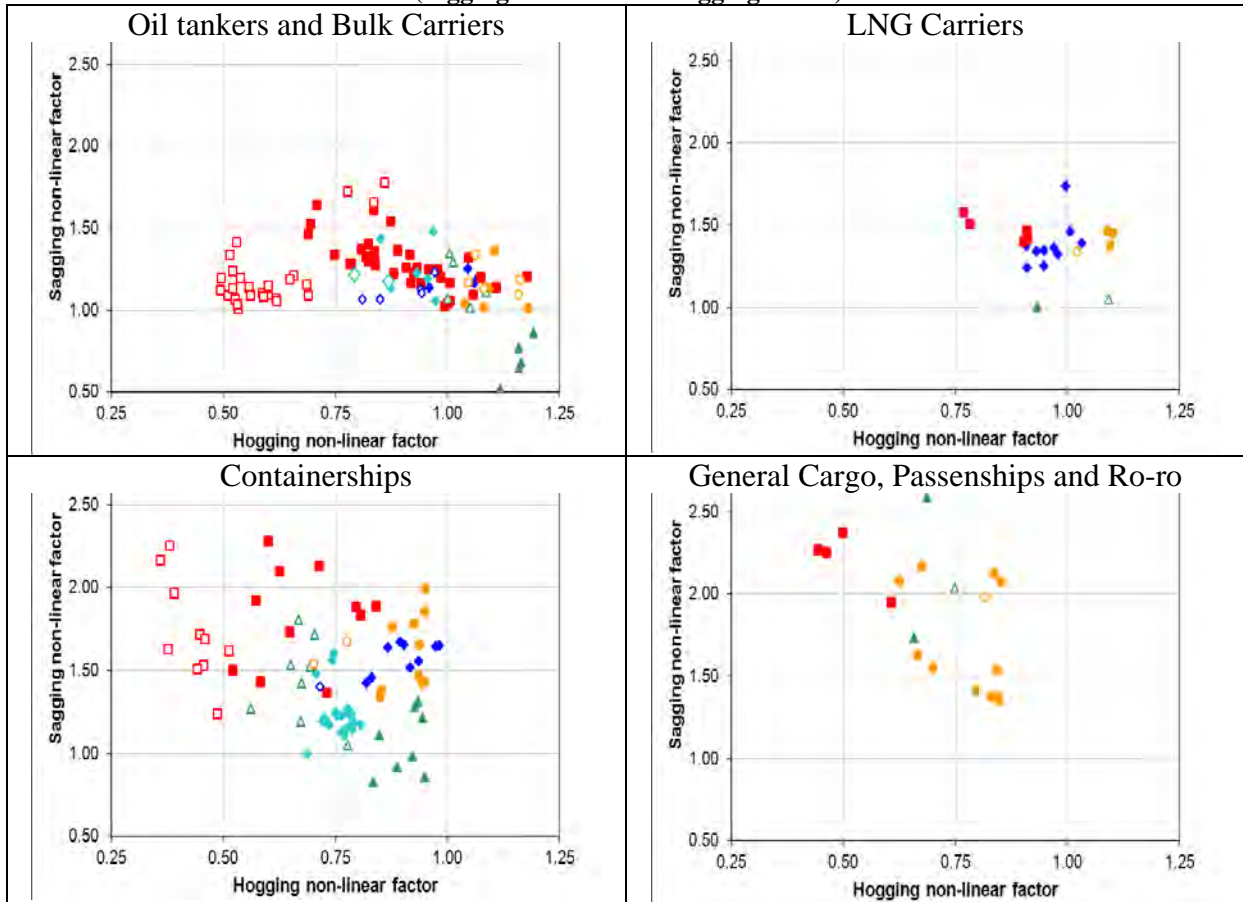
The non-linear coefficients have been computed using non-linear seakeeping software and methods described above. For each ship of the database the non-linear envelope corresponding to the long-term vertical bending moment and shear forces have been computed for every section.

For each ship, 6 characteristic values are taken:

- The maximum vertical bending moment along the ship (hogging)
- The minimum vertical bending moment along the ship (sagging)
- The maximum vertical shear force in the aft part (hogging)
- The minimum vertical shear force in the aft part (sagging)
- The maximum vertical shear force in the fore part (sagging)
- The minimum vertical shear force in the fore part (hogging)

The non-linear factors are computed by dividing the non-linear values by the corresponding linear values. The following graphs are showing the non-linear factors for the vertical bending moment in hogging and sagging.

**Table 15: VBM non-linear factors (sagging factor versus hogging factor)**



Despite a large discrepancy between the different Class Society results, some formulations have been fitted to the results. A bow flare factor has been introduced to characterize the geometry of the hull shape above the waterline in the bow region. This bow flare coefficient is used in the sagging non-linear coefficient.

$$f_{Bow} = \frac{A_{DK} - A_{WL}}{0.2 L z_f}$$

$A_{DK}$  is the deck area in front of  $0.8L$ . It includes the forecastle deck if there is one.  
 $A_{WL}$  is the waterline area in front of  $0.8L$ .  
 $z_f$  is the vertical distance from the waterline to the deck (or forecastle deck).

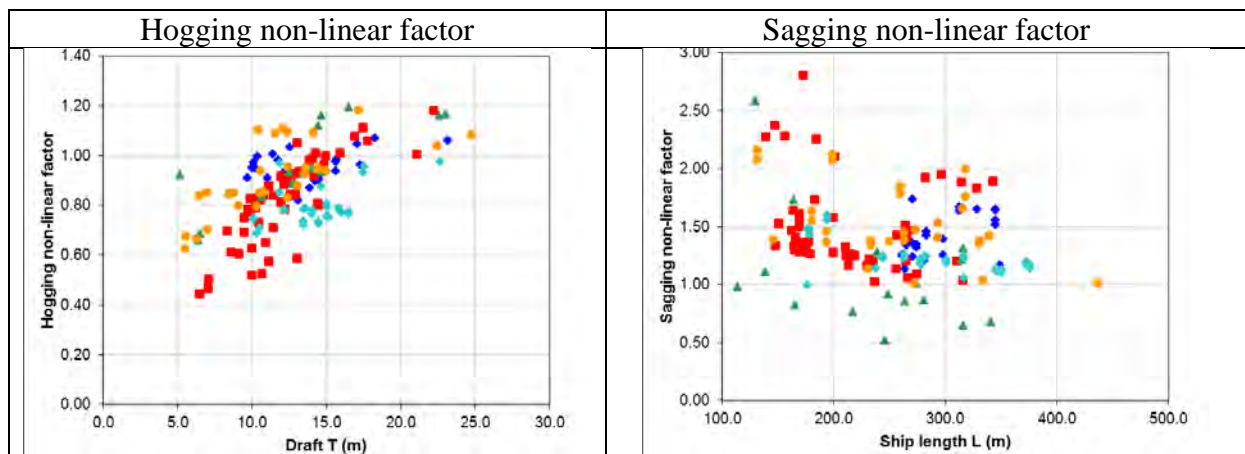
The new formulations for the non-linear factors for vertical bending moment are:

$$f_{NL-Hog} = \text{Min} \left( 0.3 \frac{C_B}{C_W} \sqrt{T}, 1.1 \right)$$

$$f_{NL-Sag} = \text{Max} \left( 4.5 \frac{1 + 0.2f_{Bow}}{C_W \sqrt{C_B} L^{0.3}}, 1.0 \right)$$

The  $C_W$  has been introduced on purpose, to cancel the effect of the  $C_W$  in the linear formulation. It was discussed that in general  $C_W$  has a big variation due to the stern shape and the selected waterline level, hence a designer will be able to reduce the wave VBM by adjusting the hull form shape locally to reduce the  $C_W$  whilst maintaining the displacement and most other resistance performance. This coefficient is however very correlated to the linear results, and is used in the proposed formulation. Introducing the  $C_W$  again in the non-linear factors will cancel the effect on the total VBM, while keeping a good comparison between the linear formulations and the linear calculations.

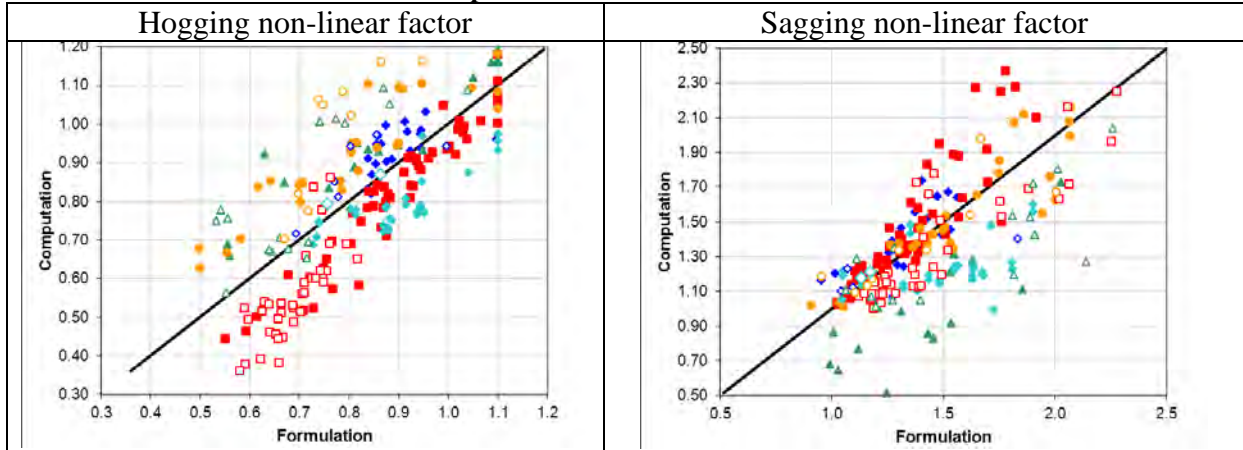
The non-linear coefficients are not dimensionless. Computations results have shown that the amount of non-linearity depends on the ship shape ( $C_W, C_B, f_{Bow}$ ), but also on the ship size. For smaller ships, the design sea states are much more steep and severe relatively to the ship size, than they are for the longer ships. Hence the non-linear effects are more important for smaller ships: lower hogging non-linear factor and higher sagging non-linear factor.



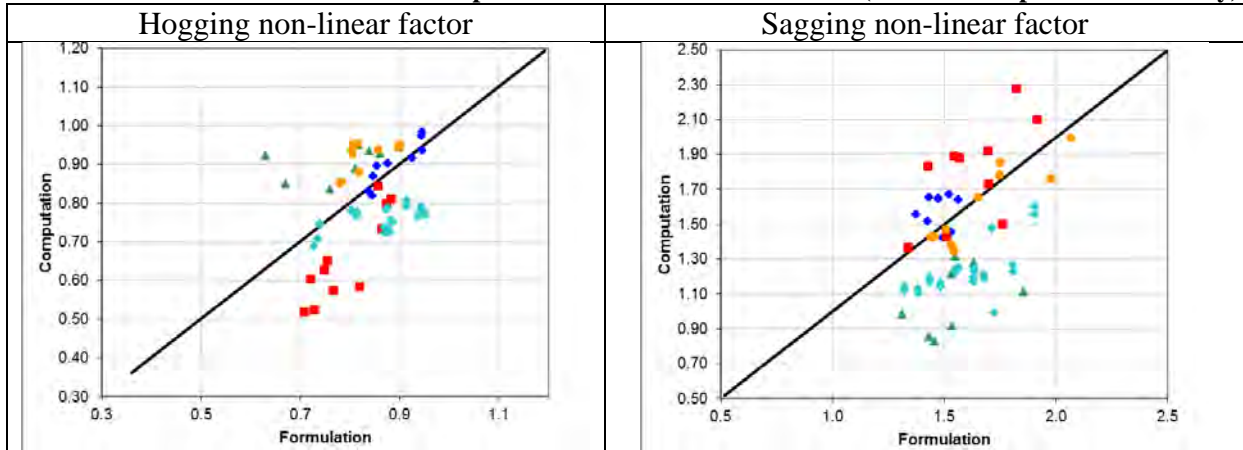
**VBM non-linear factors with respect to ship size (draft or length)**

The following figures show the comparison between the computed non-linear coefficient and the proposed formulations. For each Class Society (represented by one colour), the correlation between the computations and the rule formulation is very clear. The general scatter comes from the difference between the Class Society tools and methods. The rule formulations have been fitted to the average of the results.

**Table 16: VBM non-linear factors: computations versus rule formulation**



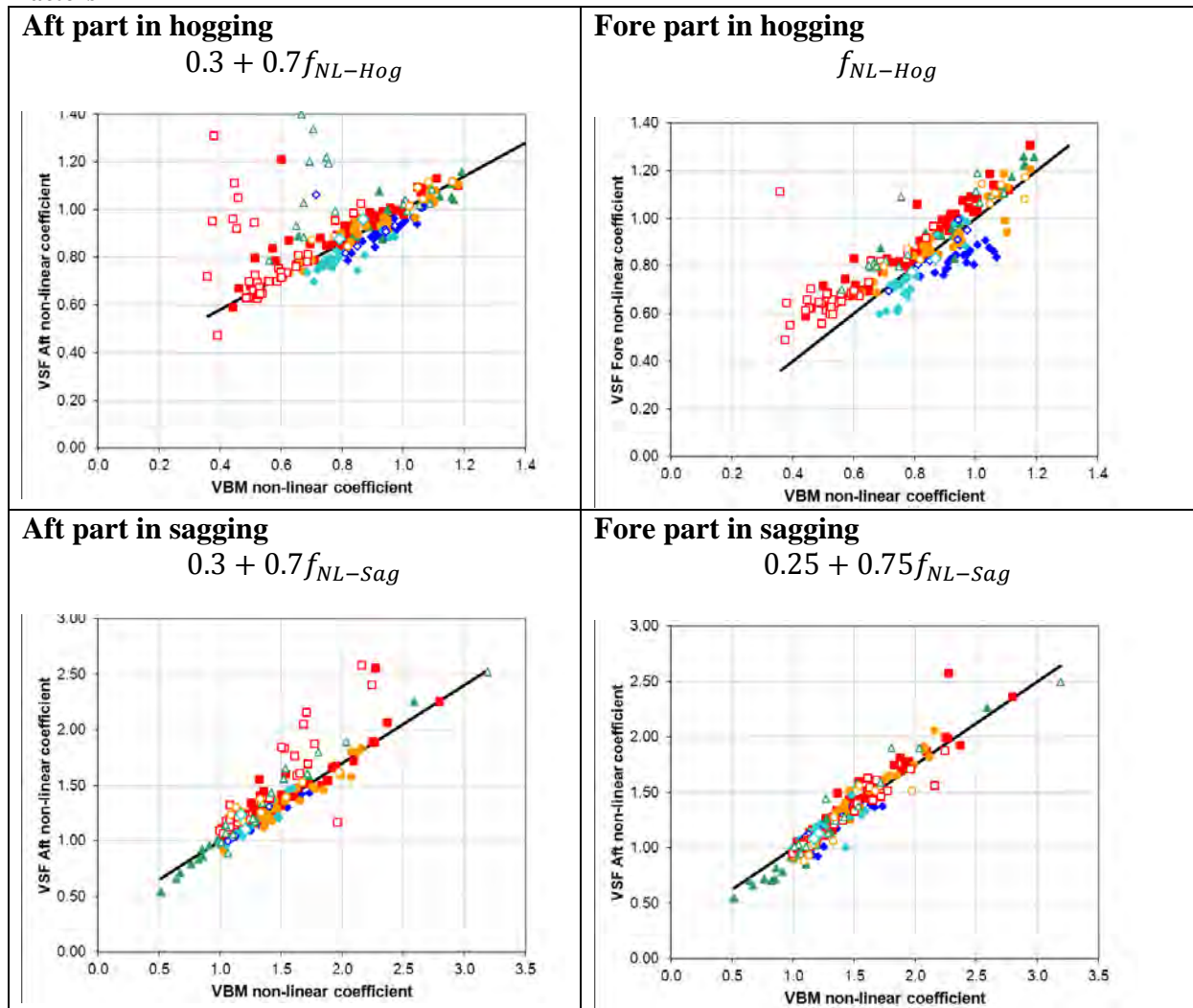
**Table 17: VBM non-linear factors: computations versus rule formulation (Containerships in full load only)**



For vertical shear forces the computations show a very strong correlation with the non-linear factors from the vertical bending moment, as shown in the following figures. Hence the rule formulations are based on the same factors  $f_{NL-Hog}$  and  $f_{NL-Sag}$ .



**Table 18: Correlation between the shear forces non-linear factors and the bending moment non-linear factors**



The accuracy of these new formulations is compared to the accuracy of the S11 non linear factors (assumed to be 1.0 in hogging):

**Table 19: Accuracy of the S11 and S11A formulations for the non-dimensional part (entire database)**

	Hogging			Sagging		
	VBM	VSF aft	VSF fore	VBM	VSF aft	VSF fore
UR S11 formulation	23.2%	14.8%	19.1%	19.0%	18.3%	18.0%
UR S11A formulation	16.7%	14.6%	14.7%	14.3%	14.5%	14.0%

**Table 20: Accuracy of the S11 and S11A formulations for the non-dimensional part (containership in full load only)**

	Hogging			Sagging		
	VBM	VSF aft	VSF fore	VBM	VSF aft	VSF fore
UR S11 formulation	14.4%	10.3%	11.9%	21.7%	20.9%	21.6%
UR S11A formulation	12.8%	12.1%	11.5%	19.7%	18.0%	19.3%

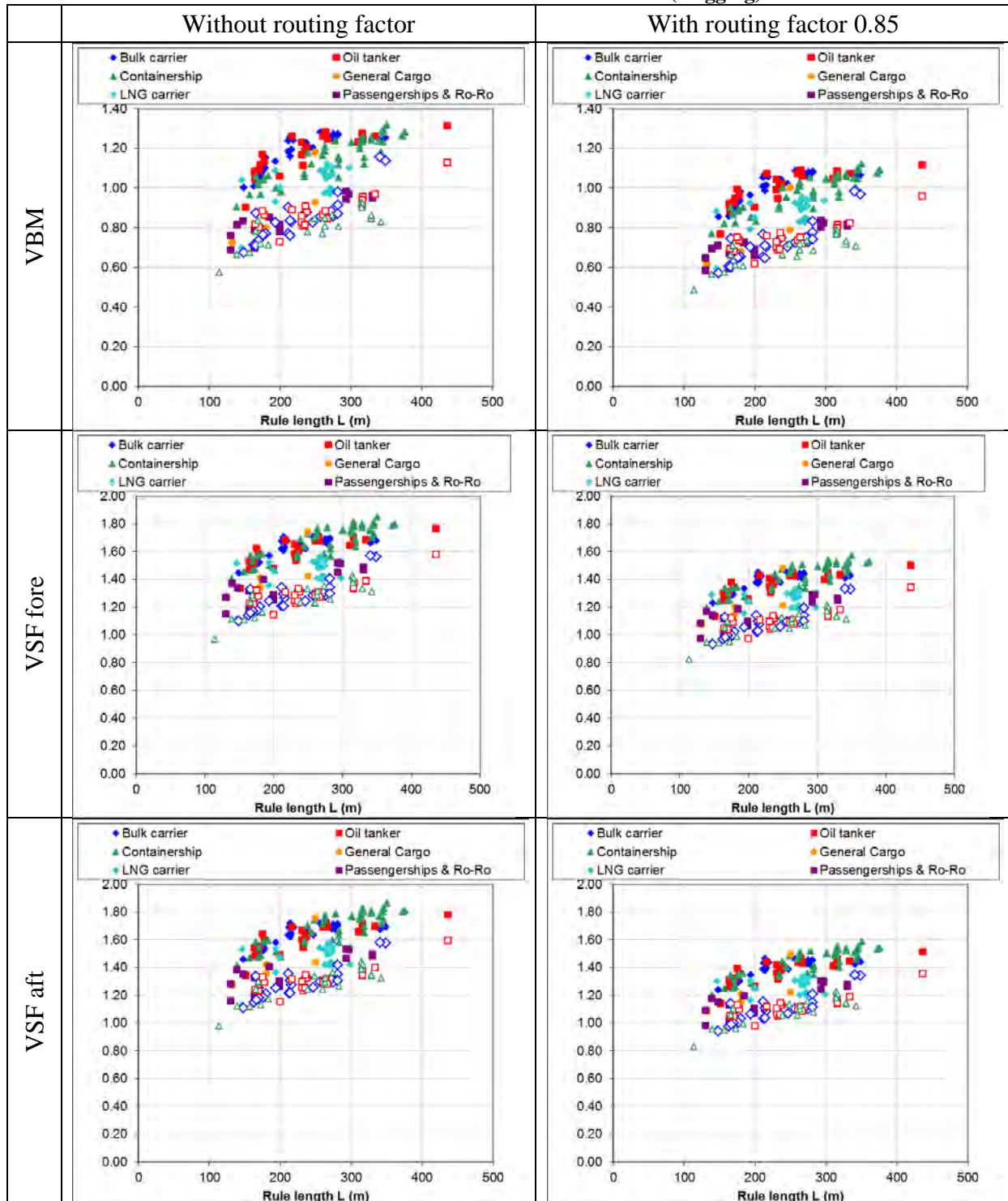
The accuracy have been improved slightly, but it is clear that the accuracy in the nonlinear factor governs the uncertainty compared to the non-dimensional factor and the wave parameter.

## Routing factor

The comparison of the new formulations with the current S11 formulations shows an increase of all the loads, even for the blunt ships (Oil Tankers and Bulk Carriers). It has been decided to introduce a calibration coefficient, called routing factor, to lower the design loads. This coefficient has been calibrated to  $f_R = 0.85$ , so that the hogging vertical bending moment is not changed for the blunt ships (small increase for ships longer than 200m, and small decrease for ships smaller than 200m).

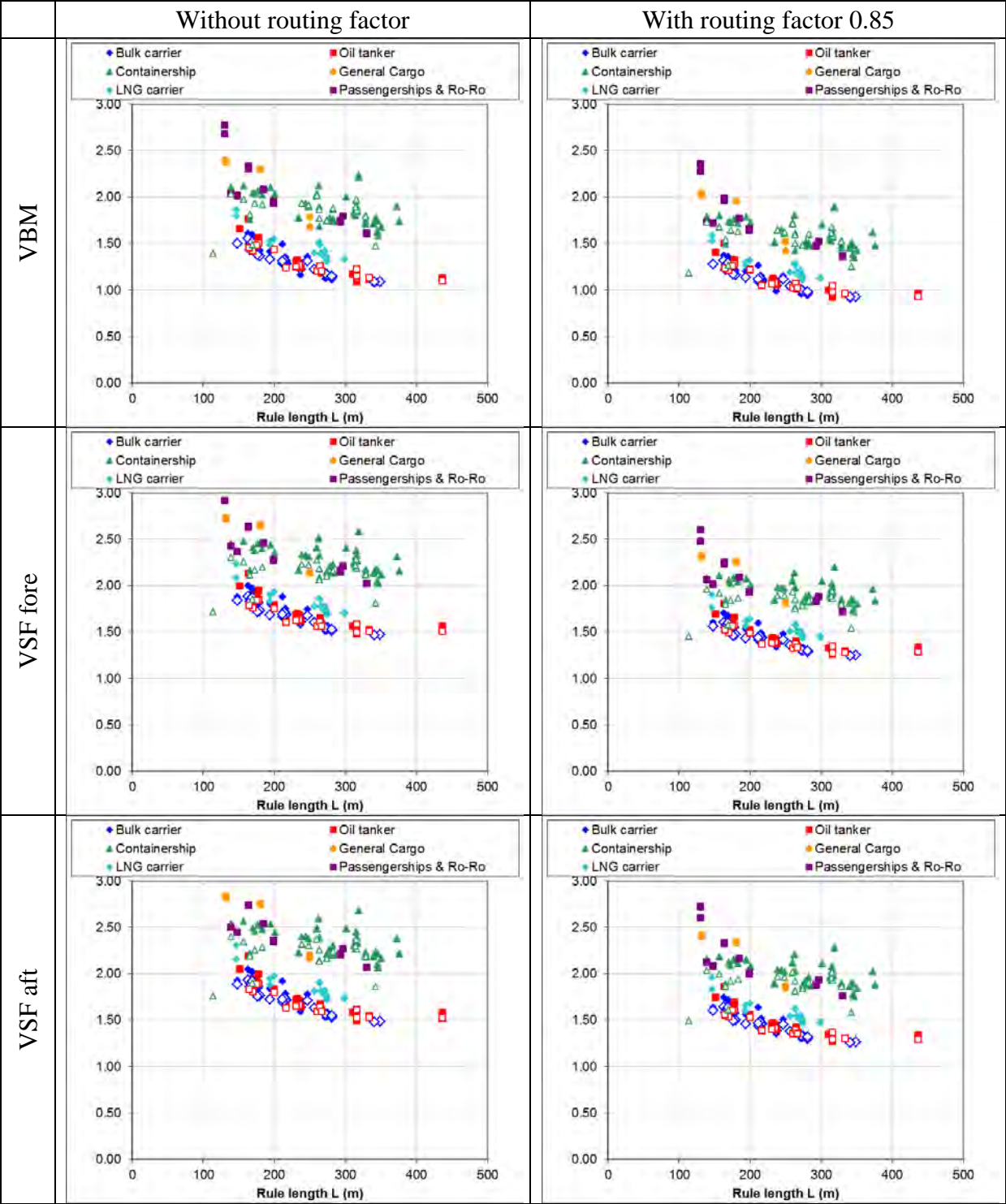
For the Container ships in full load condition, the hogging vertical bending moment is decreased for ships smaller than 300m. The hogging shear force however is still increased by 20% to 60%.

**Table 21: Ratio between the new formulation and the S11 formulation (Hogging)**



Concerning the sagging case, despite this routing factor, the vertical bending moment is increased by 40% to 90% for the Container ships, and the vertical shear forces are increased by 70% to 130%.

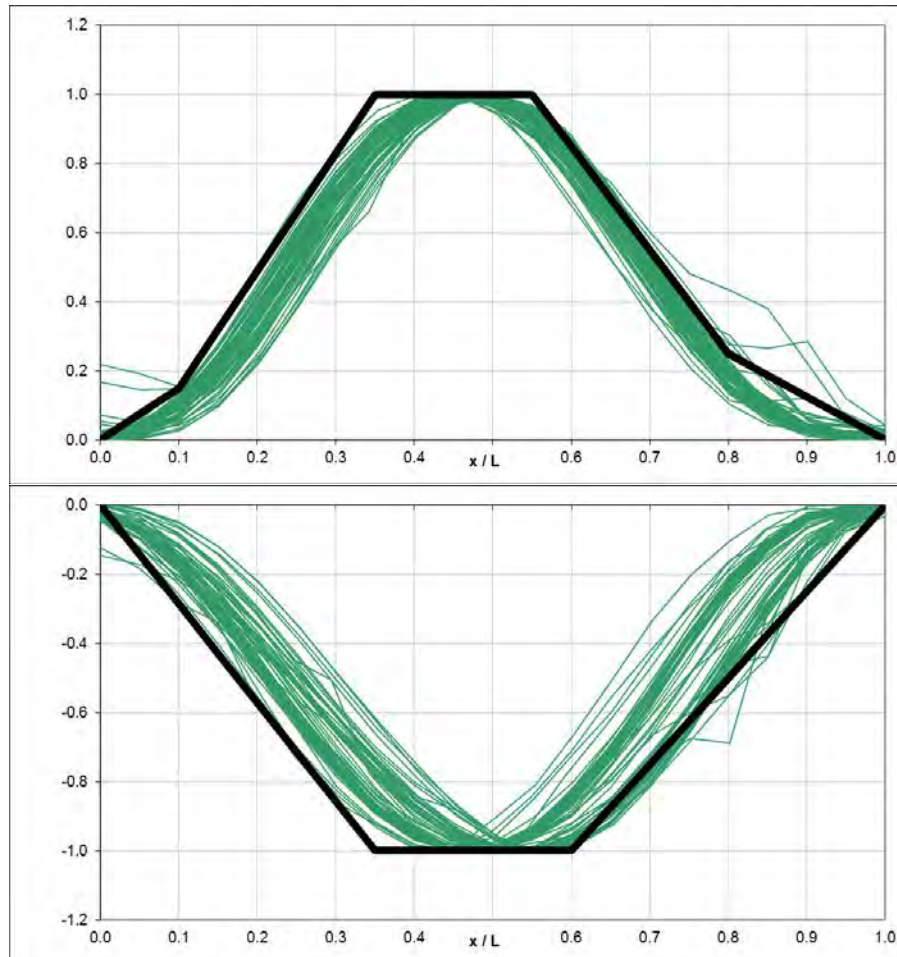
**Table 22: Ratio between the new formulation and the S11 formulation (Sagging)**



This routing factor is a pure empirical factor. There is no strong justification except a partial tuning with the S11 loads. However it could be qualitatively explained by the operating conditions: it corresponds to a decrease of 15% of the highest significant wave heights in the North Atlantic scatter diagram that might be explained by weather avoidance capabilities, considering the increased accuracy of weather forecast.

### Distribution function

The distribution functions for vertical bending moment and vertical shear forces have been fitted directly to non-linear results for containerships. These functions are specific to containerships because, contrary to what has been done for the previous loads formulations where all the ship from the database have been taken into account, only the containerships have been used to fit the distribution function. The comparison between the computations and the proposed formulation is given in the following figures:



**Figure 7: Vertical Bending Moment Distribution Function (hogging upper plot and sagging lower plot)**

The following figures show the distribution functions for the vertical shear forces. The forward half and the aft half of the ships are presented separately as the results have been made dimensionless with the Fore shear force and Aft shear force respectively.



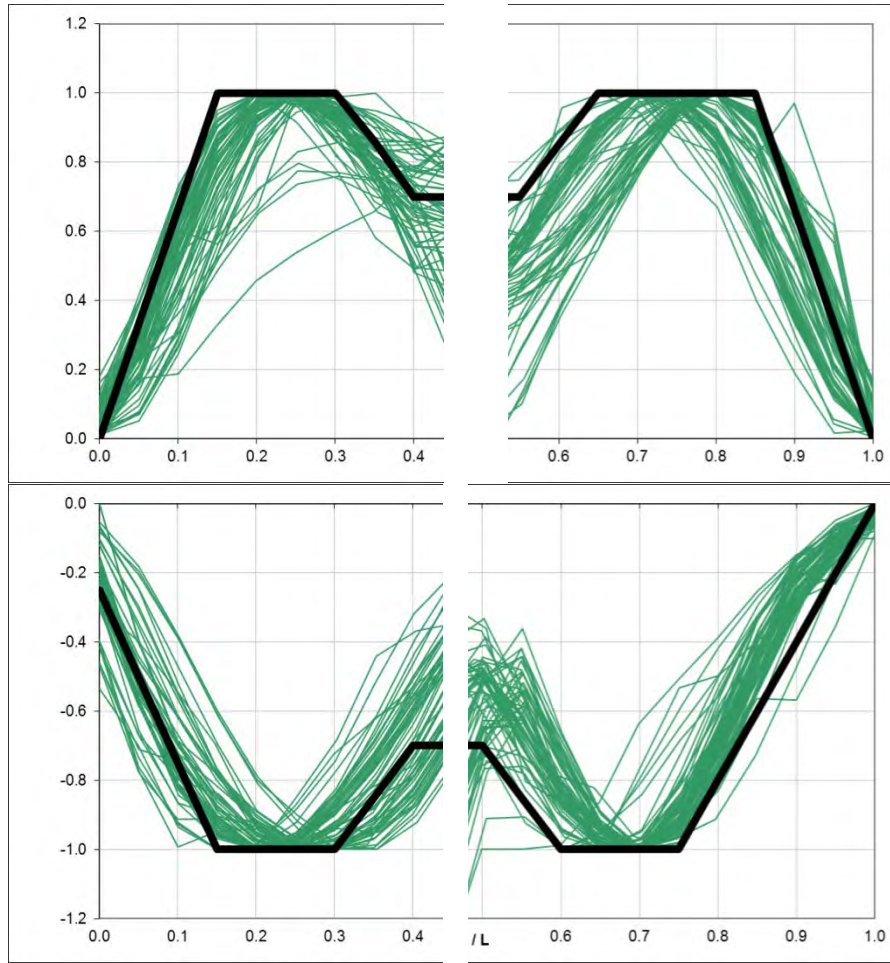


Figure 8: Vertical Shear Force Distribution Function

### Final formulation

All the new formulations for vertical bending moment and shear forces are summarized here:

### Wave parameter

$$C = 1 - 1.50 \left( 1 - \sqrt{\frac{L}{L_{ref}}} \right)^{2.2} \quad \text{for } L \leq L_{ref}$$

$$C = 1 - 0.45 \left( \sqrt{\frac{L}{L_{ref}}} - 1 \right)^{1.7} \quad \text{for } L > L_{ref}$$

$$L_{ref} = 315 C_W^{-1.3}$$

### Vertical bending moment

$$M_{W-Hog} = +1.5 f_R L^3 C C_W \left( \frac{B}{L} \right)^{0.8} f_{NL-Hog}$$

$$M_{W-Sag} = -1.5 f_R L^3 C C_W \left( \frac{B}{L} \right)^{0.8} f_{NL-Sag}$$

$$f_{NL-Hog} = 0.3 \frac{C_B}{C_W} \sqrt{T}, \quad \text{not to be taken greater than 1.1}$$

$$f_{NL-Sag} = 4.5 \frac{1+0.2f_{Bow}}{C_W \sqrt{C_{BL}^{0.3}}}, \quad \text{not to be taken less than 1.0}$$

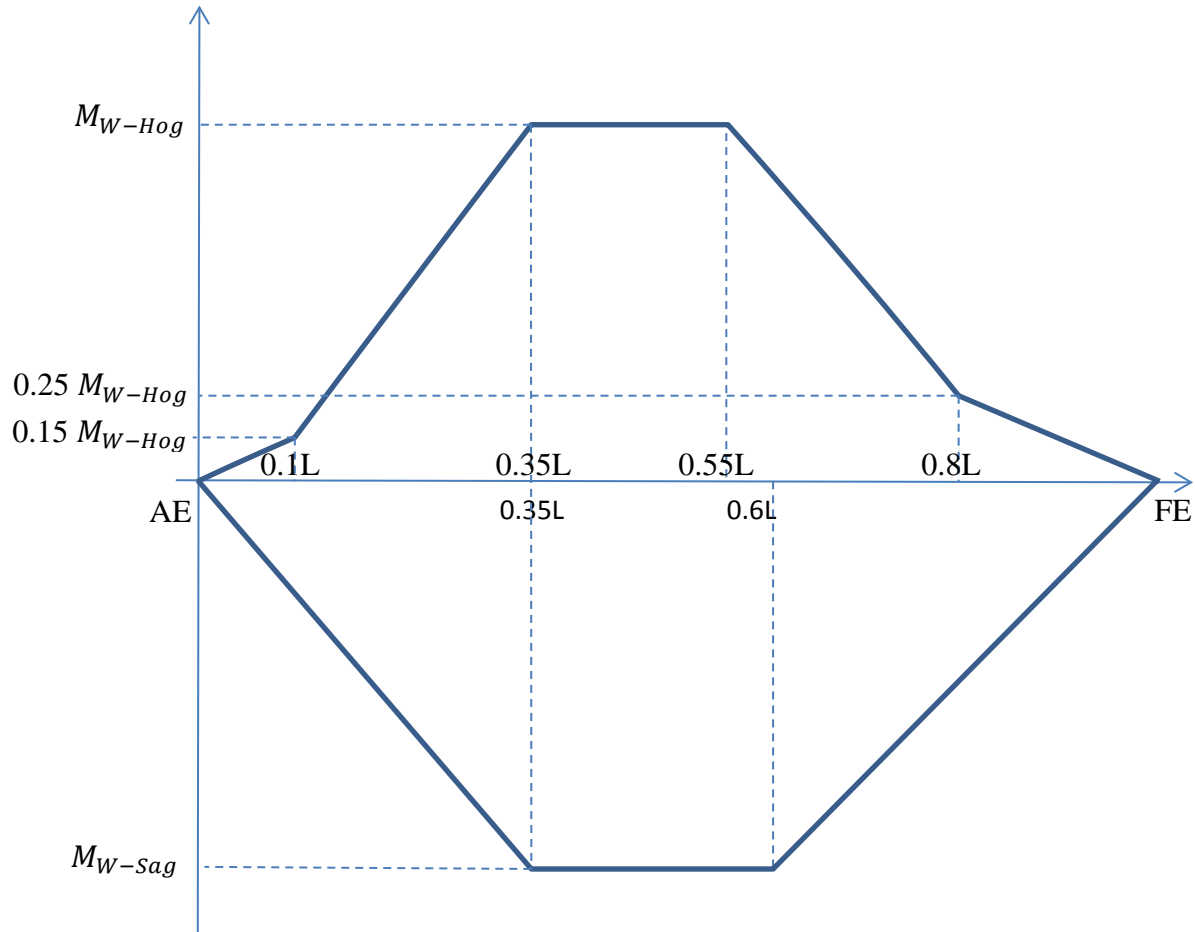
$$f_{Bow} = \frac{A_{DK} - A_{WL}}{0.2 L z_f}$$

$A_{DK}$  is the deck area in front of  $0.8L$ . It includes the forecastle deck if there is one.

$A_{WL}$  is the waterline area in front of  $0.8L$ .

$z_f$  is the vertical distance from the waterline to the deck (or forecastle deck).

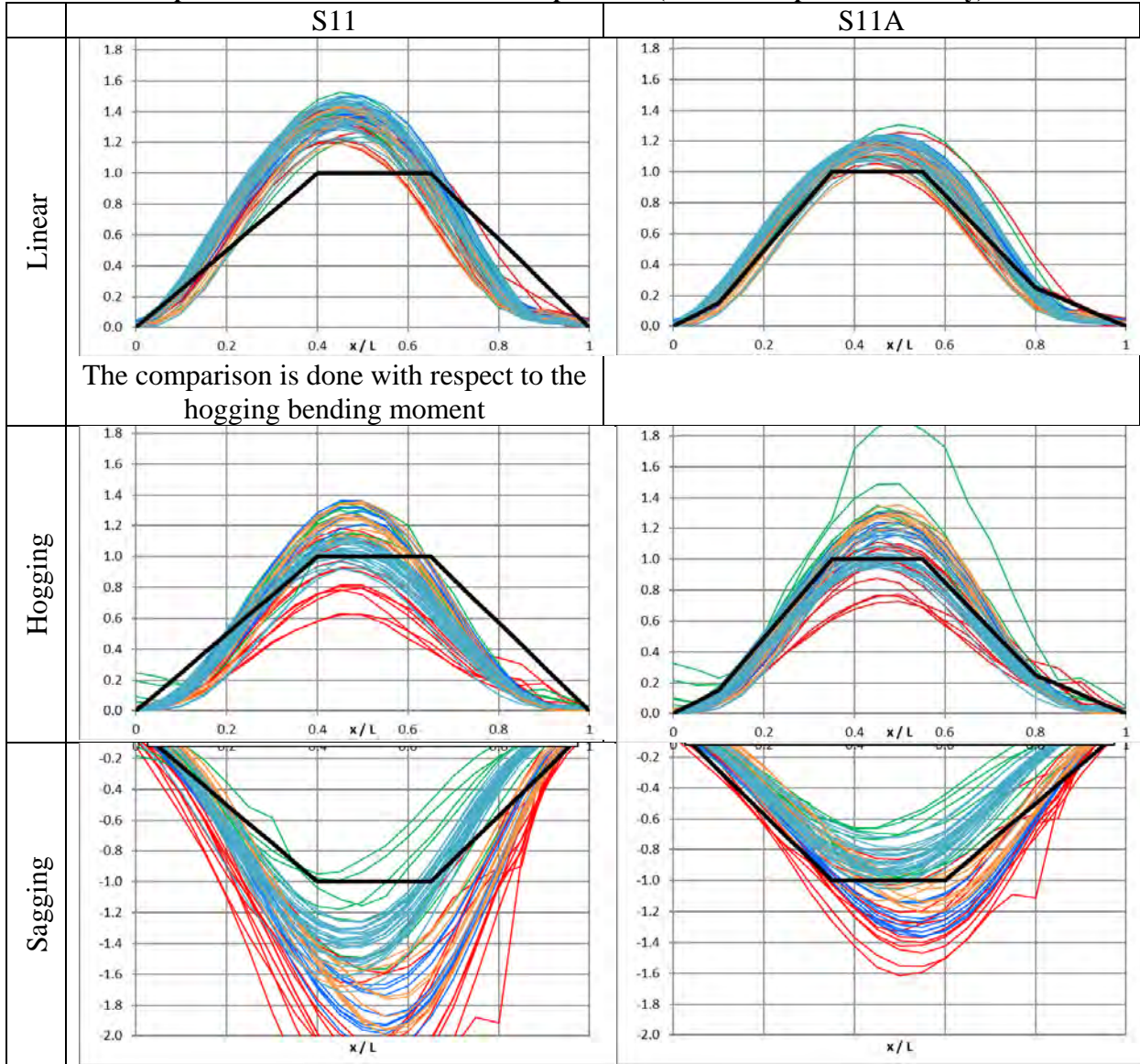
$$f_R = 0.85$$



**Figure 9: Distribution of the vertical wave bending moment**

The comparison of the final formulations is done on the following figures. The linear and non-linear long-term bending moment distribution has been made non-dimensional by dividing by the rule bending moment amidship. The comparison is done only on containerships in full load. The routing coefficient 0.85 is used in S11A formulations, which explains that in average the computations are higher than the rules.

**Table 23: Comparison of rule formulation and computations (containership in full load only)**



**Vertical shear force**

$$L_{ref} = 330 C_W^{-1.3} \quad \text{for wave shear force}$$

$$FW_{Hog}^{Aft} = +5.2 f_R L^2 C C_W \left(\frac{B}{L}\right)^{0.8} (0.3 + 0.7 f_{NL-Hog})$$

$$FW_{Hog}^{Fore} = -5.7 f_R L^2 C C_W \left(\frac{B}{L}\right)^{0.8} f_{NL-Hog}$$

$$FW_{Sag}^{Aft} = -5.2 f_R L^2 C C_W \left(\frac{B}{L}\right)^{0.8} (0.3 + 0.7 f_{NL-Sag})$$

$$FW_{Sag}^{Fore} = +5.7 f_R L^2 C C_W \left(\frac{B}{L}\right)^{0.8} (0.25 + 0.75 f_{NL-Sag})$$

$$FW^{Mid} = +4.0 f_R L^2 C C_W \left(\frac{B}{L}\right)^{0.8}$$

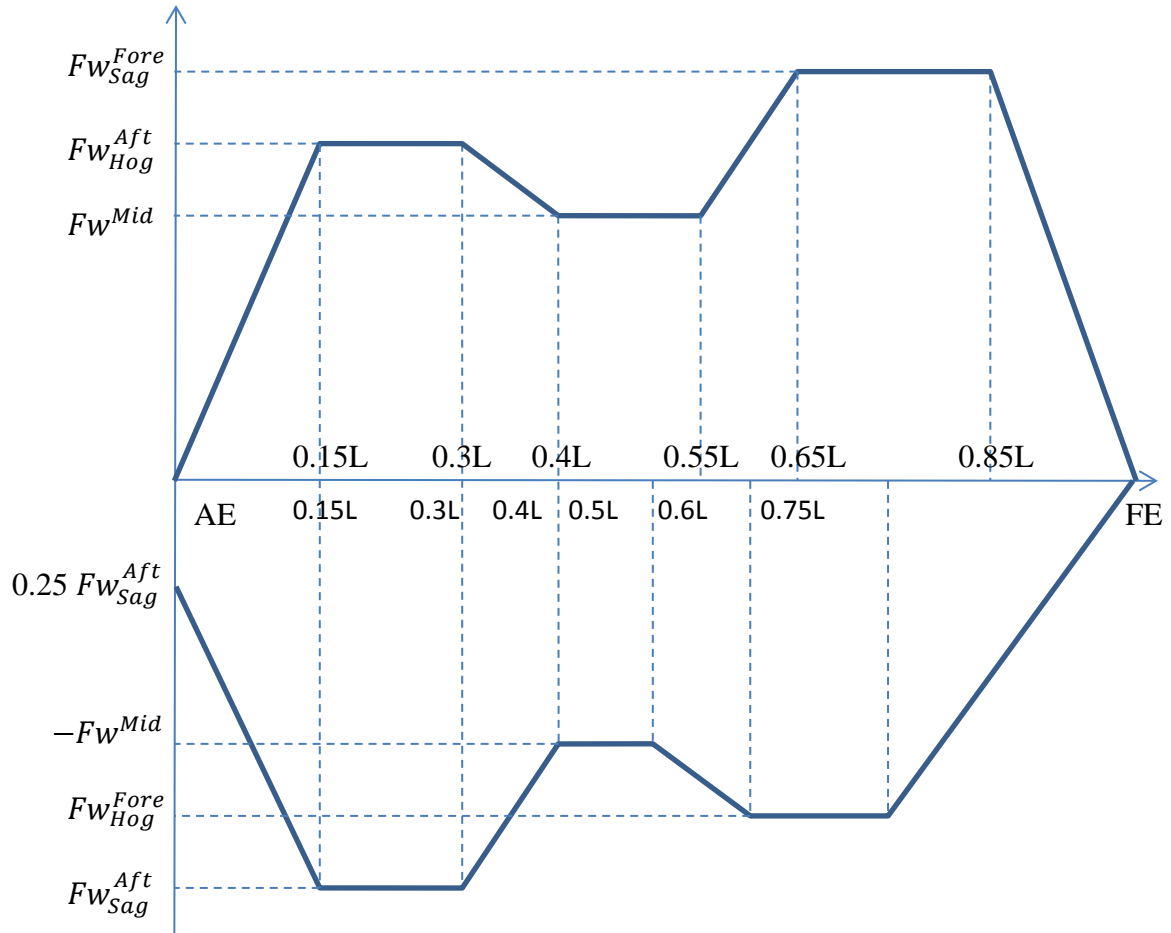


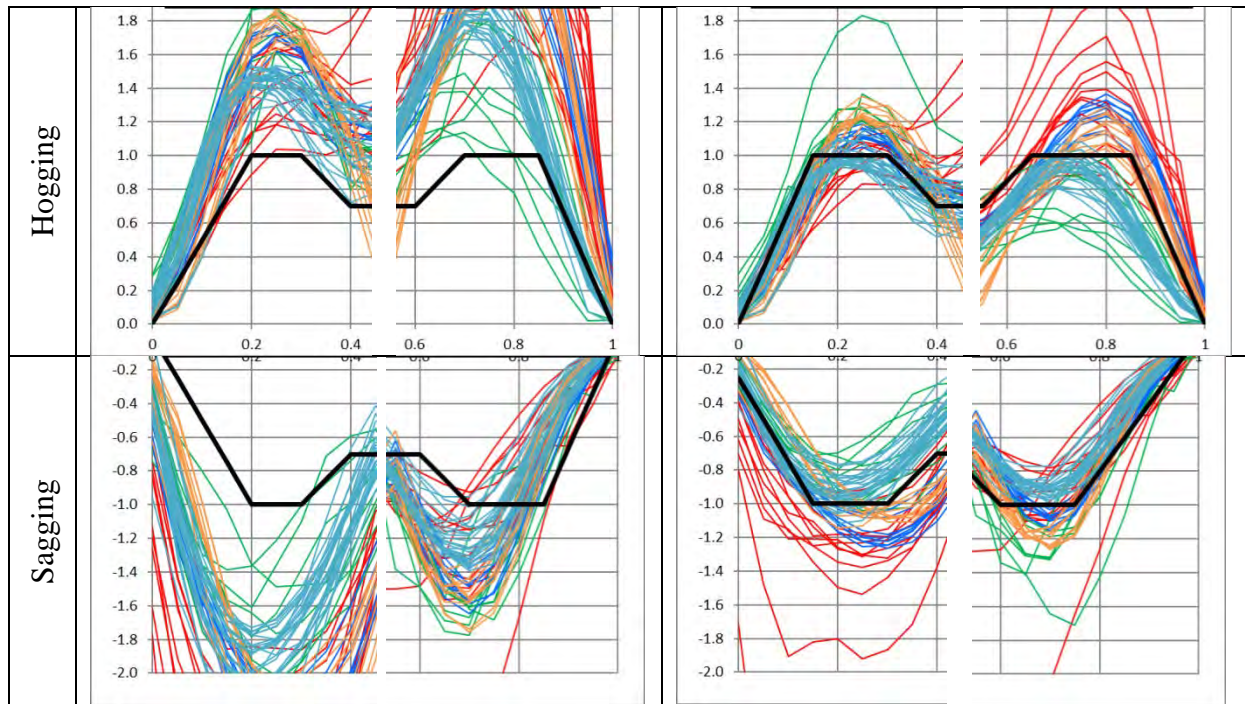
Figure 10: Distribution of the vertical wave shear force

The comparison of the final formulations is done on the following figures. The linear and non-linear long-term shear force distribution has been made non-dimensional by dividing by the rule shear force in the fore part and in the aft part separately. The comparison is done only on containerships in full load. The routing coefficient 0.85 is used in S11A formulations, which explains that in average the computations are higher than the rules.

Table 24: Comparison of rule formulation and computations (containership in full load only)

	S11	S11A
Linear		
	The comparison is done with respect to the hogging shear force	





### TB S11A.3 Strength Assessment

#### TB S11A.3.2 Stiffness criterion

The S11 bending strength assessment specifies a minimum moment of inertia of the midship section:

$$I_{Min} = 3CL^3B(C_B + 0.7) \quad (cm^4)$$

No technical background has been found to explain the meaning of this criterion, and hence how it should be updated due to the change in the bending moment formulations. A tentative interpretation is done and a new formulation is proposed. It is found that the minimum inertia criterion is equivalent to a maximum curvature radius.

In 1965 this minimum moment of inertia did not exist in the Bureau Veritas rules, but there was a criterion on the depth of the hull:

- For standard steel ships, the depth is to be greater than  $L/16$  :  $D > \frac{L}{16}$
- A ship made with higher tensile (HT) steel should not have a higher deflection than a corresponding ship in standard steel for which  $D = \frac{L}{16}$

Hence the criteria was on the deflection (or curvature) of a ship with the characteristics  $D=L/16$ .

Looking at the relation between the moment of inertia, the section modulus and the distance from the neutral axis, we can write:

$$I = Z_{Deck} (z_{Deck} - z_{Neutral}) = Z_{Bottom} (z_{Neutral} - z_{Bottom})$$

The minimum distance from the neutral axis to the deck or to the bottom is equal to  $D/2$ . Moreover a minimum section modulus is specified in UR S7 and in UR S11. Hence, we can write:

$$I > Z_{min} \frac{D}{2} > Z_{min} \frac{L}{32} \approx Z_{min} 0.03L$$

The formulation given in UR S7 (with material factor  $k=1$ ) is (in SI units):

$$Z_{min} = CL^2 B(C_B + 0.7)10^{-6}$$

From this we can compute the corresponding minimum moment of inertia, and we find the expression given in S11 with material factor  $k=1$ .

$$I > 3CL^3 B(C_B + 0.7)10^{-8}$$

The deflection of the hull girder submitted to a given bending moment  $M$  can be characterized by its radius of curvature  $R = \frac{EI}{M}$ ,  $E$  being the Young modulus of steel. If we consider the sagging bending moment from S11, the corresponding minimum radius of curvature is:

$$R = \frac{EI}{|M_{Sag}|} > 56.2 L$$

**Conclusion 1:** The S11 formulation for the minimum moment of inertia is consistent with the S7 formulation of the minimum section modulus and the initial BV criterion  $D > \frac{L}{16}$ . It corresponds to a maximum deflection of the hull girder due to the wave sagging bending moment, characterized by a minimum radius of curvature equal to  $56.2 L$ . The deflection due to the total bending moment is however not a constant as it depends on the amount of still water bending moment.

However the S11 gives another formulation of the minimum section modulus, depending on the total bending moment (still water + wave):

$$Z > \frac{|M_S + M_W|}{175} 10^{-6}$$

From this expression we can compute the corresponding minimum moment of inertia:

$$I > 17.1 L |M_S + M_W| 10^{-11}$$

This formulation is different from the actual S11 minimum moment of inertia, but is more consistent as it takes into account the S11 minimum section modulus and the total applied bending moment. The radius of curvature at the midship section can be computed from the inertia and the total applied bending moment (still water + wave):

$$R = \frac{EI}{|M_S + M_W|} > 35.3 L$$

**Conclusion 2:** This reformulation of the minimum moment of inertia is corresponding to a minimum radius of curvature at the midship section for the total bending moment (still water + wave). This formulation applies to all HT steels as the maximum authorized deflection should not depend on the steel type.

To take into account the net scantling approach a reduction of the permissible radius of curvature is proposed.

$$R = \frac{EI}{|M_S + M_W|} > 32 L$$

Another way to present this criteria is to propose a minimum net moment of inertia:

$$I > 1.55L|M_S + M_W| 10^{-7} \quad [m^4]$$

This equation is directly derived from the previous one using  $E = 2.06 \cdot 10^5 \text{ N/mm}^2$   
 This criterion is now used in the S11A.3.2

### TB S11A.3.3 Yield strength assessment

In the current S11, the yielding strength assessment is divided in a bending strength (section modulus, moment of inertia) and a shearing strength (minimum thickness). It is proposed here to have a unified approach with two load combinations, and to express the criteria in term of Von-Mises stress.

In the S11 the bending stress criterion is a minimum section modulus. Corrosion is not taken into account.

$$Z > \frac{|M_S + M_W|}{175/k}$$

In the CSR the bending strength criterion is formulated with a maximum allowed normal bending stress. The computations are done using the net-scantling approach as defined in CSR.

$$\frac{|M_S + M_W|}{Z} < 190/k$$

For the shearing strength a minimum thickness of the structural members carrying most of the shear force (shell and effective longitudinal bulkheads) is specified in S11. Corrosion is not taken into account. For ships without effective longitudinal bulkheads, the formulation is:

$$t > \frac{0.5|F_S + F_W| S}{110/k \cdot l}$$

For ships with two effective longitudinal bulkheads the formulation is different but the principle is the same.

For the shearing strength the CSR formulation is a maximum allowed shear force based on a shear flow calculation of the cross section under consideration and applying the net-scantling approach of CSR.

$$|F_S + F_W| < Q_R = \min_i \left( \frac{120/k}{q_{vi}/t_i} \right)$$

Due to the net scantling approach the allowable stress in CSR was increased from 175/k to 190/k for the bending check, and from 110/k to 120/k for the shear stress.

In the proposed formulation two load combinations are considered, see S11A3.3.2 and S11A.3.3.3:

- 100% bending and 0% shear. This load combination corresponds to the actual bending strength assessment
- 100% shear and 0% bending. This load combination corresponds to the actual shearing strength assessment

The reason for splitting the two checks is that the deck and bottom (horizontal material) is considered to carry the bending moment, while the side and inner side (vertical material) is considered to carry the shear force, when the hull girder is considered as a beam.

The resulting Von-Mises stress (S11A.3.3.1) is computed by the hull girder stress determined according to S11A.2.5:

$$\sigma_{HG} = \frac{\gamma_S M_S + \gamma_W M_W}{I_{net}} (z - z_n) 10^{-3}$$

$$\tau_{HG} = \frac{\gamma_S F_S + \gamma_W F_W}{t_{net}/q_v}$$

$$\sigma_{eq} = \sqrt{\sigma_x^2 + 3\tau^2}$$

where for the bending strength assessment:

$$\sigma_x = \sigma_{HG}$$

$$\tau = 0$$

and for the shear strength assessment:

$$\sigma_x = 0$$

$$\tau = \tau_{HG}$$

The yielding criterion is expressed in terms of permissible stress, including partial safety factors. It makes more sense to compare the stress to the specified minimum yield stress  $R_{eH}$ , including some partial safety factors, than to a value defined as  $190/k$  (the intention with the former stress criterion is to leave some stress to other load components than the vertical hull girder loads considered). That is why the partial safety factor  $\gamma_1$  has been introduced.

$$\sigma_{VM} < \frac{R_{eH}}{\gamma_1 \gamma_2}$$

- $R_{eH}$ : specified minimum yield stress
- $\gamma_1$ : partial safety factor for high tensile steels  $\gamma_1 = k \frac{R_{eH}}{235}$

Specified minimum yield stress $R_{eH}$	235	315	355	390	390	460
K	1.00	0.78	0.72	0.68	0.66	0.62
$\gamma_1$	1.00	1.05	1.09	1.13	1.10	1.21

- $\gamma_2$ : partial safety factor to take into account the other loads that are neglected
  - for pure bending case:  $\gamma_2 = 1.24$
  - for pure shear case:  $\gamma_2 = 1.13$

This approach is consistent with the yielding check applied to the FE Analysis in CSR, where a Von-Mises stress is computed for each load case (Equivalent Design Wave), and compared to the  $R_{eH}$  with appropriate safety factors.

## TB S11A.4 Buckling strength

### General

The buckling strength assessment of the new UR S11A is based on the prescriptive buckling requirements developed for the IACS Common Structural Rules for Bulk Carriers and Oil Tankers (refer to the CSR Pt1, Ch08, Sec03). Background information to the general

approach is therefore given in the technical background documentation of the CSR, available via the IACS web-site.

### Changes compared to CSR formulation

The changes compared to the CSR formulations are caused by the following to issues:

- The UR S11A is applicable for container ships only.
- The new UR S11A provides only longitudinal hull girder stresses caused by vertical bending moment and shear stresses caused by vertical shear forces.
- The structural components checked by the buckling assessment according to UR S11A are basically plates, stiffeners and stiffened panels. Struts, Pillars and transverse primary members etc. are not in scope of UR S11A.

Based on the list above the requirements developed for the CSR were simplified as follows:

#### *Allowable Utilisation Factor (UR S11A.4.2)*

Because only plates, stiffeners and stiffened panels under seagoing conditions are checked according to the UR S11A requirements, the allowable buckling utilisation factor  $\eta_{all}$  is set to 1.0 according to IACS CSR Pt.1, Ch08, Sec01, Table 1. Therefore the buckling acceptance criterion was generalised and simplified to:

$$\eta_{act} \leq 1$$

Where  $\eta_{act}$  is the maximum buckling utilisation factor as calculated according to the UR S11A requirements.

#### *Interaction formulaes (plate limit state) (UR S11A, Annex 2, [2.1.1] and [2.2])*

Because UR S11A is applicable for container ships only the partial safety factor S as defined in IACS CSR Pt.1, Ch08, Sec05 can be set to 1.0 and is therefore deleted from the interaction equations in the UR S11A. Furthermore only the normal stress in longitudinal direction of the ship hull and the shear stresses are defined according to UR S11A. This yields to a constant coefficient  $e_0$  according to IACS CSR Pt.1, Ch08, Sec05 Table1 of  $2/\beta_p^{0.25}$ . Therefore the interaction equation for plates can be simplified for longitudinal and transverse stiffening arrangement as follows:

a) Longitudinal stiffening arrangement:

$$\left(\frac{\gamma_c \sigma_x}{\sigma_{cx}}\right)^{2/\beta_p^{0.25}} + \left(\frac{\gamma_c |\tau|}{\tau_c}\right)^{2/\beta_p^{0.25}} = 1$$

b) Transverse stiffening arrangement:

$$\left(\frac{\gamma_c \sigma_y}{\sigma_{cy}}\right)^{2/\beta_p^{0.25}} + \left(\frac{\gamma_c |\tau|}{\tau_c}\right)^{2/\beta_p^{0.25}} = 1$$

Even for curved plate panels only axial stresses can be considered following the UR S11A requirements. Therefore the buckling cases in IACS CSR Pt1, Ch08, Sec05, Table 4 can be reduced to two cases and the interaction formulae is simplified to:

$$\left(\frac{\gamma_c \sigma_{ax}}{C_{ax} R_{eH_P}}\right)^{1.25} + \left(\frac{\gamma_c \tau \sqrt{3}}{C_\tau R_{eH_P}}\right)^2 = 1.0$$

#### *Ultimate critical buckling stresses (UR S11A, Annex 2, [2.1.3])*

The determination of the ultimate critical buckling stresses is defined in IACS CSR Pt.1, Ch08, Sec05 [2.2.3]. The reduction factors  $C_x$ ,  $C_y$  and  $C_\tau$  as defined in IACS CSR Pt.1, Ch08,

Sec05, table 3, have to be calculated considering the factor  $c_1$ , which is dependent from the stress state and the method of buckling assessment (method A and B) in the IACS CSR. Considering the scope of S11A factor  $c_1$  will become in any case:

$$c_1 = \left(1 - \frac{1}{\alpha}\right) \geq 0$$

This value is directly included in UR S11 A, Annex 2, Table 2 for the buckling case 2.

*Correction factors  $F_{trans}$  and  $F_{long}$  (UR S11A, Annex 2, [2.1.4])*

The correction factor  $F_{trans}$  is to be set in general to 1.0. Other values are only provided for structures in Bulk Carriers, refer to IACS CSR Pt1, Ch08, Sec05 [2.2.5], which is not in scope of UR S11A. Therefore the factor  $F_{trans}$  was deleted.

The correction factor  $F_{long}$  as defined in IACS CSR Pt1, Ch08, Sec05, table 2 was simplified in order to not consider U-type profiles on hatch covers, which is not in scope of UR S11A.

*Lateral load  $P$  (UR S11A, Annex 2 [4.4.3])*

Due to the fact that IACS has no common procedure to calculate lateral pressures on plate panels for other than CSR ships, the definition of the lateral load  $P$  (IACS CSR Pt.1, Ch08, Sec05 [2.3.4]) as necessary for the determination of the buckling capacity of stiffeners was discussed within the PT.

In theory the pressure  $P$  affects the bending stress  $\sigma_b$  as given in the stiffener limit state formulation:

$$\frac{\gamma_c \sigma_a + \sigma_b + \sigma_w}{R_{eH}} = 1$$

$\sigma_b$  is calculated as follows:

$$\sigma_b = \frac{M_0 + M_1}{Z} 10^{-3}$$

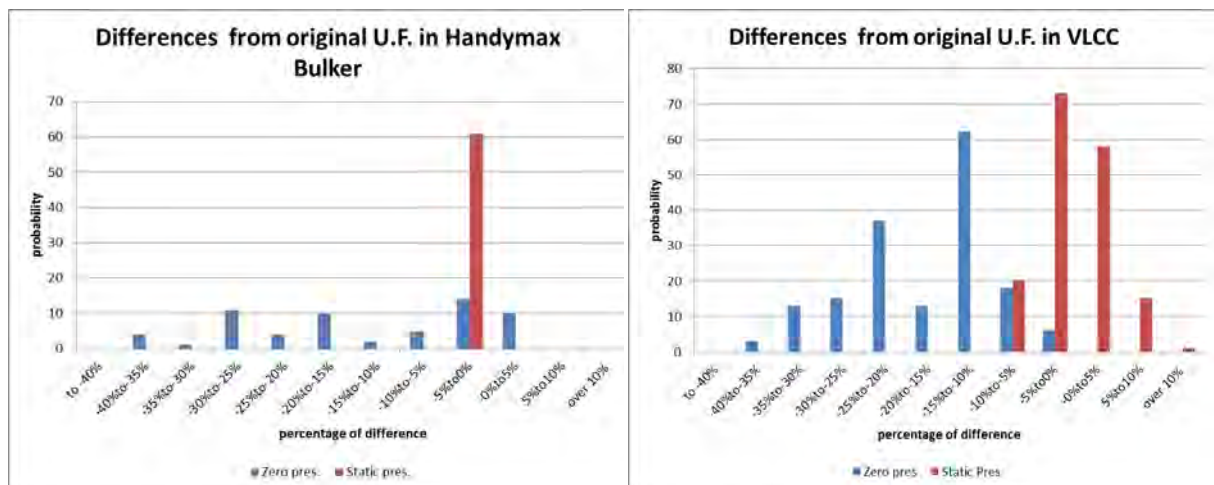
Where the lateral load  $P$  is only affecting  $M_1$  by

$$M_1 = C_i \frac{|P|s\ell^2}{24} 10^{-3} \quad \text{for continuous stiffener}$$

While  $M_0$  is the moment caused by the longitudinal (hull girder) stress and the deformation  $w$  of the stiffener. Therefore the influence of the lateral load  $P$  is relative small, if the stiffener under consideration is subject to high hull girder stresses as it is normally the case in the midship area. In these areas  $M_1$  becomes relative small compared to  $M_0$  and even the component  $\sigma_a$ , the axial stress component dominates the buckling behaviour. In areas with small hull girder stresses (fore- and aft part of the hull structure) the influence of the lateral load  $P$  is of greater importance.

An investigation considering the influence of the lateral load  $P$  on the buckling utilisation was carried out for the midship area for two ships (a Bulk Carrier and an Oil Tanker) and gave the results illustrated in the figure below.

The calculations were carried out following the CSR procedure considering the static and dynamic pressures according to CSR, setting the lateral load  $P$  to zero and considering only the static pressure. The buckling utilisation for  $P$  equal to zero and  $P$  equal to the static pressure was compared to the buckling utilisation factor according to CSR (x-axis on the figure below). As shown in most cases the difference in the buckling utilisation is very small, if the static pressure is considered (red), however increased, if the lateral load is set to zero (blue).



**Figure 11: Probability of differences in buckling utilisation of stiffeners in midship area (Bulk Carrier left, Oil Tanker right)**

It was therefore decided to use the static pressures within the consequence assessments carried out by the PT. The formulation in the requirement was changed to use the maximum static pressure only. While this will result in slightly uncertain results, the results will be the same independent from the classification society. The differences in terms of buckling utilisation in comparison to results determined by using the total pressure will be small, at least in the midship part. Furthermore it has to be noted that for larger Container ships Cargo-Hold Analyses by means of Finite element method is required (refer to UR S34) and that also for these calculations buckling checks are required including consideration of other load components.

## TB S11A.5 Ultimate Hull girder strength assessment

### General

The ultimate hull girder strength assessment refers to the collapse capacity check, i.e. the cross section should not break in two. Even though it may be regarded as obvious that this should be a requirement, such assessment have for many class societies been taken care of implicitly by requiring that the individual panel should not fail. The collapse requirement refers to that the whole cross section should not fail, but it does not mean that the individual panel will not fail. Therefore the collapse capacity and the buckling check should be regarded as complimentary checks on two levels with different acceptance criteria; a local check and a global check. It is absolutely not acceptable that the cross section fails, but it is less critical if only a single panel fail. A panel failing in theory may imply that the panel is actually not failing in practise, i.e. no damage is observed, because the loads may be redistributed to surrounding elements. The latter is also a justification to require a collapse capacity check, since lack of observed damage may imply a false safety margin. The redistribution from some panels to others is partly included in the incremental-iterative method. If one element fails another has to take a higher load.

The two buckling checks as described above should ideally be based on the same common methodology, i.e. the same local buckling model. It is however inconvenient to have iteration on the local model and then also a second iteration in the global model. The buckling model may therefore differ in the local and global buckling, which also is the case in IACS CSR for Bulk Carrier and Oil Tanker (CSR). The proposal for the ultimate capacity check is to use the

theory according to CSR (with reference to the CSR). Further background of the method may be found in TB for CSR.

The ultimate capacity shear check from CSR-H has been excluded and regarded as a secondary check. Documentation of damage experience due to global shear failure of container vessels have not been identified.

The introduction of the collapse assessment is considered as a substantial improvement for URS 11A, although several IACS class societies have already such requirements.

### **The ultimate hull girder capacity check formulation**

The collapse check formulation is written as

$$\gamma_S M_S + \gamma_W M_W \leq \frac{M_U}{\gamma_M \gamma_{DB}}$$

Where

$M_S$  = Permissible still water bending moment

$M_W$  = Vertical wave bending moment

$\gamma_S$  = Partial safety factor for the still water bending moment

$\gamma_W$  = Partial safety factor for the vertical wave bending moment

$M_U$  = Vertical hull girder ultimate bending capacity

$\gamma_M$  = Partial safety factor for the vertical hull girder ultimate bending capacity, covering material, geometric and strength prediction uncertainties

$\gamma_{DB}$  = Partial safety factor for the vertical hull girder ultimate bending capacity, covering the effect of double bottom bending

The partial safety factors should ideally be calibrated based on structural reliability analysis combining wave loading and strength with probability density functions for parameters related to significant variation and uncertainty. The objective would then be to find partial safety factors that together give an acceptable low probability of failure. This has been the basis for some of the factors used in CSR, and some of these factors have therefore been assumed to have been representative also for container vessels.

#### *Still water overloading case*

The check can in principle be done based on a high partial safety factor for the still water load,  $\gamma_S=1.2$ , and with a reduced safety factor for the wave bending,  $\gamma_W=0.7$ , to represent a static overloading case. This is regarded as a relevant scenario. This check was however been found to not be governing for any of the vessels in the consequence assessment, so this check have been omitted. The static overloading case should thereby be regarded as implicit in the dynamic overloading case.

#### *Whipping*

Whipping has been considered as relevant for the ultimate capacity check. The class society procedures differ considerably. A common approach and the magnitude, i.e. the importance, have not been agreed on. It will depend on the ship design, trade, size, powering, seamanship and even the financial crisis with slow steaming. Whipping is included as a requirement in the functional requirements for Post-Panamax container vessels, but is left to the individual class society to consider.

#### *Partial safety factor for wave loading*



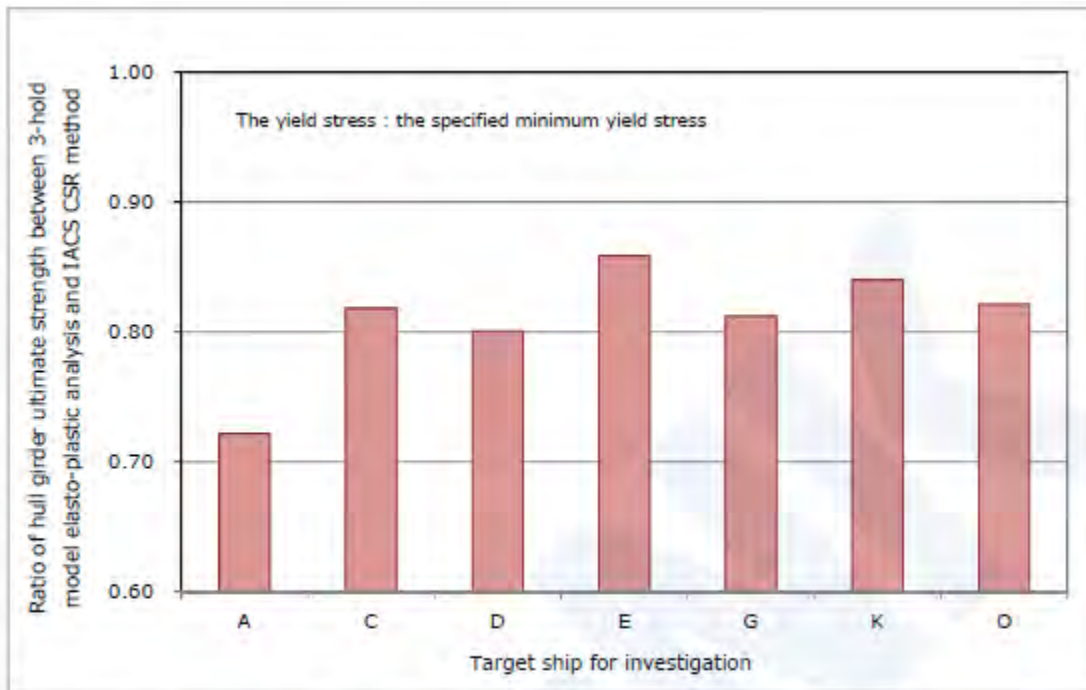
From CSR the partial safety factor for the wave bending moment has been selected as  $\gamma_W=1.2$ . Several of the class societies already use this factor and it seems to have been an accepted factor also for container ships.

*Partial safety factor for still water loading*

From CSR the partial safety factor for the still water loading has been set to  $\gamma_S=1.0$ . The same factor has been considered relevant for container ships.

*Partial safety factor for the material effect*

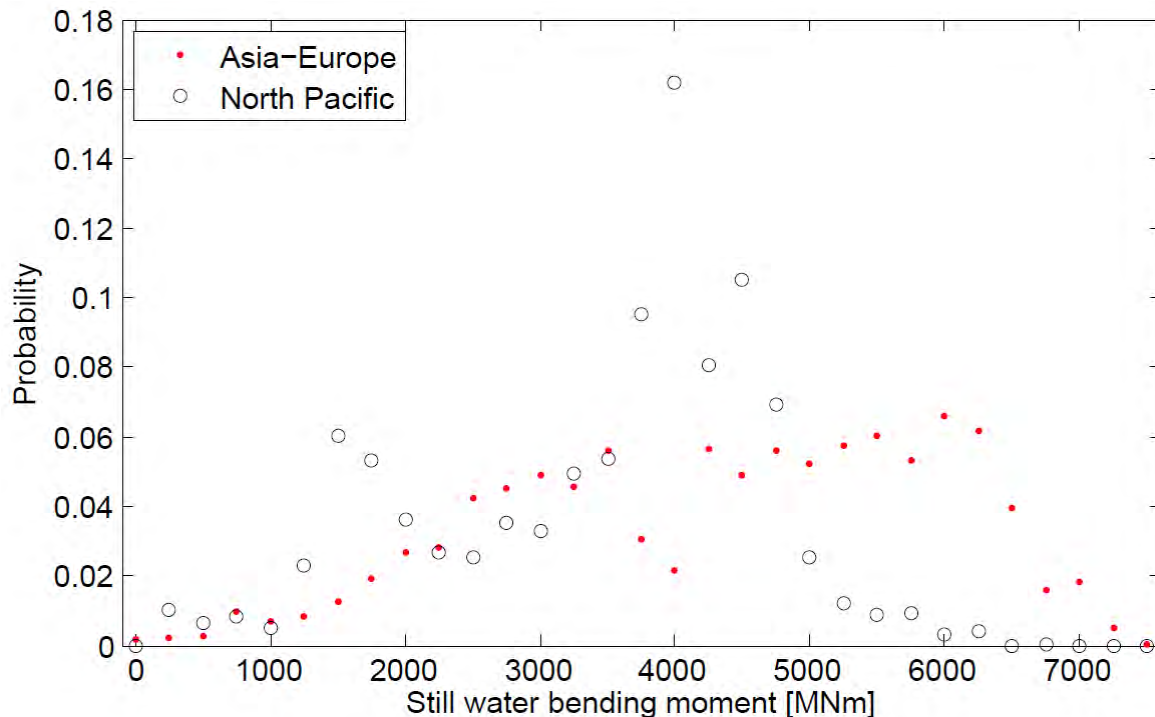
The partial safety factor for the material effect  $\gamma_M$  should include uncertainties related to material, geometrical imperfections e.g. due to welding, and the method used to estimate the collapse strength. An important material property is the yield strength. The minimum specified yield strength is to be used, and the real yield strength may be higher. The collapse strength is based on half the corrosion addition deducted. This is regarded conservative for the global stress level. The geometrical imperfections should not exceed the accepted level of fabrication tolerances required by the class societies and IACS Rec. 47. These imperfections should already be included in the buckling model. Exceedance of the fabrication tolerances, e.g. the deformation at the mid span of the stiffener or flange, will normally not be significant, as the big change of local buckling capacity happens from a zero to a small imperfection. All of these supports that a material factor of  $\gamma_M = 1.0$  should be sufficient. However, the method for collapse capacity may introduce uncertainties. The different class societies use  $\gamma_M$  varying between 1.0 to 1.1. In the “Investigation Report on Structural Safety of Large Container Ships” a comparison is shown between the ultimate hull girder strength calculated by using 3-hold non-linear finite element calculations and the method used in IACS CSR, see Figure 12. As shown for most of the Containerships investigated here the difference is between 15 % and 20%. However one has to note that in this case the non-linear FE calculations already consider the double bottom bending effect, which should be taken out, if we discuss the difference between the calculation methods only. Considering this, a factor  $\gamma_M$  of about 1.05 seems to be reasonable and in addition it demonstrates that it is important to choose the PSF  $\gamma_M$  consistently with the approach used for the estimation of the collapse strength. There should be mentioned that there are also uncertainties in the estimates of the various methods due to definition of collapse and implementation, but the results supports that a higher  $\gamma_M$  than 1.0 should be used when the CSR method is used. The Figure 12 also suggests that the combined factor of  $\gamma_M$  and  $\gamma_{DB}$  should be in the order of 1.2 (vessel A is not representative and is related to MOL Comfort).



**Figure 12: Ratio of hull girder ultimate strength calculated by 3-hold non-linear finite element analysis and IACS CSR method, taken from the “Investigation Report on Structural Safety of Large Container Ships” issued by the Investigative Panel on Large Container Ship Safety of ClassNK in September 2014**

*Plus sign between the still water and wave bending moment*

It should be noted that the plus sign between the still water and wave bending moment implies a hidden safety margin, since the still water loading when fully utilized does not always occur simultaneously with the extreme wave loading. Studies on the implicit safety margin in relation to container ships have not been identified, and the magnitude of the hidden safety margin may vary with ship size and trade. However, as an illustration, the probability distribution of the still water bending moment for one container ship on two different trades is given in Figure 13. The probability of exceeding the permissible maximum hogging moment is about 4% on Asia-Europe trade and closer to 0% in North Pacific. It is thereby low likelihood of exceeding the maximum permissible hogging moment at the same time as exceeding the rule wave bending moment (for this particular ship). The probability of simultaneously occurrence decays for increasing design life time and for a 25 year return period it may therefore be relevant with a partial safety factor of less than 1.0. For other vessel types like tankers and bulk carriers or FPSO’s the hidden safety margin may be significant. The relevant combination factor (understood as the partial safety factor) for the still water bending moment was estimated to 0.70 in sagging and 0.60 in hogging for a return period of 100 years for a FPSO in North Sea (Huang, W. and Moan, T., Combination of global still-water and wave load effects for reliability based design of floating production, storage and offloading (FPSO) vessels, *Applied Ocean Research* 27, 2005, pp.127-141). For Container ships these two results suggest that a partial safety factor of less than 1.0 could be relevant, but it is set to 1.0 to be conservative.



**Figure 13: Probability distribution of still water bending moment from full scale measurements of a 8600TEU Post-Panamax container ship in two different trades (ref. Storhaug, G. and Kahl, A., Hyel2015, paper in progress). Permissible still water bending moment is 6700MNm.**

#### *Double bottom effect*

The partial safety factor for the double bottom needs to be included. Although several of the class societies already has accounted for such factors, the MOL Comfort assessment and report from NK has publically demonstrated values that are in line with what some of the class societies have already been using. These values are also in fair agreement with what has been used in CSR ( $\gamma_{DB} = 1.1$  except 1.25 for empty cargo holds in alternate loading). It should be noted however that these factors are ship type and design dependent. For container ships the double bottom effect in container cargo holds, does not act exactly as for bulk holds or oil cargo tanks on tankers and bulk carriers. The partial safety factor  $\gamma_{DB}$  varies from 1.0 to 1.2 between the class societies in hogging. The NK report seems to demonstrate a factor of 1.2 for several Post-Panamax ships although it is slightly unclear if this is actually also representative for FE prediction with and without lateral loading depending on the accuracy of the simplified model. There are uncertainties in the double bottom factor, because even nonlinear FE analysis with “standard” approach does not handle this correctly, hence the factors from “standard” nonlinear FE analysis may be regarded as somewhat conservative. For UR S11A the following is proposed

$$\begin{aligned} \gamma_{DB} &= 1.15 \text{ for hogging} \\ \gamma_{DB} &= 1.0 \text{ for sagging (the double bottom in tension)} \end{aligned}$$

Combining the double bottom factor with the material factor, this is in line with **Figure 12**.

#### **Principle of ultimate capacity calculation**

Regarding the ultimate bending capacity of the hull girder an iterative calculation method based on the well-known Smith-Method is included in the CSR. The ultimate bending capacity of the hull girder cross section under consideration is defined as the maximum moment of the moment-curvature curve for that cross section. The method determining this

curve is given in Annex 3 of S11A and described in detail in technical background documents of CSR.

#### **TB S11A.6 Additional requirements for large container ships**

Following the Recommendations of IACS EG/Containerships the project team developing the new S11A requirements was tasked to include explicitly additional requirements for large Container ships in a format of functional requirements.

The additional requirements are limited in their application to ships with a breadth  $B$  greater than the old Panamax breadth of 32.26 m.

As one of the most important effects related to the hull girder strength of Container ships, the influence of the double hull bending, including the influence of the transverse stresses (bi-axial stress state) was identified following the MOL Comfort accident. To avoid similar accidents the effect of the local loads as well as additional hull girder loads are to be taken into account for yielding and buckling assessment of large Container ships (S11A.6.2)

The assessment of the whipping effect in terms of hull girder strength and structural integrity is currently still a matter of research. Therefore IACS is at this point in time not able to define a harmonized process that accounts for whipping in the longitudinal strength checks. Because the effect is obviously of importance it was decided to include the requirement S11A.6.3 to take into considerations the whipping contribution to the vertical wave bending moment for the hull girder ultimate strength assessment for large Container ships.

## Overview of results of Consequence Assessment

### General

A consequence assessment was carried out by using a number of ships of the database that was already used for the load computations.

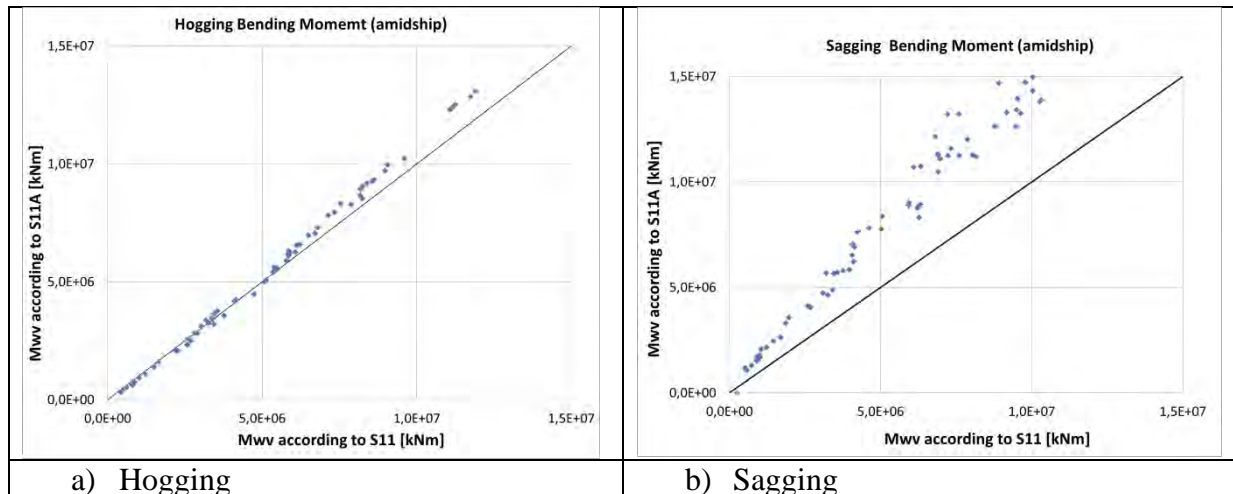
The intention was to investigate the differences of the new proposed requirements compared to the current S11 and to estimate the design impact.

Therefore for the selected ships at 5 locations along the length of the ship (0.3, 0.35, 0.55, 0.6 and 0.65L) the vertical bending moments and shear forces were calculated and the required strength checks were carried out according to the existing S11 and the new proposed S11A requirements. In cases of new requirements in the S11A like the ultimate hull girder strength check, or in case where reservations exist, the checks for the current requirements were carried out according to the requirements of the society.

The results of the investigations are summarised in the following subsections.

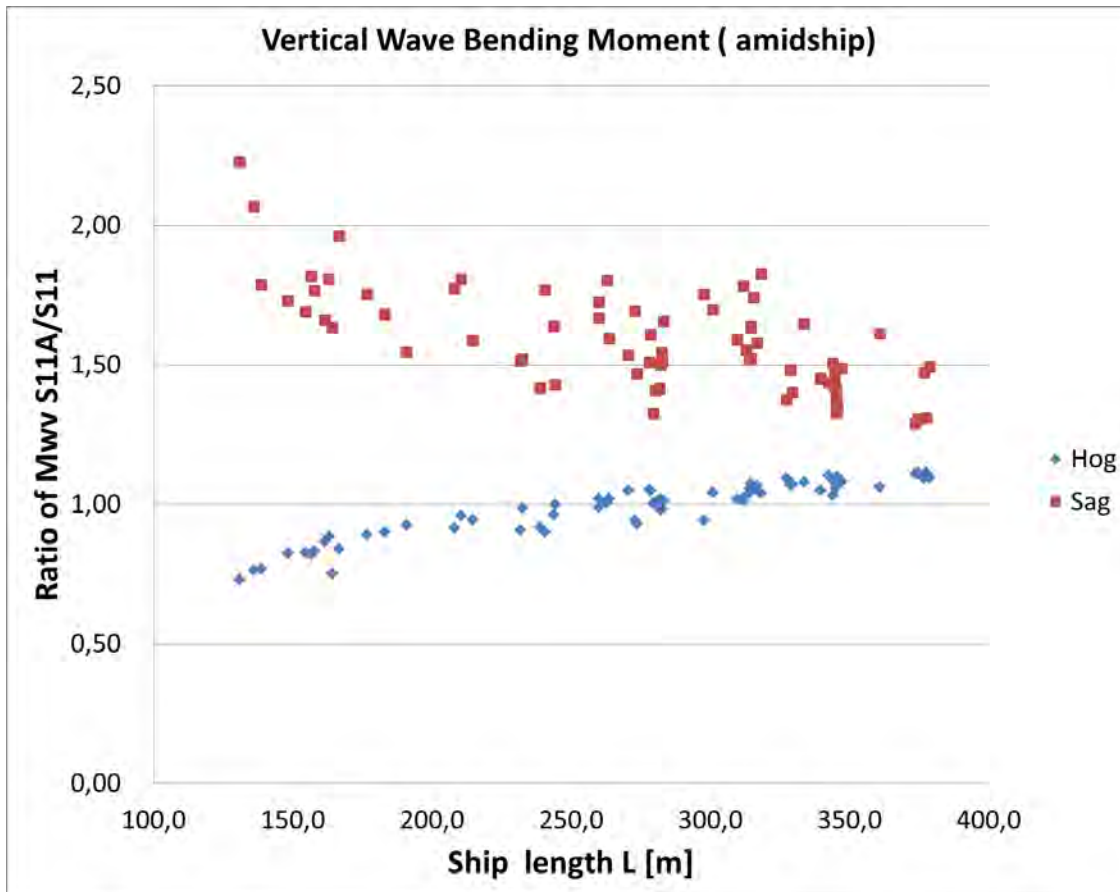
### Loads

The formulations for vertical wave bending moments and shear forces were changed for the new S11A. In the following comparisons between the loads calculated according to the formulations of the current S11 and the new proposed S11A are shown and discussed.



**Figure 14: Comparison of the wave bending moments new S11A requirement versus existing S11 requirement for a) hogging and b) sagging**

As shown in Figure 14 in case of hogging the new requirement will give higher wave bending moments for larger ships while the wave bending moments for smaller ships are smaller compared with the existing S11 formulation. In case of sagging the new formulation will always result in larger wave bending moments compared with the current requirement.



**Figure 15: Ratio of new S11A to existing S11 requirement versus ship length L**

Plotting the ratio of the wave bending moment according to the new S11A divided by the existing S11 formulation versus the ship length shows clearly that for smaller ships the hogging moment decreases, while the sagging moment increases. The reason here is obviously that the nonlinear effects are more important for smaller ships than for longer ships. This is also supported by the results obtained by the non-linear load computations. For smaller ships and the used wave scatter diagram the design sea states are much more steep and severe relatively to the ship size, than they are for the longer ships. The new proposed formulation of the vertical wave shear forces yields to significantly higher forces compared to the formulation in the current S11, as shown in Figure 16. The new formulation solves the since long time known problem of the inconsistency of the wave bending moment formulation of the current S11 at one hand and the shear force formulation at the other. Therefore the increase of the shear forces compared to the current formulation is partly caused by the elimination of this inconsistency.

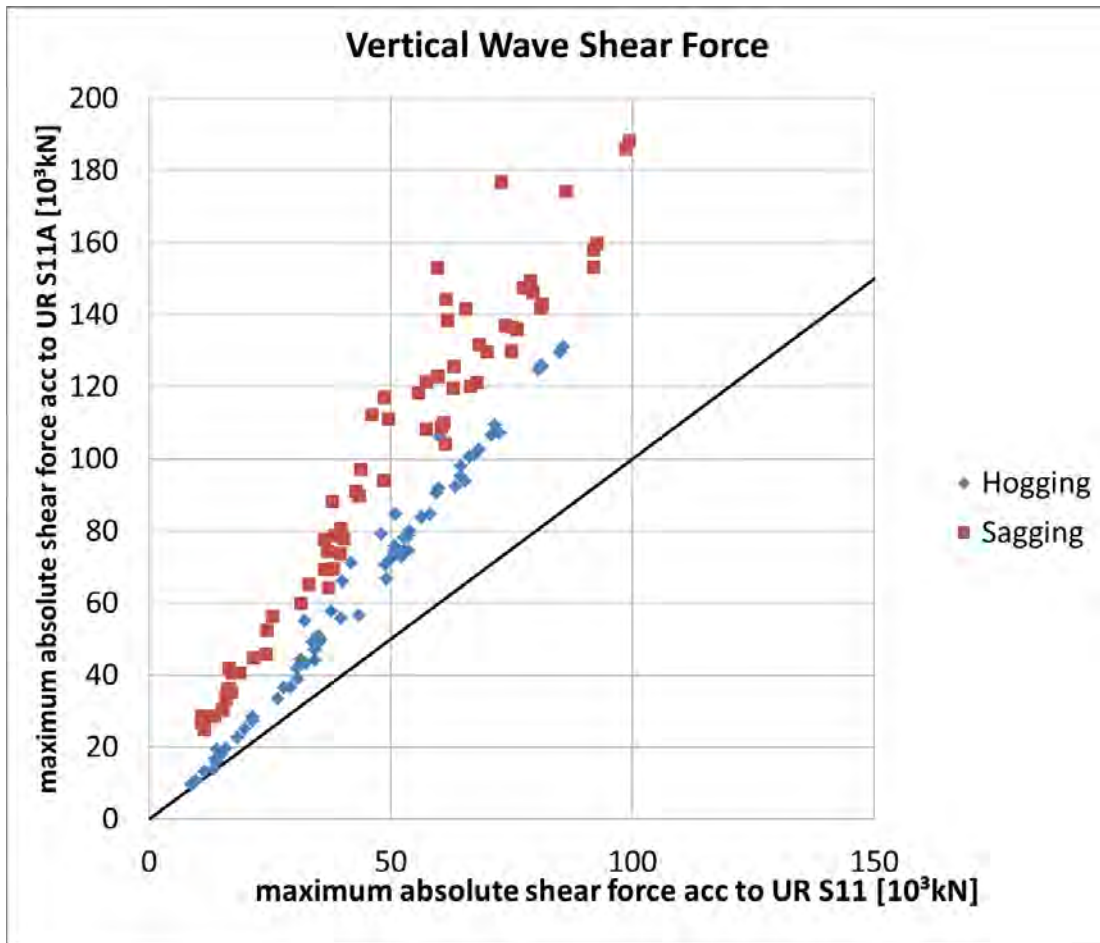
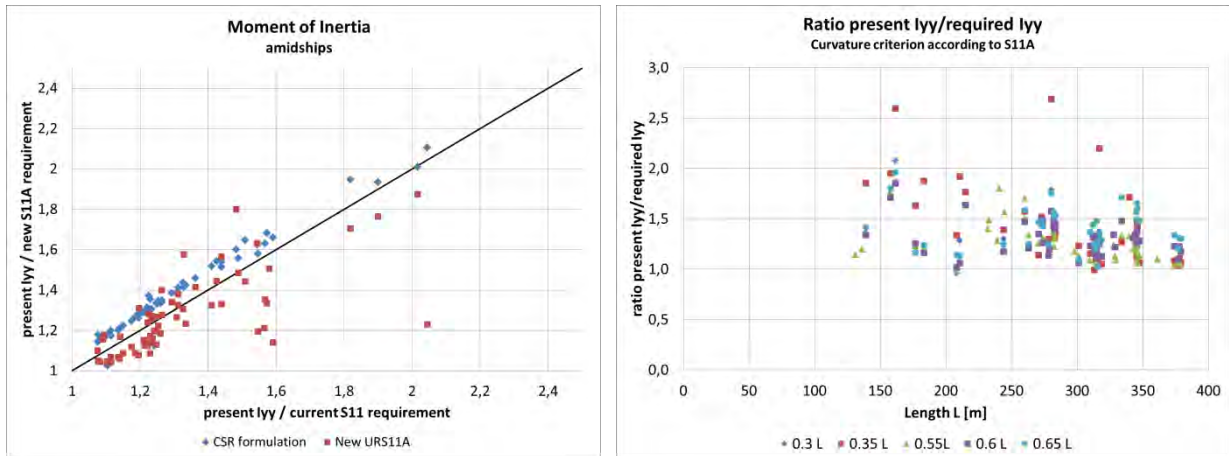


Figure 16: maximum absolute shear force obtained using the new proposed S11A formulation versus the maximum absolute shear force obtained using the current S11 formulation

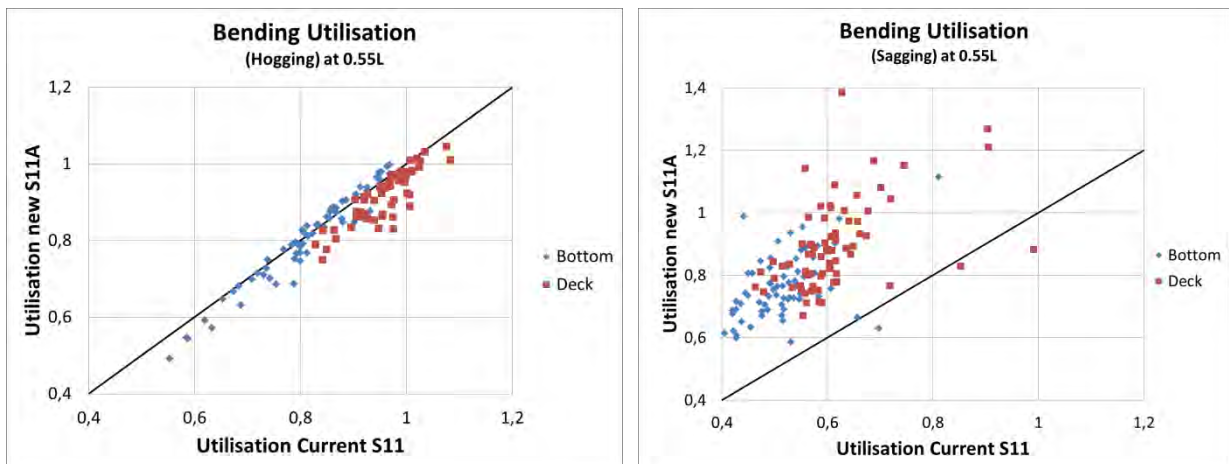


## Yield Assessment



**Figure 17: Comparison of required moment of inertia, left comparison with current S11 requirement (red, new formulation of S11A, blue formulation of CSR), right comparison of the new requirement of S11A with existing moment of inertia of the ship cross sections.**

Figure 18 shows the results of a comparison of the new required moment of inertia compared with the existing requirements of S11 and CSR (left) and the existing moment of inertia calculated for the different cross sections of the ships in the database. As can be seen, the new requirement introduces a wider scatter of the required values, which is caused by the consideration of the load (total vertical bending moment). However the right side of the figure illustrates that almost all cross sections of the existing Container Ships that were checked in the CA, fulfil the new requirement.

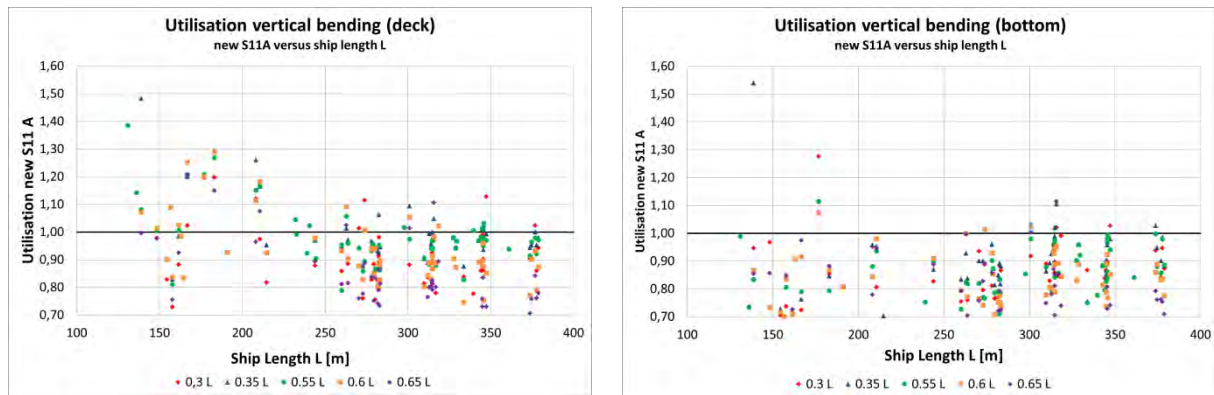


**Figure 18: Utilization factor of bending strength comparison between the new requirement in S11A with the requirement in the existing S11 at 0.55L, left hogging condition, right sagging condition**

Figure 18 shows the results for the utilization factors for bending strength calculated for cross sections near mid-ship (0.55L) left in hogging condition and right in sagging. Blue rhombs indicate results obtained at bottom, while red squares indicate results obtained at equivalent deck level according to UR S5. At left hand side of the figure it can be clearly seen that the utilization in hogging conditions at deck level is in general equal or lower compared with the current S11, while the results at bottom are in some cases above the current S11 requirement. The reason here is mainly the difference of the change of the section modulus at bottom and deck level caused by the implementation of the net-scantling approach as described above. In case of sagging, at right hand

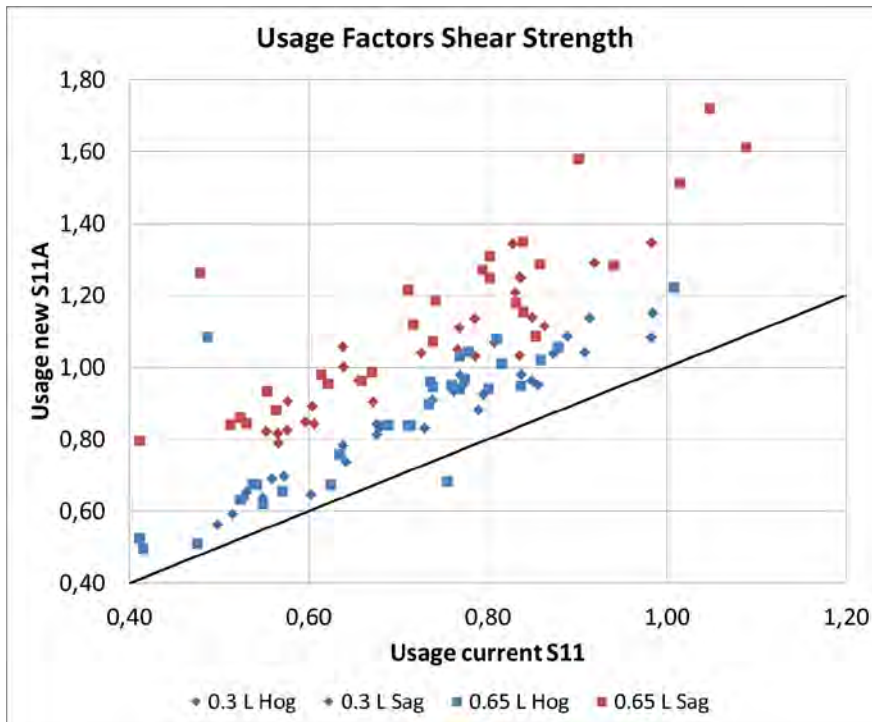


side of Figure 18, the results are almost above the current S11 requirement, mainly caused by the significant increase of the wave bending moment in sagging.



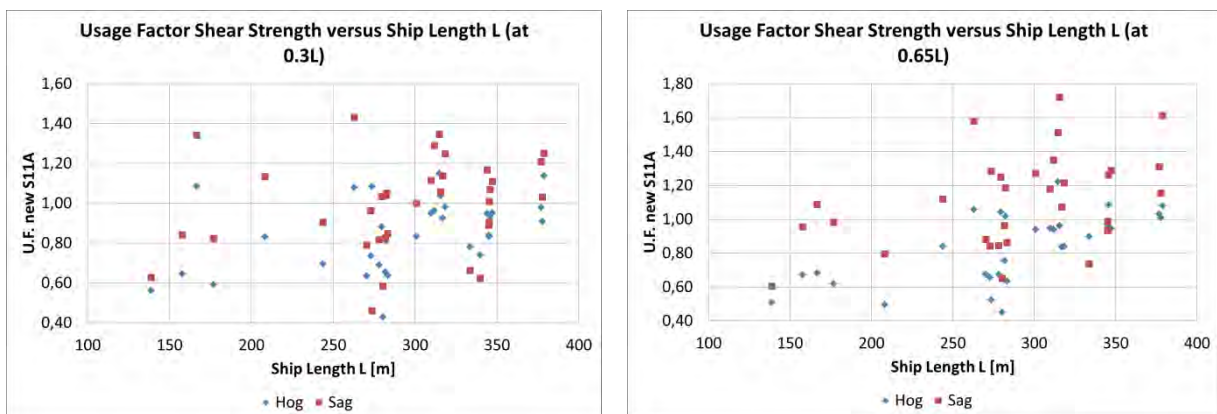
**Figure 19: Utilisation factor of bending strength according to the new S11A requirement versus the Ship length L, left results obtained at equivalent deck level (UR S5), right results obtained at bottom**

Figure 19 shows the utilization factors for bending according to the new S11A requirement versus the ship length L. At left hand side the results obtained at equivalent deck level are shown, at right hand side the results at bottom. As can be seen most of the cross sections fulfill the requirements, however at deck level more cross sections fails the check than at bottom level. Furthermore it can be observed that higher deviations are found for smaller ships compared to the larger ones. There are basically two reasons for this effect. One is the trend to higher non-linear load factors as already described above for smaller ships, the second is in case of sagging the relative high uncertainty with respect to the still water values.



**Figure 20: Usage factors for shear strength at cross sections 0.3L and 0.65L compared with the current S11 requirement**

**Figure 20:** shows the usage factors for the shear assessment obtained according to the new S11A requirements versus the old S11 requirement. As can be seen the usage in case of shear is almost significantly increased compared to the old requirements, which is especially true for the sagging condition (red points in the graph). Furthermore it is shown that a large number of cross sections do not fulfill the new requirements. This is also observed from Figure 21, where the usage factors calculated according to the new S11A are plotted versus the ship length.

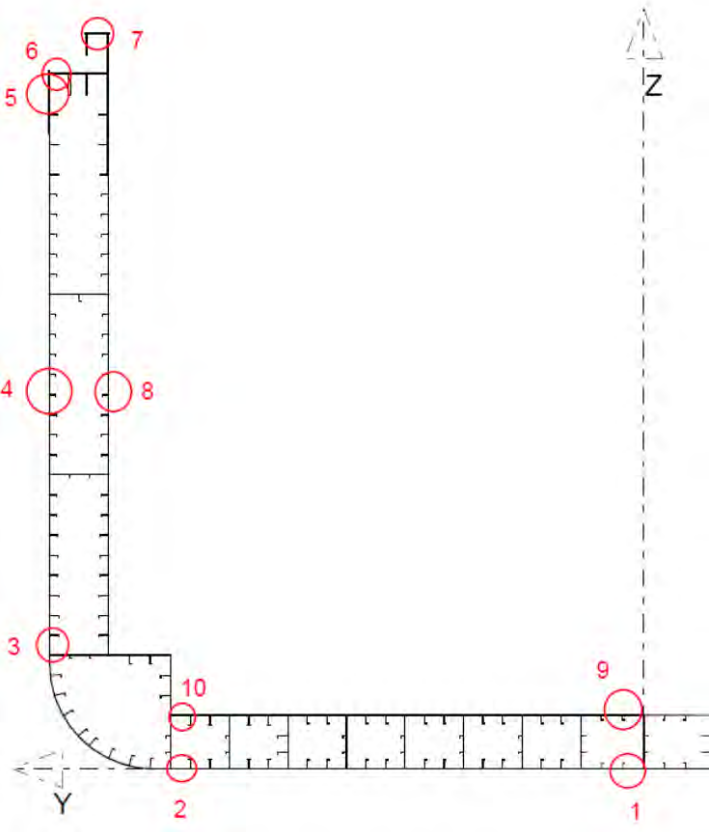


**Figure 21: Usage Factors for shear strength versus the ship length L, left cross sections at 0.3L, right cross sections at 0.65 L**

There are mainly three reasons for the high deviation of the results compared to the current S11 requirements. At first the existing inconsistency between the vertical wave bending moment and the vertical wave shear force, which tends to obtain too low shear forces following the current S11 approach is removed in the new S11A. In addition the wave loads, especially in case of sagging have

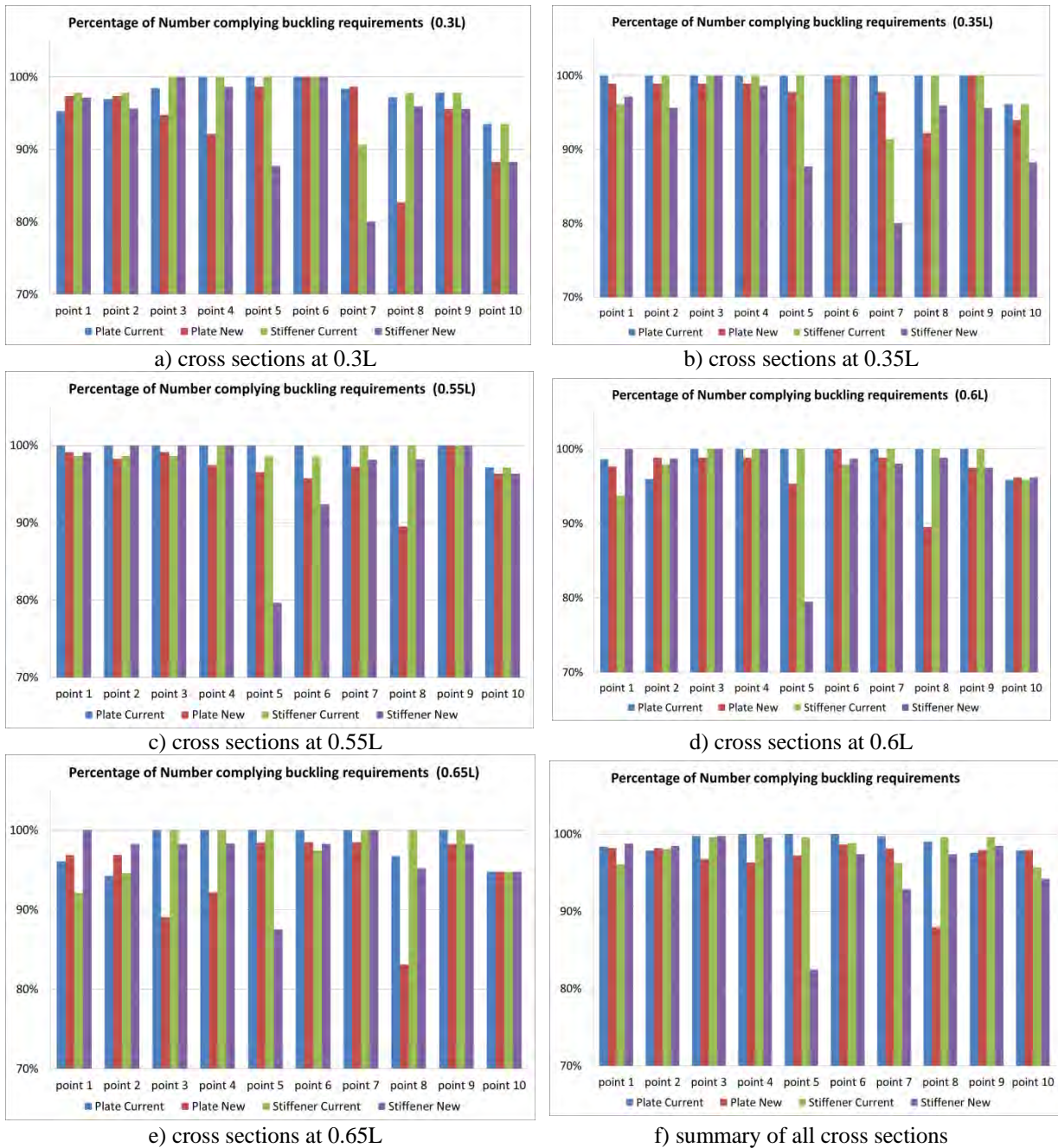
increased significantly, which is the reason that in sagging condition the utilization is higher than in hogging, see Figure 20. The third reason is the high uncertainty that we have with respect to the still water loads in sagging condition for the ships in the data base. Even the still water sagging values given in the loading manuals seems to be based on sometimes “unrealistic” load case assumptions. Therefore the significance of the CA results with respect to the bending and shear utilization in sagging condition is somehow limited.

**Buckling assessment**



**Figure 22: Positions of the 10 evaluation points for the buckling assessments**

The buckling assessment following the new proposed requirements in S11A was carried out for the five cross sections as used for the yield strength assessment and the 10 elements as shown in Figure 22. The checks were carried out for the plating as well as for the stiffeners, if applicable. For comparison buckling assessment following the current S11 requirements or the requirements of the class society (in case of reservations against the buckling requirement in S11) were carried out. The results obtained are summarised in Figure 23, for each cross section and each evaluation point.



**Figure 23: Results of the buckling assessments, a) to e) for cross sections at 0.3, 0.35, 0.55, 0.6 and 0.65L respectively, f) summary considering all buckling results**

The blue columns in Figure 23 indicate the number of plate elements that fulfill the buckling requirements according to the existing rules, the red column indicates the number of plate elements that pass the buckling check following the approach in S11A. Similar the green columns indicate the results for the stiffener check following the existing rules and the purple column indicates the results for the stiffeners following the S11A. As shown in Figure 23 most of the elements pass the buckling checks. However some areas with larger deviations from the existing situation can be identified. Especially the plate elements at evaluation points 3, 4 and 8 as well as the stiffener at evaluation point 5 shows some deficiencies with respect to the S11A requirements. The reason for the plate elements is mainly related to the significantly increased shear stresses, which yields to the high utilization not only in case of buckling but also in case of shear yield checks as already described above. This is supported by the observation that the deficiencies for these evaluation points and the plate elements are found especially at the cross sections at 0.3L and 0.65L, see Figure 23 a) and e),

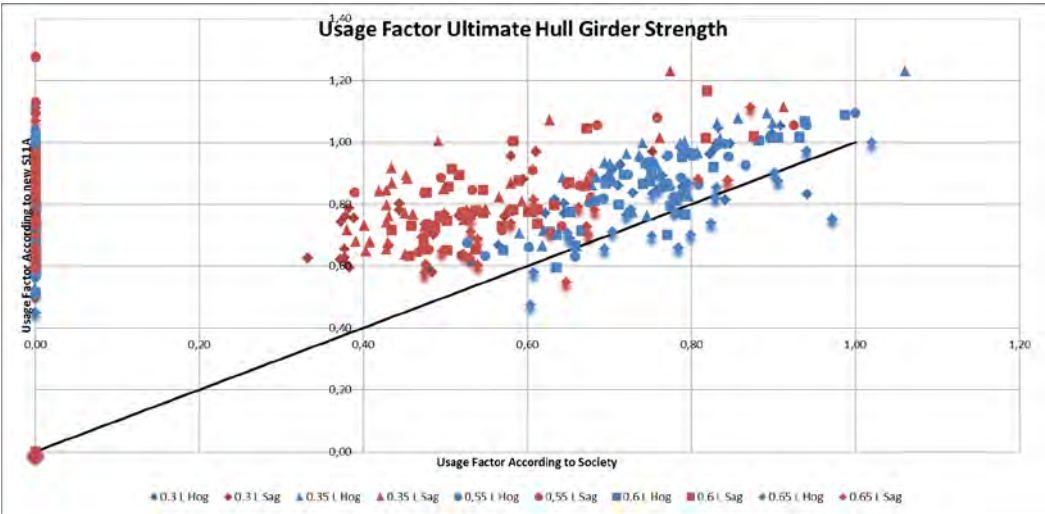
while at mid ship section (Figure 23 c)) much more elements fulfill the requirement. Furthermore the stiffener in the shear plate is found in some cases insufficient (evaluation point 5). This obviously is true for all the checked cross sections and could be caused by the significantly increased sagging wave bending moments.

Also here it should be noted that in some cases the still water values in case of sagging are uncertain and can influence the results obtained in the buckling check.

**Ultimate Hull Girder Strength**

Ultimate hull girder strength was assessed during the CA following the S11A approach as well as applying existing approaches of the class societies for comparison. The checks were carried out at the cross sections used for the yield and buckling checks as described above. The partial safety factor for the double bottom effect was kept constant irrespective of changes in the double bottom structure at the forward ore afterward cross sections.

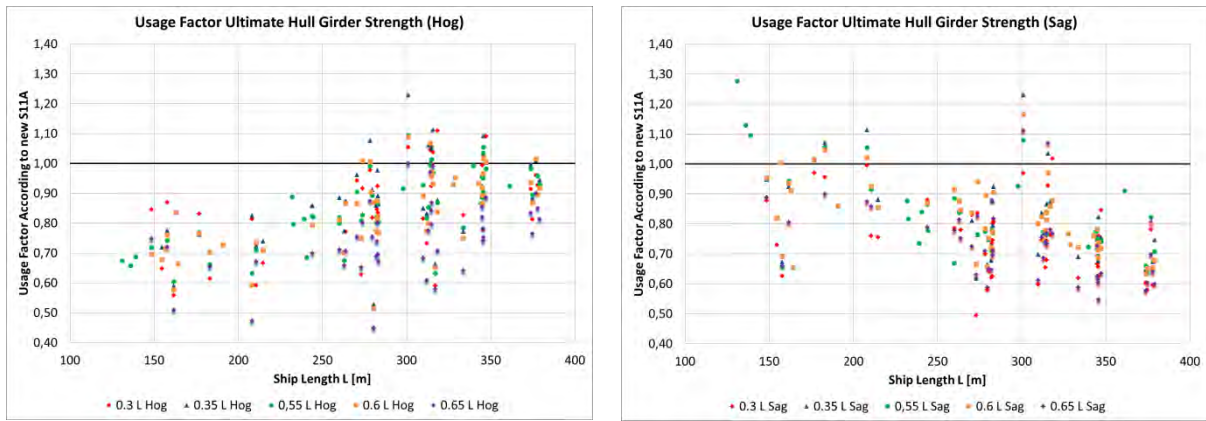
Results obtained following the approach in S11A compared with results following existing class requirements are shown in Figure 24. As can be shown, the S11A requirement is obviously a bit stricter than the existing requirements of the class societies. Furthermore most of the checked cross sections pass the check. The obvious increased usage by applying the S11A requirements is mostly caused by the increased wave bending loads, especially in case of sagging (red points in Figure 24).



**Figure 24: Comparison of the usage factor for ultimate hull girder strength of the S11A requirement to existing class requirements**

Figure 25 shows the utilisation for the ultimate strength check versus the ship length. At left hand side the results obtained for hogging condition and at left hand side the results for the sagging condition are shown. It can be seen clearly that in hogging some larger ships do not pass the ultimate strength check, while in hogging only two larger and a few smaller ships fails. In sagging case it is expected that probably not correct still water bending moments cause the failure of the check. In hogging case obviously a few larger ships are required to be strengthened.





**Figure 25: Usage factor for ultimate hull girder strength versus the ship length L, left hogging condition, right sagging condition**

However it has to be kept in mind that a possible reduction of the partial safety factor for the double bottom effect was not considered in the checks, even in cases where the structure of the double bottom changes or the breadth of the double bottom decreases in comparison to the midship part. Consideration of the variability of the partial safety factor for the double bottom effect will reduce remarkably the number of cross sections at the forward and aft part of the ships that do not pass the check.

## UR S12 "Side Structures in Single Side Skin Bulk Carriers"

### Part A. Revision History

Version no.	Approval date	Implementation date when applicable
Rev.5 (May 2010)	24 May 2010	-
Rev.4 (July 2004)	5 July 2004	-
Rev.3 (Sept 2000)	7 September 2000	1 July 2001
Rev.2.1 (1997)	10 December 1997	-
Rev.1 (1997)	8 September 1997	-
NEW (1992)	<i>No record</i>	-

- **Rev.5 (May 2010)**

**.1 Origin for Change:**

- Based on IACS Requirement (*Common Structural Rules for Bulk Carriers and Double Hull Oil Tankers*)

**.2 Main Reason for Change:**

Following the introduction of the IACS Common Structural Rules for Bulk Carriers and Double Hull Oil Tankers, Hull Panel were tasked to review all the UR S files to consider whether or not they are applicable to ships covered by the CSR.

**.3 List of non-IACS Member classification societies contributing through the TC Forum and/or participating in IACS Working Group:**

None.

**.4 History of Decisions Made:**

After review it was decided that for CSR bulk carriers the requirements of UR S12 are superseded by those of the Common Structural Rules and therefore do not apply.

UR S12 is not applicable for CSR oil tankers.

**.5 Other Resolutions Changes**

All UR S files, except UR S8, S9, S15, S16, S19, S22, S23, S30 and S31.

**.6 Dates:**

Original proposal: 2007, made by Hull Panel Task 50  
 Panel submission to GPG: 19 April 2010  
 GPG Approval: 24 May 2010 (Ref. 10051\_IGd)

- **Rev.4 (July 2004)**

No TB document available – addition of 'Contracted for Construction' footnote.

- **Rev.3 (Sept 2000)**

See TB document in Part B.

- **Rev.2.1 (1997)**

No TB document available.

- **Rev.1 (1997)**

No TB document available.

- **NEW (1992)**

No TB document available.



## Part B. Technical Background

List of Technical Background (TB) documents for UR S12:

Annex 1. **TB for Rev.3 (Sept 2000)**

See separate TB document in Annex 1.



**Note:** *There are no separate Technical Background (TB) documents for the original resolution (1992), Rev.1 (1997), Rev.2.1 (1997), Rev.4 (July 2004) and Rev.5 (May 2010).*

## UR S13 “Strength of bottom forward in oil tankers”

### Part A. Revision History

Version no.	Approval date	Implementation date when applicable
Corr.1 (May 2014)	13 May 2014	-
Rev.2 (May 2010)	24 May 2010	-
Rev.1 (1993)	2 December 1993	1 July 1994
NEW (1993)	<i>No record</i>	-

- **Corr.1 (May 2014)**

**.1 Origin for Change:**

- Suggestion by an IACS Member

**.2 Main Reason for Change:**

UR S13 currently refers to Regulation 13 of MARPOL 73/78 Annex I however the structure of MARPOL Annex I has been substantially revised since UR S13 was first introduced and Regulation 13 no longer refers to segregated ballast tanks. Instead, Regulation 18 should be referenced.

**.3 List of non-IACS Member classification societies contributing through the TC Forum and/or participating in IACS Working Group:**

None.

**.4 History of Decisions Made:**

A Hull Panel Member noted that UR S13 still referenced Regulation 13 instead of Regulation 18.

**.5 Other Resolutions Changes**

None

**.6 Dates:**

Original proposal: 14 April 2014  
 Panel submission to GPG: 29 April 2014  
 GPG Approval: 13 May 2014 (Ref: 14068\_IGb)

- **Rev.2 (May 2010)**

**.1 Origin for Change:**

- Based on IACS Requirement (*Common Structural Rules for Bulk Carriers and Double Hull Oil Tankers*)

**.2 Main Reason for Change:**

Following the introduction of the IACS Common Structural Rules for Bulk Carriers and Double Hull Oil Tankers, Hull Panel were tasked to review all the UR S files to consider whether or not they are applicable to ships covered by the CSR.

**.3 List of non-IACS Member classification societies contributing through the TC Forum and/or participating in IACS Working Group:**

None.

**.4 History of Decisions Made:**

After review it was decided that for CSR oil tankers the requirements of UR S13 are superseded by those of the Common Structural Rules and therefore do not apply.

UR S13 is not applicable for CSR bulk carriers.

**.5 Other Resolutions Changes**

All UR S files, except UR S8, S9, S15, S16, S19, S22, S23, S30 and S31.

**.6 Dates:**

Original proposal: 2007, made by Hull Panel Task 50  
Panel submission to GPG: 19 April 2010  
GPG Approval: 24 May 2010 (Ref. 10051\_IGd)

- **Rev.1 (1993)**

Addition of mandatory implementation date – no TB document available.

- **NEW (1993)**

No TB document available.

## Part B. Technical Background

List of Technical Background (TB) documents for UR S13:



**Note:** *There is no separate Technical Background (TB) document for the original resolution (1993), Rev. 1 (1993), Rev. 2 (May 2010) and Corr. 1 (May 2014).*

## UR S14 “Testing Procedures of Watertight Compartments”

### Summary

Changes were made to clarify application of UR S14 especially for smaller ships / non-SOLAS ships. For that purpose, Part B was modified, and new Part C was added. Test pressure head for ships under Part C was newly developed.

### Part A. Revision History

Version no.	Approval date	Implementation date when applicable
Rev. 7 (Dec 2022)	28 December 2022	1 January 2024
Rev. 6 (Aug 2016)	19 September 2016	1 January 2018
Rev.5 (Jan 2015)	15 January 2015	1 January 2016
Rev.4 (August 2012)	20 August 2012	1 July 2013
Rev.3 (May 2010)	24 May 2010	-
Rev.2 (May 2001)	30 May 2001	-
Rev.1 (Feb 2001)	12 February 2001	-
NEW (1996)	<i>No record</i>	-

#### • Rev.7 (Dec 2022)

##### .1 Origin for Change:

- Suggested by IACS member

##### .2 Main Reason for Change:

UR S14 provides tank testing requirements which were in part developed to address the SOLAS tank testing requirements however since IACS URs are applicable to seagoing ships over 100 GT in size, UR S14 is also applicable to small non-SOLAS ships and yachts. As a result of this, LR placed a reservation against UR S14 with respect to the application to LR’s Special Service Craft Rules on the basis that the testing regime is too onerous. Therefore, it was decided to revise UR S14 to include an appropriate tank testing regime for small ships.

##### .3 List of non-IACS Member classification societies contributing or participating in IACS Working Group:

None.

##### .4 History of Decisions Made:

A project team was set up to investigate appropriate tank testing requirements for small ships where aspects such as overflow arrangements, materials other than steel,

the practical application of the existing requirements and the relationship between design pressure and test pressure were considered. The existing Part B is now only applicable to SOLAS exempt/equivalent ships, and a new Part C has been added which is applicable to non-SOLAS ships.

See Part B Annex 3 for a detailed technical background.

Existing paragraph Part B 2.5 (2.6 in Rev. 7) has been amended to clarify that the relaxations for sister ships are applicable to both lead ships which were tested in accordance with Part A and lead ships which have been tested in accordance with Part B Paragraph 2.3. The previous reference to Table 1 has been removed.

Part B Section 2.5.2 of UR S14 rev. 6 requires that structural testing be carried out for at least one tank of each type among all tanks of each sister vessel. One topic of discussion within the Hull Panel was whether for sister ships in Parts B and C there should be a requirement that one tank of each type be structurally tested given that this requirement means that there may not be much relaxation for sister ships. This is because the requirement to structurally test one tank of each type of structural similarity applies to the lead ship. It was decided to only require one tank to be structurally tested for a sister ship subject to Part C (Part B kept as before) since the purpose of the structural test is to confirm the design. As this will already have been done for the lead ship, it is only necessary to test the workmanship on sister ships which is done by means of a leak test. This relaxation does not apply to tanks carrying pollutants however rather than require every such tank to be structurally tested, on a sister ship one tank of each type need only be structurally tested.

The relaxations for sister ships have also been extended to cover spaces such as chain lockers.

The Hull Panel also decided to make other minor amendments as follows:

- Fuel oil overflow tanks not intended to hold fuel have been added to Part A, Table 1.
- A reference to Recommendation 47 or a recognised fabrication standard has been removed in line with changes made to other URs.
- Part B, Section 2.6 was amended to clarify that the lead ship is to be structurally tested in accordance with either Part A or Part B, Section 2.3.
- A definition of the overflow has been included; this is any physical means of preventing overflow.
- The requirement to test tanks based on the pressure relief valve setting has been replaced with a requirement to test tanks based on the design vapour pressure. This is to align with the requirements of the CSR BC & OT.
- The requirement to consider an appropriate additional head for chemical cargo tanks where the density is greater than 1 has been revised to refer to Section 4.4.1 where there is a description of how to test such tanks. Section 4.4.1 has also been amended to clarify the test pressure for such tanks which shall not exceed the maximum design internal pressure in the top of tank.
- In Annex 1/Part A/Table 1/Note 6 in UR S14, MSC/Circ.1176 has been replaced by MSC.1/Circ.1572/Rev.1

## **.5 Other Resolutions Changes**

None

## **6 Any hinderance to MASS, including any other new technologies:**

None

## **.6 Dates:**

Original proposal : 09 November 2018 (Ref: 18193\_PHa)  
Submission to GPG : 08 December 2022 (Ref: PH18018\_IHcb)  
GPG Approval : 28 December 2022 (Ref: 18193\_IGr)

## **• Rev.6 (Aug 2016)**

### **.1 Origin for Change:**

Based on IMO Regulation SOLAS II-1/11

### **.2 Main Reason for Change:**

The CSR BC & OT refers to UR S14 which is considered by the IMO to be a lesser standard than the SOLAS tank testing requirements. In order to resolve this issue, it was proposed that UR S14 be amended to comply with SOLAS II-1/11.

### **.3 List of non-IACS Member classification societies contributing through the TC Forum and/or participating in IACS Working Group:**

None.

### **.4 History of Decisions Made:**

Various options for satisfying the SOLAS requirements were discussed and it was agreed that SOLAS ships (including CSR BC & OT) should comply with SOLAS II-1/11. Hence, it was concluded that UR S14 should be amended to comply with SOLAS so that the tank testing requirements of Chapter II-1/11 are applicable to all SOLAS ships. However, it was noted that the requirements of UR S14 apply to both SOLAS and non-SOLAS vessels and that Flag Administrations may issue either exemptions against Chapter II-1/11 or state that UR S14 Rev 5 tank testing requirements are equivalent to SOLAS chapter II-1/11. Hence, it was decided that UR S14 should be split into two Parts; Part A giving requirements for SOLAS ships and Part B giving requirements for non-SOLAS ships and ships which have been given exemption/equivalency by their Flag. The decision was also made to require documentary evidence of the owner's agreement to seek exemption/equivalency as well as evidence that the Flag Administration has granted exemption/equivalency.

In addition, the Survey Panel requested that some amendments be made to the air test procedures and the requirements for NDT; these have been included.

There was some discussion about the SOLAS requirements concerning the following:

- Structural testing of Fore Peak, double bottom and side skin voids.
- Use of stagger testing
- Definition of watertight sub-division

#### Structural testing of Fore Peak, double bottom and side skin voids.

UR S14 does not require a structural test for these spaces and this was queried by one Member who advised that:

“Structural test is required for the watertight boundaries of spaces even other than tanks in accordance with SOLAS II-1/11.2.”

However, Regulation 11.1 states that "Testing watertight spaces not intended to hold liquids and cargo holds intended to hold ballast by filling them with water is not compulsory." Although Regulation 11.2 does state that the forepeak, double bottom (including duct keels) and inner skins are to be tested with a head of water, when Regulation 11.1 is taken into account it is clear that the spaces mentioned in Regulation 11.2 are assumed to be spaces intended to carry liquid and not void spaces; the purpose of Regulation 11.2 is to specify the test pressure for these spaces.

It was, therefore, decided to retain the existing text in UR S14.

#### Use of stagger testing

UR S14 allows stagger testing to be used however one Member advised that there had been issues with certain Flags regarding the implementation of this procedure.

Upon closer examination of SOLAS it was found that there is no requirement in SOLAS that tanks have to be tested from both sides; just that the boundaries have to be tested for both tightness and structural strength. In addition, the stagger testing is a minimum level of testing and has to cover both tension and compression cases.

It was, therefore, decided to retain the existing text in UR S14.

#### Definition of watertight sub-division

There was some debate about the definition of watertight sub-division. SOLAS II-1/11.3 requires tanks which are intended to hold liquids, and which form part of watertight sub-division of the ship, shall be tested for tightness and structural strength... In Rev. 6 of UR S14, watertight sub-division has been defined as follows:

“Watertight subdivision means the main transverse and longitudinal subdivisions of the ship required to satisfy the subdivision requirements of SOLAS Chapter II-1”

The watertight sub-division can be related to the damage stability requirements contained in SOLAS as it is understood that when the damage stability is being assessed, various spaces on the ship are assumed to be flooded but that this flooding is limited by longitudinal and transverse sub-division. If the boundary of the tank is not required to satisfy the watertight subdivision requirements (and hence damage



stability) then it does not need to be tested. An example would be small engine room tanks.

## **.5 Other Resolutions Changes**

None

## **.6 Dates:**

Original proposal: 11178dIGad 15 June 2016  
Panel submission to GPG: 19 August 2016 (Ref: 11178dPHI)  
GPG Approval: 19 September 2016 (Ref: 11178dIGzc)

## **• Rev.5 (Jan 2015)**

### **.1 Origin for Change:**

Request by the GPG.

### **.2 Main Reason for Change:**

To align UR S14 with the Guidelines submitted to the Correspondence Group on Testing of Watertight Compartments which was established at SDC 1. These are based on the guidelines submitted to SDC 1 (SDC 1/INF.13). Also to remove the relaxations and reintroduce the structural tests for Tankers and Combination Carriers, based on Industry feedback and the discussion at GPG74.

### **.3 List of non-IACS Member classification societies contributing through the TC Forum and/or participating in IACS Working Group:**

None.

### **.4 History of Decisions Made:**

At GPG74 (April 2013), the GPG noted the Industry feedback received during the IMO DE56 and DE57 sessions and requested that the relaxations for Tankers and Combination Carriers be removed from the Guidelines that were submitted to DE57, which, in effect, reintroduces the structural tests for Tankers and Combination Carriers. In addition, it was agreed to update UR S14 to align with the DE57 Guidelines (all changes made between MSC86 and DE57 submissions). It is noted that the UR S14 (Rev 4) was previously updated to align with the MSC86 version which was introduced in IACS paper MSC 86/23/13, 25 Feb 2009 and gained widespread agreement among flag states at that time.

The relationship between Rev. 4 and Rev. 5 to the various submissions to IMO MSC and DE is shown in the following table:

IACS	IMO
UR S14, Rev. 4, Aug 2012	MSC 86/23/13, 25 Feb 2009
-	DE 56/INF.11, 9 Dec 2011
-	DE 57/INF.6, 8 Jan 2013
UR S14, Rev. 5, Jan 2015	Same as the updated version of SDC 1/INF.13 submitted to the CG established at SDC 1

A summary of changes made between UR S14 Rev. 4 and Rev. 5 is as follows:

- Updating the definitions for the test types.
- Clarifying the "Testing Schedule for New Construction or Major Structural Conversion".
- Clarifying the "Test Methods".
- Specifying additional requirements for "Hydrostatic or hydropneumatic tightness test".
- Updating Table 1 "Test Requirements for Tanks and Boundaries" and specifying requirements for additional "Tanks or boundaries to be tested".
- Combined Rev 4, Table 1, Notes 7 and 8 and clarified that for watertight bulkheads (item 11.1) the alternative testing methods may only be applicable where a hose test is not practicable. For items 12, 16 and 17 of Table 1 the alternative to the hose test may be made at the discretion of who performs the test.
- Updating the requirements for Liquefied gas carriers, in Para 2.2 and Table 2.
- Updating the notes for Table 3.
- Reintroduce the structural tests for Tankers and Combination Carriers.

Following SDC 1, the guidelines were further revised and submitted to the IMO SDC Correspondence Group on Testing of Watertight Compartments. A summary of the changes is as follows:

- Enhancement of the conditions for confirming structural adequacy while afloat.
- Inclusion of requirements for fore and aft peak spaces with equipment.
- Note 9 covering a structural test waiver.
- Testing to be carried out to the satisfaction of the Administration instead of the Class Society.

## **.5 Other Resolutions Changes**

None

## **.6 Dates:**

Original proposal: GPG74 FUA 3, 11 April 2013  
Panel submission to GPG: 07 November 2014 by Hull Panel  
GPG Approval: 15 January 2015 (Ref: 11178dIGo)

• **Rev.4 (August 2012)**

**.1 Origin for Change:**

- Request by Hull Panel and the GPG.

**.2 Main Reason for Change:**

To place the testing updates made in the IACS "PROCEDURES FOR TESTING TANKS AND TIGHT BOUNDARIES" (the PROCEDURES) into a new update of UR S14.

The following is a roadmap showing changes made to arrive at Rev. 4.

Roadmap for the Rev. 4 of UR S 14

<b>Section in UR S14 (Rev. 3, May 2010)</b>		<b>Location in UR S14 (Rev. 4, Aug 2012)</b>
14.1.1	Shop primer and final coating	4.5 – Application of Coating
	Structural test	3.1 – Structural test
	Hydropneumatic testing	3.1 – Leak test, 3.2 – Definition, Hydropneumatic test
	Leak testing	3.1 – Leak test
	Hose testing	3.2 – Definition, Hose test
14.1.2	Application - Test conditions	2.1 – Application
	Purpose	1 – General
	Stage of construction at which to test and general testing requirements	4.1 – General test procedure
	Not applicable to CSR BC/OT	(Statement no longer valid)
14.2.1	Structural testing and coating	4.5 – Application of coating, Table 3
14.2.2	Leak testing air pressure	4.4.4 – 4.4.6 (Tank air test, compressed air fillet weld test, and vacuum box test)
	Indicating Liquid	3.2 – Definition - Air test, Compressed air fillet weld test, and vacuum box test
	Test pressure verification (U-tube and gauge)	4.4.4 – U-tube, Master gauge
	Leak testing and coating	4.5 – Application of coating, Table 3
	Other recognized methods	4.4.9 – Other Test
14.2.3	Hose Testing (pressure, nozzle and distance)	4.4.3 – Hose test (pressure, nozzle and distance)
14.2.4	Hydropneumatic	4.4.2 – Hydropneumatic test
14.2.5	Other Testing Methods	4.4.9 –Other Test
14.3	General Testing Requirements	4.1 – General test procedure, Table 1
14.4	Additional Requirements for special type vessels/tanks	Table 2 (although no text as in 14.4)
Table 1	General Testing Requirements	Table 1 – General Testing Requirements
Table 2	Additional testing requirements for spaces within the cargo area of certain types of ships – LNG Carriers	(Direct reference to URs G1 and G2 not made)

<b>Section in UR S14 (Rev. 3, May 2010)</b>		<b>Location in UR S14 (Rev. 4, Aug 2012)</b>
	Additional testing requirements for spaces within the cargo area of certain types of ships – Other vessel types	Table 2 – Additional Test Requirements for Special Service Ship/Tanks
N/A		2.3 – Testing of structures not listed in Table 1 or 2
N/A		4.2.1 – Type and time of test
N/A		4.2.2 – Number of Structural Tests
N/A		4.3 – Leak Test Procedures
N/A		4.4.1 – Hydrostatic Test
N/A		4.4.3 – Hose test practicability
N/A		4.4.7 – Ultrasonic Test
N/A		4.4.8 – Penetration Test
N/A		4.6 – Safe Access to Joints
Based Sec. 14.2.1 and 14.2.2		Table 3 – Application of Leak Test, Coating and Provisions for Safe Access for Type of Welded Joints

### **.3 List of non-IACS Member classification societies contributing through the TC Forum and/or participating in IACS Working Group:**

None.

### **.4 History of Decisions Made:**

The Hull Panel created the PROCEDURES based on Rev. 3 of the UR S14 and then IACS (with the Cook Islands and the Marshall Islands) submitted the PROCEDURES to IMO MSC86 meeting held in May/June 2009 (Ref. Paper MSC 86/23/13, dated 25 February 2009).

The reason for developing the PROCEDURES was to document well established and proven practices used for testing the integrity of watertight compartments intended to contain liquids which are at variance to certain degrees with both the previous requirements of SOLAS (which addressed the testing of subdivision boundaries for watertightness) and the new requirements contained in resolution MSC.194(80) that entered into force on 1 January 2009, which include additional requirements for testing the structural strength of tanks intended to contain liquids. The PROCEDURES were developed to remove variances which will impact all ships to which the requirements of SOLAS chapter II-1 apply.

With the Rev. 4 update, the requirements of UR S14 are confirmed to be applicable to ships to which the Common Structural Rules apply, reversing the application note previously in Rev. 3.

### **.5 Other Resolutions Changes**

None

## **.6 Dates:**

Original proposal: *GPG72 FUA 5*  
Panel submission to GPG: *10 July 2012 (By Hull Panel)*  
GPG Approval: *20 August 2012 (Ref. 11178aIGc)*

### **• Rev.3 (May 2010)**

#### **.1 Origin for Change:**

- Based on IACS Requirement (*Common Structural Rules for Bulk Carriers and Double Hull Oil Tankers*)

#### **.2 Main Reason for Change:**

Following the introduction of the IACS Common Structural Rules for Bulk Carriers and Double Hull Oil Tankers, Hull Panel were tasked to review all the UR S files to consider whether or not they are applicable to ships covered by the CSR.

#### **.3 List of non-IACS Member classification societies contributing through the TC Forum and/or participating in IACS Working Group:**

None.

#### **.4 History of Decisions Made:**

After review it was decided that for CSR ships the requirements of UR S14 are superseded by those of the Common Structural Rules and therefore do not apply.

#### **.5 Other Resolutions Changes**

All UR S files, except UR S8, S9, S15, S16, S19, S22, S23, S30 and S31.

## **.6 Dates:**

Original proposal: *2007, made by Hull Panel Task 50*  
Panel submission to GPG: *19 April 2010*  
GPG Approval: *24 May 2010 (Ref. 10051\_IGd)*

### **• Rev.2 (May 2001)**

See TB document in Part B.

### **• Rev.1 (Feb 2001)**

See TB document in Part B.

### **• NEW (1996)**

No TB document available.

## **Part B. Technical Background**

List of Technical Background (TB) documents for UR S14:

Annex 1. **TB for Rev.1 (Feb 2001)**

See separate TB document in Annex 1.

Annex 2. **TB for Rev.2 (May 2001)**

See separate TB document in Annex 2.

Annex 3. **TB for Rev.7 (Dec 2022)**

See separate TB document in Annex 3.

**Note:** *There are no separate Technical Background (TB) documents for the original resolution (1996), Rev.3 (May 2010), Rev.4 (Aug 2012), Rev.5 (Jan 2015) and Rev.6 (Aug 2016).*

**Technical Background (TB) document for UR S14 (Rev.1 Feb 2001)**

The attached change is proposed in order to eliminate the one Member's reservation on UR S14 – Testing Procedures of Watertight Compartments. It was considered by ABS that application of the requirements of S14.1.2 should not extend to pressure tanks and small gravity tanks. To accommodate this, WP/S agreed that the wording 'tanks, including independent tanks' should be replaced by 'gravity tanks including independent tanks of 5m<sup>3</sup> or more in capacity' as shown on the attached.

The change was agreed unanimously and no unresolved issues remain.

Submitted by WP/S Chairman on 9 January 2001

## Technical Background (TB) document for UR S14 (Rev.2 May 2001)

### a) Objective/Scope

Further to adoption of Rev.1 (February 2001) to eliminate a Member's reservation on S14.1.2, there was a need to remove the ambiguity of the changes made in Rev.1, thereby achieving uniform implementation in practice.

### b) Source of Proposed Requirements

One Member provided an editorial improvement to S14.1.2.

### c) Points of Discussion

- On Member further proposed that all types of gravity tanks under 5 m<sup>3</sup> (small integral gravity tanks inclusive) should be exempted from S14. No discussion was pursued by GPG. However, ABS pointed out that SOLAS II-1/Reg.14.4 requires hydrotesting of double bottom testing and II-1/14.5 requires tanks forming part of subdivision bulkheads to be likewise tested.
- This revision was limited to achieve the clarity of S14.1.2.
- After exchange of alternative wordings for the first bullet of S14.1.2, the following wording was finally agreed by GPG: S 14.1.2 - "*gravity tanks, excluding independent tanks of less than 5 m<sup>3</sup> in capacity.*"

**Remark:** When incorporating the revisions of UR S14 into their Rules, Member Societies are to ignore Rev.1 (Feb 2001).



## Technical Background (TB) document for UR S14 (Rev.7 Dec 2022)

### 1 Aims

UR S14 Rev. 6 'Testing Procedures of Watertight Compartments' provides tank testing requirements which were in part developed to address the SOLAS tank testing requirements however UR S14 Rev. 6 is also applicable to small non-SOLAS ships and yachts. Hence, it was decided to investigate the applicability of the SOLAS requirements as well the appropriateness of the tank testing requirements given in UR S14 Rev. 6 to small ships.

### 2 Applicability of UR S14 Rev. 6

According to Vol 1 IACS General Procedures Part A;

*Generally, and unless stated otherwise, IACS's scope of interest and activity is with respect to vessels of over 100 GT of whatever type, self-propelled or not, restricted or unrestricted service; except for "inland waterway" vessels, military vessels, and other government ships operated for non-commercial purposes.*

Hence, UR S14 Rev. 6 is applicable to all passenger ships and cargo ships over 100 GT (except IWW and Great Lakes) including work boats, yachts, high speed craft, barges, pontoons, fishing vessels and domestic ferries and irrespective of the material of construction.

### 3 Review of Statutory requirements

#### 3.1 Applicability of SOLAS

The applicability of the SOLAS tank testing requirements are as follows;

- All passenger ships engaged on international voyages (carries more than 12 passengers)
- Cargo ships greater than or equal to 500 GT engaged on international voyages

SOLAS does not apply to;

- Ships of war and troopships
- Cargo ships of less than 500 GT
- Ships not propelled by mechanical means
- Wooden ships of primitive build
- Pleasure yachts not engaged in trade
- Fishing vessels

The SOLAS tank testing requirements are given in Pat B-2, Regulation 11;

*1 Testing watertight spaces not intended to hold liquids and cargo holds intended to hold ballast by filling them with water is not compulsory. When testing by filling with water is not carried out, a hose test shall be carried out where practicable. This test shall be carried out in the most advanced stage of the fitting out of the ship. Where a hose test is not practicable because of possible damage to machinery, electrical equipment insulation or outfitting items, it may be replaced by a careful visual examination of welded connections, supported where deemed necessary by means such as a dye penetrant test or an ultrasonic leak test or an equivalent test. In any case a thorough inspection of the watertight bulkheads shall be carried out.*

*2 The forepeak, double bottom (including duct keels) and inner skins shall be tested with water to a head corresponding to the requirements of regulation 10.1. (Head of water up to the bulkhead deck of passenger ships and the freeboard deck of cargo ships.)*

*3 Tanks which are intended to hold liquids, and which form part of the watertight subdivision of the ship, shall be tested for tightness and structural strength with water to a head corresponding to its design pressure. The water head is in no case to be less than the top of the air pipes or to a level of 2.4 m above the top of the tank, whichever is the greater.*

*4 The tests referred to in paragraphs 2 and 3 are for the purpose of ensuring that the subdivision structural arrangements are watertight and are not to be regarded as a test of the fitness of any compartment for the storage of oil fuel or for other special purposes for which a test of a superior character may be required depending on the height to which the liquid has access in the tank or its connections.*

### **3.2 Background to the SOLAS requirements**

The requirement to test tanks originally introduced into the 1914 draft SOLAS Convention (which was not ratified due to the outbreak of World War I) and the requirements were as follows;

*Double bottoms, deep tanks and all compartments intended to hold liquids shall be tested with water at least to a head eight feet above the top of the tank or to the load waterline, whichever is greater.*

Unfortunately, in the Minutes of Proceedings there is no background provided as to why 8 ft was selected as a suitable margin for the structural testing. However, at the time the British Board of Trade were investigating the strength of bulkheads and had authorised the construction of experimental watertight bulkheads with the aim of 'providing a proper margin of resistance'. These experiments are described in 'Strength of Watertight Bulkheads' by J. Foster (read at the spring meeting of the 57th session of the Institution of Naval Architects, 1916).

It seems that for the majority of bulkheads, the maximum deflection recorded before the bulkheads started experiencing plastic deformation was at around 8ft of additional head above the top of the bulkhead. Some bulkheads started failing earlier and the paper discusses changes made to the bulkhead (bracket design etc.) to improve the performance. Although not explicitly stated it is clear that the British Board of Trade decided that 8ft was a suitable margin; partly because it was largely achievable for existing bulkhead designs but also because 8ft was the standard height of a tween deck. It should be noted that the smallest bulkhead tested had a height of 13.75 ft which is approximately 4.2 metres and this bulkhead was one of the ones requiring reinforcement. The smallest height bulkhead where 8ft did not cause damage was 17 ft which is approximately 5.2 metres. Hence, it can be concluded that very small ships were not considered when the standard was set.

This is relevant for the 1914 draft SOLAS convention because the committee drafting the convention was led by Sir Archibald Denny who was British and there is mention of the British Board of Trade submitting a report on the strength of bulkheads to the committee. It had already been decided that it was too complicated to mandate bulkhead scantlings in the SOLAS convention and to rely on Class requirements but a test to 'an appropriate head' had been proposed. It seems likely that the British pushed for the test head to be 8 ft in order to guarantee their proposed 'margin of resistance'.

it is interesting to note that the 1929 SOLAS Convention states the following;

*Tanks which are intended to hold liquids, and which form part of the subdivision of the ship, shall be tested for tightness with water to a head up to the deepest subdivision waterline or to a head corresponding to two-thirds of the depth from the top of keel to the margin line in way of the tanks, whichever is the greater; provided that in no case shall the test head be less than 3 feet above the top of the tank.*

When viewed in the light of the extensive damage cases arising from World War I, one explanation could be that the reduced margin was informed by real world data. It is possible that the original intention of the SOLAS requirements was to ensure the survival of the watertight subdivision in the event of flooding and that might be why the margin of safety was reduced to 3 ft above the top of the tank rather than 8 ft. This is borne out by the 1948 SOLAS Convention which retained the above requirement and went on to state that;

*The tests referred to in paragraphs (d) and (e) are for the purpose of ensuring that the subdivision structural arrangements are watertight and not to be regarded as a test of fitness of any compartment for the storage of oil fuel or for other special purposes for which a test of a superior character may be required depending on the height to which the liquid has access in the tank or its connections.*

The above requirements were retained in both the 1960 SOLAS Convention and the 1974 SOLAS Convention. The current requirements were introduced in MSC 216(82) in 2006; the technical background for the 2.4 metres is given in SLF 44-3-4 where it is stated that IACS UR S14 was used as the basis for the 2.4 metres and the following is noted;

*It is to be noted that the proposed margin of 2.4 m might be too stringent in the case of smaller ships and will need further discussion.*

However, it appears that no further discussions took place on the appropriateness of the above requirements and they were accepted on the basis of being class requirements and to a higher standard than SOLAS. The technical background for the original version of UR S14 is not available however prior to 1996 some class societies were using 2.4 metres (or similar) in their Ship Rules although not in their other Rule sets. It is important to note that the application of this test pressure to small ships would have been based on a set of assumptions concerning required safety margins and it is possible that an individual class society might have been accounting for the size of tank elsewhere in their rules when deriving the scantlings of bulkheads.

### **3.3 Other statutory requirements**

A review of other statutory requirements was carried out to determine what their tank testing requirements are, and these are as follows;

#### **The Passenger Yacht Code (PYC)**

Applies to yachts carrying between 12 and 36 passengers; the tank testing requirements are given in Part III, Regulation 4.13;

- (1) *Testing of watertight spaces not intended to hold by filling them with water is not compulsory but where such testing is not carried out-*
  - (a) *a hose test shall be carried out where practicable;*
  - (b) *this test shall be carried out in the most advanced stage of the fitting out of the ship;*
  - (c) *where a hose test is not practicable because of possible damage to machinery, electrical equipment insulation or outfitting items, it may be replaced by a careful visual examination of welded connections, supported where deemed necessary by means such as a dye penetrant test or an ultrasonic leak test or an equivalent test; and*
  - (d) *in any case a thorough inspection of the watertight bulkheads shall be carried out.*

(2) *The forepeak, double bottom (including duct keels) and inner skins shall be tested with water to a head corresponding to the requirements of section 4.12(1). (head of water up to the bulkhead deck)*

(3) *Tanks which are intended to hold liquids, and which form part of the watertight subdivision of the ship, shall be tested for tightness and structural strength with water to a head corresponding to its design pressure and the water head is in no case to be less than the top of the air pipes or to a level of 2.4 metres above the top of the tank, whichever is the greater.*

Essentially, the requirements are the same as SOLAS.

### **The Large Commercial Yacht Code (LY3)**

Applies to yachts greater than 24 metres which are in commercial use for sport or pleasure, carry no cargo and no more than 12 passengers. The requirements for watertight bulkheads refer out to Class requirements however yachts subject to LY3 which are greater than 500 GT are also subject to SOLAS.

### **High Speed Craft Code, 2000**

Applies to high speed craft engaged in international voyages and;

- Passenger craft which do not proceed in the course of their voyage more than four hours at 90% of maximum speed from a place of refuge; and
- Cargo craft of 500 gross tonnage and upwards which do not proceed in the course of their voyage more than eight hours at 90% of maximum speed from a place of refuge when fully laden.

The HSC Code does not contain any explicit requirements for tank testing however given that it is general principle that for aspects which are not covered by IMO Codes, reference is to be made to the relevant IMO Conventions, then the SOLAS requirements are applicable to vessels which are subject to the HSC Code.

### **MGN 280 – Small Vessels in Commercial Use for Sport or Pleasure, workboats and Pilot Boats – UK**

Applies to UK vessels up to 24 metres Load Line length which are engaged at sea in activities on a commercial basis, which carry cargo and/or not more than 12 passengers, or provide a service in which neither cargo nor passengers are carried, or are UK pilot boats of whatever size.

There are no explicit tank testing requirements however;

*The design of hull structure and construction should provide strength and service life for the safe operation of a vessel, at its service draught and maximum service speed, to withstand the sea and weather conditions likely to be encountered in the intended area of operation.*

### **Guidelines for Survey of Fishing Vessels 15 m Length Overall and Over – Ireland**

Applies to fishing vessels which are over 15 metres in length, and which are not classed.

Part B, Section 1.1 stipulates;

*Boundaries of double bottom, deep, ballast, peak and other tanks are to be tested with a head of liquid to the top of air pipes, except that fuel oil and lube oil tanks may be tested to the highest point that liquid will rise under service condition. Tank testing of fuel oil, lube oil*

*and fresh water tanks may be specially considered based on satisfactory external examination of the tank boundaries.*

### **Large Fishing Vessel Inspection Regulations – Canada**

Applies to fishing vessels greater than 24.4 metres or 150 GT that are not sailing ships.

The tank testing requirements are given in Regulation 18;

*Before a steel fishing vessel is launched, the compartments within the main hull shall, before the cementing is commenced, be subjected to hose or pressure tests as follows:*

- (a) double bottoms that are not to be used for the carrying of oil shall be tested to a head of water equal to the maximum head that can be experienced in service;*
- (b) deep tanks and peak tanks used for carrying water, and deep tanks and double bottom tanks arranged for carrying oil fuel shall be tested to a head of water equal to the maximum head to which the tanks can be subjected in service, but not less than 2.44 m above the crown of the tanks where the moulded depth to the strength deck exceeds 4.88 m, and 915 mm where the moulded depth does not exceed 3.05 m; intermediate heads may be obtained by interpolation between 4.88 and 3.05 m;*
- (c) peak bulkheads that do not form the boundaries of tanks shall be tested by filling the peaks with water to the level of the load water line;*
- (d) watertight bulkheads, including recesses and watertight flats, watertight tunnels, weatherdecks and waterways, shall be hose tested; the pressure of water in the hose shall not be less than 207 kPa;*
- (e) watertight doors shall be tried under working conditions and hose tested; the pressure in the hose shall not be less than 207 kPa.*

### **Construction and Outfit Standards – Fishing Vessels of less than 15 metres – UK**

Applies to commercial fishing vessels of less than 15 metres length overall

The tank testing requirements are given in Part 1, Section 1.7

*Freshwater, ballast, oil fuel, and other tanks, void spaces and collision bulkheads should be either water or air pressure tested at the discretion of MCA or the Fishing Vessel Certifying Authority.*

*Where water tested, the head in integral tanks is to be not less than 2.4m above the tank top or to the overflow point whichever is the greater.*

*Where tested by air pressure, the test pressure is to be no greater than 0.2kg/cm<sup>2</sup> (2.85 psi).*

*Fish stowage tanks and vivier tanks are to be tested by filling with water to overflow level.*

### **Japan Craft Inspection Organisation**

Applies to all craft less than 24 metres; tanks are to be tested either hydrostatically to the top of the overflow or with an air test to 0.025 MPa.

### **ISO 21487 – Small Craft – Permanently Installed Petrol and Diesel Fuel Tanks**

Applies to craft less than 24 metres.

*Petrol fuel tanks are to be leakage tested in accordance with 7.2.1. (Pressure of 20 kPa)*

*Petrol fuel tanks shall be pressure tested in accordance with 7.3. Metallic tanks may as an alternative be pressure tested in accordance with 7.2.2 using a pressure which is the higher of the following;*

- *30 kPa; or*
- *1.5 times the highest hydrostatic pressure to which the tank may be subjected in service (maximum fill-up height above the tank top) plus 10 kPa*

### **Division 242 Recreational Vessels with a Hull Length of 24 m or more and of Gross Tonnage of less than 3000 – France**

There are no explicit tank testing requirements however the requirements for bulkheads refer out an approved body in Article 242-3.04;

*Sealed bulkheads shall meet the requirements of this Article. Their positions shall ensure that the vessel remains sufficiently buoyant to meet damage stability requirements, where appropriate.*

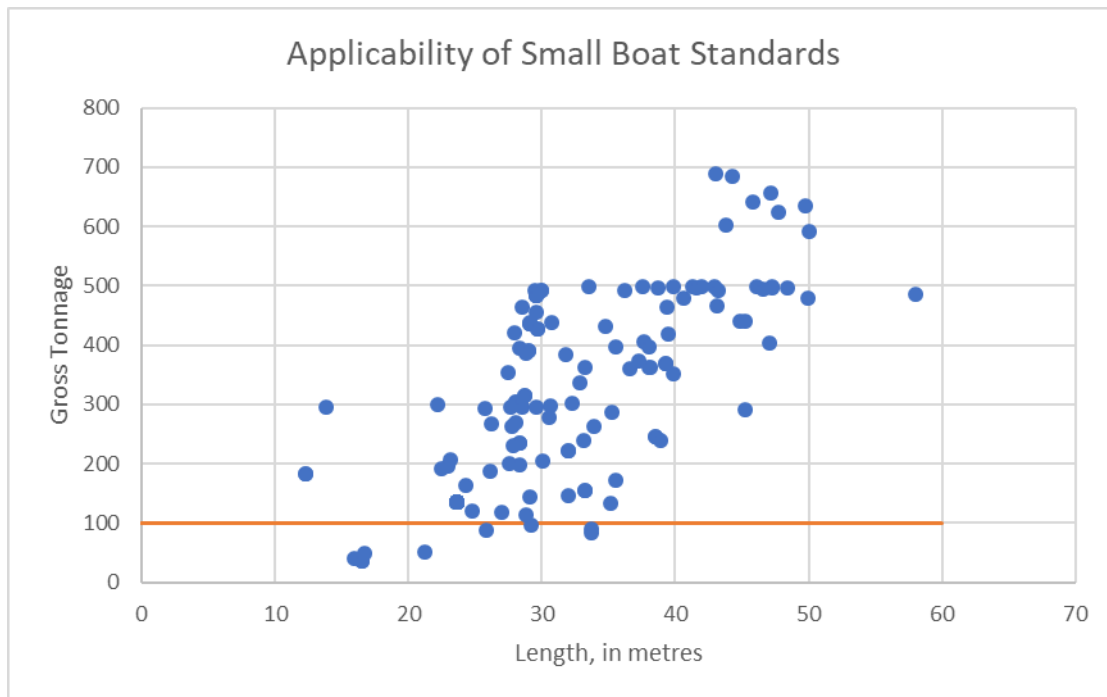
*Their resistance, watertightness and the openings and gangways installed therein shall meet the requirements of an approved body.*

### **Other Flag Requirements**

Although many Flags have requirements for small vessels, most of these refer out to Class requirements for tank construction and testing and do not have their own explicit requirements.

### **3.4 Relevance of Small Boat Requirements**

To determine the relevance of the national and international standards it is necessary to relate the lower limit of UR S14 (100 GT) to the lower limit used by the national and international standards which are primarily length based. The tonnage certificates (both ITC 69 and Certificate of Measurement) issued by Lloyd's Register's Southampton Office between 2015 and March 2021 were analysed and the Gross Tonnage (up to 700 GT) was plotted against length. As can be seen from Figure 1, the least ship length for a Gross Tonnage greater than 100 GT is approximately 12 metres. Hence, all of the small boat standards identified in the standards review will be taken into account when developing appropriate tank testing requirements.



**Figure 1**

### 3.5 Conclusion

A review of the various standards shows that the various ship types can be categorised as follows;

- International cargo ships > 500 GT
- International cargo ships <= 500 GT
- Domestic cargo ships > 100 GT
- International passenger ships > 100 GT
- Domestic passenger ships > 100 GT
- Fishing vessels > 100 GT
- International passenger yachts > 100 GT
- Domestic passenger yachts > 100 GT
- International commercial yachts > 500 GT
- International commercial yachts <= 500 GT
- Domestic commercial yachts > 100 GT
- Pleasure yachts > 100 GT
- International cargo HSC > 500 GT
- International cargo HSC <= 500 GT
- Domestic cargo HSC > 100 GT
- International passenger HSC > 100 GT
- Domestic passenger HSC > 100 GT
- Barges and pontoons > 100 GT
- Domestic workboats > 100 GT

All of these vessel types are covered by UR S14 (for GT > 100) however it should be noted that SOLAS only applies to the following vessels;

- International cargo ships > 500 GT
- International passenger ships
- International passenger yachts
- International commercial yachts > 500 GT

- International cargo HSC > 500 GT
- International passenger HSC

In practical terms there is no difference between a ship engaged on an international voyage and one engaged on a domestic voyage when it comes to the strength of the bulkhead; the reason the SOLAS requirements are limited to ships engaged on international voyages is due to the IMO having no jurisdiction over domestic vessels. Furthermore, ships engaged on international voyages are no more likely to experience a flooding event than domestic vessels (indeed it could be argued that the reverse is true as the likelihood of grounding or collision increases for ships close to the coastline/port).

From a 'strength of bulkhead point of view there is no difference between a cargo ship and a passenger ship and hence there is no real justification for having different tank testing requirements for a cargo ship  $\leq$  500 GT than for a domestic passenger ship less than 500 GT. Therefore, the question is not so much about how strong the bulkhead should be but what is the acceptable risk to the ship in the event of the bulkhead failing

It is clear that for small cargo ships the IMO is prepared to accept a greater degree of risk which they are not prepared to accept for small passenger ships engaged on international voyages. Furthermore, since no flags have introduced mandatory tank testing requirements for large domestic passenger ships let alone small passenger ships it must be concluded that the main driver for there being tank testing requirements for all passenger ships engaged on international voyages is the combination of passengers and the international voyage. Passengers on ships in international waters are less likely to be rescued quickly in the event of a casualty and hence the risk to life is higher. Hence, there is no reason to impose stricter requirements for domestic passenger ships than for cargo ships.

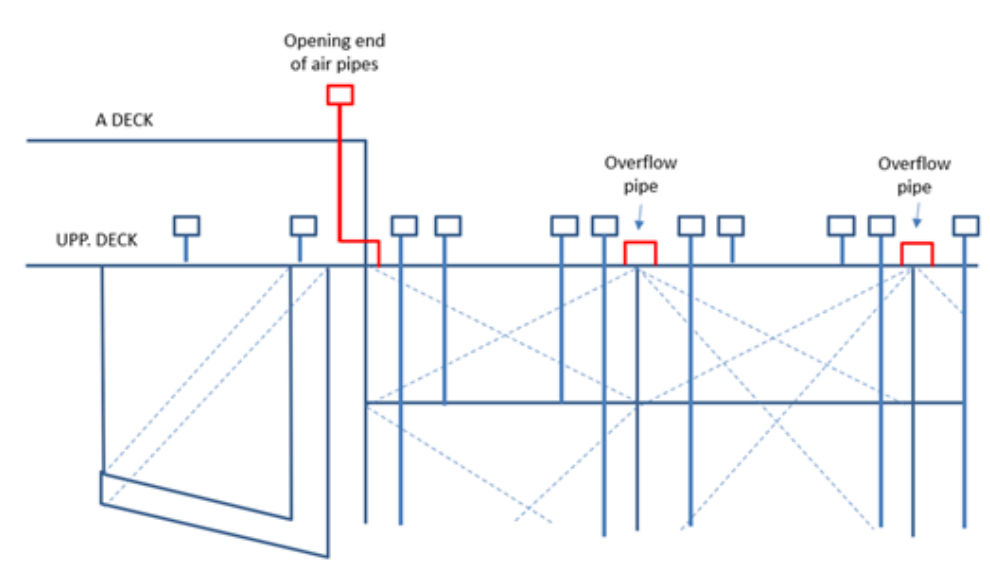
#### **4. Investigation into test pressure**

##### **4.1 Air pipe and overflow arrangements**

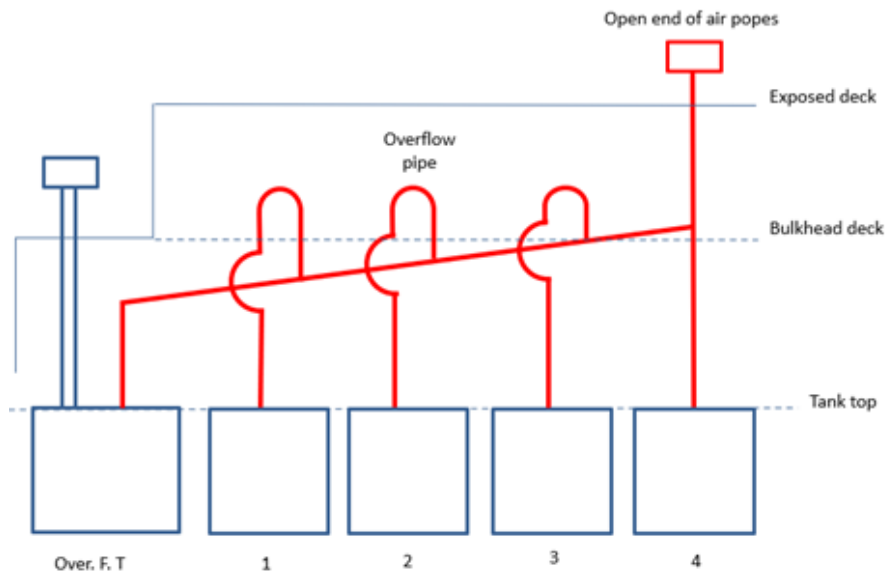
When determining the test head, IACS UR S14 refers to the height of the overflow whereas SOLAS refers to the height of the air pipe. This difference is critical as Class Rules treat overflows and air pipes differently; essentially an overflow is fitted where the height of the air pipe exceeds the pressure head to which the tank has been designed. Hence the height of the overflow can be lower than the height of the air pipe; especially for double bottom tanks where an overflow tank can be used. It also important to note that the overflow is not necessarily an overflow pipe. In fact, the overflow is any device used to prevent the overfilling of a tank and can be an airpipe, overflow pipe, intermediate tank or high-level alarm.

In many classification rules, the height of the overflow is used as the basis for the design head, but when a tank has an overflow pipe and an air pipe, as in Figures 2 and 3 which give an example of a typical overflow pipe and air pipe arrangement, it is not clear which should be used for the basis of the test pressure. Therefore, consideration needs to be given to determining the highest point to which the liquid will rise in service. For example, for cargo tanks which could have a vent and an overflow pipe, the presence of high-level alarms and cargo filling procedures means that overfilling the tank is not likely to occur. The governing criteria for these tanks is hence the requirement to test to 2.4 metres above the top of the tank.



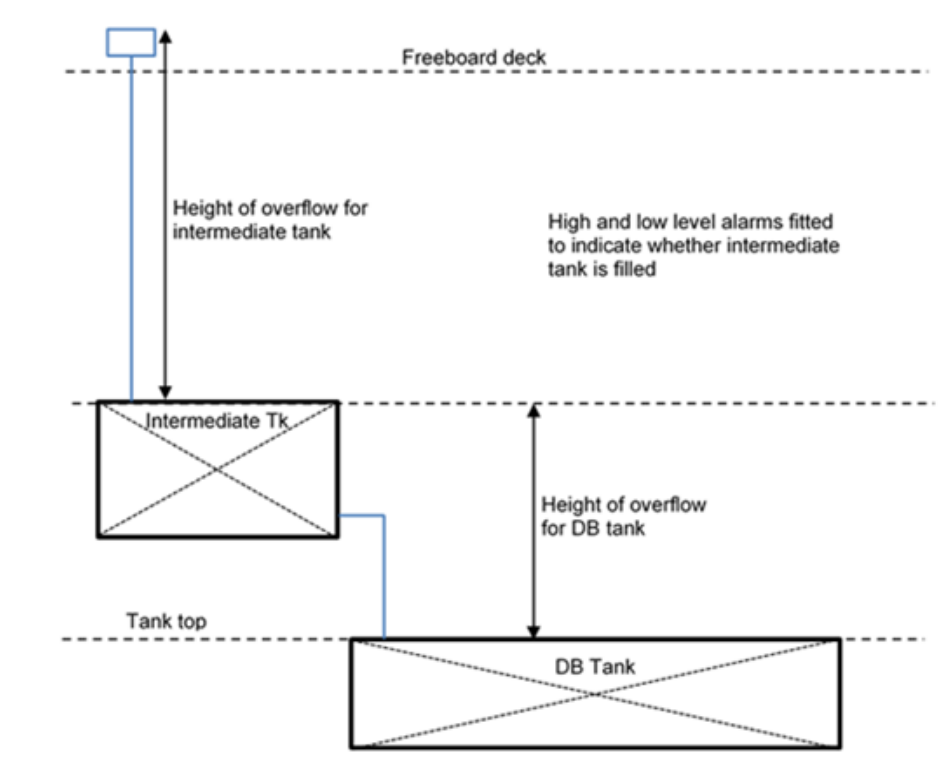


**Figure 2**



**Figure 3**

As an alternative to the standard overflow arrangement, it is also possible to use an intermediate tank to reduce the design loads for double bottom tanks, see Figure 4 below.



**Figure 4**

The design pressure for the double bottom tank is based on the distance to the top of the intermediate tank and the design pressure for the intermediate tank is based on the height of the air pipe. In this case the "overflow pipe" referred to in UR S14 is not the line connected to the double bottom tank but the opening of the line leading onto the freeboard deck, which is the reference point for the test head. This case is rare and is less relevant for small ships which are unlikely to have this arrangement.

In cases where the height of the air pipe or overflow above the crown of the tank is less than 2.4m, UR S14 and SOLAS require a hydrostatic test with a minimum test pressure of 2.4m. The concern here is that for small ships with small tanks, the test pressure is significantly larger in relation to the anticipated in-service loads and hence design pressure than it is for large ships. This is primarily relevant for wing tanks and cargo tanks as for double bottom and small engine room tanks, the height of the overflow will normally exceed 2.4 metres.

It is concluded that difference between the design pressure and the test pressure is only an issue for small ships in the case of wing tanks and cargo tanks where the crown of the tank corresponds to the bulkhead deck and therefore the overflow pipe is less than 2.4m. This arrangement will be used for the investigation into the relationship between test pressure and design pressure.

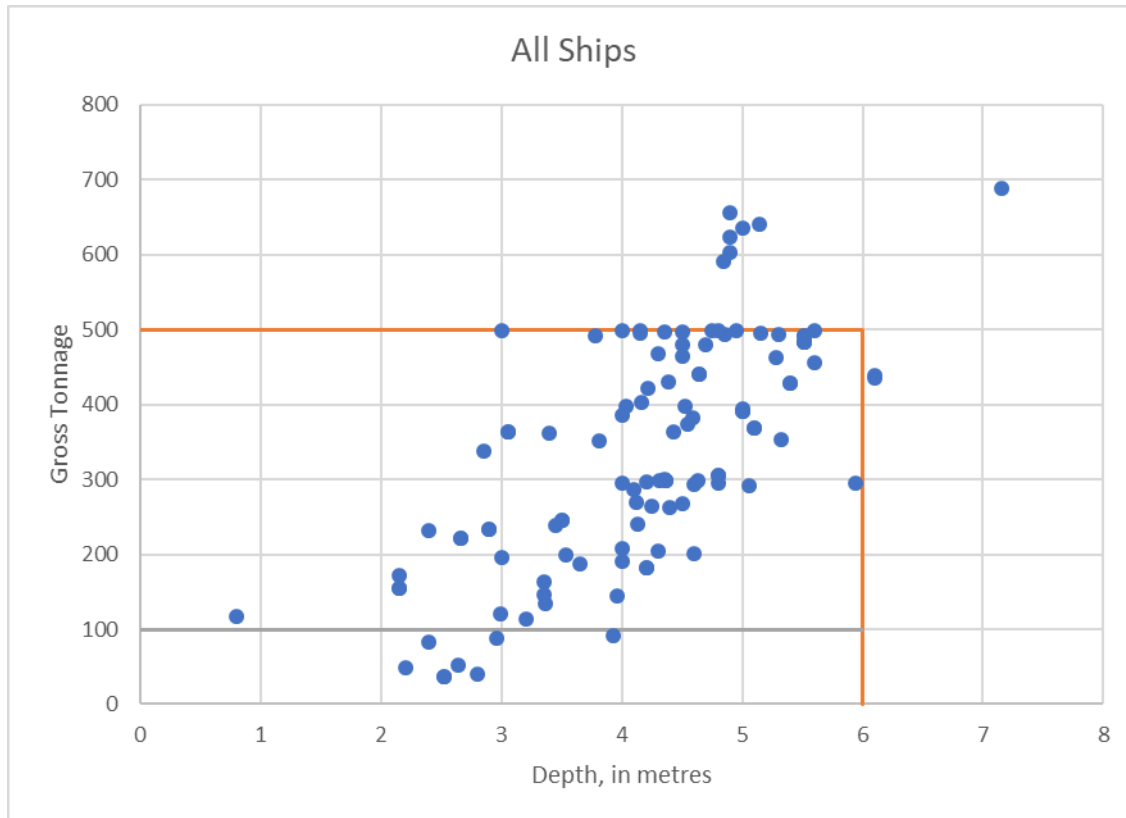
#### **4.2 Design pressure v test pressure**

The relationship between the test pressure and the design pressure was investigated to determine the appropriate minimum test pressure for small tanks.

It is the responsibility of the class society to ensure that the design pressure and associated stress level used to obtain bulkhead scantlings is such that the tank will not fail subjected to the test pressure. However, the means by which this is achieved varies. Some class societies consider the test pressure as a separate load case with its own allowable stress factor. Other class societies relate the design pressure to the test pressure and some do not

consider the test pressure at all and instead use a lower stress factor (inverse of safety margin) for the design pressure in order to achieve a safety margin which will cover tank testing. This variation in approach can be seen in Figure 6.

In order to determine the depth of ship (a more useful measure for the purposes of tank test pressures than ship length) which generally corresponds to 500 GT, the gross tonnages reviewed in Section 3.4 were re-analysed. As Figure 5 shows, the majority of ships with a gross tonnage less than 500 GT also have a depth less than 6 metres. Therefore, the range of depths considered will be limited on this basis.



**Figure 5**

The plate thicknesses required by each IACS Member for ships with a depth up to 6 metres (small ships) were calculated based on both the design pressure and the required test pressure; the height of the tank was assumed to be the same as the depth of the ship. The resulting plate thicknesses were then used to reverse engineer the CSR plating formula.

The CSR plate formula is as follows:

$$t = 0.0158\alpha_p b \sqrt{\frac{|P|}{\chi C_a R_{eH}}}$$

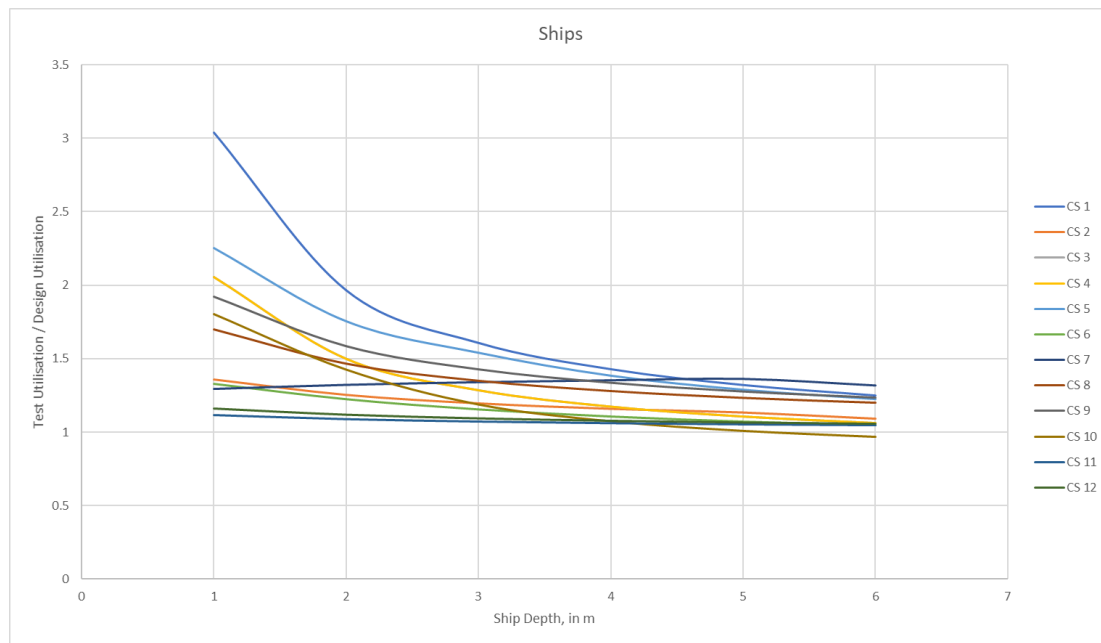
Rearranging for  $C_a$  (stress factor) gives:

$$C_a = \frac{|P|(0.0158\alpha_p b)^2}{\chi R_{eH} t^2}$$

By calculating the required plate thickness for a given design pressure it is possible to first obtain the stress factor associated with the design pressure and then the stress factor associated with the test pressure. For Class Societies where the test pressure is not directly

considered when calculating the required plate thickness, the plate thickness associated with the design pressure was used for both the design and test cases.

The ratio of the test case stress factor to the design case stress factor was then calculated and plotted. Note that although a simpler method to obtain the utilisation ratio would have been to just divide the test pressure by the design pressure this would not have accounted for the approach where the test pressure has its own stress factor.



**Figure 6**

As Figure 6 shows the utilisation ratio generally increases as the ship depth reduces (although in most cases the stress does not exceed yield). This is because the smaller tanks the test pressure is much greater in comparison to the design pressure. Even where a higher stress factor is used in association with the test pressure, a slight increase in the utilisation ratio can be seen (e.g. CS 12) where the utilisation at 1 metre is 1.06 and at 6 metres is 1.16). This suggests that in order to account for tank testing, Class Societies have had to increase bulkhead scantlings generally and for small tanks in particular.

The question then becomes whether it is reasonable to firstly base all tank scantlings on the stress factor required for a small tank to not exceed yield and secondly to require a higher level of safety for small tanks than for large tanks. Ultimately, it does not make sense for a work boat to be required to have a higher safety level than an oil tanker or passenger ship and hence it seems reasonable to set the test pressure such that the increase in stress is similar to that seen for ships where the SOLAS test pressure is applicable. To determine what this test pressure should be, the average utilisation ratio across all IACS members was calculated for a 6-metre depth ship (the smallest size ship to which SOLAS is generally applicable). This utilisation ratio was calculated to be 1.14; i.e. for a ship with a depth of 6 metres, the acceptable increase in stress in the plate is 14%. This compares well to the CSR where the utilisation ratio is 1.11 (the CSR uses the same allowable stress for the tank testing load case as for the static load case).

### 4.3 Proposed test pressure

It is proposed to use a minimum test pressure head which is linked to the depth of the ship where for ships where depth is less than 6 metres, the minimum test pressure head will be calculated as follows in order to achieve a target utilisation of around 1.1;

$$\text{Test pressure} = 0.3D + 0.76$$

or 2.4 metres whichever is lesser.

This results in the following test heads;

Depth of Ship	Min test head
6 metres	2.4 metres
5 metres	2.26 metres
4 metres	1.96 metres
3 metres	1.66 metres
2 metres	1.36 metres
1 metres	1.06 metres

Note that in no case can the test pressure be less than the minimum airpipe height of 0.76 metres.

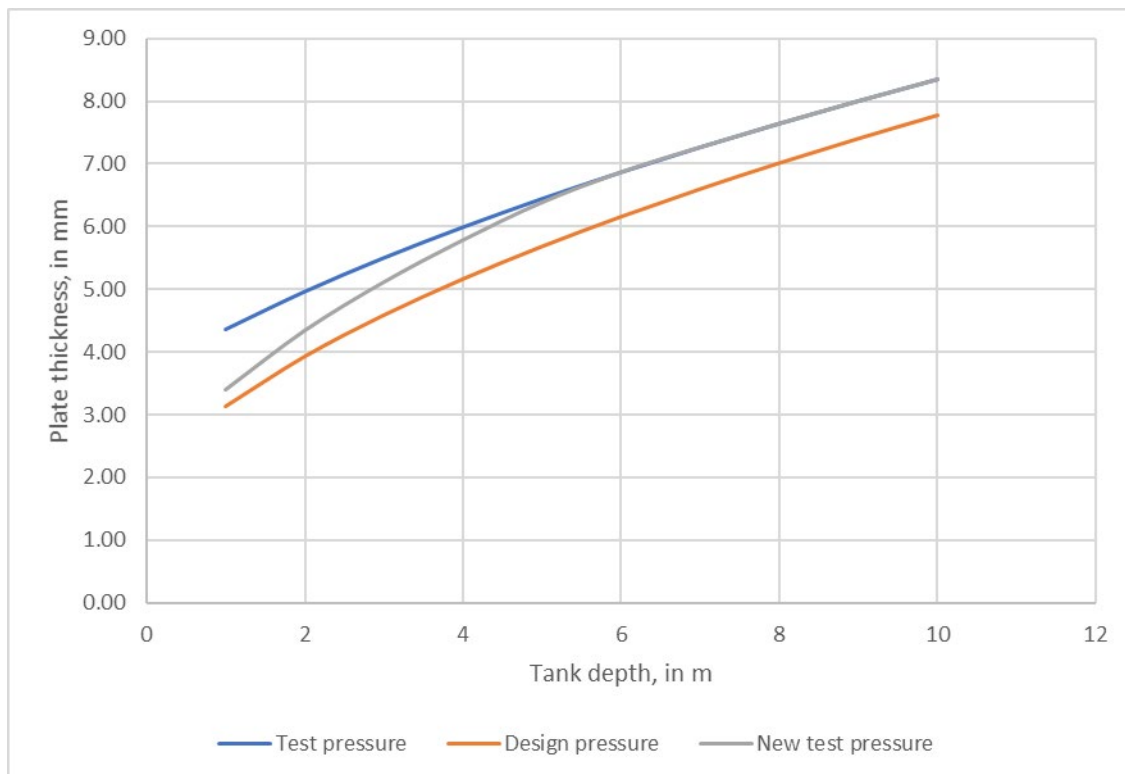


Figure 7

To confirm the resulting stress levels, the net plate thicknesses required by the CSR BC & OT for transverse bulkheads were calculated for a spacing of 650 mm, an aspect ratio of 1 and  $C_{a-max} = 0.8$ .

D (m)	Design p (kN/m <sup>2</sup> )	Design t (mm)	Test p (kN/m <sup>2</sup> )	Test t (mm)	Ratio	New test p (kN/m <sup>2</sup> )	New test t (mm)	Ratio
10	107.6	7.77	124	8.34	1.07	124	8.34	1.07
9	97.6	7.40	114	8.00	1.08	114	8.00	1.08
8	87.6	7.01	104	7.64	1.09	104	7.64	1.09
7	77.6	6.60	94	7.26	1.10	94	7.26	1.10
6	67.6	6.16	84	6.86	1.11	84	6.86	1.11
5	57.6	5.68	74	6.44	1.13	72.6	6.38	1.12
4	47.6	5.17	64	5.99	1.16	59.6	5.78	1.11
3	37.6	4.59	54	5.50	1.20	46.6	5.11	1.11
2	27.6	3.94	44	4.97	1.26	33.6	4.34	1.10
1	17.6	3.14	34	4.37	1.39	20.6	3.40	1.08

This results in a utilisation ratio of 1.12 for a 5 metre tank depth and 1.08 for a 1 metre tank depth. The corresponding reduction in plate thickness is largely insignificant for the 4 and 5 metre tank depths but is 0.5 mm for the 3 metre tank depth and 1 mm for the 1 metre tank depth (after rounding).

## 5 Review of survey practices

As part of the investigation into whether the tank testing requirements given in UR S14 Rev. 6 are appropriate for small ships, information was obtained from each IACS member concerning the following:

- Practical limitations of tank testing
- Types of tests conducted
- Failures due to overloading
- Failures due to tank material
- Smallest tank size tested

When the failures due to tank testing were investigated it was found that the failure rate during structural tank testing was less than 5%. A couple of cases concerned the failure of the equipment, e.g. the pressure gauge failed and so the applied test pressure was greater than required. Other examples relate to the tank testing not being carried out correctly however, the majority of failures appear to be because the bulkheads were too weak.

For the majority of ships, the new construction tank testing requirements given in UR S14 are satisfactory however for smaller tanks (and hence small ships), in practice the surveyors are waiving the structural test and relying on the leak test only. It is therefore proposed to introduce a lower limit for the size of tank which needs to be structurally tested of a volume of 2m<sup>3</sup>.

For composites, issues were reported relating to the test procedures however due to the wide variation in composites and construction methods, it would be very difficult to include a prescriptive requirement which covers all composite tanks. Instead, a statement will be included in UR S14 that test procedures need to be discussed and agreed with the composite manufacturer in order to achieve equivalency to the test required for steel tanks.

## UR S17 “Longitudinal Strength of Hull Girder in Flooded Condition for Non-CSR Bulk Carriers”

### Summary

Clarification that this UR S17 is applicable to self-unloading bulk carrier only if the unloading system maintains the watertightness during seagoing operations.

### Part A. Revision History

Version no.	Approval date	Implementation date when applicable
Rev.10 (Mar 2019)	04 March 2019	1 July 2020
Rev.9 (Apr 2014)	17 April 2014	1 July 2006
Rev.8 (May 2010)	24 May 2010	1 July 2006
Corr.1 (Oct 2009)	15 October 2009	-
Rev.7 (Feb 2006)	1 February 2006	1 July 2006
Rev.6 (July 2004)	5 July 2004	-
Rev.5 (June 2003)	20 June 2003	1 July 2003
Rev.4 (June 2002)	20 June 2002	-
Rev.3 (Sept 2000)	7 September 2000	1 July 2001
Rev.2 (1998)	28 May 1998	-
Rev. 1 (1997)	4 November 1997	-
NEW (1997)	8 September 1997	1 July 1998

#### • Rev.10 (Mar 2019)

##### 1 Origin for Change:

- Request by GPG 15139\_IGh dated 18/9/2016

##### 2 Main Reason for Change:

The applicability of ESP to the self-unloading bulk carriers (SUBC) leads to the GPG request to identify the UR S which are NOT applicable to SUBC.

The Hull Panel decided to insist on the fact that the flooding conditions considered in the UR S17 and 18 are relevant for each cargo hold if the unloading system watertightness is maintained during the seagoing conditions.

##### 3 List of non-IACS Member classification societies contributing through the TC Forum and/or participating in IACS Working Group:

None

##### 4 History of Decisions Made:

Discussion at the HP meeting in 2016

Analysis by Hull Panel Chair  
Discussion and decision by the Hull Panel in 2018

## 5 Other Resolutions Changes:

Within this study for SUBC application: UR S18, 21A and 30.

## 6 Any hinderance to MASS, including any other new technologies:

None

## 7 Dates:

Original Proposal: 14 June 2018                      Made by: Hull Panel  
Panel Approval: 11 December 2018  
GPG Approval: 04 March 2019 (Ref. 15139\_IGI)

### • **Rev.9 (Apr 2014)**

#### .1 Origin for Change:

Suggestion by IACS member

#### .2 Main Reason for Change:

To clarify the scope of application of UR S17, S18 and S20.

#### .3 List of non-IACS Member classification societies contributing through the TC Forum and/or participating in IACS Working Group:

None.

#### .4 History of Decisions Made:

It was decided not to assign implementation dates for versions Corr.1 (Oct 2009), Rev.8 (May 2010) and Rev.9 (April 2014) because these revisions/corrections are retrospectively applicable from 1 July 2006 i.e. the assigned date of implementation of Rev.7 (Feb 2006).

#### .5 Other Resolutions Changes

UR S18 and UR S20

#### .6 Dates:

Original proposal: 19 Feb 2014, made by Hull Panel Chair  
Panel submission to GPG: 01 Apr 2014  
GPG Approval: 17 April 2014 (14044\_IGb)

### • **Rev.8 (May 2010)**



**.1 Origin for Change:**

- Based on IACS Requirement (*Common Structural Rules for Bulk Carriers and Double Hull Oil Tankers*)

**.2 Main Reason for Change:**

Following the introduction of the IACS Common Structural Rules for Bulk Carriers and Double Hull Oil Tankers, Hull Panel were tasked to review all the UR S files to consider whether or not they are applicable to ships covered by the CSR.

**.3 List of non-IACS Member classification societies contributing through the TC Forum and/or participating in IACS Working Group:**

None.

**.4 History of Decisions Made:**

After review it was decided that for CSR bulk carriers the requirements of UR S17 are superseded by those of the Common Structural Rules and therefore do not apply.

UR S17 is not applicable for CSR oil tankers.

**.5 Other Resolutions Changes**

All UR S files, except UR S8, S9, S15, S16, S19, S22, S23, S30 and S31.

**.6 Dates:**

Original proposal: 2007, made by Hull Panel Task 50  
Panel submission to GPG: 19 April 2010  
GPG Approval: 24 May 2010 (Ref. 10051\_IGd)

**• Corr.1 (Oct 2009)**

**.1 Origin for Change:**

- Suggestion by IACS member

**.2 Main Reason for Change:**

In January 2006, GPG did not reach consensus on a single uniform application date for the revisions of URs S17, S18 and S20, but did agree, by 2/3 majority, to an application statement reading "*Revision [x] of this UR is to be applied by IACS Societies to ships contracted for construction from a date commencing not later than 1 July 2006*" that was intended to mean that the revised URs S17, S18 and S20 were to be applied by IACS Societies to ships contracted for construction on or after a date dd/mm/2006 (to be chosen by each Society) that had to be not later than 1 July 2006.

However, the application statement, as it was written, was not clear because it could be understood that the revised URs were applicable to ships contracted for construction before 1 July 2006 only and not on or after 1 July 2006.

In order to make the application statement clearer and user-friendly, in October 2009 - when the circumstances that brought to the adoption of that peculiar wording were no longer valid - GPG agreed to change it to read: *"Revision [x] of this UR is to be applied by IACS Societies to ships contracted for construction on or after 1 July 2006"*.

**.3 History of Decisions Made:**

See .2 above.

**.4 Other Resolutions Changes**

URs S18 and S20

**.5 Any dissenting views**

None

**.6 Dates:**

GPG Approval: 15 October 2009 (*ref. 9628\_IGb*)

- **Rev.7 (Feb 2006)**

See TB document in Part B.

- **Rev.6 (July 2004)**

Addition of 'Contracted for Construction' statement.

No TB document available.

- **Rev.5 (June 2003)**

See TB document in Part B.

- **Rev.4 (June 2002)**

No TB document available.

- **Rev.3 (Sept 2000)**

See TB document in Part B.

- **Rev.2 (1998)**

Introduction of early implementation of damage stability requirements with a view to synchronising with the implementation of UR S18 and S20.

No TB document available.

- **Rev. 1 (1997)**

No TB document available.

- **NEW (1997)**

No TB document available.

## Part B. Technical Background

List of Technical Background (TB) documents for UR S17:

Annex 1. **TB for Rev.3 (Sept 2000)**

See separate TB document in Annex 1.



Annex 2. **TB for Rev.5 (June 2003)**

See separate TB document in Annex 2.



Annex 3. **TB for Rev.7 (Feb 2006)**

See separate TB document in Annex 3.



Annex 4. **TB for Rev.9 (Apr 2014)**

See separate TB document in Annex 4.



**Note:**

*There are no separate Technical Background (TB) documents for the original resolution (1997), Rev.1 (1997), Rev.2 (May 1998), Rev.4 (Sept 2000), Rev.6 (July 2004), Corr.1 (Oct 2009), Rev.8 (May 2010) and Rev.10 (Mar 2019).*

## **Technical Background to changes proposed in respect of UR's S1A, Annex 2 to S1A, S12, S17, S18, S19, S20 and S22**

The objective of the proposal is to reflect the IMO interpretation of 'single side skin construction' in the above mentioned Unified Requirements for bulk carriers. The Working Party on Strength discussions were unable to yield unanimous agreement and the following matters remain unresolved:

- The titles for UR's S17, S18, S19, S20 and S22 include the wording 'single side skin'. It was generally considered that this wording should now be deleted as the text clearly defines the scope of application and refers additionally to arrangements with double side skin construction. The GL Member does not support this view on the basis that the expression 'single side skin' appears in the text of SOLAS Chapter XII. In view of this difference, the wording 'single side skin' has been enclosed in square brackets pending further consideration by GPG.
- In order to clarify how the breadth of the side shell should be measured, the phrase 'between topside tank and hopper tank' has been used in S17.1(ii) and (iii), S18.1(ii) and (iii), S19.1(ii), S20.1(ii) and (iii), and S22(ii). This was not supported by the ABS member who considers that the IMO definition of single side skin construction does not necessarily refer only to the location between topside and hopper tanks. Also this was not supported by the CRS Member who considers that MSC 89(71), which identifies that measurements are to be made perpendicular to the side shell, provides sufficient guidance. For these reasons, the text has been enclosed in square brackets pending further consideration by GPG.

In addition to the above, two other issues have been raised as follows:

- The ABS Member has requested that the following be considered in respect of the deletion of reference to damage stability requirements from paragraph S17.1 of URS17. It is noted that the reference was originally included in order to cover a six months difference in implementation timetables between SOLAS and IACS. Although both implementation dates have now passed and the need for this provision is limited, there could still be cases where it is relevant due to a change of Class from a non-IACS Society to an IACS Society. It is, therefore, proposed that the present clause in URS17 be replaced by an alternative clause within a unified requirement more specifically related to stability requirements. Support for this proposal has been indicated by PRS, DNV, KR, RINA, CRS and LR.
- The GL Member has requested that consideration be given to amending URS20 and URS22 such that these requirements are only applicable when corrugated bulkheads are fitted. This matter has not received support from the other WP/S Members and is considered to be outside the scope of the present Task.

## UR S17 (Rev. 5, June 2003)

### Technical background

The new revision specifies more in detail which loading conditions are to be considered in UR S17, among those required in UR S1 and S1A. Intermediate loading conditions encountered during ballast water operations are to be considered in UR S17, as they are very transient conditions, and in the normal and not extreme conditions.

For clarification, a note is added to the implementation date of [1 July 2003] stating that such bulk carriers constructed on or after [1 July 2003] are to comply with the applicable version of S17.

The second paragraph of S17.1 is relocated to S17.2.1 "Floodable holds".

The first sentence of the fourth paragraph of S17.3 is relocated to S17.2.2 "(Floodable conditions) Loads". The second sentence of the fourth paragraph of S17.3 is combined with the third paragraph (with "intermediate" deleted).

The last paragraph of S17.1 is deleted as this is not applicable to bulk carriers defined in S17 (Rev.5). SOLAS itself takes care of damage stability.

S17.2 is divided into S17.2.1 and S17.2.2 each with a title appropriate to the contents.

In the definition of fsfc in S17.4, "alternate loading condition" is changed to "loading conditions with empty hold(s)" to agree with S25.

#### Note by the IACS Permanent Secretariat

Council (C 47, 10-12 June 2003) decided that the implementation date of S11(Rev.3) and S17(Rev.5) should be aligned with that of UR S25 – 1 July 2003. NK will implement UR S25 from 1 January 2004. In the interim period between 1 July 2003 and 1 January 2004 NK will recommend that Owners/Builders stipulate in their contract compliance with URs S11 Rev.3 and S17 Rev.5 when UR S25 is applied.

Adopted on 20 June 2003

## Technical Background

### UR S17(Rev.7), UR S18(Rev.7) and UR S20(Rev.4)

(February 2006)

#### 1. Objective

These revisions are proposed to extend the application of URs S17, S18 and S20 to bulk carriers of double side skin construction.

#### 2. Background

The Maritime Safety Committee in the IMO, at its 76<sup>th</sup> session (MSC 76), agreed that new ships of 150 m in length and upwards, which would be of double-side-skin construction, should also comply with all the structural strength provisions of regulation XII/5 of SOLAS requiring that the ship shall have sufficient strength to withstand flooding of any one cargo hold. DE Sub-Committee, at its 47<sup>th</sup> session (DE 47), prepared a final draft text for amendments to SOLAS XII mainly by removing the words which refer to single-side skin construction from this regulation after having discussed about hold flooding scenarios. The agreed hold flooding scenario or assumption was a hypothetical one in which only a cargo hold would be flooded to the water level outside the ship in that flooded condition without flooding the double side skin spaces. Finally the amendments of SOLAS XII were approved at MSC 78 and adopted at MSC 79.

IACS UR S17, S18 and S20 have been referred to in SOLAS 1997 Conference Resolution 3, Recommendation on compliance with SOLAS regulation XII/5. Therefore GPG decided to revise these URs in line with the above-mentioned IMO decision on 10 Jan 2003 and tasked WP/S to effect the revision. Hull Panel took over the task after the reorganization of IACS in 2005.

#### 3. Amendment

Hull Panel prepared a draft revision.

In the application of these three URs, the exemption of cargo holds of double side skin construction was deleted or explicit inclusion of double side skin construction was described. The definition of bulk carrier is referred not to the new definition of the SOLAS XII but to the definition in UR Z11.2.2.

#### 4. Additional Note

##### 4.1 S17.4 Strength Assessment.

The requirements regarding the shear stress in the rev 6 were relative to the side shell only of a single side skin vessel. These requirements are to be applied to the side shell and the inner

hull in case of a double side skin bulk carrier. These requirements refer to the corresponding requirements of URS11.4 (Rev 4 in force today) in which the formulations are given for ships with and without longitudinal bulkheads. Moreover the door is open in UR S11.4.1 to the possible use of a method of direct stress calculation.

#### **4.2 S18.6 'Corrosion addition and steel renewal' and 'S20.3 Shear Capacity of the double bottom'**

Attention is drawn on the fact that it will be necessary to update UR S18 and S20 after the entry into force of the JBP Rules. The corresponding corrosion additions and criteria for steel renewal will be changed.

#### **5. Source/ derivation of proposed requirement**

Hull Panel

#### **6. Decision by voting**

N.A.

26 October 2005

Prepared by Hull Panel

#### **Notes:**

2248eIGj, 8 Jan 2006: GPG concluded that the following be added to the TB.

*"GPG unanimously approved the amended URs and TB. After several rounds of correspondence, GPG did not reach consensus on a single uniform application date for these revisions but did agree, by 2/3 majority, to an application statement to the effect that these revisions of these URs are to be applied by IACS Societies to ships contracted for construction from a date commencing not later than 1 July 2006. GPG Chairman also encouraged all Members to endeavor to apply the requirements of the amended URs in conjunction with their approval of double hull bulk carriers subject to amended SOLAS XII/5.2 by one means or another."*

\* \* \*



## Technical Background Document for UR S17 (Rev. 9, Apr 2014)

### 1. Objective/Scope

The objective of this revision is to clarify the scope of application of IACS UR S17, S18, and S20.

### 2. Source of Proposed Requirements

- IACS UI SC207
- SOLAS XII/5.1 & 5.2

### 3. Technical Basis and Rationale

IACS UR S18 and S20 only apply to conventional bulk carriers with cargoes having a density of 1.0 t/m<sup>3</sup>. Ore Carriers, combination carriers, box-type bulk carriers and hybrid bulk carriers are excluded and the URs do not apply to CSR bulk carriers.

IACS UR S17 applies mostly to conventional bulk carriers as well as hybrid bulk carriers and box-type bulk carriers. Ore carriers and combination carriers are excluded and the UR does not apply to CSR bulk carriers.

However UI SC207 states that;

“Regardless of the date of contract for construction, or the cargo hold cross section configuration, of ships which shall comply with SOLAS XII/5.2, such ships are to comply with IACS Unified Requirements (UR) S17 (rev.7), S18 (rev.7) for corrugated transverse bulkheads, where fitted, and S20 (rev.4), if they do not comply with the IACS CSR for Bulk Carriers.”

This means that UR S17, S18 and S20 are applicable to all of the bulk carrier types covered by SOLAS XII/5.2 with the exception of CSR bulk carriers. This includes conventional bulk carriers, ore carriers, combination carriers, box-type bulk carriers, hybrid bulk carriers and other bulk carrier types.

### 4. Summary of Changes

The scope of application of UR S17, S18 and S20 has been revised to incorporate the requirements of SOLAS Chapter XII, Sections 5.1 & 5.2. The exclusion of CSR bulk carriers is retained.

### 5. Points of Discussion

See above sections.

### 6. Attachments, if any

None

## UR S18 "Evaluation of Scantlings of Corrugated Transverse Watertight Bulkheads in Non-CSR Bulk Carriers Considering Hold Flooding"

### Summary

Clarification that this UR S18 is applicable to self-unloading bulk carrier only if the unloading system maintains the watertightness during seagoing operations.

### Part A. Revision History

Version no.	Approval date	Implementation date when applicable
Rev.10 (Mar 2019)	04 March 2019	1 July 2020
Rev.9 (Apr 2014)	17 April 2014	1 July 2006
Rev.8 (May 2010)	24 May 2010	1 July 2006
Corr.1 (Oct 2009)	15 October 2009	-
Rev.7 (Feb 2006)	1 February 2006	1 July 2006
Rev.6 (July 2004)	5 July 2004	-
Rev.5 (July 2003)	16 July 2003	-
Rev.4 (Nov 2001)	9 November 2001	-
Rev.3 (Feb 2001)	12 February 2001	-
Rev.2 (Sept 2000)	7 September 2000	1 July 2001
Rev.1.1(March 1998) & Rev.1.1(March 1998)/Corr.1 <sup>1</sup>	12 March 1998	-
Rev.1 (1997) <sup>2</sup>	4 November 1997	-
NEW (1997)	8 September 1997	1 July 1998

#### Notes:

- 1 The change made in Rev.1.1 was not properly reflected in the clean version in the Blue Book CD-ROM and so Corr.1 of the clean version was issued on 26 February 1999.
- 2 There were editorial errors in the first version of Rev.1 circulated and so a corrected version was circulated on 28 November 1997.

#### • Rev.10 (Mar 2019)

##### 1 Origin for Change:

- Request by GPG 15139\_IGh dated 18/9/2016

##### 2 Main Reason for Change:

The applicability of ESP to the self-unloading bulk carriers (SUBC) leads to the GPG request to identify the UR S which are NOT applicable to SUBC.

The Hull Panel decided to insist on the fact that the flooding conditions considered in the UR S17 and 18 are relevant for each cargo hold if the unloading system watertightness is maintained during the seagoing conditions.

**3 List of non-IACS Member classification societies contributing through the TC Forum and/or participating in IACS Working Group:**

None

**4 History of Decisions Made:**

Discussion at the HP meeting in 2016  
Analysis by Hull Panel Chair  
Discussion and decision by the Hull Panel in 2018

**5 Other Resolutions Changes:**

Within this study for SUBC application: UR S17, 21A and 30.

**6 Any hinderance to MASS, including any other new technologies:**

None

**7 Dates:**

Original Proposal: 14 June 2018                      Made by: Hull Panel  
Panel Approval: 11 December 2018  
GPG Approval: 04 March 2019 (Ref. 15139\_IGI)

• **Rev.9 (Apr 2014)**

**.1 Origin for Change:**

Suggestion by IACS member

**.2 Main Reason for Change:**

To clarify the scope of application of UR S17, S18 and S20.

**.3 List of non-IACS Member classification societies contributing through the TC Forum and/or participating in IACS Working Group:**

None.

**.4 History of Decisions Made:**

It was decided not to assign implementation dates for versions Corr.1 (Oct 2009), Rev.8 (May 2010) and Rev.9 (Mar 2014) because these revisions/corrections are retrospectively applicable from 1 July 2006 i.e. the assigned date of implementation of Rev.7 (Feb 2006).

**.5 Other Resolutions Changes**

UR S17 and UR S20

**.6 Dates:**

Original proposal: 19 Feb 2014, made by Hull Panel Chair  
Panel submission to GPG: 01 Apr 2014  
GPG Approval: 17 April 2014 (Ref: 14044\_IGb)

• **Rev.8 (May 2010)**

**.1 Origin for Change:**

- Based on IACS Requirement (*Common Structural Rules for Bulk Carriers and Double Hull Oil Tankers*)

**.2 Main Reason for Change:**

Following the introduction of the IACS Common Structural Rules for Bulk Carriers and Double Hull Oil Tankers, Hull Panel were tasked to review all the UR S files to consider whether or not they are applicable to ships covered by the CSR.

**.3 List of non-IACS Member classification societies contributing through the TC Forum and/or participating in IACS Working Group:**

None.

**.4 History of Decisions Made:**

After review it was decided that for CSR bulk carriers the requirements of UR S18 are superseded by those of the Common Structural Rules and therefore do not apply.

UR S18 is not applicable for CSR oil tankers.

**.5 Other Resolutions Changes**

All UR S files, except UR S8, S9, S15, S16, S19, S22, S23, S30 and S31.

**.6 Dates:**

Original proposal: 2007, made by Hull Panel Task 50  
Panel submission to GPG: 19 April 2010  
GPG Approval: 24 May 2010 (Ref. 10051\_IGd)

• **Corr.1 (Oct 2009)**

**.1 Origin for Change:**

- Suggestion by IACS member

**.2 Main Reason for Change:**

In January 2006, GPG did not reach consensus on a single uniform application date for the revisions of URs S17, S18 and S20, but did agree, by 2/3 majority, to an

application statement reading *"Revision [x] of this UR is to be applied by IACS Societies to ships contracted for construction from a date commencing not later than 1 July 2006"* that was intended to mean that the revised URs S17, S18 and S20 were to be applied by IACS Societies to ships contracted for construction on or after a date dd/mm/2006 (to be chosen by each Society) that had to be not later than 1 July 2006.

However, the application statement, as it was written, was not clear because it could be understood that the revised URs were applicable to ships contracted for construction before 1 July 2006 only and not on or after 1 July 2006.

In order to make the application statement clearer and user-friendly, in October 2009 - when the circumstances that brought to the adoption of that peculiar wording were no longer valid - GPG agreed to change it to read: *"Revision [x] of this UR is to be applied by IACS Societies to ships contracted for construction on or after 1 July 2006"*.

### **.3 History of Decisions Made:**

See .2 above.

### **.4 Other Resolutions Changes**

URs S17 and S20

### **.5 Any dissenting views**

None

### **.6 Dates:**

GPG Approval: 15 October 2009 (*ref. 9628\_IGb*)

- **Rev.7 (Feb 2006)**

See TB document in Part B.

- **Rev.6 (July 2004)**

Addition of 'Contracted for Construction' statement.

No TB document available.

- **Rev.5 (June 2003)**

See TB document in Part B.

- **Rev.4 (Nov 2001)**

See TB document in Part B.

- **Rev.3 (Feb 2001)**

See TB document in Part B.

- **Rev.2 (Sept 2000)**

See TB document in Part B.

- **Rev. 1.1 (March 1998) & Rev. 1.1 (March 1998)/Corr.1 \***

The last paragraph of S18.2.1 with regard to the cargo filling height was changed to read "the upper deck level at centreline".\*

No TB document available.

*\* This change was not properly reflected in the clean version in the Blue Book CD-ROM and so Corr.1 of the clean version was issued on 26 February 1999.*

- **Rev. 1 (1997)**

No TB document available.

- **NEW (1997)**

No TB document available.

## Part B. Technical Background

List of Technical Background (TB) documents for UR S18:

Annex 1. **TB for Rev.2 (Sept 2000)**

See separate TB document in Annex 1.



Annex 2. **TB for Rev.3 (Feb 2001)**

See separate TB document in Annex 2.



Annex 3. **TB for Rev.4 (Nov 2001)**

See separate TB document in Annex 3.



Annex 4. **TB for Rev.5 (June 2003)**

See separate TB document in Annex 4.



Annex 5. **TB for Rev.7 (Feb 2006)**

See separate TB document in Annex 5.



Annex 6. **TB for Rev.9 (Apr 2014)**

See separate TB document in Annex 6.



**Note:**

*There are no separate Technical Background (TB) documents for the original resolution (1997), Rev.1 (1997), Rev.1.1 (March 1998)/Corr.1, Rev.6 (July 2004), Corr.1 (Oct 2009), Rev.8 (May 2010) and Rev.10 (Mar 2019).*

## **Technical Background to changes proposed in respect of UR's S1A, Annex 2 to S1A, S12, S17, S18, S19, S20 and S22**

The objective of the proposal is to reflect the IMO interpretation of 'single side skin construction' in the above mentioned Unified Requirements for bulk carriers. The Working Party on Strength discussions were unable to yield unanimous agreement and the following matters remain unresolved:

- The titles for UR's S17, S18, S19, S20 and S22 include the wording 'single side skin'. It was generally considered that this wording should now be deleted as the text clearly defines the scope of application and refers additionally to arrangements with double side skin construction. The GL Member does not support this view on the basis that the expression 'single side skin' appears in the text of SOLAS Chapter XII. In view of this difference, the wording 'single side skin' has been enclosed in square brackets pending further consideration by GPG.
- In order to clarify how the breadth of the side shell should be measured, the phrase 'between topside tank and hopper tank' has been used in S17.1(ii) and (iii), S18.1(ii) and (iii), S19.1(ii), S20.1(ii) and (iii), and S22(ii). This was not supported by the ABS member who considers that the IMO definition of single side skin construction does not necessarily refer only to the location between topside and hopper tanks. Also this was not supported by the CRS Member who considers that MSC 89(71), which identifies that measurements are to be made perpendicular to the side shell, provides sufficient guidance. For these reasons, the text has been enclosed in square brackets pending further consideration by GPG.

In addition to the above, two other issues have been raised as follows:

- The ABS Member has requested that the following be considered in respect of the deletion of reference to damage stability requirements from paragraph S17.1 of URS17. It is noted that the reference was originally included in order to cover a six months difference in implementation timetables between SOLAS and IACS. Although both implementation dates have now passed and the need for this provision is limited, there could still be cases where it is relevant due to a change of Class from a non-IACS Society to an IACS Society. It is, therefore, proposed that the present clause in URS17 be replaced by an alternative clause within a unified requirement more specifically related to stability requirements. Support for this proposal has been indicated by PRS, DNV, KR, RINA, CRS and LR.
- The GL Member has requested that consideration be given to amending URS20 and URS22 such that these requirements are only applicable when corrugated bulkheads are fitted. This matter has not received support from the other WP/S Members and is considered to be outside the scope of the present Task.



**Technical Background to changes proposed in respect of UR S18.4.1(a)  
(Rev. 3, 2001)**

The attached change is proposed in response to a problem raised by a shipbuilder and reported by DNV in respect of the distance requirement from the edge of the stool top plate to the surface of the corrugation flange, as given in S18.4.1(a). The need for a distance of this magnitude was questioned, particularly for cases where the lower stool top plate is inclined, as this detail could encourage accumulation of dirt and moisture leading to excessive corrosion at the bulkhead to stool interface.

The matter was debated by WP/S and it was concluded that the specified distance could be reduced to alleviate the above problem while maintaining a sufficient distance to form a satisfactory weld and avoid lamella tearing of the stool top plate.

The change was agreed unanimously and no unresolved issues remain.

Submitted by WP/S Chairman on 9 January 2001

**Technical Background to changes proposed with respect to UR S18.4.1(a) & S18.4.1(c)**

The attached changes are proposed to achieve greater uniformity in practice among IACS members with respect to the welding requirements at the lower end of vertically corrugated bulkheads. These changes affect: (a) connections between the corrugations and the stool top plate or inner bottom plating; (b) connections between the stool side plating and the stool top and inner bottom plating; and (c) connections between the floors and the inner bottom plating in-way-of transverse corrugated bulkheads. In the proposal, the text has been modified to remove the non-specific phrase “generally to be connected to.... by full penetration welds” and to replace it with more specific requirements for each of the above mentioned locations.

Submitted by WP/S Chairman on 28 August 2001.

**Technical Background**  
**S18.4.1 in Rev. 5 of UR S18**

The objective of the attached proposal is to avoid any misinterpretation of the lower stool requirement for ships less than 190 m in length. As presently written, the requirement could be interpreted that for ships less than 190 m in length a stool not complying with the requirements in S18.4.1 itself is allowed and its presence taken into account when defining the corrugation spans according to Figure 2 of UR S18. This is not the intention of the requirements.

With the occasion, the specifications of “bottom” and “top” stool have been unified to “lower” and “upper” as used in other parts of UR S18.

\*\*\*

## Technical Background

### UR S17(Rev.7), UR S18(Rev.7) and UR S20(Rev.4)

(February 2006)

#### 1. Objective

These revisions are proposed to extend the application of URs S17, S18 and S20 to bulk carriers of double side skin construction.

#### 2. Background

The Maritime Safety Committee in the IMO, at its 76<sup>th</sup> session (MSC 76), agreed that new ships of 150 m in length and upwards, which would be of double-side-skin construction, should also comply with all the structural strength provisions of regulation XII/5 of SOLAS requiring that the ship shall have sufficient strength to withstand flooding of any one cargo hold. DE Sub-Committee, at its 47<sup>th</sup> session (DE 47), prepared a final draft text for amendments to SOLAS XII mainly by removing the words which refer to single-side skin construction from this regulation after having discussed about hold flooding scenarios. The agreed hold flooding scenario or assumption was a hypothetical one in which only a cargo hold would be flooded to the water level outside the ship in that flooded condition without flooding the double side skin spaces. Finally the amendments of SOLAS XII were approved at MSC 78 and adopted at MSC 79.

IACS UR S17, S18 and S20 have been referred to in SOLAS 1997 Conference Resolution 3, Recommendation on compliance with SOLAS regulation XII/5. Therefore GPG decided to revise these URs in line with the above-mentioned IMO decision on 10 Jan 2003 and tasked WP/S to effect the revision. Hull Panel took over the task after the reorganization of IACS in 2005.

#### 3. Amendment

Hull Panel prepared a draft revision.

In the application of these three URs, the exemption of cargo holds of double side skin construction was deleted or explicit inclusion of double side skin construction was described. The definition of bulk carrier is referred not to the new definition of the SOLAS XII but to the definition in UR Z11.2.2.

#### 4. Additional Note

##### 4.1 S17.4 Strength Assessment.

The requirements regarding the shear stress in the rev 6 were relative to the side shell only of a single side skin vessel. These requirements are to be applied to the side shell and the inner

hull in case of a double side skin bulk carrier. These requirements refer to the corresponding requirements of URS11.4 (Rev 4 in force today) in which the formulations are given for ships with and without longitudinal bulkheads. Moreover the door is open in UR S11.4.1 to the possible use of a method of direct stress calculation.

#### **4.2 S18.6 'Corrosion addition and steel renewal' and 'S20.3 Shear Capacity of the double bottom'**

Attention is drawn on the fact that it will be necessary to update UR S18 and S20 after the entry into force of the JBP Rules. The corresponding corrosion additions and criteria for steel renewal will be changed.

#### **5. Source/ derivation of proposed requirement**

Hull Panel

#### **6. Decision by voting**

N.A.

26 October 2005

Prepared by Hull Panel

#### **Notes:**

2248eIGj, 8 Jan 2006: GPG concluded that the following be added to the TB.

*"GPG unanimously approved the amended URs and TB. After several rounds of correspondence, GPG did not reach consensus on a single uniform application date for these revisions but did agree, by 2/3 majority, to an application statement to the effect that these revisions of these URs are to be applied by IACS Societies to ships contracted for construction from a date commencing not later than 1 July 2006. GPG Chairman also encouraged all Members to endeavor to apply the requirements of the amended URs in conjunction with their approval of double hull bulk carriers subject to amended SOLAS XII/5.2 by one means or another."*

\* \* \*

## Technical Background Document UR S18 (Rev. 9, Apr 2014)

### 1. Objective/Scope

The objective of this revision is to clarify the scope of application of IACS UR S17, S18, and S20.

### 2. Source of Proposed Requirements

- IACS UI SC207
- SOLAS XII/5.1 & 5.2

### 3. Technical Basis and Rationale

IACS UR S18 and S20 only apply to conventional bulk carriers with cargoes having a density of 1.0 t/m<sup>3</sup>. Ore Carriers, combination carriers, box-type bulk carriers and hybrid bulk carriers are excluded and the URs do not apply to CSR bulk carriers.

IACS UR S17 applies mostly to conventional bulk carriers as well as hybrid bulk carriers and box-type bulk carriers. Ore carriers and combination carriers are excluded and the UR does not apply to CSR bulk carriers.

However UI SC207 states that;

“Regardless of the date of contract for construction, or the cargo hold cross section configuration, of ships which shall comply with SOLAS XII/5.2, such ships are to comply with IACS Unified Requirements (UR) S17 (rev.7), S18 (rev.7) for corrugated transverse bulkheads, where fitted, and S20 (rev.4), if they do not comply with the IACS CSR for Bulk Carriers.”

This means that UR S17, S18 and S20 are applicable to all of the bulk carrier types covered by SOLAS XII/5.2 with the exception of CSR bulk carriers. This includes conventional bulk carriers, ore carriers, combination carriers, box-type bulk carriers, hybrid bulk carriers and other bulk carrier types.

### 4. Summary of Changes

The scope of application of UR S17, S18 and S20 has been revised to incorporate the requirements of SOLAS Chapter XII, Sections 5.1 & 5.2. The exclusion of CSR bulk carriers is retained.

### 5. Points of Discussion

See above.

### 6. Attachments, if any

None.

## **Technical Background to changes proposed in respect of UR's S1A, Annex 2 to S1A, S12, S17, S18, S19, S20 and S22**

The objective of the proposal is to reflect the IMO interpretation of 'single side skin construction' in the above mentioned Unified Requirements for bulk carriers. The Working Party on Strength discussions were unable to yield unanimous agreement and the following matters remain unresolved:

- The titles for UR's S17, S18, S19, S20 and S22 include the wording 'single side skin'. It was generally considered that this wording should now be deleted as the text clearly defines the scope of application and refers additionally to arrangements with double side skin construction. The GL Member does not support this view on the basis that the expression 'single side skin' appears in the text of SOLAS Chapter XII. In view of this difference, the wording 'single side skin' has been enclosed in square brackets pending further consideration by GPG.
- In order to clarify how the breadth of the side shell should be measured, the phrase 'between topside tank and hopper tank' has been used in S17.1(ii) and (iii), S18.1(ii) and (iii), S19.1(ii), S20.1(ii) and (iii), and S22(ii). This was not supported by the ABS member who considers that the IMO definition of single side skin construction does not necessarily refer only to the location between topside and hopper tanks. Also this was not supported by the CRS Member who considers that MSC 89(71), which identifies that measurements are to be made perpendicular to the side shell, provides sufficient guidance. For these reasons, the text has been enclosed in square brackets pending further consideration by GPG.

In addition to the above, two other issues have been raised as follows:

- The ABS Member has requested that the following be considered in respect of the deletion of reference to damage stability requirements from paragraph S17.1 of URS17. It is noted that the reference was originally included in order to cover a six months difference in implementation timetables between SOLAS and IACS. Although both implementation dates have now passed and the need for this provision is limited, there could still be cases where it is relevant due to a change of Class from a non-IACS Society to an IACS Society. It is, therefore, proposed that the present clause in URS17 be replaced by an alternative clause within a unified requirement more specifically related to stability requirements. Support for this proposal has been indicated by PRS, DNV, KR, RINA, CRS and LR.
- The GL Member has requested that consideration be given to amending URS20 and URS22 such that these requirements are only applicable when corrugated bulkheads are fitted. This matter has not received support from the other WP/S Members and is considered to be outside the scope of the present Task.

Submitted by WP/S Chair on 31 May 2000

(Note: For GPG action, refer to GPG Chair's message 0064dIGa, 31/7/00)

## UR S20 “Evaluation of Allowable Hold Loading for Non-CSR Bulk Carriers Considering Hold Flooding”

### Part A. Revision History

Version no.	Approval date	Implementation date when applicable
Rev.6 (Apr 2014)	17 April 2014	1 July 2006
Rev.5 (May 2010)	24 May 2010	1 July 2006
Corr.1 (Oct 2009)	15 October 2009	-
Rev.4 (Feb 2006)	1 February 2006	1 July 2006
Rev.3 (July 2004)	5 July 2004	-
Rev.2 (Sept 2000)	7 September 2000	1 July 2001
Rev.1 (1997)	4 November 1997	-
NEW (1997)	8 September 1997	1 July 1998

- **Rev.6 (Apr 2014)**

**.1 Origin for Change:**

- Suggestion by IACS member

**.2 Main Reason for Change:**

To clarify the scope of application of UR S17, S18 and S20.

**.3 List of non-IACS Member classification societies contributing through the TC Forum and/or participating in IACS Working Group:**

None.

**.4 History of Decisions Made:**

It was decided not to assign implementation dates for versions Corr.1 (Oct 2009), Rev.5 (May 2010) and Rev.6 (Apr 2014) because these revisions/corrections are retrospectively applicable from 1 July 2006 i.e. the assigned date of implementation of Rev.4 (Feb 2006).

**.5 Other Resolutions Changes**

UR S17 and UR S18

**.6 Dates:**

Original proposal: 19 Feb 2014, made by Hull Panel Chair  
 Panel submission to GPG: 01 Apr 2014  
 GPG Approval: 17 April 2014 (Ref: 14044\_IGb)



- **Rev.5 (May 2010)**

**.1 Origin for Change:**

- Based on IACS Requirement (*Common Structural Rules for Bulk Carriers and Double Hull Oil Tankers*)

**.2 Main Reason for Change:**

Following the introduction of the IACS Common Structural Rules for Bulk Carriers and Double Hull Oil Tankers, Hull Panel were tasked to review all the UR S files to consider whether or not they are applicable to ships covered by the CSR.

**.3 List of non-IACS Member classification societies contributing through the TC Forum and/or participating in IACS Working Group:**

None.

**.4 History of Decisions Made:**

After review it was decided that for CSR bulk carriers the requirements of UR S20 are superseded by those of the Common Structural Rules and therefore do not apply.

UR S20 is not applicable for CSR oil tankers.

**.5 Other Resolutions Changes**

All UR S files, except UR S8, S9, S15, S16, S19, S22, S23, S30 and S31.

**.6 Dates:**

Original proposal: 2007, made by Hull Panel Task 50  
Panel submission to GPG: 19 April 2010  
GPG Approval: 24 May 2010 (Ref. 10051\_IGd)

- **Corr.1 (Oct 2009)**

**.1 Origin for Change:**

- Suggestion by IACS member

**.2 Main Reason for Change:**

In January 2006, GPG did not reach consensus on a single uniform application date for the revisions of URs S17, S18 and S20, but did agree, by 2/3 majority, to an application statement reading "*Revision [x] of this UR is to be applied by IACS Societies to ships contracted for construction from a date commencing not later than 1 July 2006*" that was intended to mean that the revised URs S17, S18 and S20 were to be applied by IACS Societies to ships contracted for construction on or after a date dd/mm/2006 (to be chosen by each Society) that had to be not later than 1 July 2006.

However, the application statement, as it was written, was not clear because it could be understood that the revised URs were applicable to ships contracted for construction before 1 July 2006 only and not on or after 1 July 2006.

In order to make the application statement clearer and user-friendly, in October 2009 - when the circumstances that brought to the adoption of that peculiar wording were no longer valid - GPG agreed to change it to read: *"Revision [x] of this UR is to be applied by IACS Societies to ships contracted for construction on or after 1 July 2006"*.

### **.3 History of Decisions Made:**

See .2 above.

### **.4 Other Resolutions Changes**

URs S17 and S18

### **.5 Any dissenting views**

None

### **.6 Dates:**

GPG Approval: 15 October 2009 (*ref. 9628\_IGb*)

- **Rev.4 (Feb 2006)**

See TB document in Part B.

- **Rev.3 (July 2004)**

Addition of 'Contracted for Construction' statement.

No TB document available.

- **Rev.2 (Sept 2000)**

See TB document in Part B.

- **Rev. 1 (1997)**

No TB document available.

- **NEW (1997)**

No TB document available.

## Part B. Technical Background

List of Technical Background (TB) documents for UR S20:

Annex 1. **TB for Rev.2 (Sept 2000)**

See separate TB document in Annex 1.



Annex 2. **TB for Rev.4 (Feb 2006)**

See separate TB document in Annex 2.



Annex 3. **TB for Rev.6 (Apr 2014)**

See separate TB document in Annex 3.



**Note:** *There are no separate Technical Background (TB) documents for the original resolution (1997), Rev.1 (1997), Rev.3 (July 2004), Corr.1 (Oct 2009) and Rev.5 (May 2010).*

## **Technical Background to changes proposed in respect of UR's S1A, Annex 2 to S1A, S12, S17, S18, S19, S20 and S22**

The objective of the proposal is to reflect the IMO interpretation of 'single side skin construction' in the above mentioned Unified Requirements for bulk carriers. The Working Party on Strength discussions were unable to yield unanimous agreement and the following matters remain unresolved:

- The titles for UR's S17, S18, S19, S20 and S22 include the wording 'single side skin'. It was generally considered that this wording should now be deleted as the text clearly defines the scope of application and refers additionally to arrangements with double side skin construction. The GL Member does not support this view on the basis that the expression 'single side skin' appears in the text of SOLAS Chapter XII. In view of this difference, the wording 'single side skin' has been enclosed in square brackets pending further consideration by GPG.
- In order to clarify how the breadth of the side shell should be measured, the phrase 'between topside tank and hopper tank' has been used in S17.1(ii) and (iii), S18.1(ii) and (iii), S19.1(ii), S20.1(ii) and (iii), and S22(ii). This was not supported by the ABS member who considers that the IMO definition of single side skin construction does not necessarily refer only to the location between topside and hopper tanks. Also this was not supported by the CRS Member who considers that MSC 89(71), which identifies that measurements are to be made perpendicular to the side shell, provides sufficient guidance. For these reasons, the text has been enclosed in square brackets pending further consideration by GPG.

In addition to the above, two other issues have been raised as follows:

- The ABS Member has requested that the following be considered in respect of the deletion of reference to damage stability requirements from paragraph S17.1 of URS17. It is noted that the reference was originally included in order to cover a six months difference in implementation timetables between SOLAS and IACS. Although both implementation dates have now passed and the need for this provision is limited, there could still be cases where it is relevant due to a change of Class from a non-IACS Society to an IACS Society. It is, therefore, proposed that the present clause in URS17 be replaced by an alternative clause within a unified requirement more specifically related to stability requirements. Support for this proposal has been indicated by PRS, DNV, KR, RINA, CRS and LR.
- The GL Member has requested that consideration be given to amending URS20 and URS22 such that these requirements are only applicable when corrugated bulkheads are fitted. This matter has not received support from the other WP/S Members and is considered to be outside the scope of the present Task.

Submitted by WP/S Chair on 31 May 2000

(Note: For GPG action, refer to GPG Chair's message 0064dIGa, 31/7/00)

## Technical Background

### UR S17(Rev.7), UR S18(Rev.7) and UR S20(Rev.4)

(February 2006)

#### 1. Objective

These revisions are proposed to extend the application of URs S17, S18 and S20 to bulk carriers of double side skin construction.

#### 2. Background

The Maritime Safety Committee in the IMO, at its 76<sup>th</sup> session (MSC 76), agreed that new ships of 150 m in length and upwards, which would be of double-side-skin construction, should also comply with all the structural strength provisions of regulation XII/5 of SOLAS requiring that the ship shall have sufficient strength to withstand flooding of any one cargo hold. DE Sub-Committee, at its 47<sup>th</sup> session (DE 47), prepared a final draft text for amendments to SOLAS XII mainly by removing the words which refer to single-side skin construction from this regulation after having discussed about hold flooding scenarios. The agreed hold flooding scenario or assumption was a hypothetical one in which only a cargo hold would be flooded to the water level outside the ship in that flooded condition without flooding the double side skin spaces. Finally the amendments of SOLAS XII were approved at MSC 78 and adopted at MSC 79.

IACS UR S17, S18 and S20 have been referred to in SOLAS 1997 Conference Resolution 3, Recommendation on compliance with SOLAS regulation XII/5. Therefore GPG decided to revise these URs in line with the above-mentioned IMO decision on 10 Jan 2003 and tasked WP/S to effect the revision. Hull Panel took over the task after the reorganization of IACS in 2005.

#### 3. Amendment

Hull Panel prepared a draft revision.

In the application of these three URs, the exemption of cargo holds of double side skin construction was deleted or explicit inclusion of double side skin construction was described. The definition of bulk carrier is referred not to the new definition of the SOLAS XII but to the definition in UR Z11.2.2.

#### 4. Additional Note

##### 4.1 S17.4 Strength Assessment.

The requirements regarding the shear stress in the rev 6 were relative to the side shell only of a single side skin vessel. These requirements are to be applied to the side shell and the inner

hull in case of a double side skin bulk carrier. These requirements refer to the corresponding requirements of URS11.4 (Rev 4 in force today) in which the formulations are given for ships with and without longitudinal bulkheads. Moreover the door is open in UR S11.4.1 to the possible use of a method of direct stress calculation.

#### **4.2 S18.6 'Corrosion addition and steel renewal' and 'S20.3 Shear Capacity of the double bottom'**

Attention is drawn on the fact that it will be necessary to update UR S18 and S20 after the entry into force of the JBP Rules. The corresponding corrosion additions and criteria for steel renewal will be changed.

#### **5. Source/ derivation of proposed requirement**

Hull Panel

#### **6. Decision by voting**

N.A.

26 October 2005

Prepared by Hull Panel

#### **Notes:**

2248elGj, 8 Jan 2006: GPG concluded that the following be added to the TB.

*"GPG unanimously approved the amended URs and TB. After several rounds of correspondence, GPG did not reach consensus on a single uniform application date for these revisions but did agree, by 2/3 majority, to an application statement to the effect that these revisions of these URs are to be applied by IACS Societies to ships contracted for construction from a date commencing not later than 1 July 2006. GPG Chairman also encouraged all Members to endeavor to apply the requirements of the amended URs in conjunction with their approval of double hull bulk carriers subject to amended SOLAS XII/5.2 by one means or another."*

\* \* \*

## Technical Background Document UR S20 (Rev. 6, Apr 2014)

### 1. Objective/Scope

The objective of this revision is to clarify the scope of application of IACS UR S17, S18, and S20.

### 2. Source of Proposed Requirements

- IACS UI SC207
- SOLAS XII/5.1 & 5.2

### 3. Technical Basis and Rationale

IACS UR S18 and S20 only apply to conventional bulk carriers with cargoes having a density of 1.0 t/m<sup>3</sup>. Ore Carriers, combination carriers, box-type bulk carriers and hybrid bulk carriers are excluded and the URs do not apply to CSR bulk carriers.

IACS UR S17 applies mostly to conventional bulk carriers as well as hybrid bulk carriers and box-type bulk carriers. Ore carriers and combination carriers are excluded and the UR does not apply to CSR bulk carriers.

However UI SC207 states that;

“Regardless of the date of contract for construction, or the cargo hold cross section configuration, of ships which shall comply with SOLAS XII/5.2, such ships are to comply with IACS Unified Requirements (UR) S17 (rev.7), S18 (rev.7) for corrugated transverse bulkheads, where fitted, and S20 (rev.4), if they do not comply with the IACS CSR for Bulk Carriers.”

This means that UR S17, S18 and S20 are applicable to all of the bulk carrier types covered by SOLAS XII/5.2 with the exception of CSR bulk carriers. This includes conventional bulk carriers, ore carriers, combination carriers, box-type bulk carriers, hybrid bulk carriers and other bulk carrier types.

### 4. Summary of Changes

The scope of application of UR S17, S18 and S20 has been revised to incorporate the requirements of SOLAS Chapter XII, Sections 5.1 & 5.2. The exclusion of CSR bulk carriers is retained.

### 5. Points of Discussion

See above.

### 6. Attachments, if any

None.

## UR S21 “Evaluation of Scantlings of Hatch Covers and Hatch Coamings and Closing Arrangements of Cargo Holds of Ships”

### Summary

The buckling requirements in UR S21 are improved based on latest CSR buckling requirements. Then UR S21 and S21A are harmonized and combined as a single UR S21 Rev.6. And UR S21A is deleted since 1 July 2024.

### Part A. Revision History

Version No.	Approval date	Implementation date when applicable
Rev.6 (Jan 2023)	26 January 2023	1 July 2024
Rev.5 (May 2010)	24 May 2010	-
Corr.1 (Oct 2004)	25 October 2004	-
Rev.4 (July 2004)	5 July 2004	-
Rev.3 (Apr 2003)	7 April 2003	1 January 2004
Rev.2 (Nov 2002)	17 December 2002	-
Rev.1 (2002)	1 June 2002	-
NEW (1997)	<i>No record</i>	-

#### • Rev.6 (Jan 2023)

##### 1 Origin of Change:

- Suggestion by IACS member

##### 2 Main Reason for Change:

(1) Improvement of the buckling requirements

Different buckling assessment methods, have been included in the relevant UR-Ss, such as UR S11, S11A, S21 and S21A. With the development of the harmonized buckling method in the Common Structural Rules for Bulk Carriers and Oil Tankers (CSR), it's considered necessary to also harmonise the buckling methods among all the different UR-Ss based on the CSR buckling methodology.

For the introduction of the new buckling methodology, it's to be carried out as part of the comprehensive work package on the harmonisation of buckling requirements in different IACS Resolutions, with a newly proposed UR S35-Buckling as a common unified buckling toolbox and simultaneous amendments to the Relevant UR-S including UR S11, S11A, S21 and S21A.

For UR S21 specifically, this harmonization will introduce the latest IACS buckling method for the buckling check of hatch covers of related ship types.



## (2) Harmonisation and combination of UR S21 and S21A

After improvement of the buckling requirements in UR S21 and S21A respectively, it's decided by Hull Panel at the 37<sup>th</sup> meeting (Sept 2022) to further harmonize and combine UR S21 and S21A as a single UR S21. After this combination, UR S21A is deleted.

### **.3 List of non-IACS Member classification societies contributing through the TC Forum and/or participating in IACS Working Group:**

None

### **.4 History of Decisions Made:**

The Hull Panel at the 23<sup>rd</sup> meeting (Sept 2015) considered for the first time the need for harmonising the different IACS Resolutions. A comment received from shipyards is that the IACS approaches regarding buckling requirements were different in the UR S11, S11A, S21, S21A and CSR.

The decision to revise UR S21 is an outcome of the work of IACS GPG Meeting 83. Therefore, a Project Team PT PH43 was ad hoc nominated by the Hull Panel and tasked for the harmonization of buckling requirements in the UR-Ss, as well as for making improvements in the formulation itself.

Hull Panel at the 37<sup>th</sup> meeting (Sept 2022) decided to further harmonize and combine UR S21 and S21A as a single UR S21.

### **.5 Other Resolutions Changes**

- The requirements in UR S21A are harmonized with corresponding requirements in S21, which are then included in UR S21 Rev.6.
- UR S21A is deleted since 1 July 2024. The revised UR S21 is cross-referenced in UR S35.

### **.6 Any hindrance to MASS, including any other new technologies:**

None

### **.7 Dates:**

Original proposal	: 14 September 2017	(Made by: An IACS member)
Panel Approval	: 22 December 2022	(Ref: PH17036b)
GPG Approval	: 26 January 2023	(Ref: 18058aIGc)

- **Rev.5 (May 2010)**

- .1 Origin for Change:**

- Based on IACS Requirement (*Common Structural Rules for Bulk Carriers and Double Hull Oil Tankers*)

- .2 Main Reason for Change:**

Following the introduction of the IACS Common Structural Rules for Bulk Carriers and Double Hull Oil Tankers, Hull Panel were tasked to review all the UR S files to consider whether or not they are applicable to ships covered by the CSR.

- .3 List of non-IACS Member classification societies contributing through the TC Forum and/or participating in IACS Working Group:**

None.

- .4 History of Decisions Made:**

After review it was decided that for CSR bulk carriers the requirements of UR S21 are superseded by those of the Common Structural Rules and therefore do not apply.

UR S21 is not applicable for CSR oil tankers.

- .5 Other Resolutions Changes**

All UR S files, except UR S8, S9, S15, S16, S19, S22, S23, S30 and S31.

- .6 Dates:**

Original proposal: 2007, made by Hull Panel Task 50  
Panel submission to GPG: 19 April 2010  
GPG Approval: 24 May 2010 (Ref. 10051\_IGd)

- **Corr.1 (Oct 2004)**

"Pontoon hatch covers" corrected to read "double skin hatch covers" – no TB document available.

- **Rev.4 (July 2004)**

Addition of 'Contracted for Construction' footnote – no TB document available.

- **Rev.3 (Apr 2003)**

See TB document in Part B.

- **Rev.2 (Nov 2002)**

No TB document available.

- **Rev.1 (2002)**

No TB document available.

- **New (1997)**

No TB document available.

## **Part B. Technical Background**

List of Technical Background (TB) documents for UR S21:

Annex 1. **TB for Rev.3 (Apr 2003)**

See separate TB document in Annex 1.

Annex 2. **TB for Rev.6 (Jan 2023)**

See separate TB document in Annex 2.

**Note:** *There are no separate Technical Background (TB) documents for the original resolution (1997), Rev.1 (2002), Rev.2 (Nov 2002), Rev.4 (July 2004), Corr.1 (Oct 2004) and Rev.5 (May 2010).*

IACS WP/S - Task 70

Revision 3 of UR S21

April 2003

## **UR S21 Rev. 3 Technical background**

### **Background**

Following the hearings of the Re-Opened Formal Investigation into the loss of the m.v. Derbyshire, held in the U.K., the Court recommended that UR S21 should be re-appraised in the light of the latest sea-keeping model tests, and that this new standard be made applicable both to new ships and retrospectively to existing vessels. Later, in March 2002, IACS announced a series of eight initiatives to improve the safety of bulk carriers. UR S21 Rev. 2 was firstly developed by AHG/EBC, working in association with members of WP/S to address the application of measure number 6 to new ships. In addition to the green sea load model, this Revision incorporates changes to the strength formulation for hatch covers, strength standards for the design of hatch coamings, and for the securing of hatch covers to resist horizontal green sea loads.

At its 46 Meeting in December 2002, the Council assigned a new task to the WP/S, to amend UR S21 Rev.2 as submitted to MSC 76) to incorporate loads, allowable stress (0,8 yielding) and deflection criteria as adopted in the revisions to Load Line Convention adopted by IMO at MSC 76. S21(Rev.3) has been so developed.

The new WP/S task was then labelled as Task 70.

### **Application**

Hatch cover secondary stiffeners are required to be continuous in order to have the necessary buckling strength against the compressive loads induced by the bending of primary supporting members.

Hatch coaming secondary stiffeners are required to be continuous in order to be able to sustain the plastic bending moment distribution assumed for these elements.

Hatch cover primary supporting members are required to be continuous to ensure their load carrying capacity and an adequate transmission of forces when grillage effects are taken into account. For similar reason, a maximum spacing of the primary supporting members parallel to the direction of secondary stiffeners is included.

### **Hatch cover load model**

According to the decisions taken by IACS after MSC 76, as reflected in the Task 70 Form A, the load model adopted in Rev. 2 of UR S21 is the one adopted by IMO in Regulation 16-1 of the revised Load Line Convention.

The value formula reported in Regulation 16-1 of the revised LLC for ships less than 24 m in length is not included since it is not applicable to the bulk carriers to which UR S21 applies. However, the relevant values are used to interpolate the pressure values for ship's length less than 100 m.

### **Hatch cover strength criteria**

Following the assumptions stated in the 1988 LL Protocol, the hatch covers are assumed to behave in the elastic domain under the assigned loads. Consequently, the allowable stresses are:

- 0,8 and 0,46 times the minimum upper yield stress for normal and shear stresses, respectively,
- 0,8 times the critical buckling stress for normal compression and shear stresses.

The stress response of the hatch cover primary supporting members is generally to be determined through a grillage or a Finite Element calculation, beam models are adopted only for hatch covers that are not designed as a grillage of longitudinal and transverse primary supporting members. Prescriptive requirements for the hatch cover top plate thickness and secondary stiffener section modulus are given.

Based on the elastic approach used for the strength criteria of secondary stiffeners and plating, the effective width of the primary supporting members is equal to the spacing of primary supporting members, to be taken not greater than 0,165 times the member side span, on each side of it.

However, since the formula for the secondary stiffener required section modulus does not account for the stresses induced by the bending of primary supporting members, the attached plate flange area of the primary supporting members is to be calculated without any contribution from the secondary stiffener area.

In the S21 requirement for minimum plate thickness, the coefficient 15,8 used in the expression applies for plates under pressure with clamped edges that are free to pull in and with plastic hinges at the edges and at mid-span. An additional factor of 1,5 is introduced to account for co-existing compressive membrane stress in the hatch cover top plate as well as the possibility that the lateral pressure loading may locally exceed the UR S21 value. Considering the combined effects of the local plate bending stress and the flange stress of primary supporting members, the 1,5 factor is increased linearly to 1,90 for the attached plate flange of primary stiffening members stressed above 80% of the allowable stress limit. The 1,90 factor gives a plate flange thickness consistent with hatch cover designs that have been assessed with respect to their lateral load capacity by non-linear FE analysis.

The requirements for hatch cover plate thickness include a buckling check of the compression stress induced by the bending of primary supporting members either parallel or perpendicular to the secondary stiffeners. The formulae adopted for these buckling checks are taken from UR S11.

For secondary stiffeners, the elastic section modulus is derived from the elastic bending moment at the fixed end. Only the lateral pressure is considered, while the second order bending moment caused by the combined effect of stiffener deflection (by the lateral pressure load) and the membrane stress in the plate (from the bending of the primary supporting member) is disregarded.

In order to ensure the elastic behaviour of the hatch cover structures, it is required that buckling checks are carried out for secondary stiffeners parallel to primary supporting members, subjected to the compression stresses induced in the top plate flange by the bending of primary supporting members. The formulae adopted for these buckling checks are taken from UR S11.

For flat bar secondary stiffeners, a limit on the web depth to net thickness ratio is introduced, based on typical Society criteria, to prevent their local buckling.

The breadth of the primary supporting member flanges is to be at least 40% of their depth, in association with a laterally unsupported span not greater than 3,0 m, in order to avoid tripping.

The critical buckling stress check for the web panel of the primary supporting members is based on the formula valid for simply supported plate. The criteria adopted for calculating the actual shear stress to be compared with the critical buckling stress are the following.

- Primary supporting members parallel to the direction of secondary stiffeners do not directly support such stiffeners, which are the load carrying elements. Therefore, the shear is uniform in each panel bounded by the crossing with other primary supporting members, the face plate (or the bottom cover plate) and the cover plate. In this case, the web panels bounded by the above elements, subjected to uniform shear stresses, are to be considered in the buckling check.
- Primary supporting members perpendicular to the direction of secondary stiffeners are subjected to an almost linearly varying shear force distribution, induced by the vertical loads transmitted through the secondary stiffeners. In this case, the buckling check is to be carried out for an assumed square panel with sides equal to the primary supporting member web height. This assumption is based on the 45° orientation of the principal compressive stresses in the web subjected mainly to shear (at least in the vicinity of the neutral axis), which allows square panels to be idealised in which the shear stress may be assumed to be uniform.

A deflection limit and closing requirements between hatch cover panels are included with the intention of ensuring weathertightness of the hatch cover under extreme green sea loads. The limit of  $0,0056 l$  (where  $l$  is the greatest span of the primary supporting members) included in the revised Load Line Convention is assumed.

### **Hatch coamings – Load and strength criteria**

The values for the pressure  $p_{\text{coam}}$  were provided by the IACS AHG/WD-SL study on the assessment of UR S21 based on the MARIN model test results.

The pressure of  $290 \text{ kN/m}^2$  on the No. 1 forward transverse hatch coaming is the upper bound of the measured longitudinal loads appropriate to a 20-year North Atlantic storm excluding flooding.

The pressure of  $220 \text{ kN/m}^2$  on the other coamings is the upper bound obtained for transverse loads on side coamings.

The pressure reduction from  $290 \text{ kN/m}^2$  to  $220 \text{ kN/m}^2$ , due to the protection provided to the forward transverse hatch coaming by a forecastle complying with UR S28, is also derived from the IACS study based on the MARIN model test results. Although these tests were carried out on models not fitted with a forecastle, the effect of the forecastle protection on the No. 1 forward hatch coaming was estimated to be equivalent to the protection given by the No. 1 hatch cover to the No. 2 forward hatch coaming.

It is to be noted that the pressures on hatches aft of  $0,25 L$  from the forward perpendicular have not been exhaustively investigated during the MARIN tests. However, the following considerations are to be taken into account.

- The investigations carried out by the AHG/WD-SL have shown that the maximum transverse pressures on transverse hatch coamings occur in beam sea conditions. In these conditions, it is deemed that the pressures on transverse hatch coamings are largely the same for all hatches, irrespective of their location along the ship's length.
- The maximum longitudinal pressures, acting on the front hatch covers, are surely lower for aft hatches, with respect to No. 2 hatches, due to the protection offered by the forward hatches.
- For practical design purposes, the horizontal forces are conservatively assumed to be the same for hatch No. 2 and for hatches aft of hatch No.2.

In the formula for the local net plate thickness, the coefficient 14,9 appropriate for plates not subjected to in-plane stresses is adopted. Considering the low probability of load occurrence a plastic approach is adopted for secondary stiffeners, although, for consistency with the hatch cover formulation, an allowable stress rather than a yield stress limit is used. A safety factor equal to 1,15 is then included in the formulae to arrive at an overall safety margin of 1,2 with respect to the development of plastic hinges.

As a plastic bending moment distribution is specified for secondary stiffener, the required elastic section modulus is evaluated by introducing the term  $c_p$ , which is the ratio of the plastic section modulus to the elastic section modulus. Again a safety factor of 1,15 is incorporated to establish an overall margin of 1,2 against yield.

Formulae for the thickness and elastic minimum section modulus of the coaming stays were derived for the elastic shear force and bending moment appropriate to a cantilever under a uniformly distributed pressure. For stays of non-cantilever design the same allowable stress limits apply, but prescriptive scantlings have not been formulated.

### **Securing devices**

The criteria of Recommendation No. 14 are explicitly required to be complied with.

### **Stoppers**

No credit is given for the friction forces between the covers and the coamings. The stoppers are to be dimensioned against longitudinal and transverse forces arising from a pressure of 175 kN/m<sup>2</sup>.

For the hatch coaming of hatch No.1, a pressure equal to 230 kN/m<sup>2</sup> is to be considered, unless a fore-castle is fitted in accordance with UR S28. In this case, a value of 175 kN/m<sup>2</sup> may be considered.

Compared with the pressures on the hatch coamings, these values take into consideration the local reduction of pressure that occurs at the upper edge of the vertical boundary created by the coaming and hatch cover side or end plate.



### **Corrosion addition and steel renewal criteria**

The corrosion addition of 1,5 mm for the hatch coaming and coaming stays is based on the results of the NK report "Corrosion Analysis for Bulk Carriers and Determination of Corrosion Margin (Part 3)" of January 2002, prepared in relation to WP/S Task No. 22.

Steel renewal criteria are defined consistently with the corrosion addition values.

### **Remarks made by some Member Societies**

1. GL has repeated its reservation on the adopted buckling check formulae, also placed on the previous Rev. 2 of UR S21, which reflects the GL reservation on UR S11.
2. LR has accepted the present revision of UR S21 on a majority basis, but they supported a different approach in which the strength criteria were the same as those adopted in the previous Rev. 2 prepared by the AHG/EBC, with the permissible stresses changed from 0,95 to 0,8 times the yielding stress.

In the LR's view, when Regulation 16-1 states that "the product of the maximum stress determined in accordance with the above loads and the factor 1,25 shall not exceed the critical buckling strength in compression", it does not say how the critical buckling strength is to be calculated. According to LR, the criteria of Regulation 16-1 are fulfilled by changing the allowable stresses in the expressions of the previous Rev. 2 of UR S21, which should therefore be retained for this purpose.

The other Members, however, did not agree on this interpretation of Regulation 16-1 and were in favour of explicit buckling stress checks.

Note by the Permanent Secretariat:

- GPG decided to expand the scope of application to bulk carriers, ore carriers and combination carriers as defined in UR Z11. See the title and S21.1.
- Adopted on 7 April 2003 (2248gICa). An information paper on the revision of S21(Rev.3, April 2003) was submitted to IMO MSC 77(May 2003).

## Technical Background document for UR S21 Rev.6 (Jan 2023)

### 1. Scope and objectives

For this revision of UR S21, it's mainly about two aspects. The first is to adopt a new buckling methodology for hatch cover analysis, which is based on CSR -- Common Structural Rules for Bulk Carriers and Oil Tankers. The second is to further harmonize and combine UR S21 and S21A as a single UR S21. After this combination, UR S21A is deleted.

Regarding the first aspect, on the improvement of the buckling requirements, the major revision is made to Section S21.3.6 "Buckling Strength". As two directly related items, Section S21.3.1 "Yield Strength" and Section S21.3.2 "Stress Calculation Model" are also improved based on corresponding requirements in CSR.

For the introduction of the new buckling methodology, it's been carried out as part of the comprehensive work package on the harmonisation of buckling requirements in different IACS Resolutions, with a newly proposed UR S35-Buckling as a common unified buckling toolbox and simultaneous amendments to the Relevant UR-S including UR S11, S11A, S21 and S21A.

For the application of UR S35-Buckling to specific ship types or structural members requiring buckling assessment, definition of loading conditions, standard corrosion deductions, hull girder stresses, stress combinations, safety factors should be given in the individual UR-Ss; based on these definitions as input parameters, wherever applicable it links to UR S35-Buckling for buckling assessment with respect to slenderness requirements, prescriptive buckling requirements and buckling requirements for direct strength analysis. With this framework of general rule organization and a standardized interface of reference to the same UR S35-Buckling for buckling assessment in all relevant UR-S (S11, S11A, S21, S21A, etc.), the goal of Harmonisation of Buckling Requirements in IACS Resolutions is achieved. Specifically, in this revision of UR S21 definition of load model, net scantlings, stress calculation methods, safety factors are given in S21.3.6 to be used as input parameters for buckling check, while a link to UR S35-Buckling is also given referring to the common unified slenderness requirements and the direct strength analysis (DSA) buckling assessment requirements.

Regarding the second aspect, on the harmonisation and combination of UR S21 and S21A, all the requirements in UR S21A are harmonized with corresponding parts in S21, which are then included in UR S21 Rev.6.

### 2. Engineering background for technical basis and rationale

#### (1) Improvement of the buckling requirements

It is mainly to introduce the CSR buckling methodology into this UR under the broader perspective of Harmonisation of Buckling Requirements in IACS Resolutions, for which this UR is taken as part of the Relevant UR-S. Therefore, the TB for this harmonisation can be taken as a whole for the common part, and this part is mainly included in the TB of the new UR S35-Buckling. For details, refer to the Part B, Annex 1 of the HF+TB for the new UR S35-Buckling.

For simplicity and avoiding repetition, therefore only the part specific to this UR S is included in this text. For this revision of UR S21, it's considered that there is only one technical point to be noted, i.e. the safety factor defined in S21.3.6.3.4 and the allowable buckling utilization factors defined in S21.3.6.3.5 are to follow the corresponding CSR requirements. Specifically, the allowable buckling utilization factors definitions in CSR Pt2, Ch1, Sec 5, Table 3 are followed as defined below.

**Allowable buckling utilisation factors**

Structural component	Subject to	$\eta_{all}$ , Allowable buckling utilisation factor
Plates and stiffeners Web of PSM	External pressure, as defined in S21.2	0.80
	Other loads (cargo loads, etc.)	0.90 for static+dynamic load case 0.72 for static load case

where the value of  $\eta_{all} = 0.8$  corresponding to vertical weather design load is the same as in previous revision of UR S21(rev. 5), and is also taken to substitute the generally equivalent safety factor  $S=1.25$  in previous revision of UR S21A (Corr.2 Mar 2019). The value of  $h_{all}=0.9$  for other static+dynamic load case is taken to substitute the generally equivalent safety factor  $S=1.1$  in previous revision of UR S21A (Corr.2 Mar 2019). In addition, an additional value of  $h_{all}=0.72$  for other static load case is introduced considering the same value already defined in CSR with well accepted technical background. Therefore, actually no additional TB besides that for corresponding CSR requirement is considered necessary.

(2) Harmonisation and combination of UR S21 and S21A

After improvement of the buckling requirements in UR S21 and S21A respectively, all the requirements in UR S21A are harmonized with corresponding parts in S21 as far as possible, which are then included in UR S21 Rev.6. These requirements apply to all ships except CSR bulk carriers, and are for all cargo hatch covers and coamings on exposed decks. However, parts of the requirements are for some specific ship types as categorized below:

- Type-A ships, including all ships except bulk carriers, self-unloading bulk carriers, ore carriers and combination carriers, as defined in UR Z11.
- Type-B ships, including all bulk carriers, self-unloading bulk carriers, ore carriers and combination carriers, as defined in UR Z11.

Generally, it's decided that the harmonized UR S21 Rev.6 is to generally follow the rule text organization framework of UR S21A. For this harmonisation, firstly all major structural strength requirements with possible scantling impacts are compared. Specifically, the formulae related to the following aspects are compared:

- Hatch cover local strength on plating and stiffeners
- PSM and edge girders

- Hatch coaming plating, stiffeners, coaming stays and securing devices

Based on the comparison, it shows that generally all scantling requirements in UR S21 and S21A can be harmonized except for the following items due to some identified reasons.

First, due to different horizontal weather design load in UR S21A, 2.2 and UR S21.4.1, the following items need to be listed as dependent on either Type-A or Type-B ships:

- S21A, 5.1: Local net plate thickness of coamings
- S21A, 5.2: Net scantling of stiffeners of coamings
- S21A, 5.3.1: Coaming stay section modulus and web thickness
- S21A, 7.1 Corrosion addition for hatch covers and hatch coamings

Second, there are some requirements included in UR S21A but not in UR S21. Some of them are harmonized based on calculation of typical designs showing no apparent scantling impact, such as the hatch cover stiffener shear area requirement in S21A, 3.3. However, based on calculations of typical designs, it shows that due to apparent scantling impact the following requirements are only for Type-A ships:

- S21A, 3.4.2: Edge girders (skirt plate) thickness requirement
- S21A, 5.2: Requirement to gross thickness of coaming plate with sniped stiffeners.
- S21A, 6.2.2: Hatch cover supports with tabled permissible nominal surface pressure.

In addition, there are some detailed requirements in UR S21 but not in UR S21A, which are kept only for Type-B ships as below:

- S21A, 5.3.1: Size of welding at the lower end of coaming stays
- S21A, 6.2.3: Some specific requirements on hatch cover stoppers.

With the above harmonisation and classification of all requirements in UR S21 and S21A, besides the already identified consequences caused by buckling rule improvement and some other harmonized requirements, it's considered that no apparent scantling impact is to be observed based on the further harmonisation and combination of UR S21 and S21A as a single UR S21 Rev.6.

In addition, as far as possible the symbols used in CSR 2022 are followed in the revised UR S21, which makes it easier for either rule application by Industry or future further rule harmonisation within IACS.

## **2.4 Consequence Assessment**

Regarding the first aspect, on the improvement of the buckling requirements, two CA (Consequence Assessment) reports are prepared based on the calculation of 2 typical hatch covers using this revised UR S21 and the previous revision (rev. 5) respectively. Based on the reports, it indicates that some design improvements might need to be

introduced to meet the buckling requirements in this revision of UR S21 especially for relatively big size hatch covers. However, this is same as required in CSR, which had been proved more reasonable from both theoretical analysis and practical design points of view.

The two CA reports are attached as listed below:

(1) PTPH43\_WPA\_CA Rep\_UR\_S21\_Rev.6\_TB Annex 2\_BC110k\_HC1.docx

(2) PTPH43\_WPA\_CA Rep\_UR\_S21\_Rev.6\_TB Annex 2\_BC325k\_HC1.docx

Regarding the second aspect, on the harmonisation and combination of UR S21 and S21A, it's considered that no apparent scantling impact is to be observed due to the further harmonisation and combination of UR S21 and S21A as a single UR S21 Rev.6. Specifically, for the hatch cover stiffener shear area requirement in S21A, 3.3, it's a requirement originally included in UR S21A but not in UR S21, after harmonisation it applies to both Type-A and Type-B ships in UR S21 Rev.6. For consequence assessment, some calculations are carried out regarding typical hatch cover stiffeners compliant with UR S21 originally designed without considering this net shear area requirement. Based on the calculation, it shows that the net section modulus requirement is always a far more governing factor than net shear area requirement. Therefore, for typical hatch cover designs no scantling impact is expected to be caused by this rule harmonisation.

### **3. Source/derivation of the proposed IACS Resolution**

For this revision of UR S21 which is mainly to adopt a new buckling methodology for hatch cover analysis, it's to be applied in conjunction with the new UR S35-Buckling as a general unified buckling toolbox. The revised buckling requirements in both Resolutions are in general based on CSR Pt 1, Ch 8, Sec 5 and App 1. Background information to the general approach is therefore same as the corresponding parts in the technical background documentation of CSR, available via the IACS web-site.

### **4. Summary of Changes intended for the revised Resolution:**

Regarding the first aspect, on the improvement of the buckling requirements, referring to the previous revision of UR S21(rev. 5), the major revision is made to Section S21.3.6 "Buckling Strength". As two directly related items, Section S21.3.1 "Yield Strength" and Section S21.3.2 "Stress Calculation Model" are also improved based on corresponding requirements in CSR.

Referring to the previous revision of UR S21A (Corr.2 Mar 2019), the major revision is made to Section 3.6 "Buckling strength of hatch cover structures". As two directly related items, Section 3.5 "Strength calculations" and Section 3.1.1 "Yield strength" are also improved based on corresponding requirements in CSR. For both UR S21 and S21A, some editorial or minor revisions corresponding to the revision of the buckling requirements are introduced.

For details, a modified text indicating changes in red and with underlining for new additions and strike through for deletions is attached.

(1) Specifically, from UR S21(rev. 5) to UR S21(rev. 6), for the sub-items of UR S21(rev. 6), Section 3.6 "Buckling Strength", the rule revisions can be summarized as below:

➤ S21, 3.6.1 General

Technical background is not considered necessary.

➤ S21, 3.6.2 Slenderness requirements

The slenderness requirement on stiffeners applicable for hatch covers is newly introduced from CSR.

➤ S21, 3.6.3 Buckling requirements

S21, 3.6.3.1 Application

Technical background is not considered necessary.

S21, 3.6.3.2 Panel types and assessment methods

This is newly introduced from CSR.

S21, 3.6.3.3 Applied stresses and pressure

The level of applied stresses on hatch cover plate structures are not intended to be modified by present text changes.

It has to be highlighted that, even with unchanged stresses, the longitudinal stress and the transversal stress, respect to orientation of stiffeners and the shear stress are no more checked for buckling assessment in isolation as was up to previous revision, but they shall be checked in a combined manner, as relevant, into interaction equations. It is also now explicitly covered the bi-axial compressive case that, up to the prior revision, was left to each Classification Society's judgement.

Moreover, according to the general procedure in UR S-Buckling, also the case with one stress component in compression and the other component in tension shall also be assessed.

In the stiffener buckling check, the additional contribution of lateral pressure will also be accounted for.

S21, 3.6.3.4 Safety factors

Technical background is not considered necessary.

S21, 3.6.3.5 Buckling acceptance criteria

This is newly introduced from CSR, which uses the same definition of allowable buckling utilisation factors for a hatch cover subject to different loading conditions.

(2) Specifically, from UR S21A (Corr.2 Mar 2019) to UR S21(rev. 6), for the sub-items of UR S21(rev. 6), Section 3.6 "Buckling Strength", the rule revisions can be summarized as below:

➤ S21, 3.6.1 General

Technical background is not considered necessary.

➤ S21, 3.6.2 Slenderness requirements

The slenderness requirement on stiffeners applicable for hatch covers is newly introduced from CSR.

➤ S21, 3.6.3 Buckling requirements

S21, 3.6.3.1 Application

Technical background is not considered necessary.

S21, 3.6.3.2 Panel types and assessment methods

This is newly introduced from CSR.

S21, 3.6.3.3 Applied stresses and pressure

Technical background is not considered necessary.

S21, 3.6.3.4 Safety factors

The explanation given in the above Section 2 of this document on the technical point of allowable buckling utilisation factors applies.

S21, 3.6.3.5 Buckling acceptance criteria

This is newly introduced from CSR, which uses the same definition of allowable buckling utilisation factors for a hatch cover subject to different loading conditions.

Regarding the second aspect, on the harmonisation and combination of UR S21 and S21A, generally the harmonized UR S21 Rev.6 is revised based on UR S21A (Corr.2 Mar 2019) after improving the buckling requirements.

In the harmonized and combined UR S21 Rev.6, besides the majority part following UR S21A (Corr.2 Mar 2019) and the buckling improvement, firstly the following items are listed as dependent on either Type-A or Type-B ships:

- S21, 5.1: Local net plate thickness of coamings
- S21, 5.2: Net scantling of stiffeners of coamings
- S21, 5.3.1: Coaming stay section modulus and web thickness
- S21, 7.1 Corrosion addition for hatch covers and hatch coamings

Secondly, the hatch cover stiffener shear area requirement in S21, 3.3 is harmonized, while the following requirements are only for Type-A ships:

- S21, 3.4.2: Edge girders (skirt plate) thickness requirement
- S21, 5.2: Requirement to gross thickness of coaming plate with sniped stiffeners.
- S21, 6.2.2: Hatch cover supports with tabled permissible nominal surface pressure.

Thirdly, the following requirements are only for Type-B ships:

- S21, 5.3.1: Size of welding at the lower end of coaming stays
- S21, 6.2.3: Some specific requirements on hatch cover stoppers.

In addition, as far as possible the symbols used in CSR 2022 is followed in the harmonized and combined UR S21 Rev.6.

## 5. Points of discussions or possible discussions

This Rev.6 of UR S21 was made through discussions of the draft version provided by the project team within the Hull Panel, which mainly involved incorporating individual comments on specific technical points, updates based on corresponding CSR improvements and accepting the consolidated text.

Major points of discussions and conclusions during the development of this revision have been the following:

No.	Section	Points of discussion and conclusions
1.	S21.3.1 and S21A, 3.1.1	The same yield strength assessment requirements are adopted from CSR 2022, which corresponds to using FE analysis method as the single prescribed method for hatch cover direct strength analysis.
2.	S21.3.2.2 and S21A, 3.5	The same General requirements for FE modelling and analysis as in CSR 2022 is adopted here, which generally also complies with UR S21A requirements. Note that the FE modelling and analysis of hatch covers fitted with U-type stiffeners is also adapted from CSR 2022.
3.	S21.3.6.3.3 and S21A, 3.6.3.3	In the previous version of UR S21 and S21A, the stresses for hatch cover direct strength buckling check may be determined by either grillage analysis or FEM. However, based on joint investigation of Societies and ship yards, it's determined that only FEM is to be kept in the rule for hatch cover direct strength analysis. For details, refer to the TB corresponding to the new UR S35-Buckling. Based on this decision, harmonization is achieved among UR S21, S21A and CSR to take FEM as the single prescribed method for hatch cover direct strength analysis.

## 6. Attachments if any

Two CA reports are attached as:

(1) PTPH43\_WPA\_CA Rep\_UR\_S21\_Rev.6\_TB Annex 2\_BC110k\_HC1.docx

(2) PTPH43\_WPA\_CA Rep\_UR\_S21\_Rev.6\_TB Annex 2\_BC325k\_HC1.docx



## **URS21A “Evaluation of Scantlings of Hatch Covers and Hatch Coamings and Closing Arrangements of Cargo Holds of Ships”**

### **Summary**

The requirements in UR S21A are harmonized with S21, which are then included in UR S21 Rev.6, UR S21A is deleted on the implementation of UR S21 Rev.6

### **Part A. Revision History**

<b>Version no.</b>	<b>Approval date</b>	<b>Implementation date when applicable</b>
Del (Jan 2023)	27 January 2023	1 July 2024
Corr.2 (Mar 2019)	04 March 2019	-
Corr.1 (Feb 2018)	19 February 2018	-
Rev.1 (May 2015)	26 May 2015	1 July 2016
Corr.1 (Oct 2011)	21 Oct 2011	-
NEW (May 2011)	23 May 2011	1 July 2012

#### **• Del (Jan 2023)**

##### **1 Origin for Change:**

- Suggestion by IACS member

##### **.2 Main Reason for Change:**

(1) Improvement of the buckling requirements

Different buckling assessment methods, each of which are then the latest available methods, have been included in the relevant UR-Ss, such as UR S11, S11A, S21 and S21A. With the development of the harmonized buckling method in the Common Structural Rules for Bulk Carriers and Oil Tankers(CSR), it's considered necessary to also harmonise the buckling methods among all the different UR-Ss based on the CSR buckling methodology.

For the introduction of the new buckling methodology, it's to be carried out as part of the comprehensive work package on the harmonisation of buckling requirements in different IACS Resolutions, with a newly proposed UR S35-Buckling as a common unified buckling toolbox and simultaneous amendments to the Relevant UR-S including UR S11, S11A, S21 and S21A.

For UR S21A specifically, this harmonization will introduce the latest IACS buckling method for the buckling check of hatch covers of related ship types.

## (2) Harmonisation and combination of UR S21 and S21A

After improvement of the buckling requirements in UR S21 and S21A respectively, it's decided by Hull Panel at the 37th meeting (Sept 2022) to further harmonize and combine UR S21 and S21A as a single UR S21. After this combination, UR S21A is deleted.

### **3 List of non-IACS Member classification societies contributing or participating in IACS Working Group:**

None

### **4 History of Decisions Made:**

The Hull Panel at the 23rd meeting (Sept 2015) considered for the first time the need for harmonising the different IACS Resolutions. The shipyards complained that the IACS approaches regarding buckling requirements were different in the UR S11, S11A, S21, S21A and CSR.

The decision to revise UR S21A is an outcome of the work of IACS GPG Meeting 83. Therefore, a Project Team PT PH43 was ad hoc nominated by the Hull Panel and tasked for the harmonization of buckling requirements in the UR-Ss, as well as for making improvements in the formulation itself.

Hull Panel at the 37th meeting (Sept 2022) decided to further harmonize and combine UR S21 and S21A as a single UR S21.

### **5 Other Resolutions Changes:**

The requirements in UR S21A are harmonized with corresponding requirements in S21, which are then included in UR S21 Rev.6.

### **6 Any hinderance to MASS, including any other new technologies:**

None

### **7 Dates:**

Original proposal	: April 2015	Made by: IACS PT56
Panel Approval	: 21 December 2022	(Ref: PH17036b)
GPG Approval	: 27 January 2023	(Ref: 18058bIGb)

Note: For this deletion, no TB document is available. However, on the harmonisation and its combination with UR S21, the TB is available in the TB for UR S21 Rev.6.

- **Corr.2 (Mar 2019)**

**1 Origin for Change:**

Request by GPG 15139\_IGh dated 18/9/2016

**2 Main Reason for Change:**

The applicability of ESP to the self-unloading bulk carriers (SUBC) leads to the GPG request to identify the UR S which are NOT applicable to SUBC.

The UR S21 is not applicable to bulk carriers as mentioned in 1.1. Therefore this corrigenda clarifies the UR is neither applicable to SUBC. This clarification has been added for removing any ambiguity in the application scope.

**3 List of non-IACS Member classification societies contributing through the TC Forum and/or participating in IACS Working Group:**

None

**4 History of Decisions Made:**

Discussion at the HP meeting in 2016  
Analysis by Hull Panel Chair  
Discussion and decision by the Hull Panel in 2018

**5 Other Resolutions Changes:**

Within this study for SUBC application: UR S17, 18 and 30.

**6 Any hinderance to MASS, including any other new technologies:**

None

**7 Dates:**

Original Proposal: 14 June 2018                      Made by: Hull Panel  
Panel Approval: 11 December 2018  
GPG Approval: 04 March 2019 (Ref. 15139\_IGI)

- **Corr.1 (Feb 2018)**

**.1 Origin for Change:**

Requested by non-IACS entity

**.2 Main Reasons for Change:**

Many materials with lower friction coefficient are applied for hatch cover supports, not only one plastic material.

**.3 List of non-IACS Member Classification Societies contributing through the TC Forum and/or participating in IACS Working Group:**

None

**.4 History of Decisions Made:**

A hatch cover manufacturer addressed questions to IACS related to the UR S21A permissible nominal surface pressure including the meaning of the different support materials provided in table 9. The Hull Panel developed the answer to Industry questions including necessary clarifications.

Please refer to the TB section (Annex 4) for the details of the correction.

**.5 Other Resolutions Changes**

None

**.6 Dates:**

Original proposal: December 2017 Made by: Hull Panel  
Panel Approval: 26 January 2018 (Ref: PH17029)  
GPG Approval: 19 February 2018 (Ref. 17179\_IGf)

• **Rev.1 (May 2015)**

**.1 Origin for Change:**

Request by non-IACS entity

**.2 Main Reasons for Change:**

Comments were received from industry in 2011 and the Hull Panel decided that further work was needed to clarify the requirements. Rule amendments include modifications of definition and application as well as clarification of the approach to partial loading of containers on hatches.

**.3 List of non-IACS Member classification societies contributing through the TC Forum and/or participating in IACS Working Group:**

None

**.4 History of Decisions Made:**

UR S21A was issued in May 2011, with a minor correction in Oct 2011. In late 2011, an IACS Member received comments/questions on UR S21A from Cargotec during the Member's rules amendment process. In 2012, the Hull Panel developed unified IACS response to the comments, but noted that further work would be needed. At the 18th Hull Panel Meeting (Mar. 2013), the Hull Panel agreed to establish PT PH31/2013 to study the issues surrounding UR S21A. In addition, a small study was performed by PT PH31 which compared various partial loading conditions for a hatch cover on which a stack of containers is partially supported by an outboard stanchion.

A recommendation on fixing or harmonizing UR S21A was submitted to IACS Hull Panel on 28 Feb. 2014. After 20th Hull Panel meeting (Mar. 2014), the Hull Panel requested PT PH31/2013 to revise UR S21A according to the proposed recommendation.

At first, minor amendments were made to the document and submitted to Hull Panel for review. Then, feedback from Hull Panel was considered for further revision of the document.

Please refer to the rule text and TB section for the details of the amendments.

#### **.5 Other Resolutions Changes**

None

#### **.6 Dates:**

Original proposal: Mar 2015 Made by: PT PH31/2013

Panel Approval: 29 Mar 2015 by: Hull Panel

GPG Approval: 26 May 2015 (Ref: 13173\_IGf)

#### **• Corr.1 (Oct 2011)**

##### **.1 Origin for Change:**

Suggestion by an IACS member

##### **.2 Main Reasons for Change:**

Error in the equation of design load on freeboard deck for ships with less freeboard than type B according to ICLL in Table 1.

##### **.3 List of non-IACS Member classification societies contributing through the TC Forum and/or participating in IACS Working Group:**

None

##### **.4 History of Decisions Made:**

A Hull Panel member located a possible error in the equation of design load on freeboard deck for ships with less freeboard than type B according to ICLL in Table 1. Hull Panel confirmed the error by comparing the equation with that in CSR-BC and requested for a correction.

Please refer to the TB section for the details of the correction.

#### **.5 Other Resolutions Changes**

None

#### **.6 Dates:**

Original proposal: *August 2011 Made by: Hull Panel*  
Panel Approval: *24 August 2011 by: Hull Panel*  
GPG Approval: *21 October 2011 (Ref. 11078\_IGe)*

- **New (May 2011)**

**.1 Origin for Change:**

- Other (In order to specify strength criteria for hatch covers on ship types other than bulk carriers, ore carriers and combination carriers, to demonstrate compliance of hatch covers with ILLC 66 Regulation 16)

**.2 Main Reasons for Change:**

Regulation 16 of the International Load Line Convention (ILLC) 1966 specifies loads on hatch covers that are to be applied to all types of ships. UR S21, Rev. 5 gives strength criteria for hatch covers on bulk carriers, ore carriers and combination carriers as defined in UR Z11. Currently no requirement exists for hatch covers on ship types other than the aforementioned.

This UR is intended to cover that gap by enumerating strength requirements for hatch covers on ship types other than bulk carriers, ore carriers and combination carriers as defined in UR Z11.

**.3 List of non-IACS Member classification societies contributing through the TC Forum and/or participating in IACS Working Group:**

None

**.4 History of Decisions Made:**

Action to create task decided at 2nd Hull Panel meeting. Task No. 14 was assigned by the Hull Panel to this undertaking. A dedicated project team was created to execute this task.

Form A was approved by GPG on 5 August 2005. Preliminary versions of the proposed UR and technical background documents were circulated among the Hull Panel members for review.

Final version approved at the 14th Hull Panel meeting in February 2011.

**.5 Other Resolutions Changes**

None

**.6 Dates:**

Original proposal: *December 2010 Made by: Hull Panel*  
Panel Approval: *February 2011 by: Hull Panel*  
GPG Approval: *23 May 2011 (Ref. 11078\_IGc)*

## **Part B. Technical Background**

List of Technical Background (TB) documents for UR S21A:

Annex 1. **TB for New (May 2011)**

See separate TB document in Annex 1.

Annex 2. **TB for Corr.1 (Oct 2011)**

See separate TB document in Annex 2.

Annex 3. **TB for Rev.1 (May 2015)**

See separate TB documents in Annex 3.

Annex 4. **TB for Corr.1 (Feb 2018)**

See separate TB documents in Annex 4.

**Note:** *There are no separate Technical Background (TB) documents for Corr.2 (Mar 2019) and Del (Jan 2023)*

## **Technical Background for UR S21A New, May 2011**

### **1. Scope and objectives**

To define strength criteria for hatch covers on ship types other than bulk carriers, ore carriers and combination carriers as defined in UR Z11.

### **2. Engineering background for technical basis and rationale**

Reg. 16 of the ICLL 1966 specifies hatch cover loads for all ship types. While a UR (S21) pertaining hatch cover strength exists for bulk carriers, ore carriers and combination carriers, as defined in URZ11, there are no criteria for other ship types. This UR is intended to fill that gap.

### **3. Source/derivation of the proposed IACS Resolution**

The source of the information was obtained through work performed by a dedicated project team and additional input from the Hull Panel.

### **4. Summary of Changes intended for the revised Resolution:**

Not applicable

### **5. Points of discussions or possible discussions**

The UR was developed by the project team (PT) for Task No. 14. Discussions on the draft documents prepared by the PT were reviewed and discussed within the Hull Panel at Panel meetings and via email correspondence.

### **6. Attachments if any**

Detailed technical background document is attached.



# **Technical Background for UR S21A**

**Evaluation of Scantlings of Hatch Covers and  
Hatch Coamings and Closing Arrangements of  
Cargo Holds of Ships**

# Technical Background for UR S21a “Evaluation of Scantlings of Hatch Covers and Hatch Coamings and Closing Arrangements of Cargo Holds of Ships”

## **TB S21a.1 Introduction**

UR S21a was developed to supplement UR 21 and applies to all ships except bulk carriers, ore carriers and combination carriers, as defined in UR Z11.

## **TB S21a.2 Application and definitions (UR S21a.1)**

### **TB S21a.2.1 Definitions – Positions (UR S21a.1.2.2)**

The defined positions for hatch covers upon exposed decks are as given by the International Convention on Load Lines (ICLL), 1966 as amended by the 1988 protocol, as amended in 2003, Regulation 13.

### **TB S21a.2.2 Material (UR S21a.1.3)**

The structural integrity of hatch covers is important for the survivability of ships. As a consequence a material class I according to UR S6 (Use of steel grades for various hull members - ships of 90 m in length and above) is to be applied for hatch covers.

### **TB S21a.2.3 General requirements (UR S21a.1.4)**

Hatch cover primary supporting members are required to be continuous to provide sufficient load carrying capacity and an adequate transmission of forces when grillage effects are taken into account.

For similar reason, a maximum spacing of the primary supporting members parallel to the direction of secondary stiffeners is included. It shall not exceed 1/3 of the span of primary supporting members. A ratio of spacing/length limited to 1/3 guarantees a relatively high ratio of effective breadth/spacing. When strength calculation is carried out by FE analysis using plane stress or shell elements, this requirement can be waived because shear lag effects are implicitly considered by this assessment method as long as the mesh density is sufficiently fine.

Hatch cover secondary stiffeners are required to be continuous in order to have the necessary buckling strength against the compressive loads induced by the bending of primary supporting members.

Hatch coaming secondary stiffeners are required to be continuous in order to be able to sustain the bending moment distribution assumed for these elements.

### TB S21a.3 Hatch cover and coaming load model (UR S21a.2)

#### TB S21a.3.1 Vertical weather design load (UR S21a.2.1)

The vertical weather design loads adopted in UR S21a are identical with the loads given by ICLL in Regulation 16 (2), (3), and (4) except for exposed superstructure decks of ships with a length  $L > 100$  m located at least one superstructure standard height above the lowest Position 2 deck. For these decks a reduced design load of  $2.1 \text{ t/m}^2$  is required as given by UI LL 70.

The provision that, under the given conditions, the design load for hatch covers on the actual freeboard deck may be as required for a superstructure deck originates from UI LL 70 and is based on an assumed freeboard deck as defined in IACS UI LL64.

The height of the hatch coaming above deck less 600 mm may be considered for the definition of the assumed freeboard deck with respect to the determination of the vertical weather design load on hatch covers.

#### TB S21a.3.2 Horizontal weather design load (UR S21a.2.2)

As the load model adopted by S21 is very much specific to bulk carriers and does not consider the height of a structure above the load line of the assessed ship, the project team decided to adopt the horizontal weather design load from UR S3 (Strength of end bulkheads of superstructures and deckhouses) except for the definition of factor  $f$  and  $c_L$ . Factor  $f$  is a wave coefficient and was adopted from UR S11 (Longitudinal strength standard). For ships of less than 90 m in length factor  $f$  was newly defined as it is not given by UR S11. Factor  $c_L$  is less than one for ships of less than 90 m in length and reduces the effect of wave coefficient  $f$ .

#### TB S21a.3.3 Calculation of container loads (UR S21a.2.4)

Formulas for the support forces  $A_z$ ,  $B_z$  and  $B_y$  acting on the hatch cover are based on the assumption that the full vertical static and dynamic acceleration  $g \cdot (1+a_v)$  is acting in combination with an acceleration of  $0,5 \cdot g$  in transverse direction. The dynamic acceleration factor  $a_v$  depends on the position of the considered hatch cover in longitudinal direction. The typical distribution of  $a_v$  over the ship length is shown in Fig. 1. The transverse acceleration of  $0,5 \cdot g$  corresponds to a static heel of  $30^\circ$ .

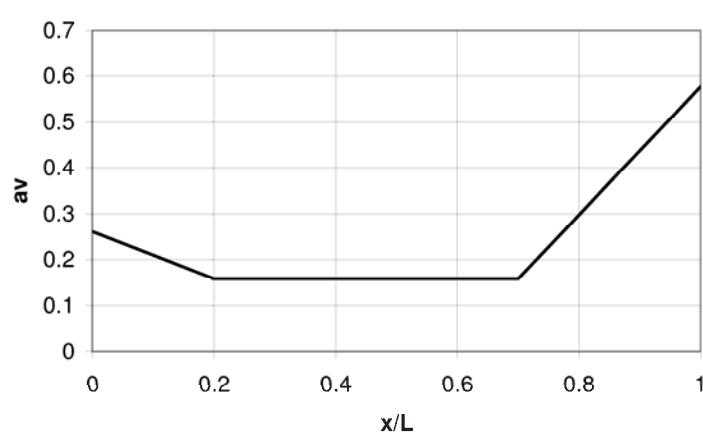
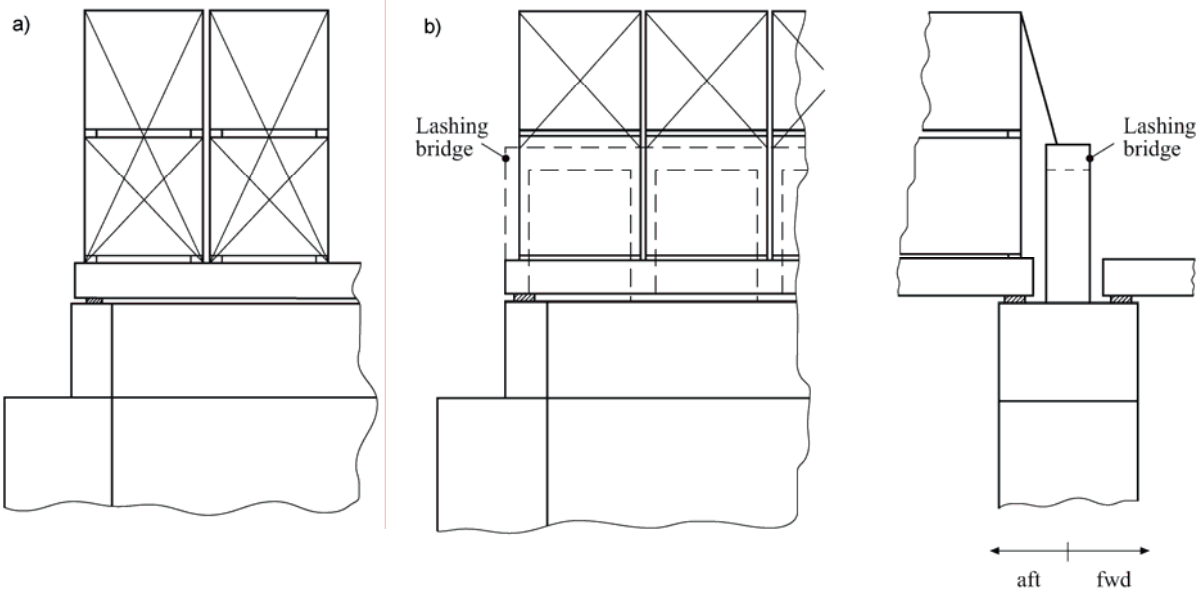


Fig. 1 Distribution of factor  $a_v$

In case of container stacks secured to lashing bridges or carried in cell guides the forces acting on the hatch cover may be specially considered. Fig. 2 gives an example for container secured to the hatch cover (a) and secured to a lashing bridge (b). In the latter case the forces due to the ship's roll motion are transmitted partially to the lashing bridge so that the formulas for the forces acting on the hatch cover given by UR S21a.2.3 may not be applicable. However, as the torsional stiffness of container stacks is limited, support forces at corners of 20' container stacks away from lashing bridge or cell guides, respectively, may not be influenced considerably. These support forces at half length of the hatch cover are definitive for the structural design of the cover. Thus,  $A_z$ ,  $B_z$  and  $B_y$  acting on the hatch cover at those stack corners may be assumed according to the given formulae in a conservative manner.



**Fig. 2 Container secured to the hatch cover (a) and to a lashing bridge (b)**

As an alternative to the given container loads, UR S21a allows applying container loads based on accelerations calculated by an individual acceleration analysis for the used lashing system. The individual acceleration analysis shall be carried out by the individual classification society.

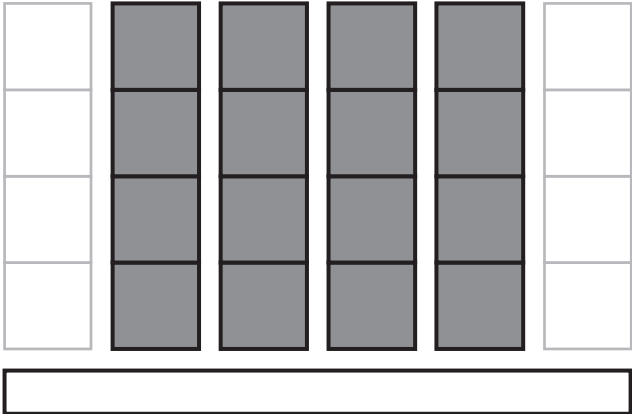
This alternative assessment method allows designing hatch covers more individually with respect to the applied lashing system and according to the acceleration calculation of the individual class society. However, a load model independent from the lashing system provides more flexibility to the owner in choosing different lashing systems or modifying the lashing system without to be limited by the hatch cover design.

**TB S21a.3.3.1 Load cases with partial loading (UR S21a.2.4.1)**

Point loads and container loads acting on the hatch cover are also to be considered for partial non homogeneous loading which may occur in practice, e.g. where specified container stack places are empty.

UR S21a gives a simplified approach for assessing the partial loading of container hatch covers where the hatch cover is loaded without the outermost stacks, as can be seen in Fig. 3. It

may be necessary to also consider partial load cases where more or different container stacks are left empty.

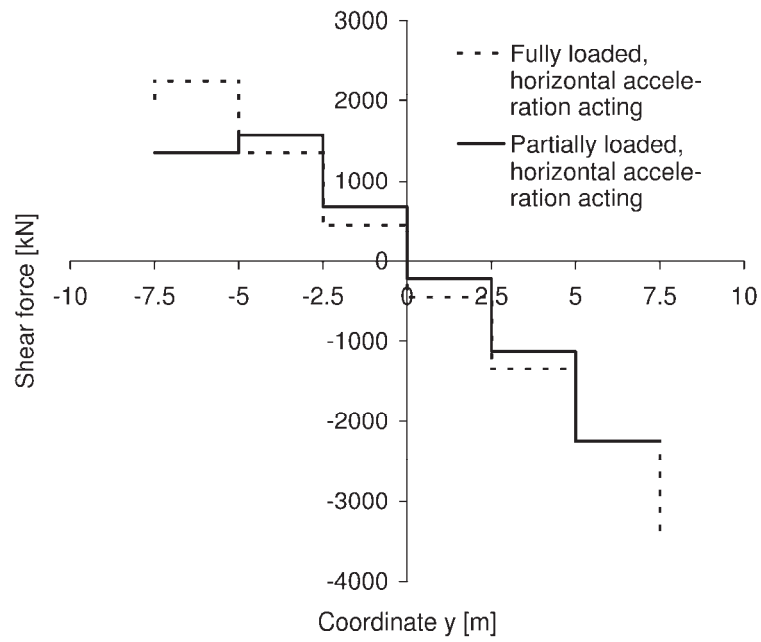


**Fig. 3 Partial loading of a container hatch cover**

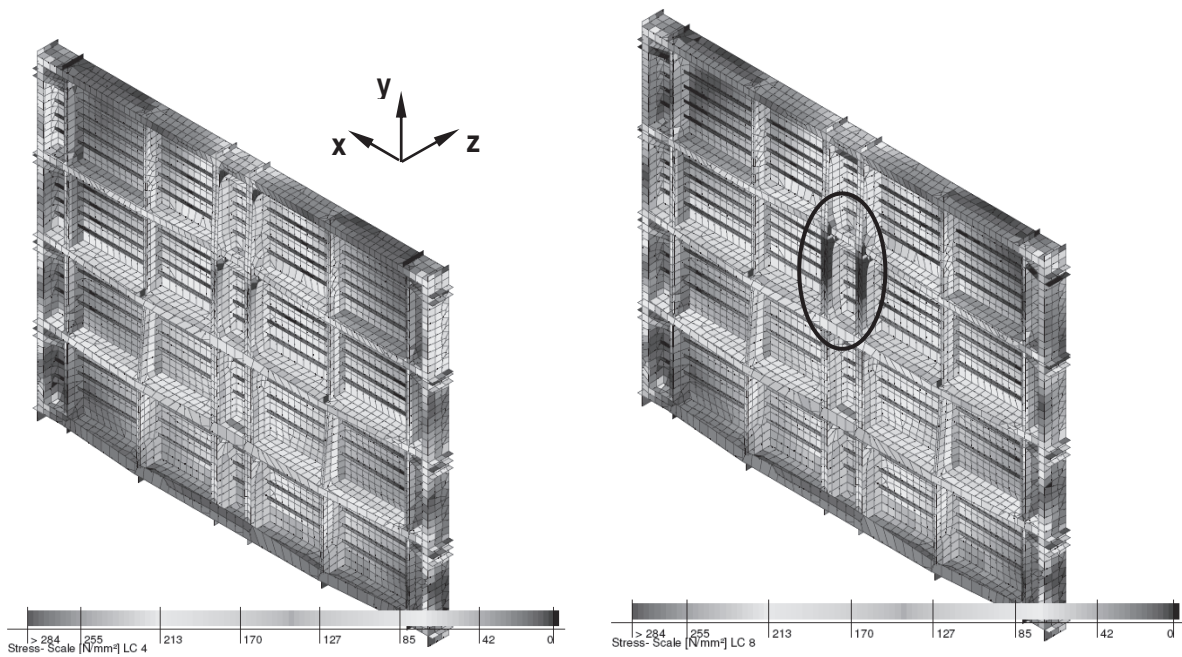
The need for these considerations arise from the occurrence of increased loads due to the unbalanced vertical support forces at the supports of container stacks next to the empty stack places caused by the ship’s roll motion.

Fig. 4 schematically illustrates resulting shear force distributions in a transverse primary supporting member of a hatch cover loaded with 20' containers. Distributions are shown for the hatch cover fully loaded and for the partial load case shown in Fig. 3 with horizontal acceleration acting. As can be seen, for the partial container load case in some areas increased shear forces occur.

For further illustration, Fig. 5 shows the equivalent stress distributions of a hatch cover loaded with stacks of 20’ container and exposed to vertical and horizontal accelerations. On the left hand side, the hatch cover is fully loaded and on the right hand side the stress distribution is shown for a partial load case similar to the one shown in Fig. 3. It can be seen that increased stresses occur in the center transverse primary supporting members.



**Fig. 4 Shear forces acting in a transverse primary supporting member of a hatch cover due to different load cases**



**Fig. 5 Stress distribution in a hatch cover, fully loaded (left) and with partial loading (right)**

## TB S21a.4 Hatch cover strength criteria (UR S21a.3)

### TB S21a.4.1 Permissible stresses and deflections - Stresses (UR S21a.3.1.1)

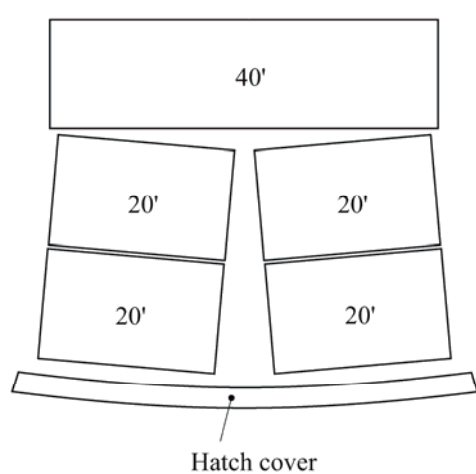
The equivalent stress according to v. Mises is to be assessed. In general, the permissible equivalent stress is 80% of the minimum yield point of the material as required by ICLL Regulation 16 (5).

When loads other than the vertical weather design load are assessed using FEM with plane stress or shell elements the permissible equivalent stress is 90% of the minimum yield point of the material. This is reasonable because due to Poisson effects FEM may calculate increased stresses compared to a grillage analysis. Furthermore, this is justified by the use of FEM as a more sophisticated assessment tool. However, the increased permissible stress is only to be applied for loads other than the vertical weather design load to not contradict ICLL regulations.

### TB S21a.4.2 Permissible stresses and deflections - Deflection (UR S21a.3.1.2)

The deflection limit as given by ICLL Regulation 16 (5) is included for the vertical weather design load case.

Where hatch covers are arranged for carrying containers and mixed stowage is allowed, i.e., a 40'-container stowed on top of two 20'-containers, particular attention should be paid to the deflections of hatch covers. Fig. 6 gives an example for a mixed stowage situation and the resulting hatch cover and container stack deflection.



**Fig. 6 Example for mixed stowage and resulting hatch cover and container stack deflection**

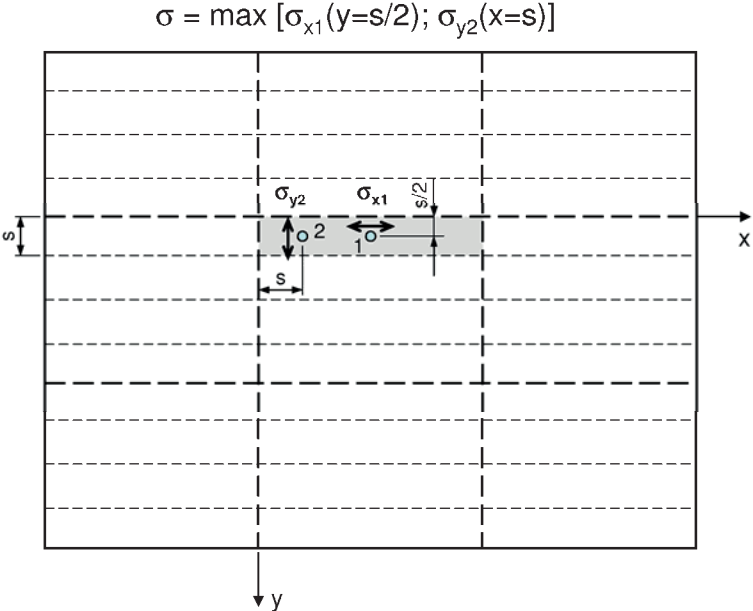
### TB S21a.4.3 Local net plate thickness (UR S21a.3.2)

The requirement for the minimum net plate thickness of hatch cover top plating subjected to the vertical weather design load and distributed cargo loads is the same as used in UR S21.

The coefficient 15,8 used in the expression applies for plates under pressure with clamped edges that are free to pull in and with plastic hinges at the edges and at mid-span.

An additional factor  $F_p \geq 1,5$  is introduced to account for co-existing compressive membrane stress in the hatch cover top plate as well as the possibility that the lateral pressure loading may locally exceed the assumed value. Factor  $F_p$  is increased linearly to 1,90 for the attached plate flange of primary supporting members stressed above 80% of the allowable stress limit.

The normal stress of the hatch cover plating may be determined in a distance equal to the stiffener spacing  $s$  from webs of adjacent primary supporting members perpendicular to secondary stiffeners and in a distance equal to half of the stiffener spacing  $s$  from the web of an adjacent primary supporting member parallel to secondary stiffeners. This accounts for the shear lag effect leading to reduced membrane stresses at the assessed locations. As an example, Fig. 7 shows locations for determination of  $\sigma_x$  and  $\sigma_y$  for the plate field marked in grey. The greater of both stresses is to be taken for the normal stress of the hatch cover plating in the requirement for the local net plate thickness. At assessment point 1 an intermediate stress  $\sigma_x$  over the plate breadth  $s$  is determined which is reasonable for the assumed three-hinge-collapse failure mode. The assessment of  $\sigma_y$  at point 2, located in a distance equal to the stiffener spacing from the web of the adjacent primary supporting member, accounts for reduced local bending stresses close to the short edge of the plate field.



**Fig. 7 Determination of normal stress of hatch cover plating**

**TB S21a.4.4 Net scantling of secondary stiffeners (UR S21a.3.3)**

For secondary stiffeners, the minimum elastic section modulus is derived from the elastic bending moment at the fixed end under consideration of the permissible stress as required by ICLL Regulation 16 (5). Only the lateral pressure is considered, while the second order bending moment caused by the combined effect of stiffener deflection (by the lateral pressure load) and the membrane stress in the plate (from the bending of the primary supporting member) is disregarded.

If secondary stiffeners parallel to primary supporting members are regarded for calculating the cross sectional properties of these primary supporting members, it is to be verified that the combined stress of those stiffeners induced by the bending of primary supporting members and lateral pressures does not exceed the permissible stresses.

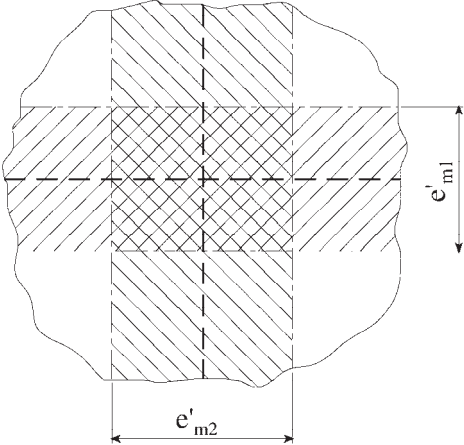


For hatch cover stiffeners under compression sufficient safety against lateral and torsional buckling is to be verified.

For flat bar secondary stiffeners, a limit on the web depth to net thickness ratio is introduced to prevent their local buckling. This requirement is adopted from UR S21.

**TB S21a.4.5 Net scantling of primary supporting members - Primary supporting members (UR S21a.3.4.1)**

For all components of primary supporting members sufficient safety against buckling must be verified. For biaxial compressed flange plates this is to be verified within the effective widths. For illustration, Fig. 8 shows a crossing of two primary supporting members with their effective widths. The area where a buckling proof must be carried out for biaxial compression is marked in grey. The buckling proof for parts of the hatch cover plating located in this area is to be done as a combined proof for cases 1 and 2 according to Tab. 5 of UR S21a.



**Fig. 8 Crossing of two primary supporting members and their effective widths**

**TB S21a.4.6 Edge girders (Skirt plates) (UR S21a.3.4.2)**

For edge girders the same requirement for minimum net plate thickness is adopted as for the hatch cover top plating except for minimum thickness values that do not depend on the pressure load.

Furthermore, a stiffness requirement for edge girders similar to the requirement as given by IACS Rec. 14 is incorporated to maintain an adequate sealing pressure between securing devices.

**TB S21a.4.7 Strength calculations (UR S21a.3.5)**

Strength calculation for hatch covers may be carried out by either, using beam theory, grillage analysis or FEM. However, simple beam models shall be adopted only for hatch covers that are not designed as a grillage of longitudinal and transverse primary supporting members. In other cases a grillage analysis using beam elements or an FEM analysis using plane stress or shell elements is appropriate.

#### **TB S21a.4.7.1 Strength calculations - Effective cross-sectional properties for calculation by beam theory or grillage analysis (UR S21a.3.5.1)**

When determining cross-sectional properties of a primary supporting member, cross sectional areas of secondary stiffeners parallel to the primary supporting member under consideration and within the effective breadth can be included. In this case it is to be verified that the combined stress of those stiffeners induced by the bending of primary supporting members and lateral pressures does not exceed the permissible stresses.

Special calculations may be required for determining the effective breadth of one-sided or non-symmetrical flanges. This can be done by special engineering formulas or, if available, according to the individual class society's rules. In more complex cases an FEM calculation is recommended.

The cross-sectional area of flange plates under compression may be reduced by buckling of the plating. Flange plates with secondary stiffeners perpendicular to the web of primary supporting members are in particular prone to buckling failure. Thus, the effective width is to be considered for the determination of cross-sectional properties of such primary supporting members for grillage analysis or beam theory calculations. However, the effective width of plating is not to be taken greater than the value obtained for the effective breadth.

#### **TB S21a.4.8 Buckling strength of hatch cover structures (UR S21a.3.6)**

For further information regarding the buckling strength criteria refer to the technical background documents of Common Structural Rules for Bulk Carrier (CSR/BC), Chapter 6 – Hull Scantlings, Section 3 – Buckling & Ultimate Strength of Ordinary Stiffeners and Stiffened Panels.

Safety factors for the buckling strength assessment are based on the net scantling approach. To be in compliance with ICLL Regulation 16 (5) the safety factor for assessing the hatch cover when subjected to the vertical weather design load is to be taken equal to 1,25. For loads other than the vertical weather design load, a safety factor equal to 1,1 is to be applied. This is justified by the more sophisticated buckling strength approach compared to the approach in UR S21. The chosen safety factor of 1,1 matches that of CSR/BC to be used with this kind of buckling strength approach.

The given correction factors  $F_1$  for boundary conditions at the longitudinal stiffeners correspond to the values given by CSR/BC.

#### **TB S21a.4.8.1 Buckling strength of hatch cover structures - Proof of partial and total fields of hatch covers - Lateral buckling of secondary stiffeners (UR S21a.3.6.3.3)**

The factor  $c_s$  accounts for the boundary conditions of transverse secondary stiffeners. It is to be 1,0 for simply supported and 2,0 for partially constraint stiffeners. Fig. 9 gives examples for the factor  $c_s$ . For a stiffener, the supports of which are equally spaced, a factor  $c_s = 1,0$  is to be chosen (a). If a stiffener spacing changes from a wide spacing to a much more narrow spacing, a partial constraint exists and  $c_s = 2,0$  is to be chosen (b). Also when brackets are fitted at the supports of the stiffener, it is to be assumed as partially constraint.



a)  $c_s = 1,0$  for simply supported stiffeners



b)  $c_s = 2,0$  for partially constraint stiffeners

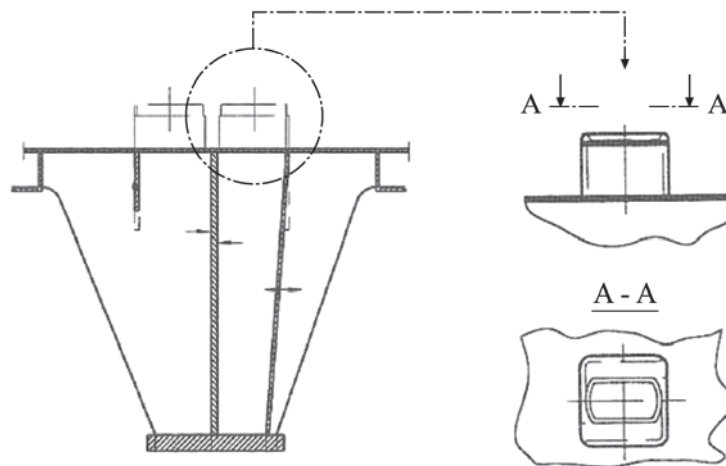
**Fig. 9 Examples for the factor  $c_s$  accounting for the boundary conditions of transverse secondary stiffeners**

### **TB S21a.5 Details of hatch covers (UR S21a.4)**

#### **TB S21a.5.1 Container foundations on hatch covers (UR S21a.4.1)**

UR S21a requires designing substructures of container foundations for cargo and container loads applying the given permissible stresses.

Substructures are required to effectively distribute the localized support forces at the container stack corners. An example for container foundations and their substructures is given in Fig. 10. The figure shows a section through a primary supporting member with supporting structural elements like brackets beneath two container foundations. The detail drawing shows a typical container foundation more closely.



**Fig. 10 Example for container foundations and their substructures**

#### **TB S21a.5.2 Weather tightness (UR S21a.4.2)**

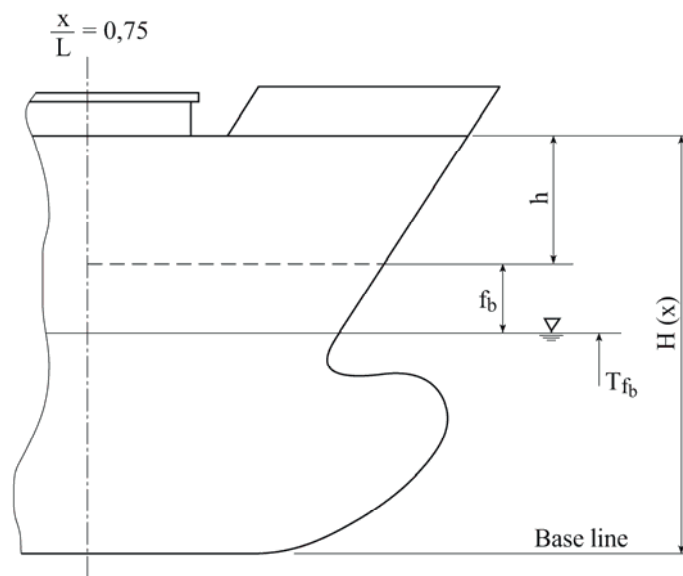
Further to the requirements as given by UR S21a the contents of IACS Rec. 14 are to be observed.

### **TB S21a.5.2.1 Weather tightness - Dispensation of weather tight gaskets (UR S21a.4.2.2)**

For hatch covers of cargo holds solely for the transport of containers, the fitting of weather tight gaskets may be dispensed with upon request by the owners and subject to compliance with the given conditions that correspond to UI LL64.

Among others, it is to be complied with the condition that the exposed deck on which the hatch covers are located is situated above a depth  $H(x)$ .  $H(x)$  is measured from the base line. The definition of  $H(x)$  is illustrated by Fig. 11 for a position forward of  $x/L = 0,75$ .

Further to the requirements as given by UR S21a, Chapter 3 of IMO MSC/Circ. 1087 is to be referred to concerning the stowage and segregation of containers containing dangerous goods.



**Fig. 11 Definition of  $H(x)$**

### **TB S21a.6 Hatch coaming strength criteria (UR S21a.5)**

#### **TB S21a.6.1 Local net plate thickness of coamings (UR S21a.5.1)**

The horizontal weather design load model was adopted from UR S3. Thus, the prescriptive local net plate thickness of hatch coamings corresponds to that given in UR S3. The plate thickness required by UR S3 was assumed as a net plate thickness for UR S21a. Additionally, a minimum net plate thickness depending on the ship length was added which is not given by UR S3. Longitudinal strength aspects are to be observed as the given plate thickness formula merely covers local pressure loads.

#### **TB S21a.6.2 Net scantlings of secondary stiffeners of coamings (UR S21a.5.3)**

Similar to the prescriptive local net plate thickness, the prescriptive net scantlings for secondary stiffeners of hatch coamings correspond to those given in UR S3. Again, the stiffener section modulus required by UR S3 was assumed as a net section modulus for UR S21a. In addition, a minimum net cross sectional area of secondary stiffeners is required. The latter is based on the elastic shear force of a continuous beam under a uniformly distributed load.

### **TB S21a.6.3 Coaming stays (UR S21a.5.3)**

Coaming stays in general are to be designed for the loads transmitted through them and permissible stresses as defined for hatch cover structures.

For stays of coamings with a height of less than 1,6 m and subjected to the horizontal design weather load, a prescriptive minimum section modulus and web thickness of the stay at the root point are given equal to the requirements of UR S21. Formulae were derived for the elastic shear force and bending moment appropriate to a cantilever under a uniformly distributed pressure. For coaming stays having a height of 1,6 m or more, prescriptive scantlings have not been formulated as a cantilever design can not be assumed.

### **TB S21a.7 Closing arrangements (UR S21a.6)**

#### **TB S21a.7.1 Securing devices - Cross-sectional area of the securing devices (UR S21a.6.1.4)**

The requirements, UR S21a gives for the minimum cross-sectional area of securing devices used to maintain an adequate sealing pressure, correspond to the requirement as given by IACS Rec. 14.

For small hatch covers where the packing line pressure needs to be maintained by securing devices, typically rod type securing devices are used. For this type of securing device the given minimum cross-sectional area is applicable.

For large hatch covers securing devices may not be necessary to maintain packing line pressure as the covers are heavy enough. Securing devices then may be needed only as anti-lifting devices. These often exhibit designs which can not be sufficiently assessed only by a required cross-sectional area. They are to be designed according to the requirements for anti-lifting devices (UR S21a.6.1.5).

Where securing devices of special design are used to maintain the packing line pressure and in which significant bending or shear stresses occur, these may be designed as anti-lifting devices. As load the packing line pressure multiplied by the spacing between securing devices is to be applied.

### **TB S21a.8 Corrosion addition and steel renewal (UR S21a.8)**

The requirements for corrosion additions of hatch cover structures are consistent with UI LL70. The requirements for corrosion additions of hatch coamings are consistent with UR S21.

The requirements for steel renewal of hatch cover structures are consistent with the requirements as given by UR S21. Steel renewal requirements for hatch coamings are to be according to the individual class society's rules.

## **Technical Background for UR S21A Corr.1, Oct 2011**

### **1. Scope and objectives**

To correct the error in the equation of design load on freeboard deck for ships with less freeboard than type B according to ICLL in Table 1.

### **2. Engineering background for technical basis and rationale**

See attachment 1& 2.

### **3. Source/derivation of the proposed IACS Resolution**

See attachment 1& 2.

### **4. Summary of Changes intended for the revised Resolution:**

See attachment 1& 2.

### **5. Points of discussions or possible discussions**

None.

### **6. Attachments if any**

See attachment 1& 2.

# S21A

(cont)

**Tab. 1 Design load  $p_H$  of weather deck hatches**

Position	Design load $p_H$ [kN/m <sup>2</sup> ]	
	$\frac{x}{L_{LL}} \leq 0,75$	$0,75 < \frac{x}{L_{LL}} \leq 1,0$
1	for $24 \text{ m} \leq L_{LL} \leq 100 \text{ m}$	
	$\frac{9,81}{76} \cdot (1,5 \cdot L_{LL} + 116)$	on freeboard deck
		$\frac{9,81}{76} \cdot \left[ (4,28 \cdot L_{LL} + 28) \cdot \frac{x}{L_{LL}} - 1,71 \cdot L_{LL} + 95 \right]$
		upon exposed superstructure decks located at least one superstructure standard height above the freeboard deck
		$\frac{9,81}{76} \cdot (1,5 \cdot L_{LL} + 116)$
	for $L_{LL} > 100 \text{ m}$	
$9,81 \cdot 3,5$	on freeboard deck for type B ships according to ICLL	
	$9,81 \cdot \left[ (0,0296 \cdot L_1 + 3,04) \cdot \frac{x}{L_{LL}} - 0,0222 \cdot L_1 + 1,22 \right]$	
	on freeboard deck for ships with less freeboard than type B according to ICLL	
	$9,81 \cdot \left[ (0,1452 \cdot L_1 + 8,52) \cdot \frac{x}{L_{LL}} - 0,1089 \cdot L_1 + 9,89 \right]$	
	$L_1 = L_{LL}$ but not more than 340 m	
	upon exposed superstructure decks located at least one superstructure standard height above the freeboard deck	
	$9,81 \cdot 3,5$	
2	for $24 \text{ m} \leq L_{LL} \leq 100 \text{ m}$	
	$\frac{9,81}{76} \cdot (1,1 \cdot L_{LL} + 87,6)$	
	for $L_{LL} > 100 \text{ m}$	
	$9,81 \cdot 2,6$	
	upon exposed superstructure decks located at least one superstructure standard height above the lowest Position 2 deck	$9,81 \cdot 2,1$

## Attachment 2

### Comparison of Exposed Deck Design Pressure/Load Requirements

Bulk Carrier Weather Deck Hatches

for  $x/L_{LL} \leq 0.75$

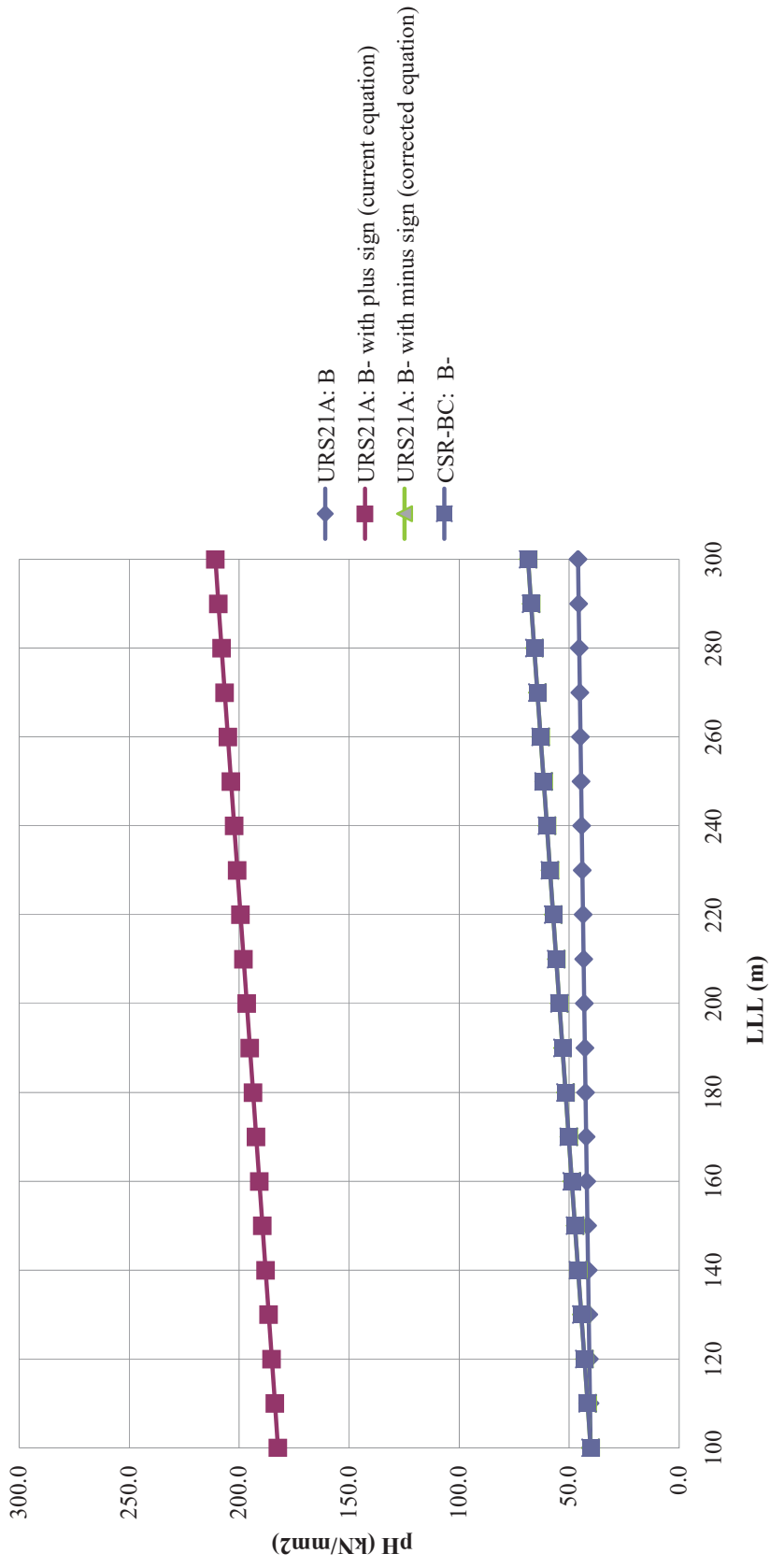
$$p_H \text{ (kN/mm}^2\text{)} = 34.335$$

$$x/L_{LL} = 0.85$$

L <sub>LL</sub> (m)	L <sub>1</sub> (m)	Design Load, p <sub>H</sub> (kN/mm <sup>2</sup> )			
		UR S21A			
		B	B- (w/+sign, current)	B- (w/-sign, corrected)	CSR-BC
100	100	40.2	182.3	40.2	40.2
110	110	40.5	183.7	41.6	41.6
120	120	40.8	185.2	43.1	43.1
130	130	41.1	186.6	44.5	44.5
140	140	41.4	188.0	45.9	45.9
150	150	41.7	189.4	47.3	47.3
160	160	42.0	190.9	48.8	48.8
170	170	42.3	192.3	50.2	50.2
180	180	42.5	193.7	51.6	51.6
190	190	42.8	195.1	53.0	53.0
200	200	43.1	196.6	54.5	54.5
210	210	43.4	198.0	55.9	55.9
220	220	43.7	199.4	57.3	57.3
230	230	44.0	200.8	58.7	58.7
240	240	44.3	202.3	60.2	60.2
250	250	44.6	203.7	61.6	61.6
260	260	44.9	205.1	63.0	63.0
270	270	45.2	206.5	64.4	64.4
280	280	45.4	207.9	65.9	65.9
290	290	45.7	209.4	67.3	67.3
300	300	46.0	210.8	68.7	68.7



# Comparison of Exposed Deck Design Pressure Requirements



## References:

URS12A

### **Tab. 1 Design load $p_H$ of weather deck hatches**

#### **Design load $p_H$ [kN/m<sup>2</sup>]**

For  $L_{LL} > 100\text{mm}$  and  $x/L_{LL} \leq 0.75$

$$9,81 \cdot 3,5$$

For  $L_{LL} > 100\text{mm}$  and  $0.75 < x/L_{LL} < 1.0$

on freeboard deck for type B ships according to ICLL

$$9,81 \cdot \left[ (0,0296 \cdot L_1 + 3,04) \cdot \frac{x}{L_{LL}} - 0,0222 \cdot L_1 + 1,22 \right]$$

on freeboard deck for ships with less freeboard than type B according to ICLL

$$9,81 \cdot \left[ (0,1452 \cdot L_1 \ominus 8,52) \cdot \frac{x}{L_{LL}} - 0,1089 \cdot L_1 + 9,89 \right]$$

$L_1 = L_{LL}$  but not more than 340 m

upon exposed superstructure decks located at least one superstructure standard height above the freeboard deck

$$9,81 \cdot 3,5$$

**Table 4: Pressures on exposed decks for H1, H2, F1 and F2**

Location	Pressure $p_W$ , in kN/m <sup>2</sup>	
	$L_{LL} \geq 100$ m	$L_{LL} < 100$ m
$0 \leq x_{LL}/L_{LL} \leq 0.75$	34.3	$14.9 + 0.195 L_{LL}$
$0.75 < x_{LL}/L_{LL} < 1$	$34.3 + (14.8 + a(L_{LL} - 100)) \left( 4 \frac{x_{LL}}{L_{LL}} - 3 \right)$	$12.2 + \frac{L_{LL}}{9} \left( 5 \frac{x_{LL}}{L_{LL}} - 2 \right) + 3.6 \frac{x_{LL}}{L_{LL}}$

where:

- $a$ : Coefficient taken equal to:
  - $a = 0.0726$  for Type B freeboard ships
  - $a = 0.356$  for Type B-60 or Type B-100 freeboard ships.
- $x_{LL}$ : X coordinate of the load point measured from the aft end of the freeboard length  $L_{LL}$ .

## **Technical Background Document UR S21, Rev. 1 (May 2015)**

### **1. Objective/Scope**

Comments were received from industry in 2011 and the Hull Panel decided that further work was needed to clarify the requirements. Rule amendments include modifications of definition and application as well as clarification of the approach to partial loading of containers on hatches.

### **2. Source of Proposed Requirements**

See attachment 1& 2.

### **3. Technical Basis and Rationale**

See attachment 1& 2.

### **4. Summary of Changes**

See attachment 1& 2.

### **5. Points of Discussion**

None

### **6. Attachments, if any**

See attachment 1& 2.

\*\*\*

# **Technical Background for UR S21A**

**Evaluation of Scantlings of Hatch Covers and  
Hatch Coamings and Closing Arrangements of  
Cargo Holds of Ships**

## **TB S21a.1 Introduction**

UR S21a was developed to supplement UR 21 and applies to all ships except bulk carriers, ore carriers and combination carriers, as defined in UR Z11.

## **TB S21a.2 Application and definitions (UR S21a.1)**

### **TB S21a.2.1 Definitions – Positions (UR S21a.1.2.2)**

The defined positions for hatch covers upon exposed decks are as given by the International Convention on Load Lines (ICLL), 1966 as amended by the 1988 protocol, as amended in 2003, Regulation 13.

### **TB S21a.2.2 Material (UR S21a.1.3)**

The structural integrity of hatch covers is important for the survivability of ships. As a consequence a material class I according to UR S6 (Use of steel grades for various hull members - ships of 90 m in length and above) is to be applied for top plate, bottom plate and primary supporting members.

### **TB S21a.2.3 General requirements (UR S21a.1.4)**

Hatch cover primary supporting members are required to be continuous to ensure their load carrying capacity and an adequate transmission of forces when grillage effects are taken into account.

For similar reason, a maximum spacing of the primary supporting members parallel to the direction of secondary stiffeners is included. It shall not exceed 1/3 of the span of primary supporting members. A ratio of spacing/length limited to 1/3 guarantees a relatively high ratio of effective breadth/spacing. When strength calculation is carried out by FE analysis using plane stress or shell elements, this requirement can be waived because shear lag effects are implicitly considered by this assessment method as long as the mesh density is sufficiently fine.

Hatch cover secondary stiffeners are required to be continuous in order to have the necessary buckling strength against the compressive loads induced by the bending of primary supporting members.

Hatch coaming secondary stiffeners are required to be continuous in order to be able to sustain the bending moment distribution assumed for these elements.

### **TB S21a.2.4 Net scantling approach (UR S21a.1.5)**

Hatch cover strength has to be calculated using grillage analysis or FEM. Grillage analysis means analysis of grillage structures using beam elements. FEM means finite element analysis using shell elements, plane stress elements and beam elements, where beam elements may be used to idealize flanges of primary supporting members and secondary stiffeners.

## **TB S21a.3 Hatch cover and coaming load model (UR S21a.2)**

### **TB S21a.3.1 Vertical weather design load (UR S21a.2.1)**

The vertical weather design loads adopted in UR S21a are identical with the loads given by ICLL in Regulation 16 (2), (3), and (4) except for exposed superstructure decks of ships with a length  $L > 100$  m located at least one superstructure standard height above the lowest Position 2 deck. For these decks a reduced design load of  $2.1 \text{ t/m}^2$  is required as given by UI LL 70.

The provision that, under the given conditions, the design load for hatch covers on the actual freeboard deck may be as required for a superstructure deck originates from UI LL 70 and is based on an assumed freeboard deck as defined in IACS UI LL64.

The height of the hatch coaming above deck less 600 mm may be considered for the definition of the assumed freeboard deck with respect to the determination of the vertical weather design load on hatch covers.

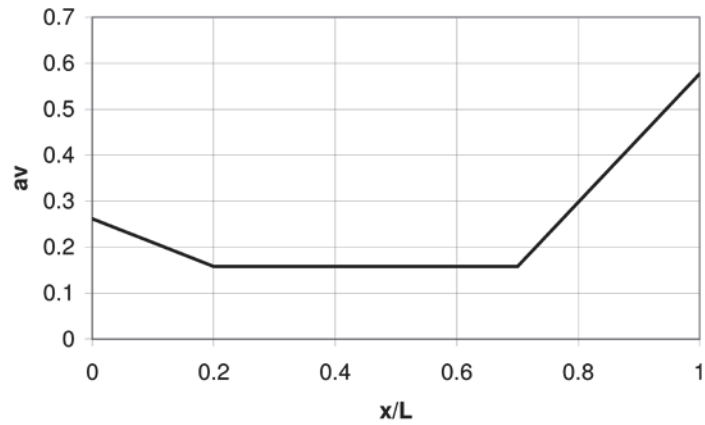
### **TB S21a.3.2 Horizontal weather design load (UR S21a.2.2)**

As the load model adopted by S21 is very much specific to bulk carriers and does not consider the height of a structure above the load line of the assessed ship, the project team decided to adopt the horizontal weather design load from UR S3 (Strength of end bulkheads of superstructures and deckhouses) except for the definition of factor  $f$  and  $c_L$ . Factor  $f$  is a wave coefficient and was adopted from UR S11 (Longitudinal strength standard). For ships of less than 90 m in length factor  $f$  was newly defined as it is not given by UR S11. Factor  $c_L$  is less than one for ships of less than 90 m in length and reduces the effect of wave coefficient  $f$ .

The horizontal weather design load needs not to be included in the direct calculation of skirt plates of the hatch cover. It is considered that the horizontal weather design load has no impact on scantlings of the primary supporting members except for the thickness of skirt plates, which is determined by formulae defined in 3.4.2.

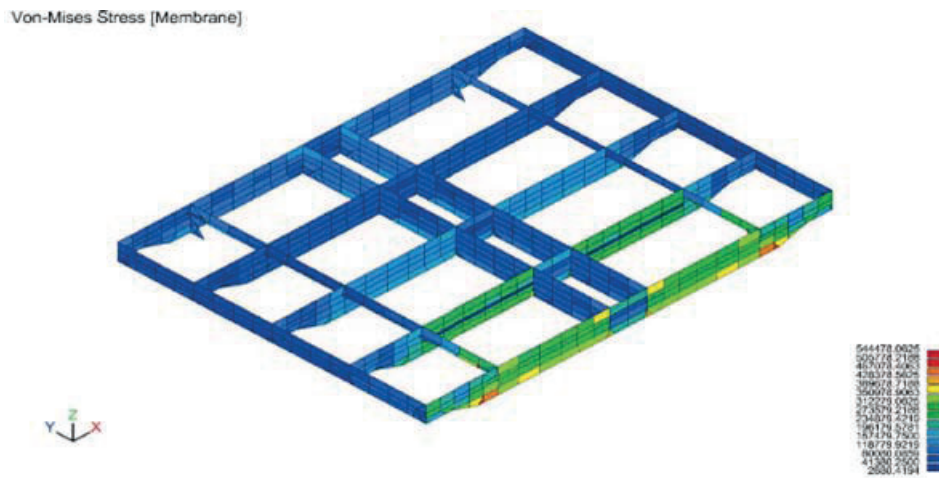
### **TB S21a.3.3 Calculation of container loads (UR S21a.2.4)**

Formulas for the support forces  $A_z$ ,  $B_z$  and  $B_y$  acting on the hatch cover are based on the assumption that the full vertical static and dynamic acceleration  $g \cdot (1+a_v)$  is acting in combination with an acceleration of  $0,5 \cdot g$  in transverse direction. The dynamic acceleration factor  $a_v$  depends on the position of the considered hatch cover in longitudinal direction. The typical distribution of  $a_v$  over the ship length is shown in Fig. 1. The transverse acceleration of  $0,5 \cdot g$  corresponds to a static heel of  $30^\circ$ .



**Fig. 1 Distribution of factor  $a_v$**

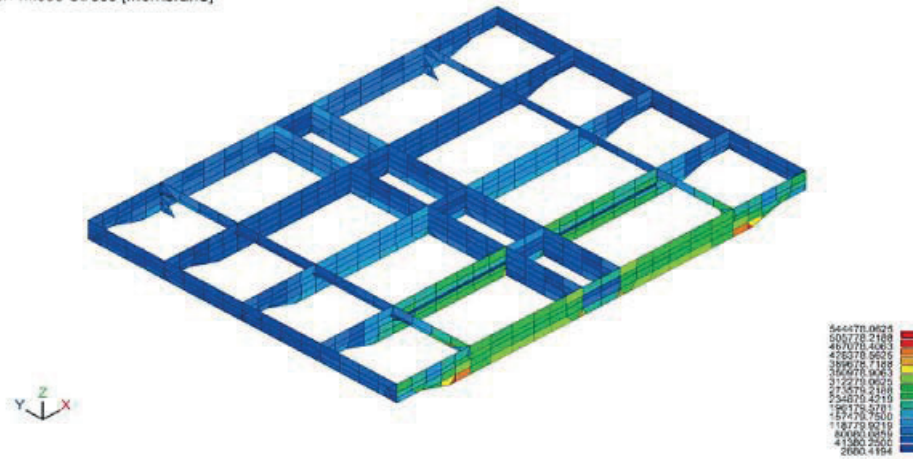
The designed height of centre of gravity (COG) of container stacks is defined as weighted mean value of the stack, where the COG of each tier is assumed to be located at the centre of each container. In terms of the position of the COG of each container, it is noted that classes may use different assumptions in container lashing calculations, e.g., at the centre of each container or one third of the height of each container. While the position at the centre of each container is adopted for the safer assumption in this UR, it should be also noted that the impact on the FE analysis due to the difference would be minimal, as can be seen from Fig. 2 and 3.



**Fig. 2 Stress distribution with COG at the centre of each container**

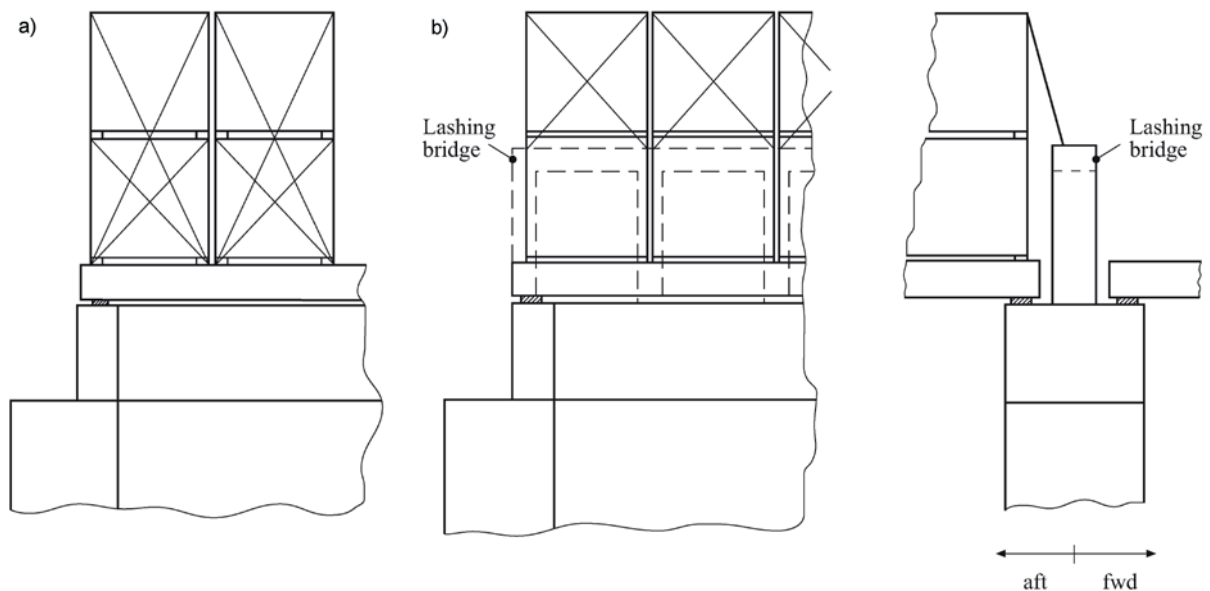


Von-Mises Stress [Membrane]



**Fig. 3 Stress distribution with COG at one third of the height of each container**

In case of container stacks secured to lashing bridges or carried in cell guides the forces acting on the hatch cover may be specially considered. Fig.4 gives an example for container secured to the hatch cover (a) and secured to a lashing bridge (b). In the latter case the forces due to the ship's roll motion are transmitted partially to the lashing bridge so that the formulas for the forces acting on the hatch cover given by UR S21a.2.3 may not be applicable. However, as the torsional stiffness of container stacks is limited, support forces at corners of 20' container stacks away from lashing bridge or cell guides, respectively, may not be influenced considerably. These support forces at half length of the hatch cover are definitive for the structural design of the cover. Thus,  $A_z$ ,  $B_z$  and  $B_y$  acting on the hatch cover at those stack corners may be assumed according to the given formulae in a conservative manner.



**Fig. 4 Container secured to the hatch cover (a) and to a lashing bridge (b)**

In general, the height of the center of gravity of the stack,  $h_m$ , needs to be taken above hatch cover top for the determination of the foot point forces  $A_z$  and  $B_z$ . However, when strength of the hatch cover structure is assessed by grillage analysis the height of the center of gravity of the stack is required to be taken above the hatch cover supports and the horizontal foot

point forces  $B_Y$  do not need to be considered. The reason for this is that the grillage model will typically be idealized at the neutral axes of the primary supporting members of the hatch cover which do not coincide with the hatch cover top, where the foot point forces act. Thus, the foot point forces are typically applied to the grillage model in locations that do not match the real locations at which the foot point forces act. This is compensated by taking the height of the center of gravity of the stack above the hatch cover supports, which are typically located closer to the neutral axes of the primary supporting members than to hatch cover top. In cases, where the hatch cover supports are located below the neutral axes of the primary supporting members of the hatch cover, this procedure is conservative. The horizontal foot point forces  $B_Y$  will not have an effect on the bending stresses in the primary supporting members as they act in the idealization plane of the grillage model and, thus, can be omitted.

The approval of the hatch cover is made for the foot point loads as given by the drawings. It should be noted that these foot point loads are not to be exceeded in any loading condition of the vessel.

#### **TB S21a.3.3.1 Load cases with partial loading (UR S21a.2.4.1)**

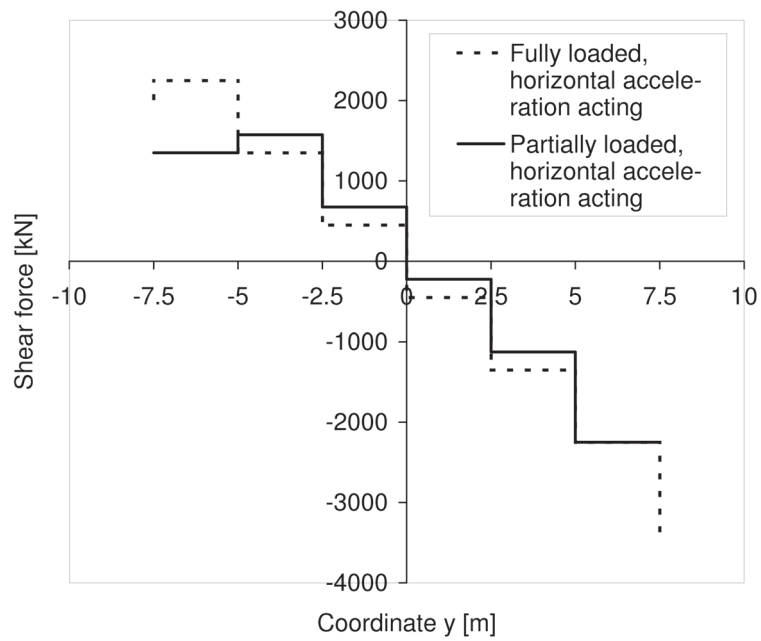
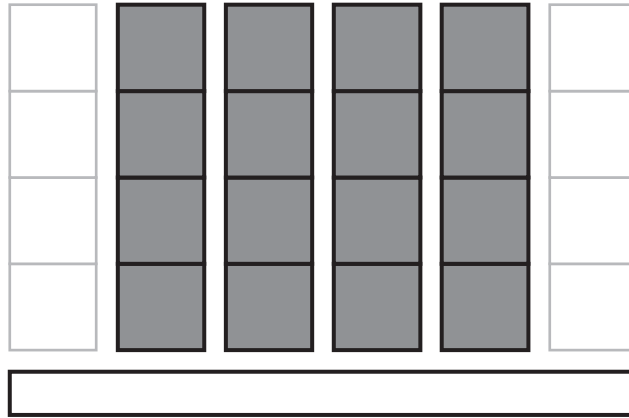
Point loads and container loads acting on the hatch cover are also to be considered for partial non homogeneous loading which may occur in practice, e.g. where specified container stack places are empty.

UR S21a gives a simplified approach for assessing the partial loading of container hatch covers where the hatch cover is loaded without the outermost stacks. It may be necessary to also consider partial load cases where more or different container stacks are left empty.

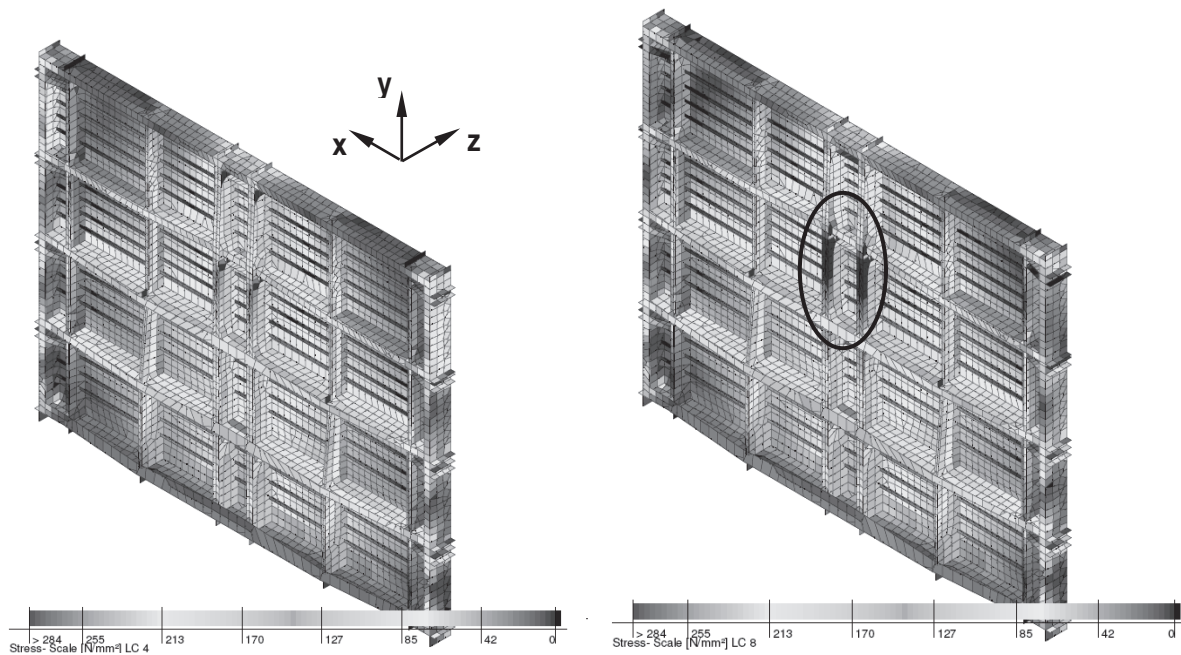
The need for these considerations arise from the occurrence of increased loads due to the unbalanced vertical support forces at the supports of container stacks next to the empty stack places caused by the ship's roll motion.

Fig. 5 schematically illustrates resulting shear force distributions in a transverse primary supporting member of a hatch cover loaded with 20' containers. Distributions are shown for the hatch cover fully loaded and for the partial load case shown in the upper part of Fig. 5 with horizontal acceleration acting. As can be seen, for the partial container load case in some areas increased shear forces occur.

For further illustration, Fig. 6 shows the equivalent stress distributions of a hatch cover loaded with stacks of 20' container and exposed to vertical and horizontal accelerations. On the left hand side, the hatch cover is fully loaded and on the right hand side the stress distribution is shown for a partial load case similar to the one shown in Fig. 5. It can be seen that increased stresses occur in the center transverse primary supporting members.



**Fig. 5 Shear forces acting in a transverse primary supporting member of a hatch cover due to different load cases**



**Fig. 6 Stress distribution in a hatch cover, fully loaded (left) and with partial loading (right)**

## **TB S21a.4 Hatch cover strength criteria (UR S21a.3)**

### **TB S21a.4.1 Permissible stresses and deflections - Stresses (UR S21a.3.1.1)**

The equivalent stress according to v. Mises is to be assessed. In general, the permissible equivalent stress is 80% of the minimum yield point of the material as required by ICLL Regulation 16 (5).

When loads other than the vertical weather design load are assessed using FEM the permissible equivalent stress is 90% of the minimum yield point of the material. This is reasonable because due to Poisson effects FEM may calculate increased stresses compared to a grillage analysis. Furthermore, this is justified by the use of FEM as a more sophisticated assessment tool. However, the increased permissible stress is only to be applied for loads other than the vertical weather design load to not contradict ICLL regulations.

Attention should be paid to stress concentration due to structural discontinuities, e.g,

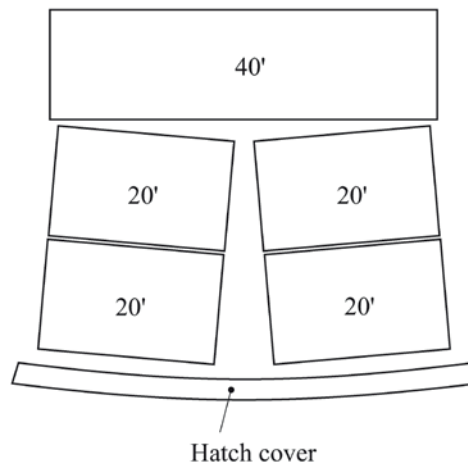
- knuckle points of face plates of primary supporting members, where the web height is changing
- connections between face plates of longitudinal and transverse primary supporting members, the web heights of which are the same.

The classification society may require further verifications of stress concentrations.

### **TB S21a.4.2 Permissible stresses and deflections - Deflection (UR S21a.3.1.2)**

The deflection limit as given by ICLL Regulation 16 (5) is included for the vertical weather design load case.

Where hatch covers are arranged for carrying containers and mixed stowage is allowed, i.e., a 40'-container stowed on top of two 20'-containers, particular attention should be paid to the deflections of hatch covers. Fig. 7 gives an example for a mixed stowage situation and the resulting hatch cover and container stack deflection.



**Fig. 7 Example for mixed stowage and resulting hatch cover and container stack deflection**

#### **TB S21a.4.3 Local net plate thickness (UR S21a.3.2)**

The requirement for the minimum net plate thickness of hatch cover top plating subjected to the vertical weather design load is the same as used in UR S21.

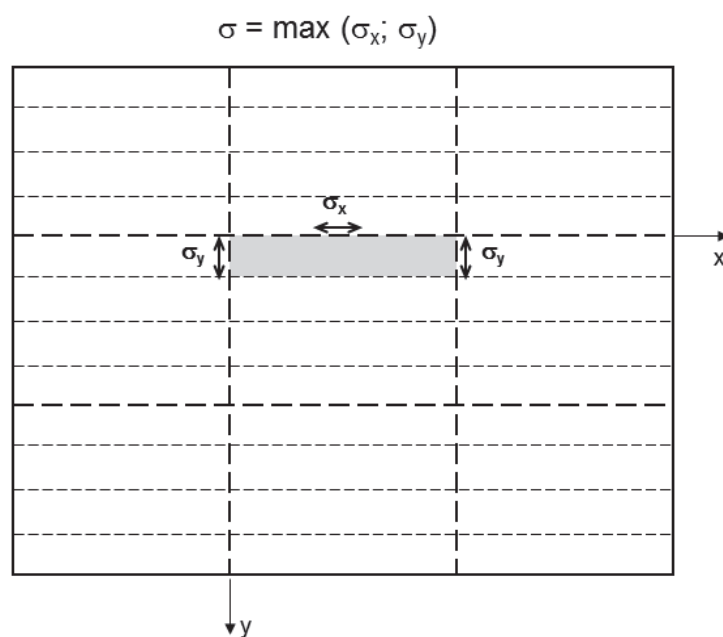
The coefficient 15,8 used in the expression applies for plates under pressure with clamped edges that are free to pull in and with plastic hinges at the edges and at mid-span.

An additional factor  $F_p \geq 1,5$  is introduced to account for co-existing compressive membrane stress in the hatch cover top plate as well as the possibility that the lateral pressure loading may locally exceed the assumed value. Factor  $F_p$  is increased linearly to 1,90 for the attached plate flange of primary supporting members stressed above 80% of the allowable stress limit.

The normal stress of the hatch cover plating is to be determined at all adjacent primary supporting members, parallel and perpendicular to the secondary stiffeners as indicated in Fig. 8.

The greatest of those stresses is to be taken for the normal stress of the hatch cover plating in the requirement for the local net plate thickness. For FE-models using plane stress or shell elements, it is sufficient to read out the stress from the centre of elements adjacent to the webs of the primary supporting members, as long as the element size is not larger than the stiffener spacing, as required by 3.5.2. (General requirements for FEM calculations).

Special loading, e.g. from project cargo, may cause unexpected shear stress in lower plating, not considered by the load cases given in this UR. For this case, the thickness requirement of  $t=6.5s$  is to be applied to ensure sufficient buckling strength of the structure.



**Fig. 8 Determination of normal stress of hatch cover plating**

**TB S21a.4.4 Net scantling of secondary stiffeners (UR S21a.3.3)**

For secondary stiffeners, the minimum elastic section modulus is derived from the elastic bending moment at the fixed end. For vertical weather load the permissible stress as required by ICLL Regulation 16 (5) and for distributed cargo load the permissible bending stress is 90% of the minimum yield point of the material. Only the lateral pressure is considered, while the second order bending moment caused by the combined effect of stiffener deflection (by the lateral pressure load) and the membrane stress in the plate (from the bending of the primary supporting member) is disregarded.

If secondary stiffeners parallel to primary supporting members are regarded for calculating the cross sectional properties of these primary supporting members, it is to be verified that the combined stress of those stiffeners induced by the bending of primary supporting members and lateral pressures does not exceed the permissible stresses.

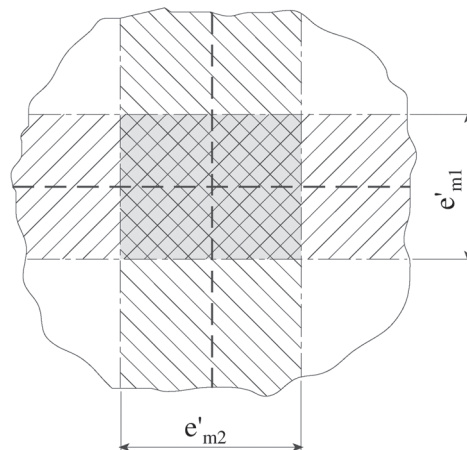
For hatch cover stiffeners under compression sufficient safety against lateral and torsional buckling is to be verified.

For flat bar secondary stiffeners, a limit on the web depth to net thickness ratio is introduced to prevent their local buckling. This requirement is adopted from UR S21.

**TB S21a.4.5 Net scantling of primary supporting members - Primary supporting members (UR S21a.3.4.1)**

For all components of primary supporting members sufficient safety against buckling must be verified. For biaxial compressed flange plates this is to be verified within the effective widths. For illustration, Fig. 9 shows a crossing of two primary supporting members with their effective widths. The area where a buckling proof must be carried out for biaxial compression is

marked in grey. The buckling proof for parts of the hatch cover plating located in this area is to be done as a combined proof for cases 1 and 2 according to Tab. 7 of UR S21a.



**Fig. 9 Crossing of two primary supporting members and their effective widths**

#### **TB S21a.4.6 Edge girders (Skirt plates) (UR S21a.3.4.2)**

For edge girders the same requirement for minimum net plate thickness is adopted as for the hatch cover top plating except for minimum thickness values that do not depend on the pressure load.

Furthermore, a stiffness requirement for edge girders similar to the requirement as given by IACS Rec. 14 is incorporated to maintain an adequate sealing pressure between securing devices.

#### **TB S21a.4.7 Strength calculations (UR S21a.3.5)**

Strength calculation for hatch covers may be carried out by either, using grillage analysis or FEM. Simple beam theory analysis shall be adopted only for hatch covers that are not designed as a grillage of longitudinal and transverse primary supporting members.

For double skin hatch covers and hatch covers with box girders, FEM is to be applied to account for shear stresses in top plating and lower plating. Grillage analysis is not able to consider these shear stresses.

##### **TB S21a.4.7.1 Strength calculations - Effective cross-sectional properties for calculation by grillage analysis (UR S21a.3.5.1)**

When determining cross-sectional properties of a primary supporting member, cross sectional areas of secondary stiffeners parallel to the primary supporting member under consideration and within the effective breadth can be included. In this case it is to be verified that the combined stress of those stiffeners induced by the bending of primary supporting members and lateral pressures does not exceed the permissible stresses.

Special calculations may be required for determining the effective breadth of one-sided or non-symmetrical flanges. This can be done by special engineering formulas or, if available, according to the individual class society's rules. In more complex cases an FEM calculation is recommended.



The cross-sectional area of flange plates under compression may be reduced by buckling of the plating. Flange plates with secondary stiffeners perpendicular to the web of primary supporting members are in particular prone to buckling failure. Thus, the effective width is to be considered for the determination of cross-sectional properties of such primary supporting members for grillage analysis or beam theory calculations. However, the effective width of plating is not to be taken greater than the value obtained for the effective breadth.

#### **TB S21a.4.8 Buckling strength of hatch cover structures (UR S21a.3.6)**

For further information regarding the buckling strength criteria refer to the technical background documents of Common Structural Rules for Bulk Carrier (CSR/BC), Chapter 6 – Hull Scantlings, Section 3 – Buckling & Ultimate Strength of Ordinary Stiffeners and Stiffened Panels.

Safety factors for the buckling strength assessment are based on the net scantling approach. To be in compliance with ICLL Regulation 16 (5) the safety factor for assessing the hatch cover when subjected to the vertical weather design load is to be taken equal to 1,25. For loads other than the vertical weather design load, a safety factor equal to 1,1 is to be applied. This is justified by the more sophisticated buckling strength approach compared to the approach in UR S21. The chosen safety factor of 1,1 matches that of CSR/BC to be used with this kind of buckling strength approach.

The given correction factors  $F_1$  for boundary conditions at the longitudinal stiffeners correspond to the values given by CSR/BC.

For buckling strength assessment of the hatch coaming vertical plate and coaming stays, vertical and horizontal forces transmitted from the hatch cover should be considered.

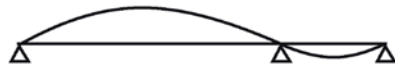
##### **TB S21a.4.8.1 Buckling strength of hatch cover structures - Proof of partial and total fields of hatch covers - Lateral buckling of secondary stiffeners (UR S21a.3.6.3.3)**

The factor  $c_s$  accounts for the boundary conditions of transverse secondary stiffeners. It is to be 1,0 for simply supported and 2,0 for partially constraint stiffeners. Fig.10 gives examples for the factor  $c_s$ . For a stiffener, the supports of which are equally spaced, a factor  $c_s = 1,0$  is to be chosen (a). If the stiffener spacing changes from a wide spacing to a much more narrow spacing, a partial constraint exists and  $c_s = 2,0$  is to be chosen (b). Also when brackets are fitted at the supports of the stiffener, it is to be assumed as partially constraint.





a)  $c_s = 1,0$  for simply supported stiffeners



b)  $c_s = 2,0$  for partially constraint stiffeners

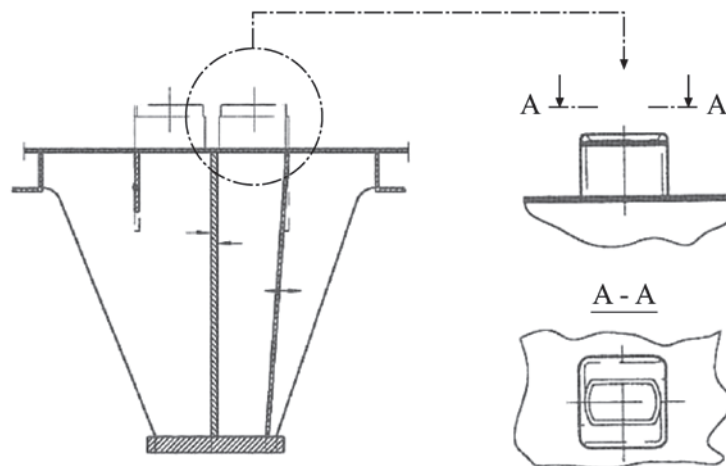
**Fig. 10 Examples for the factor  $c_s$  accounting for the boundary conditions of transverse secondary stiffeners**

### **TB S21a.5 Details of hatch covers (UR S21a.4)**

#### **TB S21a.5.1 Container foundations on hatch covers (UR S21a.4.1)**

UR S21a requires designing substructures of container foundations for cargo and container loads applying the given permissible stresses.

Substructures are required to effectively distribute the localized support forces at the container stack corners. An example for container foundations and their substructures is given in Fig.11. The figure shows a section through a primary supporting member with supporting structural elements like brackets beneath two container foundations. The detail drawing shows a typical container foundation more closely.



**Fig. 3 Example for container foundations and their substructures**

#### **TB S21a.5.2 Weather tightness (UR S21a.4.2)**

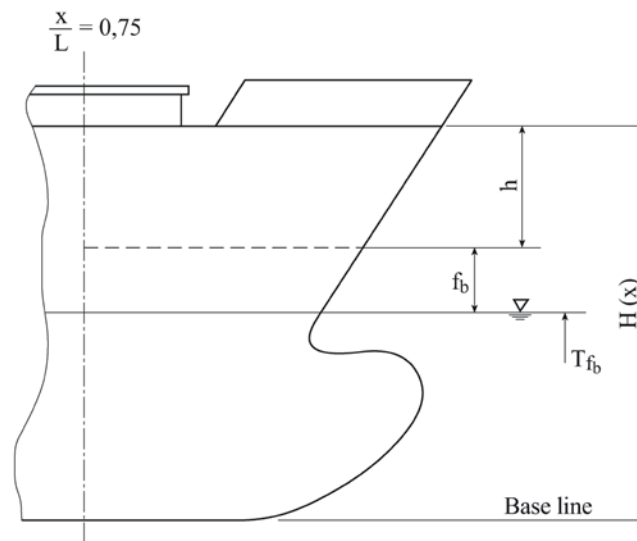
Further to the requirements as given by UR S21a the contents of IACS Rec. 14 are to be observed.

### **TB S21a.5.2.1 Weather tightness - Dispensation of weather tight gaskets (UR S21a.4.2.2)**

For hatch covers of cargo holds solely for the transport of containers, the fitting of weather tight gaskets may be dispensed with upon request by the owners and subject to compliance with the given conditions that correspond to UI LL64.

Among others, it is to be complied with the condition that the exposed deck on which the hatch covers are located is situated above a depth  $H(x)$ .  $H(x)$  is measured from the base line. The definition of  $H(x)$  is illustrated by Fig.12 for a position forward of  $x/L = 0,75$ .

Further to the requirements as given by UR S21a, Chapter 3 of IMO MSC/Circ. 1087 is to be referred to concerning the stowage and segregation of containers containing dangerous goods.



**Fig. 4 Definition of  $H(x)$**

### **TB S21a.6 Hatch coaming strength criteria (UR S21a.5)**

#### **TB S21a.6.1 Local net plate thickness of coamings (UR S21a.5.1)**

The horizontal weather design load model was adopted from UR S3. Thus, the prescriptive local net plate thickness of hatch coamings corresponds to that given in UR S3. The plate thickness required by UR S3 was assumed as a net plate thickness for UR S21a. Additionally, a minimum net plate thickness depending on the ship length was added which is not given by UR S3. Longitudinal strength aspects are to be observed as the given plate thickness formula merely covers local pressure loads.

#### **TB S21a.6.2 Net scantlings of secondary stiffeners of coamings (UR S21a.5.3)**

Similar to the prescriptive local net plate thickness, the prescriptive net scantlings for secondary stiffeners of hatch coamings correspond to those given in UR S3. Again, the stiffener section modulus required by UR S3 was assumed as a net section modulus for UR S21a. In addition, a minimum net cross sectional area of secondary stiffeners is required. The latter is based on the elastic shear force of a continuous beam under a uniformly distributed load.

### TB S21a.6.3 Coaming stays (UR S21a.5.3)

Coaming stays in general are to be designed for the loads transmitted through them and permissible stresses as defined for hatch cover structures.

For stays of coamings described in Fig. 9 Examples 1 and 2 of UR S21a and subjected to the horizontal design weather load, a prescriptive minimum section modulus and web thickness of the stay at the root point are given equal to the requirements of UR S21. Formulae were derived for the elastic shear force and bending moment appropriate to a cantilever under a uniformly distributed pressure. For coaming stays described in Fig. 9 Examples 3 and 4 of UR S21a or others, prescriptive scantlings have not been formulated as a simple cantilever design cannot be assumed.

For coaming stays, which transfer friction forces at hatch cover supports, fatigue strength is to be considered according to individual class society's rules.

As a guidance, the following load spectrum (as shown in Fig. 13) is given:

$$\log N = \log N_{max} \left[ 1 - \left( \frac{\Delta\sigma}{\Delta\sigma_{max}} \right)^h \right]$$

where

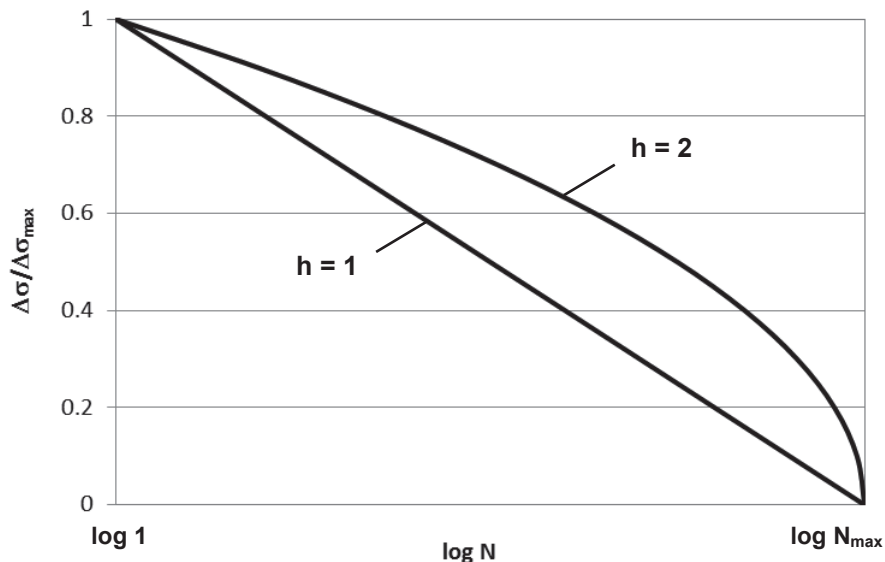
$N$  = cumulative frequency (number of cycles)

$N_{max}$  = maximum number of cycles

$\Delta\sigma$  = stress range

$\Delta\sigma_{max}$  = maximum stress range in spectrum

$h$  = shape parameter



**Fig. 13 Stress range spectra**

The maximum stress range  $\Delta\sigma_{max}$  is to be calculated using  $2P_h$  as load range. For hatch cover supports and supporting structures as well as coaming stays the following shape factors should be applied:

- $h = 1$  for non-metallic, frictionless material on steel contact
- $h = 2$  for steel on steel contact

The maximum number of cycles may be taken equal to  $N_{\max} = 5.0 \cdot 10^7$  for a design lifetime of 20 years. For design lifetime of 30 years the maximum number of cycles may be  $N_{\max} = 7.5 \cdot 10^7$ . For intermediate lifetimes  $N_{\max}$  should be interpolated.

## **TB S21a.7 Closing arrangements (UR S21a.6)**

### **TB S21a.7.1 Securing devices - Cross-sectional area of the securing devices (UR S21a.6.1.4)**

The requirements, UR S21a gives for the minimum cross-sectional area of securing devices used to maintain an adequate sealing pressure, correspond to the requirement as given by IACS Rec. 14.

For small hatch covers where the packing line pressure needs to be maintained by securing devices, typically rod type securing devices are used. For this type of securing device the given minimum cross-sectional area is applicable.

For large hatch covers securing devices may not be necessary to maintain packing line pressure as the covers are heavy enough. Securing devices then may be needed only as anti-lifting devices. These often exhibit designs which can not be sufficiently assessed only by a required cross-sectional area. They are to be designed according to the requirements for anti-lifting devices (UR S21a.6.1.5).

Where securing devices of special design are used to maintain the packing line pressure and in which significant bending or shear stresses occur, these may be designed as anti-lifting devices. As load the packing line pressure multiplied by the spacing between securing devices is to be applied.

### **TB S21a.7.2 Securing devices - Anti lifting devices (UR S21a.6.1.5)**

For the omission of the anti lifting devices, Chapter 5.6 of IACS Rec. 14 should be referred to.

Alternatively to the proof of the absence of hatch cover lifting, imposed as a condition by Rec. 14, anti-lifting devices may be omitted for ships

- equipped with lashing bridges or similar, which properly limit lifting forces, and
- fulfilling the requirements according to 4.2.2 for non-weather-tight hatch covers.

In case of lashing bridges available, attention should be paid to the hatch cover loadings with stacks having a low number of tiers that cannot be lashed to the lashing bridges. It should be proven that hatch cover lifting does not occur under loads arising from the ship's rolling motion. Furthermore, the provisions of Chapter 5.6 of IACS Rec. 14 with respect to the effective height of transverse cover guides should to be observed.

## **TB S21a.8 Corrosion addition and steel renewal (UR S21a.7)**

The requirements for corrosion additions of hatch cover structures are consistent with UI LL70. The requirements for corrosion additions of hatch coamings are consistent with UR S21.

The requirements for steel renewal of hatch cover and coaming structures are consistent with the requirements as given by UR S21. For coaming structures, the corrosion additions  $t_s$  of which are not provided in Tab. 10 of UR S21a, steel renewal requirements are to be according to the individual class society's rules.

Report No: UR S21A 2/2.4/2.4.4	Revision No. & Date: Rev.0 Feb. 2015	Status of Report: <input checked="" type="radio"/> Final
Report Title: Investigation of Partial Load Cases for Each Heel Direction		Rules Reference: Rev.1 XXX. 2015 version
		Distribution by IACS <input type="radio"/> External <input checked="" type="radio"/> Internal
Project Teams: PT PH 31/2013		Approved for Issue by: <input checked="" type="checkbox"/> HP Technical review
Reporting Organisation Name & Address: IACS 36 Broadway London SW1H 0BH		No. of Pages:9
<p>Summary:</p> <p>Partial load cases could occur when at least one stack place remains empty on a hatch cover.</p> <p>While the partial load cases are specified in draft revised UR S21A Tab. 3, it is not clear whether these cases could cover both possible heel directions, as the assessment of only one heel direction is documented by the existing background report on partial load cases.</p> <p>FE analysis was performed with a variety of partial load cases and showed that the load cases in Tab. 3 could cover possible partial load cases sufficiently.</p>		
Revision History:		

## Content

1 Introduction.....	3
2 Analysis.....	3
3 Conclusions.....	8
APPENDIX.....	9

## 1 Introduction

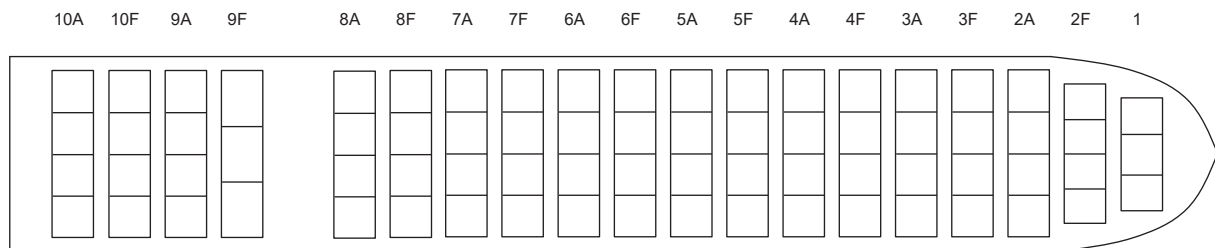
The aim of this investigation is to check the impact that the partial load cases have on hatch cover structures. FE analysis is performed under various partial load cases in each heel direction in order to investigate which load cases are severer.

The purpose of this document is to confirm whether partial load cases defined in Tab.3 in UR S21A (see APPENDIX) are appropriate for both possible heel directions, as the assessment of only one heel direction is documented by the existing background report on partial load cases.

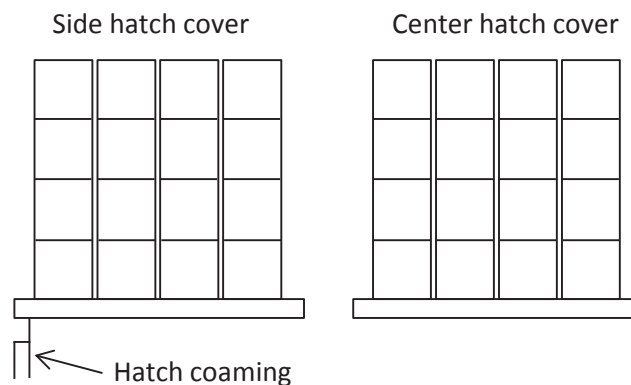
## 2 Analysis

### 2.1 Subject ship and hatch cover

Subject ship is an 8,000TEU container ship. The subject hatch cover is in mid-ship area. In this report, the center and side hatch covers are considered.



**Fig.1 Hatch cover arrangement**



**Fig.2 Subject hatch covers**

Having in mind that the aim of this report is not to investigate the scantling impact but to examine which partial load cases are critical to hatch cover structures, the FE



model of the center hatch cover is used for both center and side hatch covers under different boundary conditions.

## 2.2 Load cases

Ten load cases shown in Fig. 3 are considered for each hatch cover. Heel direction is right in cases 1 to 5 and left in cases 6 to 10. In all cases, only 20 feet containers are considered because the load from 40 feet containers are fully supported by the hatch end coamings and, therefore, is not critical to the required scantling of the girder system (see Fig.4).

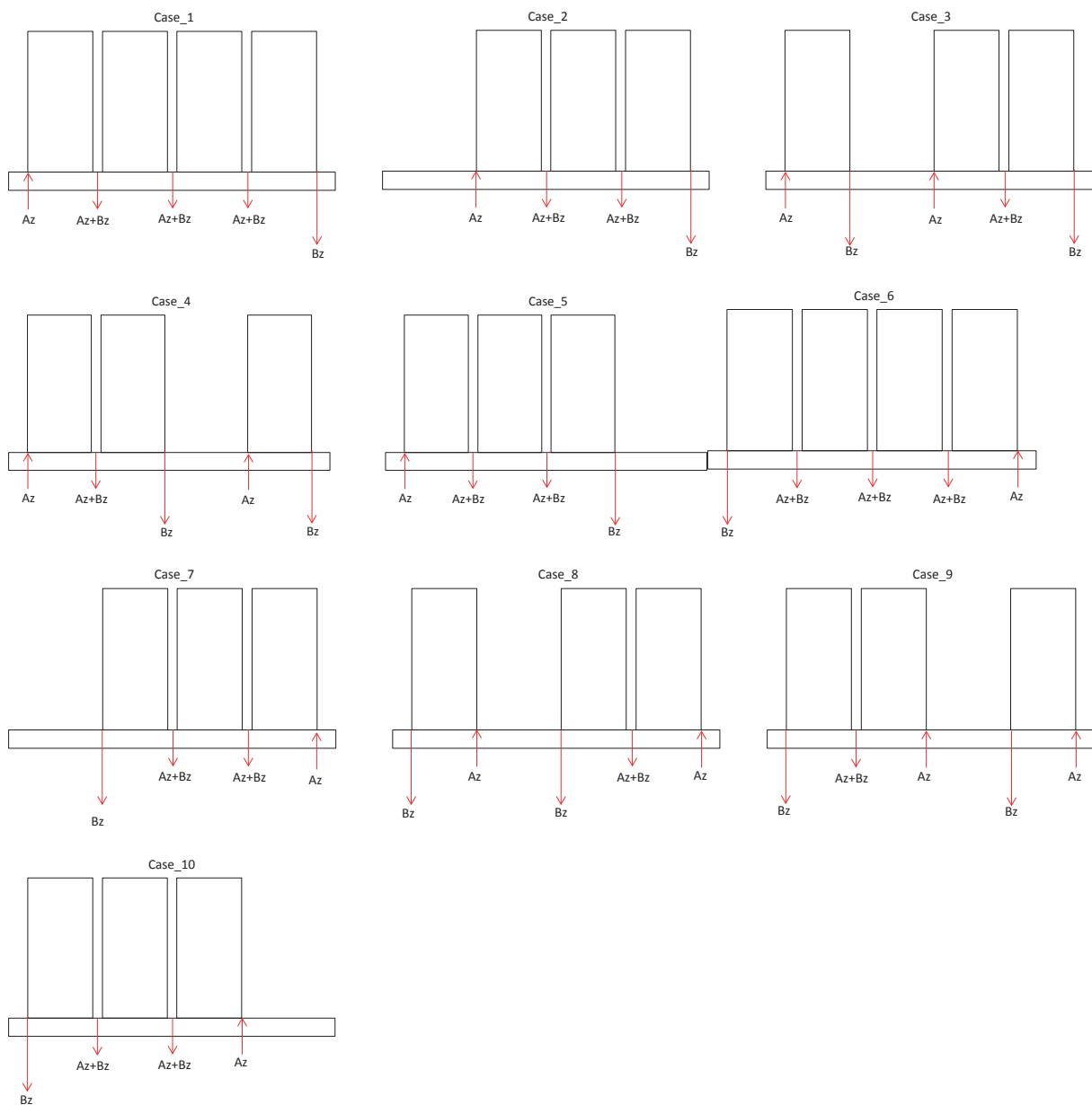
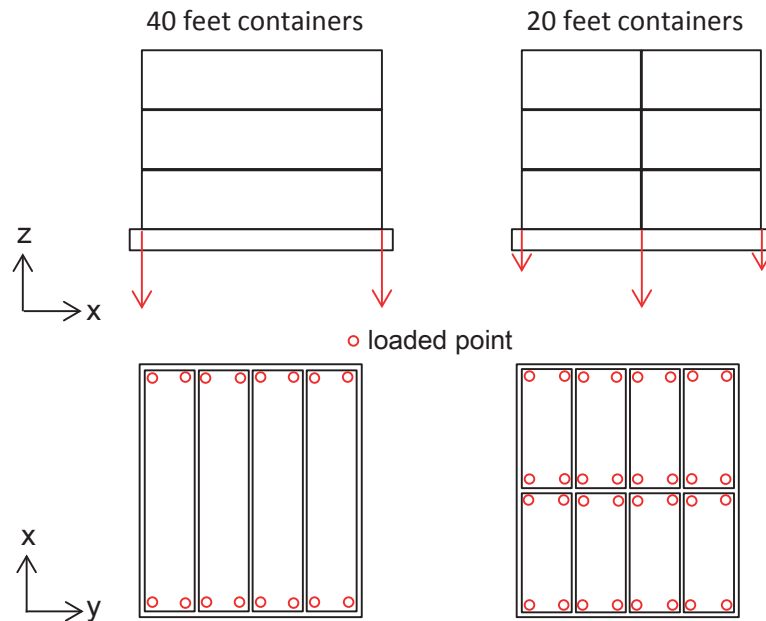


Fig.3 Load cases



**Fig.4 Loaded points of 40 feet containers and 20 feet containers**

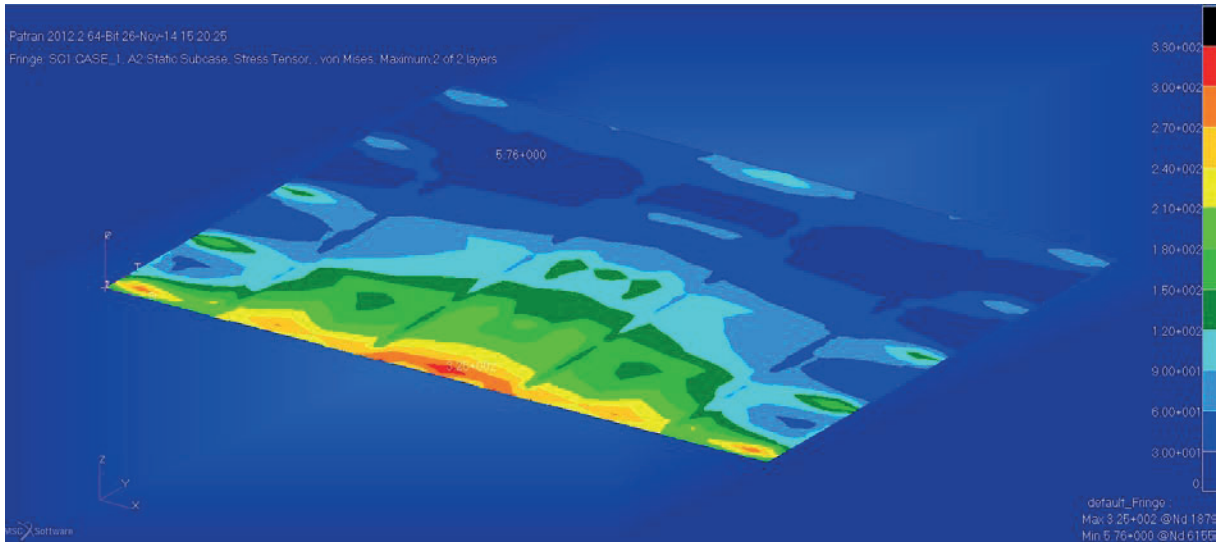
The design container loads, “ $A_z$ ” and “ $B_z$ ”, are calculated according to S21A 2.4. The loads and other parameters are show in Table 1.

**Table 1**

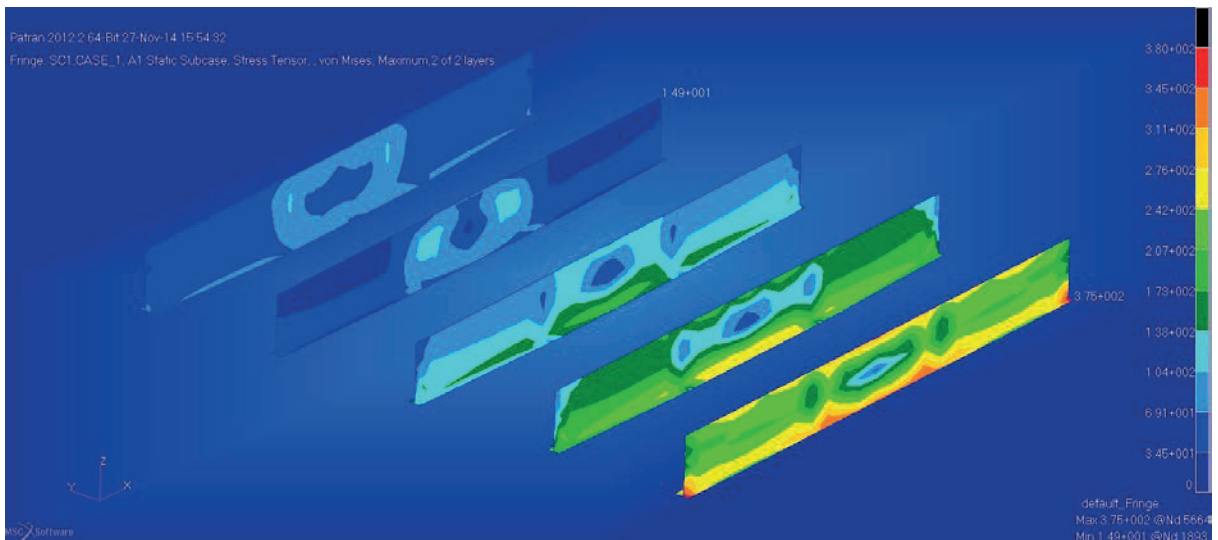
L (m)	323.3
$V_0$ (Knots)	27.7
$x / L$	0.5
$a_v$ ( $m/s^2$ )	0.17
hm (m)	6.9
Stack mass (ton)	90
b (m)	2.26
$A_z$ (kN)	435.6
$B_z$ (kN)	900.2

## 2.3 Analysis results

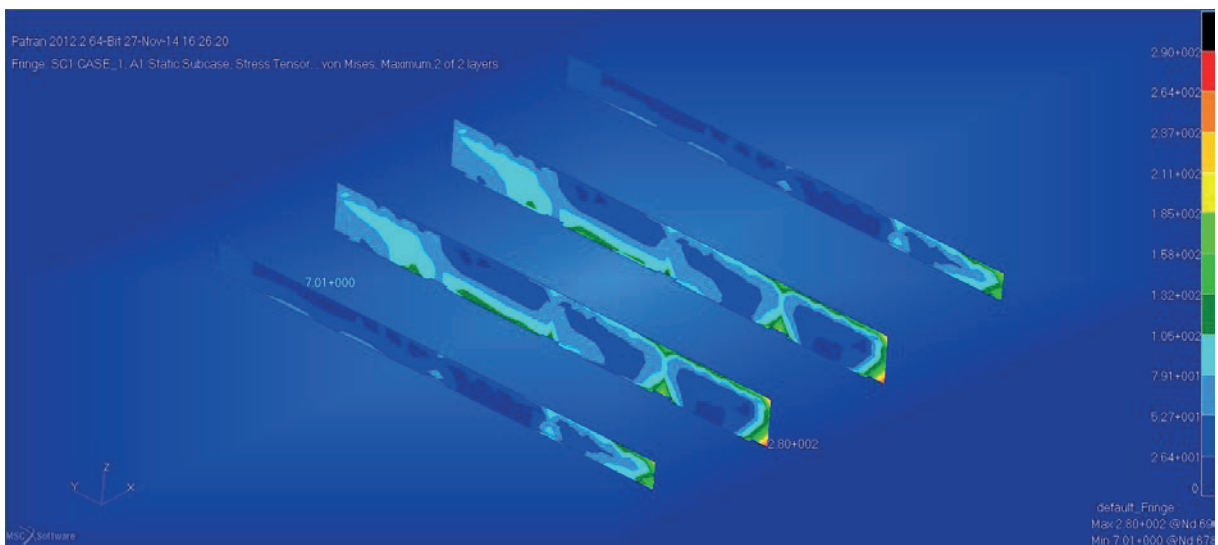
Stress in way of the fixed nodes (as boundary conditions) are excluded in this report. Examples of equivalent stress distribution are shown in Figs. 5 to 10. Maximum equivalent stress of top plate, girders and transverse webs are show in Table 2. The analysis results show that load cases 1, 5, 6 and 7 are predominant for the strength of hatch cover structures. Load cases 5 and 7 are the same load cases specified in Tab.3 of S21A. Thus, partial load cases defined in Tab.3 of S21A are appropriate to decide the scantling of hatch cover structures.



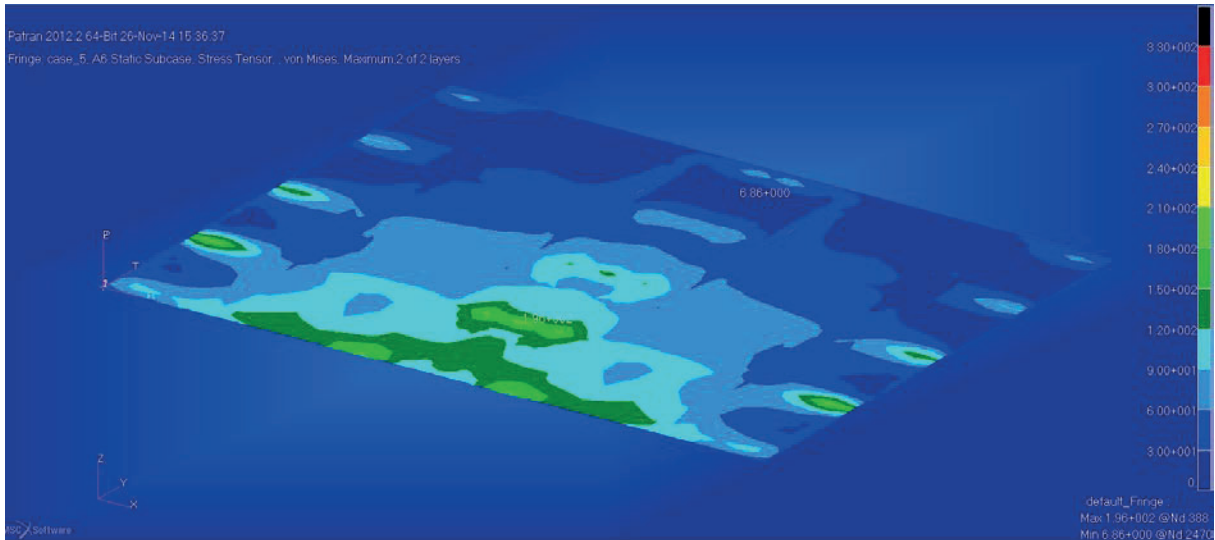
**Fig.5 Stress distribution at top plate (center hatch cover: case 1)**



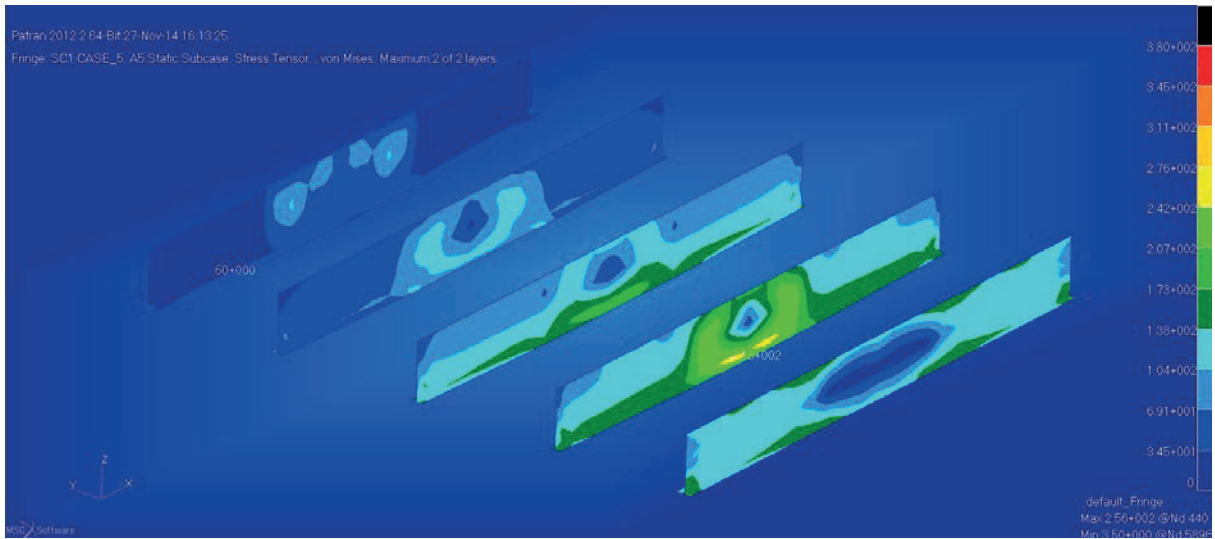
**Fig.6 Stress distribution at girders (center hatch cover: case 1)**



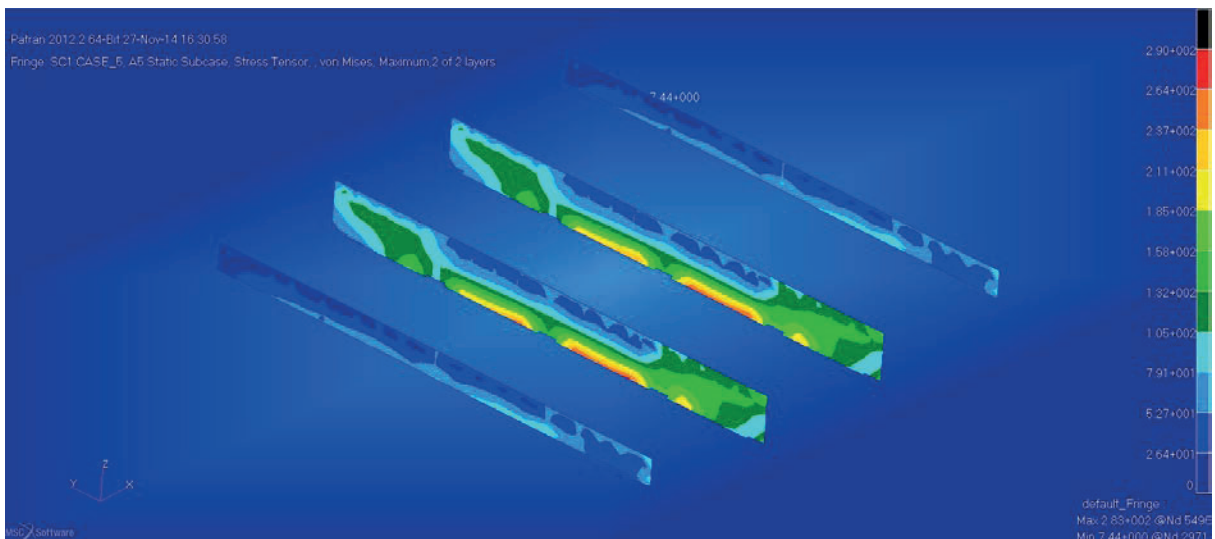
**Fig.7 Stress distribution at transverse webs (center hatch cover: case 1)**



**Fig.8 Stress distribution at top plate (center hatch cover: case 5)**



**Fig.9 Stress distribution at girders (center hatch cover: case 5)**



**Fig.10 Stress distribution at transverse webs (center hatch cover: case 5)**

**Table 2 Maximum stresses in each load case (unit: MPa)**

		Center hatch cover			Side hatch cover		
		Top plate	Girder	Trans web	Top plate	Girder	Trans web
Heel right	Case 1	325	375	280	311	362	271
	Case 2	309	361	268	292	346	258
	Case 3	284	326	243	273	316	236
	Case 4	256	260	225	247	255	200
	Case 5	196	256	283	196	255	270
Heel left	Case 6	326	375	280	146	234	296
	Case 7	198	256	283	150	238	375
	Case 8	257	262	225	145	228	326
	Case 9	285	326	243	141	229	208
	Case 10	310	361	268	143	230	222

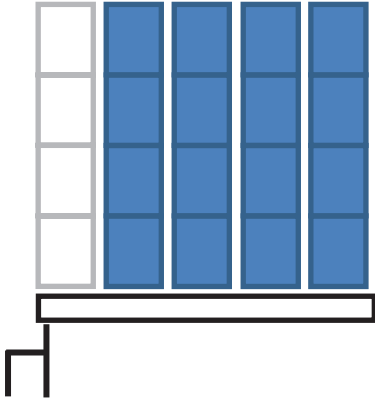
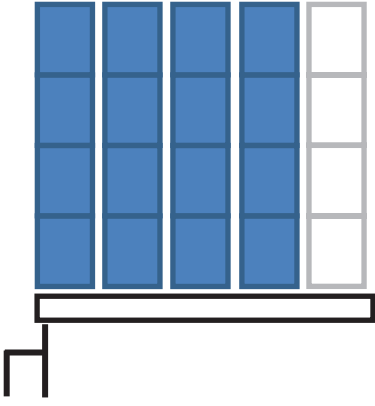
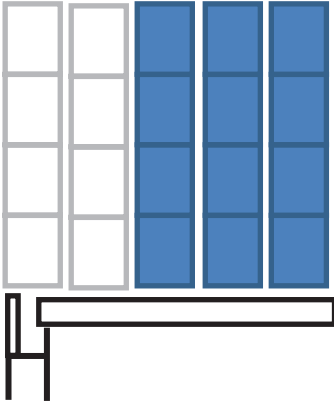
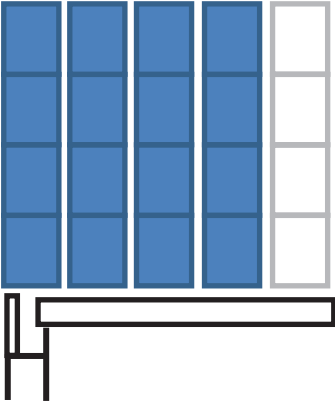
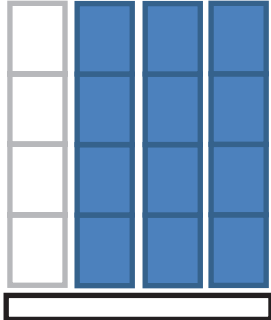
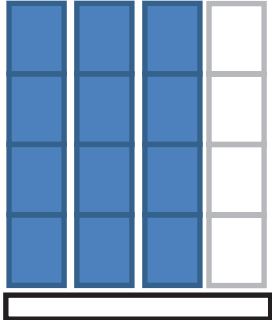
### 3 Conclusion

FE analysis was carried out under various partial load cases. From the FE analysis results, it is clear that partial load cases defined in Tab.3 of S21A are proper load cases to decide the strength of hatch cover structures.

## APPENDIX

Tab. 3 of DRAFT revised UR S21A.

Tab. 1 Partial loading of container hatch covers

Heel direction	←	→
Hatch covers supported by the longitudinal hatch coaming with all container stacks located completely on the hatch cover		
Hatch covers supported by the longitudinal hatch coaming with the outermost container stack supported partially by the hatch cover and partially by container stanchions		
Hatch covers not supported by the longitudinal hatch coaming (center hatch covers)		

## **Technical Background (TB) document for UR S21A (Corr.1 Feb 2018)**

### **1. Scope and objectives**

Clarify the utilization of permissible nominal surface pressure values and applicability of support materials including pertinent coefficients.

### **2. Engineering background for technical basis and rationale**

The permissible nominal pressure ( $P_n$ ) may be applied also for other substructures and adjacent structures, but UR S21A 6.2.2 requirement is only applicable to supports of hatch covers and not applicable to other structures. "Supports as well as the adjacent structures and substructures are to be designed such that the permissible stresses according to 3.1.1 are not exceeded. This is relevant for the forces  $P_v$  and  $P_h$ .

Where supports are composed of various materials, the permissible nominal pressure of each material needs to be considered and the acceptance criteria is to be based on the mechanical properties of weakest material.

The limitation of the permissible pressure for steel support surfaces is related to the phenomenon of fretting and friction welding and not related to the hardness of the material.

It is to be noted that the value of  $P_n$  as indicated in UR S21A 6.2.2 Table 9 is given for "Plastic materials on steel" and not for "plastic materials" alone.

The permissible nominal surface pressures are given in Table 9 for:

- Hull structural steel
- Hardened steel
- Low friction material

The permissible nominal surface pressure value given for hull structural steel material should be used where both parts of a sliding contact support are made of this material.

The permissible nominal surface pressure value given for hardened steel material should be used where at least one part of the sliding contact support is made of this material.

The permissible nominal surface pressure value given for low friction material is applicable for a wide variety of sliding support pad systems to which the first two materials (hull structural steel or hardened steel) are not applicable. The Note in 6.2.2 allows for increased surface pressures if proof is provided that the support material can resist this pressure. In addition for support pad systems where no sliding effect occurs at the contact surface but where the relative motion is taken up by the deformation of the pad material, reference may need to be made to the support pad system manufacturer.

Sea load pressures and allowable stresses, previously based on GL1997 (ICLL 66) or now from MSC 77/26/add.1 ANNEX3 (upgraded ICLL), are defined for hatch cover structures, with no link with nominal surface pressure of the supporting material. The nominal surface pressure is an intrinsic value of the supporting material.

The table 9 of UR S21A gives default values of permissible nominal surface pressure  $P_n$ , while providing the possibility to use a higher value on a case by case basis, as permitted by the "Note" in UR S21A 6.2.2.

### **3. Source/derivation of the proposed IACS Resolution**

A hatch cover manufacturer addressed questions to IACS related to the UR S21A permissible nominal surface pressure including the meaning of the different support materials provided in table 9. The Hull Panel developed the answer to Industry questions including necessary clarifications.

### **4. Summary of Changes intended for the revised Resolution:**

The support material designation of lower friction material in table 9 for "Plastic materials on steel" has been modified to "lower friction materials" considering that many materials with lower friction coefficient are applied for hatch cover supports, not only one plastic material.

### **5. Points of discussions or possible discussions**

None.

### **6. Attachments if any**

Not applicable.



## **Technical Background to changes proposed in respect of UR's S1A, Annex 2 to S1A, S12, S17, S18, S19, S20 and S22**

The objective of the proposal is to reflect the IMO interpretation of 'single side skin construction' in the above mentioned Unified Requirements for bulk carriers. The Working Party on Strength discussions were unable to yield unanimous agreement and the following matters remain unresolved:

- The titles for UR's S17, S18, S19, S20 and S22 include the wording 'single side skin'. It was generally considered that this wording should now be deleted as the text clearly defines the scope of application and refers additionally to arrangements with double side skin construction. The GL Member does not support this view on the basis that the expression 'single side skin' appears in the text of SOLAS Chapter XII. In view of this difference, the wording 'single side skin' has been enclosed in square brackets pending further consideration by GPG.
- In order to clarify how the breadth of the side shell should be measured, the phrase 'between topside tank and hopper tank' has been used in S17.1(ii) and (iii), S18.1(ii) and (iii), S19.1(ii), S20.1(ii) and (iii), and S22(ii). This was not supported by the ABS member who considers that the IMO definition of single side skin construction does not necessarily refer only to the location between topside and hopper tanks. Also this was not supported by the CRS Member who considers that MSC 89(71), which identifies that measurements are to be made perpendicular to the side shell, provides sufficient guidance. For these reasons, the text has been enclosed in square brackets pending further consideration by GPG.

In addition to the above, two other issues have been raised as follows:

- The ABS Member has requested that the following be considered in respect of the deletion of reference to damage stability requirements from paragraph S17.1 of URS17. It is noted that the reference was originally included in order to cover a six months difference in implementation timetables between SOLAS and IACS. Although both implementation dates have now passed and the need for this provision is limited, there could still be cases where it is relevant due to a change of Class from a non-IACS Society to an IACS Society. It is, therefore, proposed that the present clause in URS17 be replaced by an alternative clause within a unified requirement more specifically related to stability requirements. Support for this proposal has been indicated by PRS, DNV, KR, RINA, CRS and LR.
- The GL Member has requested that consideration be given to amending URS20 and URS22 such that these requirements are only applicable when corrugated bulkheads are fitted. This matter has not received support from the other WP/S Members and is considered to be outside the scope of the present Task.

**Technical Background Document**  
**IACS Council – To Improve Bulk Carrier Safety**  
**UR S 23 – Proposed Rev. 3**

**Objective and Scope:**

To reflect the IACS Council decision to advance the implementation date of SOLAS XII requirements relating to existing bulk carriers from 15 years to 10 years.

This will bring forward reinforcement of the corrugated transverse bulkhead between No.1 and No.2 holds and the double bottom structure of No.1 hold, in accordance with S19 and S22.

**Source of Proposed Requirements:**

- ABS/DNV/LR put forward a set of proposed actions to improve bulk carrier safety on 5 Feb 2002 (s/n 2033).
- Council decided to revise S 23 implementation schedule in such a way as to require ships under 10 years of age, *as of 1 July 2003*, to comply by age 10, and to require ships of age 10-15 which are not already in compliance to comply at the next Intermediate or Special Survey coming due *after 3 July 2003*.

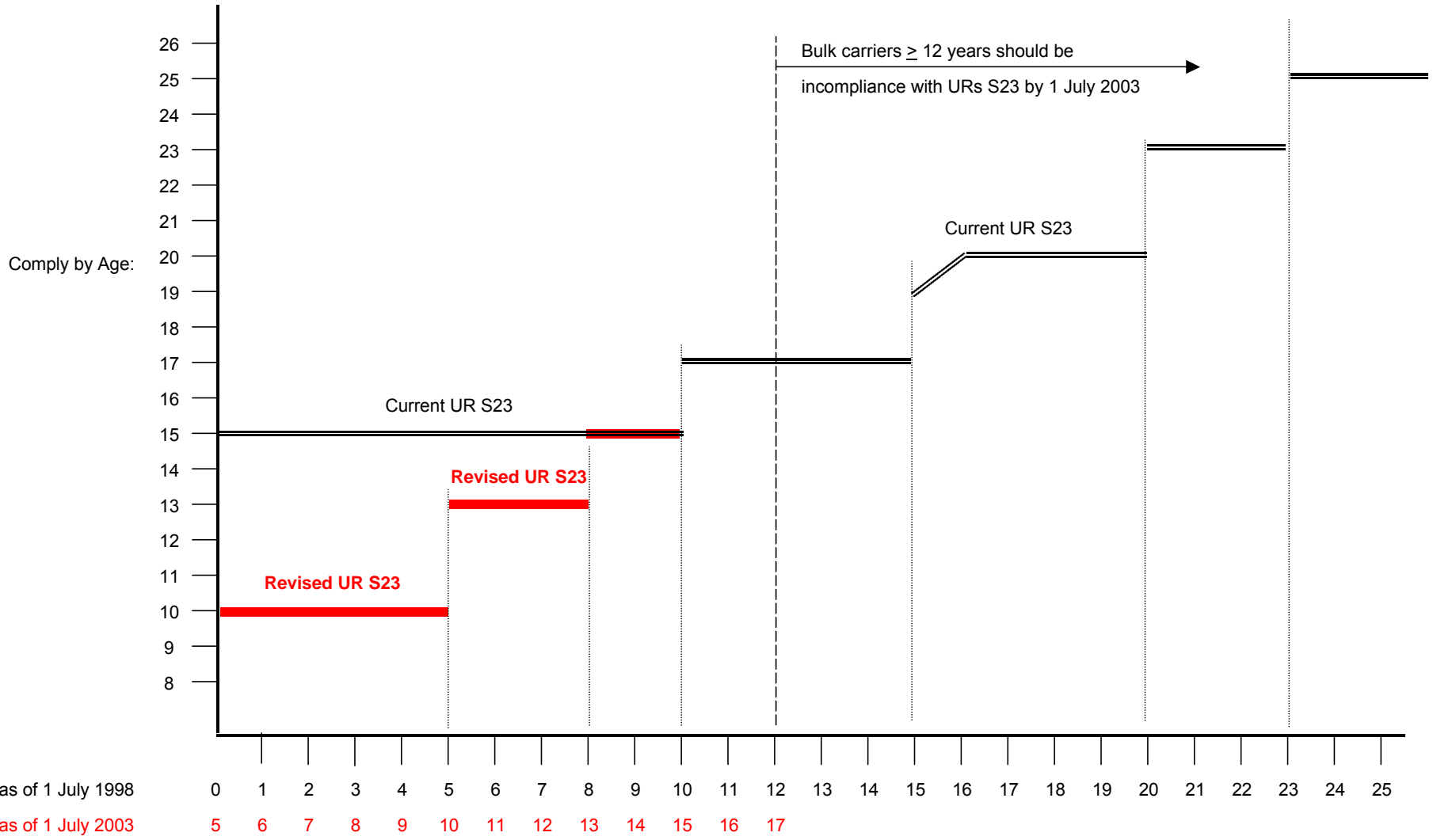
**Points of Discussion:**

- Care was taken to provide an adequate period of fair warning to allow owners of those ships that must comply first under the revised implementation schedule to plan, and the societies to perform the necessary plan review and preparation for modifications at the upcoming survey.  
S23.1.A.iv was carefully worded so that compliance is not required prior to 1 July 2003.  
(Compliance date of this new measure was changed from 1 Jan 03 to 1 July 03.)
- Completion, prior to 1 July 03, of an intermediate or special survey coming due after 1 July 03, cannot be used to postpone compliance. See S23.1.a.v.
- BV raised a question on the interpretation of “due date of intermediate survey”. In this case, the “due date” will be the last day of the 18 months intermediate survey window period.  
RINA/KR confirmed.

**Conclusion**

- Council approved the proposed draft UR S 23 on 19 March 2002.
- Council announced this revision to the public on 15 March 2002.

Date of submission: 28 Feb12002  
Permanent Secretariat



**UR S 23**  
(Rev.3.1 Nov 2002)

**Technical Background:**

1. ABS brought to the attention of GPG that the amendment undertaken by Council in pursue of its measure 1, when S23.1.b. was amended to read: "Completion, prior to 1 July 2003, of an intermediate or special survey with a due date after 1 July 2003, cannot be used to postpone compliance." introduced some interpretation when applied to intermediate survey due to the fact that intermediate survey does not have a definitive "due date". ABS' interpretation was that:

"...for the purpose of application of this requirement of UR S23, the "due date" of the intermediate survey should be understood to be the third anniversary date (and that the three months following the due date may be used to complete the survey) -- so as to require any ship with a third anniversary after 1 July 03 to comply with the requirements in conjunction with this intermediate survey regardless of whether the intermediate survey was done before that "due date" or not."

2. ABS further advised that based on reaction from owners it seemed that all other Members had a different interpretation in practice, which allowed the ship to complete the intermediate survey prior to 1 July 2003 within the window and required compliance with URs S19 and S22 at the next special survey or other controlling date.

3. Based on this ABS proposal and for consistency with other URs S31, S26 and S27, the following text was agreed:

"S23.1(b): Completion prior to 1 July 2003 of an intermediate or special survey with a due date after 1 July 2003 cannot be used to postpone compliance. However, completion prior to 1 July 2003, of an intermediate survey the window for which straddles 1 July 2003 can be accepted."

4. No change to the implementation date.

\* \* \*

# TECHNICAL BACKGROUND

## UR S23 (REV.4, AUGUST 2007)

### 1. Scope and objective

To revise UR S23 (rev.3.1) so that it can be consistent with SOLAS regulation XII/4 as amended by IMO Res. MSC.170(79).

### 2. Background

The Statutory Panel raised this issue which is regarding editorial amendments to UR S23 so that it can be consistent with SOLAS regulation XII/4 as amended by IMO Res. MSC.170(79).

As the maintenance of UR S23 is under Hull Panel responsibility, the Statutory Panel Chairman asked Hull Panel to take it onboard.

Upon the request from Statutory Panel, Hull Panel unanimously agreed to prepare and submit the draft revision to UR S23.2 to GPG for their review and approval.

After deliberations, the Hull Panel proposed to revise UR S23 (rev.3.1) so that it can be consistent with SOLAS regulation XII/4 as amended by IMO Res. MSC.170(79).

### 3. Points of discussions

The Hull Panel unanimously agreed to revised UR S23 (rev.3.1).

### 4. Source/derivation of proposed requirements

- ✓ PH7005XRSa
- ✓ SOLAS regulation XII/4 as amended by IMO Res. MSC.170(79).

### 5. Decision by voting

N.A.

Submitted by Hull Panel Chairman

19 July 2007

### Permanent Secretariat note (September 2007):

Rev. 4 approved by GPG 28 August 2007, ref. 7626\_IGb.

**Technical Background Document**  
**IACS Council – To Improve Bulk Carrier Safety**  
**UR S 24 – Proposed Rev. 1**

**Objective and Scope:**

To reflect the IACS Council decision to extend the implementation of the requirements of UR S 24 **(installation of water ingress detection and alarms) to all cargo holds on all existing ships as well as new building ships.**

**Source of Proposed Requirements:**

- ABS/DNV/LR put forward a set of proposed actions to improve bulk carrier safety on 5 Feb 2002 (s/n 2033).
- IACS Council decided to revise S 24 to achieve the above objective.

**Points of Discussion:**

- The 2m water level at which the ingress detectors shall activate detection was already provided in the existing text of S24.3.6.
- WP/MCH, in response to Council instruction, urgently reviewed the proposed revision and suggested to specify the place where the alarms are to be located.

Hence, the positions where the detectors shall be installed are specified in the revised S24.3.2

- Implementation: For new ships, from 1 Jan 2003;  
For existing ships, see S24.1.3.

**Conclusion**

- Council agreed to the proposed draft UR S 24 on 19 March 2002.
- Council announced this revision to the public on 15 March 2002.

Date of submission: 28 Feb12002  
Permanent Secretariat

## UR S25 “Harmonised Notations and Corresponding Design Loading Conditions for Bulk Carriers”

### Part A. Revision History

Version no.	Approval date	Implementation date when applicable
DELETE (May 2010)	24 May 2010	-
Rev.2 (July 2004)	5 July 2004	-
Corr.1 (May 2004)	14 May 2004	
Rev.1 (Feb 2003)	12 February 2003	-
NEW (June 2002)	19 June 2002	1 July 2003

- **DELETE (May 2010)**

**.1 Origin for Change:**

- Based on IACS Requirement (*Common Structural Rules for Bulk Carriers and Double Hull Oil Tankers*)

**.2 Main Reason for Change:**

Following the introduction of the IACS Common Structural Rules for Bulk Carriers and Double Hull Oil Tankers, Hull Panel were tasked to review all the UR S files to consider whether or not they are applicable to ships covered by the CSR.

**.3 List of non-IACS Member classification societies contributing through the TC Forum and/or participating in IACS Working Group:**

None.

**.4 History of Decisions Made:**

After review it was decided that as UR S25 is currently only applicable for CSR bulk carriers and since the requirements are replaced by those of the Common Structural Rules, UR S25 may be withdrawn.

**.5 Other Resolutions Changes**

All UR S files, except UR S8, S9, S15, S16, S19, S22, S23, S30 and S31.

**.6 Dates:**

Original proposal: 2007, made by Hull Panel Task 50  
 Panel submission to GPG: 19 April 2010  
 GPG Approval: 24 May 2010 (Ref. 10051\_IGd)

- **Rev.2 (July 2004)**

Addition of 'Contracted for Construction' footnote – no TB document available.

- **Corr.1 (May 2004)**

Correction to S25.4.4.1 (a) i and 4.4.1 (b) in order to correctly refer to the provisions of S11.2.1.3 – no TB document available.

- **Rev.1 (Feb 2003)**

See TB document in Part B.

- **NEW (June 2002)**

See TB document in Part B.



## Part B. Technical Background

List of Technical Background (TB) documents for UR S25:

Annex 1. **TB for Original Resolution (June 2002)**

See separate TB document in Annex 1.



Annex 2. **TB for Rev.1 (Feb 2003)**

See separate TB document in Annex 2.



**Note:** *There are no separate Technical Background (TB) documents for Corr.1 (May 2004), Rev.2 (July 2004) and Delete (May 2010).*

**UR S 25 - Technical Background (TB) Documents****1 Summary**

The proposal covers 2 parts:

- (1) To assign standard notations to new ships intended to carry dry cargoes in bulk
- (2) Each standard to be based on a minimum set of design loading conditions including some optional ones

**2 Suggested contents of Technical background (TB)****2.1 Scope and objectives**

The assigned classes BC-A, BC-B, BC-C will create increased transparency in the shipping market, in a way similar to that already existing as regards Ice Class A, B or C or Chemical Tankers Type I, II or III, thus ensuring that bulk carriers are ordered, chartered and/or sold with adequate understanding of the type of ship and operational limitations involved. Bulk carriers categorized as BC-A are to be considered to have high flexibility in cargo loading, unloading, and carriage including Multiple Port loading as standard. Bulk carriers categorized BC-B has no density restriction of the cargo intended to carry but have some restrictions in cargo distribution on board. Bulk carriers categorized as BC-C are designed for the carriage of low density cargoes only.

The proposed draft resolution is not intended to prevent any other loading conditions to be included in the loading manual for which calculations are to be submitted as required by the relevant UR, nor is it intended to replace in any way the required loading manual/instrument.

A bulk carrier may in actual operation be loaded differently from the design loading conditions specified in the loading manual, provided limitations for longitudinal and local strength as defined in the loading manual and loading instrument onboard are not exceeded.

**2.2 Points of discussions or possible discussions****(General)**

- .1 The intentions with the minimum design loading conditions proposed is not to define all the actual loading conditions that bulk carriers will encounter during their operational lives, but to ensure that those are designed and constructed with a strength envelope which is sufficiently wide to allow them to perform most of the transportation services that will be required during their lifetime.
- .2 The owner may specify design loading conditions in addition to the minimum required, in that case such design loading conditions shall be included in a standardized summary table on the first page in the loading manual actually prepared for on board operation of the ship.
- .3 During actual operation ships are to be loaded within the limits of conditions and restrictions stated in the loading manual.

**(Title)**

There was a discussion whether "class notation" or simple "notation" is to be used. It was noted that "class notation" is not defined and could vary from one society to another. For example, "class notations" may require action by governance bodies but simple "notation" does not. In this view, BC-A (B, C) would be a class notation but other portions relative to empty hold combinations and cargo densities may not. By deleting "class" it is intended to cover both "notation" and "class notation" without narrowing down the extent of UR. Further, for some classification societies, class notations need be in a limited size of a field which accommodate all notes shown in ( ).

**(Application)**

It was intention of the Committee that classification and statutory requirements such as longitudinal strength, local strength and stability criteria applicable for the design loading conditions listed under Sections 4 and 5 are not the integral part of this new URs, whilst these requirements are to be complied with according to respective statutory and class requirements.

**(Maximum cargo density)**

In case where a bulk cargo of which density is more than 3.0 tonnes/m<sup>3</sup>, BC-B and BC-A bulk carriers are allowed to carry such a cargo without giving annotations to such loading condition subject to compliance with strength requirements in Rules and Regulations of each Society and necessary description in the loading manual.

**(Design ballast condition/ballast tank capacity)**

This condition is needed to define the design ballast condition where strength of the bottom forward is assured against slamming. In achieving this condition, use of cargo hold adapted for carrying ballast water is excluded. Further, reflecting current practice, a need to obtain deeper draught where a ballast hold, if any, is utilized, is provided.

**2.3 Source/derivation of proposed requirements**

UR S1A is taken into consideration in developing this standard.

**Technical Background Document**  
**General Policy Group**  
**Refinement of UR S 25 (Rev.1, Feb 2003)**

**Objective and Scope:**

To refine UR S25

- 1) to provide sufficient ballast capacity for the heavy ballast condition
- 2) to allow appropriate flexibility in the design of capacity and disposition of ballast tanks, and
- 3) to eliminate the unnecessary complexity and confusion without changing the intent.
- 4) to achieve common understanding of para. 4.4.2(b) – longitudinal strength checks when more than 1 hold is capable of being used for ballast at sea (GPG 53 FUA 27)
- 5) To achieve common understanding of the application of the design conditions of Section 4 with respect to the applicable rules criteria for longitudinal strength (footnote 1 to S25.2.3).

**Points of Discussion:**

- 1) ABS put forward a set of proposals on 22 July 2002:
  - pending completion of the suggested task (ABd, item 1b), to require a ballast hold for larger bulk carriers so as to retain the current design practice. (4.4.1(b)),
  - to confine the BWTs 100% full requirement to strength check purposes (new 4.4.2),
  - to separate BWT capacity/disposition requirement (new 4.4.1) from strength requirement (new 4.4.2) so as to allow more flexibility in designing the capacity and disposition of BWTs,
  - to specify that the length for use with the trim requirement is to be LBP (4.4.1), and
  - the departure condition bunker capacity is to agree with the accepted marine practice (4.5).
- 2) Members' reactions to the ABS proposals are summarized in the attached Table "[S25Rev\_cmt\_summary]".
- 3) In summary, ABS proposal, with further refinements based on member's comments, was generally accepted by the Members. Concerning the conditional hold ballast/new task proposal, DNV's submitted a counter proposal for minimum forward draught criteria for all lengths. Following comment by one member, DNV subsequently submitted a compromise proposal.

The majority was in favour of the DNV's first proposal for a minimum draught forward, that is, the lesser of 0.03L or 8.0 meters. It was agreed that this requirements should be applicable to all bulk carriers regardless of the ship's length.

(The following compromise text, was supported by NK. GL, who proposed 0.025L/8m, did not respond to this compromise text:

4.4.1(b) v: *The forward draught in the heavy ballast condition is not to be less than the smaller of  $k*L$  and 8.0 meters where  $k = 0.00015L$ , but is not to be taken less than 0.025 and need not be taken larger than 0.03)*

The figure, 0.03L, was chosen instead of 0.025L since Members' studies revealed, in conjunction with the proposed requirement that at least one cargo hold be 100% full, that a minimum draught forward of the smaller of 0.025L or 8m was too shallow to be compatible to the ABS proposed ballast cargo holds.

- 4) With regard to para.4.4.2(b) concerning longitudinal strength checks when more than one hold is capable of being used for ballast at sea, the majority of GPG at GPG 53(2-4 Oct.2002) were of the view that each hold should be addressed in turn, with all the others empty but NK argued strongly that in case where two or more holds were intended to be filled together or when arranged to facilitate ballast water exchange at sea, certain configurations were unrealistic. Therefore, applying 4.4.2(b) on a single hold-filled basis would be too harsh. A particular case was a forward ballast hold which would never be filled with all other tanks full and holds further aft empty. The forward trim would make the ship unmanageable.

At a small GPG meeting during MSC 76, it was agreed that 4.4.2(b) should be amended to make the longitudinal strength requirements for heavy ballast conditions clear and to settle the unresolved issues.

- 6) The loading conditions listed under Section 4 are to be used for the checking of applicable rules criteria for longitudinal strength, i.e. for BC-B and BC-A designs of single skin construction the design conditions of Section 4.1 4.2, 4.3 and 4.4 are to be considered with respect to the requirements of S17 in addition to the requirements of S11. If the requirements of S17.1 is understood to be in conflict with this view, the application requirements of S17.1 must be amended.

Following a lengthy discussion, the criteria for longitudinal strength under Section 4 has been specified by adding a footnote to 2.2 as follows: "Footnote 1: As required by S7, S11 and S17".

**\* S 17 applies to BCs carrying solid bulk cargoes with bulk density of 1.0 t/m<sup>3</sup> or above. However, the notation BC-C applies to BCs carrying solid bulk cargoes with bulk density of less than 1.0 t/m<sup>3</sup> . Therefore, S17 will not be applied to BCs assigned the notation BC-C under S25.**

**(S17 does not require longitudinal strength checks in the hold flooded condition for BCs carrying cargos with bulk density of less than 1.0 t/m<sup>3</sup> .)**

7) Other proposals were considered and agreed with some modifications.

## **Conclusion**

- Council agreed to the proposed Revision No.1 of UR S 25 on 12 February 2003.

Attached:

- 1) NK's study on significant wave height vs the DNV's proposed formula.
- 2) Summary of members' reactions

## Attachment 1.

*DNV compromise proposal (NVj) – 4.4.1(b) v:*

*The forward draught in the heavy ballast condition is not to be less than the smaller of  $k * L$  and 8.0 m.  $K = 0.00015 L$ , but is not to be taken less than 0.025 and need not be taken larger than 0.03.*

0120gNKo dated 28 August 2002.

With regard to my message of 0120gNKn dated 23 Aug, 02, I would like to draw your attention to the attachment diagram, which contains a material that could support the *DNV's* proposed criteria of forward draught for the heavy ballast condition which is prepared for rough seas.

- The points shown in the diagram are the results of calculation on the basis of the occurrence probability of exposure of bottom at bow of bulk carriers exceeding 10-2 (1/100) against the significant wave heights.
- It is found that the significant wave heights are 2 - 3 m for smaller bulk carriers and are 6 - 7 m for larger ones, which can agree with seafarers' empirical recognition of rough seas.
- The real line as proposed in NVj is drawn in the diagram.
- From the diagram, the proposed forward draught criteria for heavy ballast conditions are found reasonable.

Further, as regards Paragraph 2.2.3 of LRC, the forward draughts in the normal ballast condition (not heavy ballast condition) of small bulk carriers without ballast hold are as follows:

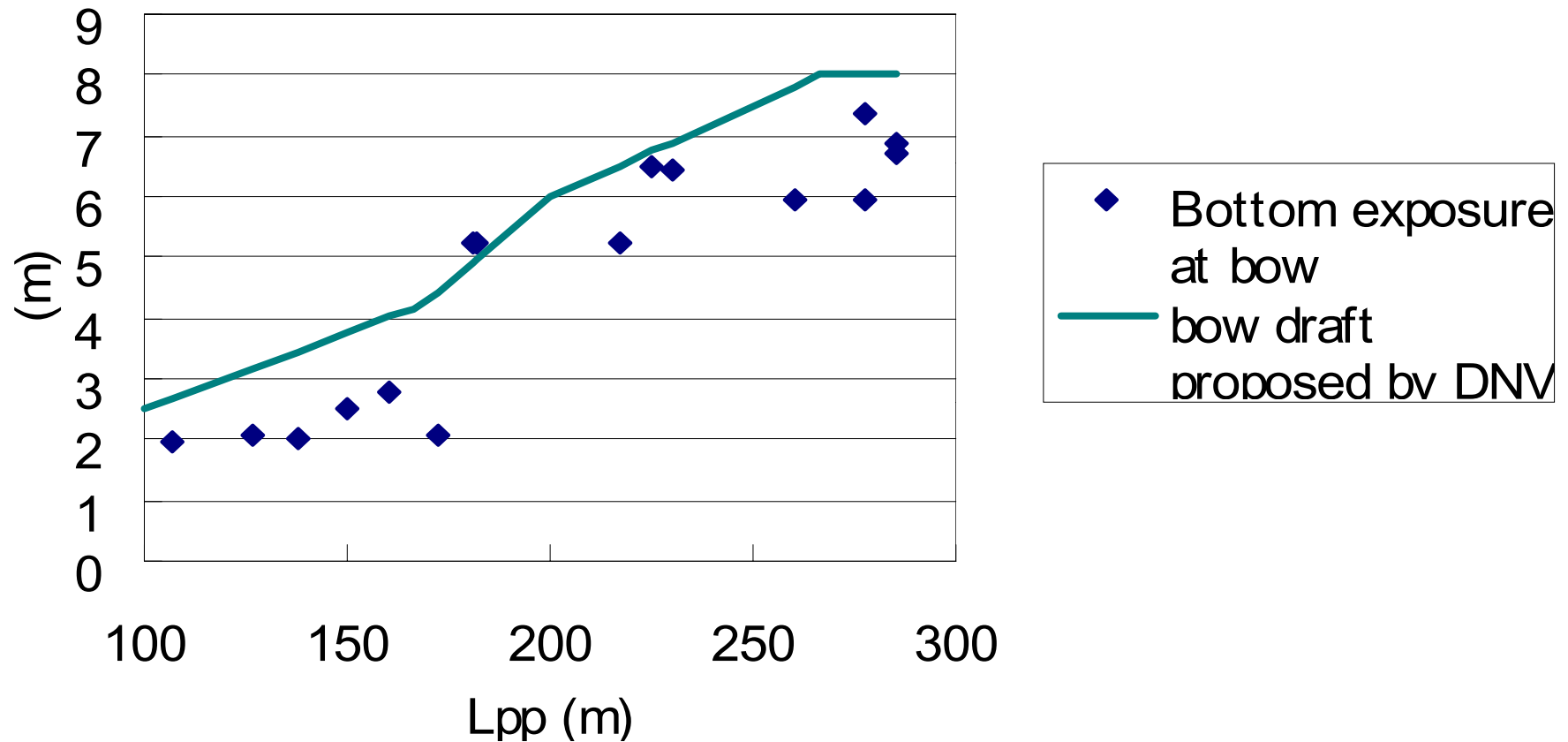
df / L	L(m)
1 0.0261L	143
2 0.0213L	148
3 0.0248L	150
4 0.0209L	160

I would like to invite GPG members to consider the above and accept the *DNV's* proposal in NVj based on the technical background as above explained.

Best regards

H.Jin

## Significant wave height for rough seas V.S. DNV's proposal





**THE REVISION OF IACS UR S25 (Rev.2, Feb 2003)**

**COMMENTS SUBSEQUENT TO ABd (22 JULY 2002) AND ABS REPLIES THERETO**

*(Comments are identified by 3 name/sequence digits, with their dates being shown in the last page)*

<b>Para.</b>	<b>Comment</b>	<b>Reply</b>
<b>1.3</b>	(ABh) (in conjunction with change to 2.2) Add reference to stability	Proposed in ABh.
	(NVh) OK	Noted
<b>2.2</b>	(NKj) 2. In order to clarify the application of loading and ballast conditions for strength assessment I would like to propose to editorially amend paragraph 2.2 of UR S25 as follows. "Rule criterion regarding local strength is to be checked for the loading conditions listed under Sections 4 and 5, as applicable. Rule criterion regarding longitudinal hull girder strength and stability is to be checked for the loading conditions listed under Section 4 and those specified in the approved loading manual based on the conditions listed under Section 5."	See below reply to LRb
	(LRb) 3. We agree with NK that the text of paragraph 2.2 should be edited to make its' intent clearer. The following text is proposed: "2.2 The loading conditions listed under Section 4 are to be used for the checking of rule criteria regarding longitudinal strength, local strength and stability. The loading conditions listed under Section 5 are to be used for the checking of rule criteria regarding local strength."	Agree, with addition of capacity and disposition of ballast tanks to "under Section 4". Also changed title of Section 5 to suit the revised 2.2, all in ABh.
	(NVh) OK (to ABi)	Noted
	(NKK) I agree to the revised wording for Paragraph 2.2 as proposed by LR in item No.3 of LR's message.	Noted
<b>3</b>	(ABh) (In conjunction with change to 4.1 – 4.3) In BC-A, add "at the summer load line draught" after "specified holds empty"	Proposed in ABh.
	(NVh) OK, but the words "at the summer load line draught" should be changed to "at maximum draught", which is the terminology used in the rest of S25. NB "maximum draught" is already defined in S25 2.3.	(ABk) Let us point out that "maximum draft is summer draft" in S25.2.3 is in itself an incorrect statement in that maximum draft is clearly tropical fresh or, where assigned, timber tropical fresh. It is therefore proposed that a much better formulation is to delete S25.2.3 and the phrase " <b>maximum draft</b> " be replaced, throughout S25, by the phrase " <b>molded summer load line draft</b> ." (This overrides ABi)
<b>4.1 – 4.3</b>	(LRb) Add "with all ballast tanks empty" after "at maximum draught"	Additions made in ABh.
	(NKK) - I support the insertion of wording "with all ballast tanks empty" after "at maximum draught" to Paragraphs 4.1, 4.2 and 4.3 as suggested by LR in item No.4 of the message in LRb.	See above
<b>4.4.1</b>	(NKh) - Add "arrangement and" to the title with corresponding change in the text.	-In ABf, The title is changed to read "Ballast tank capacity and disposition" to address the concern more explicitly and to the

	- Add "design" to the title of 4.4.1(a) and (b) and 4.4.2(a) and (b)	sequence of the events in design. Text changed accordingly. -the definition qualifies these terms for use with this UR and the intent of NK comment is considered fulfilled.
<b>4.4.1(a) i</b>	(KRd) "Slack condition" in item 4.4.1(a) and (b): - I would like to propose to use the phrase "partial filling" in line with other URS instead of "slack" - partial filling of ballast tanks is agreeable but we still tend not to allow partial filling of fore peak ballast tank. If it is to be allowed for the fore peak tank, it should at least be stated that the proper structural arrangement is to be provided to prevent sloshing load.	In ABg - Text changed to indicate partially filled. - Text also changed to refer to the last paragraph in S11.2.1.2
<b>4.4.1(a) ii</b>	(GLc) Add "and" at the end. (LRb) ... the propeller is <u>to be</u> fully immersed.	Addition made in ABg as suggested. Corrected in ABh as suggested
<b>4.4.1(a) iii</b>	(CCb) As far as length of ship is concerned, I considered that "L" should be the length of ship which is the initial consideration by SC/BCS and defined in MARPOL Convention where the coefficient of 0.015 is introduced instead of the length between perpendiculars of the ship, otherwise this coefficient should be reconsidered. (CCb bis) The use of LBP is acceptable to CCS if majority agrees. (LRb)...the trim is <u>to be</u> by the stern and is not to exceed...	It is believed that by adhering to 0.015, the definition of waterline is maintained without any change. Use of LBP is only for the sake of convenience of clients. Noted Corrected in ABh as suggested
<b>4.4.1(b) i</b>	(KRd) Same as 4.4.1(a) i	See reply above
<b>4.4.1(b) ii</b>	(LRb)...or required, is <u>to be</u> full. (NVh) The footnote regarding bulk carriers without ballast hold(s) is redundant and may be deleted.	Corrected in ABh as suggested Accepted in Abj but confirmation of uniform understanding by all Members requested in Abm.
<b>4.4.1(b) iii</b>	(GLc) Delete "and to the waterline" (LRb)...immersion I/D is <u>to be</u> at least ...	Deleted in ABh as suggested. Corrected in ABh as suggested
<b>4.4.1(b) iv</b>	(LRb) ...the trim is <u>to be</u> by the stern and <u>is not to</u> exceed...	Corrected in ABh as suggested
<b>4.4.1(b) last para.</b>	(NKh) Delete the entire paragraph (NKi) NK will make further comment early next week. (NKj) The proposal for a mandatory requirement for installation of a ballast hold for bulk carriers of certain length and above is supported. In this connection in the fleet statistics there is a clear separation of ship length between handy size and panamax at the length of 200m. Therefore it would be more appropriate to use this	Pending further comment by NK, the paragraph is retained in ABg. (ABh) ABS can support 180m, if supported by others, but cannot support 200m proposed by NKj, for reason that it departs from the present day practice as most recently reported by NK on 17 April 2002 reading in part: <b>"2.2 Bulk carriers smaller than Panamax</b> <i>While checking 36 bulk carriers of 172m in length and less classed by ClassNK, it was found that about 94% of them did not have ballast holds. Therefore design ballast condition of this size of bulk carriers must be normal ballast condition.</i> <i>While checking 30 Handymax bulk carrier of around 180m in length and over, all bulk carriers have ballast holds. It could not however be confirmed whether or not heavy ballast condition is used more frequently than normal ballast condition. The answer is unknown at the moment.</i> <i>Therefore we have to consider that there are two types of Handymax bulk carriers, i.e., Panamax-like Handymax bulk carriers and Handy-like Handymax bulk carriers in terms of operation or selecting ballast condition."</i>

**4.4.1(b)  
last para  
(cont'd)**

length for requirement of a ballast hold.	which agrees with ABS finding. Please note that how often hold ballast will be used is not the issue. Rather, if such option is available in case of need is the issue of safety which need be addressed.	
(BVb) 1. It is a good thing from operational point of view to increase the range of sea states where the ship can be operated with light ballast condition (without filling the ballast hold). As defined by SC/BCS, this could be obtained by reinforcing the bottom forward against slamming, fully immersing the propeller and dealing with longitudinal strength. 2. As a matter of ship safety, it is needed, at least for Panamax and larger vessels, to allow the captain to adopt a heavy ballast (ballast hold is full) condition where storm conditions are expected. As mentioned in ABS message (1.B Capacity and parameter), the draft increase in this case is much higher than the one corresponding to 60% propeller immersion. The only fact we know with reasonable accuracy is that this heavy ballast condition generally allow present vessel designs to sail in very bad weather without major damages. Conditions like the 60% propeller immersion do not lead to the same level of safety, and may be insufficient in storm conditions. The two above principles are fully in line with the MARPOL requirements for oil tankers, taking into account the bulk carrier specific fact that the scantlings of the ballast hold are to specially designed for ballast carriage purpose. The ABS proposed revision of UR S25.4 (document 0120gABdRevS25.doc) meets the above mentioned two principles in our opinion and is therefore supported, including the length limit value of 172 - 180 m. For the same reasons, we do not support the NK and DNV proposals.	The last paragraph is retained in ABg based on this comment.	
(KRc) 3) Item 4.4.1(b) (i) - <i>which then read "any water ballast hold is be full"</i> - is suggested to delete since there is no need to define all ballast holds to be full once strength requirements and trim/draft requirements are satisfied. Therefore, NK's amendment to this item is supported. With this amendment, no length limit - <i>in the last paragraph</i> - for bulk carriers to have ballast hold can be deleted. Our record shows that ballast hold are rarely designated in a handy size bulk carrier and this deletion can enhance the designer's/operator's option.		In ABf, hold ballast is addressed in 4.4.1(b) ii with qualifier "where required or provided"
(KRd) - with the introduction of item 4.4.1(b) ii, we can agree with the last sentence - <i>assumed to refer to last paragraph</i> - of item 4.4.1(b).		The last paragraph is retained in ABg based on this comment
(Rlc) For the same reasons as expressed by Mr Guyader in BVb and repeated by Mr McIntyre in ABf, RINA supports the view that one or more holds dedicated to the carriage of ballast are to be explicitly required in 4.4.1 (b), at least for ships above a certain length. As far as the length limit of 172 m is concerned, it results to us that a large amount of Handysize bulk carriers are concentrated in the range 170-180 m, so that a limit within this range would entail that one ship might be discriminated from another just for a matter of centimetres! We are of the opinion that 170 m is an appropriate length limit; however, we would appreciate other Societies' view on this matter		The last paragraph is retained in ABg based on this comment
(Rld) Minimum length of 170m should be retained as indicated in Rlc.	The last paragraph is retained in ABg based on comments from other societies For the same reason, 180m was retained in ABh.	
(CCb) The length limit of 172 m is unnecessary as all the ships of 150 m or above can be designed and assessed under the requirements of URs.	As a matter of fact, at-sea ballast water hold is fitted for all larger ships. It was found necessary that this practice be written into UR at least pending completion of a new task being proposed at this time to establish all criteria necessary and sufficient for the safety of heavy ballast condition. For this reason, this paragraph was retained in ABg for further consideration. Or is it your opinion that all ships of 150m and above are to have ballast hold?	
(CCb-bis) As far as minimum length of ship is concerned, CCS prefers 180m.		[180m] is reflected in ABi
(LRb) Whilst we have considerable sympathy with the amendments proposed by Mr Myklebust (0120gNVd), we consider that it would be preferable to explicitly require the provision of a ballast hold for larger bulk carriers. LR consider that a minimum length of 180 metres should be		See reply to NKj

**4.4.1(b)  
last para  
(cont'd)**

specified, although we could accept 200 metres as proposed by Mr Jin (0120gNKj) if this is supported by other Members.	
(NVd) Delete the last paragraph and introduce item v reading "the draught forward is not less than the smaller of 0.03L and 8.0 meters. .	(ABi) DNV propose to replace the requirement for a ballast hold for ships above a certain length with a minimum required draught forward. We understand that the minimum draft forward criteria which DNV proposes is an empirical criteria which fits with the current DNV bulk carrier fleet (being the heavy weather ballast draught forward with ballast hold filled on ships with ballast holds). If so, then we consider it to be a surrogate for, or alternative to, simply mandating a ballast hold above a certain length limit--based on current empirical practice, but using different parameters. So, in our view, as with the ABS proposal to require a ballast hold, the DNV proposal can only be considered to be a "stop gap" measure. We cannot see that the proposal has any greater merit than simply requiring a ballast hold; and is much less direct. If adopted, it has the potential of "locking in" future design practice for a very long time to come using parameters the origin and significance of which will soon be forgotten. Also, we have not had time to check how these proposed criteria "fit" with the ABS fleet. And, since we have done that check for the length limit for mandating a ballast hold, which is supported by the NK study done for SC/BCS and which a majority of other societies have agreed to in principle, we strongly believe the ABS proposal is the better chose (particularly at this late date.) Also, what we understand is happening now is that designers are producing "standard" S25 compliance designs but with bigger ballast tanks and no ballast holds. This was never intended. It is possible that, with the DNV minimum draught forward criteria, designers will continue to provide much bigger than needed ballast tanks instead of ballast holds and present the designs to owners as IACS S25 compliant designs--any changes are at additional cost to owners. This is what we seek to avoid, while not unintentionally reducing the safety and flexibility of existing (unregulated practice) by inadequate regulation. So, we do not support the DNV proposal in this regard.

	<p>(NVe) For the sake of good order, DNV completely agrees that a good bulk carrier design should include cargo hold(s) adapted for ballast water. What we have argued against, and which is the reason for our suggestion in 0120gNVd of 12-08, is the need to introduce a mandatory requirement to ballast hold(s) for some types of bulk carriers into S25, a UR which is not intended to tell designers how to design the arrangement of bulk carriers, and which may introduce more questions than it solves.</p> <p>Please recall that most bulk carriers are today designed with ballast hold(s) even though there are no formal requirements to do so. The reason is that designers have found this to be the best compromise between providing sufficient ballast capacity and maximum cargo hold cubic capacity. We can not see that the introduction of UR S25 will make the voluntary inclusion of ballast hold(s) less likely.</p> <p>If ballast hold(s) are to be required, we would argue that such requirements should apply equally to single side skin and double side skin bulk carriers. For most double side skin designs, that we have been involved in, the designers have tried to retain the cargo hold cubic capacity by reducing the size of top wing tanks and hoppers to compensate for the volume occupied by the double side skin, thereby keeping the same ballast tank capacity as of a single side skin vessel, and keeping the same need for ballast hold(s).</p> <p>Equal applicability would also remove the need for the "special consideration" statement 4.4.1(b), which would most likely lead to different application by the various IACS members. It would also solve the problem of how to handle bulk carriers with partial double side skin, i.e.; double side skin in some cargo holds and single side skin in the rest.</p> <p>Finally, a bulk carrier's length is not as clear-cut a parameter as it might initially seem. For example if the size limit is set to 200 m as proposed by 0120gNKj, all modern handymax bulk carriers (50 - 55000 tdw) will fall below this size limit (around 190 metres) although they are normally provided with ballast hold(s), while a much smaller 36000 tdw lakesize bulk carrier may exceed 200 metres. If a size limit in terms of ship's length should be applied, such length limit should be below that of typical handymax bulk carriers, f. inst. 180 metres as suggested in 0120gLRb</p>	<p>(ABi) Regarding requiring a ballast hold above a certain length, we have explained and argued the need for this to the best of our ability in our prior messages and in 2.2.1 above. IACS has decided to "regulate" ballast conditions for bulk carriers for the first time. However, the regulation in S25 on this at present is "necessary" but "not sufficient" and will, if left as is, result in designs of bulk carriers which are less capable, less safe and less flexible in heavy weather ballast operation than is currently provided by the "unregulated" market. This is wholly unintended and counterproductive, and since it relates directly to safety--we cannot leave it as it is. Mandating a ballast hold above a certain length will simply clarify to designers not to design bulkers which "just meet" the other criteria in S25 and should steer them back on course. Owners, whose complaints we are trying to satisfy, will not take kindly to being presented with an S25 compliant design with unnecessarily large ballast tanks and no ballast holds--requiring redesign to meet owners needs.</p> <p>Regarding DNV's objection to allowing "special consideration" for the length at which a ballast hold is to be required on double skin bulk carriers, we understand their arguments and, in effort to reach consensus, we can agree to deleting this provision, if so agreed by other Members. I have therefore put this sentence in square brackets in the attachment. If this sentence is deleted will DNV join the majority and agree to mandating a ballast hold on bulkers of 180m length and above? Would DNV please advise?</p> <p>And, as indicated in ABh, we agree to the 180m Length limitation espoused by DNV.</p>
<p><b>4.4.1(b) last para. (cont'd)</b></p>	<p>(GLd) GL fully supports DNV's approach to define a minimum ballast draft at F. P. The approach focuses directly on the main issue of bottom strengthening forward due to slamming pressure . Besides, GL is of the opinion that the proposed formulation of minimum ballast draft forward might be too conservative . GL suggests to use 0,025 L instead of 0,03 L in the formulation.</p> <p>The revised version would therefore read as follows: "The draught forward is not less than the smaller of 0,025 L length as defined in S2 and 8.0 metres".</p>	<p>(ABi) We do not believe the DNV proposed forward draught criteria relates to prevention of slamming forward--we believe it is an empirical fit to the current DNV fleet of bulk carriers in the heavy ballast condition with a ballast hold filled.</p>
	<p>(NKK) The criterion for the draught forward of 4.4.1(b) Heavy ballast condition that is proposed by DNV in place of a mandatory requirement</p>	<p>(ABj) 1. Re the proposals in NVh and NKK to replace the requirement for a ballast hold for ships above a certain length with a minimum draught forward requirement for ships above a certain length:</p>

<p>of ballast holds provides generic approach of heavy ballast condition and is supported. However it needs further examination as pointed out by Mr Jacoby in GLd that the proposed formulation of minimum ballast draught forward might be too conservative. As a result of NK's investigation on the forward draughts of NK class ships, the proposed criterion, i.e. the smaller of 0.03L and 8.0 meters, is found reasonable for larger bulk carriers like Panamax, Capesize bulk carriers. However, for handy size bulk carriers that do not have a hold adapted for ballast this criterion is too conservative. In this regard, I share ABS concept that no ballast hold is required for smaller bulk carriers. The propeller immersion criterion, taking into consideration the fact that the criterion of 60 % propeller immersion for heavy ballast condition provides sufficient criterion for handy size bulk carriers without regulating the draught forward.</p> <p>I therefore consider that it would be appropriate to take the above assessment into account in the draft text by DNV (NVd) and to amend to read as follows:</p> <p>"4.4.1(b) Heavy ballast condition"</p> <p>i - iv no change</p> <p>v "The draught forward for bulk carriers 200 m and above in length as defined in S2 is to be not less than the smaller of 0.03L and 8 meters."</p>	<p>1.1 we reiterate our view that it is more transparent and direct to simply require the ballast hold, in line with the current (unregulated) practice. As BV pointed out: "As a matter of ship safety, it is needed, at least for Panamax and larger vessels, to allow the captain to adopt a heavy ballast (ballast hold is full) condition where storm conditions are expected. As mentioned in ABS message (1.B Capacity and parameter), the draft increase in this case is much higher than the one corresponding to 60% propeller immersion. The only fact we know with reasonable accuracy is that this heavy ballast condition generally allow present vessel designs to sail in very bad weather without major damages. Conditions like the 60% propeller immersion do not lead to the same level of safety, and may be insufficient in storm conditions."</p> <p>This "safety condition" is today met, in unregulated practice, by the provision of a ballast hold. It is most appropriate to simply continue this practice (unless or until we can provide "definitive" heavy weather ballast criteria) rather than to impose an empirical, surrogate parameter such as minimum draft forward to accomplish the same objective in a more indirect and more limiting way.</p> <p>Simply put, minimum draft forward in heavy ballast is not considered a reliable parameter to define a ballast capacity requirement for the purpose of ensuring safety. A draft at the center of flotation in terms of %age of maximum displacement ("Bulk Carrier Practice" indicated 50-65% of loaded displacement to be the norm for heavy weather ballast, see 0120gIAC, 9 Aug) may be.</p> <p>1.2 It does not make sense for designers to design ships with unnecessarily large ballast tanks-- which they may still do if the minimum forward draft criteria--is adopted in UR S25 when owners want and will require ballast holds. This potential foulup is avoided by simply mandating the ballast hold.</p>
<p><b>4.4.1(b) last para. (cont'd)</b></p> <p>(NKK) Comments to 2.1 Paragraph 4.4.1(b) of ABS comments in ABh</p> <p>-1. With regard to the length criterion based on NK report, I would like to suggest that the statistics on ship length of bulk carriers contained in the attached document (0120gNKKAttach_SC3Ax6A2.doc) is to be used as the common basis.</p> <p>-2. However, in line with the new approach proposed by DNV in NVd to specify the minimum forward draught using ships length, which was further elaborated in the message NVe of 14 Aug. 02 an introduction of a mandatory ballast hold requirement is taken over by the DNV's approach. In case of a need of demarcation in ship length for different approaches according to the size 200 m is a pragmatic magic number, which avoids difficult separation of bulk carries in the same category of sizes.</p>	<p>See ABI</p>
<p>(IGd) I would request that Members who have not already done so now comment on this issue, stating which proposal they</p>	<p>(ABk) 1. With reference to Chairman's IGd, 15 Aug: Our first and foremost objective, indeed our obligation, must be to establish criteria which provide for adequate safety. We do know that the current (unregulated) design practice provides adequate safety for heavy weather ballast service-- based on the historical record. However, we do not know, today, whether or to what extent that practice (in terms of heavy weather ballast capacity) can be reduced, if at all, before the boundary between "adequate safety" and "inadequate safety" would be reached. ABS has proposed a new task exactly for this reason, pending completion of which, IACS should be taking a prudent approach by adopting a UR compatible to the current design practice. For this purpose, we must be checking heavy ballast displacement, rather than forward draft, so that rough weather performance and ship's motion can</p>

<p>support. In addition, if supporting the ABS proposal, please indicate whether you support a minimum length of 180 m or 200 m. If supporting the DNV proposal, please indicate whether you support a minimum draft forward of 0.025L or 0.03L.</p>	<p>be controlled. It is also to be noted that propeller immersion in current designs is considerably above 60% and checking forward draft alone does not provide a true picture of the ballast capacity actually provided under the current (unregulated) design practice. (See further comments on this below and the attached files.)</p> <p>Therefore, we reiterate our view, and urge Members to support, that a simple, straightforward and transparent mechanism for achieving the safety objectives outlined above is to require a ballast hold for the size range of ships for which current, unregulated design practice, has historically provided a ballast hold. We believe it clear from the arguments we have put forward previously, and below, that attempting to do this by specifying minimum draft forward is neither transparent nor adequate. Further, it will be seen from the information in the attached file, that (with respect to the ABS fleet) the proposed criteria for minimum draft forward constitutes a significant reduction in heavy weather ballast capacity. How can we, or indeed anyone, know whether such reduction is sound or unsound--and whether ships built to this criteria would prove to have adequate safety in heavy weather conditions or not? We cannot know the answer to that without doing the studies and work necessary to establish a rational and definitive set of minimum heavy weather ballast criteria which will "just" provide adequate safety. Unless or until that development is done, we should not reduce, either consciously or inadvertently, the heavy weather ballast capacity which the unregulated market has provided up to now.</p>	
<p><b>4.4.1(b) last para. (cont'd)</b></p>	<p>(NKI) 1. Reference in made to the Chairman's message IGd and ABS' message ABj both dated 15 Aug. 2002 and earlier messages in this regard.</p> <p>2. One of the outstanding issues is the heavy ballast condition, in particular, how IACS wishes to regulate this matter in a technically accountable manner. I would like to point out that the new UR S25 is to be address the safety aspects of IACS concern in a way that designers are guided to satisfy the fit for purpose design that shipowners are happy with. At the same time IACS should avoid to restrict innovative design approaches which may come up in some time by dwelling in the design of today.</p> <p>3. There are two approaches being discussed, i.e. a mandatory ballast hold arrangement or a ballast tank/hold arrangement that achieves the minimum forward draught in addition to the propeller immersion and trim requirements. Use of hold ballast in the present design certainly resulted in achieving deep draught in heavy ballast condition without being regulated to have one. This approach is in my view one of the technical solutions to satisfy a number of design and operational features that shipowners and designers considered necessary. Largest cargo capacity, sufficient propeller immersion for achieving necessary propulsion without causing propeller racing, deep forward draught to avoid slamming in heavy sea conditions, appropriate stability, maneuverability, etc.</p> <p>4. The mandatory ballast hold approach for bulk carriers of certain length and above would endorse the present design practice but it falls short of regulating the relevant design parameters. It would be interesting to study the desired heavy ballast conditions in terms of stability, maneuverability, sea keeping performance, slamming frequency, propulsion and ahead speed, etc. At present those matters have been properly achieved in a satisfactory manner to all concerned by regulating some of them and there is no significant and compelling needs to attempt regulating all of them by IACS regulations and it would be sufficient to touch upon some of the key elements at least at this time under the revision of UR S25.</p> <p>5. Having said above I would like to put forward my comment to the course of action in your message IGd with a view to closing the gaps and taking members' preferred approaches. I would like to request you that the NK proposals in NKK and the third item to decide should be included in the items to which GPG members are requested to indicate their views:</p> <p>-1. NK's proposal in item 3.1 of its previous message NKK concerning items 3.2 and 4 of the Chairman's message IGd.</p> <p>As NK had proposed the applicable ship length is to be associated with the forward draught that the minimum forward draught should be the smaller of 0.03L and 8 m for bulk carriers of 200 m and above in length.</p>	<p>See ABI</p>
<p>(NVi) 1. Mandatory requirement to ballast hold</p>	<p>(ABK) It is agreed that the</p>	

	<p>We are in complete agreement with ABS and BV that a heavy ballast condition is needed for stormy weather. We also agree that to provide a ballast hold is a good way to provide a safe condition in stormy weather [provided the ballast hold has been/can be filled under safe conditions!]. As a matter of fact most bulkcarriers are provided with ballast holds today although there are no formal requirement to do so. Our objections to requiring a ballast hold are based upon other considerations:</p> <ul style="list-style-type: none"> <li>* The need to be safe in stormy weather applies to all bulkcarriers to which S25 applies [ie L above 150m]. Requirements to a heavy ballast condition should therefore be formulated so that it covers all bulkcarriers above 150m.</li> <li>* Requirements that apply only to some bulkcarriers [size groups/structural configurations] may create the unwanted impression that IACS do not care about the safety of other bulkcarriers in stormy weather.</li> <li>* IACS requirements should be formulated so that good design practices at present are supported, ie. to provide ballast hold[s], while at the same time not preventing technological innovation and alternative solutions.</li> <li>* The intention of by SC/BCS when developing S25 was not to instruct yards or to limit their freedom in designing the general arrangement of bulkcarriers.</li> </ul> <p>We believe that our proposed criteria meet the above considerations. We would be prepared to accept slight modification of the criteria, eg as suggested by GL, if that is the majority view of the members. We do, however, not understand the reason why the DNV criteria should only apply to bulkcarriers above 200m as suggested by Mr Jin in his message NKI, and would have difficulties in supporting his suggestion as our objective has been to have criteria applicable to all bulkcarriers covered by S25.</p> <p>We can not understand that our proposed criteria will prevent or discourage the current practice of providing bulkcarriers with ballast hold(s).</p> <p>Neither are we overly concerned that some designers will try to increase the size of dedicated ballast tanks in order to meet the criteria without providing a ballast hold. Such solutions will necessarily reduce the cargo hold cubic capacity, which are still one of the main parameters considered by shipowners when ordering bulkcarriers, and make such designs unattractive in the marketplace.</p>	<p>UR should not prevent new technologies but we also recall that DNV objected to the proposal for special consideration for double hull designs. Pending approval and completion of the task being proposed, it is our opinion that such special consideration should be allowed. We must again recall that our proposal for mandatory hold ballast above [170-180m] is in conjunction with the SC/BCS requirement for 60% immersion and should be considered as applying to all lengths; however, we will be agreeable to additional requirements below that length. See further comments below.</p>
<p><b>4.4.1(b) last para. (cont'd)</b></p>	<p>(NKm) 1. Reference is made to DNV's message NVi, in particular to the paragraph that discussed the forward draught in ballast condition, in which DNV discussed that the forward draught in heavy ballast condition is to be applicable to all bulk carriers under UR S25.</p> <p>2. First I would like to point out that the discussion about the NK's proposal in NKI is not comprehensive and only looking at the idea NK put forward partially. As NK had pointed out that the forward draught in heavy ballast condition proposed by DNV is appropriate for bulk carriers of 200 m in length or greater but too deep against the present design and safety record for bulk carriers of less than 200 m. NK's proposal was to separate the application in two parts, i.e. for bulk carriers of length 200 m or above and the rest. NK does not consider it appropriate to reduce the requirement of forward draught of the lessor of 0.03L or 8m for the group of larger bulk carriers because it gives a message to industry that the forward draught in heavy ballast condition in the present design practice is too large.</p> <p>3. There will be a couple of possible approaches for the group of smaller bulk carriers, i.e. of length less than 200m. My message in NKI suggested that the forward draught in heavy ballast condition of the group of smaller bulk carriers can be left unregulated as is the present situation. The strengthening of forward bottom, minimum propeller immersion and maximum trim requirements have sufficient criteria for those vessels to navigate in heavy weather condition. NK however can accept the forward draught of 0.025L in heavy ballast condition by taking the proposal of GL as adapted for this size category as the required draught will be 5m for 200m length, the maximum ship length of this size</p>	<p>See ABI</p>



category.														
<p>(NVj) When DNV proposed to link the heavy ballast condition to a forward draught the proposed figure of 0.03L we knew that this was based on a rough statistics, and was prepared for small adjustments. We wanted however to avoid restricting the figure to ships over or under a given length. We therefore are reluctant to accept the proposals of NK and GL. We have however made further studies into this, and would like to present the following revised formulation:</p> <p>"The forward draught in the heavy ballast condition is not to be less than the smaller of <math>k \cdot L</math> and 8,0 m.  <math>k = 0,00015 L</math>, but is not to be taken less than 0,025 and need not be taken larger than 0,03."</p>	<p>(ABk) We have checked a number of the bulk carrier designs classed with ABS in relation to the proposed minimum draft forward criteria put forward in NVd and NVj. The results are shown in the attached files. Our survey clearly indicates that the required drafts forward and aft, and resulting displacement, are considerably less than the full hold ballast condition and cannot be accepted--unless/until confirmed by the proposed task to develop rational and definitive criteria. <b><i>We therefore propose, in the spirit of compromise and in pursuit of a unanimous concensus, that our proposal to require a ballast hold above [170-180m] Length be retained and the minimum forward draft criteria proposed in NVj be applied for ships below that length that are not provided with a ballast hold.</i></b> This additional requirement (minimum draft forward requirement for smaller ships which do not have a ballast hold) is considerably more than the SC/BCS provided in the original S25, and current design practice, but we are prepared to accept it if all other societies are in agreement. We encourage all Members to carefully check their existing fleet against the proposed minimum draft forward criteria and we believe that, having done so, Members will agree that such a criteria is not preferable to our proposal to simply require a ballast hold for ships above a certain size, in line with current practice.</p>													
<p><b>4.4.1(b) last para. (cont'd)</b></p>	<p>(LRc) 1. Reference is made to my emails 0120gLRb and 0120gIGd dated 12 and 5 August 2002 respectively.  2. With regard to the questions raised in 0120gIGd, the following comments are offered:  2.1 Mandatory Requirement for Ballast Hold  2.1.1 We should think of future double hull bulk carrier designs, which may have sufficient ballast tank capacity to achieve 4.4.1 (b) of 0120gNVd. For current single skin designs, it is practically impossible for a ship in excess of 200 m to achieve the draught forward of "the smaller of 0.03L or 8 m" without having a ballast cargo hold.  2.1.2 Therefore, following a careful review of the ABS and DNV proposals, LR now support DNV's proposal for a requirement for the minimum draught forward in the heavy ballst condition.  2.1.3 The requirement for the heavy ballast condition with a minimum draught forward of "the smaller of 0.03L or 8 m" should be applicable to all bulk carriers regardless of the ship length.  2.2 0.025L or 0.03L  2.2.1 LR support 0.03L. The minimum draught forward in this requirement is not applicable to normal ballast but only to the heavy ballast condition. According to LR's studies, "the smaller of 0.025L or 8 m" is too shallow to require ballast cargo holds for single hull bulk carriers.  2.2.2 Our investigation indicates that the heavy ballast conditions of all bulk carriers with a ballast hold satisfy the "the smaller of 0.03L or 8 m" requirements as indicated below:</p> <table border="0"> <tr><td>1 Handy size</td><td>0.044L</td></tr> <tr><td>2 Handy size</td><td>0.038L</td></tr> <tr><td>3 Handy size</td><td>0.038L</td></tr> <tr><td>1 Panamax</td><td>0.032L</td></tr> <tr><td>2 Panamax</td><td>0.037L</td></tr> <tr><td>3 Panamax</td><td>0.033L</td></tr> </table>	1 Handy size	0.044L	2 Handy size	0.038L	3 Handy size	0.038L	1 Panamax	0.032L	2 Panamax	0.037L	3 Panamax	0.033L	<p>See ABI</p>
1 Handy size	0.044L													
2 Handy size	0.038L													
3 Handy size	0.038L													
1 Panamax	0.032L													
2 Panamax	0.037L													
3 Panamax	0.033L													

	<p>4 Panamax 0.037L  1 Cape size 0.031L  2 Cape size 0.029L but &gt; 8.0 m</p> <p>2.2.3 We are aware of one bulk carrier design with a ship length of 176 metres with no ballast hold. The minimum draught forward in the heavy ballast condition is 0.029L, which is very close to the proposal above.</p> <p>2.2.4 We would be interested in other Members' data regarding the draught forward of bulk carriers with no ballast cargo hold.</p>	
<p><b>4.4.1(b)</b>  <b>last para.</b>  <b>(cont'd)</b></p>	<p>(NKn) Reference is made to messages of ABS in ABk, DNV in NVj and LR in LRc</p> <p>1. With regard to the approaches of DNV and ABS, I, logically, understand that:</p> <p>1) Though DNV's approach may require less forward draught than the present design practice of vessels with a ballast hold, it inevitably results in a design which arranges a ballast hold to meet the proposed forward draught requirements.</p> <p>2) ABS's approach does not specify the size of a ballast hold and, I think, needs to be more specific.</p> <p>3) DNV's approach would help to define the desired heavy ballast condition even the formula is to be further reviewed.</p> <p>2. As regards LR data on the forward draughts in Paragraphs 2.2.2 and 2.2.3 of LRc, our own data shows less forward draughts e.g. approximately 0.025L in smaller bulk carriers that have no ballast hold. I will forward our own data in the early next week.</p> <p>3. As a conclusion, I may support the DNV proposal contained in NVj.</p> <p>4. And I would like to propose that the technical background for the forward draught requirements should be prepared based on the studies by DNV mentioned in NVj in order to make them justifiable.</p>	<p>See ABI</p>
	<p>(KRe) 1. Ref. is made to IGd dated 15 August, LRc of 22nd August and other commenting e-mails. I appreciate other members' comments and insight on ballast condition issue.</p> <p>2. With regard to the questions in 0120gIGd, please be advised our position as follows:</p> <p>1) whilst I see the valuable points of commenting members, I tend to support not to require mandatory ballast hold as has been expressed in my mail KRc dated 24 July. Instead, I support DnV's proposal to define minimum draft forward in heavy ballast condition.</p> <p>2) It reveals that the forward draft under heavy ballast condition for the existing three handy size bulk carriers which have no ballast cargo hold are 0.0245L(160m), 0.0289L(172m) and 0.025L(178m). However, I support 0.03L as a minimum draft.</p>	<p>See ABI</p>
	<p>(BVc) Mandatory requirement for ballast hold UR S25 4.4.1 (b)</p> <p>BV fully supports the analysis and conclusions provided in Steve McIntyre's message 0120gABk dated 21/08/2002, requesting at least one hold able to be ballasted for ships of more than 180 m in length.</p> <p>Justification of our position is provided in our previous message (0120gBVa)</p> <p>Further to the comments of the other members, we emphasize two additional points:</p> <ul style="list-style-type: none"> <li>- Whatever our final position, we are now setting a standard. According to the first reactions and the questions we have received concerning UR S25, the Industry has understood this. The new standard will replace the former unregulated "generally accepted" designs. The job of the shipyards will be now to design ships within the constraints fixed by the new URs (S25, Sxx, Syy, Szz...), neither more nor less. As a consequence, if we don't require a ballast hold, we effectively prevent the present practice of providing one, except if this is an explicit requirement of the Shipowner. However, we have understood that this last point is precisely what HKSOA wanted to avoid.</li> <li>- In attached graphs 1 and 2, we have displayed the DNV proposed criteria (60% propeller immersion + fore draught proposal of 0120gNVj) against the present</li> </ul>	<p>See ABI</p>

	<p>practice of Heavy Ballast including ballast holds for ships referred to by NK (SC/BCS document "Investigation on Design Ballast Condition 2002-04-17) , ABS in 0120gABk, LR for Panamax of 216 m Lpp in 0120gLRc and 5 additional BV ships.</p> <p>Our conclusion is that the standard proposed by DNV is significantly lower than the present practice for all ships larger than 180 m in length, with regard to slamming probability of occurrence and propeller racing in harsh weather. So we cannot support this proposal .</p>																
<p><b>4.4.1(b) last para. (cont'd)</b></p>	<p>(NKo) With regard to my message of 0120gNKn dated 23 Aug, 02, I would like to draw your attention to the attachment diagram, which contains a material that could support the proposed criteria of forward draught for the heavy ballast condition which is prepared for rough seas.</p> <p>The points shown in the diagram are the results of calculation on the basis of the occurrence probability of exposure of bottom at bow of bulk carriers exceeding 10-2 (1/100) against the significant wave heights.</p> <p>It is found that the significant wave heights are 2 - 3 m for smaller bulk carriers and are 6 - 7 m for larger ones, which can agree with seafarers' empirical recognition of rough seas.</p> <p>The real line as proposed in NVj is drawn in the diagram.</p> <p>From the diagram, the proposed forward draught criteria for heavy ballast conditions are found reasonable.</p> <p>Further, as regards Paragraph 2.2.3 of LRc, the forward draughts in the normal ballast condition (not heavy ballast condition) of small bulk carriers without ballast hold are as follows:</p> <table data-bbox="331 707 672 858"> <thead> <tr> <th></th> <th>df / L</th> <th>L(m)</th> </tr> </thead> <tbody> <tr> <td>1</td> <td>0.0261L</td> <td>143</td> </tr> <tr> <td>2</td> <td>0.0213L</td> <td>148</td> </tr> <tr> <td>3</td> <td>0.0248L</td> <td>150</td> </tr> <tr> <td>4</td> <td>0.0209L</td> <td>160</td> </tr> </tbody> </table> <p>I would like to invite GPG members to consider the above and accept the DNV's proposal in NVj based on the technical background as above explained.</p>		df / L	L(m)	1	0.0261L	143	2	0.0213L	148	3	0.0248L	150	4	0.0209L	160	<p>See ABI</p>
	df / L	L(m)															
1	0.0261L	143															
2	0.0213L	148															
3	0.0248L	150															
4	0.0209L	160															
	<p>(NVk) Please note our comments to Hisayasu's mail:</p> <p>When DNV formulated the proposal in our mail NVj of 23 August 2002, this was an attempt to provide a compromise solution that does not collide unacceptably with present design practices for the heavy ballast condition of the smaller bulk carriers. However, we agree with what we understand to be the underlying position of NK on this matter, that the stipulated minimum forward draught for the heavy ballast condition in UR S25 should not be considered as a safety issue. The statistical data over bulk carriers lost while in the ballast condition provides no indication in such direction.</p> <p>The proposed forward draught limit in the heavy ballast condition should in DNV's opinion rather ensure that the frequency of bottom slamming will not induce the ship speed to be reduced beyond those reductions decided based on a general assessment of sea condition. The documentation provided by NK in their mail of 28 August 2002 is not entirely clear to us. We would therefore appreciate a more detailed explanation of the background.</p>	<p>See ABI</p>															
	<p>(ABI) 1. Monitoring the replies from Members, we see that despite our best efforts to convince Members of the need to require a ballast hold, the majority supports the DNV proposal for a minimum draft forward requirement for the heavy ballast condition.</p> <p>2. Nonetheless, we must say that we appreciate and fully support the arguments and additional points provided in Maurice's message BVc, 23 Aug and still believe requiring a ballast hold to be the better and more prudent approach for IACS to take.</p> <p>3. That said, in light of the majority support for the minimum draft forward requirement, we would be prepared to accept the "...the smaller of 0.03L or 8 m..." formulation, but we cannot accept the 0.025L formulation.</p>	<p>-</p>															

	<p>(IGe) 1. Reference is made to my email dated 15 August 2002 (0120gIGd) and to the further very stimulating correspondence from Members.</p> <p>2. Following receipt of Mr McIntyre's message 0120gABI, seven Members now support a requirement for a minimum draught forward in the heavy ballast condition. Two Members (BV and CCS) support an explicit requirement for the provision of a ballast hold, whilst I can not trace a response from RS.</p> <p>3. Of the Members supporting a requirement for a minimum draught forward, the majority prefer the lesser of 0.03L or 8.0 metres with only one Member supporting the lesser of 0.025L or 8.0 metres. Only one Member supported DNV's modified proposal for a minimum draught of the lesser 0.00015*L*L or 8.0 metres.</p> <p>4. Accordingly, I propose that the requirement to be submitted to Council should be for a minimum draught forward of the lesser of 0.03L or 8.0 metres.</p> <p>5. Mr Han is requested to prepare a clean and underlined texts of UR S25 incorporating the above requirement, together with the other amendments agreed by Members.</p> <p>6. Members will be requested to approve the revised text for submission to Council within one week of its' circulation by Mr Han.</p>	
<p><b>4.4.1(b) last para. (cont'd)</b></p>	<p>(NKp) 1. Reference is made to my message NKO of 28 Aug 02, Arve's message NVk and Steve's message ABI of 29 Aug 02 as well as the other earlier messages.</p> <p>2. I welcomed the message of Steve in particular the paragraph 3. I noted that ABS couldn't accept the 0.025L formulation. I hope that the position of ABS has carried out ramification study of smaller bulk carriers of the present design and possibly future ones. NK has difficulty in accepting the application of the greater of 0.003L or 8m for all length of bulk carriers. As communicated in my message NKn and NKO this Society supports the minimum requirement proposed by DNV in NVj of 20 Aug 02. In this connection I would like to offer the following comments.</p> <p>2.1 Maneuverability of bulk carriers in sea condition is to be maintained by ahead propulsion and speed. I fully agree with DNV in NVk that frequent slamming if happens during heavy weather would induce the ship speed to be reduced beyond those restrictions. Proper forward draft that eliminates such situation to happen and sufficient propeller immersion helps to maintain ahead speed. The latter is already included in the UR S25 in the original version and no change has been proposed. Therefore it is considered accepted by all Members.</p> <p>2.2 Forward draft and slamming are to be considered in a package for achieving fit for purpose design. The matter of strengthening forward bottom against slamming has already been dealt with by the revised text of paragraph 4.4.2(a)i by the discussion so far. Now the forward bottom is to be strengthened against slamming in normal ballast condition. Therefore the forward bottom is considered strong enough for voyages in heavy ballast condition, i.e. in greater forward draught. The amount of forward draught necessary in heavy ballast condition has been discussed during the past month from various angles. It was the general agreement that in the present design practice bulk carriers of certain length and above have a ballast hold without being regulated, which demonstrate that designers and shipowners agreed a need of greater forward draught than that of normal ballast and utilised a cargo hold for ballast purpose. Due to strength consideration the ballast hold is full when used for heavy ballast condition. The consequential ballast condition demonstrated to have provided sufficient forward draught for unrestricted voyages. The forward draught proposed by DNV in NVj has been tested in bulk carriers of the present design. It was found that for Panamax and Capesize bulk carriers a ballast hold would be fitted to satisfy the requirement and commercial demand of grain capacity. For other bulk carriers there are some bulk carriers in particular smaller ones that satisfy the forward draught requirement in heavy ballast condition without fitting ballast hold. The relevant risks of this design relevant to forward bottom and propeller immersion are now addressed by the UR S25 by means of the requirements for strengthening of forward bottom against slamming in normal ballast condition and the requirement of the heavy ballast condition.</p> <p>2.3 Now with regard to the enquiry of Arve in NVk the data provided in the attachment to my last message NKO derived from NK's extensive study carried out on ship's maneuverability and sea keeping in heavy weather conditions with regard to deck wetness due to green sea loading, exposure of forward bottom, propeller racing, etc. Sixteen bulk carriers of all range of the sizes were used for the study. From that study it is known that ship masters take actions as they feel it necessary in heavy weather condition when for example exposure of forward bottom takes place several times per hour and/or ten times of shipping green sea on</p>	

<b>4.4.1(b) last para. (cont'd)</b>	<p>bow deck per hour.</p> <p>2.4 From the analysis NK was successful in establishing significant wave height in head sea condition when exposure of forward bottom takes place several time per hour. The information was super imposed on the diagram of the bow draught proposed by DNV as provided in the attached to the message NKo.</p> <p>2.5 I do not want to open a debate on the outcome of the study but am pleased to point out that the bow draught requirement proposed by DNV matches the trend of the significant wave heights that causes exposure of forward bottom at several times per hour, over which shipmasters takes action for reducing bow exposure such as reducing head speed, changing bearing, etc.</p>		
	<p>(NKq) 1. NK's comment in NKp of 30 August crossed the Chairman's message lGe of the same day.</p> <p>I appreciate the action taken by the Chairman in summing up the discussion during the past month for the revision of UR S25 with a view to achieving the final agreement of the revised text for submission to Council. I also appreciate Mr Han in taking the role for type setting the final draft revision.</p> <p>2. With regard to the provision of heavy ballast condition I do not quite agree with the Chairman's sum-up. There were two approaches, one proposed by ABS for requiring a mandatory ballast hold for bulk carriers of certain length and above and the other proposed by DNV for introducing minimum forward draught in the heavy ballast condition in UR S25.</p> <p>3. Thanks to the message of Steve in ABI of 29 August all commenting members agreed to specify the design minimum forward draught in heavy ballast condition. However the requirements for the amount of the forward draught were divided in two ways. This matter as far as I see is yet to be concluded and should be further discussed and concluded by explicit comments.</p> <p>4. I therefore request Mr Chairman and Mr Han to put the two proposals given below in square brackets in the final draft text to be circulated to GPG for consideration and decision by GPG, i.e. the last paragraph of section '4.4.1(b) Heavy Ballast Condition' should read as;</p> <p>"The draught forward is not to be less than the smaller of [<math>k \cdot L</math> and 8.0 metres, <math>k</math> being <math>0.00015 \cdot L</math> but is not to be taken less than 0.025 and need not to be taken larger than 0.03][0.03L and 8 meters]."</p>		
	<p>(RIe) Please note that RINA was in favour of supporting ABS/BV position not to accept bulk carriers without ballast hold.</p> <p>However, following the majority of Members, we can accept DNV's figures, i.e. the smaller of 0.03 L or 8 m.</p>		
	<p>(IAd) Reference is made to GPG Chairman's mail 0120glGe dated 30 August 2002.</p> <p>Attached herewith please find the final text of UR S25 incorporating the agreed changes and Chairman's conclusions.</p> <p>GPG Chairman invites Members to confirm their agreement to the attached document by 10 September after which the documents will be submitted to Council for final approval.</p> <p>Concerning 4.4.1(b)v, Mr.Jin's suggestion to put "<math>k \cdot L</math> and 8.0 meters, <math>k = , , , ,</math>" in square brackets was not supported by ABS and BV, however, it is reflected in the TB.</p> <p>Permsec wrote the TB in such a way that it did not lose members' valuable comments even if they were not agreed by the majority.</p> <p>Members' approval is sought by 10 September.</p>		
	<p>(BVd) Taking into account the support of the vast majority of members for the DNV proposed solution (the smaller of 0.03 L or 8 m) , please note that BV can accept this formulation, even if we still prefer not to accept bulk carriers without ballast hold.</p> <p>We do not support the proposal of NKq to put the solution of "0.025 L" between square brackets, as this solution is unacceptable for us and is not the solution supported by the majority of members.</p>	<p>(ABm) The views expressed by Maurice in BVd, 3 Sept, are fully supported.</p>	

<b>4.4.1(b) last para. (cont'd)</b>	<p>(CCc) 1. Reference is made to IAd of 4 September 02. 2. Please be informed that CCS can support DNV's proposal, i.e.the smaller of 0.03L or 8m. 3. The draft URS25 as attached to IAd is acceptable to CCS.</p>		
<b>4.4.2</b>	(Rlc) We also agree with ABS's proposal for strength requirements in 4.4.2 (tanks 100% full). However, in order to make 4.4.2 fully in line with UR S11.2.1.2, we propose that the following sentence be added before 4.4.2(a): "The longitudinal strength is to be checked for all the partial filling of tanks that may be partially filled or empty during navigation."		The comment is agreed and appreciated However, in ABg the change was made to 4.4.1(a) i and 4.4.1(b) i since partially full BWTs are addressed in these locations and RI suggested changes will be more appropriate if made therein.
	(Rld) Although understanding Mr. McIntyre's considerations, we deem it relevant to strength requirements and strictly connected with the modifications proposed by Mr. Myklebust.		For reason indicated earlier and as supported by NVf, the reference to S11.2.1.2 is retained in 4.4.1(a) i and 4.4.1(b) i.
	(NVf) we do not see the reason for moving the reference to S11.2.1.2 from 4.4.1(a)i. and 4.4.1(b)i. to 4.4.2(a)iii. and 4.4.2(b)ii. S11.2.1.2 refers to partially filled tanks which are allowed in the conditions defined in 4.4.1, and the reference (if at all necessary) should be included here.		See above
	(NVh) 4.4.2(a) & 4.4.2(b) Longitudinal strength requirements must apply to both the condition with empty/partially filled ballast tanks and the condition with 100% full ballast tanks. See proposed wording in NVd.		See above
<b>4.4.2(a) i</b>	(NKj) 4.4.2(a) i needs clarification as the ballast tank filling rate contained in the main body of paragraph 4.4.2 may not be applied in the subsequent ballast conditions. I therefore would like to propose to modify 4.4.2(a) i. as follows. "the structures of bottom forward are to be strengthened in accordance with the Rules of the Society against slamming for the condition of 4.4.1(a) at the lightest forward draught, unless the condition that all ballast tanks as designated in 4.4.1(a) are to be 100% full is specified in the loading manual for this condition."		ABh now reads as follows: i. the structures of bottom forward are to be strengthened in accordance with the Rules of the society against slamming for the condition of 4.4.1(a) at the lightest forward draught, and
	(LRb) The clarification given in 0120gNKj is supported.		See above reply
	(Nve) We agree that item 4.4.2(a)i is unclear, but at the same time we do not fully understand the meaning of the text proposed in 0120gNKj. We do, therefore, believe that a complete reorganizing of 4.4.2 will give better clarity than the proposal in 0120gNKj, ref. our suggestion in 0120gNVd of 12-08.		(ABi) I think the version of 4.4.2(a)i in ABh, has the same effect as what DNV proposed.
<b>4.4.2(b) last sentence</b>	(NVd) Delete the last sentence.	(ABi) ABS cannot accept the DNV proposal to delete the last line of 4.4.2(b). If more than one ballast hold is designated for carriage of water ballast at sea, then the longitudinal strength needs to be checked with the ballast tanks full and each one of the designated ballast holds full, one by one, to ensure that the ship has adequate strength should any one of the designated ballast holds indeed be filled at sea. If there are two designated ballast holds for water ballast at sea, then two conditions have to be checked. It would, to our understanding, rarely be more than that.	

<b>4.4.2(b) last sentence (cont'd)</b>	<p>(NVh) Same comment as for 4.4.2(a). The last sentence still seems unclear. If the sentence implies that several heavy ballast conditions are required for bulkcarriers having more than one ballast hold, we disagree. One heavy ballast condition should be the minimum IACS requirement. The owner/designer may of course specify other heavy ballast conditions if they so desire, in that case such conditions are to be approved, ref. S25 1.2. That is why we have in NVd proposed to delete the last sentence.</p>	<p>(ABj) In reply to NVh and NKK, both 15 Aug: 2. Re the proposals to delete the last sentence of 4.4.2(b), we do not agree. The sentence does not imply that several heavy ballast conditions are required. Rather, if more than one ballast hold is designated by the designer/owner in the operating manual for the carriage of water ballast at sea, it must be that the master is allowed and may at some time to fill each such ballast hold, at least individually, while at sea. The purpose of the last sentence is to require that the longitudinal strength be checked for such conditions with all the other ballast tanks full--so as to ensure that the S11 criteria will not be exceeded in such conditions, and for the same reasons that we are requiring that the strength check be done with all the ballast tanks full for the normal ballast condition, even if the "all tanks full" condition is not given in the loading manual as the normal ballast condition. These are checks to ensure that strength criteria will not be exceeded if all the ballast tanks plus each ballast hold designated for carriage of water ballast at sea are full. We have modified the text slightly to try to make this clearer ( see attachment).</p>
	<p>(NKK) Comments to ABS comments in ABg (<i>sic</i>; ABi) -1. 2.2.2 Paragraph 4.4.2(b) I support DNV's proposal to delete the last line of 4.4.2(b) because of the following reasons. - Where a bulk carrier is provided with two ballast holds for carriage of water ballast at sea, three permutations of each ballast hold being filled are considered. In this situation, it is to be left to owner's decision based on operational convenience which permutation is used to achieve the required heavy ballast condition. - We have no reason to force the two ballast holds be filled at the same time as the heavy ballast condition during voyage because of the two ballast holds being fitted. This means that both of two heavy ballast conditions (one ballast hold is full but another is empty and vice-versa) are not necessarily needed to meet the heavy ballast condition.</p>	<p>(ABj) See above</p>
	<p>(NKI) NK supports the modification proposed by Mr Myklebust in NVd of 12 Aug 02 with regard to the last sentence of paragraph 4.4.2(b) Heavy ballast condition, i.e. deletion of the sentence "In such instance, the longitudinal strength is to be satisfactory at least for each condition with one such hold full and all others empty" as this matter is regulated in paragraph 4.4.2(b) sub-paragraph i in the text contained in NVd.</p>	<p>See ABk below</p>

<p><b>4.4.2(b)</b> <b>last</b> <b>sentence</b> <b>(cont'd)</b></p>	<p>(NVi) 2. Number of ballast holds and heavy ballast conditions          There is a tendency that modern bulkcarrier designs are provided with more than 1 ballast hold, normally when specified by the shipowner. We have even seen bulkcarriers with every second hold [holds 2, 4, 6, ...] designated as ballast holds. The reasons may be:</p> <ul style="list-style-type: none"> <li>* to provide increased strength of watertight bulkheads,</li> <li>* to provide increased flexibility to take part loads into a minimum number of holds</li> <li>* to provide effective ballast water management [eg. Sediment management] procedures</li> <li>* others.</li> </ul> <p>To require longitudinal strength check for any one of these ballast holds to be full while all others are empty, would discourage such excellent solutions, which we believe should not be the effect of IACS requirements. We would therefore reiterate that IACS should require only one heavy ballast condition. It should in this connection be recalled that:</p> <ul style="list-style-type: none"> <li>* Owners/designers will have the option to specify additional heavy ballast conditions if they so desire, which have to be submitted for approval, ref. S25.1.2.</li> <li>* All ballast holds [irrespective of how many are provided] are to be checked for local strength, ref. S25.5.5</li> <li>* The master has, irrespective of the loading conditions specified in the loading manual, the freedom to load [including ballast] the vessel differently, provided limitations for longitudinal and local strength as defined in the loading manual and loading instrument onboard are not exceeded, ref. S25.1.3. No difference should be made between cargo and ballast in this connection.</li> </ul>	<p>(ABk) We do not agree that specifying water ballast to obtain increased scantlings of bulkheads is a proper way of design. Our point is that if a hold is designated for at-sea ballast, the longitudinal strength should be sufficient for the intended service. It is to be recalled that the original request from the industry was (and still is, we believe) to eliminate operating restrictions as much as possible, and by specifying the condition of approval, we will not require special notations for the loading restrictions. Without the last sentence of 4.4.2(b) a restricted ballasting notation will be required. We do not believe that requiring longitudinal strength check for one hold ballasted condition will in any way discourage any other arrangement that is permitted under S25.1.2.</p>
	<p>(BVc) 2. Longitudinal strength if more than one ballast hold is fitted – UR S25 4.4.2 (b)          It is not requested to have more than one ballast hold. However, if more than one is effectively designated for ballast, it must be possible to use each of them while satisfying the longitudinal strength criteria. We understand that some ballast holds can be only used in ports or sheltered areas for air draft reasons, but in this case they are not intended for " carriage of water at sea". So the ABS text is supported by BV.</p>	<p>(ABi) we appreciate and fully support the arguments and additional points provided in Maurice's message BVc, 23 Aug</p>
<p><b>4.5</b></p>	<p>(NVd) Replace "bunker full (normally 95% fuel oil) and other" with "all"</p>	<p>(ABi) we do not believe it either realistic or prudent to define the departure condition to be "100%". Fuel oil tanks are never, in practice, filled 100% full owing to the dangers of overflow and spillage associated with expansion. Designers have already questioned whether "100% consumables" means "bunkers 95% full and other consumables 100%", in accord with normal design practice. We agree with them and believe it clearer for everyone and more prudent to state this clearly in the UR. Therefore, we do not agree to revert to the less clear and wholly hypothetical "100% consumables" ---which would very likely be interpreted to be "bunkers 95% full and other consumables 100%" in actual practice by many. It is better to state this accepted and expected "interpretation" as the requirement.</p>
	<p>(NKK) I support ABS proposal of departure condition with bunker full (normally 95% fuel oil).</p>	<p>Noted with thanks</p>
	<p>(NVi) 3. Departure condition          We certainly agree that bunker tanks will not be 100% full in normal operation. However, the intent of S25 has never been to define how bulkcarriers shall be operated. The sole purpose of S25 is to ensure that the strength envelope is sufficiently wide for bulkcarriers to be fit for purpose. For this reason a number of design loading conditions have been defined, all of which from a</p>	<p>(ABk) with respect to "departure conditions", we would not object to the proposed wording if it is acceptable to all other societies but would suggest, to eliminate dead meat,</p>



	<p>strength point might be seen to be somewhat severe as compared to actual operating conditions.</p> <p>SC/BCS has adopted the term 100% full throughout S25 on purpose, both as regards cargo holds, ballast holds, ballast tanks and fuel oil tanks [re fuel oil tanks the term 100% full is applied several times also in section 5].</p> <p>The only advantage we can see for applying less than 100% bunker in the departure condition is to reduce maximum still water bending moment [in eg the normal ballast condition with all ballast tanks 100%], and saving some steel for the builder, which is contrary to the intent of S25. Trim considerations are no longer a problem after allowing empty and/or partially filled tanks in the ballast conditions</p> <p>To maintain the SC/BCS intent and the integrity of S25 we would prefer to retain 100% consumables [including bunker] in the departure condition.</p> <p>However, the capacity which shall be used under S25 must represent the maximum filling for the ship's operation. We will therefore propose a slight amendment to item 4.5: "Departure condition with bunker tanks at maximum capacity, in any case not less than 95% full, and other consumables 100%....".</p>	<p><b><i>"Departure condition: with bunker tanks not less than 95% full and other consumables 100%..."</i></b></p> <p>For the record, it is to be noted that by changing from the "MARPOL condition" (no consumable) to arrival condition (10% consumables), SC/BCS de facto eased the propeller immersion requirement but tightened the forward draft requirement. We believe this decision was made based on the present design conditions rather than a fictitious condition for 100% full bunker tanks.</p>
	<p>(BVC) Bunker departure condition - UR S25 4.5</p> <p>The proposal of DNV (0120gNVi, last sentence) is supported.</p>	<p>Noted</p>
<b>5</b>	<p>(ABh) (In conjunction with change to 2.2) Change title of 5 to "Design loading conditions (for local strength)</p>	<p>Proposed in ABh.</p>
<b>None</b>	<p>(IAC) With regard to ABg (and item 1b of ABd) with respect to a task to determine all parameters and corresponding criteria to ensure safety in heavy ballast condition, may the Secretariat suggest that early input be sought also from the Nautical Institute and from IFSMA? They are at the same address and would no doubt consult each other.</p> <p>An extract from the NI's book 'Bulk Carrier Practice' is attached.</p>	<p>-</p>

**0120g CORRESPONDENCES AFTER ABd, 22 July 2002**

	IA	IG	ABS	BV	CCS	DNV	GL	KR	LR	NK	RI	RS
a												
b		23 July 02		29 July 02	6 Aug 02 13 Aug 02 (b-bis)		1 Aug 02		12 Aug 02			
c	9 Aug 02	8 Aug 02		23 Aug 02	4 Sep 02	23 July 02	6 Aug 02	24 July 02	22 Aug 02		1 Aug 02	
d	3 Sep 02	15 Aug 02	22 July 02	3 Sep 02		12 Aug 02	14 Aug 02	1 Aug 02			13 Aug 02	
e		30 Aug 02	23 July 02			14 Aug 02		23 Aug 02			3 Sep 02	
f			31 July 02			14 Aug 02						
g			8 Aug 02			?				23 July 02		
h			13 Aug 02			15 Aug 02				24 July 02		
i			14 Aug 02			19 Aug 02				1 Aug 02		
j			15 Aug 02			20 Aug 02				9 Aug 02		
k			21 Aug 02			29 Aug 02				15 Aug 02		
l			29 Aug 02							16 Aug 02		
m			3 Sep 02							20 Aug 02		
n										23 Aug 02		
o										29 Aug 02		
p										30 Aug 02		
q										2 Sep 02		

## UR S26 “Strength and Securing of Small Hatches on the Exposed Fore Deck”

### Summary

The sentence has been added to specify that small hatches regarded as a non-weather-tight hatch according to UI LL64 are not subject to UR S26.

### Part A. Revision History

Version no.	Approval date	Implementation date when applicable
Rev.5 (May 2023)	11 May 2023	1 July 2024
Rev.4 (May 2010)	24 May 2010	-
Rev.3 (Aug 2006)	7 August 2006	1 July 2007
Rev.2 (July 2004)	5 July 2004	-
Rev.1 (Nov 2003)	7 November 2003	-
NEW (Nov 2002)	29 November 2002	1 January 2004

#### • Rev.5 (May 2023)

##### 1 Origin for Change:

- Suggestion by IACS member

##### 2 Main Reason for Change:

A Member raised an issue regarding a possible need for amendment of UR S26 “Strength and Securing of Small Hatches on the Exposed Fore Deck” in connection with UI LL64 “Non-weather-tight hatch covers above superstructure deck (Load Line Convention 1966 Regulations 2(5) and 14(2))”.

In case of containerships, non-weather-tight hatches can be accepted based on complying with the relevant requirement in UI LL64. For this reason, small hatches on containerships complying with the relevant requirements of the UI also can be non-weather-tight. Considering that the requirements in UR S26 are applied to small hatches capable of being closed weather-tight or watertight, small hatches regarded as a non-weather-tight hatch according to UI LL64 is not subject to this UR S26.

However, the requirements of clauses 4 & 5 of the UI cannot practically be applied due to the feature of small hatches, so it is decided that those are excepted.

Regarding the clause 6 in the UI LL64 for scantlings, since it is also practically difficult to be applied to small hatches while the scantling requirements for the hatches are needed, the Chair proposed the phrase of “However, for scantlings of small hatches the strength requirements in clause 4 of this UR could be applied instead of clause 6 of UI LL64.”

### **3 List of non-IACS Member classification societies contributing or participating in IACS Working Group:**

None

### **4 History of Decisions Made:**

A Member raised an issue regarding a possible need for amendment of UR S26 in connection with UI LL64.

Hull Panel Chair reviewed two resolutions and shared an opinion that UI LL64 is only applicable to containerships with a number of additional conditions. Hence UI LL64 has a quite narrow field of applicability compared to the more general applicability of UR S26. Hull Panel decided to make a cross reference from UR S26 to UI LL64 for the case of Containerships.

At the same time Hull Panel Members asked for consultation of Safety Panel if the relaxation from weathertightness given in UI LL64 also can be applied to small access hatches on containerships located at the same deck and position as the cargo hatchways considering the relevant requirement in UI LL64. Majority of Safety Panel members agreed to the conclusion from Hull Panel.

Considering Hull Panel's conclusion and Safety Panel's discussion, Hull Panel Chair has prepared the draft UR S26 (Rev.5) and its associated TB. Some members pointed out the issues of which the requirements of clauses 4 & 5 of the UI LL64 cannot practically be applied due to the feature of small hatch, so it is decided that those are excepted.

Regarding the clause 6 in the UI LL64 for scantlings, since it is also practically difficult to be applied to small hatches while the scantling requirements for the hatches are needed, the Chair proposed the phrase of "However, for scantlings of small hatches the strength requirements in clause 4 of this UR could be applied instead of clause 6 of UI LL64."

### **5 Other Resolutions Changes:**

None

### **6 Any hinderance to MASS, including any other new technologies:**

None

### **7 Dates:**

Original proposal:	10 November 2022	<i>(made by a Hull Panel Member)</i>
Panel Approval:	24 April 2023	(Ref: 23058_PHa)
GPG Approval:	11 May 2023	(Ref: 23058_IGb)

- **Rev.4 (May 2010)**

**1 Origin for Change:**

- Based on IACS Requirement (*Common Structural Rules for Bulk Carriers and Double Hull Oil Tankers*)

**2 Main Reason for Change:**

Following the introduction of the IACS Common Structural Rules for Bulk Carriers and Double Hull Oil Tankers, Hull Panel were tasked to review all the UR S files to consider whether or not they are applicable to ships covered by the CSR.

**3 List of non-IACS Member classification societies contributing through the TC Forum and/or participating in IACS Working Group:**

None

**4 History of Decisions Made:**

After review it was decided that for CSR ships the requirements of UR S26 are superseded by those of the Common Structural Rules and therefore do not apply.

**5 Other Resolutions Changes**

All UR S files, except UR S8, S9, S15, S16, S19, S22, S23, S30 and S31.

**6 Dates:**

Original proposal: 2007, made by Hull Panel Task 50  
Panel submission to GPG: 19 April 2010  
GPG Approval: 24 May 2010 (Ref. 10051\_IGd)

- **Rev.3 (Aug 2006)**

See TB document in Part B.

- **Rev.2 (July 2004)**

Addition of 'Contracted for Construction' footnote – no TB document available.

- **Rev.1 (Nov 2003)**

See TB document in Part B.

- **New (Nov 2002)**

See TB document in Part B.

## **Part B. Technical Background**

List of Technical Background (TB) documents for UR S26:

Annex 1. **TB for Original Resolution (Nov 2002)**

See separate TB document in Annex 1.

Annex 2. **TB for Rev.1 (Nov 2003)**

See separate TB document in Annex 2.

Annex 3. **TB for Rev.3 (Aug 2006)**

See separate TB document in Annex 3.

**Note:** *There are no separate Technical Background (TB) documents for Rev.2 (July 2004), Rev.4 (May 2010) and Rev.5 (May 2023).*

## **UR S 26 Strength and Securing of Small Hatches on the Exposed Fore Deck** (New, Nov 2002)

### **Technical Background:**

This technical background (TB) is developed in line with Annex 2 of IACS Internal Information No. 15.

#### **1. Scope and objectives**

1.1 The reopened Derbyshire formal inquiry published its report in December 2000. Mr Justice Coleman's Recommendations are summarised in Section 14 of the report, in which there are a number of recommendations addressed to IACS and Classification Societies.

Further to the discussion at C42 in December 2000 where it was decided to form a Small Group in order to make proposals for the way forward on Mr Justice Coleman's Recommendations. Subsequently AHG/FDF was established to initially consider two issues, which were:

- Strength Requirements for Fore Deck Fittings and Equipment; and
- Prevention of Water Ingress through Fore Deck Openings

1.2 AHG/FDF considered amongst others prevention of water ingress through a small hatch on fore deck. The objective of this UR is to introduce knowledge of good seamanship in technical design thus to reduce risk of the small hatch cover being opened in heavy seas and consequential inadvertent water ingress into the space underneath.

#### **2. Points of discussions and possible discussions**

2.1 The investigation of Derbyshire showed that the hatch cover of small hatch (used as rope hatch) was torn off and considered to have allowed subsequent sea water ingress to the space underneath.

2.2 The AHG addressed deck height above Load Water Line where green water may wash over the fore deck, and technical aspects of securing devices of small hatch covers.

2.3 In regard to the deck height, analysis put forward by a member indicated that 0.1L or 22m was too conservative in particular for larger vessels. However the AHG considered it appropriate for the purpose of eliminating fore decks of pure car carriers that are clearly above green seas, also keeping in mind the damage case to the fore deck of the passenger liner QE2.

2.4 The AHG analyzed possible cases where a small hatch cover secured by butterfly nuts may be opened in heavy weather condition and arrived at a likelihood that the hatch cover is pressed down by green sea forces causing the butterfly nuts to loosen and consequently be dislodged. This assumption was considered realistic by a report that it was not difficult to dislodge tightened butterfly nuts by hammering it outward.

2.5 The Group considered a way out and came to a conclusion that there is a need of a secondary securing (locking) device that keeps the hatch cover in place even in such a case where the primary securing device was loosened or even dislodged.

2.6 The Group also considered that the hatch cover must have a metal to metal touch for preventing further compression by green sea forces. In the method using butterfly nuts for the primary securing device the group considered that over-tightening butterfly nuts causes permanent deformation (distortion) of forks (clamps), which allows the butterfly nuts to come off easily. Preventive measures were stipulated to the effect that the forks are of robust strength, and are curved upward or raised at the free end with a view to reducing the risk of the butterfly nuts being dislodged.

- 2.7 The group further considered that location of hinges of small hatch covers would play an important role to keep the cover in place in green water. It has come to the group's attention that on a few ships the hinges for a small hatch cover have been located on the far side from the direction of water flow, such that the action of green seas would tend to try to open the hatch, and at least in some cases the ship's crew have turned the cover around. The group did not believe that there is any international requirement that would prevent this and therefore IACS should consider introducing a paragraph to the effect that the hinges should be arranged such that the predominant direction of green water would cause the cover to close.
- 2.8 The group agreed that on the fore deck the hinges should be arranged on the fore side of the hatch. The model tests suggest that away from the centre line a 45 degree orientation could be theoretically better, but this requires proper arrangement of deck stiffening. For small hatches located between the main hatches (for example between Nos. 1 and 2) the hinges might be best placed on the outboard edge in beam sea and bow quartering conditions, while hinges on fore edge are also acceptable.
- 2.9 The group agreed that the ship type category, general dry cargo ship, was for the carriage of dry cargo loaded through hatch covers, and did not include special purpose ships such as Container Ships, Vehicle Carriers and Ro-Ro ships.
- 2.10 The AHG agreed that whilst the problem of securing small hatch covers mounted on the fore deck was identified during the Derbyshire RFA, the application of this UR should be for all types of new ships, to improve their common capability to resist green sea loads. The group therefore considers that National standards, ISO 5778 and the design practice for small hatch covers should be examined with regard to this UR, and that the cost of such improvement is small.
- 2.11 For the illustrative primary securing arrangement shown in Figure 2, the AHG considered the possible addition of a nut or double nut on the toggle to prevent the fork from being bent downwards, or to be used for locking the butterfly nut in position.

### **3. Source/derivation of proposed requirements**

- 3.1 The group established information regarding current industry standards and practices from national and international standards such as Japanese Industry Standards, Korean Industry Standards, DIN, Italian shipyards' practices and ISO standard.
- 3.2 The group identified three preferred types of securing devices. However, the group considered that there is a room of improvements. With regard to the widely used butterfly nuts the group felt a need to add a requirement such that butterfly nuts would not be dislodged by being loosened due to the effect of extra compression to gasket that may be caused by green sea forces. Metal to metal contact was introduced to achieve this level of security. This method was also made applicable to other preferred securing device such as quick acting cleats and central wheel locking device.
- 3.3 The group considered that a secondary locking device would improve securing small hatch covers in place even though such secondary device may not keep the hatch cover weather-tight. To that end the group considered that a backing bar or sliding bolt of slack fit would satisfy the objective. The group felt that specific technical requirement can be left to innovation of designers and shipyards.
- 3.4 Structural requirements for the small hatch cover were based on a design pressure of 150 kPa. This pressure was considered suitable for the fore deck from information provided by AHG/WD-SL to AHG/EBC (reference UR S21 Rev 1, July 2002), and corresponds to a position of about 0.04L from the forward perpendicular of a capesize bulk carrier. Plate thicknesses were derived from plastic criteria, while the stiffener requirements were assessed on elastic stresses. In view of easy



maintenance of these covers, a reduced corrosion allowance of 1 mm was included for the plate and 2 mm for the stiffeners. For the purposes of providing a simple and economical standard, this design is assumed to apply to all areas specified in clause 2.

#### **4. Decision by Voting if any**

The technical requirements in this proposed UR were considered by all members of the AHG and agreed unanimously. The implementation scheme, which is contained in square brackets, is to be decided by GPG.

Note by the permanent Secretariat

1. NK proposed an annotation to Figure 2 for the metal to metal contact. Council tasked the AHG to consider. As a result, para. 6.1 was modified and new para. 6.2 added. Item 9 of Figure 2 was annotated as "bearing pad welded on the bracket of a toggle bolt for metal to metal contact".

\*\*\*\*\*

## Technical Background

### S26 (Rev.1, Nov 2003) & S27(Rev.2, Nov 2003)

#### Part A: S26.2.2 (Rev.1, Nov 2003) + S27.2.2(Rev.2, Nov 2003)

##### 1. Objective:

To clarify the ships to which S26 and S27 shall apply.

##### 2. Points raised by BV (s/n 3142):

- .1 “Ore carriers” are not mentioned in S26/S27 para 2.2. It needs to be clarified.
- .2 “Refrigerated cargo ships, livestock carriers, deck ships, dedicated forest product carriers and dedicated cement carriers” do not seem to be excluded from the scope of application. It needs to be clarified.

##### 3. GPG Discussion

- .1 Failure to explicitly include “ore carriers” in the scope of application statements in S26/27 was just an oversight. It was agreed that “Ore carriers” should be explicitly mentioned.
- .2 The proposal to align the scope of application for “general dry cargo ships” with that of UR Z7.1 was not agreed. It would exempt more vessels from the application of S26/27. The scope of application of S26/S27 was based on considerations of freeboard – not on alignment with Z7.1 (3142\_ABc dated 29 September 2003).  
But, it was agreed to include “combination carriers(as defined in UR Z11)” in the scope of application of S26/S27 for clarity.

##### 4. Conclusion

- .1 Para 2.2 of S26 and S27 was amended to the above effect.
- .2 Council approved it on 7 Nov 2003.

**Part B: S27.5.1.1(Rev.2, Nov 2003)**

**1. Objective**

To clarify the scope of application of S27.5.1.1 to existing ships.

**2. Points raised by ABS (s/n 3059a):**

.1 ABS suggested that S27.5.1.1 does not mean that closing devices of air pipes (~~and ventilators~~ : *this wording "and ventilators" was deleted as UR P3 does not cover "ventilators"*) on all existing ships subject to S27 need to be upgraded to comply with the current UR P3. GPG agreed.

.2 GPG did not agree to the view that if an air pipe or ventilator closing device has to be replaced to comply with the other requirements of S27, the new closing device should comply with the current UR P3. (3059aABa, 25 July 2003)

NK pointed out that though some types of air pipe heads satisfying the requirements of UR P3(Rev.1) may be in the market it should be noted that a type of air pipeheads widely applied on board ships built in Asian builders is yet to fully comply the new requirement despite the effort of manufacturers. The identified problem is being addressed by the manufacturer and it is likely that an improved prototype is to be tested in a short time (3059aNKb, 3 Oct 2003).

**3. Conclusion**

.1 A footnote was added to S27.5.1.1 as indicated in para.2.1 above.

.2 Council approved it on 7 Nov 2003.

**End.**

Prepared by the Permanent Secretariat  
30 October 2003

## Technical Background of Revision to UR S26 (Rev.3)

### 1. Scope and objective

After the S26 (Rev. 2 July 2004) was implemented, there were the question, “For hatches designed for use of emergency escape, when fitted with central locking devices as stipulated in UR S26.5.1 (iii), they are usually fitted outside hatch covers and cannot be operated from inside. In this case, emergency escape becomes unrealistic, and securing devices that can be operated from both sides are to be fitted, for instance, dogs (twist tightening handles) with wedges as mentioned in UR S26.5.2.”(see Fig.1)

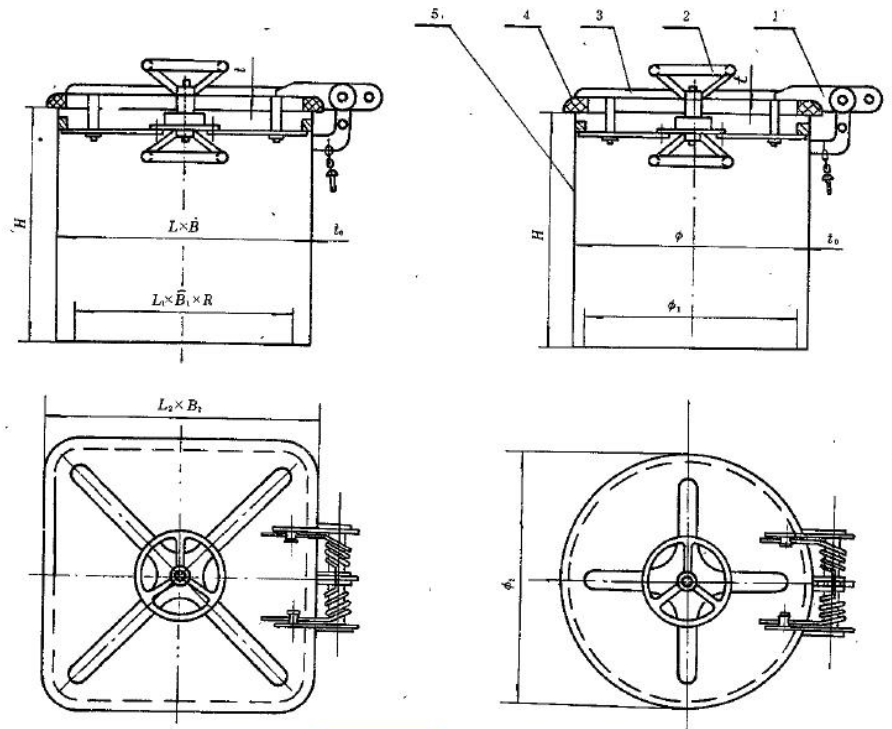


Fig.1 quick-acting type hatch cover

Having checked the plan review practice of each member society, it is confirmed that both sides operable weather-tight hatch covers are installed for emergency escape hatchways. Accordingly, it is concluded that the further clarification of the requirements of UR S26 will not have any impact to the industry practice and is more in line with the intent of the UR.

### 2. Points of discussions or possible discussions

The texts of S26.1.3 are modified as follows:

“Hatches designed for emergency escape need not comply with the requirements, 5.1 (i) and (ii), 6.3 and 7 of this UR. Securing devices of such hatches are to be of a quick-acting type (e.g., one action wheel handles are provided as central locking devices for latching/unlatching of hatch cover) operable from both sides of the hatch cover.”

### 3. Source/ derivation of proposed requirement

Hull Panel

### 4. Decision by voting

N.A.

Submitted by Hull Panel Chairman  
9 June 2006

**Permanent Secretariat's Note:**

- **GPG discussion (s/n 6124, 26 July 2006)**

All members supported the amendments to UR S26 and its TB.

8 members agreed to the proposed implementation statement. BV proposed a modification with a view to clarification on application of ship types by referring to item 2 of the UR, which was supported by KR. However the GPG Chairman considered that the original implementation statement was sufficient as the changes introduced in rev.3 of UR S26 (items 1.3 and 1.4), being part of the UR, will have to be implemented in accordance with the application provisions in item 2 of the UR anyway, in addition to its implementation schedule.

- **Council discussion**

All members supported the draft UR S26 (Rev.3) and its TB.

## UR S27 “Strength Requirements for Fore Deck Fittings and Equipment”

### Part A. Revision History

Version no.	Approval date	Implementation date when applicable
Rev.6 (June 2013)	25 June 2013	1 July 2014
Rev.5 (May 2010)	24 May 2010	-
Rev.4 (Nov 2004)	30 November 2004	-
Rev.3 (July 2004)	5 July 2004	-
Rev.2 (Nov 2003)	7 November 2003	-
Corr.1 (July 2003)	14 July 2003	-
Rev.1 (Mar 2003)	27 March 2003	-
NEW (Nov 2002)	29 November 2002	1 January 2004*

**\* Note:**

Actual implementation date is dependent on vessel age, therefore the resolution text should be consulted for full details.

#### • Rev.6 (June 2013)

##### .1 Origin for Change:

- Suggestion by IACS Member in Statutory Panel September 2011

##### .2 Main Reason for Change:

A question was raised in the Statutory Panel with background in approval of a car carrier for which design pressure in UR S27 became applicable to hold ventilator on the upper deck on large car carrier, almost 22 m above summer water line. This was considered unreasonable.

##### .3 List of non-IACS Member classification societies contributing through the TC Forum and/or participating in IACS Working Group:

None.

##### .4 History of Decisions Made:

After discussion within the Hull Panel, it was concluded that the pressure in UR S27 is to be modified to avoid unreasonable requirements e.g. for cargo hold ventilators on car carriers. It was agreed to prepare a transition of the pressure formula of S27.4.1.1 to eliminate the abrupt “on-off” application at 0.1L or 22m height above the summer load waterline.

##### .5 Other Resolutions Changes

None.

**.6 Dates:**

Original proposal: 2011, made by a Hull Panel member  
Panel submission to GPG: 05 June 2013  
GPG Approval: 25 June 2013 (Ref. 13145\_IGc)

- **Rev.5 (May 2010)**

**.1 Origin for Change:**

- Based on IACS Requirement (*Common Structural Rules for Bulk Carriers and Double Hull Oil Tankers*)

**.2 Main Reason for Change:**

Following the introduction of the IACS Common Structural Rules for Bulk Carriers and Double Hull Oil Tankers, Hull Panel were tasked to review all the UR S files to consider whether or not they are applicable to ships covered by the CSR.

**.3 List of non-IACS Member classification societies contributing through the TC Forum and/or participating in IACS Working Group:**

None.

**.4 History of Decisions Made:**

After review it was decided that for CSR oil tankers the requirements of UR S27 are superseded by those of the Common Structural Rules and therefore do not apply. For CSR bulk carriers the requirements of UR S27 concerning air pipes and ventilators still apply, but those for windlasses are superseded by the Common Structural Rules and do not apply.

**.5 Other Resolutions Changes**

All UR S files, except UR S8, S9, S15, S16, S19, S22, S23, S30 and S31.

**.6 Dates:**

Original proposal: 2007, made by Hull Panel Task 50  
Panel submission to GPG: 19 April 2010  
GPG Approval: 24 May 2010 (Ref. 10051\_IGd)

- **Rev.4 (Nov 2004)**

See TB document in Part B.

- **Rev.3 (July 2004)**

Addition of 'Contracted for Construction' footnote – no TB document available.

- **Rev.2 (Nov 2001)**

See TB document in Part B.

- **Corr.1 (July 2003)**

Editorial improvements/corrections – no TB document available.

- **Rev.1 (Mar 2003)**

See TB document in Part B.

- **NEW (Nov 2002)**

See TB document in Part B.



## Part B. Technical Background

List of Technical Background (TB) documents for UR S27:

Annex 1. **TB for Original Resolution (Nov 2002)**

See separate TB document in Annex 1.

Annex 2. **TB for Rev.1 (Mar 2003)**

See separate TB document in Annex 2.

Annex 3. **TB for Rev.2 (Nov 2003)**

See separate TB document in Annex 3.

Annex 4. **TB for Rev.4 (Nov 2004)**

See separate TB document in Annex 4.

Annex 5. **TB for Rev.6 (June 2013)**

See separate TB document in Annex 5.

An addendum to the Annex 5 (i.e. "7. Additional technical background 2021 – Application of green sea load on windlass") was introduced in March 2021 (Ref: 21026\_IGc)



**Note:** There are no separate Technical Background (TB) documents for Corr.1 (July 2003), Rev.3 (July 2004) and Rev.5 (May 2010).

## Technical Background

### UR S 27 (New, November 2002)

This technical background (TB) is developed in line with Annex 2 of IACS Internal Information No. 15.

#### 1. Scope and objectives

1.1 The reopened Derbyshire formal inquiry published its report in December 2000. Mr Justice Coleman's Recommendations are summarised in Section 14 of the report, in which there are a number of recommendations addressed to IACS and Classification Societies.

Further to the discussion at C42 in December 2000 it was decided to form a Small Group in order to make proposals for the way forward on Mr Justice Coleman's Recommendations. Subsequently AHG/FDF was established to initially consider two issues, which were:

- Strength Requirements for Fore Deck Fittings and Equipment; and
- Prevention of Water Ingress through Fore Deck Openings

1.2 This UR addresses recommendations 10 and 17 of the above report. During the RFA it was identified that the loss of rotating type ventilator heads on the fore deck was likely to have been one of the first events to have occurred in the ship loss sequence. Damage to air and vent pipes leading to further water ingress was also considered to have occurred. Evidence from the wreck further showed that the port windlass had been lost.

#### 2. Points of discussions and possible discussions.

2.1 AHG/FDF determined that increasing air or ventilator pipe thickness for the smaller sizes did not in general yield sufficient strength. Hence it was decided to require additional brackets, which allows the continuance in the main of current pipe thickness standards.

2.2 For ventilators, the forces acting on the closing device should be sustainable with the head in any open or closed position. The combination of horizontal forces, vertical forces and tilting moments acting on a rotating type mushroom ventilator head are such as to render this device unsuitable for application in the areas defined in clause 2 of the UR.

2.3 AHG/FDF considered that hidden corrosion in the bolts securing the windlass was a potential problem that required inspection. However as this could not be quantified for design purposes, nor can be easily inspected, the group considered that the required safety factor should take this into account. Hence a safety factor of 2.0 on bolt proof strength was agreed. Reference for the definition of bolt proof strength is ISO 898-1.

2.4 For the calculation of windlass forces in the direction of the shaft, a factor ' $f$ ' is included to simplify determination of the effective area exposed to the water flow, taking into consideration part shielding of one disc or component by another. A simple relationship as a function of  $B/H$  is determined, with a maximum value of 2.5

appropriate to a large multi-disc windlass. The applied pressure in this direction was also increased to reflect the greater shape coefficient of an actual windlass disc compared to the simplified outline shape used for the model tests.

- 2.5 The group agreed that the ship type category, general dry cargo ship, was for the carriage of dry cargo loaded through hatch covers, and did not include special purpose ships such as Container Ships, Vehicle Carriers and Ro-Ro ships.

### **3. Source/derivation of proposed requirements**

- 3.1 The group established information regarding current industry standards and practices from national and international standards such as Japanese Industry Standards, Korean Industry Standards, DIN, Italian shipyards' practices and ISO standard.
- 3.2 The velocity of water over the fore deck, and the pressures to be applied to the windlass were obtained from results of a program of sea keeping model tests of three bulk carriers conducted at MARIN (Ref. 1). AHG/WD-SL determined a water velocity over the fore deck of 13.5 m/sec (reference 'Amended formula for load model of UR S21', supplied to AHG/EBC July 2002). In these tests, the ship speed, even when operating at full engine power, was reduced by wave forces to be close to zero. The direction of water flow was found to be variable, depending on the ships heading, shape of the bow, location of the equipment etc. The requirements in the UR are therefore irrespective of any particular direction.
- 3.3 The shape factors for air or ventilator pipes and their closing device were based on the MODU code. The slamming factor was taken as that due to momentum. Resulting pressures were correlated with measurements from the above model tests, such that the combination of water velocity, slamming and shape factors corresponded to the maximum measured forces on a cylinder located on the fore deck, as supplied to the AHG. A further coefficient  $C_p$  provides for protection from a breakwater or forecastle, but not from the bulwark. The model tests showed that a large wall of water is formed by the presence of the ship's bow, and collapses onto the deck immediately behind the bulwark. The slope of the bulwark then tends to direct the water onto any pipes or fittings located behind, and thus effectively gives little protection in extreme seas.
- 3.4 Measured forces on the windlasses were supplied to the AHG, as obtained directly from the above sea keeping model tests. The pressure to be applied to the windlass perpendicular to its shaft was obtained from the maximum measured force in this direction divided by the projected area. The maximum measured force parallel to the shaft leads to a nominal pressure of about 100 kPa, but in recognition of the much increased resistance to flow in this direction for a real windlass compared to the idealised and smooth model, this was increased to 150 kPa. It was also found from comparing significant values of forces that differences between intact and flooded conditions were not large.

### **4. Decision by Voting if any**

The technical requirements in this proposed UR were considered by all members of the AHG and agreed unanimously. The implementation scheme, which is contained in square brackets, is to be decided by GPG.

Note by the Permanent Secretariat

1. As the 1966 Load Line uses “ventilators” in Regulation 19, the term “vent” was replaced by “ventilator” except in 5.1.5 and 5.1.6 where “vent pipes” was replaced by “ventilators”.
2. Council agreed that a note should be added to Table 1 and 2 for other air pipe / ventilator heights.
3. For pipe diameter 40A and 50A in Table 1, a note was added  
“Not permitted for new ships – reference UR P1”.
4. New sentence 1.3 was added to take account of the integrated windlass & winch type of design.
5. Implementation scheme was harmonized with that of URs S 31 and S 26.
6. Date of approval: 14 November 2002 (2219\_ICd).

**References <sup>1)</sup>:**

1. Seakeeping Tests for a Capesize Bulk Carrier – Phase 1, MARIN Report No. 16548-1-SMB November 2000.
2. Seakeeping Tests for a Capesize Bulk Carrier – Phase 2. MARIN Report No. 16541-1-SMB February 2002
3. Seakeeping Tests for a Panamax Bulk Carrier – Phase 3. MARIN Report No.16635-1-SMB February 2002.

● \* \* \* \*

Submitted by the AHG/FDF Chairman  
29 July 2002

## Technical Background

### UR S 27 (Rev.1, March 2003)

This technical background (TB) is developed in line with Annex 2 of IACS Internal Information No. 15.

#### 1. Scope and objectives

To provide more flexibility to the designer for air pipes and ventilators.

#### 2. Points of discussions and possible discussions.

The AHG/FDF Chairman reported on 10 March 2003:

In 4.1.1, two values are defined for the shape coefficient  $C_d$ , namely 0.5 for pipes and 1.3 for the heads of air pipes or ventilators. Mr Cooper, ABS has raised the possibility that in order to reduce loads, a vent head may in some circumstances be designed of cylindrical form with its axis in the vertical direction. In this circumstance, the value of 1.3 which is applicable to heads with plane side surfaces becomes rather severe. However, on the other side, the value of 0.5 would not account for the effect of disturbed water flow around a short cylinder.

The Chairman AHG/FDF suggested the following in order to give more flexibility to the designer.

$C_d$  = shape coefficient  
 (~~0.5 for pipes and 1.3 for air pipe or ventilator head~~)  
 = 0.5 for pipes, 1.3 for air pipe or ventilator heads in general, 0.8 for an air pipe or ventilator head of cylindrical form with its axis in the vertical direction.

GPG/Council approved on 24 March 2003.

• \* \* \* \*

25 March 2003

## Technical Background

### S26 (Rev.1, Nov 2003) & S27(Rev.2, Nov 2003)

#### Part A: S26.2.2 (Rev.1, Nov 2003) + S27.2.2(Rev.2, Nov 2003)

##### 1. Objective:

To clarify the ships to which S26 and S27 shall apply.

##### 2. Points raised by BV (s/n 3142):

- .1 “Ore carriers” are not mentioned in S26/S27 para 2.2. It needs to be clarified.
- .2 “Refrigerated cargo ships, livestock carriers, deck ships, dedicated forest product carriers and dedicated cement carriers” do not seem to be excluded from the scope of application. It needs to be clarified.

##### 3. GPG Discussion

- .1 Failure to explicitly include “ore carriers” in the scope of application statements in S26/27 was just an oversight. It was agreed that “Ore carriers” should be explicitly mentioned.
- .2 The proposal to align the scope of application for “general dry cargo ships” with that of UR Z7.1 was not agreed. It would exempt more vessels from the application of S26/27. The scope of application of S26/S27 was based on considerations of freeboard – not on alignment with Z7.1 (3142\_ABc dated 29 September 2003).  
But, it was agreed to include “combination carriers(as defined in UR Z11)” in the scope of application of S26/S27 for clarity.

##### 4. Conclusion

- .1 Para 2.2 of S26 and S27 was amended to the above effect.
- .2 Council approved it on 7 Nov 2003.

**Part B: S27.5.1.1(Rev.2, Nov 2003)**

**1. Objective**

To clarify the scope of application of S27.5.1.1 to existing ships.

**2. Points raised by ABS (s/n 3059a):**

.1 ABS suggested that S27.5.1.1 does not mean that closing devices of air pipes (~~and ventilators~~ : *this wording "and ventilators" was deleted as UR P3 does not cover "ventilators"*) on all existing ships subject to S27 need to be upgraded to comply with the current UR P3. GPG agreed.

.2 GPG did not agree to the view that if an air pipe or ventilator closing device has to be replaced to comply with the other requirements of S27, the new closing device should comply with the current UR P3. (3059aABa, 25 July 2003)

NK pointed out that though some types of air pipe heads satisfying the requirements of UR P3(Rev.1) may be in the market it should be noted that a type of air pipeheads widely applied on board ships built in Asian builders is yet to fully comply the new requirement despite the effort of manufacturers. The identified problem is being addressed by the manufacturer and it is likely that an improved prototype is to be tested in a short time (3059aNKb, 3 Oct 2003).

**3. Conclusion**

.1 A footnote was added to S27.5.1.1 as indicated in para.2.1 above.

.2 Council approved it on 7 Nov 2003.

**End.**

Prepared by the Permanent Secretariat  
30 October 2003

## **Technical Background**

### **UR S 27 (Rev. 4, Nov. 2004)**

#### **1. Objective**

To add a footnote to UR S 27 clarifying that UR S27 does not apply to the cargo tank venting systems and the inert gas systems of oil tankers.

#### **2. Background**

According to NK, the AHG/FDF had previously agreed that S27 was not applicable to dedicated cargo tank venting systems (3059bNKa, 24 September 2004).

#### **3. Discussion**

- 3.1 BV suggested that the oil tankers are submitted to the same sea condition than sustain by the bulk-carriers; so logically all vent pipes situated in the fore quarter of the existing oil tankers can be subject also to sea damages.

Therefore, these pipings should comply with UR S27, unless it is demonstrated by statistics that no damage occurred on forward part of the oil tanker in the same or less sea condition than encountered by the "Derbyshire" and there was no oil pollution consecutive to these damages (3059bBVa, 27/09/2004).

- 3.2 Members expressed the view that if the tanker's venting systems are to comply with UR S27, it should be demonstrated by statistics that there were reported damages on forward part of oil tankers. NK had not seen any such damage reports (3059bNKb, 01/10/2004).
- 3.3 Tanker vent masts are quite substantial structures owing to other design requirements and we are not aware that there is a history of wave damage of such structures (3059bABa, 01/10/2004).
- 3.4 GPG agreed to add a note to achieve the above objective.
- 3.5 Council confirmed that S27 is not applicable to the cargo tank venting and inert gas systems on all ~~oil~~-tankers. Approved on 30 November 2004(3059bICb).

29 October 2004  
Prepared by the Permsec



## Technical Background Document

### UR S27, Rev. 6 (June 2013)

#### 1. Objective/Scope

According to UR S27 the dimensioning velocity  $V$  of water over the fore deck is 13.5 m/s for exposed items located less than 22m or 0.1L (whichever is the lesser) above the summer load waterline. The objective of this document is to adjust the velocity  $V$  to be applied in S27-4.1.1 taking the actual height of the item into account.

#### 2. Source of Proposed Requirements

The proposed requirements are based on the technical justifications for the current requirements, current practice within industry, and discussion within the Hull Panel (via correspondence and at Hull Panel Meetings).

#### 3. Technical Basis and Rationale

1. Items located higher than 22m or 0.1L above the summer load waterline, whichever is the lesser, will not experience impact loads. We will refer to this limiting height of items as  $d_1$ . The background for this limiting height is not available. Taking the relevant probability level into account it is very difficult to define the limiting height based on model tests (or full scale measurements) even for very comprehensive tests. The limiting height is associated with significant uncertainties.
2. In scantling draft conditions the exposed deck items on ships with a low deck height are not expected to encounter impact velocity in excess of  $V=13.5$  m/s. The minimum height of such items above the waterline is denoted  $d_2$  in this document. The background for the threshold velocity 13.5 m/s applied in UR S27 is model tests of Panamax and Capesize bulk carriers with freeboards 5.4m and 6.7m.
3. Experimental studies by B. Buchner 2002 concludes that the actual velocity  $V$  at items on deck is reasonable explained by dam-breaking models. From regressions of these experiments it was proposed that  $V \propto \sqrt{h}$  where  $h$  denotes the actual height of water above the deck. Buchner proposed a modified Rayleigh distribution of the relative motion at the bow in order to deduce extreme value distribution of  $h$ . This distribution contains heuristic ship specific constants. However, the classical Rayleigh distribution is conservative in this context and is assumed.
4. The extreme value distribution of  $h$  for various deck heights  $d$  above the waterline can be simulated assuming the classical Rayleigh distribution of relative bow motion. Monte Carlo simulations have been carried out by DNV for a reasonable range or standard deviations of relative motions at the bow. The

95% percentile  $h_{95}$  of the extreme value distribution of  $h$  indicates an approximate linear relation between  $h_{95}$  and  $d$ .

5. The forward speed is assumed small. It should be noted that the experiments by B. Buchner 2002 were carried out for FPSOs at zero forward speed. One hull panel member questioned if this is conservative or not, compared to cases where forward speed is considered? This issue is two-folded. In terms of velocity amplitudes it is usually higher loads associated with forward speed. However, in this task the essential issue is the relative variation of the impact speed with respect to  $d$  given that the limiting velocity amplitudes in the previous rule properly accounted for forward speed effects. We are not aware of studies regarding forward speed effects on the velocity shape. The forward speed effect on the shape is expected to be small for typical ULS conditions.

#### 4. Summary of Changes

As a consequence we propose the following approximation of  $V$

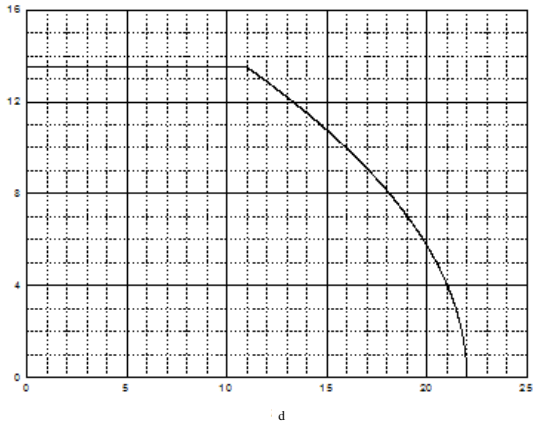
$$V = \begin{cases} 0 & , & d \geq d_1 \\ 13.5 \cdot \sqrt{\frac{d_1 - d}{d_1 - d_2}} & , & d_1 > d > d_2 \\ 13.5 & , & d \leq d_2 \end{cases}$$

The value of  $Zd_1$  is precisely defined in 3.1. The value of  $Zd_2$  is explained in 3.2. A lower bound of  $Zd_2$  can be assumed by considering the minimum freeboard and forecastle on e.g. Capesize carriers. It follows that a lower value of  $Zd_2$  could be about 7m. By increasing the parameter  $Zd_2$  the values of  $V$  becomes more conservative. Similar to  $Zd_1$  the value of  $Zd_2$  should take the ship length into account. Due to limited available experimental data a conservative value of  $Zd_2$  is needed. As a consequence we propose the following threshold.

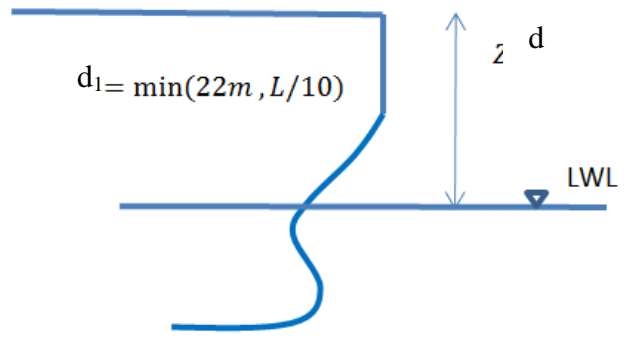
$$d_2 = \alpha \cdot d_1 , \quad \alpha = 0.5$$

Hence

$$V = \begin{cases} 0 & , & d \geq d_1 \\ 13.5 \cdot \sqrt{\frac{1 - \frac{d}{d_1}}{1 - \alpha}} & , & d_1 > d > \alpha \cdot d_1 \\ 13.5 & , & d \leq \alpha \cdot d_1 \end{cases}$$



Example:  $V(d)$  in case  $L=300m, \alpha = 0.5$



References:

B. Buchner 2002 "Green Water on Ship type Offshore Structures", PhD thesis, Delft

**5. Points of Discussion**

None

**6. Attachments, if any**

None

\*\*\*

## **An addendum to the Annex 5 (Mar 2021)**

### **Technical Background Document UR S27, Rev. 6 (June 2013)**

#### **7. Additional technical background 2021 – Application of green sea load on windlass**

##### **7.1 Background**

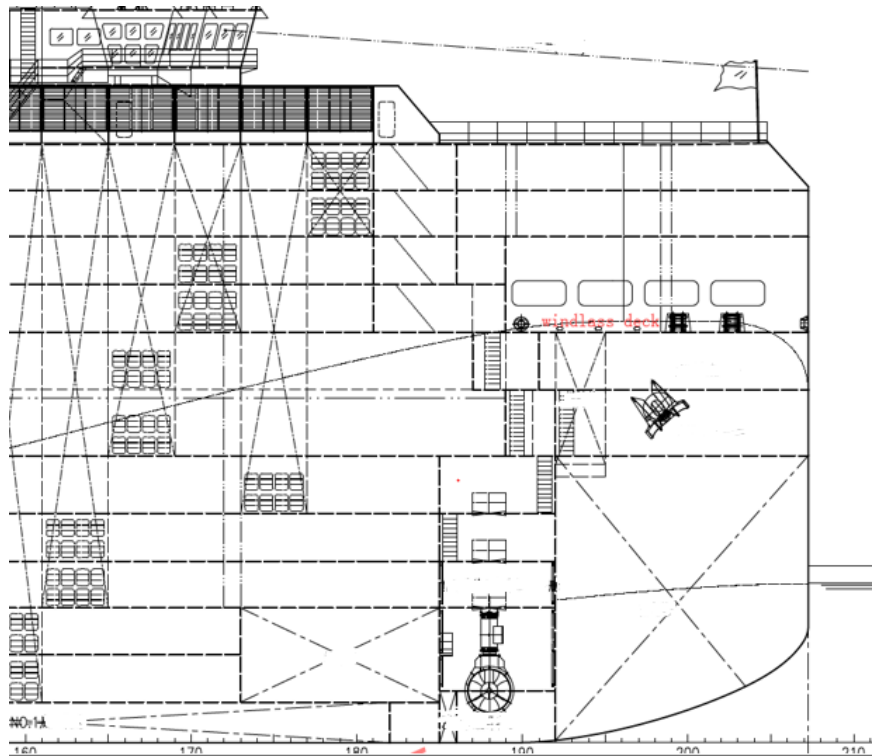
On 29 November 2019, one IACS member asked Hull Panel for clarification about the application of the green sea loads on the windlass deck of a Pure Car Truck Carrier (PCTC), see Figure 1.

The application is given in §2.1 of UR S27, Rev.6:

**“All ship types of sea going service of length 80 m or more, where the height of the exposed deck in way of the item is less than 0.1L or 22 m above the summer load waterline, whichever is the lesser.”**

Initially Hull Panel reviewed three possible interpretations:

- The windlass deck shall be considered as an exposed deck and the current green sea loads shall be applied.
- The windlass deck shall be considered as an exposed deck (in some extent) and reduced green sea loads formulation needs to be developed.
- The windlass deck shall be considered as a non-exposed deck, no green sea loads shall be applied.



**Figure 1** Typical arrangement of a PCTC with the windlass not located at the weather deck.

In the following discussion in Hull Panel, it was concluded that the meaning of "exposed deck" is the same as "weather deck", i.e. to be understood in full agreement with SOLAS II-2, Reg.3, 50: "Weather deck is a deck which is completely exposed to the weather from above and from at least two sides."

However, at this stage it was not possible to conclude on the application of green sea loads on windlass located at decks other than weather deck. Hence HP Chair tasked the HP members to:

- **review their damage databases and report damage experience of windlasses caused by green-sea loading.**

**7.2 Damage experience of windlasses caused by green-sea loading**

Totally eleven (11) members provided feedback. Of those, seven (7) members did not find any reported damages on windlasses caused by green-sea loading. Four (4) Classification Societies (CS) reported damages as summarized in the table below:

CS	Brief description of reported damages	HP Chair summary																
I	<p>CS I has reviewed its damage database and only identified one winch damage case (deformation) on a containership as a result of heavy weather.</p>	<p>Usually windlasses on containerships are located at exposed deck at foreship. i.e. UR S27 applies.</p>																
II	<p>CS II found the following 3 cases of damage on windlass reported due to bad weather:</p> <table border="1" data-bbox="296 712 1005 1028"> <thead> <tr> <th data-bbox="296 712 512 813">Global service notation</th> <th data-bbox="512 712 624 813">Year of build</th> <th data-bbox="624 712 756 813">Survey Year</th> <th data-bbox="756 712 1005 813">Damage types</th> </tr> </thead> <tbody> <tr> <td data-bbox="296 813 512 871">Container ship</td> <td data-bbox="512 813 624 871">2000</td> <td data-bbox="624 813 756 871">2007</td> <td data-bbox="756 813 1005 871">Bending</td> </tr> <tr> <td data-bbox="296 871 512 960">Liquefied gas carrier</td> <td data-bbox="512 871 624 960">2008</td> <td data-bbox="624 871 756 960">2012</td> <td data-bbox="756 871 1005 960">Crack at weld, Detachment</td> </tr> <tr> <td data-bbox="296 960 512 1028">Container ship</td> <td data-bbox="512 960 624 1028">2008</td> <td data-bbox="624 960 756 1028">2014</td> <td data-bbox="756 960 1005 1028">Defective</td> </tr> </tbody> </table> <p>However, it is not possible to determine whether these damages were directly the consequence of green sea loads.</p>	Global service notation	Year of build	Survey Year	Damage types	Container ship	2000	2007	Bending	Liquefied gas carrier	2008	2012	Crack at weld, Detachment	Container ship	2008	2014	Defective	<p>Usually windlass on containerships and gas carriers are located at exposed deck at foreship, i.e. UR S27 applies.</p>
Global service notation	Year of build	Survey Year	Damage types															
Container ship	2000	2007	Bending															
Liquefied gas carrier	2008	2012	Crack at weld, Detachment															
Container ship	2008	2014	Defective															
III	<p>CS III reports one damage case on a vehicle carrier (damage on winch/windlass seems to be an attached power unit but not attachment to deck which URS27 addresses):</p> <ol style="list-style-type: none"> <li data-bbox="296 1294 1005 1485">1. The mooring equipment and windlass were located on No7 Deck where bounded by side wall with some opening. However, during the severe weather encountered at North Sea, side wall was distorted, and ingress of green-sea water damaged mooring equipment.</li> <li data-bbox="296 1507 1005 1731">2. So even though there is deck above the mooring deck where partially protected by side wall, ingress of water can potentially damage windlass and mooring equipment. It is recommended IACS UR S27 should take account of green sea with no credit of bounded side wall or deck above out of an abundance of caution.</li> </ol>	<p>The sea pressure/green sea pressure has damaged the side wall/bulwark to the recess for the windlass. It seems that the damage on the power unit of the windlass is a consequence of the structural failure of the side wall/bulwark, i.e. lack of protection.</p> <p>The side wall/bulwark strength might not have been sufficient to withstand the sea pressure/bow impact pressure.</p>																
IV	<p>CS IV confirms that there is one suspicious damage report of a windlass of PCC in their database. However, since there is no detailed description about a cause of the damage, it is unknown whether the damage is due to green sea load or not.</p>	<p>Unless the nature of this damage is better described, it is not possible to make any conclusion from this damage.</p>																

### **7.3 Conclusion**

Based on the damage experience as summarized in 7.2, it was concluded in Hull Panel Chair's message of 6 May 2020 that it is no need for updates in UR S27 with respect to the application of green sea pressure for windlass.

Hence UR S27 does not apply for the bolts, chocks and stoppers securing the windlass as well as its supporting structure of windlasses located in protected/non-exposed locations, i.e. on decks other than the weather deck.

This addendum to Part B, Annex 5 in the technical background of UR S27 is prepared to document the in-service experience provided by IACS members on this issue.

\*\*\*

## UR S28 “Requirements for the Fitting of a Forecastle for Bulk Carriers, Ore Carriers and Combination Carriers”

### Part A. Revision History

Version no.	Approval date	Implementation date when applicable
Rev.3 (May 2010)	24 May 2010	-
Rev.2 (Sept 2005)	22 September 2005	-
Rev.1 (July 2004)	5 July 2004	-
NEW (May 2003)	6 May 2003	1 January 2004

- **Rev.3 (May 2010)**

**.1 Origin for Change:**

- Based on IACS Requirement (*Common Structural Rules for Bulk Carriers and Double Hull Oil Tankers*)

**.2 Main Reason for Change:**

Following the introduction of the IACS Common Structural Rules for Bulk Carriers and Double Hull Oil Tankers, Hull Panel were tasked to review all the UR S files to consider whether or not they are applicable to ships covered by the CSR.

**.3 List of non-IACS Member classification societies contributing through the TC Forum and/or participating in IACS Working Group:**

None.

**.4 History of Decisions Made:**

After review it was decided that for CSR bulk carriers the requirements of UR S28 are superseded by those of the Common Structural Rules and therefore do not apply.

UR S28 is not applicable for CSR oil tankers.

**.5 Other Resolutions Changes**

All UR S files, except UR S8, S9, S15, S16, S19, S22, S23, S30 and S31.

**.6 Dates:**

Original proposal: 2007, made by Hull Panel Task 50  
 Panel submission to GPG: 19 April 2010  
 GPG Approval: 24 May 2010 (Ref. 10051\_IGd)



- **Rev.2 (Sept 2005)**

See TB document in Part B.

- **Rev.1 (July 2004)**

Addition of 'Contracted for Construction' footnote – no TB document available.

- **NEW (May 2003)**

See TB document in Part B.

## Part B. Technical Background

List of Technical Background (TB) documents for UR S28:

Annex 1. **TB for Original Resolution (May 2003)**

See separate TB document in Annex 1.



Annex 2. **TB for Rev.2 (Sept 2005)**

See separate TB document in Annex 2.



**Note:** *There are no separate Technical Background (TB) documents for Rev.1 (July 2004) and Rev.3 (May 2010).*

## UR S28 Technical background

### 1. Historical background

In March 2002, IACS announced eight initiatives to improve the safety of Bulk Carriers, including the fitting of a forecastle on new bulk carriers.

It was initially considered that the forecastle would provide protection for forward hatches against green sea loading acting vertically on the top of hatch covers and horizontally on the fore end of hatch covers as well as the fore end hatch coaming and to fore-deck fittings.

Information provided by the AHG/WD-SL on the basis on the continuing investigations on available model test results indicated that the forecastle height does not affect extreme vertical loads on the hatch cover significantly. As a consequence, no credit has been given to the effect of a forecastle to reduce vertical green sea loading on hatch covers.

URs S26 and S27 were developed for requiring sufficient strength of fore-deck fittings against a design load based upon the upper bound load from the results of MARIN model tests for bulk carriers without a forecastle.

UR S21 Rev.3 allows credit to be given to the beneficial effects of a forecastle fitted in accordance with UR S28 for reducing the pressures on the forward transverse hatch coaming and securing arrangements for hatch No. 1.

The 1988 Load Line Protocol addresses “Protection of the crew” in regulation 25 and “Means of safe passage of crew” in regulation 25-1. Further “Bow height” and “reserve buoyancy” required in regulation 39 were developed taking the probability of deck wetness into account.

Consequentially, taking account of the above, the intention to require a forecastle for a new ship is:

- to contribute to the provision of the reserve buoyancy required by regulation 39 of the 1988 Load Line Protocol, as amended;
- to reduce the horizontal loads in UR S21 Rev. 3 for the strength checks of the forward transverse hatch coaming and closing arrangements of hatch No. 1; and
- to protect the crew working in the forward area of the ship.

### 2. Forecastle characteristics

The forecastle is required to be enclosed to achieve increased buoyancy in the forward area.

The specified forecastle dimensions and locations required for reducing horizontal loads on forward transverse coaming and closing arrangements on hatch No. 1, as well as those concerning the location of the aft edge of the forecastle, are based on the following considerations:

.1 A flow of water flushing on the forecastle deck with speed  $v_0$ , reaching a point located at a distance  $x$  from the aft edge of the forecastle deck and at a depth  $h$  below the specified height,  $H_F$ , of the forecastle is defined by the following equations:

$$\begin{cases} x = v_0 t \\ h = \frac{1}{2} g t^2 \end{cases}$$

which gives:

$$x = v_0 \sqrt{\frac{2h}{g}}$$

.2 The design pressure assumed in UR S21(Rev. 3) for forward transverse coaming protected by a forecastle fitted in accordance with UR S28 is equal to 220 kN/m<sup>2</sup> (S21.4.1).

.3 The analysis of the results of the MARIN model tests indicated that the water speed corresponding to the above-mentioned design pressure is equal to 11.0 m/s.

.4 Using the formula in .1 above for (see figure below):

$$x = l_F$$

$$h = H_F - H_C$$

and imposing a limitation to  $v_0$  ( $v_0 \leq 11.0$  m/s) in order not to exceed the maximum design pressure for forward transverse coaming protected by a forecastle, it results:

$$l_F \leq 4.97 \sqrt{H_F - H_C}$$

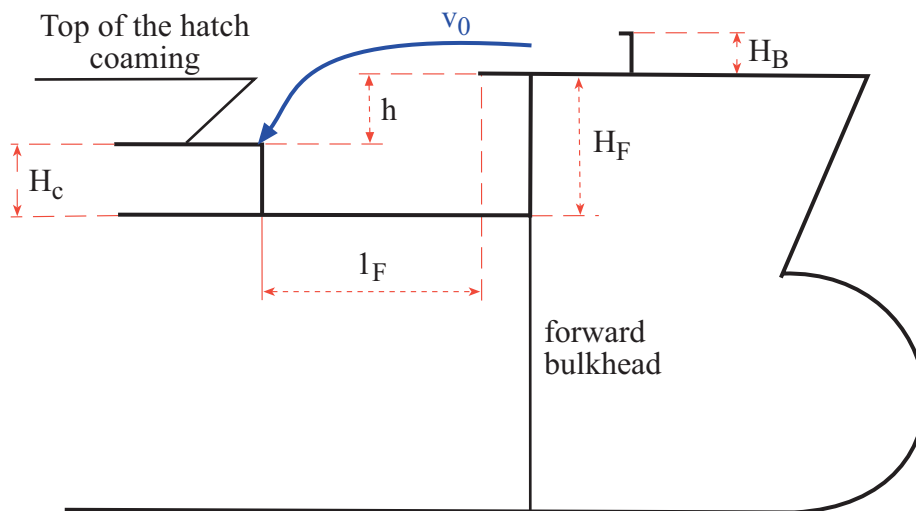
that can be rounded to:

$$l_F \leq 5 \sqrt{H_F - H_C}$$

.5 Practical considerations based on the examination of existing hatch cover designs led to the definition of the following condition for reducing the loads on the closing arrangements of hatch No. 1:

$$H_F \geq H_C + 0,5 \text{ m}$$

- .6 The formula of  $l_F$  given in point .4 above and the condition on  $H_F$  given in point .5 above ensure that the actual pressure on the forward transverse coaming is less than the design pressure.
- .7 To avoid increased vertical loads on the No. 1 hatch cover, which could be caused by the presence of a breakwater close to the aft edge of the forecastle deck, the minimum distance for a breakwater, if fitted, forward of the aft edge of the forecastle deck has been specified.



### 3. Remarks made by some Member Societies

Three Societies expressed the view that the expected effects of a forecastle for reducing safety risks associated with hatch covers, coaming, fore deck fittings and crew protection of new bulk carriers have been properly addressed by risk control options contained in regulation 39 of 1988 Load Line Protocol, as amended, and IACS URs S21(Rev.3), S26 and S27. Therefore they consider that there is no need to mandate the fitting of a forecastle in all cases. Fitting a forecastle in accordance with UR S28 may only be made mandatory for fulfilling the requirement of regulation 39 of the 1988 Load Line Protocol, as amended.

## Technical Background Document

### UR S28 (Rev.2, Sept. 2005)–

#### Scope and objectives

Scope and objectives are to resolve the following problem.

There is a small Bulk Carriers (i.e. L is less than 150m), which cannot satisfy this requirement because the distance from the forward bulkhead of the foremost hold to the forward transverse hatch coaming of foremost hold hatch cover is too short. If this requirement satisfies forcibly, hatch cover operation will be hindered.

#### Points of discussions or possible discussions

- 1 TB of UR S28 states the benefits of fitting forecastle as below:
  1. to achieve the provision of the reserve buoyancy required by regulation 39 of 1988 ICLL Protocol, as amended.
  2. to reduce the horizontal loads acting on the hatch coaming
  3. to protect the crew
- 2 The purpose of the first sentence of S28.2 is to avoid a too short forecastle.
- 3 For small Bulk Carriers, the purpose specified in 1.1 above will usually be achieved if forecastle length is more than  $0.07L$ , which is specified in Reg.39 of 1988 ICLL Protocol.
- 4 The purpose specified in 1.2 above is achieved if the forecastle satisfies the maximum distance  $l_F$  specified in S28.2
- 5 As the 1988 ICLL Protocol addresses specifically the Protection of the Crew issue, it is assumed that the fitting of a forecastle in accordance with 1988 ICLL Protocol achieves the purpose in 1.3.
- 6 Therefore, even if small Bulk Carriers with sufficient length of forecastle cannot satisfy the first sentence of S28.2, the purposes specified above are achieved.

#### Source/ derivation of proposed interpretation

N.A.

#### Decision by voting

N.A.

#### Appendix

N.A.

Submitted by Hull Panel Chairman  
31 July 2005

## UR S30 “Cargo Hatch Cover Securing Arrangements for Bulk Carriers not Built in accordance with UR S21 (Rev.3)”

### Summary

Clarification that this UR S30 is not applicable for the self-unloading bulk carrier.

### Part A. Revision History

Version no.	Approval date	Implementation date when applicable
Corr.1 (Mar 2019)	04 March 2019	-
Rev.1 (2003)	Aug 2003	
Corr.1 (2003)	May 2003	
New (2003)	Jan 2003	

#### • Corr.1 (Mar 2019)

##### 1 Origin of Change:

- Request by GPG 15139\_IGh dated 18/9/2016

##### 2 Main Reason for Change:

The applicability of ESP to the self-unloading bulk carriers (SUBC) leads to the GPG request to identify the UR S which are NOT applicable to SUBC.

This UR applies to bulk carriers not build in accordance with UR S21 (Rev.3) i.e. mainly for bulk carriers build before 1 Jan 2004. For avoiding to introduce retroactive requirements in relation with the GPG request to specify which UR S are not applicable to self-unloading bulk carriers (SUBC), the Hull Panel decided to clarify the point with this corrigenda clarifying this UR S is not applicable to SUBC.

##### 3 List of non-IACS Member classification societies contributing through the TC Forum and/or participating in IACS Working Group:

None

##### 4 History of Decisions Made:

Discussion at the HP meeting in 2016  
 Analysis by Hull Panel Chair  
 Discussion and decision by the Hull Panel in 2018

##### 5 Other Resolutions Changes:

Within this study for SUBC application: UR S17, 18 and 21A.

**6 Any hinderance to MASS, including any other new technologies:**

None

**7 Dates:**

Original Proposal: 14 June 2018            Made by: Hull Panel  
Panel Approval:    11 December 2018  
GPG Approval:     04 March 2019 (Ref. 15139\_IGI)

● **Rev.1 (Aug 2003)**

See TB document in Part B.

● **Corr.1 (May 2003)**

No TB document available.

● **New (Jan 2003)**

See TB document in Part B.

\*\*\*\*\*



## Part B. Technical Background

List of Technical Background (TB) documents:

Annex 1. **TB for Original Resolution (Jan 2003)**

See separate TB document in Annex 1.



Annex 2. **TB for Corr.1 (May 2003)**

See separate TB document in Annex 2.



Annex 3. **TB for Rev.1 (Aug 2003)**

See separate TB document in Annex 3.



**Note:** *There is no separate Technical Background (TB) documents for Corr.1 of Rev.1 (Mar 2019).*

# New UR S30 Technical background

(Jan 2003)

## 1. Objective

To re-draft UR S30 to cover horizontal loads and securing arrangements.

## 2. Reference:

1. Section 4 of Recommendation 14,
2. S21(Rev.2),
3. MSC 76/WP.16/para.23

## 3. Points of discussion

1. The AHG/EBC-Strength prepared a draft UR S[yy] “Requirements for existing bulk carriers’ hatch covers and coamings not built in accordance with UR S21 (Rev.2)” in August 2002.

Technical Background for this UR S[yy] is **annexed**.

However, following a more detailed cost-benefit analysis (carried out by DNV with GPG Members’ input), this UR S[yy] was found not cost-effective. Council decided to keep in abeyance until after MSC 76. It was so reported to MSC 76.

2. IMO MSC 76 decisions

MSC 76 decision (MSC 76/WP.16) reads: *While recognizing that replacing hatch covers in existing ships would not be cost-effective, the group agreed that more attention should be paid to hatch cover securing mechanisms and the issue of horizontal loads only, especially with regard to maintenance and frequency of inspection. Consequently, the group agreed further that ship owners and operators should be made aware of the need to implement regular maintenance and inspection procedures for closing mechanisms in existing bulk carriers in order to ensure proper operation and efficiency at all times, and invited the Committee to instruct the DE Sub-Committee to develop standards for hatch cover securing arrangements for existing ships and that IACS UR S21 and Recommendation 14 could be used as a starting point for discussion.*

3. GPG decisions

Finally, GPG at its small group meeting on 7-8 January 2003 prepared a draft UR S30 incorporating section 4 of Recommendation 14. Horizontal loads are specified in section 3 of S30 “Stoppers”.

The pressure value 175 kN/m<sup>2</sup> for stoppers is derived from UR S21(Rev.2) and its TB which reads as follows:

“The stoppers are to be dimensioned against longitudinal and transverse forces arising from a pressure of 175 kN/m<sup>2</sup>. This value takes into consideration the local reduction of pressure that occurs at the upper edge of the vertical boundary created by the coaming and hatch cover side or end plate.”

The pressure value 230 kN/m<sup>2</sup> comes from the following provision of ex-UR S30(Syy).

“With the exclusion of ships fitted with a forecastle complying with UR S28 or a breakwater complying with S 29 (S29 now withdrawn), No.1 hatch cover is to be effectively secured by means of stoppers, against the longitudinal forces arising from a pressure of 230 kN/m<sup>2</sup>, which may be reduced to 175 kN/m<sup>2</sup> if a forecastle not complying with S28 is fitted.”

**4. Section 4 “Materials and Welding”**

ABS proposed to have an additional section 4 “Materials and Welding” in S30.

**5. Recommendation 14**

GPG decided to revise Recommendation 14.

**4. Conclusions**

1. UR S30 was adopted on [31 January 2003] and submitted to IMO DE 46 in the same day.
2. WP/S will be asked to incorporate comparable changes in the revision of UR S21 that they are preparing (WP/S Task 70 – Revision of S21(Rev.2))

\*\*\*\*\*

## **Annex: TB for UR S [yy] submitted by AHG/EBC.**

**(Date of submission: 20 August 2002)**

### **1. Background**

Following the hearings of the Re-Opened Formal Investigation into the loss of the m.v. Derbyshire, held in the U.K., the Court recommended that UR S21 should be re-appraised in the light of the latest sea-keeping model tests, and that this new standard be made applicable both to new ships and retrospectively to existing vessels. Later, in March 2002, IACS announced a series of eight initiatives to improve the safety of bulk carriers. UR Syy was developed by AHG/EBC working in association with WP/S to address the application of measure number 6 to existing bulk carriers.

The requirements for hatch covers and coamings of existing bulk carriers are generally consistent with the requirements for new bulk carriers in UR S21 Rev. 1. Exceptions to this are shown below.

### **2. Hatch cover load model**

Based on cost benefit considerations, the hatch cover strength in the forward spaces flooding conditions are not required to be assessed. This is partially compensated by the additions made to the net thickness, which do not take into consideration the reduced life of the ship.

For the intact condition, the same load formulation as UR S21 is used.

### **3. Hatch cover strength criteria**

In the formula for the required net plate thickness, the factor  $F_P$  for combined membrane and bending response has a minimum value of 1,35, instead of 1,50 as adopted in UR S21. This minimum value is significant in areas of the hatch cover plate subjected to low in-plane stresses from bending of primary supporting members. Therefore, the overall safety is not significantly reduced, as these areas are not susceptible to plate buckling.

The safety factor,  $F_S$ , in the formula for the required minimum section modulus of secondary stiffeners depends on the stress level, so that  $F_S$  ranges between 1,2 and 1,5. This allows more specific requirements to be included for the minimum section modulus of stiffeners on the basis of their location and the corresponding stress level.

\*\*\*\*\*

# New UR S30 Technical background

(Jan 2003, Corr.1- May 2003)

## 1. Objective

To re-draft UR S30 to cover horizontal loads and securing arrangements.

## 2. Reference:

1. Section 4 of Recommendation 14,
2. S21(Rev.3),
3. MSC 76/WP.16/para.23
4. S[yy] prepared by AHG/EBC.

## 3. Points of discussion

1. The AHG/EBC-Strength prepared a draft UR S[yy] "Requirements for existing bulk carriers' hatch covers and coamings not built in accordance with UR S21 (Rev.3)" in August 2002.

Technical Background for this UR S[yy] is **annexed**.

However, following a more detailed cost-benefit analysis (carried out by DNV with GPG Members' input), this UR S[yy] was found not cost-effective. Council decided to keep in abeyance until after MSC 76. It was so reported to MSC 76.

2. IMO MSC 76 decisions

MSC 76 decision (MSC 76/WP.16) reads: *While recognizing that replacing hatch covers in existing ships would not be cost-effective, the group agreed that more attention should be paid to hatch cover securing mechanisms and the issue of horizontal loads only, especially with regard to maintenance and frequency of inspection. Consequently, the group agreed further that ship owners and operators should be made aware of the need to implement regular maintenance and inspection procedures for closing mechanisms in existing bulk carriers in order to ensure proper operation and efficiency at all times, and invited the Committee to instruct the DE Sub-Committee to develop standards for hatch cover securing arrangements for existing ships and that IACS UR S21 and Recommendation 14 could be used as a starting point for discussion.*

3. GPG decisions

Finally, GPG at its small group meeting on 7-8 January 2003 prepared a draft UR S30 incorporating section 4 of Recommendation 14. Horizontal loads are specified in section 3 of S30 "Stoppers".

The pressure value 175 kN/m<sup>2</sup> for stoppers is derived from UR S21(Rev.3) and its TB which reads as follows:

"The stoppers are to be dimensioned against longitudinal and transverse forces arising from a pressure of 175 kN/m<sup>2</sup>. This value takes into consideration the local reduction of pressure that occurs at the upper edge of the vertical boundary created by the coaming and hatch cover side or end plate."

The pressure value 230 kN/m<sup>2</sup> comes from the following provision of ex-UR S30(Syy).

"With the exclusion of ships fitted with a forecastle complying with UR S28 or a breakwater complying with S 29 (S29 now withdrawn), No.1 hatch cover is to be effectively secured by means of stoppers, against the longitudinal forces arising from a pressure of 230 kN/m<sup>2</sup>, which may be reduced to 175 kN/m<sup>2</sup> if a forecastle not complying with S28 is fitted."

4. Section 4 "Materials and Welding"

ABS proposed to have an additional section 4 "Materials and Welding" in S30.

5. Recommendation 14

GPG decided to revise Recommendation 14.

4. **Conclusions**

1. UR S30 was adopted on 30 January 2003 and submitted to IMO DE 46.

2. At the same time, WP/S was asked to incorporate comparable changes in the revision of UR S21 that they are preparing (WP/S Task 70 – Revision of S21(Rev.3))

\*\*\*\*\*

## **Annex: TB for UR S [yy] submitted by AHG/EBC.**

**(Date of submission: 20 August 2002)**

### **1. Background**

Following the hearings of the Re-Opened Formal Investigation into the loss of the m.v. Derbyshire, held in the U.K., the Court recommended that UR S21 should be re-appraised in the light of the latest sea-keeping model tests, and that this new standard be made applicable both to new ships and retrospectively to existing vessels. Later, in March 2002, IACS announced a series of eight initiatives to improve the safety of bulk carriers. UR Syy was developed by AHG/EBC working in association with WP/S to address the application of measure number 6 to existing bulk carriers.

The requirements for hatch covers and coamings of existing bulk carriers are generally consistent with the requirements for new bulk carriers in UR S21 Rev. 1. Exceptions to this are shown below.

### **2. Hatch cover load model**

Based on cost benefit considerations, the hatch cover strength in the forward spaces flooding conditions are not required to be assessed. This is partially compensated by the additions made to the net thickness, which do not take into consideration the reduced life of the ship.

For the intact condition, the same load formulation as UR S21 is used.

### **3. Hatch cover strength criteria**

In the formula for the required net plate thickness, the factor  $F_p$  for combined membrane and bending response has a minimum value of 1,35, instead of 1,50 as adopted in UR S21. This minimum value is significant in areas of the hatch cover plate subjected to low in-plane stresses from bending of primary supporting members. Therefore, the overall safety is not significantly reduced, as these areas are not susceptible to plate buckling.

The safety factor,  $F_s$ , in the formula for the required minimum section modulus of secondary stiffeners depends on the stress level, so that  $F_s$  ranges between 1,2 and 1,5. This allows more specific requirements to be included for the minimum section modulus of stiffeners on the basis of their location and the corresponding stress level.

\*\*\*\*\*

## IACS Unified Requirement S 30 (Rev.1)

### Technical Backgrounds:

#### a) Objective/Scope

To amend the existing text of UR S30 to eliminate ambiguity

#### b) Source of Proposed Requirements

ABS GPG put forward a draft amendment to UR S30.1.1 (2248jABa of 22 July 2003).

#### c) Points of Discussion

1. S30.1.1 reads that *these requirements apply.....and are for steel hatch cover securing devices and stoppers for cargo hold hatchways within 0.25 L of the fore perpendicular, except pontoon type hatch cover.*

However, S30.3 on stoppers specifically addresses hatch covers 1 and 2.

Hatch cover no.3 may be at least partially within 0.25L from FP on some bulk carriers. GPG/Council agreed that in such cases, S30 applies only to hatch covers 1 and 2 if they are within 0.25L of the FP.

2. S30.1.1 has been so amended.
  - S30 does not apply to hatch cover no.3 if it is partially within 0.25L.
  - S30 does apply to hatch cover no.1 and 2 whenever they are wholly or partially within the forward 0.25 L aft the FP.
  - Since UR S21, Rev.3 applies to all position 1 hatch covers, the ambiguity being corrected in S30 does not occur in S21, Rev. 3.

\*\*\*

approved on 18/08/2003 (2248jICa)



## UR S31 (Sww) Technical Background

### 1. Background

In March 2002, IACS announced eight initiatives to improve the safety of bulk carriers. UR S31 was developed by AHG/EBC, working together with members of WP/S, to address measure number 7. The objective of UR S31 is to establish steel renewal criteria for the side frames of pre-S12 (Rev 1) bulk carriers that are generally equivalent to the application of the renewal criteria of UR S12.

### 2. Renewal thickness

Two thickness values, as indicated below, are defined for the purpose of establishing the steel renewal criteria for the side frames of existing pre-S12 bulk carriers.

- The thickness  $t_{\text{COAT}}$ , which corresponds to the renewal thickness applicable to S12 ships. In accordance with UR S12,  $t_{\text{COAT}}$  is therefore defined as 75% of the thickness required according to S12.3 and S12.4. When measured thickness is below this value, actions as described below are required.
- The renewal thickness  $t_{\text{REN}}$ , obtained by reducing  $t_{\text{COAT}}$  by an amount  $t_{\text{C}}$ . The  $t_{\text{C}}$  values have been established from a review of the current practices of the IACS members.

However, the renewal thickness is never to be taken less than 75% of the thickness adopted at the new building stage in order to avoid corrosion wastage in excess of that anticipated in the design.

Different minimum thicknesses are defined in UR S12 depending on the hold to which any frame belongs and on the part of the frame under consideration. As a consequence, different  $t_{\text{COAT}}$  and  $t_{\text{C}}$  values, and thus  $t_{\text{REN}}$  values, are defined separately for:

- the span and the upper bracket,
- the lower bracket,

distinguishing between hold No. 1 and the other holds.

The renewal criteria, based on the measured thickness  $t_{\text{M}}$ , are as follows:

- a) When  $t_{\text{M}} \leq t_{\text{REN}}$ , steel renewal is required. This is consistent with the present Society practice.
- b) When  $t_{\text{REN}} < t_{\text{M}} \leq t_{\text{COAT}}$ , measures are to be taken, consisting of all the following:
  - sand blasting, or equivalent, and coating ,
  - fitting tripping brackets,
  - maintaining the coating in “as-new” condition, or equivalent (i.e. without breakdown or rusting), at Special and Intermediate Surveys.

The above measures may be waived if the structure and coating are in “as-new” condition.

These criteria aim to ensure adequate strength of the side frames of pre S-12 ships when their measured thickness is lower than the corresponding renewal thickness of S12 ships.

However, in order that these criteria may be considered as being generally equivalent to the UR S12 renewal criteria, the renewal thickness  $t_{REN}$  is also to satisfy simple yield strength and buckling checks. The yielding strength checks are explicitly defined in UR S31 and their background is reported in 4.

The buckling checks are covered through the introduction of limiting web depth to thickness ratios for both the frames and the lower brackets. These limits are the same as those established in UR S12 for renewal, the only difference being retention of the k factor for asymmetrically flanged frames, since this could have been applied in the design of pre-S12 ships.

### **3. Thickness measurements, steel renewal and reinforcing measures**

The effectiveness of steel renewal or alternative measures relies on an adequate extent of the structure being treated. Measures adopted for the lower and upper brackets are individually required to extend over at least 25% of the overall span. In addition, for the reasons given in 2. above, different renewal thicknesses are defined for the span and upper bracket and for the lower bracket.

The necessity to combine these principles led to the identification of four zones A, B, C and D, as shown in Figure 1 of UR S31, and to the definition of thickness measurements and renewal or reinforcement criteria for each zone.

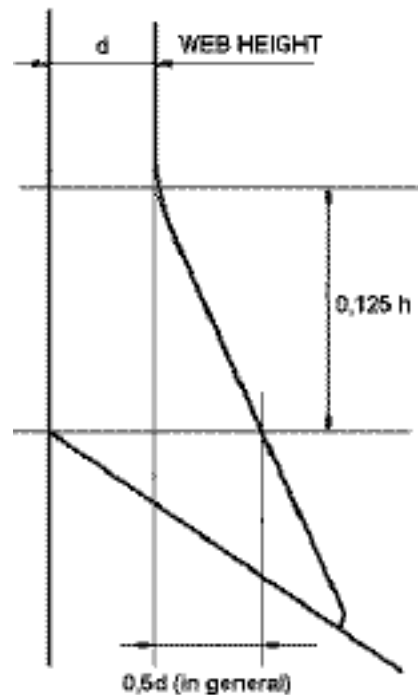
Reinforcing measures involve the fitting of tripping brackets at the lower part and at midspan of side frames. Frame tripping is considered as being one of the major causes of side frame collapse and the efficiency of tripping brackets in preventing catastrophic failures has been demonstrated in some near miss cases.

The criteria for dealing with pitting and grooving are the same as in UR S12.

### **4. Yield strength checks**

Shear and bending strength checks are required to be carried out at two transverse sections a) and b), specified in Figure 2 of UR S31. Section a) is representative of the lower bracket strength, while section b), located at the connection between frame and lower bracket, is representative of the frame strength at its lower part.

Some strength analyses carried out by Members in the course of the development of UR S31 showed that the bending check is significant when small brackets (length less than about 10% of the frame span) are fitted. For this reason, and for consistency with UR S12, the bending check is not required when the bracket length and depth comply with the requirements of UR S12 shown in Figure 1.

**Figure 1 – Minimum bracket dimensions according to UR S12**

NK placed a reservation on the bending strength check required in S31.3.4.

While the other Members agreed that the definition of  $t_{REN}$  and the acceptability of measured thickness  $t_M$  have always to account for the results of the strength checks, including the bending moment check, NK deem that the bending check is to be carried out only when  $t_M$  is less than  $t_{COAT}$ .

The strength checks are based on the following considerations.

- a) The side pressure only is considered for calculating the shear force and bending moment in the side frame lower part. The side pressure load model was developed by the AHG/WD-SL and is reported in their document “Dynamic sea pressure for Bulk Carriers” of 30 January 2002. In this model, the pressure loads are defined through a coefficient  $f$ , which accounts for any load probability of exceedance. The side pressures in UR S31 are defined for the following probabilities of exceedance:
  - $10^{-6}$ , for the head sea condition,
  - $10^{-4}$ , for the beam sea condition.
- b) In order to simplify the procedure, certain approximations, as described below, are involved in the assessment of the applied shear forces and bending moments.

The shear force at section a) is obtained by integrating the still water and wave pressures over the frame span  $h$ . It is assumed that the sum of the still water and wave pressures is uniform along the span  $h$ . It is also assumed that 60% of the total lateral force on the frame is carried by

the lower end support: for this reason, a coefficient  $k_s = 0,6$  is introduced in the formulae for  $t_{REN,Sa}$  and  $t_{REN,Sb}$  in S31.3.4.

The shear force at section b) is assumed to be equal to that at section a) multiplied by a factor. The factor is equal to (the frame span “h” minus twice the length of the lower bracket) divided by “h” (it is assumed here that the upper and the lower brackets have the same length).

The bending moment at sections a) and b) are obtained by multiplying the total lateral force on the frame by the frame span and dividing it by coefficients “ $m_a$ ” and “ $m_b$ ”, derived from the results of Finite Element calculations. The “ $m_a$ ” and “ $m_b$ ” values depend on the loading condition of the hold to which the frame under consideration belongs.

The analyses carried out showed that, for loaded holds, the side frames may be considered as being clamped at the lower end ( $m_a = 12$ ). The coefficients “ $m_b$ ” depends, of course, on the distance from the support and hence on the bracket length.

In the case of empty holds of ships navigating in non homogeneous loading conditions (i.e. at the maximum draft) the sea pressure acting on the double bottom is not counterbalanced by internal cargo. This induces significant rotation of the hopper tanks and hence of the side frame lower ends. This rotation increases the bending moment (i.e. reduces the “ $m_a$ ” and “ $m_b$ ” values) and consequently lower coefficients have been included for this case.

- c) The load probabilities defined in a) are based on the assumption that the following probabilities:
- $10^{-7}$ , for the head sea condition,
  - $10^{-5}$ , for the beam sea condition

represent extreme sea conditions. This is based on a comparison of the  $10^{-8}$  probability loads obtained by the AHG/WD-SL with the Marin model test results and a judgement of the beam sea loads justified as follows.

In severe sea states, a Master would normally operate his ship in the head seas condition. However, a beam seas condition might occur in an emergency situation, due for instance to engine or shaft failure. In the latter case, the use of a higher load probability is justified by the need for a joint probability of occurrence of two rare events. On basis of this assumption, a stress level corresponding to yield was applied to these levels of probability.

However, the sea load formula proposed by the AHG/WD-SL gives considerably higher values of side pressure than those given by current class rules of some societies and/or calculation results of long term predictions carried out by some societies. The values of probability have been modified as specified in a) above and the stress levels have been reduced accordingly.

Both the load probability of exceedance and the “ $m_a$ ” and “ $m_b$ ” values are consistent with an elastic behaviour of the side frames. Consequently, the normal and shear allowable stresses are obtained by multiplying the yield stress by appropriate safety factors (0,90 for the normal stresses and 0,40 for the shear stresses).

Notes by the Permanent Secretariat

1. In order to lift its reservation to the bending strength check in S31.3.4, NK put forward the following amendment to the renewal thickness in S31.2.1.

*the strength check is to be carried out when  $t_M \leq t_{COAT}$*

GPG 53 (Oct.2002) agreed this and further decided that  $t_{RENS}$  need not be taken as more than  $0.75t_{S12}$ , allowing that Members were free to apply the stricter requirements should they wish. Hence, the following was added to S31.2.1:

*but the  $t_{RENS}$  as obtained from S31.3.3 need not be taken more than  $0.75 t_{S12}$*

2. At the time of approval of S31, revision of S12 had not been completed. WP/S was expected to complete the remaining task to develop shear and bending checks for inclusion into S12 which would be similar to those given in S31. See S12 (Rev.4).
3. Implementation schedule is the same as that for URs S26 and S27.
4. Date of approval of S31: 14 November 2002 (2219\_ICd).

\*\*\*\*\*

# UR S31 Technical background

**(Rev.1, June 2003)**

## **1. Background**

NK Council Member proposed that S31 should be revisited with regard to shear buckling of hold frame webs. It reported that the S31 requirement on the renewal thickness in regard to shear buckling of hold frame web used an assumption that the as-built design was subjected to the allowable stress, however, there were a number of bulk carriers that the assumption was not in reality.

Council tasked WP/S to undertake an urgent review of S31 on 4 March 2003 (during GPG 54).

ABS drew Council attention to the need to clarify some vague language used at the end of S31.2.1. ABS also proposed to add the requirements for bulk carriers subject to UR S31 that are ice strengthened. S31.1.1 refers.

## **2. S31.2.1: Web depth to thickness ratio**

A number of bulk carriers have the depth of side frames immediately abaft the collision bulkhead much greater than that of ordinary frames by classification requirements. Such design has been widely applied to provide significantly large moment of inertia for restricting undesirable flexibility of side shell and achieving smooth continuation of the side shell structural stiffness of fore peak tank to that of the foremost cargo hold.

Working shear stresses of the deep hold web frames in that area are quite lower than the assumed maximum working shearing stresses, i.e.  $0.4\sigma_y$ .

Section S31.2.1 of the original UR S31, therefore, has been amended by introducing a new text and formula taking into a web depth to thickness ratio into account in the procedure for determining renewal thickness  $t_{REN}$ .

The shear capacity of hold frame web plate used in S31.2.1 can be given by the following formula.

$$\tau_{cr} = K \frac{\pi^2 E}{12(1-\nu^2)} \left(\frac{t}{b}\right)^2 = S_f \tau_a \quad (1)$$

where:

$\tau_{cr}$  = critical shear buckling stress

$t$  =  $t_{REN,d/t}$ , web thickness satisfying the required shear buckling criteria corresponding to the assumed allowable shear stress  $\tau_a$  with safety factor.

$\tau_a$  = allowable shear stress (=  $0.4 \sigma_y$ )

$S_f$  = safety factor

In case where the working shear stress  $\tau_w$  is smaller than allowable shear stress, critical shear buckling stress may be reduced by replacing  $\tau_a$  with  $\tau_w$  in (1):

$$\tau_{cr} \geq S_f \tau_w$$

where:

$$\tau_w = \frac{t_{REN,S}}{t_{REN,d/t}} \tau_a$$

$t_{REN,S}$  is as obtained from S31.3.3,

$t_{REN,d/t}$  is the web thickness that satisfies the web depth to thickness ratio specified in the original S31.2.1 for  $t_{REN}$  as follows:

for frames:

- $65 k^{0.5}$  for symmetrically flanged frames
- $55 k^{0.5}$  for asymmetrically flanged frames

and for the lower brackets at section a) of Figure 2 of UR S31:

- $87 k^{0.5}$  for symmetrically flanged frames
- $73 k^{0.5}$  for asymmetrically flanged frames

where  $k = 1.0$  for ordinary hull structural steel and  $k < 1$  for higher tensile steel according to UR S4.

However, when  $t_{REN,d/t}$  is greater than  $t_{REN,S}$ , it means that the maximum working shear stresses  $\tau_w$  is less than the allowable shear stress  $\tau_a$  and the corresponding  $t_{REN, d/t}'$  will be obtained by the following formula,

$$t_{REN, d/t}' = \sqrt[3]{t_{REN,d/t}^2 t_{REN,S}}$$

For the reader's easy understanding the following explanation is given:

The relationship between critical shear stresses and the web plate thickness is given by the formula (1)

$$\tau_{cr} = K \frac{\pi^2 E}{12(1-\nu^2)} \left(\frac{t}{b}\right)^2 = S_f \tau_a \quad (1)$$

In case where working shear stresses  $\tau_w$  are less than the allowable shear stress  $\tau_a$  the corresponding critical shear stress  $\tau_{cr}'$ , while maintaining the same safety factor, is given by

$$\tau_{cr}' = K \frac{\pi^2 E}{12(1-\nu^2)} \left(\frac{t'}{b}\right)^2 = S_f \tau_w \quad (2)$$

where,  $t'$  is the web plate thickness giving the critical shear stress  $\tau_{cr}$

Consequently the working shear stresses  $\tau_w$  is given by formula (3)

$$\tau_w = \frac{t_{REN,S}}{t'} \tau_a \quad (3)$$

where,  $t_{REN,S}$  is as given in S31.3.3

The following equation is obtained by substituting  $\tau_w$  in formula (2) by that of formula (3):

$$K \frac{\pi^2 E}{12(1-\nu^2)} \left(\frac{t'}{b}\right)^2 = S_f \frac{t_{REN,S}}{t'} \tau_a = S_f \tau_a \frac{t_{REN,S}}{t'} \quad (4)$$

Combining equations (1) and (4) give the following relationship between  $t$  and  $t'$ :

$$\left(\frac{t'}{b}\right)^2 = \frac{t_{REN,S}}{t'} \left(\frac{t}{b}\right)^2 \quad (5)$$

Equation (5) gives  $t'$  as follows:

$$t' = \sqrt[3]{t^2 t_{REN,S}} \quad (6)$$

$t'$  given by the formula (6) gives the renewal web thickness for side frames and lower brackets satisfying the shear buckling criteria corresponding to the working shear stresses, where  $t$  is greater than  $t_{REN,S}$ .

The formula for  $t'$  is based on the formulation of the elastic shear buckling stress. For as built thicknesses  $t_{AB}$  greater than  $1,65 \cdot t_{REN,S}$ , the side frame web works in the elastic domain, also considering an actual thickness of about 75% of the as built one, and the formula in (6) is applicable.

$t$  above is denoted as  $t_{REN,d/t}$ , while  $t'$  is denoted as  $t_{REN,d/t}'$  in UR S31.2.1.

### 3. Alternative to steel renewal

The fitting of tripping brackets, in accordance with S31.2.3, is allowed as an alternative to steel renewal, when the measured thickness is less than  $t_{REN,d/t}$  required by the web depth to thickness ratio check for the frame web.

This measure is considered an efficient solution for the stability of the web and flange at the upper termination of the lower end bracket, subjected to the combined effects of the sea pressure loads, the compressive force of the lower end bracket flange and the shear stress of the side frame web.



#### **4. S31.2.1: Measurement of depth of lower bracket**

It was raised by WP/S meeting in February 2003 that it would be necessary to modify the definition of depth of lower bracket for the calculation of  $d/t$  in association with revision of UR S12. WP/S agreed that the depth may be measured perpendicular to the face plate of lower bracket from the intersection of sloping plating of hopper tank and side shell plate.

For the measurement of depth of lower bracket, the WP/S agreed to give credit to the possible secondary stiffeners fitted on the lower bracket plate for buckling prevention.

#### **5. S31.2.1: Steel renewal**

The test of the original S31.2.1 addressed only  $1.2t_{\text{COAT}}$  for the minimum plate thickness for the renewed parts. It should also address  $1.2t_{\text{REN}}$  to be comprehensive. Therefore a new wording “or  $1.2t_{\text{REN}}$  whichever is the greater” is inserted after “ $1.2t_{\text{COAT}}$ ” in the paragraph next to the last in S31.2.1.

#### **6. S31.2.1: Meaning of “as-new” condition**

It is clarified that the structure is in “as-new” condition when the thicknesses are as per the approved drawings.

The coating is in “as-new” condition when it is without breakdown or rusting exists.

#### **7. S31.2.2: Zone of sand blasting and coating**

With regard to the requirement of sand blasting and coating for frames in the 5th paragraph of S31.2.2, considering the consistency with the other requirements, zone B is added for sand blasting and coating, when zone C is required sand blasting and coating.

#### 8. Notes by the Permanent Secretariat

##### 8.1 Other changes

- S31.2.1.2.a) “tripping bracket alternative”: Fitting of tripping brackets, as an alternative to the requirements for the web depth to thickness ratio of side frames, does not exclude that the other checks for renewal (corrosion and strength) are to be performed. Amendments to S31.2.1.2a) and S31.2.1.2d).
- S31.2.1.2.c) “thickness of renewed webs of frames and lower brackets” - the requirement “ $t_{\text{ren}}$  need not be taken more than  $0.5t_{\text{S12}}$ ” has been retained.
- The expression “frames” throughout in S31 was re-checked and modified so that it is changed to “frames and brackets” where the requirements address both frames and brackets.

("brackets" are added to 1<sup>st</sup> sentence in S31.1, 3<sup>rd</sup> paragraph in 31.1, the penultimate paragraph in S31.2.2, and 2<sup>nd</sup> paragraph in S31.2.5.)

8.2 An information paper was submitted to MSC 77 on 8 April 2003 advising them that:

- S31 has been revised to amongst others explicitly limit the renewal thickness to be not less than the as-built thickness.
- The shear and bending checks carried out under S31 as revised will, in a majority cases, govern the thickness of the replaced portion of the web.

8.3 NK proposed to add the following to the TB (2219cNKg of 19/06/03)

- **S31.2.1.3** Criteria for frames and brackets (Bending check)

DNV pointed out that side frame with insufficient bending strength may go unnoticed since the bending requirements will not be checked until the web thickness is less than  $t_{\text{COAT}}$ . Therefore, it is incorrect to use  $t_{\text{COAT}}$  as reference for section modulus control. (2219cNVd of 26 May 2003) At C47, the majority of members shared the views of DNV comments.

But NK stated as follows: The matter of bending stress check had been discussed and agreed by GPG in October 2002 with a view to resolve the reservation lodged by NK. On the technical side of the bending stress check, the timing for carrying out the bending stress check is linked to the result of thickness measurement. The actual web thickness has little to do with the section modulus of hold frames and it may seem to be illogical to use such criteria for a need of bending stress check. However, the provision of S31.2.1.3 contained in Mr. Han's message 2219cIAa of 17 April 2003, i.e. "Where  $t_M$  in the lower part of side frames, as defined in Figure 1, is equal to or less than  $t_{\text{COAT}}$ ", gives a pragmatic approach of the application of the bending check when diminution of the hold frame has modestly progressed. NK's investigation into hold frame failure indicated extensive corrosion of hold frames being the major contributor to hold frame failure and the requirement of S31.2.1.3, contained in UR S31 attached to the message of Mr. Han, provides the right timing for taking action for risk reduction of hold frame failure by a pragmatic use of modest progress in diminution of hold web. NK consider that there would be a very limited risk reduction if well maintained hold frames in nearly as built condition are to be renewed due to the age of bulk carriers and not due to the condition of the structure. NK, therefore, did not agree the proposal of DNV."

- NK made the following statements at Council 47 meeting (10-12 June 2003):
  - 1) The introduction of the bending/shear buckling checks, which had been introduced into S31 needs to be carefully examined.
  - 2) According to NK's data extensive corrosion in hold frames is an identified primary contributor to hold frame failures. There are still a number of well-maintained ships with good coating condition albeit not satisfying the new bending check requirements. Such a new requirement may well be applied for risk reduction purposes once cargo hold frames have shown a start of deterioration. The criteria "where  $t_M$  in the lower part of side frames is equal to or less than  $t_{\text{COAT}}$ " is considered to provide the sign of a start of deterioration.

- 3) NK would examine the integrity of existing BCS' hold frames structures, using such criteria contained in the former draft version of UR S31.2.1.3 (May 2003), which read as follows:

*S31.2.1.3 Criteria for frames and brackets ( pre-S31.2.1.3(Rev.1))*

*Where  $t_M$  in the lower part of side frames, as defined in Figure 1., is equal to or less than  $t_{COAT}$  and the length or depth of the lower bracket does not meet the requirements in S12, a bending strength check in accordance with S31.3.4 is to be carried out and renewals or reinforcements of frames and/or brackets are to be effected as required therein.*

\*\*\*\*

Annexed: TB of the first issue of S 31(Nov 2002).

## UR S31 (Sww, Nov 2000) Technical Background

### 1. Background

In March 2002, IACS announced eight initiatives to improve the safety of bulk carriers. UR S31 was developed by AHG/EBC, working together with members of WP/S, to address measure number 7. The objective of UR S31 is to establish steel renewal criteria for the side frames of pre-S12 (Rev 1) bulk carriers that are generally equivalent to the application of the renewal criteria of UR S12. UR S12 in this TB refers to UR S12 (Rev.1, 2 and 3).

### 2. Renewal thickness

Two thickness values, as indicated below, are defined for the purpose of establishing the steel renewal criteria for the side frames of existing pre-S12 bulk carriers.

- The thickness  $t_{\text{COAT}}$ , which corresponds to the renewal thickness applicable to S12 ships. In accordance with UR S12,  $t_{\text{COAT}}$  is therefore defined as 75% of the thickness required according to S12.3 and S12.4. When measured thickness is below this value, actions as described below are required.
- The renewal thickness  $t_{\text{REN}}$ , obtained by reducing  $t_{\text{COAT}}$  by an amount  $t_{\text{C}}$ . The  $t_{\text{C}}$  values have been established from a review of the current practices of the IACS members.

However, the renewal thickness is never to be taken less than 75% of the thickness adopted at the new building stage in order to avoid corrosion wastage in excess of that anticipated in the design.

Different minimum thicknesses are defined in UR S12 depending on the hold to which any frame belongs and on the part of the frame under consideration. As a consequence, different  $t_{\text{COAT}}$  and  $t_{\text{C}}$  values, and thus  $t_{\text{REN}}$  values, are defined separately for:

- the span and the upper bracket,
- the lower bracket,

distinguishing between hold No. 1 and the other holds.

The renewal criteria, based on the measured thickness  $t_{\text{M}}$ , are as follows:

- a) When  $t_{\text{M}} \leq t_{\text{REN}}$ , steel renewal is required. This is consistent with the present Society practice.
- b) When  $t_{\text{REN}} < t_{\text{M}} \leq t_{\text{COAT}}$ , measures are to be taken, consisting of all the following:
  - sand blasting, or equivalent, and coating ,
  - fitting tripping brackets,
  - maintaining the coating in “as-new” condition, or equivalent (i.e. without breakdown or rusting), at Special and Intermediate Surveys.

The above measures may be waived if the structure and coating are in “as-new” condition.

These criteria aim to ensure adequate strength of the side frames of pre S-12 ships when their measured thickness is lower than the corresponding renewal thickness of S12 ships.

However, in order that these criteria may be considered as being generally equivalent to the UR S12 renewal criteria, the renewal thickness  $t_{REN}$  is also to satisfy simple yield strength and buckling checks. The yielding strength checks are explicitly defined in UR S31 and their background is reported in 4.

The buckling checks are covered through the introduction of limiting web depth to thickness ratios for both the frames and the lower brackets. These limits are the same as those established in UR S12 for renewal, the only difference being retention of the k factor for asymmetrically flanged frames, since this could have been applied in the design of pre-S12 ships.

### **3. Thickness measurements, steel renewal and reinforcing measures**

The effectiveness of steel renewal or alternative measures relies on an adequate extent of the structure being treated. Measures adopted for the lower and upper brackets are individually required to extend over at least 25% of the overall span. In addition, for the reasons given in 2. above, different renewal thicknesses are defined for the span and upper bracket and for the lower bracket.

The necessity to combine these principles led to the identification of four zones A, B, C and D, as shown in Figure 1 of UR S31, and to the definition of thickness measurements and renewal or reinforcement criteria for each zone.

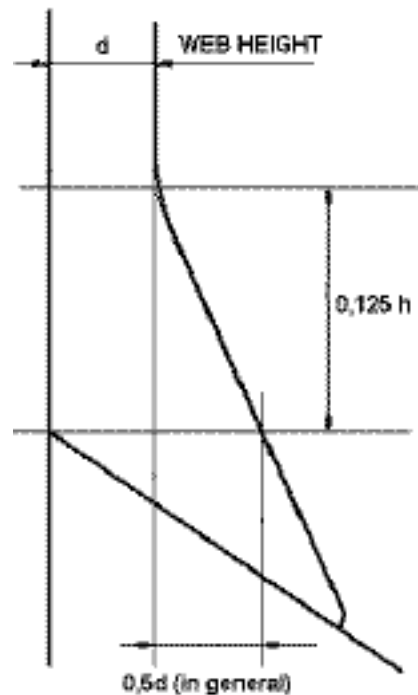
Reinforcing measures involve the fitting of tripping brackets at the lower part and at midspan of side frames. Frame tripping is considered as being one of the major causes of side frame collapse and the efficiency of tripping brackets in preventing catastrophic failures has been demonstrated in some near miss cases.

The criteria for dealing with pitting and grooving are the same as in UR S12.

### **4. Yield strength checks**

Shear and bending strength checks are required to be carried out at two transverse sections a) and b), specified in Figure 2 of UR S31. Section a) is representative of the lower bracket strength, while section b), located at the connection between frame and lower bracket, is representative of the frame strength at its lower part.

Some strength analyses carried out by Members in the course of the development of UR S31 showed that the bending check is significant when small brackets (length less than about 10% of the frame span) are fitted. For this reason, and for consistency with UR S12, the bending check is not required when the bracket length and depth comply with the requirements of UR S12 shown in Figure 1.

**Figure 1 – Minimum bracket dimensions according to UR S12**

NK placed a reservation on the bending strength check required in S31.3.4.

While the other Members agreed that the definition of  $t_{REN}$  and the acceptability of measured thickness  $t_M$  have always to account for the results of the strength checks, including the bending moment check, NK deem that the bending check is to be carried out only when  $t_M$  is less than  $t_{COAT}$ .

The strength checks are based on the following considerations.

- a) The side pressure only is considered for calculating the shear force and bending moment in the side frame lower part. The side pressure load model was developed by the AHG/WD-SL and is reported in their document “Dynamic sea pressure for Bulk Carriers” of 30 January 2002. In this model, the pressure loads are defined through a coefficient  $f$ , which accounts for any load probability of exceedance. The side pressures in UR S31 are defined for the following probabilities of exceedance:
  - $10^{-6}$ , for the head sea condition,
  - $10^{-4}$ , for the beam sea condition.
- b) In order to simplify the procedure, certain approximations, as described below, are involved in the assessment of the applied shear forces and bending moments.

The shear force at section a) is obtained by integrating the still water and wave pressures over the frame span  $h$ . It is assumed that the sum of the still water and wave pressures is uniform along the span  $h$ . It is also assumed that 60% of the total lateral force on the frame is carried by

the lower end support: for this reason, a coefficient  $k_s = 0,6$  is introduced in the formulae for  $t_{REN,Sa}$  and  $t_{REN,Sb}$  in S31.3.4.

The shear force at section b) is assumed to be equal to that at section a) multiplied by a factor. The factor is equal to (the frame span “h” minus twice the length of the lower bracket) divided by “h” (it is assumed here that the upper and the lower brackets have the same length).

The bending moment at sections a) and b) are obtained by multiplying the total lateral force on the frame by the frame span and dividing it by coefficients “ $m_a$ ” and “ $m_b$ ”, derived from the results of Finite Element calculations. The “ $m_a$ ” and “ $m_b$ ” values depend on the loading condition of the hold to which the frame under consideration belongs.

The analyses carried out showed that, for loaded holds, the side frames may be considered as being clamped at the lower end ( $m_a = 12$ ). The coefficients “ $m_b$ ” depends, of course, on the distance from the support and hence on the bracket length.

In the case of empty holds of ships navigating in non homogeneous loading conditions (i.e. at the maximum draft) the sea pressure acting on the double bottom is not counterbalanced by internal cargo. This induces significant rotation of the hopper tanks and hence of the side frame lower ends. This rotation increases the bending moment (i.e. reduces the “ $m_a$ ” and “ $m_b$ ” values) and consequently lower coefficients have been included for this case.

- c) The load probabilities defined in a) are based on the assumption that the following probabilities:
- $10^{-7}$ , for the head sea condition,
  - $10^{-5}$ , for the beam sea condition

represent extreme sea conditions. This is based on a comparison of the  $10^{-8}$  probability loads obtained by the AHG/WD-SL with the Marin model test results and a judgement of the beam sea loads justified as follows.

In severe sea states, a Master would normally operate his ship in the head seas condition. However, a beam seas condition might occur in an emergency situation, due for instance to engine or shaft failure. In the latter case, the use of a higher load probability is justified by the need for a joint probability of occurrence of two rare events. On basis of this assumption, a stress level corresponding to yield was applied to these levels of probability.

However, the sea load formula proposed by the AHG/WD-SL gives considerably higher values of side pressure than those given by current class rules of some societies and/or calculation results of long term predictions carried out by some societies. The values of probability have been modified as specified in a) above and the stress levels have been reduced accordingly.

Both the load probability of exceedance and the “ $m_a$ ” and “ $m_b$ ” values are consistent with an elastic behaviour of the side frames. Consequently, the normal and shear allowable stresses are obtained by multiplying the yield stress by appropriate safety factors (0,90 for the normal stresses and 0,40 for the shear stresses).

Notes by the Permanent Secretariat

1. In order to lift its reservation to the bending strength check in S31.3.4, NK put forward the following amendment to the renewal thickness in S31.2.1.

*the strength check is to be carried out when  $t_M \leq t_{COAT}$*

GPG 53 (Oct.2002) agreed this and further decided that  $t_{RENS}$  need not be taken as more than  $0.75t_{S12}$ , allowing that Members were free to apply the stricter requirements should they wish. Hence, the following was added to S31.2.1:

*but the  $t_{RENS}$  as obtained from S31.3.3 need not be taken more than  $0.75 t_{S12}$*

2. At the time of approval of S31, revision of S12 had not been completed. WP/S was expected to complete the remaining task to develop shear and bending checks for inclusion into S12 which would be similar to those given in S31. See S12 (Rev.4).
3. Implementation schedule is the same as that for URs S26 and S27.
4. Date of approval of S31: 14 November 2002 (2219\_ICd).

\*\*\*\*\*



## **Technical Background UR S 31 (Rev. 2)**

### **1. Objective**

To make UR S31 apply to OBOs of single side skin construction not built to S12(Rev.1) and its subsequent revisions (s/n 2219j).

### **2. Background**

GPG found that:

There are OBOs of single side skin construction not built to S12(Rev.1) or subsequent revisions;

Hence, these OBOs may be subject to much the same risk of side shell frame damage and corrosion as single side skin bulk carriers.

GPG decided that the scope of application of UR S31 should be expanded to OBOs, as defined in UR Z11, of single side skin construction.

### **3. Amendment**

Permanent Secretariat and WP/S Chairman prepared a draft revision.

The implementation schedule for OBO carriers is given in the text.

2 July 2004  
Prepared by the Permsec

# UR S31, Technical Background Document

(Rev.3, Nov 2005)

Revision of UR S31 Renewal Criteria for Side Shell Frames and Brackets

## Scope and objectives

- 1) The difficulty that was observed in the uniform implementation of UR S31 (Rev.2 July 2004) by surveyors/class societies due to unclear descriptions was questionable.
  - 2) Verification of UR S31 by UK MCA is reported in DE48/INF.6.
- Taking the above into consideration, modify UR S31 based on experience gained from its implementation and review UK's verification.

## Points of discussions or possible discussions

Ex-WP/SRC clarified the operational issues/problems which were obtained from each member's experiences gained from its implementation, and suggested ex-WP/S to revise UR S31.

Ex-WP/S modified UR S31 Rev.2 based on the comments and the consideration of UK MCA report as follows:

- 1) The following underlined texts are added:

### **S31.1 Application and definitions**

In the case a vessel as defined above does not satisfy above definition in one or more holds, the requirements in UR S31 do not apply to these individual holds.

### **S31.2.1.1 Symbols used in S31.2.1**

$t_{S12}$  = thickness, in mm, as required by UR S12 (Rev. 3) in S12.3 for frame webs and in S12.4 for upper and lower bracket webs

### **S31.2.1.2**

(c)  $t_{REN,d/t}$  (applicable to Zone A and B only)

### **S31.2.1.2.1**

a) Lower brackets

Lower brackets are to be flanged or face plate is to be fitted.

c) Immediately abaft collision bulkhead

For the side frames, including the lower bracket, located...

### **S31.2.1.2.4**

When the measured frame webs thickness  $t_M$  is such that  $t_{REN} < t_M \leq t_{COAT}$  and the coating is in GOOD condition, sand blasting and coating as required in a) above may be waived even if not found in "as-new" condition, as defined above, provided that tripping brackets are fitted and the coating damaged in way of the tripping bracket welding is repaired.

### **S31.2.2 Thickness measurements,....**

When flanges of frames or brackets are to be renewed according to S31, the outstanding breadth to thickness ratio is to comply with the requirements in UR S12.5.

**S31.2.6 Renewal of all frames in one or more cargo holds**

*When all frames in one or more holds are required to be renewed according to UR S31, the compliance with the requirements in UR S12 (Rev. 1) may be accepted in lieu of the compliance with the requirements in UR S31, provided that:*

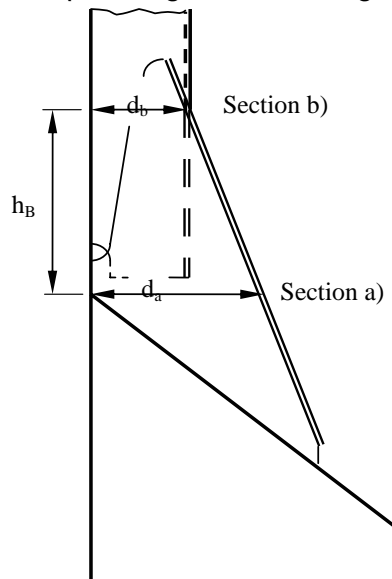
- *It is applied at least to all the frames of the hold(s)*
- *The coating requirements for side frames of "new ships" are complied with*
- *The section modulus of side frames is calculated according to the Classification Society Rules.*

**S31.3.4 Bending strength check**

**Table 2 – Bending moment coefficient  $m_a$  and  $m_b$**

$m_b$		
$h_B \leq 0,08h$	$h_B = 0,1h$	$h_B \geq 0,125h$

**S31.3.4 Figure 2 (following sketch showing lapped connection to be added)**



- 2) The following correction is made as underlined:

**S31.2.1.2.1**

*b) Tripping bracket alternative*

*When  $t_M$  is less than  $t_{REN,d/t}$  ~~at section b)~~ in zone A of the side frames, ....*

**Source/ derivation of proposed interpretation**

Ex-WP/S

**Decision by voting**

N.A.

**Appendix**

N.A.

Submitted by Hull Panel Chairman

1 July 2005

**Permsec's Note (03/11/2005):**

**1. S31.2.1.2.1b**

Based on the recommendation from the Hull Panel Chairman, GPG agreed that no change be made to S31.2.1.2.1b in Rev.3.

Hull Panel was instructed to further clarify this item. Hull Panel advised that it would be incorporated in the internal guidelines for UR S31 which was being developed under Hull Panel Task No. 21. Hull Panel was also instructed to propose, if found necessary, a suitable amendment to S31.2.1.2.1b) for a future revision of S31, once they clarify the matter in the internal guidelines.

**2. Uniform implementation date**

Council agreed that the uniform implementation date should be '1 July 2005' (5028hICa, 5028hBVc of 16 Nov 2005).

**END**

## UR S32[DRAFT] "Local Scantlings of Double Side Skin Structure of Bulk Carriers"

### Part A. Revision History

Version no.	Approval date	Implementation date when applicable
DELETE (May 2010)	-	-
DRAFT (Nov 2004)	-	-

- **DELETE (May 2010)**

Draft UR S32 was never issued (although the draft was made available on the IACS website for public information) since it was superseded by the IACS Common Structural Rules for Bulk Carriers produced by the IACS Joint Bulker Project (JBP). Following a review of all UR S files to consider whether or not they are applicable to ships covered by the CSR (Hull Panel Task 50) it was decided to withdraw the draft UR S32 [GPG approval ref. 10051\_IGd (24 May 2010)].

- **DRAFT (Nov 2004)**

See TB document in Part B.

## Part B. Technical Background

List of Technical Background (TB) documents for UR S32[DRAFT]:

Annex 1. **TB for Draft Resolution (Nov 2004)**

See separate TB document in Annex 1.



**Note:** *There is no separate Technical Background (TB) document for Delete (May 2010).*



## Technical Background – UR S32(not adopted)

Annex 1. TB prepared by WP/S, 29 November 2003.

Annex 2. IACS submission to IMO DE 47, 23 December 2004.

Annex 3. AHG/WD-SL's proposed LCF Table, 16 March 2004.

### Note: Summary of GPG discussion (October 2004)

1. The GPG Chairman's message 3056FIGf of 06/10/2004 is quoted:

**Quote:**

6 October 2004

Considering all received answers (ABS, RINA, GL, NK, DNV, LR and CCS) , there is unanimous agreement to support the course of action proposed under point 5 of my mail IGe. Permsec is then invited to act accordingly. In addition, five members (ABS, GL, DNV, LR and CCS) supported the proposal made by Steve in his message ABb.

Message ABb deals with the LCF table contained in GPG 56/8.1.3/WP-1, annex 2. This table was intended to modify the text of UR S32 by introducing LCF values explicitly dependent of the loading condition (column 2 full load and column 4 ballast condition).

This idea was further developed and generalised by JTP and JBP in two slightly different ways:

1. JTP provides different tables for the full load and ballast cases, and modifies LCF values of GPG 56/8.1.3/WP-1, annex 2
2. JBP has LCFs explicitly dependant of the loading condition through the ratio: loading condition draft / full load draft, based on results of AHG/WD-SL and other experimental (test model basin) results as explained in the load TB document available on the JBP website.

In both cases, the table given in GPG 56/8.1.3/WP-1, annex 2 was an intermediate step in the process leading to the present load formulations of JTP and JBP. These two formulations are now under review by a small JTP/JBP group on loads under the auspices of RTH in order to harmonise them.

Based on the above, my suggestion is to consider task FUA 28.2 as closed, considering that the conditions in ABb item 1 are met, simply adding GPG 56/8.1.3/WP-1 annex 2 in the TB document of UR S32 as suggested by Laura.

If members prefer to apply item 2 of ABb and modify the text of UR S32, I simply insist on the fact that it is better to add two different tables in UR S32, one for full load, the other one for ballast condition, keeping the numerical values of GPG 56/8.1.3/WP-1, annex 2 of course, as the substantial difference mentioned hereabove is not obvious and even partly masked reading the table formatted as in document GPG 56/8.1.3/WP-1, annex 2, which looks superficially similar to the one presently in the UR (you have to read the explanations under the table and notice that column 2 is now under beam sea). I doubt that Permsec is able to perform this task without proper technical support.

Members opinion on application of item 1 or 2 of ABb is requested in order to definitely close this task during GGP 57 meeting.

Best regards,

Jean-françois Segretain  
IACS GPG Chairman

**Unquote**

2. GPG finally decided at its 57<sup>th</sup> meeting (18-20 October 2004):

GPG 57 FUA 18: To insert the LCF Table (GPG 56/8.1.3/WP-1/Annex 2) to the Technical Background document for the draft UR S32 with the following statement:

*The LCF Table has been considered in the development of the Bulker Rules by JBP and in the rule harmonization between JBP and JTP rules by the AHG/RTH.*

**With this action, WP/S Task 71 is closed.**

See Annex 3.



**Annex 1.**

**IACS WP/S Task 71**

**UR Sxx on the local scantling of DSS structures of Bulk  
Carriers**

Chairman Submission to GPG

Genoa, 29 November 2003

## 1. Outcome of IACS WP/S Task 71

UR Sxx finalised by the WP/S, which includes the criteria for local scantling of DSS structures of Bulk Carriers, is submitted to GPG for approval.

In considering this UR, please note that:

- 1.1 The criteria for the evaluation of the net scantlings of double side structures of Bulk Carriers, excluding fatigue, have been agreed by the WP/S.
- 1.2 The criteria relevant to the fatigue check of longitudinal and transverse side shell stiffeners have agreed by all Members except NK. The motivation of the NK reservation is reported in Appendix.

It is to be pointed out that WP/S Members, except NK, agreed on the fatigue check criteria provided that these criteria could be further considered and improved during the development of IACS common Rules. In particular, ABS considers that it is questionable to include these fatigue criteria in UR Sxx as more time is needed to refine them.

- 1.3 Two different approaches for the evaluation of the corrosion additions and, therefore, for calculating the gross scantlings from the net scantlings have been considered by WP/S:
  - a) The first one was originally proposed by NK and is based on the statistics provided by the WP on Hull Damages some years ago. This approach was discussed under WP/S Task 22.
  - b) The second one was proposed by ABS, during the last WP/S meeting, which was held at RINA H.O. from 28 to 30 October 2003. This proposal is based on the ABS corrosion statistics and experience, as well as those of DNV and LR.

The main differences between the two approaches a) and b) are relevant to the following aspects:

- value of corrosion additions, to be added to the net scantlings. The major difference is in the side shell plating corrosion addition,
- rounding of net thickness and corrosion additions,
- calculation of the steel renewal thickness on the basis of the net thickness and corrosion additions.

A document reporting the differences between the two proposals in term of total corrosion additions for each hull structural element is enclosed for prompt reference.

Since a unanimous consensus was not reached within the WP/S, both documents are presently submitted to GPG:

- UR Sxx proposal 1, including corrosion additions as per proposal in 1.3 a),
- UR Sxx proposal 2, including corrosion additions as per proposal in 1.3 b).

These two documents have already been submitted to WP/S Members for voting. The vote results is that BV, CCS, KR, NK and RINA support proposal 1, whilst ABS, DNV, GL, LR and RS support proposal 2.

The WP/S requests the GPG to task the IACS WP/SRC to examine the matter in order to define the corrosion addition approach that best fits with IACS Societies' experience on corrosion and steel renewal criteria.

## **2. Double side space length**

During the last WP/S meeting, Members raised the question whether UR Sxx should require double side spaces having length not greater than the hold in way.

After discussion, Members agreed to request the GPG to task IACS WP/SLL to give advice on this aspect, which involves also stability related problematic.

Anyway, while waiting for the WP/SLL advice, the WP/S agreed to include the two following options in UR Sxx regarding the position of transverse bulkheads in double side spaces:

1. the first option requiring transverse bulkheads (tight or non-tight) to be fitted and aligned with the cargo hold transverse bulkheads,
2. the second option requiring transverse tight bulkheads to be fitted and aligned with the cargo hold transverse bulkheads.

A final decision on the option to be considered should be taken after receiving the WP/SLL advice.

## **3. Actions requested to GPG**

The following actions are kindly requested to GPG:

1. Approve UR Sxx as far as the net strength criteria are concerned.

The WP/S deems that, when submitting UR Sxx to IMO, IACS should point out that the net strength criteria in UR Sxx, in particular those regarding the fatigue checks, will be further progressed and improved in the course of the on-going development of the IACS common Rules on Double Side Skin Bulk Carriers.

2. Note the NK reservation and ABS considerations relevant to the fatigue checks of longitudinal and transverse side shell stiffeners.
3. Task the WP/SRC to define the corrosion addition approach, between the two proposed by WP/S Members, that best fits with IACS Societies' experience on corrosion and steel renewal criteria.

4. Task the WP/SSL to give advice on the double side spaces length.

## **Appendix – Details of NK reservation on UR Sxx fatigue criteria**

The following text has been extracted from NK's message to WP/S of 28/11/2003.

NK expresses their disagreement with the fatigue criteria incorporated in the draft UR Sxx, while NK agree with the other part of UR Sxx, for the following reasons:

1. NK checked the information given by DNV e-mail received on 2003/11/28 5:26 at Tokyo and made comparison of the estimated damage Minor sum with damage experience for the vessel DNV1 engaged in North Atlantic route as shown in the enclosed file. This comparison shows the same tendency of damage experience as NK showed for many oil tankers engaged in PG-Japan route that ballast water tanks sustains many fatigue cracks on the longitudinals in the vicinity under the ballast water line but not under the full load water line. However, the estimated damage given by UR Sxx fatigue criteria appears maximum in the vicinity under the full load water line. This crucial discrepancy gives unacceptable loss of credibility to IACS because the draft UR requires to make reinforcement to the structure which is not likely to sustain fatigue damage while leaving the structure of high risk of fatigue damage not reinforced.
2. NK reviewed the impact of UR Sxx (finalised at the last meeting of ISG/F) given to the current design of DSS bulk carrier and it shows that maximum damage is over 17 for handysize and over 12 for overpanamax and that they resulted in the increase of section modulus of side longitudinals by 20% to 40% in addition to the modification of angle section to T type section of longitudinals for almost all the side longitudinals within the DSS space. This impact is recognised too much.
3. After consult with NK AHG/WD-SL member for the modification of load formula, which was made at the last meeting, it was realised that the modification made was not discussed nor agreed in AHG/WD-SL. Therefore, it needs discussion within AHG/WD-SL.
4. Load model including LCF and stress combination factor was not discussed in an appropriate manner and still needs discussion within AHG/WD-SL.
5. In view of the above, the fatigue criteria should be discussed spending some more time because WP/S have some time to submit it to IMO DE 47.

## **DOUBLE-SIDE SKIN CONSTRUCTION OF BULK CARRIERS**

### **Structural requirements for bulk carriers of double-side skin construction**

**Submitted by the International Association of Classification Societies (IACS)**

#### **SUMMARY**

<i>Executive summary:-</i>	This paper summarises the work carried out by IACS for the development of unified strength requirements for double-side skin bulk carriers and provides information to the Sub-Committee on the IACS requirements under development.
<i>Action to be taken:-</i>	Paragraph 13.
<i>Related documents:-</i>	DE 46/32 paragraphs 24.14 and 24.15.

1. DE 46 noted that the information available on longitudinal strength of double-side skin bulk carriers was not sufficient for thorough examination of strength aspects of such ships and invited Members and international organisations to provide information to DE 47 on aspects of local, longitudinal and global strength for further discussion.
2. At DE 46, the IACS observer informed that IACS is currently developing scantling standards for double-side skin bulk carriers. This paper aims at providing information to the Sub-Committee on the IACS requirements under development.
3. The IACS on going work on the structural scantling of double-side skin bulk carriers includes the criteria for the local scantling of the double-side structures comprised between the hopper and the topside tanks, as well as the criteria for direct strength analyses of cargo hold structures.
4. In elaborating their requirements, IACS took into account the definitions and characteristics of double-side skin bulk carriers agreed at MSC 77.
5. The criteria for the local scantlings of the double-side structures, intended to be applied to side shell, inner side, transverse bulkheads, web frames and stringers, are defined in draft IACS Unified Requirement S32. They are based on the yielding, buckling and fatigue strength criteria, adopting a net scantling approach.
6. The criteria for the direct analysis of cargo hold structures are under development in IACS Unified Requirement S33. They are based on the Finite Element analysis of cargo hold structures and the yielding and buckling strength criteria, adopting the net scantling approach to be consistent with UR S32.

7. The net scantling approach entails that the scantlings obtained from the draft UR S32 strength requirements do not include any corrosion margin. The required scantlings, to which a ship is to be built, are obtained by adding appropriate corrosion additions to these net scantlings. The corrosion additions are to be defined as a function of the corrosive severity of the environment (cargo holds, ballast tanks, void space, outside sea and air) in which each structural element is located. Steel renewal criteria are specified for each structural element by defining the thickness at which steel renewal is required or, in other words, its corrosion margin which is within the corrosion additions.
8. The load model adopted in draft UR S32 and S33 has been developed on the basis of extensive work carried out by IACS, including seakeeping direct calculations carried out for a number of bulk carriers of different sizes.
9. The requirements contained in the draft UR S32 and S33 are intended to be included as part of a comprehensive set of common structural Rules that IACS is developing on double-side skin bulk carriers. In this sense, the requirements in the draft UR S32 and S33 will be revised and updated in the course of the development of these IACS common Rules.
10. In particular, the present text of draft UR S32 incorporates two alternatives for the corrosion additions and steel renewal criteria. Both alternatives are based on the experience gained by IACS Members in surveying their classed fleets. Further work is already ongoing to resolve which criteria are to be used in the IACS common structural Rules.
11. The fatigue strength criteria included in the draft UR S32 are based on a simplified formulation and will be subject to further improvements as a result of the on-going IACS common Rules developments.
12. The above-mentioned draft UR S32 is available on the IACS website at [www.iacs.org.uk](http://www.iacs.org.uk) for information.

**Action requested of the Sub-Committee.**

13. The Sub-Committee is requested to note the above information.

\* \* \*

### **Annex 3 (TB for UR S32)**

**1. The LCF Table for UR S32 is contained in the AHG/WD-SL 2003 Progress Report. This table was intended to modify the text of UR S32 by introducing LCF values explicitly dependent of the loading condition (column 2 full load and column 4 ballast condition). This idea was then further developed and generalised by JTP and JBP in two slightly different ways:**

- a) JTP provides different tables for the full load and ballast cases, and modifies LCF values of the AHG/WD-SL Table;
- b) JBP has LCFs explicitly dependant of the loading condition through the ratio: loading condition draft / full load draft, based on results of AHG/WD-SL and other experimental (test model basin) results as explained in the load TB document available on the JBP website.

In both cases, the Table prepared by the AHG/WD-SL was an intermediate step in the process leading to the present load formulations of JTP and JBP. These two formulations are now under review by a small JTP/JBP group on loads under the auspices of the AHG/RTH in order to harmonise them. GPG 57 decided that this LCF Table should be included in the TB document for UR S32. WP/S Task 71 is thereby completed.

**2. The following is quoted from the AHG/WD-SL 2003 Progress Report (3019aGLa, AHG/WD-SL Annual Progress Report 2003, 17 March 2004).**

\* \* \*

#### **AHG/WD-SL new task 12: To develop the load model for the UR on double side skin structures of bulk carriers.**

Most of the group's activities in the last year were dealing with their new task 12. Here, especially the development of a load model to be used to determine the local scantling of double side skin structures of Bulk Carriers was pursued. This task may be subdivided into two main subtasks:

- 1) To determine rule formulations for local loads, ship motion parameters, ship accelerations and horizontal wave-induced bending
- 2) To accomplish a load combination factor table for general wave load cases

The outcome of those activities is given in chapter Sxx2 of the UR Sxx files as attached to an email referenced "3056fRIa: Outcome of IACS WP/S Task 71 - UR Sxx on the local scantling of DSS structures of Bulk Carriers" of the WP/S chairman Dino Cervetto from the 1st of December 2003. An excerpt containing the load formulations are given in annex 1.



However, the AHG/WD-SL recommended updating some figures in the UR Sxx according an email referenced "IACS AHG/WD-SL Task 12: FUA 15.3 from GPG 55" from the AHG/WD-SL chairman dated 9th of November 2003. The respective recommendations may be deduced from annex 2.

According to C48 FUA5 this task had to be closed. However, the preparation of the technical background paper for the loads documented in annex 1 and annex 2 has not finalised yet. Because most of the load formulations are the basis for JTP and JBP rule formulations GPG is requested to agree to finalise the preparation of the technical background documentation by third quarter of this year.

**GPG is requested to note the progress.**

**Annexed. AHG/WD+SL Comments on UR Sxx (S32)****1) UR Sxx: Table 1 – Load combination factors (LCFs)**

Load parameter	Load combination factor	Head Sea	Beam Sea			Oblique Sea
		1: Max external pressure	2: Max internal pressure	3: Max external pressure	4: Max internal pressure	5: Max horizontal bending moment
$p_w$	$C_w$	1,0;1,0;1,0 1,0 [1,0]	0,9;0,8;0,8 0,8 [0,1]	1,0;1,0;1,0 1,0 [1,0]	0,6;0,6;0,5 0,5 [0,5]	0,4;0,7;0,2 0,7 [0,7]
$a_v$	$C_{Av}$	0,5;0,3;0,4 0,5 [0,3]	1,0;1,0;1,0 1,0 [1,0]	1,1;1,0;0,8 1,0 [1,0]	0,8;0,9;0,9 0,9 [0,7]	0,4;0,2;0,3 0,4 [0,2]
$a_T$	$C_{AH}$	0,0;0,0;0,0 0,0 [0,0]	0,7;1,0;0,9 1,0 [0,0]	0,6;0,5;0,5 0,5 [0,5]	1,0;1,0;1,0 1,0 [1,0]	0,5;0,0;0,2 0,5 [0,0]
$a_L$	$C_{AL}$	1,0 [0,5]	0,1 [1,0]	0,1 [0,0]	0,1 [0,0]	0,5 [0,5]
$M_V$	$C_{wvbm}$	0,4;1,0;0,2 1,0 [1,0]	0,3;0,4;0,7 0,4 [1,0]	0,4;0,3;0,6 0,3 [0,25]	0,1;0,1;0,1 0,1 [0,1]	0,2;0,2;0,2 0,2 [0,2]
$M_H$	$C_{whbm}$	0,0;0,0;0,0 0,0 [0,0]	0,3;0,2;0,1 0,2 [0,0]	0,1;0,3;0,1 0,3 [0,1]	0,3;0,2;0,8 0,2 [0,2]	1,0;1,0;1,0 1,0 [1,0]

The first LCF stands for the foremost hold, the second LCF for the amidships hold and the third LCF for the aftermost hold. The **LCFs marked in blue** represent values merged from all three holds whereas the LCFs in square brackets represent the current UR Sxx values.

The LCFs for the foremost hold and amidships hold were developed from direct calculations performed for a handy size, a panamax and a capesize bulk carrier. Here, following procedure was applied:

Columns 1, 3 and 5: Full load condition to maximise loads on side shell

Column 2: Full load condition or heavy ballast condition for inner bottom

Column 4: Heavy ballast and Normal ballast to maximise internal liquid loads on inner side

The aftermost hold merely developed from direct calculations for panamax bulk carrier. Here following procedure was applied:

Columns 1, 2, 3 and 5: Full load condition to maximise loads on side shell and inner bottom

Column 4: Normal ballast to maximise internal liquid loads on inner side

The considered loading conditions comprise:

- Full load homogenous heavy cargo
- Heavy ballast
- Normal ballast

**2) The roll amplitude in UR Sxx is recommended to read:**

$$\theta [\text{deg}] = \frac{9000 \cdot (1,25 - 0,025 \cdot T_{roll}) \cdot k_b}{(B + 75) \cdot \pi}$$

*with :*

$$T_{roll} [\text{sec}] = \frac{2,3 \cdot k_r}{\sqrt{GM}}$$

All parameters are denoted according to UR Sxx.

**3) Cr in “Sxx.2.2 – Wave pressure load” is recommended to read:**

$$Cr = \left( 1,25 - 0,025 \frac{2,3 \cdot k_r}{\sqrt{GM}} \right) \cdot k_b$$

**4) GM and kr in UR Sxx are recommended to read:**

Following values are recommended to be used in UR Sxx for the initial metacentric height GM and the roll radius of gyration kr:

	Full load homogenous heavy cargo	Full load homogenous light cargo or alternate heavy cargo	Heavy ballast	Normal ballast
GM	0,12 B	0,18 B	0,25 B	0,33 B
kr	0,35 B	0,38 B	0,40 B	0,45 B

## UR S33 "Requirements for Use of Extremely Thick Steel Plates in Container Ships"

### Summary

The Rev.3 is issued to take into account the deletion of Recommendation 20 and adoption of new UR W33, which are effective from 01 July 2021.

### Part A. Revision History

Version no.	Approval date	Implementation date when applicable
Rev.3 (Feb 2020)	18 February 2020	01 July 2021
Rev.2 (Dec 2019)	2 December 2019	01 January 2021
Rev.1 (Sept 2015)	30 September 2015	01 January 2017
New (Jan 2013)	21 January 2013	01 January 2014

- **Rev.3 (Feb 2020)**

#### 1 Origin of Change:

- Based on IACS Requirement

#### 2 Main Reason for Change:

Changes made to reflect the adoption of new UR W33 and deletion of Recommendation 20.

#### 3 List of non-IACS Member classification societies contributing through the TC Forum and/or participating in IACS Working Group:

None

#### 4 History of Decisions Made:

GPG instructed the Hull Panel to proceed to the Corrigenda (19120\_IGe). Hull Panel vide PHc dated 23 Dec 2019 provided the draft Corr.1 to Rev.2 of the UR S33 and its associated HF/TB to GPG for approval. However, considering that the UR W33 has an implementation date of 01 July 2021, and Rec.20 is still applicable till the implementation of UR W33, GPG decided to adopted a revision instead of correction, so that the implementation dated of the revision (i.e Rev.3) of UR S33 matches with the implementation date of UR W33.

#### 5 Other Resolutions Changes:

UR Z23, Rec.47

**6 Any hinderance to MASS, including any other new technologies:**

None

**7 Dates:**

Original Proposal : December 2019  
Panel Approval : 23 December 2019 (Ref: PH16017\_IHr)  
GPG Approval : 18 February 2020 (Ref: 19120\_IGi)  
GPG Approval for TB Annex 3: 29 January 2021 (Ref: 21004\_IGb)

• **Rev.2 (Dec 2019)**

**1 Origin for Change:**

- Other (GPG 81 FUA 27 tasks HP to review UR S33)

**2 Main Reason for Change:**

Put in consistency the UR S33 in line with the update of UR W31 for brittle crack arrest steels.

The EG/M&W and HP agreed to split the requirements for ship design into the UR S33 and those covering the steel material characteristics and approval into the UR W31.

**3 List of non-IACS Member Classification Societies contributing through the TC Forum and/or participating in IACS Working Group:**

N/A

**4 History of Decisions Made:**

During the development of the UR W31, the EG/M&W asked confirmation to Hull Panel that the large test conditions were in line with design of container ships. The confirmation given by HP allowed to adjust the restrictions of application of BCA steel in the URs W31 and S33.

**5 Other Resolutions Changes:**

UR W31

**6 Any hinderance to MASS, including any other new technologies:**

None

**7 Dates:**

Original Proposal: October 2016 (Made by GPG 81)  
Panel Approval: 8 November 2019 (Ref: 19120\_PHb)  
GPG Approval: 3 December 2019 (Ref: 19120\_IGe)

- **Rev.1 (Sept 2015)**

**.1 Origin for Change:**

- Suggestion by an IACS member

**.2 Main Reason for Change:**

Address the comments raised following the publication of UR S33.  
Amend UR S33 by removing material related content and transferring this to UR W31.  
Amend UR S33 by transferring design related content from UR W31.

**.3 List of non-IACS Member Classification Societies contributing through the TC Forum and/or participating in IACS Working Group:**

None

**.4 History of Decisions Made:**

Members concurred that annex 2 standard ESSO test in UR S33 should be transferred to UR W31. Also they agreed that the paragraph 1.4 hull structures (for the purpose of design) should be transferred from UR W31 to UR S33.

One member suggested to remove the paragraph 4.3.1(e) because they thought that the application of enhanced NDT particularly time of flight diffraction (TOFD) technique might be a high risk option.

One member proposed "FCAW" in Table 1 of Annex 1 to be replaced to "welding procedures other than EGW".

Members agreed to include Fig. 2 and details in order to explain other weld areas in the paragraph 4.2.1(b).

Panel agreed that the crack arrest properties for brittle design should be transferred from UR S33 and defined in UR W31. Two members argued that they would prefer the crack arrest properties for brittle design should be included in UR S33.

Panel approved the proposal to include the brittle crack arrest properties for YP36 and YP40 in UR S33 4.1.3. A member commented that the proposal should be reconsidered depending on the EG/M&W position about inclusion or not of brittle crack arrest properties for YP36 and YP40 in the revised W31.

A member supported the proposal of asking EG/M&W to find the best place for definition of crack arrest properties for YP36 and YP40.

No TB is expected for the present revision.

**.5 Other Resolutions Changes**

None

**.6 Dates:**

Original Proposal: *20 September 2013 made by: Panel Member*

Panel Approval: *09 July 2015 (Ref: PH13026\_IHy)*

GPG Approval: *30 September 2015 (Ref: 14139\_IGf)*

• **New (Jan 2013)**

**.1 Origin for Change:**

- Suggestion by the Japan Society of Naval Architects and Ocean Engineers (JASNAOE)

**.2 Main Reason for Change:**

None - new document.

**.3 List of non-IACS Member Classification Societies contributing through the TC Forum and/or participating in IACS Working Group:**

None

**.4 History of Decisions Made:**

See technical background.

**.5 Other Resolutions Changes**

None

**.6 Dates:**

Panel Approval: *26 November 2012 (By Hull Panel)*

GPG Approval: *21 January 2013 (12215\_IGc)*

## Part B. Technical Background

Annex 1. **TB for New (Jan 2013)**

See separate TB document in Annex 1.

Annex 2. **TB for Rev.2 (Dec 2019)**

See separate TB document in Annex 2.

Annex 3. **TB for Rev.3 (Feb 2020)**

See separate TB document in Annex 3.

**Note:** *There are no Technical Background (TB) document availables for Rev.1 (Sept 2015).*





## Technical Background document for UR S33 (New, Jan 2013)

### 1. Scope and objectives

An increase in the size of container ships has led to the application of thicker steel plates to their hull structures.

Safety-related issues regarding the use of extremely thick steel plates concerning brittle fracture toughness and brittle crack arrestability have been identified with the above trend.

Under this situation, some classification societies have developed their own guidelines related to the issues which need to be unified.

IACS has recognized that it is necessary to develop unified requirements for the safety use of extremely thick steel plates.

### 2. Engineering background for technical basis and rationale

The following issues were highlighted that IACS needed to address:

- (1) Application of the safety measures on extremely thick steel plates is to be determined (Steel grade, minimum and maximum thickness of plates, targeted structural members etc.)
- (2) Countermeasures to prevent brittle crack initiation including NDT are to be specified for both new ships and existing ships.
- (3) Countermeasures to prevent brittle crack propagation are to be specified.
- (4) Related guidelines already developed by some classification societies can be referred to.

Taking the above into account, a project team PT52 was asked to draft a new IACS UR, UR S33, to specify the application of safety measures and the countermeasures to prevent initiation and propagation of brittle cracks.

Based on review comments made during development, the following TB items are noted:

Section 2.2.2: This text is related to crack initiation prevention and is also covered in Annex 1 Measures 1 and 2 as clarified by Notes \* and \*\*.

Section 4.3.1(e) Enhanced NDT other than TOFD may be accepted in accordance with each Class Society's procedures, provided proof of equivalence to TOFD is given.

### 3. Source/derivation of the proposed IACS Resolution

- Application of Safety Measures of Extremely thick steel plates prepared by PM for discussion in PT52.

A:

- Guide for application of higher-strength hull structural thick steel plates in container carriers

B:

- William S. Pellini, Principles of structural integrity technology, United States. Office of Naval Research, 1976
- Bannister A.C., Stacey A. (1999). Literature review of the fracture properties of grade a ship plate Proceedings of OMAE Conference, St. John Newfoundland, July

C:

- Classification notes no. 30.10, Extra high strength steel material NV47 for hull structural application in container ships

D:

- Supplementary Rules for Application of Steel with Yield Strength of 460 N/mm<sup>2</sup>
- Olaf Doerk, "Development of Toughness and Quality Requirements for YP47 Steel Welds Based on Fracture Mechanics", Proceedings of the Nineteenth (2009) International Offshore and Polar Engineering Conference

E:

- Circular No. 2011-10-E, Instruction for the application and inspection of extremely thick steel plates
- Gyu Baek An et al, "Brittle Crack Arrest Technique of Thick Steel Plate Welds in Container Ship", Proceedings of the Nineteenth (2009) International Offshore and Polar Engineering Conference

F:

- S E Webster, "Fracture Crack Path Direction in the Vicinity of Welded Joints"

G:

- Guidelines on Brittle Crack Arrest Design
- Y. Yamaguchi et al., "Development of Guidelines on Brittle Crack Arrest Design- Brittle Crack Arrest Design for Large Container Ships -1 -", Proceedings of the Twentieth (2010) International Offshore and Polar Engineering Conference
- Yoichi Sumi et al., "Overview of Japanese Joint Research Project on Safety-Related Issue of Extremely Thick Steel Plate Applied to Large Container Ships", 11th International Symposium on Practical Design of Ships and Other Floating Structures

**4. Summary of Changes intended for the revised Resolution:**

Not applicable

**5. Points of discussions or possible discussions**

For existing ships members have decided to remove the initially intended requirements from this UR text due to following reason:

Retrospective examination of existing ships was considered, but based on variable testing experiences carried out by a number of members and the lack of in-service problems, it was decided not to introduce requirements for inspection of existing ships.

**6. Attachments if any**

None

## Technical Background document for UR S33 (Rev 2, Dec 2019)

### 1 Scope and objectives

This rev.2 is made to provide clarifications on the conditions to use the brittle crack arrest steels (BCA steels) for the design of container ships in agreement with the large scale tests performed by the Japanese industry (Ref [1]) which allow to define the material properties requested in the UR W31 such as:

- Stress limit at the level of the deck
- Type of BCA as a function of the structural members and the corresponding thickness (BCA1 or BCA2)
- Weld detail between hatch coaming side and deck.

The objectives of this revision were, when brittle crack arrest steel method is used, to introduce requirements for avoiding the actual stresses of the ship at the deck do not overpass the reference stresses used for the large scale tests defining the BCA steel properties (Kca values) in UR W31.

### 2 Engineering background for technical basis and rationale

The BCA steel applications are based on a joint industry research project (JIP) organised by the Japanese Industry (Ref [1]). The report and results of this JIP have been used to determine the required Kca value of the brittle crack arrest steels (BCA steels) specifically for steel plates with thickness of over 80 mm. This report has been provided by the JIP to IACS for its own use but without allowing IACS to disclose it outside.

Large scale tests have been performed for measuring the conditions in which the brittle crack are stopped in the steel plates. The real designs of container ships with thick plates are to comply with the conditions of the tests; outside the test conditions, it is not sure the BCA steel will have the capacity to play its role, i.e. to stop the crack propagation.

Two main scenarios were considered:

- A crack initiation in the deck propagating into the hatch coaming side plate,
- A crack initiation in the hatch coaming side plate propagating into the deck plating.

No tests were performed for checking that a crack initiation in the hatch coaming side plate may or not propagate into the hatch coaming top plating. This explains why no requirement is provided for the BCA steel application in the hatch coaming top plating.

The longitudinal stiffeners are not supposed to be in BCA steels.

At the time of the tests, the Japanese industry used the permissible stress defined at the deck in the UR applicable for checking the hull girder strength of the container ships, i.e. UR S11. A close link is therefore established between the tests and the UR S11. The UR S11 defined the permissible stress as  $175/k$  MPa,  $k$  being the material factor defined in the UR S4 which depends on the material yield stress ( $ReH$ ). For the tests, the reference stress used by the Japanese industry for EH40 steel fitted at deck was consequently equal to  $175/0.68 = 257$  MPa.

It is important to note and remember the strong link between the performed tests and the permissible stress defined in UR S11 in the event the UR S33 or W31 for BCA steels are updated in future or if the design of container ships evolves with arrangements different from those used for the tests.

The use of BCA steels for the deck and hatch coaming side plates is based on the fact that the stress at the deck level is not exceeding the reference stress used for the tests, i.e. the permissible stress defined in the UR S11 for the deck plate. The justification that the stress at deck of container ships does not go beyond the permissible stress of the UR S11 is given in the appendix of this annex.

The tests were performed with:

- deck thickness up to 100 mm and the reference stress applied at the deck level and
- hatch coaming thickness up to 100 mm and a grade up to EH47.

The test specimens include groove shaped T-joint simulating a typical actual joint such as fillet weld or partial penetration weld between hatch coaming side and upper deck of very large container ships for thickness between 80 and 100 mm. The requested weld detail is a partial penetration weld allowing the BCA steel to stop the crack.

### **3 Source/derivation of the proposed IACS Resolution**

Joint industry research project (JIP) organised by the Japanese Industry (Ref [1])

### **4 Summary of Changes intended for the revised Resolution:**

Editorial changes:

- Replacement of "each Classification Society" by "the Classification Society",
- Harmonisation with UR S4 for the notation  $k$  (material factor), instead of  $HT(K)$ ,
- Definition of "upper deck region" for several uses and text simplification,

- Symbols used for the table in annex 1 put in a table note instead of a paragraph.

Technical changes:

- The use of BCA steel method may be used provided the steel grade material of the deck is not higher than YP40. It is implicitly agreed that the ship design must comply with the UR S11A. If the ship design incorporates steel grade materials with permissible stress greater than those corresponding to YP40, the BCA steel brittle crack arrest properties are not defined in UR W31. If BCA steels are considered in this case, such BCA steels and/or other means for preventing the crack initiation and propagation shall be agreed by the Classification Society.
- Reference to UR W31 entire document for the BCA steel instead of a specific paragraph of W31 to avoid future possible updates due to paragraph numbering.
- Introduction of a new paragraph 4.4 for defining:
  - the BCA properties as a function of the structural members and their thickness,
  - the BCA steels are not applicable to the hatch coaming top plate nor to the longitudinal stiffeners connected to the considered plating,
  - the weld joint detail (partial penetration) is to be used.

## **5 Points of discussions or possible discussions**

The content of the changes have been discussed between the Chairs of EG/M&W and Hull Panel before submitting the text to the HP Members.

Application to the longitudinal stiffeners

Application of BCA steels to the hatch coaming top plate

## **6 Attachments if any**

None

Refer

[1]: LARGE SCALE TESTS PERFORMED BY THE JAPAN WELDING ENGINEERING SOCIETY (JWES): "FINAL REPORT ON REQUIRED KCA IN HEAVY GAUGE STEEL PLATES - SUMMARY OF LARGE SCALE STRUCTURAL TEST RESULTS- SEPTEMBER 26TH IN 2017, BY THE JAPAN WELDING ENGINEERING SOCIETY (JWES), IRON AND STEEL DIVISION, ATS COMMITTEE"

## Appendix

### Condition for BCA steel plate fitted at the deck be used within the test assumptions

#### Ships considered for this study

For checking the application of the BCA steel on deck of containerships, several vessels having deck thickness greater than 70 mm but less than 100 mm have been considered.

The recent design of large containerships are made with deck thickness ranging from 70 to 95mm.

The deck material is either steel with ReH of 390 or 355 MPa (i.e. EH40 or EH36). The hatch coaming side plates have higher steel grades corresponding to ReH of 460 or 390 MPa (i.e. EH47 or EH40).

Seven container ships of different size (design approved from 2016 to 2018) have been considered for this study: 23000, 22000, 20600, 16000, 14500, 12700 and 8500 TEU. All those ships have deck and hatch coaming material within the scope of application for BCA steels as defined in the UR S33 (Rev.2).

#### Stress distribution for S11 and S11A

##### *Main Differences between S11 and S11A*

The main differences for the stress distributions in S11 (Rev.8) and S11A (New June 2015) are summarised in the following table:

Item	UR S11	UR S11A
Wave Bending Moment		Larger than for S11
Total BM= $M_{SW} + M_W$		4 to 6 % greater than S11
Inertia	Gross	Net (0.5 tc)
Permissible stress	175/k	235/1.24/k

The wave bending moment is larger in the UR S11A than in the S11 resulting in a total bending moment larger from 4 to 6 %.

Moreover the hull girder stress is calculated differently, in gross thickness in the S11 and in net thickness (0.5 tc) in the S11A.

However the permissible stress are comparable in both S11 and S11A provided the gross thickness approach is switched to the net thickness one. For a global corrosion of

about 8 %, the permissible stress defined in S11 in gross becomes:  $175/k * 1.08 = 189/k = 234.4/1.24 * 1/k \approx 235/1.24 * 1/k$  which is equal to the permissible stress in S11A in net.

In the following the focus is made on the hogging bending moment only as the bending moment in sagging is much lower than the one in hogging.

### *Ships characteristics*

The following units have been considered in the below tables:

- Length/distance: m
- Bending Moment: kNm
- Inertia:  $m^4$
- Stress: MPa



Table 1: Ship characteristics

**Ship Data**

Reference	S1	S2	S3	S4	S5	S6	S7
Capacity in TEU	23 000	22 000	20 600	16 000	14 500	12 700	8 500
L	378.106	393.9	377.1	374.614	345.32	313.417	314.765
B	61.5	61.3	59	54	51.2	48.2	42.8
T	16.5	16.0	16.0	16.0	15.5	16.0	15.0
Cb	0.743	0.737	0.708	0.72	0.713	0.69	0.678

**Midship section data**

Hatch coaming material (top)	95 EH47	90 EH47	75 EH47	85 ST460	70 EH47	70 EH40	80 ST390
k factor	0.62	0.62	0.62	0.62	0.62	0.66	0.68
Hatch coaming material (Side)	95 EH47	90 EH47	75 EH47	85 ST460	70 EH47	70 EH40	80 ST390
k factor	0.62	0.62	0.62	0.62	0.62	0.66	0.68
Deck Material	95 EH40	90 EH40	70 EH40	85 ST390	65 EH40	70 HT36	74 ST355
k factor	0.66	0.66	0.68	0.68	0.66	0.72	0.72
ZHCTop	35.600	35.400	35.100	32.000	32.200	29.200	26.350
ZDeck	33.200	33.500	33.000	30.000	30.200	27.200	24.600
ZNA (net)	15.257	15.466	15.303	14.059	14.081	12.903	12.205
VSWBM in Hogg	12 389 272	10 354 375	11 575 800	9 921 012	8 100 000	6 580 000	5 620 613
VWBM in Hogg	14 601 122	15 033 346	13 162 723	12 296 751	9 599 807	7 233 006	6 314 540
Total BM in Hogg	26 990 394	25 387 721	24 738 523	22 217 763	17 699 807	13 813 006	11 935 153
Inertia (net)	1 876.78	1 784.13	1 650.14	1 333.89	1 072.34	816.08	631.98
VWBM according to S11	13 242 318	14 106 459	12 046 112	11 075 480	8 891 295	6 672 726	5 872 302
Inertia (gross)	1954.98	1860.14	1722.31	1389.13	1122.41	854.44	660.52
ZNA (gross)	15.257	15.117	14.984	13.768	13.749	12.622	11.978

The permissible stresses and stress distributions are given in the Table 2 for the application of the UR S11A and S11 to the 7 ships.

Table 2: Midship section Hull Girder strength

S1	S2	S3	S4	S5	S6	S7
----	----	----	----	----	----	----

**Perm stress according to UR S11A**

ZHCTop	305.7	305.7	305.7	305.7	305.7	287.1	278.7
ZDeck	287.1	287.1	278.7	278.7	287.1	263.2	263.2

**Perm stress according to UR S11**

ZDeck	265.2	265.2	257.4	257.4	265.2	243.1	243.1
-------	-------	-------	-------	-------	-------	-------	-------

**Actual HG Stress according to S11A**

ZHCTop Hog	292.6	283.7	296.8	298.8	299.1	275.8	267.1
ZDeck Hog	258.0	256.6	265.3	265.5	266.1	242.0	234.1

**Actual HG Stress according to S11**

ZDeck Hog	235.2	241.7	247.1	245.3	249.0	226.1	219.6
-----------	-------	-------	-------	-------	-------	-------	-------

Table 3: Ratios between actual and permissible stresses

S1	S2	S3	S4	S5	S6	S7
----	----	----	----	----	----	----

**$\sigma_{app}/\sigma_{perm}$  according to S11A**

ZHCTop Hog	0.957	0.928	0.971	0.978	0.978	0.961	0.959
ZDeck Hog	0.899	0.894	0.952	0.953	0.927	0.919	0.889

**$\sigma_{app}/\sigma_{perm}$  according to S11**

ZDeck Hog	0.887	0.912	0.960	0.953	0.939	0.930	0.904
-----------	-------	-------	-------	-------	-------	-------	-------

The Table 3 shows the ratio between the actual and permissible stresses of the Table 2. It appears that the most severe criteria ( $\sigma_{app}/\sigma_{perm}$ ) is obtained at the top of the hatch coaming for all ships for the UR S11A application. The application of the UR S11 at the deck is less severe giving a ratio below 0.96 (between 0.887 and 0.960).

However, the actual stresses in Table 2 are based on the SWBM considered for the design approval. For the HG criteria only the SWBM can be increased until this maximum stress ratio (at the hatch coaming top) reaches 1.

*Note: it is to be noted that this increase of the SWBM concerns the HG criteria only for checking what should be the impact on the stress obtained at the deck level for the UR S11. The other criteria used for the design approval such as local strength verification or FE analysis are based on the SWBM mentioned in Table 1.*

For this increase of the SWBM, the stress distribution is given in the Table 4.

Table 4: Stress distribution when the stress ratio at HCT is 1.0

S1	S2	S3	S4	S5	S6	S7
----	----	----	----	----	----	----

**Actual HG Stress according to S11A**

ZHCTop Hog	305.7	305.7	305.7	305.7	305.7	287.1	278.7
ZDeck Hog	269.6	276.5	273.2	271.6	271.9	251.9	244.2

**Actual HG Stress according to S11**

ZDeck Hog	246.4	261.2	254.8	251.3	254.8	235.8	229.5
-----------	-------	-------	-------	-------	-------	-------	-------

Table 5: Stress Ratio when the stress ratio at HCT is 1.0

S1	S2	S3	S4	S5	S6	S7
----	----	----	----	----	----	----

**$\sigma_{app}/\sigma_{perm}$  according to S11A**

ZHCTop Hog	1.000	1.000	1.000	1.000	1.000	1.000	1.000
ZDeck Hog	0.939	0.963	0.980	0.975	0.947	0.957	0.928

**$\sigma_{app}/\sigma_{perm}$  according to S11**

ZDeck Hog	0.929	0.985	0.990	0.976	0.961	0.970	0.944
-----------	-------	-------	-------	-------	-------	-------	-------

When the SWBM is artificially increased until the stress ratio reaches 1 at the top of the hatch coaming for the stress distribution calculated according to UR S11A, the stress ratio at the deck according to S11 remains below 1 (between 0.929 and 0.990), which means that the actual stress at deck remains always below the corresponding permissible stress according to S11.

**Conclusions**

Seven ships have been used for this study ranging from very large container ships size of 23,000 TEU to ships of 8,600 TEU which are considered as representative of the current containership designs. All these ships are within the scope of application of the UR S33 for BCA steel in term of arrangement, deck thickness and steel materials. All of them have their maximum stress at deck complying with the UR S11 permissible stress when the ship design complies also with hull girder strength criteria of the UR S11A at the deck and hatch coaming top.

In conclusion, when the ship design complies with the hull girder strength criteria at the deck and the top of the hatch coaming according to UR S11A, the stress at the deck level made of steel grade material not higher than YP36 or YP40 remains also within the acceptable limit used by the Japanese Industry (Ref [1]) for defining the BCA steels characteristics referred in W31.

In the event the hull girder strength criteria of the UR S11 (Rev.8) and/or UR S11A (New June 2015) are modified, the above conclusion should be reconsidered.

-----

## **Technical Background document for UR S33 (Rev.3 Feb 2020)**

(29 January 2021 separately approved by GPG (Ref: 21004\_IGb))

### **1 Scope and objectives**

The below background is made to provide clarifications on the application of the UR S33 requirements. Basic assumptions and the general safety concept of the requirement are explained.

### **2 Engineering background for technical basis and rationale**

#### **Rationale of UR S33 requirements:**

The purpose of UR S33 is to avoid a sudden brittle crack of the hull structure by providing measures to control crack propagation due to design or other measures.

#### **Assumption:**

Cracks will mainly be initiated in the vicinity of weld lines, especially from block-to-block butt weld joints on hatch side coaming or on upper deck. Brittle cracks may propagate along the weldline of the block joint or may deviate from the weld line. In addition, cracks may be initiated and may propagate from other welds such as fillet and attachment welds.

#### **Safety concept:**

In principle two options

1. Avoid of crack initiation
2. Ensure crack arrest, if crack is initiated

A combination of these two principles is applied in UR S33 in dependency of the material and thicknesses used in the design of the upper deck region. Avoidance of crack initiation is mainly addressed by NDT during construction and if found appropriate by the Classification Society, after delivery. Furthermore, the effects and impacts of the applied welding procedure are considered.

Ensuring crack arrest is addressed by application of crack arrest design measures. The main idea behind the crack arrest design measures is to limit the crack propagation to the plate stake where the crack initiation has taken place.

For both crack initiation avoidance as well as for arresting an initiated crack, dedicated toughness requirements for the weld and base material are applied in combination with the a.m. measures.

The application of required measures is controlled by the table in Annex 1 of UR S33 in dependency of the yield strength and the thickness of the hatch coaming top and side plate. If one of these plates exceeds the controlling parameters as given in columns 1 and 2 of the table, measures to be applied are indicated. Measures 1 and 2 refer to NDT requirements while measures 3, 4 and 5 refer to the crack arrest design measures to avoid crack propagation as required by the functional requirement given in UR S33 4.2.1.(b).

If the as built thickness of the hatch coaming top plating and side plating is less than 50 mm, counter measures against brittle cracking are not necessary regardless of the thickness and yield strength of the upper deck plating.

Measures given under UR S33 4.3.1 a) to e) are "concept examples". This means that also other solutions / new designs might be possible, providing that the functional requirements under 4.2.1 are fulfilled and that the measures are accepted by the Classification Society.

### **Requirements for Hatch Coaming Top Plate**

Crack arrest steel (BCA) is not required for hatch coaming top plate for the following reasons:

- Due to the stress gradient within the coaming it is unlikely that a crack will be arrested when it is initiated in coaming side plate and propagates into the coaming top plate.
- $K_{ca}$  values for applicable BCA steels were determined based on the geometry and stress levels of upper deck. Therefore, for hatch coaming top plate no reliable  $K_{ca}$  values are available.
- No evidence was found neither from practical experience nor from theoretical point of view justifying the need for crack arrest ability of the hatch coaming top plate.

### **Application of NDT**

Reference is made to Annex 1, where it is stated, that enhanced NDT other than TOFD (e.g. Phased Array UT) may be accepted. This comprises also combinations of NDT methodologies.

By excluding EGW as single pass high heat input welding procedure for brittle crack arrest design solutions (refer to the table in UR S33 Annex 1, where option B is only allowed for FCAW) high toughness values of the weld as well as limitation of the physically possible defect sizes can be ensured independent from any NDE and in addition to any NDE.

**3 Source/derivation of the proposed IACS Resolution**

None

**4 Summary of Changes intended for the revised Resolution:**

None

**5 Points of discussions or possible discussions**

The need for amendments of the TB to the existing UR S33 Rev.03 have been discussed in Hull Panel before submitting the text to the HP Members.

Application of BCA steels to the hatch coaming top plate  
Application of enhanced NDT (UR S33 4.3.1(e))

**6 Attachments if any**

None

# UR S34 “Functional Requirements of Load Cases for Strength Assessments of Container Ships by Finite Element Analysis”

## Part A. Revision History

Version no.	Approval date	Implementation date when applicable
New (May 2015)	26 May 2015	1 July 2016

### • New (May 2015)

#### .1 Origin for Change:

Suggestion by an IACS member (*Action initiated to address EG/Container Ships recommendations following the MOL Comfort incident*)

#### .2 Main Reason for Change:

None – new document.

#### .3 List of non-IACS Member classification societies contributing through the TC Forum and/or participating in IACS Working Group:

None

#### .4 History of Decisions Made:

See technical background.

#### .5 Other Resolutions Changes

UR S11A

#### .6 Dates:

Original Proposal: 30 March 2015 Made by: PT PH33/2014

Panel Approval: 16 April 2015 By Hull Panel

GPG Approval: 26 May 2015 (Ref: 14019\_IGg)

## **Part B. Technical Background**

List of Technical Background (TB) documents of UR S34:

Annex 1. **TB for New (May 2015)**

See separate TB document in Annex 1.





## **Technical Background document for UR S34 (New, May 2015)**

### **1. Scope and objectives**

Following recent structural failure incidents on large container ships, an Expert Group on container ship (EG/Container Ships) was established. EG/Container Ships reported recommended actions for enhancing the requirements of post-Panamax container ships to the IACS Council.

In response to the report, at 68th Council Meeting held in December 2013 the Council decided to expand the scope of its current URs for container ships, by introducing functional requirements on structural strength for new container ships. Specifically, the project team (PT) for Hull Panel Task No. 33 (PT PH33/2014, hereinafter referred to as "the PT") was tasked to develop a new UR that prescribes the following:

- Functional requirements on load cases
- Minimum set of loading conditions

The purpose of these new requirements is to attain an acceptable level of consistency among all Classification Societies by defining the unified load cases, which are to be used while performing strength assessment for container ships by Finite Element (FE) analysis. The intention is not to prescribe an overall FE analysis standard, but rather "functional requirements" to ensure that respective analysis is undertaken with suitable load cases considered.

### **2. Engineering background for technical basis and rationale**

This UR is aimed to prescribe functional requirements on FE loads which shall be considered when FE analyses are carried out in accordance with the rules by the Classification Society. By prescribing high-level "functional requirements" on FE loads, the bottom line of structural strength becomes unified at a certain level across all Classification Societies.

The other aim of this UR is to develop a minimum set of common loading conditions for Cargo Hold Analysis in midship region. By developing common loading conditions for Cargo Hold Analysis, the base line of structural strength at cargo hold in midship region are achieved among IACS member societies and therefore the flexibility of container cargo loading comes to the equal level.

### **3. Source/derivation of the proposed IACS Resolution**

- The information obtained through work performed by PT PH33/2014

- UR S11A Longitudinal Strength of Standard for Container Ships” prepared by PT56 in parallel with the development of this UR
- Additional input from the Hull Panel regarding the work performed by PT PH33/2014 and PT56

**4. Summary of Changes intended for the revised Resolution:**

Not applicable

**5. Points of discussions or possible discussions**

The UR was developed by the project team (PT) for Task No. 33. Discussions on the draft documents prepared by the PT were reviewed and discussed within the Hull Panel at Panel meetings and via email correspondence.

**6. Attachments if any**

Detailed technical background document is attached (Attachment 1).

# **Attachment 1**

## **Technical Background for UR S34**

**Functional Requirements of Load Cases for  
Strength Assessment of Container Ships by  
Finite Element Analysis**

# Technical Background for UR S34 “Functional Requirements of Load Cases for Strength Assessment of Container Ships by Finite Element Analysis

## **TB S34.1 Functional Requirements on FE Load**

This UR is aimed to prescribe functional requirements on FE loads which shall be considered when FE analyses are carried out in accordance with the rules by the Classification Society. By prescribing high-level “functional requirements” on FE loads, the bottom line of structural strength becomes unified at a certain level across all Classification Societies.

In order to develop functional requirements at a reasonable level, a set of questionnaires was distributed within IACS member societies to collect information on the existing analysis procedures for container ships.

Based on the collected information, the PT discussed the principles behind each society’s container ship rules, particularly focusing on the requirements that relate to FE load, and established functional requirements in this UR. The outline of this UR is as follows:

### UR S34.1 Application

The application of this UR is defined as container ships and ships dedicated primarily to carry their cargo in containers.

### UR S34.2 Principles

This section states that the loads in this UR are to be considered when performing structural strength assessments (yielding and buckling assessments) while the detailed procedure is to be in accordance with the Rules of the Classification Society. This section also describes that the aspects and principles not mentioned in this UR are to be in accordance with the Rules of the Classification Society.

### UR S34.3 Definition

Global Analysis and Cargo Hold Analysis and their target structural members are defined in this section.

### UR S34.4 Analysis

The application of Global Analysis and Cargo Hold Analysis as well as loads to be considered are defined in this section. The application for Global Analysis has been [settled to be in line with that for UR S11A.6.1, where functional requirements in UR S11A are prescribed]. On the other hand, the application for Cargo Hold Analysis has been settled with reference to CSR application. In addition, two methods are introduced regarding Global Analysis since there are various possible approaches for carrying out Global Analysis.

### UR S34.5 Load Principles

Wave environment and ship operating conditions are defined in this section. Yielding and buckling assessments are to consider waves that are expected for ships to encounter during their actual voyage in the North Atlantic environment. With regard to ship operating conditions, seagoing condition is required in this UR as a minimum requirement, since it is the most representative condition throughout a ship's life.

### UR S34.6 Load Components

Static and dynamic load components to be considered in each analysis are defined

in this section based on the load components considered in container ship rules currently adopted by Classification Societies.

**UR S34.7 Loading Conditions**

Loading conditions to be considered for each analysis are defined in this section. The table indicating the minimum set of loading conditions for Cargo Hold Analysis has been developed through the comparative study within the PT, which was conducted as explained in TB S34.2.

**UR S34.8 Wave Conditions**

Dynamic wave conditions for each analysis are defined in this section. The wave conditions are described as waves that are considered to be severe for each analysis respectively.

**TB S34.2 Minimum Set of Loading Conditions for Cargo Hold Analysis**

The other aim of this UR is to develop a minimum set of common loading conditions for Cargo Hold Analysis in midship region. By developing common loading conditions for Cargo Hold Analysis, the base line of structural strength at cargo hold in midship region are achieved among IACS member societies and therefore the flexibility of container cargo loading comes to the equal level.

For this purpose, a comparative study was conducted within the PT to investigate loading conditions that are significant to the scantling of primary supporting members in a cargo hold FE model. The following steps were taken in order to effectively screen the suitable loading conditions.

1. Collecting loading conditions in IACS member societies' container ship rules
2. Narrowing down the initial set of loading conditions for further investigation
3. Conducting a comparative study based on direct strength analysis
4. Determining a minimum set of loading conditions based on the analysis results

**TB S34.2.1 Collecting loading conditions in IACS member societies' container ship rules**

As the beginning step of determining a minimum set of loading conditions, the PT distributed a questionnaire among IACS member societies and collected a wide variety of loading conditions that are currently considered in their existing container ship rules.

**TB S34.2.2 Narrowing down the initial set of loading conditions for further investigation**

The loading conditions collected from the IACS member societies were investigated and categorized into 5 broad types of loading conditions: full load conditions, ballast conditions, flooded conditions, one bay empty conditions, and other loading conditions. Due to time constraints, PT members narrowed down the loading conditions to those which are most common among all societies and those which container ships could experience during ordinary seagoing conditions. Thus, full load conditions and one bay empty conditions were selected for further discussion. It is to be noted that other cases (such as ballast and flooded conditions) may still be taken into consideration by the Classification Society if considered necessary.

The PT selected 6 loading conditions to be further investigated, as shown in Figure 1.

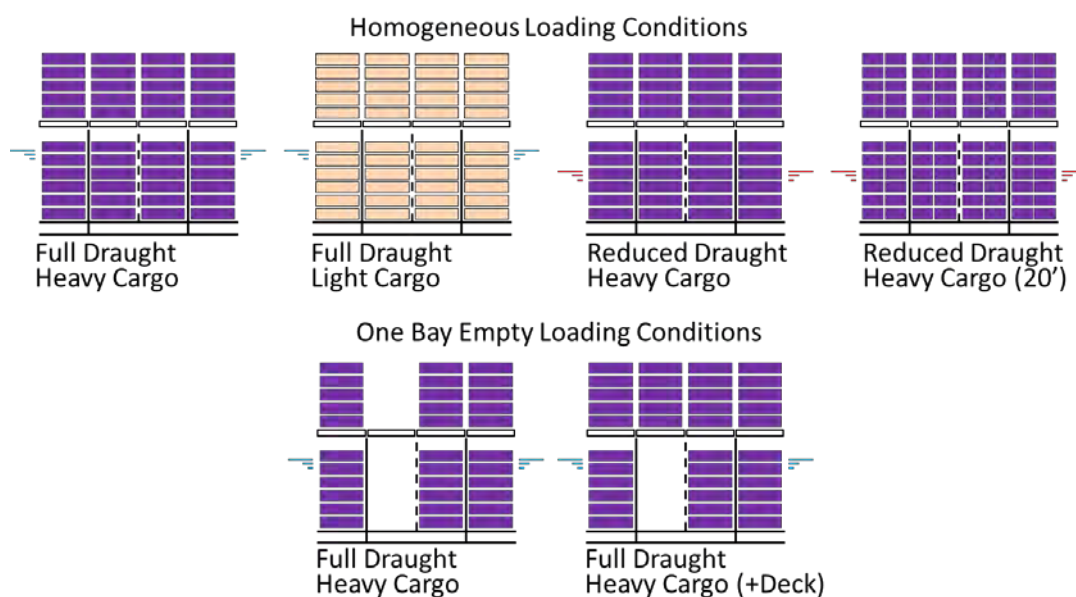


Figure 1: Set of Loading Conditions Selected for Comparative Study

Each loading condition in Figure 1 was selected for this study for the following reasons:

- Homogeneous (Full Draught, Heavy Cargo (40' containers), Hogging):  
This condition is generally considered to be the most common loading condition in practice, where both external load from sea pressure and internal load from container cargo are large.
- Homogeneous (Full Draught, Light Cargo (40' containers), Hogging):  
This condition is considered to be one of the severest conditions since light 40' containers would induce smaller internal load due to container cargo, which leads to larger external/internal pressure difference.
- Homogeneous (Reduced Draught, Heavy Cargo (40' containers), Sagging):  
This condition was selected for investigating the effect of sagging loading condition (minimum hogging loading condition), where external load due to sea pressure is smaller and internal load due to heavy cargo is larger.
- Homogeneous (Reduced Draught, Heavy Cargo (20' containers), Sagging):  
The condition similar to the above but with 20' containers was also selected for investigating the effect of loading heavy 20' containers instead of heavy 40' containers.
- One Bay Empty (Full Draught, Heavy Cargo (40' containers), Hogging):  
This condition is considered to be another one of the severest loading conditions, because the double bottom structure below the empty bay receives the largest external/internal pressure difference due to the absence of container cargo, whereas the adjacent bays receives large internal pressure.
- One Bay Empty (Full Draught, Heavy Cargo (40' containers) with Deck Fully Loaded, Hogging):  
This one bay empty condition was selected for investigating the effect of loading containers on top of the hatch cover above the empty bay.

### **TB S34.2.3 Conducting a comparative study based on direct strength analysis**

The comparative study was carried out within the PT in order to investigate which of the 6 loading conditions chosen in TB S34.2.2 would become relatively significant to scantling of each structural member in a container ship.

Upon conducting the comparative study, utilisation factors (ratio between reference stresses and allowable stresses) for yielding and buckling assessments in each structural member were compared among PT member societies, rather than comparing the actual stress values calculated from direct strength analysis. This is because every Classification Society differs in FE load application and strength evaluation methods, and the purpose of this study is to investigate the loading conditions in the order of their dominance while applying the rules adopted by individual Classification Societies.

Taking the above into account, each PT member society performed direct strength analysis in accordance with their rules while referring to the common study procedures. Direct strength analysis was carried out under the following conditions:

- One container ship FE model from each PT member societies' class-registered ships in the range basically from 8,000 to 10,000 TEU (or large container ship, if none available in the range, but preferably post Panamax) is selected individually as a subject ship for the comparative study.
- FE loads, boundary conditions, etc. for 6 loading conditions shown in Table 1 are configured in accordance with the Rules of the Classification Society.
- Utilisation factors, evaluated from yielding and buckling assessments in accordance with the Rules of the Classification Society for 6 loading conditions in Table 1, are collected from each PT member society. For this purpose, 68 representative evaluation points (see Table 2) in structural members of a container ship were selected, which are considered to be relatively severe among the structural members.

Table 1: Details of 6 Loading Conditions for the Comparative Study




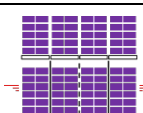


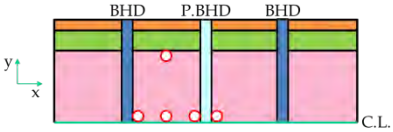
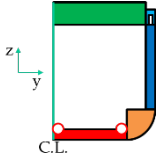
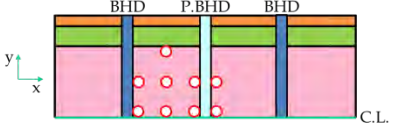
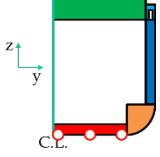
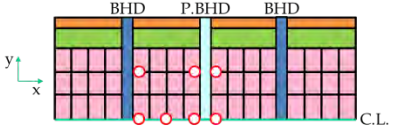
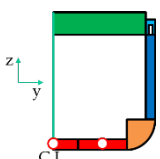
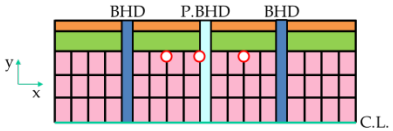
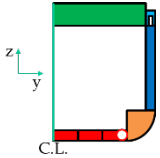

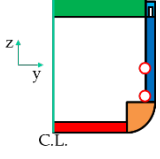

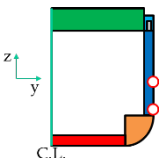

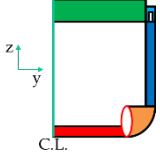
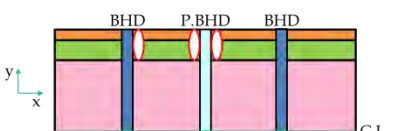
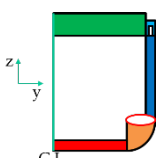

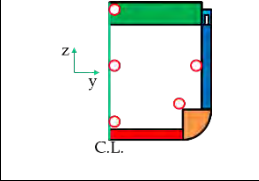
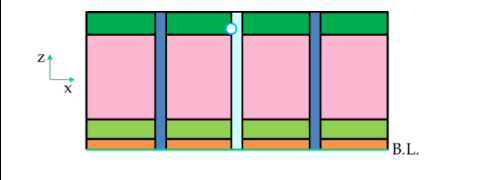
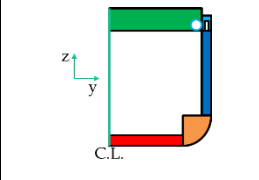

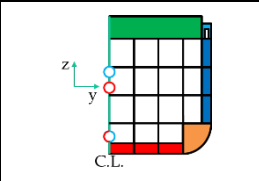
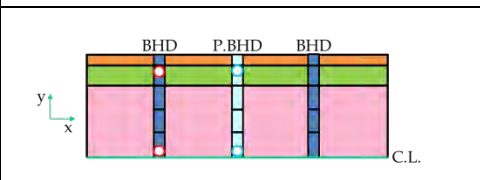
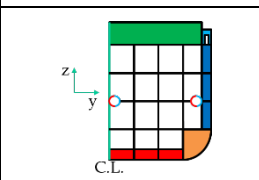
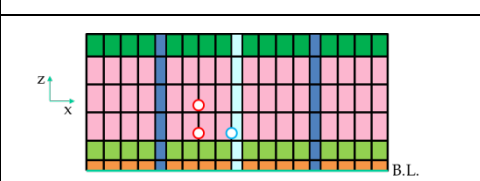
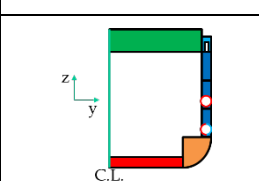
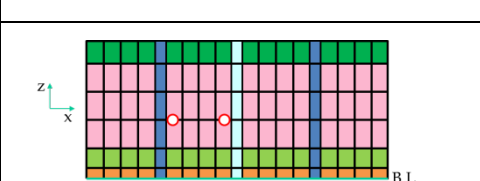
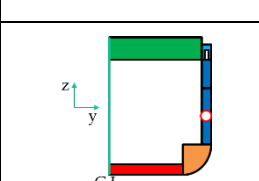
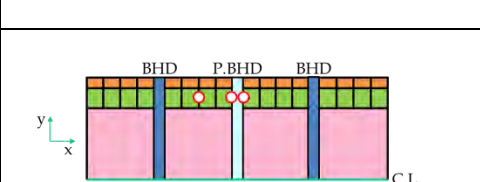
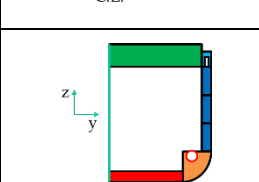
Condition name	Loading pattern	Draught	Types and weight of container	Ballast and FO	Still water hull girder moments
FH4		Scantling draught	Heavy cargo weight, 40' containers	Empty	Permissible hogging
FL4		Scantling draught	Light cargo weight, 40' containers	Empty	Permissible hogging
RH4		Reduced draught	Heavy cargo weight, 40' containers	Empty	Permissible sagging (minimum hogging)
RH2		Reduced draught	Heavy cargo weight, 20' containers	Empty	Permissible sagging (minimum hogging)
OH4E		Scantling draught	Heavy cargo weight, 40' containers (one bay empty)	Empty	Permissible hogging
OH4D		Scantling draught	Heavy cargo weight, 40' containers (one bay empty + loaded deck)	Empty	Permissible hogging



Table 2: Representative Evaluation Points

Structural member	# of points	Top/Side view	Front view
Inner bottom	5		
Bottom shell	9		
Bottom girders	7		
Bottom floors	3		
Inner hull	8		
Side shell	8		
Tiered stand (side)	3		
Tiered stand (top)	3		

Structural member	# of points	Top/Side view	Front view
Transverse bulkhead	5		
Partial bulkhead	1		
Vertical webs	4		
Horizontal girders	4		
Transverse webs	3		
Stringers	2		
Bilge webs	3		

**TB S34.2.4 Determining a minimum set of loading conditions based on the analysis results**

The results of calculated utilisation factors were collected from PT members and were compared for investigation. Figure 2 shows an example of results submitted by a PT member. In Figure 2, the solid line in the graph represents the envelope curve of the utilisation factor in respective evaluation point among 6 loading conditions for the Classification Society.

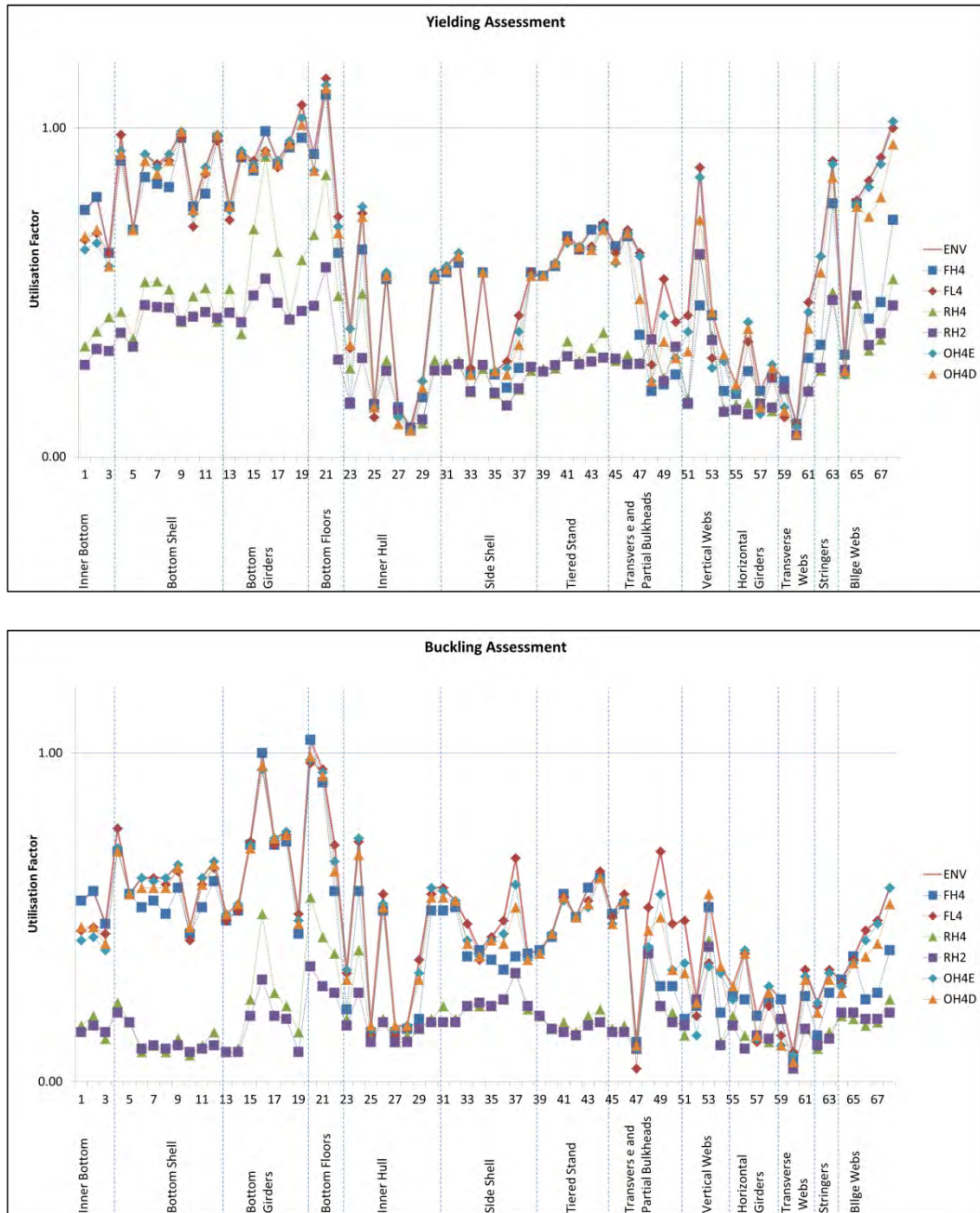


Figure 2: Example of Results Collected from PT Members

The results showed that the trend of utilisation factors to each structural member calculated for different loading conditions does not significantly differ among PT member societies. Furthermore, the PT proceeded with the investigation by comparing the loading conditions that showed similar results (RH4 and RH2, and OH4E and OH4D in particular) to further narrow down the number of loading conditions.

As a result of the study, the 4 loading conditions shown in Table 3 were chosen as a minimum set of loading conditions to be used only for evaluating the structural strength at midship region. For reference, Figure 3 indicates which loading conditions become relatively significant to each structural member. According to Figure 3, it can be confirmed that the

strength of all of the structural members can be evaluated using the 4 loading conditions determined through the PT’s study.

Table 3: Common Design Loading Conditions for Container Ships

Loading condition	Loading pattern	Draught	Container weight	Ballast and FO tanks	Still water hull girder moments
Full Load Condition (1) (FH4)		Scantling draught	Heavy cargo weight, 40' containers	Empty	Permissible hogging
Full Load Condition (2) (FL4)		Scantling draught	Light cargo weight, 40' containers	Empty	Permissible hogging
Full Load Condition (3) (RH2)		Reduced draught	Heavy cargo weight, 20' containers	Empty	Permissible sagging (minimum hogging)
One Bay Empty Condition (OH4E)		Scantling draught	Heavy cargo weight, 40' containers (one bay empty)	Empty	Permissible hogging

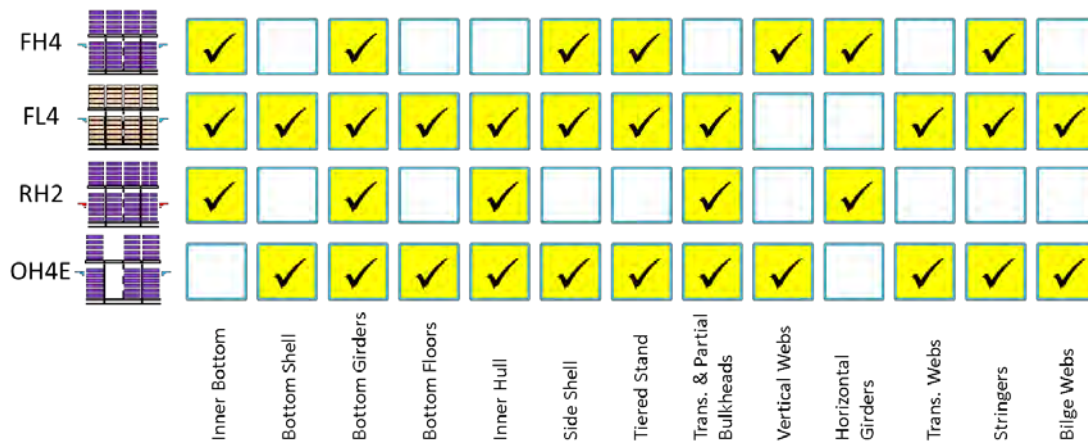


Figure 3: Structural Members where Each Loading Condition Becomes Significant

**TB S34.2.5 Maximum and Minimum Values for Cargo Weights**

The cargo weights corresponding to loading conditions in Table 3 are defined so that they depend on the ship’s design, because container ships generally differ in their design. The calculation conditions in the comparative study, which were to be in accordance with the Rules of the Classification Society, were referred to upon settling the descriptions of the cargo weights.

In particular, light cargo weight was defined on the basis of the maximum ratio of light cargo to heavy cargo weight among PT member societies. Table 4 shows the trend of light cargo and heavy cargo weights configured by the PT members in the comparative study. With this regard, the maximum weight of a container unit in hold is defined as 55% of heavy cargo weight in hold. On the other hand, containers on deck are usually planned to have less

permissible stack weight than those in hold. Thus, in order to prevent light cargo weight largely differing from the weights used in the comparative study, the maximum weight of a container unit on deck is defined as 90% of heavy cargo weight on deck while it is also not to be heavier than 17 ton per unit.

Table 4: Cargo Weight Configuration among PT Member Societies

PT Member		1	2	3	4	5	6
FH4	On Deck (ton)	30.00	30.00	21.80	32.00	150.00 per stack	30.00
	In Hold (ton)	30.00	30.48	30.50	32.00	30.00	30.00
FL4	On Deck (ton)	15.00	16.00	10.00	15.00	50.00 per stack	16.00
	In Hold (ton)	15.00	16.00	10.00	15.00	16.00	16.00
Cargo Weight Ratio (FL4/FH4)	On Deck (ton)	50%	53%	46%	47%	33%	53%
	In Hold (ton)	50%	52%	33%	47%	53%	53%

### **TB S34.3 Expected Impact to the Scantlings**

➤ Impact due to functional requirements on load cases

The minimum acceptable FE load requirements were developed as high-level functional requirements on the basis of FE load principles for existing container ship rules currently adopted by individual Classification Societies. For this reason, functional requirements on load cases in this UR have minimal effect to IACS Classification Societies.

➤ Impact due to minimum set of loading conditions

Although the degree of impact to individual Classification Societies due to this UR would depend on the difference between loading conditions adopted in each Classification Society's rules and this UR, the scantling impact would not become significantly large since the loading conditions investigated during the comparative study were selected primarily based on those already adopted by most Classification Societies. This has been confirmed by the results obtained in the comparative study, which is described in TB S34.2.

## UR S35 “Buckling Strength Assessment of Ship Structural Elements”

### Summary

UR S35 provides common buckling requirements, following the CSR buckling methodology, for all relevant IACS UR-S resolutions such as UR S21 (Rev.6, Jan 2023 Complete Revision).

### Part A. Revision History

Version no.	Approval date	Implementation date when applicable
New (Feb 2023)	09 February 2023	1 July 2024

- **New (Feb 2023)**

#### 1 Origin of Change:

- Suggestion by IACS Member

#### 2 Main Reason for Change:

Different buckling assessment methods have been included in the relevant UR-Ss, such as UR S11, S11A, S21 and S21A. With the development of the harmonized buckling method in the Common Structural Rules for Bulk Carriers and Oil Tankers(CSR), it's considered necessary to also harmonise the buckling methods among all the different UR-Ss based on the CSR buckling methodology.

For the introduction of the new buckling methodology, it's to be carried out as part of the comprehensive work package on the harmonisation of buckling requirements in different IACS Resolutions, with a newly proposed UR S35-Buckling as a common unified buckling toolbox and simultaneous amendments to the Relevant UR-S including UR S21 and S21A.

For this new UR S35-Buckling specifically, for consistency and easy maintenance of related IACS Resolutions, this harmonization brings about a necessity to provide a common set of buckling requirements following the CSR buckling methodology, which is applicable for all relevant UR-S resolutions, such as UR S21 and S21A.

#### 3 List of non-IACS Member classification societies contributing or participating in IACS Working Group:

None

#### **4 History of Decisions Made:**

The Hull Panel at the 23rd meeting (Sept 2015) considered for the first time the need for harmonising the different IACS Resolutions. A comment received from shipyards is that the IACS approaches regarding buckling requirements were different in the UR S11, S11A, S21, S21A and CSR.

The decision to propose this new UR S35-Buckling and to simultaneously revise UR S21, S21A and CSR is an outcome of the work of IACS GPG Meeting 83.

Therefore, a Project Team PT PH43 was ad hoc nominated by the Hull Panel and tasked for the harmonization of buckling requirements in the UR-Ss, as well as for making improvements in the formulation itself.

#### **5 Other Resolutions Changes:**

Revised UR S21 (merged with S21A) requiring changes in the buckling part and making reference to this UR S35-Buckling.

#### **6 Any hinderance to MASS, including any other new technologies:**

None

#### **7 Dates:**

Original Proposal	: 08 August 2022	(Made by PT PH43)
Panel Approval	: 02 December 2022	(Ref: PH17036aIHK)
GPG Approval	: 09 February 2023	(Ref: 18058_IGy)

\*\*\*\*\*

## **Part B. Technical Background**

List of Technical Background (TB) documents for UR S35:

Annex 1. **TB for New (Feb 2023)**

See separate TB document in Annex 1.



## **Technical Background (TB) document for UR S35 (New Feb 2023)**

### **1. Scope and objectives**

This UR S35-Buckling is newly proposed as a major part of the comprehensive work package on the harmonisation of buckling requirements in different IACS Resolutions, simultaneously with amendments to the Relevant UR-S including UR S21 and S21A.

Within this new framework of buckling rule requirements, UR S35-Buckling takes as a general purpose buckling toolbox, consisting of a full set of unified requirements for "Buckling Strength", which is made generally by adopting the most preferred buckling methodology in the latest Common Structural Rules for Double Hull Oil Tankers and Bulk Carriers (CSR).

In UR S35-Buckling, it consists of five sections and one appendix, giving Application and Definitions, Slenderness Requirements, Buckling Requirements for Hull Girder Prescriptive Analysis, Buckling Requirements for Direct Strength Analysis of Hatch Covers, Buckling Capacity, and the Stress-based Reference Stress calculation method, respectively.

For the application of UR S35-Buckling to specific ship types or structural members requesting buckling assessment, definition of loading conditions, standard corrosion deductions, hull girder stresses, stress combinations, safety factors should be given in the individual UR-Ss; based on these definitions as input parameters, wherever applicable it links to UR S35-Buckling for buckling assessment with respect to slenderness requirements, prescriptive buckling requirements and buckling requirements for direct strength analysis. With this framework of general rule organization and a standardized interface of reference to the same UR S35-Buckling for buckling assessment in all relevant UR-S (S21, S21A, etc.), the goal of Harmonisation of Buckling Requirements in IACS Resolutions is achieved.

### **2. Engineering background for technical basis and rationale**

#### **2.1 On the harmonisation of buckling requirements in IACS Resolutions**

The Hull Panel at the 23rd meeting (Sept 2015) considered for the first time the need for harmonising the different IACS Resolutions. As a main cause of initiation, for many years the shipyards had been complaining that the IACS approaches regarding buckling requirements are different in the UR S11, S11A, S21, S21A and CSR. Therefore, since then the Hull Panel reiterated the need to perform this task during each subsequent Hull Panel Meeting.

For this purpose, it was well recognized that CSR with a sound technical basis, obtained through technical co-operation within IACS harmonization groups and continuous improvements and maintenance based on various feedback from Industry, offer the chance to adopt one single methodology to the buckling verification of different structural types and different ship types.

Therefore, a newly proposed task titled Harmonisation of the IACS Resolutions is approved by Hull Panel and to be carried out by a designated PT PH43. It was

highlighted that IACS needs to address through the following work, according to the following programme developed by the PT, in particular a Work Package, as below:

**WP-A:**

The objective is to harmonize the buckling methodology in UR S21 and S21A, and the CSR buckling approach, with detailed Technical Background documents, is generally to be adopted for all relevant UR S.

Consequently, a new UR S specifically dedicated for buckling using the net thickness approach will be developed for detailing the buckling modes, capacity and checking criteria from CSR. With reference to this new UR S Buckling, amendments are to be proposed to UR S21 and S21A respectively. Specifically, the following two steps are to be performed:

**WP-A1:**

Review of the relevant documents (S21, S21A and CSR) with regard to the buckling modes and the corresponding capacities, applied stresses and checking criteria.

Based on CSR approach, make a proposal for a new UR S Buckling, introducing the relevant buckling modes and the corresponding capacities and checking criteria.

With the new UR S Buckling, propose amendments to UR S21 and S21A respectively. The corrosion margins and applied stresses, which depend on ship types, may need to be kept in each of the original UR S.

Consequently, with this rule change proposal, in each UR S (S21 and S21A) the buckling check will require the application of the common UR S Buckling for the appropriate mode(s) and criteria, while using the corrosion margins and applied stress already defined in each UR S.

It's also required to issue a Technical Background separately for each modified document to explain the reasons for rule changes and technical justification of the modifications.

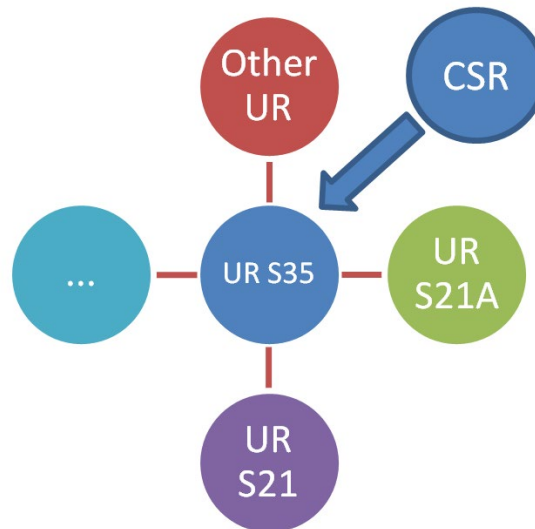
**WP-A2:**

Perform Consequence Assessment regarding the introduction of both the new UR S Buckling and amendments to relevant UR S, which may affect structural scantlings.

## **2.2 Framework and general rule organization for the harmonisation**

For the harmonization, while introducing the CSR buckling methodology into different IACS Resolutions, it's not to revise the buckling requirements in each Relevant UR-S independently. Generally, it's to adopt the buckling methodology of CSR, and the most updated buckling requirements are to be adapted and included in a separate UR S35-Buckling. Compared with CSR, the major difference is that UR S35-Buckling is organized as a buckling rule package relatively independent of ship types, well serving as a unified buckling toolbox for

the updates of UR S21 and S21A or future UR-Ss requesting buckling assessment wherever applicable, as shown in the figure below.



With this unified rule organisation, all relevant URs specific to some ship types or structural components can thereby be improved with respect to buckling in a more simplified manner. However, this also requires to carry out the extensive rule harmonisation task concerning several UR-Ss and CSR as a whole work package. Therefore, it needs to be implemented based on properly coordinated general guidelines on the organization of the harmonized buckling rule requirements. Generally, the principle is to eliminate repeated rule text in different UR-Ss as much as possible, and use same rule requirements for same type of structural members crossing different ship types. Surely, this not only makes the buckling check of different ship types easier for Industry by using a unified approach, but also brings about good maintenance of future buckling rule improvement for IACS.

Consequently, a maximum set of buckling requirements are identified and included in UR S35-Buckling, and only a minimum set of related requirements remains necessarily to be kept in each of the Relevant UR-S. As a major part of the latter set, the interface of each Relevant UR-S to UR S35-Buckling is also standardized as much as possible, which not only makes it easier for rule application by Industry but also more convenient for further harmonisation of some Relevant UR-Ss by IACS in the future, such as possibly combination of UR S11 and S11A or S21 and S21A.

Following the above principle and considerations, the following steps had been carried out.

- (1) To identify and classify all the buckling-related requirements in both CSR and Relevant UR-Ss. The identified items include different sets of slenderness requirements, DSA (direct strength analysis) or prescriptive type of buckling assessment, buckling capacity formulae based on different fundamental theories, both of global and local buckling modes to be considered, different definitions of net scantling or corrosion margins, applied stresses or stress combinations for buckling check, different stress calculation methods,

different buckling check criteria, etc., all of which need to be harmonised and included in either UR S35-Buckling or the Relevant UR-S.

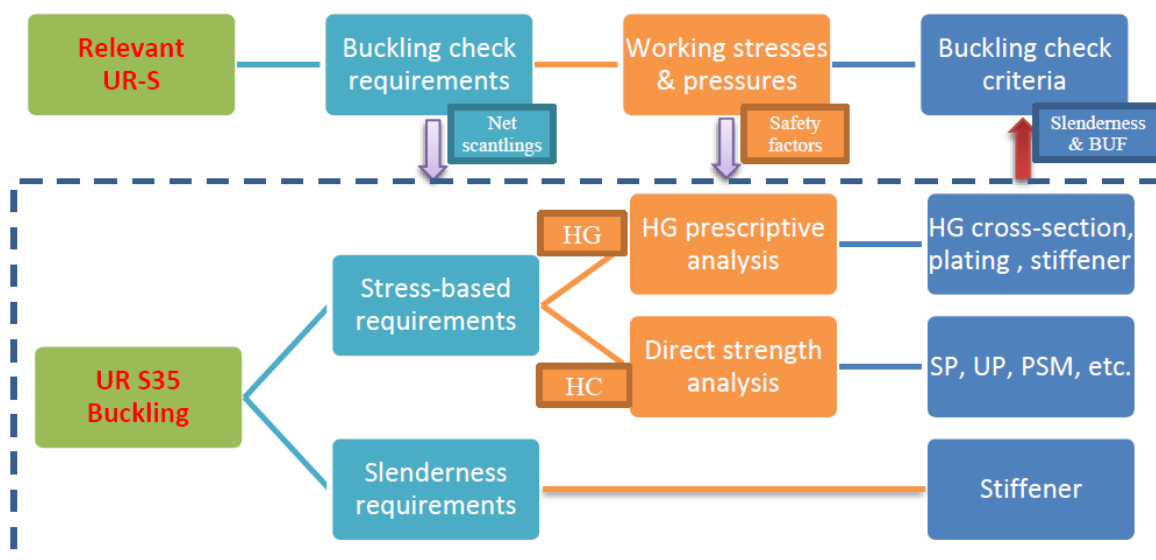
(2) On the general organization of the harmonized buckling rule requirements, regarding which part to be included in each rule text, as approved by Hull Panel on the HP-30 meeting, in UR S35-Buckling it should gather a maximum set of buckling requirements as following:

- General definitions and assumptions for buckling strength assessment
- Slenderness requirements
- Common requirements on hull girder prescriptive buckling assessment
- Common requirements on direct strength buckling assessment
- Buckling methodologies for the calculation of buckling capacity of plane panels, curved panels, corrugated panels, columns, etc.

On the other hand, in each of the Relevant UR-S it should contain the following remaining buckling-related requirements:

- Corrosion margin or net scantlings required for buckling check.
- Applied stressed or stress combinations for stress-based buckling assessment,
- Reference to specific sections of UR S35-Buckling for slenderness requirements, or stress-based buckling assessment requirements.
- Safety factors applicable for the ship types or structural members targeted in the Relevant UR-S.
- Buckling acceptance criteria

(3) Based on the general guideline and classification of all the buckling-related requirements, a framework as shown in the figure below is proposed to develop the new UR S35-Buckling and amendments to the Relevant UR-S.



(4) Based on the framework, for more specific organization of the buckling-related requirements in each rule text and different sections of the UR S35-Buckling, it is preferably to be taken as similar to that of CSR with reference to different sections of CSR Pt1, Ch 8-Buckling as shown in the table below.

Buckling-related requirements	CSR	UR S11 & S11A	UR S21 & S21A	UR S35-Buckling
General definition and assumptions on buckling assessment	Pt 1, Ch8, Sec1			Sec1
Corrosion addition for buckling assessment	Pt 1, Ch8, Sec1	√	√	
Safety factors	Pt 1, Ch8, Sec5	√	√	
Allowable buckling utilisation factors	Pt 1, Ch8, Sec1	√	√	
Buckling check criteria	Pt 1, Ch8, Sec1	√	√	
Slenderness requirements	Pt 1, Ch8, Sec2	Ref		Sec2
Prescriptive buckling requirements for Hull girder assessment	Pt 1, Ch8, Sec3	Ref		Sec3
DSA buckling requirements for hatch covers assessment	Pt 1, Ch8, Sec4 Pt 2, Ch1, Sec5	Ref		Sec4 Sec5
Buckling capacity formulas	Pt 1, Ch8, Sec5			Sec5

Note: a √ or Ref in the above table means the specific rule requirements of the first column or a reference to the requirements respectively are included in the corresponding Rule set listed in the first row. However, for CSR BC&OT and UR S35-Buckling, it also lists the specific section containing the corresponding rule requirements.

(5) As illustrated in the figure below, with a standardized interface in each of the proposed/revised Relevant UR-S, there is both a reference to UR S35-Buckling and also definitions of necessary parameters as input to UR S35-Buckling to perform detailed calculations and buckling check.

**S21**  
(cont)

**S21.3.6 Buckling strength**

**S21.3.6.1 General**

Buckling strength of all hatch cover structures is to be checked. Buckling assessments are to be performed in compliance with the requirements in UR S35 for the conditions specified in S21.3.6.2 and S21.3.6.3.

The net scantlings as defined in S21.1 are to be used for buckling check.

**S21.3.6.2 Slenderness requirements**

The slenderness requirements are to be in accordance with those specified in UR S35/Sec 2

**S21.3.6.3 Buckling requirements**

**S21.3.6.3.1 Application**

These requirements apply to the buckling assessment of hatch cover structures subjected to compressive and shear stresses and lateral pressures. The buckling assessment is to be performed for the following structural elements:

- Stiffened and unstiffened panels, including curved panels and panels stiffened with U-type stiffeners.
- Web panels of primary supporting members in way of openings.

The buckling strength assessment of coaming parts is to be done according to the individual Society's rules.

For rule application, the panel types and assessment methods, the applied stresses, safety factors and buckling check criteria are defined in S21.3.6.3.2, S21.3.6.3.3, S21.3.6.3.4 and S21.3.6.3.5, respectively. The procedure and detailed requirements for buckling assessment are given in UR S35/Sec4, including idealization of irregular plate panels, and additional definitions such as reference stresses and buckling criteria.

Unless otherwise specified, the symbols used in S21.3.6.3 are defined in UR S35.

**S21.3.6.3.2 Panel types and assessment methods**

.....

**S21.3.6.3.3 Applied stresses and pressure**

.....

**S21.3.6.3.4 Safety factors**

.....

**S21.3.6.3.5 Buckling acceptance criteria**

A structural member is considered to have an acceptable buckling strength if it satisfies the following criterion:

$$\eta_{act} \leq \eta_{lv}$$

UR S35-BUCKLING



## **2.3 Related technical background materials on buckling requirements**

As shown above, UR S35-Buckling is generally established by adopting the buckling methodology of CSR, with the most updated buckling requirements in CSR being adapted to form a common unified buckling toolbox. Therefore, all the latest version of technical background materials on the CSR buckling requirements are also equally applicable to this UR S35-Buckling.

Furthermore, this UR S35-Buckling is part of the comprehensive work package on the harmonisation of buckling requirements in different IACS Resolutions, simultaneously with amendments to the Relevant UR-S including UR S21 and S21A. Therefore, the TB for this harmonisation can be reasonably taken as a whole for the common part, and this part is better to be included in the TB of UR S35-Buckling. For simplicity and avoiding repetition, only the part specific to each Relevant UR-S will be included in the respective UR S while making a major reference to this document.

Generally, there are two categories of technical background (TB) materials for the newly proposed UR S35-Buckling and this revision of all Relevant UR-Ss as a whole.

### **(1) Category I: TBs corresponding to related CSR buckling requirements.**

Category I consists of the major part of the TB since the new UR S35-Buckling and this revision of all Relevant UR-Ss share the same methodology with CSR for buckling assessment. Such as in UR S21, it's to check the buckling strength of hatch covers based on direct strength analysis, it's identified that two parts of CSR requirements are mostly concerned, i.e. the buckling requirements for direct strength analysis in CSR Pt 1, Ch 8, Sec 4 and the requirements for hatch cover analysis in CSR Pt2, Ch1, Sec 5. Correspondingly, the CSR TBs on these requirements should equally apply to this revision of UR S21, including those in the TB Rule Reference document and more detailed collection of TB Reports. This is also the case for the revised UR S21A.

Note that during the process of carrying out this buckling rule harmonisation task, some common issues and key technical points were identified, for which it had been decided to be preferably investigated in the context of CSR, leading to several further improvements on some CSR buckling requirements. Therefore, the TB corresponding to all these RCNs (Rule Change Notices) should also be referred to and be included in this category I.

Also note that some mechanism might need to be established by IACS to ensure that future improvement of the CSR buckling requirements should also be continuously synchronized in UR S35-Buckling and all Relevant UR-S.

### **(2) Category II: TBs specific to this revision of each Relevant UR-S.**

Generally, TBs for some specific technical points related to a Relevant UR-S are to be provided for this category, together with consequence assessment if it's considered necessary. Such as for UR S21, additional TBs on the definition of allowable buckling utilizations are available in the TB for the proposed rev. 6 of

UR S21, together with some consequence assessment reports regarding several typical hatch covers.

### 3. Source/derivation of the proposed IACS Resolution

The framework and specific requirements of the newly proposed UR S35-Buckling are generally based on CSR Pt 1, Ch 8, Sec 5 and App 1. Background information to the general approach is therefore same as the corresponding parts in the technical background documentation of CSR, available via the IACS web-site.

### 4. Summary of Changes intended for the revised Resolution:

As a newly proposed UR S35-Buckling, this is the original version of this UR.

### 5. Points of discussions or possible discussions

This original version of UR S35-Buckling was made through discussions of the draft version provided by the project team within the Hull Panel, which mainly involved incorporating individual comments on specific technical points, updates based on corresponding CSR improvements and accepting the consolidated text.

Major points of discussions and conclusions during the development of this UR S35-Buckling have been the following:

No	Section	Points of discussion and conclusions																
1.	General organization	For the drafting of UR S35-Buckling, the same rule organizational structure as in CSR Pt1, Ch8 is generally to be followed, i.e. with 5 Sections and 1 Appendix.																
2.	Sec1/1.2.1	<p>Conceptually, hatch cover direct strength analysis in current Rules includes finite element method(FEM), grillage analysis and isolated beam analysis method as tabled below. However, investigation of some hatch cover makers and Societies indicates that only FEM is currently used, which is considered necessarily to be used especially for some specific structural members to get more accurate results. Finally, this corresponds to CSR 2022 which keeps only FEM for hatch cover analysis.</p> <table border="1"> <thead> <tr> <th>Methods</th> <th>CSR Pt2(2020)</th> <th>UR S21</th> <th>UR S21A</th> </tr> </thead> <tbody> <tr> <td><b>FEM</b></td> <td>√</td> <td>√</td> <td>√</td> </tr> <tr> <td><b>Grillage</b></td> <td>√</td> <td>√</td> <td>√</td> </tr> <tr> <td><b>Isolated beam</b></td> <td>√</td> <td></td> <td></td> </tr> </tbody> </table> <p>For additional information, Regarding the proposal of removing the isolated beam method and grillage method used for hatch cover analysis, it's based on a careful investigation and discussion both within a dedicated IACS work group and with Industry including several experts from hatch cover makers and shipyards. The main considerations are as below:</p>	Methods	CSR Pt2(2020)	UR S21	UR S21A	<b>FEM</b>	√	√	√	<b>Grillage</b>	√	√	√	<b>Isolated beam</b>	√		
Methods	CSR Pt2(2020)	UR S21	UR S21A															
<b>FEM</b>	√	√	√															
<b>Grillage</b>	√	√	√															
<b>Isolated beam</b>	√																	



		<p>(1) The finite element method generally provides higher level of accuracy and minimizes the numbers of approximations/assumptions. Compared with finite element method, the isolated beam method and grillage method are more simplified, which makes them more dependent on very critical assumptions regarding the idealization of some key parameters such as the effective width of attached plate, even with different definitions in various IACS Resolutions.</p> <p>(2) Limitations inherent in the grillage/isolated beam methods are deemed not acceptable for some very critical cases. For example, the shear stress in the hatch cover plate panels is not available or not very well considered in the grillage/isolated beam methods, but it has been found as an important issue leading to some serious structure collapses, especially at the hatch cover corners.</p> <p>(3) For drawing approval purpose, it's considered that FE software is nowadays available and usually applied by both Societies and Industry. Application of two different methods, equally acceptable by the Rule, might bring in undesirable discussions on the scantling check between related Parties.</p>								
3.	Sec1/3.2.2	<p>For the conceptual definition of buckling utilization factor, the original formulas of Applied equivalent stress and Equivalent buckling capacity in CSR2020 are numerically incorrect. Therefore, the formulas are revised. Finally, this corresponds to CSR 2022 which uses correct formulas and definitions.</p>								
4.	Sec1/3.3.1	<p>For Struts, pillars and cross ties, it's considered that no buckling requirements are included in original UR S11, S11A, S21, S21A, so the definition of Allowable buckling utilisation factor for these structural members are not included.</p>								
5.	Sec2	<p>Different slenderness requirements are included in UR S11, S11A, S21 and S21A as tabled below.</p> <table border="1"> <thead> <tr> <th>Rule</th> <th>Slenderness requirements</th> </tr> </thead> <tbody> <tr> <td><b>UR S11/S11.5.2</b></td> <td> <p>For flanges on angles and T-sections of longitudinals, buckling is taken care of by the following requirement:</p> <math display="block">\frac{b_f}{t_f} \leq 15</math> <p><math>b_f</math> = flange width, in mm, for angles, half the flange width for T-sections.  <math>t_f</math> = as built flange thickness.</p> </td> </tr> <tr> <td><b>UR S11A / S11A.4.2</b></td> <td> <p>For all structural elements, the slenderness requirements are to be in accordance with the Society requirements.  <i>No slenderness requirements except a formula as defined in the stiffener capacity formula of CSR, as below</i></p> <math display="block">I \geq \frac{st_p^3}{12 \cdot 10^4}</math> </td> </tr> <tr> <td><b>UR S21/</b></td> <td> <p>For flat bar secondary stiffeners and buckling stiffeners, the ratio <math>h/t_w</math> should satisfy the</p> </td> </tr> </tbody> </table>	Rule	Slenderness requirements	<b>UR S11/S11.5.2</b>	<p>For flanges on angles and T-sections of longitudinals, buckling is taken care of by the following requirement:</p> $\frac{b_f}{t_f} \leq 15$ <p><math>b_f</math> = flange width, in mm, for angles, half the flange width for T-sections.  <math>t_f</math> = as built flange thickness.</p>	<b>UR S11A / S11A.4.2</b>	<p>For all structural elements, the slenderness requirements are to be in accordance with the Society requirements.  <i>No slenderness requirements except a formula as defined in the stiffener capacity formula of CSR, as below</i></p> $I \geq \frac{st_p^3}{12 \cdot 10^4}$	<b>UR S21/</b>	<p>For flat bar secondary stiffeners and buckling stiffeners, the ratio <math>h/t_w</math> should satisfy the</p>
Rule	Slenderness requirements									
<b>UR S11/S11.5.2</b>	<p>For flanges on angles and T-sections of longitudinals, buckling is taken care of by the following requirement:</p> $\frac{b_f}{t_f} \leq 15$ <p><math>b_f</math> = flange width, in mm, for angles, half the flange width for T-sections.  <math>t_f</math> = as built flange thickness.</p>									
<b>UR S11A / S11A.4.2</b>	<p>For all structural elements, the slenderness requirements are to be in accordance with the Society requirements.  <i>No slenderness requirements except a formula as defined in the stiffener capacity formula of CSR, as below</i></p> $I \geq \frac{st_p^3}{12 \cdot 10^4}$									
<b>UR S21/</b>	<p>For flat bar secondary stiffeners and buckling stiffeners, the ratio <math>h/t_w</math> should satisfy the</p>									

		<p><b>S21.3</b> <b>.6.2</b></p> <p>following criteria:</p> $\frac{h_w}{t_w} \leq 15\sqrt{235/R_{eH}}$
		<p><b>UR</b> <b>S21A</b> <b>/</b> <b>3.6.2</b></p> <p>For lower plating of double skin hatch covers on which are intended to carry project cargos and PSM web, the net plate thickness should satisfy the following criteria:</p> $t_p \geq 6.5s/1000$ <p>For flat bar secondary stiffeners and buckling stiffeners, the ratio <math>h_w/t_w</math> should satisfy the following criteria:</p> $\frac{h_w}{t_w} \leq 15\sqrt{235/R_{eH}}$ <p>For edge girder (skirt plates), the net plate thickness should satisfy the following criteria:</p> $t_p \geq 8.5s/1000$
		<p>In CSR, however, there is an extensive set of slenderness requirements covering many kinds of structural members. Considering that slenderness requirements are usually dependent on ship types, while the current stress-based buckling check can cover almost all buckling modes, it's decided to include a minimum set of necessary CSR slenderness requirements into UR S35-Buckling. Finally, it's decided that only the slenderness requirements for stiffeners are to be included in UR S35-Buckling, because this is the only local buckling mode that is not covered by the buckling formulas which perform buckling check based on actually applied stresses.</p>
6.	Sec3/1.1.2	In the future, if necessary, the longitudinal extent of hull girder structures to be assessed for buckling strength is to be defined in the respective UR S11 and S11A.
7.	Sec3/1.1.3	Lateral pressure definition is necessary for stiffener buckling check. Since no explicit Design Load Sets are defined in UR S11 or S11A a general conceptually correct definition is included in UR S35-Buckling. Finally, following S11A practice and as approved by Hull Panel, lateral pressure is to be defined in both UR S11 and S11A as static design pressure.
8.	Sec4	Section 4 is tailored for hatch cover direct strength analysis since no DSA of other ship structures are required in related UR S11, 11A, 21 and 21A.
9.	Sec4/1.1.1	As indicated in Sec1/1.2.1, only FEM is to be used as the direct analysis method for hatch cover analysis.
10.	Sec4/2.1.1	Based on investigation of some hatch cover makers and Societies, the SP-A/SP-B/UP-A/UP-B models are used for the buckling assessment of hatch cover structures. Some typical pictures for illustration are prepared, just as the case for ship hull structural members in CSR. Finally, this corresponds to CSR 2022 which had been revised based on the corresponding rule change proposal.

11.	Sec5/ SYMBOLS	S: Partial safety factor for different structural members of different ship types, to be taken as the value defined in the respective URs, or optionally to be taken as 1.0.
12.	Sec5	The latest rule requirements in CSR2022 and RCP1 to CSR2022 are adapted in UR S35-Buckling, which includes the major CSR buckling rule improvements proposed while developing this UR S35-Buckling and making amendments to the Relevant UR-S including UR S21 and S21A, such as rule improvements on the global elastic buckling capacity, elastic torsional buckling capacity, stiffener buckling capacity, buckling capacity of panels with opening, buckling capacity of panels with U-type stiffeners, hatch cover buckling assessment, etc. Consequently, the final round of consequence assessments are carried out based on this updated set of buckling requirements.
13.	Sec5/2.2.7	For grillage beam analysis where the stresses in the attached plating are obtained based on beam theory, the Poisson Effect needs to be taken into account typically when a beam model producing stresses in x- and y-direction without the Poisson Effect, i.e. $\sigma_{xb}$ and $\sigma_{yb}$ . Normally a grillage beam analysis is used for local structures subjected to lateral loads only. In such a case the shear stresses in the attached plating may be neglected as assumed in the rule text, i.e. $\tau=0$ . In case the attached plating is subjected to overall shear and/or other membrane stress components in addition to stresses caused by the lateral load, such overall stress components are to be considered in addition to the stresses from lateral load for the buckling check.

## 6. Attachments if any

None

# IACS

INTERNATIONAL ASSOCIATION OF CLASSIFICATION SOCIETIES LTD.

PERMANENT SECRETARIAT: 4 Matthew Parker Street

Westminster, London SW1H 9NP, UNITED KINGDOM

TEL: +44(0)207 976 0660

INTERNET: [permsec@iacs.org.uk](mailto:permsec@iacs.org.uk) Web Site: [www.iacs.org.uk](http://www.iacs.org.uk)

March 2024

## History Files (HF) and Technical Background (TB) documents for URs concerning Materials and Welding (UR W)

Res. No.	Title	Current Rev.	HF/TB?
UR W1	Material and welding for ships carrying liquefied gases in bulk and ships using gases or other low-flashpoint fuels	Rev.4 Apr 2021	HF
UR W2	Test specimens and mechanical testing procedures for materials	Rev.3 Sep 2021	HF
UR W3		Deleted	No
UR W4		Deleted	No
UR W5		Deleted	No
UR W6		Deleted	No
UR W7	Hull and machinery steel forgings	Rev.4 Feb 2022	HF
UR W8	Hull and machinery steel castings	Rev.4 Mar 2024	HF
UR W9	Grey iron castings	Rev.2 May 2004	TB
UR W10	Spheroidal or nodular graphite iron castings	Rev.2 May 2004	TB
UR W11	Normal and higher strength hull structural steels	Rev.9 May 2017	HF
UR W12		Deleted	No
UR W13	Thickness tolerances of steel plates and wide flats	Rev.7 Sep 2021	HF
UR W14	Steel plates and wide flats with specified minimum through thickness properties ("Z" quality)	Rev.3 Sep 2021	HF

Res. No.	Title	Current Rev.	HF/TB?
UR W15		Deleted	No
UR W16	High strength steels for welded structures	Rev.3 Mar 2016	HF
UR W17	Approval of consumables for welding normal and higher strength hull structural steels	Rev.6 Sep 2021	HF
UR W18	Anchor Chain Cables and Accessories including chafing chain for emergency towing arrangement	Rev.6 Sep 2021	HF
UR W19		Deleted (1995) <i>superseded by UR W11</i>	No
UR W20		Deleted (1995) <i>superseded by UR W11</i>	No
UR W21		Deleted (1995) <i>superseded by UR W11</i>	No
UR W22	Offshore Mooring Chain	Rev.6 June 2016	HF
UR W23	Approval of Welding Consumables for High Strength Steels for Welded Structures	Corr.1 June 2019	HF
UR W24	Cast Copper Alloy Propellers	Rev.5 Sep 2023	HF
UR W25	Aluminium Alloys for Hull Construction and Marine Structure	Rev.6 Sep 2021	HF
UR W26	Requirements for Welding Consumables for Aluminium Alloys	Rev.2 Sep 2021	HF
UR W27	Cast Steel Propellers	Rev.3 Sep 2023	HF
UR W28	Welding procedure qualification tests of steels for hull construction and marine structures	Rev.2 Mar 2012	HF
UR W29	Requirements for manufacture of anchors	Jun 2005	TB
UR W30	Normal and higher strength corrosion resistant steels for cargo oil tanks	Deleted 1 July 2015	HF
UR W31	YP47 Steels and Brittle Crack Arrest Steels	Rev.3 Mar 2023	HF
UR W32	Qualification scheme for welders of hull structural steels	Rev.1 Sep 2020	HF
UR W33	Non-destructive testing of ship hull steel welds	Corr.1 Aug 2021	HF
UR W34	Advanced non-destructive testing of materials and welds	Dec 2019	HF
UR W35	Requirements for NDT Service Suppliers	Rev.1 Oct 2023	HF

# UR W1 “Material and welding for ships carrying liquefied gases in bulk and ships using gases or other low-flashpoint fuels”

## Summary

As per IACS Policy for the relationship between IACS Resolution and IMO instruments, IMO IGC Code requirements have been deleted in the new IACS UR W1 revision so to include amendment to tables 1, 2 and 3 only.

This revised UR W1 extends the material thickness range above 40mm to a maximum of 50mm, and the tables contained within this UR (corresponding to the applicable tables contained in IGC and IGF instruments) reflect this extended material thickness range.

## Part A. Revision History

Version no.	Approval date	Implementation date when applicable
Rev.4 (Apr 2021)	6 April 2021	1 July 2022
Rev.3 (Aug 2016)	18 August 2016	1 January 2017
Rev.2 (May 2004)	24 May 2004	-
Rev.1 (1984)	No record	-
New (1975)	No record	-

### • Rev.4 (Apr 2021)

#### 1 Origin of Change:

- Suggestion by IACS member

#### 2 Main Reason for Change:

Material manufacturers have contacted some IACS Members seeking approval of use of some material in the scope of IACS UR W1 up to 50 mm.

As per IACS Policy for the relationship between IACS Resolution and IMO instruments, IMO IGC Code requirements have been deleted in the new IACS UR W1 revision so to include amendment to tables 1, 2 and 3 only.

#### 3 List of non-IACS Member classification societies contributing or participating in IACS Working Group:

None

#### 4 History of Decisions Made:

In December 2018, the IACS EG/M&W agreed that UR W1 needed to be updated due to request from material manufacturers.

Form A – with the designated task Number EG/M&W 1809 was recorded by GPG in May 2019.

First draft was prepared in June 2019. Final draft was agreed by EG/M&W in October 2020.

#### 5 Other Resolutions Changes:

None

#### 6 Any hinderance to MASS, including any other new technologies:

None

#### 7 Dates:

Original Proposal: 26 April 2019 (Made by: EG/M&W)  
Panel Approval: 12 March 2021 (Ref: 19083\_EMWb)  
GPG Approval: 6 April 2021 (Ref: 19083\_IGc)

#### • Rev.3 (Aug 2016)

##### .1 Origin for Change:

Suggestion by IACS member

##### 2 Main Reason for Change:

IMO Resolution MSC.370(93) (revised IGC code) adopted in May 2014 comes into force for the ships whose keels are laid on after 1 July 2016. The relevant requirements of UR W1 are to be updated in line with the revised IGC Code.

##### 3 List of non-IACS Member Classification Societies contributing through the TC Forum and/or participating in IACS Working Group:

None

#### 4 History of Decisions Made:

In March 2015, the IACS EG/MW agreed that UR W1 needs to be updated in line with the revised IGC Code. Form A – with the task Number EMW 15-01 was approved by GPG in May 2015. First draft was prepared in July 2015. Final draft was agreed by EG/MW in June 2016.

#### 5 Other Resolutions Changes

None

**6 Dates:**

Original proposal: 16 April 2015 made by EG/M&W  
EG/MW Approval: 08 July 2016  
GPG Approval: 18 August 2016 (Ref: 15076\_IGd)

- **Rev.2 (May 2004)**

No records available

- **Rev.1 (1984)**

No records available

- **New (1975)**

No records available

\*\*\*\*\*



## Part B. Technical Background

List of Technical Background (TB) documents for UR W1:

Annex 1. **TB for Rev.2 (May 2004)**

See separate TB document in Annex 1.

Annex 2. **TB for Rev.3 (Aug 2016)**

See separate TB document in Annex 2.

Annex 3. **TB for Rev.4 (Apr 2021)**

See separate TB document in Annex 3.



**Note:** *There are no Technical Background (TB) documents available for the original resolution (1975) and Rev.1 (1984).*

**IACS Unified Requirement W1 (Rev.2)**  
**Technical Background**

**Material and welding for gas tankers**

**a) Objective/Scope**

The objective was to rationalize all UR Ws procedures on mechanical testing by reference to the new UR W2 (Rev.2, 2003).

**b) Source of Proposed Requirements**

The revised draft UR was developed referring to the existing requirements of the UR W1 “Material and welding for gas tankers” and the UR W2 “Test specimens and mechanical testing procedures for materials”.

**c) Points of Discussion**

Nil.

\* \* \* \* \*

## **Technical Background (TB) document for UR W1 (Rev.3 Aug 2016)**

### **1. Scope and objectives**

IMO Resolution MSC.370(93) (revised IGC code) adopted in May 2014 comes into force for the ships whose keels are laid on or after 1 July 2016. UR W1 is to be revised in line with the revised IGC code in order to update the relevant requirements on materials and welding specified in UR W1.

### **2. Engineering background for technical basis and rationale**

UR W1 has been revised in line with the revised IGC Code which is a modern and fit-for-purpose version of the Code taking into account the latest technologies.

### **3. Source/derivation of the proposed IACS Resolution**

IMO Resolution MSC.370(93) (revised IGC code)

### **4. Summary of Changes intended for the revised Resolution:**

The changes made to UR W1 are summarized as follows:

- Requirements of chemical composition
- Restriction of maximum of minimum yield stress (410N/mm<sup>2</sup> or below)
- Addition of FH grade for hull structural steels
- Addition of condition of supply for the relevant materials
- Deletion of drop weight test as alternative test for Charpy V-notch impact test of production test
- Requirements for welding procedure tests for secondary barriers
- Requirements for castings and forgings intended for cargo and process piping for design temperature above 0 degree C
- Ultrasonic testing in lieu of radiographic testing.

### **5. Points of discussions or possible discussions**

Due to this revision incorporating the requirements of the revised IGC Code, there are no relevant points for discussion associated with this revision.

### **6. Attachments if any**

N/A.

## Technical Background (TB) document for UR W1 (Rev.4 Apr 2021)

### 1. Scope and objectives

Due to the general market trend for increased sizes of independent type C gas tanks, the actual specification for low temperature steels with a maximum plate thickness of 40 mm does not suffice the design demands of current projects. For example, in the area of the fixed saddle / longitudinal key a plate thickness above 40 mm has become a common design. Thus, impact requirements for materials with thickness up to 50 mm are specified in tables 1, 2a, 2b, 3.

As per IACS Policy for the relationship between IACS Resolution and IMO instruments, IMO IGC Code requirements have been deleted in the new IACS UR W1 revision so to include amendment to tables 1, 2 and 3 only.

### 2. Engineering background for technical basis and rationale

Technical background of some Classification Societies and most commonly used international standards for design and manufacturing of pressure vessels have been analysed in order to amend the new requirements for impact tests for materials with thickness up to 50 mm specified in tables 1, 2a, 2b, 3.

### 3. Source/derivation of the proposed IACS Resolution

EN 13445-2:2018 - Unfired pressure vessels - Part 2: Materials  
ASME BPVC Section VIII:2019 - Rules for Construction of Pressure - div. 1  
CODAP:2015 - Code for construction of unfired Pressure Vessels

### 4. Summary of Changes intended for the revised Resolution:

Charpy V notch impact requirements tests in the thickness range  $40 < t \leq 50$  in the following tables:

- Table 1 Plates, pipes (seamless and welded), sections and forgings for cargo tanks and process pressure vessels for design temperatures not lower than 0°C.
- Table 2a Plates, sections and forgings for cargo tanks, secondary barriers and process pressure vessels for design temperatures below 0°C and strictly down to -10°C
- Table 2b Plates, sections and forgings for cargo tanks, secondary barriers and process pressure vessels for design temperatures below -10°C and down to -55°C
- Table 3 Plates, sections and forgings for cargo tanks, secondary barriers and process pressure vessels for design temperatures below -55°C and down to -165°C.

Deletion of IMO IGC Code requirements so to include amendment to tables 1, 2 and 3 only.

#### **5. Points of discussions or possible discussions**

Criteria for the definition of notch impact requirements tests in the thickness range  $40 < t \leq 50$  are based on the technical background of some Classification Societies and on the approach of some international standards.

Additional requirement of a further set of impact test at mid thickness for products with  $t > 40\text{mm}$  have been agreed.

Criteria for exemption to post-weld stress relief heat treatment based on alternative approach (e.g. Engineering Critical Assessment) to be approved by the Classification Society or to be in compliance with recognized standards have been considered.

#### **6. Attachments if any**

None

## UR W2 “Test specimens and mechanical testing procedures for materials”

### Summary

Review and update industry standards format according to GPG instructions

### Part A. Revision History

Version no.	Approval date	Implementation date when applicable
Rev.3 (Sep 2021)	21 September 2021	1 January 2023
Rev.2 (July 2003)	July 2003	-
Rev.1 1995	1995	-
New 1975	1975	-

#### • Rev. 3 (Sep 2021)

##### 1 Origin of Change:

- Suggestion by IACS member

##### 2 Main Reason for Change:

To update industry standards format according to GPG instructions given in GPG Vice-chair message 19000\_IRC.

##### 3 List of non-IACS Member classification societies contributing through the TC Forum and/or participating in IACS Working Group:

None.

##### 4 History of Decisions Made:

Original proposal was made according to GPG Vice-chair message 19000\_IRC. Proposal to revise the IACS URs and RECs only to refer to a dated version of the industry standard as per GPG instructions was made at IACS EG/MW meeting in September 2019. Three drafts have been discussed by the group.

##### 5 Other Resolutions Changes:

None.

##### 6 Any hinderance to MASS, including any other new technologies:

None.

## **7 Dates:**

Original Proposal : April 2019 Made by: GPG  
EG M&W Approval : July 2021  
GPG Approval : 21 September 2021 (Ref: 19000\_IGq)

- **Rev. 2 (July 2003)**

No records available.

- **Rev.1 (1995)**

No records available.

- **New 1975**

No records available.

\*\*\*\*\*

## **Part B. Technical Background**

List of Technical Background (TB) documents for UR W2:

Annex 1. **TB for Rev.2 (July 2003)**

See separate TB document in Annex 1.

Annex 2. **TB for Rev.3 (Sep 2021)**

See separate TB document in Annex 2.

**Note:** *There are no Technical Background (TB) documents available for the New (1975) and Rev.1 (1995)*



IACS Unified Requirement W2 (Rev.2)

**Test specimens and mechanical testing procedures for materials**

**Technical Backgrounds:**

**a) Objective/Scope**

The objective were as follows:

1. To amend the existing UR W2 in accordance with the UR W14 (Rev.1).
2. To update the existing UR W2 to bring in line with today's National and International Standards.
3. To rationalize all relevant sections of other UR Ws that detail general testing requirements into one document.

**b) Source of Proposed Requirements**

This revised draft UR was developed referring to the existing requirements of the UR W2 "Test specimens and mechanical testing procedures for materials".

**c) Points of Discussion**

The discussion on the following technical points had been made and achieved full agreement of the members:

Testing machines;

Tension/compression and impact testing machines are to be calibrated in accordance with ISO or other recognized standard.

Tensile test specimens;

Dimensions of tensile test specimens for various kinds of products are to be specified in accordance with ISO standard. For through thickness tensile test specimens, round test specimens including built-up type by welding are to be specified in accordance with the UR W14 (Rev.1).

Tensile properties at ambient temperature;

Testing procedures to determine yield stress, tensile strength and fracture elongation are to be specified in accordance with ISO standard.

Sub size Charpy requirements;

Dimensions of sub size Charpy V-notch specimens and the acceptance criteria are to be specified for each size of specimen.

Retest procedure

Retest procedures for tensile and Charpy V-notch impact tests are to be specified accordingly.

Ductility tests for pipes and tubes;

Requirements for the several kinds of ductility tests are to be specified in accordance with ISO standard.

Other UR Ws;

Other UR Ws are to be amended by reference to this revised UR W2 in the 2003 meeting.

\* \* \* \* \*

**Technical Background (TB) document for UR W2 Rev.3 (Sep 2021)**

**1. Scope and objectives**

Review and update industry standards format according to GPG instructions.

**2. Engineering background for technical basis and rationale**

N.A.

**3. Source/derivation of the proposed IACS Resolution**

ASTM E208:2019  
ISO 148-2:2016  
ISO 2566-1:1984  
ISO 2566-2:1984  
ISO 6892-1:2019  
ISO 6892-2:2018  
ISO 7500-1:2018  
ISO 8492:2013  
ISO 8493:1998  
ISO 8494:2013  
ISO 8495:2013  
ISO 8496:2013

**4. Summary of Changes intended for the revised Resolution:**

Industry standards format has been updated according to GPG instructions.

**5. Points of discussions or possible discussions**

None.

**6. Attachments if any**

None.

## UR W7 “Hull and machinery steel forgings”

### Summary

The current of UR W7 has been fully reworked and revised with following changes:

- Updated standards reference (external and IACS) to current version
- Changing the position of test specimens by its thickness
- Clarifying the requirements regarding the position of test specimens for hollow ring forgings
- Updated on the requirements and acceptance criteria for mechanical properties
- Updated to stipulation regarding the inspection regime.

### Part A. Revision History

Version no.	Approval date	Implementation date when applicable
Rev.4 (Jan 2022)	14 February 2022	01 July 2023
Rev.3 (May 2004)	May 2004	-
Rev.2 (July 2002)	July 2002	-
Rev.1 (1980)	1980	-
New (1978)	1978	-

#### • Rev.4 (Jan 2022)

##### 1 Origin of Change:

- Suggestion by an IACS member

##### 2 Main Reason for Change:

- 1) Review UR W7 to assess the following and recommend necessary changes:
  - a. Its relevance to current industry standards
  - b. Its relevance to other current IACS publications, since 2004 (and past versions)
- 2) In the case of hollow ring forgings, EG M&W shared the opinion that there are different interpretations of the distance to the heat treated surfaces. In connection with this matter, EG M&W received a request to review the requirements of position of test specimens from a ring forging manufacturer.

##### 3 List of non-IACS Member classification societies contributing through the TC Forum and/or participating in IACS Working Group:

None

##### 4 History of Decisions Made:

- Proposal to revise IACS UR W7 was confirmed by EG/MW Chairman on 16 April 2019. This was an action that derived from GPG, to revise EG/MW related UR's and Rec's, originally developed under a separate task.

- Task was assigned on 29 May 2019.
- Form A was submitted by task lead in October 2019.
- 7th drafts have been discussed by the group.
- Discussion and agreement took place regarding the position of test specimens by its thickness.
- Discussion and agreement took place regarding the requirements and acceptance criteria for mechanical properties - specially, Charpy V-notch impact test.
- Discussion and agreement took place regarding the inspection regime reflecting the update on IACS Rec. 68 and UR W34.
- Final draft (draft 7th) advised by EG/MW Chairman that this should be the final draft.

### **5 Other Resolutions Changes**

None.

### **6 Any hinderance to MASS, including any other new technologies:**

None.

### **7 Dates:**

Original Proposal	: 13 April 2019	(Made by: GPG)
EG M&W Approval	: 17 January 2022	(Ref: 1907_EMWzb)
GPG Approval	: 14 February 2022	(Ref: 19254_IGb)

- **Rev.3 (May 2004)**

Refer to TB in Part B Annex 2

- **Rev.2 (July 2002)**

No records available

- **Rev.1 (1980)**

Refer to TB in Part B Annex 1

- **New (1978)**

No records available

## **Part B. Technical Background**

List of Technical Background (TB) documents:

Annex 1. **TB for Rev.1 (1980)**

See separate TB document in Annex 1.

Annex 2. **TB for Rev.3 (May 2004)**

See separate TB document in Annex 2.

Annex 3. **TB for Rev.4 (Feb 2022)**

See separate TB document in Annex 3.

**Note:** *There are no Technical Background (TB) documents available for the New (1978) and Rev.2 (July 2002).*

## **Technical Background (TB) document for UR W7 (Rev.1 1980)**

### **1. Objective/Scope**

The objectives was to revise the existing UR W7 from the viewpoint of the consistency between the requirements and current techniques.

### **2. Source of Proposed Requirements**

This revised draft UR was developed referring to the existing requirements of UR W7 "Hull and machinery steel forgings".

### **3. Points of Discussion**

The discussion on the following technical points had been made and achieved full agreement of the members:

#### Chemical composition;

Chemical composition is to be specified for each steel type of hull and machinery steel forgings respectively. As details of chemical composition for alloy steel forgings for hull are not specified, the manufactures are to submit the specification for approval.

#### Direction of test specimen;

Two sampling direction of test specimen are to be defined, i.e. parallel (longitudinal test) or tangential (tangential test) to the principle axial direction of each product.

#### Mechanical properties;

Mechanical properties are to be specified for each steel type of hull and machinery steel forgings respectively. However, mechanical properties for C, C-Mn steel forging for hull are to be the same with those for machinery from design and metallurgical aspect. Charpy V- notch impact test is to be required only for propeller shaft intended for ships with ice class notation except the lowest one in UR W27.

#### Inspection;

Regarding requirements on non-destructive tests, IACS Recommendation No.68 which was adopted in 2000 is to be used as a sample of an acceptable standard.

#### Rectification;

Repair welding of forgings, such as crankshaft forgings may be permitted subject to prior approval of the Society.

## **Technical Background (TB) document for UR W7 (Rev.3 May 2004)**

### **1. Objective/Scope**

The objective was to rationalize all UR Ws procedures on mechanical testing by reference to the new UR W2 (Rev.2, 2003).

### **2. Source of Proposed Requirements**

The revised draft UR was developed referring to the existing requirements of the UR W7 "Hull and machinery steel forgings" and the UR W2 "Test specimens and mechanical testing procedures for materials".

### **3. Points of Discussion**

None

## **Technical Background (TB) document for UR W7 (Rev.4 Feb 2022)**

### **1. Scope and objectives**

In UR W7, the requirements of steel forgings intended for hull and machinery applications have been specified, e.g. chemical composition limits, position of test specimens, mechanical properties.

The objectives of this revision were to perform a general review to assess the following aspects and recommended any necessary changes:

- Its relevance to current industry standards, including the specified data/version of that standard
- Its relevance to other current IACS publications, since 2004 (and past versions)
- The requirements of position of test specimens for hollow ring forgings
- Edit, review, update where necessary, by preparing a new (revised) draft
- Review the current acceptance criteria, and revise if considered necessary

### **2. Engineering background for technical basis and rationale**

The latest UR W7 (Rev.3) was published in 2004, with no further revisions until this revision task was implemented. IACS GPG and EG/MW agreed that a review was required to assess the technical relevance compared with industry standards and IACS Resolutions.

The following technical points were considered in the presentation of this revision:

- A comprehensive literature review was carried out to attempt to align (and reference, if appropriate) any relevant external standards, e.g. mechanical properties, delivery conditions
- For materials exposed to seawater temperature with relevant Ice Class notations, the latest Trafi Regulations (2017) were reviewed as a valuable reference document
- The review also consisted of considerations and references to other IACS documents (e.g. UR W28, UR W32, UR W34, Rec. 68)
- The positions of test specimens were discussed and decided based on review of any relevant external standards and feedback from industry.

### **3. Source/derivation of the proposed IACS Resolution**

Existing Classification Societies Rules as well as the international standards have been considered:

- The origin why 27 J (L) was set as requirement for CMn steel grades for hull forgings cannot be retrieved since this criterion was stipulated for many years ago.
- It is assumed that the value was copied from the requirements for rolled normal strength steel grades A to E as per UR W11.



- Trafi Regulations (2017) provided a valuable reference for CVN test temperature and required values, for applicable materials with relevant Ice Class notations.

#### **4. Summary of Changes intended for the revised Resolution:**

The content of UR W7 has been fully reworked and revised with major changes summarized hereafter:

- Update language and terminology (where applicable) to reflect general industry nomenclature, and alignment with other revised IACS documents
- Update or introduce new standards references (external and IACS) to current version, and to reflect new or revised UR's published since Rev.3
- Deletions/additions, and general formatting for clarity
- Delivery conditions for alloy steels were added to align any relevant external standards
- The positions of test specimens were determined considering feedback from industry and any relevant external standards, e.g. slewing rings
- The requirements of Charpy V-notch impact test were stipulated to check the effectiveness of heat treatment to products
- The above requirements were determined based on existing Classification Societies
- Update or introduce the inspection scheme regarding NDT to current version considering revised IACS Rec. 68 and UR W34
- Updated exclusions to weld repair rectification on forgings subjected to torsional fatigue (e.g. propeller shaft forgings – in addition to the existing exclusion of weld repair to crankshaft forgings).

#### **5. Points of discussions or possible discussions**

- Fully annealed as delivery conditions for alloy steels were not added due to the possibility of insufficient strength
- The requirements of Charpy V-notch impact test were stipulated based on existing Classification Societies, not alignment with any relevant external standards
- The positions of test specimens and requirements of criterion for products may be changed depending on design and application with agreement by each Classification Society

#### **6. Attachments if any**

None

## UR W8 “Hull and machinery steel castings”

### Summary

The current of UR W8 has been revised with following changes:

- New requirements and clarifications regarding test block dimensions

### Part A. Revision History

Version no.	Approval date	Implementation date when applicable
Rev.4 (Mar 2024)	15 Mar 2024	1 January 2025
Rev.3 (Mar 2022)	31 Mar 2022	1 July 2023
Rev.2 (May 2004)	May 2004	-
Rev.1 (July 2002)	July 2002	-
NEW (1978)	1978	-

#### • Rev.4 (Mar 2024)

##### 1 Origin of Change:

- Suggestion by IACS member
- Industry feedback

##### 2 Main Reason for Change:

Due to industry feedback regarding the size and location of the test block arrangements in Rev.3, IACS concluded that there was an urgent need to issue a new revision of UR W8 (Rev. 4) to specifically address the UR W8 requirements for test block size in Clause 6.3, by taking into account industry feedback.

The specific feedback from industry regarding UR W8 Rev.3 test block size is that the test block size (and subsequent weight) required by Clause 6.3 in UR W8 Rev 3 is considered too demanding and, in some cases, impractical for manufacturers to produce.

For quality purposes, it was argued that smaller coupon sizes can adequately represent the casting in the case of most shipboard and machinery castings.

As a whole, industry had opined that the current Clause 6.3 for test blocks is not a practical way forward. The urgent nature of the required revision to modify Clause 6.3 has arisen as shipyards and Class Societies have already invoked UR W8 Rev. 3 to fulfil the IACS implementation cycle and implementation date of 1 July 2023.

### **3 List of non-IACS Member classification societies contributing through the TC Forum and/or participating in IACS Working Group:**

None

### **4 History of Decisions Made:**

- Original proposal to revise IACS UR W8 was agreed in October 2023 after correspondence following the IACS EG/M&W meeting in September 2023.
- IACS members sought direct industry feedback.
- IACS EG/M&W proceeded to modify the UR W8(rev.4) to account for the test block size.
- A new clause was inserted to recognise there may be a need for an alternative test block size (alternative to the new revised standard size), where specific mechanical properties need to be achieved. This may be determined by a variety of means, as per the Rev.4 requirements.
- Seven drafts have been discussed by the group.

### **5 Other Resolutions Changes:**

None

### **6 Any hinderance to MASS, including any other new technologies:**

None.

### **7 Dates:**

Original Proposal	: 02 September 2023	Made by: EG/M&W Member
Panel Approval	: 22 February 2024	Ref: 2335_EMWza
GPG Approval	: 15 March 2024	Ref: 23152bIGg

### **• Rev.3 (Mar 2022)**

#### **1 Origin of Change:**

- Suggestion by IACS EG/M&W Member

#### **2 Main Reason for Change:**

IACS UR W8 specifies the requirements for steel castings intended for hull and machinery applications such as stern frames, rudder frames, crankshafts, turbine casings, etc. The last revision was carried out in 2004.

Sampling practice (dimensions) and testing scope (no impact tests required) appear to be not in line with industry practice.

Further, larger scope of cast steel grades in industry has to be evaluated.

**3 List of non-IACS Member classification societies contributing through the TC Forum and/or participating in IACS Working Group:**

None

**4 History of Decisions Made:**

Original proposal to revise IACS UR W8 was agreed in January 2019 after correspondence following the IACS EG/MW meeting in September 2018. Seven drafts have been discussed by the group. Discussions took place during the reviews for the items as stated in TB paragraphs 4 and 5.

**5 Other Resolutions Changes:**

None

**6 Any hinderance to MASS, including any other new technologies:**

None.

**7 Dates:**

Original Proposal	: 28 September 2018	(Made by: EG M&W member)
EG/M&W Approval	: 13 January 2022	(Ref: 1807_EMWzh)
GPG Approval	: 31 March 2022	(Ref: 19136_IGd)

**• Rev.2 (May 2004)**

Refer to TB file in Part B Annex 2

**• Rev.1 (July 2002)**

Refer to TB file in Part B Annex 1

**• New (1978)**

No records are available

\*\*\*\*\*

## **Part B. Technical Background**

List of Technical Background (TB) documents for UR W8:

Annex 1. **TB for Rev.1 (July 2002)**

See separate TB document in Annex 1.

Annex 2. **TB for Rev.2 (May 2004)**

See separate TB document in Annex 2.

Annex 3. **TB for Rev.3 (Mar 2022)**

See separate TB document in Annex 3.

Annex 4. **TB for Rev.4 (Mar 2024)**

See separate TB document in Annex 4.

**Note:** *There is no Technical Background (TB) document available for the New (1978).*

## **Technical Background (TB) document for UR W8 (Rev.1 July 2002)**

### **a) Objective/Scope**

The objectives was to revise the existing UR W8 from the viewpoint of the consistency between the requirements and current techniques.

### **b) Source of Proposed Requirements**

This revised draft UR was developed referring to the existing requirements of UR W8 "Hull and machinery steel castings"

### **c) Points of Discussion**

The discussion on the following technical points had been made and achieved full agreement of the members:

**Chemical composition:** Chemical composition is to be specified according to their applications. Carbon content of steel castings for welded construction is to be max. 0.23% for its weldable quality.

**Mechanical properties:** Mechanical properties for normal quality steel castings in the original UR are to be applied. No Charpy V-notch impact test is to be required.

**Inspection:** Regarding requirements on non-destructive tests, IACS Recommendation No.69 which was adopted in 2000 is to be used as a sample of an acceptable standard.

**Rectification:** Procedure of removal of defect and weld repair is to be in accordance with IACS Recommendation No.69.

## **Technical Background (TB) document for UR W8 (Rev.2 May 2004)**

### **a) Objective/Scope**

The objective was to rationalize all UR Ws procedures on mechanical testing by reference to the new UR W2 (Rev.2, 2003).

### **b) Source of Proposed Requirements**

The revised draft UR was developed referring to the existing requirements of the UR W8 "Hull and machinery steel castings" and the UR W2 "Test specimens and mechanical testing procedures for materials".

### **c) Points of Discussion**

None

## **Technical Background (TB) document for UR W8 (Rev.3 Mar 2022)**

### **1. Scope and objectives**

Some class societies have experienced failures related to castings with inferior mechanical properties, where test coupons show acceptable results, but actual properties are low. Thus there is a need to define parameters for manufacturers to produce castings with acceptable properties and quality.

Define and further clarify appropriate dimensions of the sample for obtaining mechanical properties representative of the product.

UR W8 shall be extended to other steel grades (including steel alloy grades) which are common in industry.

Several industrial standards for steel castings require notch bar impact testing, which are not required according to current UR W8. Consideration was given whether notch bar impact testing should be introduced into UR W8, depending on the application.

### **2. Engineering background for technical basis and rationale**

Designers consider specified mechanical properties as verified by mechanical tests to be representative for the casting itself. However, for castings with higher thickness the actual properties of the cast component are often inferior to those obtained by testing due to the current non-representative test sample design.

Notch bar impact testing is considered to be a suitable measure for control of appropriately performed heat treatment.

C-Mn grades with higher strengths, and alloy steel grades are common in industry. Therefore, it is considered relevant that these castings should be represented within this UR, to have alignment with industry grades.

### **3. Source/derivation of the proposed IACS Resolution**

The following external industry standards were referenced as a source for technical rationale and preparation of this UR:

- ISO 4990:2015 – “General technical delivery requirements”
- EN 10293:2015 – “Steel castings - Steel castings for general engineering uses”
- ISO 683-1:2016 – “Heat-treatable steels, alloy steels and free-cutting steels - Part 1: Non-alloy steels for quenching and tempering”
- ISO 683-2:2016 – “Heat-treatable steels, alloy steels and free-cutting steels - Part 2: Alloy steels for quenching and tempering”
- ISO 148-1:2016 – “Metallic materials — Charpy pendulum impact test — Part 1: Test method”

### **4. Summary of Changes intended for the revised Resolution:**

- a) Addition of requirements for representative sample with dimensions representative for the ruling section of the casting. Requirements for the test block for alloy castings are added.



- b) Extension of UR W8 to C-Mn grades for castings for hull and machinery with higher specified min. strengths than currently  $R_m = 600$  MPa and  $R_p = 320$  MPa. Extension of UR W8 to alloy grades for castings for hull and machinery.
- c) Implementation of relevant requirements for chemical composition and tensile properties.
- d) A differentiation in mechanical property requirements between castings 'intended for welding' and those 'not intended for welding' (this has resulted in additional tables being inserted into this UR)
- e) Implementation of impact test requirements. Ambient temperature was introduced to be  $23^{\circ}\text{C} \pm 5^{\circ}\text{C}$  as per ISO 148-1:2016.
- f) For welding of cast steels for hull construction and marine structures references to UR W28 and UR W32, as well as recommendation for consideration of carbon equivalent  $C_{eq}$  were added. Requirements for temporary welds are added.
- g) Requirements for rectification for grinding and for repair welding added.
- h) IACS Rec. No.69 is referred to as an example of an acceptable standard for requirements for NDT.

## **5. Points of discussions or possible discussions**

In addition to the items under paragraph 4, the following items were discussed:

Due to the variety of possible national/international standards it was agreed to set up tensile test requirements and impact test requirements which were deduced from EN 10293 "Steel castings - Steel castings for general engineering uses".

Condition "fully annealed" for C-Mn castings was agreed to be kept.  
For alloy castings it was agreed that the condition "fully annealed" is not applicable.

## **6. Attachments if any:**

None.

## Technical Background (TB) document for UR W8 (Rev.4 Mar 2024)

### 1. Scope and objectives

- Develop practical requirements for representative quality test coupon size based upon critical casting cross section and material.
- Edit existing clause 6.3 and update where necessary, by preparing a new draft Rev.4.

### 2. Engineering background for technical basis and rationale

The test results represent the material from which the castings poured and the subsequent heat treatment process and may not necessarily represent the properties of the castings. These properties can be affected by solidification conditions and the rate of cooling during heat treatment, which are in turn influenced by casting thickness, size, complexity and shape. The purpose of the test block is to provide a qualitative check to demonstrate the effective control of existing heat treatment processes and procedures.

Also, the feedback from industry regarding UR W8 Rev.3 test block size is that the test block size (and subsequent weight) required by Clause 6.3 in UR W8 Rev 3 is too demanding and impractical for manufacturers to produce.

In light of the above, UR W8 Rev.3, Clause 6 was updated.

### 3. Source/derivation of the proposed IACS Resolution

The following external industry standards were referenced as a source for technical rationale and preparation of this UR:

- ISO 4990:2023 – “General technical delivery requirements”
- ISO 4885,2018 – “Ferrous materials -- Heat treatments -- Vocabulary”
- EN 10293:2015 – “Steel castings - Steel castings for general engineering uses”
- ISO 683-1:2016 – “Heat-treatable steels, alloy steels and free-cutting steels - Part 1: Non-alloy steels for quenching and tempering”
- ISO 683-2:2016 – “Heat-treatable steels, alloy steels and free-cutting steels - Part 2: Alloy steels for quenching and tempering”

### 4. Summary of Changes intended for the revised Resolution:

- Change in requirements for test block size.
- Providing requirements for an alternative regime or test block size, where certain applications may need specific properties to be achieved and demonstrated.
- Making reference to the casting ruling section in a variety of standards, to support alternative test block size.
- In addition, for determination of alternative test block sizes, recognition of supporting data from a variety of means, e.g. by historical and statistical test data, production of a representative test block or a component, simulation software, or a combination of these items

### 5. Points of discussions or possible discussions

- Test block size requirements (UR W8, Clause 6.3)
- Recognising industry feedback on the limitations of Rev.3 test block requirements, and establishing an acceptable quality regime for Rev.4.
- Establishing a suitable, practical and agreed test block size (and location) for applications where specific mechanical properties need to be achieved.

**6. Attachments if any:**

None.

## UR W11 “Normal and higher strength hull structural steels”

### Part A. Revision History

Version no.	Approval date	Implementation date when applicable
Rev. 9 (May 2017)	19 May 2017	1 July 2018
Rev. 8 (Apr 2014)	30 April 2014	1 July 2015
Corr.1 (Feb 2009)	16 February 2009	-
Rev.7 (Apr 2008)	03 April 2008	-
Rev.6 (May 2004)	24 May 2004	-
Rev.5 (July 2002)	30 July 2002	-
Rev.4 (May 2001)	17 May 2001	-
Rev.3 (June 2000)	15 June 2000	-
Rev.2 (1995)	<i>No record</i>	-
Rev.1 (1986)	<i>No record</i>	-
NEW (1979)	<i>No record</i>	-

- **Rev 9 (May 2017)**

**.1 Origin for Change:**

- Suggestion by an IACS member

**.2 Main Reason for Change:**

The main change relates to the incorporation of IACS Rec 12 into UR W11. The reason for this is to introduce requirements for surface quality of plates supplied to shipyards. Other changes consist of a review of the definitions of steel delivery conditions against current industry standards, and a revision to table 9 with consistent requirements for plates and sections made in steel grades A32, A36 refined with Al alone or with Ti.

**.3 List of non-IACS Member Classification Societies contributing through the TC Forum and/or participating in IACS Working Group:**

None.

**.4 History of Decisions Made:**

Original proposal to revise UR W11 to review delivery conditions was made at IACS EG/MW meeting in November 2012. Form A with task Number EMW1308 was agreed by GPG in January 2014. Additional proposal to revise UR W11 was to include IACS Recommendation 12 into the UR W11. Form A with task number EMW1410 was agreed by GPG in December 2014. The group decided to merge the two tasks into EMW1410 with the agreement of GPG in October 2015. Four drafts have been discussed by the group, final draft was agreed by EGMW in March 2017.

## **.5 Other Resolutions Changes**

IACS Rec 12 to be deleted.

### **.6 Dates:**

Original Proposal: January 2014      Made by: an IACS Member  
EG M&W Approval: March 2017  
GPG Approval: 19 May 2017 (Ref: 14167\_IGh)

## **• Rev 8 (Apr 2014)**

### **.1 Origin for Change:**

- Suggestion by an IACS member

### **.2 Main Reason for Change:**

This change relates to the incorporation of IACS UR W30 into UR W11. The reason for this is that the majority of UR W30 refers back to UR W11 and it has been decided that it is more logical to add the relatively small number of differences into W11 and have avoid the need to cross referencing to other UR documents.

### **.3 List of non-IACS Member Classification Societies contributing through the TC Forum and/or participating in IACS Working Group:**

None.

### **.4 History of Decisions Made:**

Original proposal was made at IACS EG/MW meeting in November 2012. Form A – with task Number EMW1301 was agreed by GPG. First draft was completed in September 2013. Final draft was agreed by EGMW in March 2014.

## **.5 Other Resolutions Changes**

IACS UR W30 to be deleted.

### **.6 Dates:**

Original Proposal: March 2014      Made by: an IACS Member  
EG M&W Approval: March 2014  
GPG Approval: 30 April 2014 (Ref: 10105\_IGq)

## **• Corr.1 (Feb 2009)**

Typo in Table 6 corrected (Subject No: 8554).  
No TB document available.

- **Rev.7 (Apr 2008)**

Revision of Appendix A to include procedures for the "approval of manufacturers' semi-finished products" (Subject No: 8554).

See separate TB document in Annex 5 for details.

- **Rev.6 (May 2004)**

Outcome of WP/MW Task 42 and 45 (Subject No: 3004a).

See separate TB document in Annex 4 for details.

- **Rev.5 (July 2002)**

Outcome of WP/MW Task 1-A submitted to GPG 52.

See separate TB document in Annex 3 for details.

- **Rev.4 (May 2001)**

Outcome of WP/MW Task 37 submitted to GPG 50.

See separate TB document in Annex 2 for details.

- **Rev.3 (June 2000)**

Outcome of AHG/MW Task No. 32 submitted to GPG 48.

See separate TB document in Annex 1 for details.

- **Rev.2 (1995)**

No TB document available.

- **Rev.1 (1986)**

No TB document available.

- **NEW (1979)**

No TB document available.

## Part B. Technical Background

List of Technical Background (TB) documents for UR W11:

Annex 1. **TB for Rev.3 (June 2000)**

See separate TB document in Annex 1.



Annex 2. **TB for Rev.4 (May 2001)**

See separate TB document in Annex 2.



Annex 3. **TB for Rev.5 (July 2002)**

See separate TB document in Annex 3.



Annex 4. **TB for Rev.6 (May 2004)**

See separate TB document in Annex 4.



Annex 5. **TB for Rev.7 (Apr 2008)**

See separate TB document in Annex 5.



Annex 6. **Interpretation given to POSCO on UR W11 (Jan 2012)**



Annex 7. **TB for Rev.8 (Apr 2014)**

See separate TB document in Annex 7.



Annex 8. **TB for Rev.9 (May 2017)**

See separate TB document in Annex 8.



**Note:** There are no separate Technical Background (TB) documents for the original resolution (1979), Rev.1 (1986), Rev.2 (1995) and Corr.1 (Feb 2009).

**GPG 48/5.17/WP.1/ Annex B2-4**

IACS Unified Requirement W11 (Rev.3, 2000.)

**Normal and higher strength hull structural steels****Technical Backgrounds:****a) Objective/Scope**

The objective was to introduce the “manufacturer’s responsibility concept” to the existing UR W11, from the viewpoint of production control in order to secure the more uniformed quality of hull steel products.

**b) Source of Proposed Requirements**

This revised draft UR was developed referring to the existing requirements of UR W11 “Normal and higher strength hull structural steels”(Rev.2).

**c) Points of Discussion**

The discussion had been mainly made on the following technical points and achieved full agreement of the members:

**Manufacturer’s responsibility concept:**

The manufacturer’s responsibility concept is to be specified in the revised Clauses 2.2 and 3.3, which require that:

- \_ Manufacturer is to control and assure the in-operation processes and production conditions.
- \_ Where deviation from the controls and/or inferior quality of the products were found, the manufacturer is required to take further measures to the Surveyor’s satisfaction.

**Definition of the rolling procedures:**

As conventional rolling and heat treatment procedures, “As rolled (AR)” and “Normalising (N)”, are to be newly defined in the revised Clause 3.3 in order to cover all the procedures that apply to the present production of hull steels.

—



**TB**

IACS Unified Requirement W11 (Rev.4 May 2001)

**Normal and higher strength hull structural steels****Technical Backgrounds:****a) Objective/Scope**

The objective was to develop the “manufacturing approval scheme of hull structural steels” as an Appendix of UR W11, from the viewpoint of production control to secure more uniformed quality of hull steel products.

**b) Source of Proposed Requirements**

The above Appendix was developed to supplement the relative requirements of UR W11 “Normal and higher strength hull structural steels” (Rev. 3).

**c) Points of Discussion**

The discussion on the following technical points had been made and achieved full agreement of the members:

Manufacturing approval;

The manufacturing approval scheme is valid for verifying the manufacturer’s capability to produce satisfactory products stably.

Manufacturing documents;

Where the programmed rolling (CR or TM) is applied, the technical details of rolling practice are to be reviewed, in addition to general documents relevant to the outline of steel works, manufacturing facilities, manufacturing process, quality control, etc.

Approval tests;

Test program should be confirmed before testing. For grades E, AH, DH and EH, weldability tests are to be additionally carried out. In case of new type of steels, conformable tests may be required to evaluate their quality and properties.

Approval documentation;

The validity of the approval is to be a maximum of five years. Renewal can be carried out by audit and assessment. The approval is to be re-considered where the major problems on manufacturing process or finished products are found.

Remark: GPG 50 (March 2001) expressed its concern over a possible lack of uniformity in practice with reference to renewal of approval in para.6 of Appendix A. At the request of GPG, WP Chair came up with an explanatory note to the second sentence of para.6.

GPG/Council agreed that the revision history in the Note to Appendix B, should be deleted from UR W 11 and added to the TB on 11 May 2001. See the annex.

\* \* \* \* \*

Annex: Revision history of W 11

## Revision History of UR W 11

These requirements were first adopted as

UR.1 Requirements for Hull Structural Steels (1959) and

UR.12 Requirements for High Tensile Hull Structural Steels (1971)

These were subsequently revised to incorporate S1 units and were adopted as

UR 128 Normal Strength Hull Structural Steel (1977) and

UR 132 Requirements for High Tensile Hull Structural Steel (1977).

**In 1979** these requirements were further revised and combined as UR 162 which was subsequently re-printed and issued as Unified Requirement W11.

**In 1994**, these requirements were revised on the basis of the contents of

W11. Normal and higher strength hull structural steels

W19. Normal and higher strength hull structural steel grades E and E36 with thickness above 50 up to 100 mm.

W20. Higher strength hull structural steels with a minimum yield strength of 390 N/mm<sup>2</sup> and

W21. Hull structural steels for low temperature application and reissued as Unified Requirement W11.

\* \* \* \* \*

**Technical background  
IACS Unified Requirement W11 (Rev. 5)**

**Normal and higher strength hull structural steels**

**Technical Backgrounds:**

**a) Objective/Scope**

The objectives were as follows:

1. To amend the requirement concerning manufacturer's responsibility in order to remove the reservation lodged by ABS.
2. To develop the requirements in the existing UR W11 for grades AH40, DH40, EH40 and grades FH hull structural steel plates with thickness over 50mm up to 100mm.

**b) Source of Proposed Requirements**

This revised draft UR was developed referring to the existing requirements of UR W11 "Normal and higher strength hull structural steels" (Rev. 4).

**c) Points of Discussion**

The discussion on the following technical points had been made and achieved full agreement of the members:

Manufacturer's responsibility;

Where imperfection of process and production controls occurs, the manufacturer is to identify the cause and establish a countermeasure to prevent its recurrence.

Definition of heat treatment process;

Heat treatment process "Quenching and Tempering (QT)" is also to be defined in clause 3.3 and Appendix B as well.

Chemical composition;

Maximum carbon equivalent is to be specified for the grades concerned according to each strength level.

Type of applicable heat treatment;

Applicable heat treatments, i.e. Normalizing, Thermo-Mechanical Rolling and Quenching and Tempering are to be specified for the grades concerned.

Toughness requirement;

Minimum average impact energy is to be specified for each the grade concerned according to the range of thickness. In addition, the above energy values for HT40 grades with thickness up to 50mm are to be modified from the viewpoint of well-balanced toughness requirement.

Number of impact test specimens;

Batch size of impact test for each the grade concerned is to be specified respectively according to the heat treatment applied.

## **Annex**

### **Revision History of UR W11**

These requirements were first adopted as  
UR.1 “Requirements for Hull Structural Steels” (1959) and  
UR.12 “Requirements for High Tensile Hull Structural Steels” (1971)

These were subsequently revised to incorporate S1 units and were adopted as  
UR 128 “Normal Strength Hull Structural Steel” (1977) and  
UR 132 “Requirements for High Tensile Hull Structural Steel” (1977).

**In 1979**, these requirements were further revised and combined as UR 162, which was subsequently re-printed and issued as Unified Requirement W11.

**In 1994**, these requirements were revised on the basis of the contents of  
W11 “Normal and higher strength hull structural steels”  
W19 “Normal and higher strength hull structural steel grades E and E36 with thickness above 50 up to 100 mm”  
W20 “Higher strength hull structural steels with a minimum yield strength of 390 N/mm<sup>2</sup>” and  
W21 “Hull structural steels for low temperature application”  
and reissued as Unified Requirement W11.

\* \* \* \*

submitted by WP/MCH to GPG 52, 12-15 March 2002

## IACS Unified Requirement W11 (Rev.6) Technical Background

### Normal and higher strength hull structural steels

#### a) Objective/Scope

The objective were as follows:

1. To rationalize all UR Ws procedures on mechanical testing by reference to the new UR W2 (Rev.2, 2003).
2. To develop a manufacturing approval scheme of hull structural steels welded with high heat input as an Appendix of UR W11.

#### b) Source of Proposed Requirements

The revised draft UR was developed referring to the existing requirements of the UR W2 “Test specimens and mechanical testing procedures for materials” and the UR W11 “Normal and higher strength hull structural steels” including the Appendix A “Manufacturing approval scheme of hull structural steels”.

#### c) Points of Discussion

The discussion on the following technical points for the above a) objective/Scope 2 had been made and achieved full agreement of the members:

##### Scope;

The approval scheme specifies weldability confirmation scheme of hull structural steels intended for welding with high heat input over 50kJ/cm and is valid for certifying that the steels have satisfactory weldability for high heat input welding concerned under testing conditions. This approval scheme is to be generally applied by manufacturer’s option and does not apply to qualification of welding procedures to be undertaken by the shipyards.

##### Range of certification;

Range of certification for steel grades is to be specified with the following key concepts:

- Approval tests on the lowest and highest toughness levels cover the intermediate toughness level.
- Approval tests on normal strength level cover that strength level only.
- For higher tensile steels, approval tests on one strength level cover strength level immediately below.

##### Test plate;

For each manufacturing process route, two test plates with different thickness ( $t$  and less than or equal to  $t/2$ ) proposed by the manufacturer are to be selected.

##### Charpy V-notch Impact test;

Requirements for notch location, test temperature and average impact energy are to be the same as those specified for base metal, i.e. the requirements of the UR W11 including the Appendix A.

##### Certification;

The Classification Society issues the certificate to the manufacturer (steel mill), including the information of steel grade designation with notation of heat input, manufacturing process, plate thickness tested and welding conditions etc.

##### Grade designation;

Upon issuance of the certificate, the notation indicating the value of heat input applied in the confirmation test may be added to the grade designation of the test plate, e.g. “E36-W300” (in the case of heat input 300kJ/cm applied).

\* \* \* \*

## **TECHNICAL BACKGROUND OF UR W11 (REV.7, APRIL 2008)**

### **1. Scope and objective**

To develop procedures for the approval of manufacturers of semi finished products intended for subsequent rolling at approved steel mills into ship steel plate, sections and bars.

### **2. Background**

There has been a considerable increase in the number of cases where non-approved manufacturers have produced and supplied semi-finished products which have been subsequently rolled by approved manufacturers, no unified requirement exists to cover this situation. Different class societies deal with such manufacturers in different ways. Issues of quality variation have also been noted in the semi-finished products delivered.

The approved manufacturers would prefer a unified approach and in is therefore proposed to develop the requirements for approval of steel slabs and for approval of rolled steels using the slabs as an amendment to UR W11 Appendix A.

### **3. Points of discussions**

The project team found common ground on the procedures to be followed.

Discussion on the necessary links between the manufacturer of the semi-finished product and the subsequent manufacturer of the rolled steel product provided more varied debate. The outcome agreed being a simple approach of approving a semi-finished manufacturer in isolation, allowing supply after approval to all approved finishing mills. One society had a strong view that both manufacturers should have a fixed link, it was agreed that this latter approach could be applied by the individual society within its own Rules as their enhanced requirement.

A number of points were raised by the Hull Panel on the first draft submitted. These were reviewed by PT2 and where appropriate amendments made or reasons for rejecting the suggestions given.

### **4. Amendment.**

The Hull Panel and its PT2 agreed to revise UR W11 Appendix A to include the necessary procedures for the “approval of manufacturers semi finished products” and define the necessary links with approved manufacturers of rolled steels products.

### **5. Source/Derivation of proposed interpretation**

N.A.

### **6. Decision by voting**

N.A.

Submitted by Hull Panel Chairman  
14 March 2008

### **Permanent Secretariat note, May 2008:**

UR W11 Rev. 7 was approved by GPG on 3 April 2008, ref. 8554\_IGb.

## Interpretation given to POSCO on UR W11 (Jan 2012)

*(i) Question:*

*In the description of the AR process, does the word "typically" indicate that the temperature condition is recommended or compulsory? POSCO believes that it does not compel any temperature control in the AR process as described in EN10025-2. Please advise the exact meaning.*

You are correct in your assumption that the "as rolled" IACS definition does not imply any form of temperature control. The word "typically" indicates neither a recommendation nor a compulsory requirement. It rather indicates the same as the description given in the EN 10025-2, i.e. there is no strict control of the rolling temperature.

*(ii) Question:*

*Please advise the proper finishing rolling temperature for the chemical composition provided.*

Classification Societies are not in a position to specify the finishing rolling temperature to be applied. It is the responsibility of the steel mill to determine the finishing rolling temperature based on the local processes and well known metallurgical effects.

The role of Classification Societies is to approve different material grades based on approval testing and review of documentation, e.g. rolling schedule, and make sure that the Classification Rules are complied with. The finishing rolling temperature for the "as rolled" process is part of the manufacturer's rolling process, which is to be documented at approval stage per UR W11, Appendix A2, Article 2.1(g).

(Ref: 11161\_IGd dated 20<sup>th</sup> January 2012)

## **Technical Background (TB) document for UR W11 (Rev. 8, Apr 2014)**

### 1. Scope and objectives

UR W30 was previously introduced in relation to approval and certification of corrosion resistant steel in accordance with MSC.289 (87) of Regulation 3-11, Part A-1, Chapter II-1 of the SOLAS Convention (Corrosion protection of cargo oil tanks of crude oil tankers). Based upon the level of repetition and cross references to UR W11, and to avoid unnecessary complication, the requirements of UR W30 have been incorporated into W11 to have all identical requirements in the same location.

### 2. Engineering background for technical basis and rationale

The general requirements of UR W30 are identical to those of UR W11. To avoid unnecessary duplication and the potential of failing to update both UR documents as appropriate in the future, the unique requirements related to corrosion resistant steel have been added to UR W11.

### 3. Source/derivation of the proposed IACS Resolution

Documents relevant to these changes are:

- IACS UR W30: Normal and higher strength corrosion resistant steels for cargo oil tanks

### 4. Summary of Changes intended for the revised Resolution:

The changes added to W11 are summarised as follows:

- References to MSC.289 (87) of Regulation 3-11, Part A-1, Chapter II-1 of the SOLAS Convention (Corrosion protection of cargo oil tanks of crude oil tankers) an scope of thickness applicable to corrosion resistant steel
- Definition of corrosion resistant steel grading
- Additional certification requirements
- Addition of Annex C which specifies the requirements for manufacturer approval of corrosion resistant steel.

### 5. Points of discussions or possible discussions

Due to this revision incorporating all requirements of UR W30 into UR W11 without any change in technical content there are no relevant points for discussion associated with this revision.

### 6. Attachments, if any

None



## **Technical Background (TB) document for UR W11 (Rev.9 May 2017)**

### **1. Scope and objectives**

To review and amend the definitions of steel delivery conditions used in UR W11 against current industry standards.

To develop the appropriate requirements for surface quality of plates in order to include the IACS Recommendation 12 into the UR W11.

To revise table 9 to have consistent requirements for plates and sections made in steel grades A32, A36 refined with Al alone or with Ti.

### **2. Engineering background for technical basis and rationale**

Permitted rolling procedures are defined within UR W11 section 3.3 in the following ways: As Rolled (AR), Normalised (N), Controlled Rolled (CR) / Normalized Rolled (NR), Quench and Tempered (QT), and Thermo-Mechanically Rolled (TM) / Thermo-Mechanically Controlled Processed (TMCP).

The definitions for AR and CR/NR are no longer found to represent the definitions that are widely used in the steelmaking industry resulting in approval and certification of steels that do not comply with the definitions in UR W11.

Based upon the above there is a need to review the IACS definitions of all rolling procedure against the definitions commonly used in industry and modify UR W11 as appropriate.

Sometimes dispute occurs over the surface quality of plate supplied to shipyards. Therefore it is found necessary to harmonise the requirements to include the surface quality given in Rec 12 into URW11. To make clear what surface imperfections are considered as defects, and identify the permissible extent of surface imperfections. Identify that the manufacturer is responsible for the surface quality. Indicate the allowable repair techniques.

### **3. Source/derivation of the proposed IACS Resolution**

Reference is made to IACS Recommendation 12 "Guidelines for Surface Finish of Hot Rolled Steel Plates and Wide Flats".

### **4. Summary of Changes intended for the revised Resolution**

The definitions of steel delivery conditions As Rolled, Normalising, Controlled Rolling, Quenching and Tempering have been reviewed and updated. The diagram of Thermo-Mechanical and Conventional Processes has been amended. The article 7 "Surface quality" has been added to the UR W11.

Table 9 has been revised to align requirements for plates and sections made in steel grades A32, A36 refined with Al alone or with Ti.

### **5. Points of discussions or possible discussions**

The definitions of steel delivery conditions were discussed and agreed with general consensus of the group. Discussions took place about the need to keep the internal soundness requirements as they are in the URW11 and the group concluded positively. The group discussed the permissible limits for imperfections and decided to refer to the Class A of the standard EN 10163-2 while allowing to refer to a recognised equivalent standard.

### **6. Attachments if any**

Nil.

## UR W13 "Thickness tolerances of steel plates and wide flats"

### Summary

Review and update industry standards format according to GPG instructions

### Part A. Revision History

Version no.	Approval date	Implementation date when applicable
Rev.7 (Sep 2021)	21 September 2021	1 January 2023
Rev.6 (June 2018)	06 June 2018	1 July 2019
Corr.1 (May 2012)	22 May 2012	-
Rev.5 (Feb 2012)	02 February 2012	1 January 2013
Rev.4 (Oct 2009)	2 October 2009	1 January 2011
Rev.3 (1995)	1995	-
Rev.2 (1992)	1992	-
Rev.1 (1989)	1989	-
New (1981)	1981	-

#### • Rev.7 (Sep 2021)

##### 1 Origin of Change:

- Suggestion by IACS member

##### 2 Main Reason for Change:

To update industry standards format according to GPG instructions given in GPG Vice-chair message 19000\_IRC.

##### 3 List of non-IACS Member classification societies contributing through the TC Forum and/or participating in IACS Working Group:

None.

##### 4 History of Decisions Made:

Original proposal was made according to GPG Vice-chair message 19000\_IRC. Proposal to revise the IACS URs and RECs only to refer to a dated version of the industry standard as per GPG instructions was made at IACS EG/MW meeting in September 2019. Three drafts have been discussed by the group.

##### 5 Other Resolutions Changes:

None.

## **6 Any hinderance to MASS, including any other new technologies:**

None.

## **7 Dates:**

Original Proposal : April 2019 Made by: GPG  
EG M&W Approval : July 2021  
GPG Approval : 21 September 2021 (Ref: 19000\_IGq)

### **• Rev.6 (June 2018)**

#### **.1 Origin for Change:**

- Alignment and consistency with UR W16.

#### **.2 Main Reason for Change:**

After UR W16 having been revised, UR W13 needed amendment for consistency with UR W16. Increased steel plate thickness up to, and exceeding 250 mm has to be covered. The class of minus tolerances for the steel grades in the scope of UR W16 needed to be treated. Further minor changes were needed.

#### **.3 List of non-IACS Member Classification Societies contributing through the TC Forum and/or participating in IACS Working Group:**

None

#### **.4 History of Decisions Made:**

The EG M&W decided that this UR is not applicable to lifting appliances.

#### **.5 Other Resolutions Changes**

None.

#### **.6 Dates:**

Original Proposal : December 2016  
EG M&W Approval : 11 May 2018 (Ref: EMW1605)  
GPG Approval : 06 June 2018 (16172aIGe)

## **Corr.1 (May 2012)**

### **.1 Origin for Change:**

- Suggestion by Hull Panel Chairman

### **.2 Main Reason for Change:**

To correct a Typographical error - in Section W13.1.3, the reference to 'Table B.2' in ISO 7452 should be changed to 'Table 2'.

### **.3 List of non-IACS Member classification societies contributing through the TC Forum and/or participating in IACS Working Group:**

None

### **.4 History of Decisions Made:**

Hull panel pointed out this error. PermSec made editorial change in the text. Since the correction was of purely editorial in nature, a separate technical background document was not prepared.

### **.5 Other Resolutions Changes**

None

### **.6 Dates:**

Original proposal: April 2012 made by: Hull panel  
GPG Approval: 22 May 2012 (Ref. 11158\_IGi)

## **• Rev.5 (Feb 2012)**

### **.1 Origin for Change:**

- Suggestion by IACS members

### **.2 Main Reason for Change:**

UR W13 was amended to clarify two items:

- 1) The thickness measuring locations for steel plate and cut steel products.
- 2) The minus tolerance for thickness when ISO 7452 Class C is applied in lieu of W13.3.

### **.3 List of non-IACS Member classification societies contributing through the TC Forum and/or participating in IACS Working Group:**

None

#### **.4 History of Decisions Made:**

- 1) UR W13 was amended at the request of some Hull Panel members. These requests were taken into consideration and a proposal was developed.
- 2) At the end of December 2010, one Hull Panel member requested a clarification from the Hull Panel regarding the required measuring points for steel rolled plates and cut steel products. After Hull Panel discussion, the Hull Panel handed a clarification to the member. The Member took the opportunity to formally document this clarification by delivering a proposal to modify UR W13.
- 3) Early in May 2011, another Hull Panel member requested a clarification regarding the intent of W13.1.3 and ISO 7452 Table 2 Class C and the minus tolerance for thickness. After discussion within the Hull Panel, original proposal was modified to reflect comments made by Hull Panel Members regarding clarifications given.

#### **.5 Other Resolutions Changes**

None

#### **.6 Dates:**

Original proposal : Dec 2010& May 2011 made by: Members of Hull panel  
Panel Approval : October 2011 by: Hull panel  
GPG Approval : 02 February 2012 (Ref. 11158\_IGg)

#### **• Rev.4 (Oct 2009)**

##### **.1 Origin for Change:**

- Request by non-IACS entity: *Union of Greek Shipowners*

##### **.2 Main Reason for Change:**

UR W13 Rev.3 is amended to require that the measured average plate thickness in a group of neighbouring plates is equal to or greater than the plates' specified nominal thickness.

##### **.3 History of Decisions Made:**

Revision 4 of UR W13 was unanimously agreed within the PT3 of Hull Panel and thereafter approved by the Hull Panel.

##### **.4 Other Resolutions Changes**

None

## **.5 Any dissenting views**

None

## **.6 Dates:**

Original Proposal : April 2009, made by PT3 of Hull Panel

Hull Panel Approval : August 2009

GPG Approval : 2 October 2009 (ref. 9560\_IGh)

- **Rev.3 (1995)**

No records are available.

- **Rev.2 (1992)**

No records are available.

- **Rev.1 (1989)**

No records are available.

- **NEW (1995)**

No records are available.

## **Part B. Technical Background**

List of Technical Background (TB) documents for UR W13:

Annex 1. **TB for Rev.4 (Oct 2009)**

See separate TB document in Annex 1.

Annex 2. **TB for Rev.5 (Feb 2012)**

See separate TB document in Annex 2.

Annex 3. **TB for Rev.6 (June 2018)**

See separate TB document in Annex 3.

Annex 4. **TB for Rev.7 (Sep 2021)**

See separate TB document in Annex 4.

**Note:** *There are no separate Technical Background (TB) documents for the original resolution (1981), Rev.1 (1989), Rev.2 (1992), Rev.3 (1995) and Corr.1 (May 2012).*

## Technical Background (TB) document

### UR W13, Rev.4 (October 2009) *[Hull Panel Task 34]*

#### 1. Scope and objectives

Amend IACS UR W13 to:

- require that the measured average plate thickness in a group of neighbouring plates is equal to or greater than the plates' specified nominal thickness;
- require that no individual thickness measurement will be more than 0.3 mm below the specified nominal thickness;
- require that, where plates are not shot-blasted and primed at the steel-mills, the shipyard is to take adequate precautions during storage and handling to ensure average thickness is maintained prior to use during the vessels construction.

#### 2. Engineering background for technical basis and rationale

HP PT3 reviewed available standards for plate measurement and thickness determination with a view to using them as a basis to specify the number and location of the required thickness readings to give confidence that the batch of plates meets the requirements as specified in Scope and Objectives.

#### 3. Source/derivation of the proposed IACS Resolution

3.1 Industrial/national/international standards for the thickness measurement of steel plates:

- There are no standards about the method of thickness measurement for hot rolled plates or defining what is average thickness.
- There are some standards for the thickness tolerances.
  1. ISO 7452: Hot-rolled structural steel plates – Tolerances on dimensions and shape
  2. EN10029: Tolerances on dimensions, shape and mass for hot rolled steel plates 3mm thick or above
  3. ASTM A6: Specification for General Requirements for Rolled Structural Steel Bars, Plates, Shapes and Sheet Piling

3.2 Current practice for thickness measurement:

- Thickness measurement techniques are either on-line automated or off-line manual methods for hull structural steel plates.
- Plate is rejected if, at any confirmation point, thickness reading is below the lower tolerance limit.
- Number of measuring points, measuring locations and measuring time are very much diverse between on-line automated or off-line manual methods.
- The statistics show that the mean of average plate thickness measured during some periods is well above the nominal thickness.



#### **4. Summary of Changes intended for the revised Resolution:**

- require that the measured average plate thickness in a group of neighbouring plates is equal to or greater than the plates' specified nominal thickness;
- define the average thickness and measuring locations
- require that, where plates are not shot-blasted and primed at the steel-mills, the shipyard is to take adequate precautions during storage and handling to ensure average thickness is maintained prior to use during the vessels construction
- In case where the steel mills apply zero minus tolerance, i.e. Class C of ISO 7452, their present recording procedure may be allowed.

#### **5. Points of discussions or possible discussions**

- Although the minus tolerance is 0.3 mm irrespective of nominal thickness, actual minus tolerance is expected to be close to 0.0 mm in consideration of the requirement that the measured average plate thickness is equal to or greater than the plates' specified nominal thickness.
- Definition of 'a group of neighbouring plates' and 'average plate thickness' could not be decided in a concrete manner due to the diversity of the steel mill production system.
- Standardization of the systematic thickness measurements is difficult due to the diversity of measuring method and measuring equipment.

#### **6. Attachments if any**

## Technical Background for UR W13 Rev.5, Feb 2012

### 1. Scope and objectives

Amend IACS UR W13 to:

- Clarify the thickness measuring locations for steel plate and subsequent cut steel products.
- Clarify the minus tolerance for thickness when ISO 7452 Class C is applied in lieu of W13.3.
- Provide general modifications or reorganization to sections affected by the above changes.

### 2. Engineering background for technical basis and rationale

#### 2.1 Intent of ISO 7452 Class C:

- W13 allows for the application of ISO 7452 Class C in lieu of W13.3.
- ISO 7452 Table B2 has a footnote which Part of which reads: "Also a minus side of thickness of 0,3 mm is permitted." However, Class C allows no minus tolerance, which is contradicted by the footnote.
- To avoid confusion in ensuring no minus tolerance is allowed and to prevent incorrect interpretations of the thickness measurement method used, an amendment was made to Section W13.1.3 advising that the part of the footnote referenced above is not applicable.
- If ISO 7452 is to be applied, UR W13.4 and W13.5 need not be applied. Since the ISO 7452 does not include specification for the number and location of measurements to establish that the plates are at or above the specified nominal thickness, and W13.4 and W13.5 are not applied, the number and location of measurements when ISO 7452 is used is left up to the satisfaction of each individual Class Society (see the second paragraph of W13.1.3).

#### 2.2 Thickness Measuring Locations:

- There was confusion about the application of measure locations for steel plate rolled directly from one slab or ingot (steel plates) and the products cut from those plates (cut steel products).
  - Although it was understood that the steel plate needed to be measured per UR W13, it was unclear whether or not the cut steel products needed to be measured.
- Based on common practice and the general intent of the UR, it was agreed that the measuring locations and requirements need only apply to the steel plate and not the steel products cut from the plate.
- This clarification was made in UR W13 via a NOTE in section A.2 and Figures A1 and A2.

### 3. Source/derivation of the proposed IACS Resolution

ISO 7452

### 4. Summary of Changes intended for the revised Resolution:

- Section 13.1.1: Definition of wide flats provided.

- Section 13.1.2: The in-text note was moved to Sect. 13.1.1
- Section 13.1.3: This section was amended to describe the minus tolerance for thickness when applying Class C of ISO 7452
- Footnotes: Footnote 1 was modified to reflect the current revision.
- A.2: An in-text NOTE was added to describe the application of the thickness measurement on steel plate.
- Figure A.1, Figure A.2: Figure A.1 was modified and Figure A.2 added to reflect the clarification on the location of thickness measurement for steel plate and the relation to the cut steel products

#### **5. Points of discussions or possible discussions**

None

#### **6. Attachments if any**

None

## **Technical Background (TB) document for UR W13 (Rev.6 June 2018)**

### **1. Scope and objectives**

Amend IACS UR W13 to:

- Apply the same criteria regardless of thickness for tolerance on nominal thickness to the following types of steel plates (same as UR W13 revision 5):
  - 1) Hull structural steel plates as per UR W11
  - 2) High strength steel plates for welded structure as per UR W16
- Clarify the minus tolerance for thickness up to, and exceeding 250 mm for products for machinery structures.

### **2. Engineering background for technical basis and rationale**

After UR W16 having been revised, UR W13 needed amendment for consistency with UR W16. The class of minus tolerances for the steel grades in the scope of UR W16 needed to be treated. Further minor changes were necessary.

### **3. Source/derivation of the proposed IACS Resolution**

IACS UR W16

### **4. Summary of Changes intended for the revised Resolution:**

- Section 13.1.1: Proposal for thickness tolerances for thickness below 5 mm is given.
- New section 13.1.2 added, indication that UR W13 is not applicable to lifting appliances.
- Section 13.1.4: Year of edition for applicable ISO 7452 is added, i.e. 2013.
- Section 13.3.3: minus tolerances added for nominal thicknesses  $t$  between 3-5, 40-80, 80-150, 150-250, and above 250 mm for products for machinery structures.
- Section 13.3.4: Added that for repair by grinding UR W11.7.4.1 has to be applied.
- Section 13.3.5: Added that for plus tolerances Classification Society or purchaser may apply other requirements than national/international standards.

### **.5 Points of discussions or possible discussions**

New section 13.1.2: The group discussed the question of minus tolerance for plates in steel grades covered by UR W16. The group recognised that the use for main offshore structures would correspond to a minus tolerance of 0.3mm while other minus tolerances may be acceptable for other types of constructions, typically lifting appliances. Therefore the group agreed that IACS UR W13 is not applicable to lifting appliances.

### **.6 Attachments if any:**

None.

**Technical Background (TB) document for UR W13 (Rev.7 Sep 2021)**

**1. Scope and objectives**

Review and update industry standards format according to GPG instructions.

**2. Engineering background for technical basis and rationale**

N.A.

**3. Source/derivation of the proposed IACS Resolution**

ISO 7452:2013

**4. Summary of Changes intended for the revised Resolution:**

Industry standards format has been updated according to GPG instructions.

**5. Points of discussions or possible discussions**

None.

**6. Attachments if any**

None.

## UR W14 Steel plates and wide flats with specified minimum through thickness properties (“Z” quality)

### Summary

Review and update industry standards format according to GPG instructions

### Part A. Revision History

Version no.	Approval date	Implementation date when applicable
Rev.3 (Sep 2021)	21 September 2021	1 January 2023
Rev.2 (May 2004)	May 2004	-
Rev.1 (July 2002)	July 2002	-
New 1982	1982	-

#### • Rev. 3 (Sep 2021)

##### 1 Origin of Change:

- Suggestion by IACS member

##### 2 Main Reason for Change:

To update industry standards format according to GPG instructions given in GPG Vice-chair message 19000\_IRC.

##### 3 List of non-IACS Member classification societies contributing through the TC Forum and/or participating in IACS Working Group:

None.

##### 4 History of Decisions Made:

Original proposal was made according to GPG Vice-chair message 19000\_IRC. Proposal to revise the IACS URs and RECs only to refer to a dated version of the industry standard as per GPG instructions was made at IACS EG/MW meeting in September 2019. Three drafts have been discussed by the group.

##### 5 Other Resolutions Changes:

None.

##### 6 Any hinderance to MASS, including any other new technologies:

None.

## **7 Dates:**

Original Proposal : April 2019 (Made by: GPG)  
EG M&W Approval : July 2021  
GPG Approval : 21 September 2021 (Ref: 19000\_IGq)

- **Rev. 2 (May 2004)**

No records available.

- **Rev.1 (July 2002)**

No records available.

- **New (1982)**

No records available.

\*\*\*\*\*

## **Part B. Technical Background**

List of Technical Background (TB) documents for UR W14:

Annex 1. **TB for Rev.1 (July 2002)**

See separate TB document in Annex 1.

Annex 2. **TB for Rev.2 (May 2004)**

See separate TB document in Annex 2.

Annex 3. **TB for Rev.3 (Sep 2021)**

See separate TB document in Annex 3.

**Note:** *There are no Technical Background (TB) documents available for New (1982).*



**Technical Background (TB)**  
**IACS Unified Requirement W14 (Rev. 1)**

**Steel plates and wide flats with specified minimum through thickness properties (“Z” quality)**

**Technical Backgrounds:**

**a) Objective/Scope**

The objective was to revise the existing UR W14 from the viewpoint of the consistency between the existing requirements and current best practice.

**b) Source of Proposed Requirements**

This revised draft UR was developed referring to the existing requirements of UR W14 “Steel plates and wide flats with improved through thickness properties”.

**c) Points of Discussion**

The discussion on the following technical points had been made and achieved full agreement of the members:

Scope;

Two “Z” quality steels are to be specified, Z25 for normal ship application and Z35 for more severe applications.

Manufacture;

The approval should follow the procedure given in UR W11 Appendix A but take into account various improved steelmaking process and the control of centre-line segregation during continuous casting.

Chemical composition;

Maximum sulphur content determined by the ladle analysis is to be specified.

Test sampling;

Batch size is to be specified according to type of product and sulphur content.

Acceptance values for reduction of area;

Minimum average and minimum individual values for reduction of area are to be specified for Z25 and Z35 respectively.

Re-test procedure;

Acceptable test result, retest-permitted result and acceptable retest result are to be specified using the schematic diagram.

Note: At the request of ABS, WP Chairman suggested further amendment to be added to W14.3.4 for clarity: “Round test specimens including built-up type by welding are to be prepared in accordance with a recognized standard” (1058aIGb, 10 May 02). Approved.

• \* \* \* \*

submitted by WP/MCH to GPG 52, 12-15 March 2002

IACS Unified Requirement W14 (Rev.2)  
Technical Background

**Steel plates and wide flats with specified minimum through thickness properties (“Z” quality)**

- a) Objective/Scope  
The objective was to eliminate the difficulty of the member’s implementation.
- b) Source of Proposed Requirements  
The revised draft UR was developed referring to the existing requirements of the UR W14 “Steel plates and wide flats with specified minimum through thickness properties (“Z” quality)”, EN 10160 and ASTM A578.
- c) Points of Discussion  
The discussion on the following technical point had been made and achieved full agreement of the members:  
Ultrasonic tests;  
The requirement level of EN10160 is to be Level S1/E1 from the viewpoint of the conformance with ASTM A578 Level C.

\* \* \* \* \*

## **Technical Background (TB) document for UR W14 (Rev.3 Sep 2021)**

### **1. Scope and objectives**

Review and update industry standards format according to GPG instructions.

### **2. Engineering background for technical basis and rationale**

None.

### **3. Source/derivation of the proposed IACS Resolution**

ASTM A578:2017  
EN 10160:1999

### **4. Summary of Changes intended for the revised Resolution:**

Industry standards format has been updated according to GPG instructions.

### **5. Points of discussions or possible discussions**

None.

### **6. Attachments if any**

None.

IACS Unified Requirement W14 (Rev.2)  
Technical Background

**Steel plates and wide flats with specified minimum through thickness properties (“Z” quality)**

- a) Objective/Scope  
The objective was to eliminate the difficulty of the member’s implementation.
  
- b) Source of Proposed Requirements  
The revised draft UR was developed referring to the existing requirements of the UR W14 “Steel plates and wide flats with specified minimum through thickness properties (“Z” quality)”, EN 10160 and ASTM A578.
  
- c) Points of Discussion  
The discussion on the following technical point had been made and achieved full agreement of the members:  
Ultrasonic tests;  
The requirement level of EN10160 is to be Level S1/E1 from the viewpoint of the conformance with ASTM A578 Level C.

\* \* \* \* \*

## **Technical Background (TB) document for UR W14 (Rev.3 Sep 2021)**

### **1. Scope and objectives**

Review and update industry standards format according to GPG instructions.

### **2. Engineering background for technical basis and rationale**

None.

### **3. Source/derivation of the proposed IACS Resolution**

ASTM A578:2017  
EN 10160:1999

### **4. Summary of Changes intended for the revised Resolution:**

Industry standards format has been updated according to GPG instructions.

### **5. Points of discussions or possible discussions**

None.

### **6. Attachments if any**

None.

## UR W16 “High Strength Steels for Welded Structures”

### Part A. Revision History

Version no.	Approval date	Implementation date when applicable
Rev.3 (Mar 2016)	1 March 2016	1 July 2017
Rev.2 (May 2004)	24 May 2004	-
Rev.1 (1994)	<i>No record</i>	-
New (1984)	<i>No record</i>	-

#### • Rev.3 (Mar 2016)

##### .1 Origin for Change:

- Suggestion by IACS member
- Based on Other Standard (*EN 10025 and EN10225, and ISO 630*)
- Other (*Offshore and marine Industry demands for including S890 steel grade, also the steelmaking industry considered the current UR W16 obsolete*)

##### .2 Main Reason for Change:

- 1) Current UR W16 has not been updated since 2004, however the manufacturing technology of steelmaking of high strength steels has advanced;
- 2) Updates to the requirements in UR W16 are required in line with the international material standards for high strength steels;
- 3) A unified procedure is required for the approval of the manufacturer of high strength steels;
- 4) The scope of UR W16 needs to be expanded to include steels with yield strength higher than 690 N/mm<sup>2</sup> which have been successfully used by the offshore industries for decades.

##### .3 List of non-IACS Member Classification Societies contributing through the TC Forum and/or participating in IACS Working Group:

None

##### .4 History of Decisions Made:

In October 2013, the IACS EGMW agreed in their annual meeting that UR W16 urgently needs updating in order to meet the industry requirements and provide appropriate requirements on material properties.

GPG agreed to Permsec’s proposal that the revision be published as a Complete Revision.

## **.5 Other Resolutions Changes**

None

## **.6 Dates:**

Original Proposal: October 2013 by EG/M&W

Panel Approval: 14 December 2015 (Ref: EG task No. EMW1205)

GPG Approval: 1 March 2015 (Ref: 13202\_IGj)

- **Rev.2 (May 2004)**

No records available

- **Rev.1 (1994)**

No records available

- **New (1984)**

No records available

## Part B. Technical Background

List of Technical Background (TB) documents for UR W16:

Annex 1. **TB for Rev.2 (May 2004)**

See separate TB document in Annex 1.



Annex 2. **TB for Rev.3 (Mar 2016)**

See separate TB document in Annex 2.



**Note:** *There are no Technical Background (TB) documents available for New (1984) and Rev.1 (1994).*



## High Strength Quenched and Tempered Steels for Welded Structures

- a) Objective/Scope  
The objective was to rationalize all UR Ws procedures on mechanical testing by reference to the new UR W2 (Rev.2, 2003).
- b) Source of Proposed Requirements  
The revised draft UR was developed referring to the existing requirements of the UR W16 “High Strength Quenched and Tempered Steels for Welded Structures” and the UR W2 “Test specimens and mechanical testing procedures for materials”.
- c) Points of Discussion  
Nil.

\* \* \* \* \*

## **Technical Background (TB) document for UR W16 (Rev.3 Mar 2016)**

### **1. Scope and objectives**

A thorough amendment of IACS UR W16 was urgently needed to keep the UR updated with the development of manufacturing technology of high strength steels; and latest international standards and codes for the manufacturing of these high strength steels. The definitions and requirements in the current W16 have not kept up with changes in industry standards and were considered inappropriate by industry.

The objectives of the amendment were:

- 1) Develop a unified approach for the approval of manufacturers of high strength steel carried out by each Classification Society.
- 2) Unify the requirements for the material properties, the delivered conditions and inspection of high strength steels in order to meet the increasing demand from the industry. There are material standards, such as ASTM, EN, ISO and other numerous national and/international standards having been developed for high strength grades.
- 3) Incorporation of steels with yield strength higher than 690 based on these grades having been applied in certain parts of structures by offshore and marine industries.

### **2. Engineering background for technical basis and rationale**

Regarding the scope of steel manufacturing, the requirements apply to hot-rolled, fine-grain, weldable high strength structural steels, specified in yield strength levels of 420, 460, 500, 550, 620, 690, 890 and 960 N/mm<sup>2</sup>, delivered in Normalized (N)/Normalised rolled (NR); Thermo-mechanical controlled rolled (TM) or Quenched and Tempered (QT) condition. Product forms include plates, wide flats, sections, bars and seamless tubulars.

Regarding the scope of application, the steels are intended for use in marine and offshore structural applications, and are not intended for ship hull structure.

Within the scope mentioned above, the requirements specifically on the manufacturing process, chemical and mechanical properties, sampling and test frequency, surface and internal soundness, inspection for both production test and initial manufacturer approval have been updated based on the latest international standards, as listed in Para 3. "Source/derivation of the proposed IACS resolution".

The revised W16 (Rev. 3) has now the unified requirements on the high strength steels to meet the needs of marine, offshore and steelmaking industries.

### **3. Source/derivation of the proposed IACS Resolution**

Marine, offshore and steelmaking industries use the international material standards for structural steels such as:

- ISO 630-3 - Part 3 Technical delivery conditions for fine – grain structural steels
- ISO 630-4 - Part 4 Technical delivery condition for high-yield-strength quenched and tempered structural steel plates

- EN 10025-3 - part 3 technical delivery conditions for normalized rolled weldable fine grain structural steels
- EN 10025-4 - part 4 technical delivery conditions for thermomechanical rolled weldable fine grain structural steels
- EN 10025-6 - part 6 technical delivery conditions for flat products of high yield strength structural steels
- EN 10225 Weldable structural steels for fixed offshore structures - Technical delivery conditions
- EN 10210-1 Hot finished structural hollow sections of non-alloy and fine grain structural steels – Part 1: Technical delivery requirements
- EN 10297-1 Seamless steel tubes for mechanical and general engineering purposes – Technical delivery conditions - part 1: Non-alloy and alloy steel tubes

The applicability of the abovementioned standards was investigated and agreed by the EG M&W group for the reference and suitability for the general marine and offshore applications.

#### **4. Summary of Changes intended for the revised Resolution:**

This is a full revision of the UR, and introduces the following major changes that reflect advances in steelmaking technology and quality assurance in steel product testing and in manufacturing process approval, in particular the elements of relevant international standards for weldable structural steels.

- Scope of application and product form
- Steelmaking and heat treatment process
- Chemical composition / Carbon equivalent specifications
- Mechanical properties testing: Tensile test and Charpy impact toughness test and acceptance criteria
- Inspection test procedure
- Surface quality
- Internal soundness
- Appendix A for procedure of approval of manufacturers

#### **5. Points of discussions or possible discussions**

All the revisions or additions have been discussed by the Group by correspondence or during the EG MW meetings and reached a final agreement.

#### **6. Attachments if any**

N/A.

## UR W17 “Approval of consumables for welding normal and higher strength hull structural steels”

### Summary

Review and update industry standards format according to GPG instructions

### Part A. Revision History

Version no.	Approval date	Implementation date when applicable
Rev.6 (Sep 2021)	21 September 2021	1 January 2023
Rev.5 (Mar 2018)	19 March 2018	1 July 2019
Rev.4 (Jan 2016)	15 January 2016	1 July 2017
Rev.3 (June 2005)	27 June 2005	-
Rev.2 (May 2004)	24 May 2004	-
Rev.1 (1993)	1993	-
New (1986)	1986	-

#### • Rev.6 (Sep 2021)

##### 1 Origin of Change:

- Suggestion by IACS member

##### 2 Main Reason for Change:

To update industry standards format according to GPG instructions given in GPG Vice-chair message 19000\_IRC.

##### 3 List of non-IACS Member classification societies contributing through the TC Forum and/or participating in IACS Working Group:

None.

##### 4 History of Decisions Made:

Original proposal was made according to GPG Vice-chair message 19000\_IRC. Proposal to revise the IACS URs and RECs only to refer to a dated version of the industry standard as per GPG instructions was made at IACS EG/MW meeting in September 2019. Three drafts have been discussed by the group.

##### 5 Other Resolutions Changes:

None.

##### 6 Any hinderance to MASS, including any other new technologies:

None.

## **7 Dates:**

Original Proposal : April 2019 (Made by: GPG)  
EG M&W Approval : July 2021  
GPG Approval : 21 September 2021 (Ref: 19000\_IGq)

### **• Rev.5 (Mar 2018)**

#### **.1 Origin for Change:**

- Alignment and consistency with UR W16.

#### **.2 Main Reason for Change:**

In order to keep consistency UR W17 needed to be aligned with UR W16 changes. The opportunity has also been taken to include grade 5Y40 based on the demands of industry and the need for consistent approval acceptance criteria across Societies, as it was not originally tasked in the FORM A.

#### **.3 List of non-IACS Member Classification Societies contributing through the TC Forum and/or participating in IACS Working Group:**

None

#### **.4 History of Decisions Made:**

None

#### **.5 Other Resolutions Changes**

None

#### **.6 Dates:**

Original Proposal: September 2016  
Panel Approval: 27 February 2018 (Ref: EMW1606)  
GPG Approval: 19 March 2018 (Ref: 16172bIGb)

### **• Rev.4 (Jan 2016)**

#### **.1 Origin for Change:**

- Suggestion by IACS member

#### **.2 Main Reason for Change:**

In the existing UR W17, the mercury method is the only test method for determining hydrogen content of welding consumables with H5 rating. However, due to

environmental factors, the mercury method has been severely restricted. Some new acceptable methods are to be added to replace the mercury method.

**.3 List of non-IACS Member Classification Societies contributing through the TC Forum and/or participating in IACS Working Group:**

None

**.4 History of Decisions Made:**

See separate TB document in Annex 3 for details.

**.5 Other Resolutions Changes**

None

**.6 Dates:**

Original Proposal: July 2014 made by an IACS Member  
Panel Approval: November 2015 (Ref: Task EMW 1406)  
GPG Approval: 15 January 2016 (Ref: 14168\_IGd)

• **Rev.3 (June 2005)**

No records available

• **Rev.2 (May 2004)**

No records available

• **Rev.1 (1993)**

No records available

• **New (1986)**

No records available

## **Part B. Technical Background**

List of Technical Background (TB) documents for UR W17:

Annex 1. **TB for Rev.2 (May 2004)**

See separate TB document in Annex 1.

Annex 2. **TB for Rev.3 (June 2005)**

See separate TB document in Annex 2.

Annex 3. **TB for Rev.4 (Jan 2016)**

See separate TB document in Annex 3.

Annex 4. **TB for Rev.5 (Mar 2018)**

See separate TB document in Annex 4.

Annex 5. **TB for Rev.6 (Sep 2021)**

See separate TB document in Annex 5.

**Note:** *There are no Technical Background (TB) documents available for New (1986) and Rev.1 (1993).*

IACS Unified Requirement W17 (Rev.2)  
Technical Background

**Approval of consumables for welding normal and higher strength hull structural steels**

- a) Objective/Scope  
The objective was to rationalize all UR Ws procedures on mechanical testing by reference to the new UR W2 (Rev.2, 2003).
- b) Source of Proposed Requirements  
The revised draft UR was developed referring to the existing requirements of the UR W17 “Approval of consumables for welding normal and higher strength hull structural steels” and the UR W2 “Test specimens and mechanical testing procedures for materials”.
- c) Points of Discussion  
Nil.

\* \* \* \* \*



**Technical Background Document  
UR W17 (Rev.3 June 2005)**

**Approval of consumables for welding normal and higher strength hull structural steels**

**a) Objective/Scope**

The objective was to amend requirements of welding consumables for YP40 steels with a view to being consistent requirements for welding joints.

**b) Source of Proposed Requirements**

The revised draft UR was developed referring to the existing requirements of the UR W17 "Approval of consumables for welding normal and higher strength hull structural steels" and UR W11 "Normal and higher strength hull structural steels".

**c) Points of Discussion**

The discussion on the following technical points for the above a) objective/Scope had been made and achieved full agreement of the members:

Required energy for impact tests;

Required energy for impact tests on welding consumables for YP40 steels is to be amended based on those of steels in UR W11(Rev.6).

Typeset errors;

Several typeset errors found during consideration are to be rectified.

Submitted by WP/MW Chair  
28/12/2004

## **Technical Background (TB) document for UR W17 (Rev.4 Jan 2016)**

### **1. Scope and objectives**

The objective is to introduce the measuring hydrogen content methods for the deposited metal of welding consumables, which is adopted in ISO 3690:2012.

### **2. Engineering background for technical basis and rationale**

In the existing UR W17 , the mercury method is the only method allowed for measuring hydrogen content of welding consumables with hydrogen content less than 5ml/100g. However, due to environmental factors, the mercury method has been severely restricted. In order to meet the need for measuring hydrogen content of welding consumables, thermal conductivity detector method listed in ISO 3690:2012 is introduced into UR W17.

### **3. Source/derivation of the proposed IACS Resolution**

The revised draft UR was developed from the existing IACS UR W17 "Approval of consumables for welding normal and higher strength hull structural steels", and referring to ISO 3690 "Welding and allied processes — Determination of hydrogen content in arc weld metal".

CCS: Comparative tests between mercury method and thermal conductivity detector method.

NK: Effect of diffusible-hydrogen measurement conditions per ISO 3690:2012 (three parts).

### **4. Summary of Changes intended for the revised Resolution:**

The thermal conductivity detector methods specified in ISO 3690:2012 are introduced into UR W17. The typical test conditions for gas chromatography method and prerequisite conditions for the application of hot carrier gas extraction method are specified in UR W17.

### **5. Points of discussions or possible discussions**

The group discussed the test temperature and minimum holding time of the hot carrier gas extraction method.

Some test data showed that differences exist in the results obtained from the test by hot carrier gas extraction method in accordance with ISO standard in different laboratories. It was considered that there may be some uncertainty in instrument calibration methods and the test procedures for this method. It was agreed to introduce requirements to check the testing procedure for this method.

### **6. Attachments if any**

N/A.

## **Technical Background (TB) document for UR W17 (Rev.5 Mar 2018)**

### **1. Scope and objectives**

The initial task was to align this UR with the changes from UR W16, Rev. 3, which were revised in March 2016, as requested by IACS GPG.

Eventually, the EGMW group considered it was necessary to incorporate the consumable grade of 5Y40 in the current revision.

### **2. Engineering background for technical basis and rationale**

UR W17 specifies the normal and higher strength grade consumables, and that the high strength grade consumables for steels covered in UR W16 were to be incorporated into UR W23. The revision for consistency with W16 was minor in nature. Further, the adoption of grade 5Y40 was considered of necessity, based on that EG MW's remark that Class Societies have received requests from the industries for type approval of this grade 5Y40. This grade may be used in offshore cases where FH40 grade is used.

### **3. Source/derivation of the proposed IACS Resolution**

Grade 5Y40 was introduced with the mechanical properties in consistency with the existing 1,2,3 and 4Y40, apart from the Charpy V-notch test temperature of -60°C which is in line with 5Y grade. The specifications of Grade 5Y40 consumable is in line with current industrial practice.

### **4. Summary of Changes intended for the revised Resolution:**

New grade of 5Y40 consumable was introduced into the Rev. 5.

### **5. Points of discussions or possible discussions**

The group discussed on the necessity and the specification of 5Y40 introduced.

### **6. Attachments if any**

N/A.

**Technical Background (TB) document for UR W17 (Rev.6 Sep 2021)**

**1. Scope and objectives**

Review and update industry standards format according to GPG instructions.

**2. Engineering background for technical basis and rationale**

N.A.

**3. Source/derivation of the proposed IACS Resolution**

ISO 3690:2018

**4. Summary of Changes intended for the revised Resolution:**

Industry standards format has been updated according to GPG instructions.

**5. Points of discussions or possible discussions**

None.

**6. Attachments if any**

None.

## **UR W18 “Anchor chain cables and accessories including chafing chain for emergency towing arrangements”**

### **Summary**

Review and update industry standards format according to GPG instructions

### **Part A. Revision History**

<b>Version no.</b>	<b>Approval date</b>	<b>Implementation date when applicable</b>
Rev.6 (Sep 2021)	21 September 2021	1 January 2023
Rev.5 (May 2004)	May 2004	-
Rev.4 (July 2003)	July 2003	-
Rev.3 (July 2002)	July 2002	-
Rev.2 (July 1999)	July 1999	-
Rev.1 1997	1997	-
New 1988	1988	-

#### **• Rev. 6 (Sep 2021)**

##### **1 Origin of Change:**

- Suggestion by IACS member

##### **2 Main Reason for Change:**

To update industry standards format according to GPG instructions given in GPG Vice-chair message 19000\_IRC.

##### **3 List of non-IACS Member classification societies contributing through the TC Forum and/or participating in IACS Working Group:**

None.

##### **4 History of Decisions Made:**

Original proposal was made according to GPG Vice-chair message 19000\_IRC. Proposal to revise the IACS URs and RECs only to refer to a dated version of the industry standard as per GPG instructions was made at IACS EG/MW meeting in September 2019. Three drafts have been discussed by the group.

##### **5 Other Resolutions Changes:**

None.

**6 Any hinderance to MASS, including any other new technologies:**

None.

**7 Dates:**

Original Proposal : April 2019 (Made by: GPG)  
EG M&W Approval : July 2021  
GPG Approval : 21 September 2021 (Ref: 19000\_IGq)

- **Rev. 5 (May 2003)**

No records available.

- **Rev.4 (July 2003)**

No records available.

- **Rev.3 (July 2002)**

No records available.

- **Rev.2 (July 1999)**

No records available.

- **Rev.1 (1997)**

No records available.

- **New 1988**

No records available.

\*\*\*\*\*

## **Part B. Technical Background**

List of Technical Background (TB) documents for UR W18:

Annex 1. **TB for Rev.2 (July 1999)**

See separate TB document in Annex 1.

Annex 2. **TB for Rev.3 (July 2002)**

See separate TB document in Annex 2.

Annex 3. **TB for Rev.4 (July 2003)**

See separate TB document in Annex 3.

Annex 4. **TB for Rev.5 (May 2004)**

See separate TB document in Annex 4.

Annex 5. **TB for Rev.6 (Sep 2021)**

See separate TB document in Annex 5.

**Note:** *There are no Technical Background (TB) documents available for New (1988) and Rev.1 (1997).*

IACS UR W18 (Rev.2)  
**Anchor Chain Cables and Accessories**

**Technical Backgrounds**

a) **Objective / Scope**

The objective was to revise the requirement on the break load test for chain accessories specified in the Unified Requirement for anchor chain cables and accessories. The existing UR W18 requires that the chain accessories, which are break load tested, have to be scrapped except in certain condition. This condition has been re-considered in this revision.

b) **Source of Proposed Requirements**

This revised draft UR was elaborated referring to the existing UR W18 "Anchor Chain Cables and Accessories" and UR A1 "Requirements concerning Mooring and Anchoring" (Rev.4, 1994).

c) **Points of Discussion**

The discussions had been held mainly upon the following point of view and achieved full agreement in the AHG/MW :

Conditions on the chain accessories which are break load tested to be put to further use ;

To prevent plastic deformation resulted from the break load test, the existing UR W18 requires only to use the material with the higher grade. In addition to that, as a result of re-consideration, the increased dimensions also have been introduced as a condition on further use in service.

△△



## Technical Background

### IACS Unified Requirement W18 (Rev.3)

#### Anchor chain cables and accessories

##### Technical Backgrounds:

**a) Objective/Scope**

The objectives was to revise the existing UR W18 from the viewpoint of the consistency between the requirements and current techniques.

**b) Source of Proposed Requirements**

This revised draft UR was developed referring to the existing requirements of UR W18 “Anchor chain cables and accessories” (Rev.2).

**c) Points of Discussion**

The discussion on the following technical points had been made and achieved full agreement of the members:

**I. For rolled steel bars for chain cables**

Chemical composition;

Chemical composition for Grade 3 steel bar is not specified. Material suppliers or chain cable manufacturers are to submit the specification for approval.

Mechanical test;

Mechanical test is to be normally carried out by the steel mill.

Retest;

Where a retest for tensile test or Charpy V-notch impact test fails to meet requirements, the test unit represented is to be rejected.

**II. For chain cables and accessories**

Heat treatment;

“Normalized and tempered” is newly added as heat treatment for chain cables and accessories.

Breaking load test;

Each manufacturing batch for the test is to be comprised of accessories which are same accessory type, grade, size and heat treatment charge. But it is not necessarily representative of each heat of steel or individual purchase order.

Mechanical tests;

For Grade 2 forged or cast chain cables, Charpy V-notch impact test is not needed. However, for Grade 2 forged and cast accessories, the test is to be required.

\* \* \* \*

submitted by WP/MCH to GPG 52, 12-15 March 2002

IACS Unified Requirement W18 (Rev.4)

## **Anchor chain cables and accessories**

### **Technical Backgrounds:**

**a) Objective/Scope**

The objective was to develop the requirements for the manufacture and certification of chain cables and their accessories for ETA equipment.

**b) Source of Proposed Requirements**

The requirements in the revised draft UR were developed referring to the IMO Resolution MSC35(63) and the corresponding specifications of individual Societies Rule.

**c) Points of Discussion**

The discussion on the following technical points had been made and achieved full agreement of the members:

General;

The requirements for chafing chains used in ETA were specified as an Appendix of UR W18 “Anchor chain cables and accessories”.

Grade of chains;

The chains are to be Grade 2 and 3 chain cables in the UR W18. The minimum size of common link and breaking load for test are to be specified in accordance with the IMO Resolution MSC35(63) and the members’ specifications.

Design, manufacture, testing and certification;

The chains are to be designed, manufactured, tested and certified in accordance with the corresponding requirements of the UR W18.

Chafing chain end onboard;

Typical arrangement of the chain end was developed referring to on members’ practices. A pear-shaped open link is to be considered so that it allows connection to a shackle corresponding to the type of ETA and chain grade.

\* \* \* \* \*

IACS Unified Requirement W18 (Rev.5)  
Technical Background

**Anchor chain cables and accessories including chafing chain for emergency towing arrangements**

- a) Objective/Scope  
The objective was to rationalize all UR Ws procedures on mechanical testing by reference to the new UR W2 (Rev.2, 2003).
  
- b) Source of Proposed Requirements  
The revised draft UR was developed referring to the existing requirements of the UR W18 “Anchor chain cables and accessories including chafing chain for emergency towing arrangements” and the UR W2 “Test specimens and mechanical testing procedures for materials”.
  
- c) Points of Discussion  
Nil.

\* \* \* \* \*

**Technical Background (TB) document for UR W18 (Rev.6 Sep 2021)**

**1. Scope and objectives**

Review and update industry standards format according to GPG instructions.

**2. Engineering background for technical basis and rationale**

N.A.

**3. Source/derivation of the proposed IACS Resolution**

ISO 1704:2008

**4. Summary of Changes intended for the revised Resolution:**

Industry standards format has been updated according to GPG instructions.

**5. Points of discussions or possible discussions**

None.

**6. Attachments if any**

None.

## UR W22 “Offshore Mooring Chain”

### Part A. Revision History

Version no.	Approval date	Implementation date when applicable
Rev.6 (June 2016)	2 June 2016	1 July 2017
Corr.1 (June 2011)	4 June 2011	-
Rev.5 (Dec 2009)	1 December 2009	1 July 2011
Rev.4 (Sept 2006)	24 September 2006	-
Rev.3 (May 2004)	24 May 2004	-
Rev.2 (July 1999)	28 July 1999	-
Rev.1 (1997)	14 February 1997	-
NEW (1993)	<i>No record</i>	-

- **Rev.6 (June 2016)**

**.1 Origin for Change:**

- Suggestion by IACS member

**.2 Main Reason for Change:**

To update and add requirements for mooring chain.

**.3 List of non-IACS Member Classification Societies contributing through the TC Forum and/or participating in IACS Working Group:**

None

**.4 History of Decisions Made:**

See Form A for task EMW 1313, minutes of EG MW meetings in 2013, 2014, 2015 and technical background.

**.5 Other Resolutions Changes**

None

**.6 Dates:**

Original Proposal: 10 December 2013 by EG/M&W

Panel Approval: 29 December 2015 (Ref: Task EMW 1313)

GPG Approval: 2 June 2016 (Ref: 16057\_IGd)

- **Rev.5 Corr.1 (June 2011)**

**.1 Origin for Change:**

- Suggestion by a non-IACS entity (PRS) and PermSec

**.2 Main Reason for Change:**

To correct the typos in the paragraph numbering (3.2.7 & 3.2.8) and the reference to the figure 3 in 3.2.7.2.

**.3 List of non-IACS Member classification societies contributing through the TC Forum and/or participating in IACS Working Group:**

None

**.4 History of Decisions Made:**

PRS pointed out the wrong reference to the figure 3 in Para 3.2.7.2 and PermSec found some other editorial corrections required in paragraph numbering (3.2.7 & 3.2.8). PermSec made the corrections and Hull Panel approved it. As the corrections were purely editorial, no technical background document was prepared.

**.5 Other Resolutions Changes**

None

**.6 Dates:**

Original proposal: *19 April 2011 Made by: PRS/PermSec*

Panel Approval: *23 May 2011 by: Hull Panel*

GPG Approval: *4 June 2011 (Ref. 11077\_IGb)*

**• Rev.5 (Dec 2009)**

**.1 Origin for Change:**

Suggestion by IACS member

**.2 Main Reason for Change:**

To develop the requirements for higher strength mooring chains in Grade R5 and also studless mooring chains.

**.3 History of Decisions Made:**

The old IACS WP/MW was aware of industrial need for higher strength offshore mooring chains other than those specified in the present the existing UR W22 and also a requirement for studless offshore mooring chains. WP/WM raised the Form A but the work was not initiated before reorganisation of the old IACS working groups. The work item was taken over by Hull Panel as their Task 27 and allocated to Project Team 2 under the chair of LR, the working document was drafted by ABS.

Following a period required to discuss issues with manufacturers, analysis of issues raised by Authorities and collation of supporting technical information, the project

team found common ground on the procedures to be followed. Fracture toughness testing, for example CTOD testing, has been a requirement in UR W22 for initial approval tests of chain manufacturers since original adoption. Acceptance values have now been included in the UR and are extended to initial approval tests of the forges and foundries for accessories. These values, established through design and operational experience, are considered to give sufficient resistance against unstable fracture in general. As CTOD values can be related to design issues, other values may be considered for specific cases of specific projects. Specifying these acceptance levels in the UR enables the manufacturer to establish Charpy impact toughness and fracture toughness relationships based on the increase in strength and thickness seen in this amendment. This allows the continued use of the Charpy V-notch impact test as the measurement of toughness during quality control release testing of the product.

#### **.4 Other Resolutions Changes**

None

#### **.5 Dates:**

Original Proposal: *2004, made by WP/MW Task No.57*  
Hull Panel Approval: *7 October 2009*  
GPG Approval: *1 December 2009 (ref. 9635\_IGe)*

- **Rev.4 (Sept 2006)**

See TB in Part B, Annex 3.

- **Rev.3 (May 2004)**

See TB in Part B, Annex 2.

- **Rev.2 (July 1999)**

See TB in Part B, Annex 1.

- **Rev.1 (1997)**

No TB document available.

- **NEW (1993)**

No TB document available.

## Part B. Technical Background

List of Technical Background (TB) documents for UR W22:

Annex 1. **TB for Rev.2 (July 1999)**

See separate TB document in Annex 1.



Annex 2. **TB for Rev.3 (May 2004)**

See separate TB document in Annex 2.



Annex 3. **TB for Rev.4 (Sept 2006)**

See separate TB document in Annex 3.



Annex 4. **TB for Rev.5 (Dec 2009)**

See separate TB document in Annex 4.



Annex 5. **TB for Rev.6 (June 2016)**

See separate TB document in Annex 5.



**Note:** *There are no Technical Background (TB) documents available for New (1993), Rev.1 (1997) and Rev.5 (Corr. 1, June 2011).*



**IACS UR W22 (Rev.2)**  
**Offshore Mooring Chain**

**Technical Backgrounds**

**a) Objective / Scope**

The objective was to revise the requirement on the break load test for chain accessories specified in the Unified Requirement for offshore mooring chains. The existing UR W22 requires that the chain accessories, which are break load tested, have to be scrapped, however, the revised one allows them to be put to further use in case they satisfy the certain conditions.

**b) Source of Proposed Requirements**

This revised draft UR was elaborated referring to the existing UR W22 "Offshore Mooring Chain", the existing/ revised UR W18 "Anchor Chain Cables and Accessories" and UR A1 "Requirements concerning Mooring and Anchoring" (Rev.4, 1994).

**c) Points of Discussion**

The discussions had been held mainly upon the following point of view and achieved full agreement in the AHG/MW :

Conditions for the chain accessories which are break load tested to be put to further use :

To prevent plastic deformation resulted from the break load test, the conditions on materials grade and dimensions of chain accessories were developed. These conditions are the same as ones specified in the proposed UR W18 (Rev.2).

△△

**IACS Unified Requirement W22 (Rev.3)  
Technical Background**

**Offshore mooring chain**

**a) Objective/Scope**

The objective was to rationalize all UR Ws procedures on mechanical testing by reference to the new UR W2 (Rev.2, 2003).

**b) Source of Proposed Requirements**

The revised draft UR was developed referring to the existing requirements of the UR W22 “Offshore mooring chain” and the UR W2 “Test specimens and mechanical testing procedures for materials”.

**c) Points of Discussion**

Nil.

\* \* \* \* \*

**Technical Background of UR W22 (Rev.4)**  
**Appendix A: Chafing Chain for Single Point Mooring Arrangements**

**1. Scope and objective**

OCIMF has requested IACS by their email of 7 June 2006 to consider some exemptions in application of IACS UR W22 for manufacturing of short lengths of chafe chains for conventional tanker's single point moorings. IACS GPG Chairman tasked Hull Panel to consider OCIMF's request/proposal and if supportive, whether UR W22 needs to be amended to acknowledge/address the OCIMF Guidelines in his message 6114\_IGa, dated 13 June 2006. Consequently, Hull Panel unanimously agreed to develop an Appendix to IACS UR W22, which specifies the requirements for chafe chains for single point mooring arrangements and incorporates the concerns that OCIMF has in manufacturing the chains.

**2. Points of discussions or possible discussions**

The following OCIMF's concerns are considered in development of the Appendix:

- .1 *Comments:* W22.1.5.1 can be waived due to the requirement for small quantities of bar stock. Such materials should be subject to full chemical and mechanical testing to prove grade compatibility and 100% Non Destructively Tested (NDT) before release into production. The material should meet or exceed the requirements of W22 Table 1 and comply with 1.5.2  
*Proposals:* A.2 specifies the materials of the chafe chain are to satisfy the requirements of materials as required by W22.2. The approval of the manufacturer by the society is no longer a condition of approval of chafe chain product.
  
- .2 *Comments:* The OCIMF recommended chafe chain configurations including the oblong plate and pick up shackle component should be accepted. Individual links should comply with the dimension tolerances specified in W22 3.7.  
*Proposals:* A.4.2 specifies that the arrangements of the end connections are to be in accordance with the recognized standards, such as OCIMF. A4.1 covers the dimensional tolerances of individual links by referring to W22.3.
  
- .3 *Comments:* Batch heat treatment will be accepted as an alternative to linear heat treatment.  
*Proposals:* The acceptance of batch heat treatment is specified in A4.1.
  
- .4 *Comments:* Break load testing of 3 link samples can be waived on provision that the manufacturer can provide documented evidence that for each size of bar stock used to manufacture the chafe chain, that the break load tests were satisfactorily performed on a sample from the same bar stock of raw material.  
*Proposals:* The statement of waiver of the break load tests is provided in Note 1 of the Appendix.

.5 *Comments:* Break load testing of chafe chain accessories including oblong plate and 42 tonnes shackle can be waived on the provision that the manufacturer can demonstrate that a destructive test of the same size and grade accessory has been performed in the last 6 months.

*Proposals:* Same proposal as above 2.4. The statement of waiver of the break load tests is provided in Note 1 of the Appendix.

.6 *Comments:* Note: In accordance with W22 sections 4.5 and 5.5, chafe chains, including accessories should be shot blasted and 100% Non Destructively Tested (NDT) for cracks and deformation after proof load testing and prior to coating.

*Proposals:* These are the condition of acceptance of the materials. A4.1

.7 Other specific concerns are provided in A.1, A.4.3, A.4.4, and A.4.5.

### **3. Source/ derivation of proposed requirement**

OCIMF

### **4. Decision by voting**

N.A.

Submitted by the Hull Panel

1 September 2006

### **Permanent Secretariat note (29 September 2006):**

GPG discussion led to a number of changes being made to the draft text:

- ABS proposed that a reference should be made to the new Appendix from the main text of W22.
- LR requested that the reference to specific industry standards be removed in paragraph 4.2 since they did not recall this being normal practice for IACS URs.
- LR also proposed that Note 1 in the Appendix be amended to better clarify the requirement.

These changes were agreed by members together with a minor typographical amendment in para 1 of the Appendix.

CCS made a proposal to replace the time-based Note with a quantity-based one, but this proposal did not gain support from the other members.

GPG and Council agreement was reached on 24 September 2006.

## **Technical Background (TB) document**

**UR W22, Rev.5 (December 2009)**  
*[Hull Panel Task 27]*

### **1. Scope and objectives**

To develop the requirements for higher strength mooring chains in Grade R5 and also studless mooring chains.

### **2. Engineering background for technical basis and rationale**

The old IACS WP/MW was aware of industrial need for higher strength offshore mooring chains other than those specified in the present the existing UR W22 and also a requirement for studless offshore mooring chains. WP/WM raised the Form A but the work was not initiated before reorganisation of the old IACS working groups. The work item was taken over by Hull Panel as their Task 27 and allocated to Project Team 2.

### **3. Source/derivation of the proposed IACS Resolution**

Following a period required to discuss issues with manufacturers, analysis of issues raised by Authorities and collation of supporting technical information, the project team found common ground on the procedures to be followed.

### **4. Summary of Changes intended for the revised Resolution:**

Fracture toughness testing, for example CTOD testing, has been a requirement in UR W22 for initial approval tests of chain manufacturers since original adoption.

Acceptance values have now been included in the UR and are extended to initial approval tests of the forges and foundries for accessories. These values, established through design and operational experience, are considered to give sufficient resistance against unstable fracture in general. As CTOD values can be related to design issues, other values may be considered for specific cases of specific projects. Specifying these acceptance levels in the UR enables the manufacturer to establish Charpy impact toughness and fracture toughness relationships based on the increase in strength and thickness seen in this amendment. This allows the continued use of the Charpy Vnotch impact test as the measurement of toughness during quality control release testing of the product.

### **5. Points of discussions or possible discussions**

A number of points were raised on the final draft submitted. These were valid points and amendments were made. The CTOD acceptance values for accessories were deleted based on ongoing experience, clarifications made to the numbers and location of CTOD specimens and the inclusions of a test location diagram. Furnace calibration procedures were also amended.

### **6. Attachments if any**

No attachment.

## **Technical Background (TB) document for UR W22 (Rev.6 June 2016)**

### **1. Scope and objectives**

The objective is to revise the requirements for offshore mooring chain and accessories in order to update them and to add requirements based on industry feedback where found appropriate.

### **2. Engineering background for technical basis and rationale**

Experience feedback and various joint industry projects (JIPs) showed that there were issues arising with offshore mooring chain quality, manufacturing practices and design requirements. The EG MW considered that the UR W22 needed to be reviewed for a global update and for developing additional requirements about key points of the manufacturing process for chain cables and mooring accessories.

### **3. Source/derivation of the proposed IACS Resolution**

The revised draft UR was developed from the existing IACS UR W22 "Offshore Mooring Chain".

### **4. Summary of Changes intended for the revised Resolution:**

The scope of the UR has been revised to add "subsea connectors". The documentation to be submitted to the Classification Society for approval has been revised to request additional information about manufacturing procedures. Requirements have been added to the manufacturing approval conditions for heat treatment furnaces and processes for chain and accessories. Additional details have been defined for CTOD testing conditions. Additional requirements for approval, manufacturing and testing of forged and cast accessories have been incorporated. Additional requirements for non-destructive examination of chain cables, forged and cast accessories have been incorporated. Requirements for dimensions and dimensional tolerances of chain links have been further detailed. Various updates of referenced standards were done.

### **5. Points of discussions or possible discussions**

All the revisions or additions have been discussed by the Group by correspondence or during the EG MW meetings and reached a final agreement. The requirements about CTOD testing at manufacturing approval stage have been discussed in details, as well as the requirements for non-destructive examinations and those for forged accessories.

### **6. Attachments if any**

None.

## UR W23 “Approval of Welding Consumables for High Strength Steels for Welded Structures”

### Summary

Clarify that grades Y89 and Y96 may be subject to particular consideration on specific projects where design requirements permit undermatching weld joints.

### Part A. Revision History

Version no.	Approval date	Implementation date when applicable
Corr.1 (June 2019)	22 June 2019	-
Rev.2 (Apr 2018)	30 April 2018	01 July 2019
Rev.1 (1997)	No record	-
New (1995)	No record	-

#### • Corr.1 (June 2019)

##### 1 Origin of Change:

- Other (External query from European Welding Association (EWA))

##### 2 Main Reason for Change:

Clarify that grades Y89 and Y96 may be subject to particular consideration on specific projects where design requirements permit undermatching weld joints.

##### 3 List of non-IACS Member classification societies contributing through the TC Forum and/or participating in IACS Working Group:

None

##### 4 History of Decisions Made:

Add “For grade Y89 and Y96” to the fourth paragraph of article 1.2.4

##### 5 Other Resolutions Changes:

None

##### 6 Any hinderance to MASS, including any other new technologies:

None

##### 7 Dates:

Original Proposal: 25 April 2019 (Ref: 19084\_IAa)  
 Panel Approval: 12 June 2019 (Ref: 19084\_EMWb)  
 GPG Approval: 22 June 2019 (Ref: 19084\_IGf)

- **Rev.2 (Apr 2018)**

**.1 Origin for Change:**

- Alignment and consistency with UR W16.

**.2 Main Reason for Change:**

In order to keep consistency UR W23 needed to be aligned with UR W16 changes.

**.3 List of non-IACS Member Classification Societies contributing through the TC Forum and/or participating in IACS Working Group:**

None

**.4 History of Decisions Made:**

None

**.5 Other Resolutions Changes**

None

**.6 Dates:**

Original Proposal: September 2016

Panel Approval: by EG M&W on January 2018 (Ref: EMW1607)

GPG Approval: 30 April 2018 (Ref: 16172cIGd)

- **Rev.1 (1997)**

No records available

- **New (1995)**

No records available

\*\*\*\*\*



## Part B. Technical Background

List of Technical Background (TB) documents for UR W23:

Annex 1. **TB for Rev.2 (Apr 2018)**

See separate TB document in Annex 1.



**Note:** *There are no Technical Background (TB) documents available for New (1995), Rev.1 (1997) and Corr.1 (June 2019).*

## **Technical Background (TB) document for UR W23 (Rev.2 Apr 2018)**

### **1. Scope and objectives**

The task requested by IACS GPG was to align this UR with the changes from UR W16, Rev. 3, after it was revised in March 2016.

### **2. Engineering background for technical basis and rationale**

High strength grade consumables for steels covered in UR W16 were to be incorporated into UR W23. Therefore, two new consumable grades Y89 and Y96 have been introduced into this UR together with the associated requirements. Annual repeat test to confirm diffusible hydrogen content for grades Y69 to Y96 has been introduced in order to maintain regular checks of this parameter which has a critical importance in welded joints of base metal at this strength level due to their increased sensitivity to hydrogen induced cracking. Also, the standard values of tensile strength for the weld metal and welded joint have been revised as same as that of base metal specified in UR W16 Rev. 3. Furthermore, the adoption of undermatching condition was considered of necessary or high strength steels, based on Class Societies remarks.

The further revision for consistency with UR W16 was minor in nature.

### **3. Source/derivation of the proposed IACS Resolution**

The specified requirements for the two new consumables were based on base metal specifications, consumable manufacturer specifications and relevant international standards, where available.

The undermatching conditions were introduced in order to be in line with the industry practice for high strength steel applications.

### **4. Summary of Changes intended for the revised Resolution:**

Two new consumable grades were introduced.

New reference to undermatching conditions was introduced into Rev. 2

Requirement to repeat diffusible hydrogen test at annual frequency has been added for grades Y69 to Y96.

### **5. Points of discussions or possible discussions**

The EG/MW discussed on the necessity of adding reference to the undermatching conditions and also the future alignment of the bending angle across relevant UR's.

### **6. Attachments if any**

None.

## UR W24 – Cast Copper Alloy Propellers

### Summary

This UR provides requirements for the manufacture, inspection and repair procedures of cast copper alloy propellers, blades and bosses. This revision has the following technical change:

Paragraph 11.3: Repair of defects in zone A:

- the permissibility of a modified Zone A, is now deleted.

Opportunity was taken to carry out other minor edits and clarifications.

Updated the definitions of linear and non-linear indications to align with ISO 23277:2015

### Part A. Revision History

Version no.	Approval date	Implementation date when applicable
Rev.5 (Sep 2023)	11 September 2023	1 January 2025
Rev.4 (July 2020)	16 July 2020	1 July 2021
Corr.1 (Jan 2013)	17 Jan 2013	-
Rev.3 (May 2012)	11 May 2012	1 July 2013
Rev.2 (May 2004)	24 May 2004	-
Rev.1 (1997)	<i>No records</i>	-
NEW (1996)	<i>No records</i>	-

#### • Rev.5 (September 2023)

##### 1 Origin of Change:

- ✓ Suggestion by IACS member

##### 2 Main Reason for Change:

To revise paragraph 11.3 of UR W24 Rev.4 to exclude such a permissibility of a modified Zone A.

##### 3 List of non-IACS Member classification societies contributing or participating in IACS Working Group:

No contribution by non-IACS Member classification societies.

#### **4 History of Decisions Made:**

The previous (Rev.4) Resolution introduced the permissibility of modification of Zone A in case of repair by welding on an individual approach. However, the lack of criteria for the application of these modification and the inconsistency of the applied approach (with feedback from the IACS Machinery Panel) caused several IACS Members to have difficulties in implementing UR W24 Rev.4 in their Classification Rules.

Responding to statements of interest from a number of IACS members, EG/M&W decided that it is necessary to revise the above Unified Requirements to exclude this permissibility. Since there are no detailed requirements for the basis of a modified Zone A, it is left to the Classification Society to decide any technical basis for such a decision. Every effort should be made to rectify a discontinuity within Zone A without recourse to welding.

#### **5 Other Resolutions Changes:**

None.

#### **6 Any hinderance to MASS, including any other new technologies:**

None.

#### **7 Dates:**

Original Proposal	: 10 February 2022	(Made by: EG/M&W)
EG/M&W Approval	: 24 August 2023	(Ref: EMW2105_)
GPG Approval	: 11 September 2023	(Ref: 22023_IGf)

### **• Rev.4 (July 2020)**

#### **1 Origin of Change:**

Suggestion by an IACS member

#### **2 Main Reason for Change:**

Review and harmonize non-destructive testing requirements in URW24 and URW27.  
Review the repair welding requirements.

#### **3 List of non-IACS Member classification societies contributing or participating in IACS Working Group:**

No contribution by non-IACS Member classification societies.

#### **4 History of Decisions Made:**

Original proposal to revise IACS UR W24 and UR W27 for consistency of the definition of liquid penetrant indications and for evaluation of technical requirements was made

at IACS EG/MW meeting in September 2016. Four drafts have been discussed by the group.

Discussions took place about UR W24 article 11.3 & UR W27 article 11.5- repair of defects in Zone A. Members decided to reword these articles to introduce cases where propeller designer submit technical documentation to propose a modified Zone A.

Discussions took place about UR W24 Appendix A – article 5.2- base metal. Members decided to use the principles of ISO 15614-6 for base metal range approval.

Discussions took place about UR W24 Appendix A – Table 9 range of qualification for thickness. Members decided to keep a pragmatic approach as changing to the ISO would require requalification of current PQRs for repairs lower than 15mm thick.

## **5 Other Resolutions Changes:**

None

## **6 Any hinderance to MASS, including any other new technologies:**

None

## **7 Dates:**

Original Proposal: September 2016 Made by: EG M&W  
EG M&W Approval: 30 June 2020 (Ref: 18149\_EMWe)  
GPG Approval: 16 July 2020 (Ref: 18149\_IGh)

## **• Corr.1 (Jan 2013)**

### **1 Origin for Change:**

Request from the Industry (Pipavav Shipyard)

### **2 Main Reason for Change:**

To correct the definition of area "A" in Figure 3 as requested by the Industry. Figures 4, 5 and 6 were also improved by the Machinery Panel.

### **3 List of non-IACS Member classification societies contributing through the TC Forum and/or participating in IACS Working Group:**

None

### **4 History of Decisions Made:**

PermSec received the request for correction from the Industry (Pipavav Shipyard). Hull Panel reviewed the request and forwarded it to Machinery Panel with some additional suggestions for corrections. Machinery Panel carried out the corrections as requested. Figures 4, 5 and 6 were also improved by the Machinery Panel.

PermSec prepared a HF section to record this correction.

## 5 Other Resolutions Changes

None

## 6 Dates:

Original proposal: *19 May 2012 made by: Pipavav Shipyard*  
Panel Approval: *21 November 2012 by: Machinery Panel*  
GPG Approval: *17 January 2013 (Ref. 12057aIGb)*

### • Rev.3 (May 2012)

#### 1 Origin for Change:

- Suggestion by an IACS member

#### 2 Main Reason for Change:

To align Table 1 (Typical chemical compositions of cast copper alloys for propellers) with industry standards.

#### 3 List of non-IACS Member classification societies contributing through the TC Forum and/or participating in IACS Working Group:

None

#### 4 History of Decisions Made:

In the Hull Panel, proposals were submitted to amend Table 1 as follows:

- (a) Removal of the lower limit of Sn for CU1
- (b) Correction of maximum limit of Sn for CU2 from 0.15% to 1.5%.
- (c) Correction of maximum limit of Sn for CU3 from 0.1% to an undetermined percentage.

The Hull Panel agreed with the proposals for amending CU1 and CU2, but rejected the proposal to amend CU3. This decision was passed onto the Machinery Panel, which is responsible for this UR.

For Technical Background, see Annex 2.

## 5 Other Resolutions Changes

None

## 6 Dates:

Original proposal: *08 February 2012 made by: HP member*  
Panel Approval: *05 April 2012 by: Hull Panel*  
GPG Approval: *11 May 2012 (Ref. 12057\_IGc)*

- **Rev.2 (May 2004)**

Outcome of WP/MW Task 42. Reference: 3004a.  
See TB in Part B, Annex 1.

- **Rev.1 (1997)**

No records available.

- **New (1996)**

No records available.

\*\*\*\*\*

## Part B. Technical Background

List of Technical Background (TB) documents for UR W24:

Annex 1. **TB for Rev.2 (May 2004)**

See separate TB document in Annex 1.

Annex 2. **TB for Rev.3 (May 2012)**

See separate TB document in Annex 2.

Annex 3. **TB for Rev.4 (July 2020)**

See separate TB document in Annex 3.

Annex 4. **TB for Rev.5 (September 2023)**

See separate TB document in Annex 4.

**Note:** *There are no Technical Background (TB) documents available for the New (1996), Rev.1 (1997) and Corr.1 (Jan 2013).*



## **IACS Unified Requirement W24 (Rev.2) Technical Background**

### **Cast Copper Alloy Propellers**

#### **a) Objective/Scope**

The objective was to rationalize all UR Ws procedures on mechanical testing by reference to the new UR W2 (Rev.2, 2003).

#### **b) Source of Proposed Requirements**

The revised draft UR was developed referring to the existing requirements of the UR W24 "Cast Copper Alloy Propellers" and the UR W2 "Test specimens and mechanical testing procedures for materials".

#### **c) Points of Discussion**

Nil.

\* \* \* \* \*

## Technical Background for UR W24 Rev.3, May 2012

### 1. Scope and objectives

The objective was to align Table 1 (Typical chemical compositions of cast copper alloys for propellers) with industry standards.

### 2. Engineering background for technical basis and rationale

It was brought to the attention of the Hull Panel that the Sn limits for certain alloys in Table 1 of UR W24 were not in line with comparable/similar alloys specified in Industry Standards. Therefore, the Table 1 was amended to better align with these standards.

### 3. Source/derivation of the proposed IACS Resolution

- ASTM B584-2000
- BS1982-2008
- JIS H5120-2006
- GB 1178-1987

### 4. Summary of Changes intended for the revised Resolution:

- Lower limit of Sn for CU1 removed.
- Upper limit of Sn for CU2 corrected.

### 5. Points of discussions or possible discussions

#### Removal of the lower limit of Sn for CU1

- In many national standards, the Sn content of typical CU1 has no lower limit.
- Some reports show that tin is an enhancing element for corrosion resistance and strength of yellow brass, but the content of tin should not exceed 1.5% in brass. Some information shows that if the tin content is less than 0.25%, its anticorrosive effect will be non-apparent.
- Therefore, the proposal to remove the lower limit of Sn for CU1 was accepted.

#### Correction of upper limit of Sn for CU2

- Some information shows that if the tin content is less than 0.25%, its anticorrosive effect will be non-apparent.
- Therefore, the proposal to correct the upper limit of Sn for CU2 from 0.15% to 1.5% was accepted.

#### Correction of upper limit of Sn for CU3

- Based on the background of the correction to CU2, the proposal to correct CU3 was submitted.
- In general, Hull Panel Members were not aware of technical issues or problems raised by manufacturers and do not see a necessity for the change.
- Additionally, the proposal did not specify a new upper limit.
- Therefore, the proposal to correct the upper limit of Sn for CU3 was rejected.

### 6. Attachments if any

None

## **Technical Background (TB) document for UR W24 (Rev.4 July 2020)**

### **1. Scope and objectives**

The objectives were to review:

- the definition of severity zones with regards to current propeller design established by the marine industry.
- the status of sampling and testing requirements for mechanical properties.
- the repair welding requirements.

Review and harmonize non-destructive testing requirements in URW24 and URW27.

### **2. Engineering background for technical basis and rationale**

UR W24 "Cast copper alloy propellers" and UR W27 "Cast steel propellers" have been reviewed for consistency and for evaluation of technical requirements. It was noted that non-destructive testing requirements are to be harmonized between both URs. The conditions for the execution of welding repair procedure qualification must be revised with regards to the recognized standards and current foundries practice.

### **3. Source/derivation of the proposed IACS Resolution**

Existing Classification Societies Rules as well as international standard ISO 15614-6:2006 have been considered.

The UR refers to the following international standard:

ISO 3452-1:2013 "Non-destructive testing -- Penetrant testing -- Part 1: General principles".

### **4. Summary of Changes intended for the revised Resolution:**

The content of UR W24 has been fully reworked and revised with major changes summarised hereafter:

- Revised and update requirements for NDT,
- Revised and develop requirements for welding procedure qualification tests for repairs.

### **5. Points of discussions or possible discussions**

UR W24 article 11.3 & UR W27 article 11.5- repair of defects in Zone A: Requirement has been discussed and reworded to introduce cases where propeller designer submit technical documentation to propose a modified Zone A.

UR W24 12.3 - welding repair procedure: it was agreed to reword the text to say that the article is intended for repairs by arc welding.

UR W24 article 13.2- hot straightening: it was agreed to introduce a text to prevent hot straightening when weld repairs are in the concerned area.

UR W24 Appendix A – article 5.2- base metal: it was agreed to use the principles of ISO 15614-6 for base metal range approval.

UR W24 Appendix A – Table 9 range of qualification for thickness: it was agreed to keep a pragmatic approach as changing to the ISO would require requalification of current PQRs for repairs lower than 15mm thick.

**6. Attachments if any**

None.

\*\*\*

## **Technical Background for UR W24 (Rev.5 Sep 2023)**

### **1. Scope and objectives**

The objectives were to:

- either provide detailed requirements for the basis of a modified zone A, or;
- to exclude such permissibility of modifying the zone A

### **2. Engineering background for technical basis and rationale**

The lack of detailed criteria for the application of a modified zone A, and the inconsistency of the applied approach (upon discussions with the IACS Machinery Panel) caused several IACS Members to have difficulties in implementing UR W24 in their Classification Rules.

Responding to statements of interest from a number of IACS members, a decision was taken by EG/M&W that it was necessary to revise UR W24 to either detail the requirements for the permissibility of modification of Zone A (and agree the chosen approach with the Machinery Panel), or to exclude such a permissibility.

#### **2a. Specification of the data utilised in the development/revision of the proposed IACS Resolution, if any**

None

### **3. Source/derivation of the proposed IACS Resolution**

Existing Classification Societies Rules

IACS UR W24

IACS UR W27

ISO 23277:2015. Non-destructive testing of welds — Penetrant testing — Acceptance levels.

### **4. Summary of Changes intended for the revised Resolution:**

- Referring to paragraph 11.3: Repair of defects in zone A - it was unanimously agreed to exclude such a permissibility of a modified Zone A, and it is left to the member Society to decide the technical basis for such a decision. Therefore the text relating to this clause is deleted.
- Minor (non-technical) typographical/editorial changes were made to other paragraphs
- Updated the definitions of linear and non-linear indications to align with ISO 23277:2015

### **5. Points of discussions or possible discussions**

- Members unanimously agreed that it was not possible to specify detailed requirements within this UR as to how (or on what basis) a modified zone A could be achieved.
- IACS Machinery Panel were also consulted, and they agreed that no detailed requirements could be included in this UR for such a modified zone A
- It was noted amongst members that other paragraphs within the UR make some provision that upon special agreement with the Classification Society, weld repair may take place (it is left to the member Society to decide the technical basis for such a decision)
- It was further noted amongst members that the UR advises that effort should be made to consider other repair methods (e.g., blending or grinding, where possible) without resulting to welding, to rectify defects within zone A.

**6. Attachments if any**

None.

\*\*\*

## UR W25 “Aluminium Alloys for Hull Construction and Marine Structure”

### Summary

Review and update industry standards format according to GPG instructions

### Part A. Revision History

Version no.	Approval date	Implementation date when applicable
Rev.6 (Sep 2021)	21 September 2021	1 January 2023
Rev.5 (June 2014)	30 June 2014	1 July 2015
Rev.4 (Dec 2011)	02 Dec 2011	1 January 2013
Rev.3 (May 2006)	16 May 2006	-
Rev.2 (Dec 2004)	27 Dec 2004	-
Rev.1 (May 2004)	24 May 2004	-
NEW (May 1998)	28 May 1998	-

#### • Rev.6 (Sep 2021)

##### 1 Origin of Change:

- Suggestion by IACS member

##### 2 Main Reason for Change:

To update industry standards format according to GPG instructions given in GPG Vice-chair message 19000\_IRC.

##### 3 List of non-IACS Member classification societies contributing through the TC Forum and/or participating in IACS Working Group:

None.

##### 4 History of Decisions Made:

Original proposal was made according to GPG Vice-chair message 19000\_IRc. Proposal to revise the IACS URs and RECs only to refer to a dated version of the industry standard as per GPG instructions was made at IACS EG/MW meeting in September 2019. Three drafts have been discussed by the group.

##### 5 Other Resolutions Changes:

None.

## **6 Any hinderance to MASS, including any other new technologies:**

None.

### **7 Dates:**

Original Proposal : April 2019 (Made by: GPG)  
EG M&W Approval : July 2021  
GPG Approval : 21 September 2021 (Ref: 19000\_IGq)

## **• Rev.5 (June 2014)**

### **.1 Origin for Change:**

Suggestion by IACS EG/MW

### **.2 Main Reason for Change:**

To remove the requirement for the corrosion testing of aluminium temper conditions H111 and H112.

### **.3 List of non-IACS Member classification societies contributing through the TC Forum and/or participating in IACS Working Group:**

None

### **.4 History of Decisions Made:**

In November 2012, the IACS EG/MW agreed in their annual meeting that the corrosion testing of aluminium alloys listed in UR W25 for temper conditions H111 and H112 was not technically necessary.

For Technical Background, see Annex 5.

### **.5 Other Resolutions Changes**

None

### **.6 Dates:**

Original proposal: January 2014 Made by: EG/MW  
GPG Approval: 30 June 2014 (Ref. 13202bIGb)

## **• Rev.4 (Dec 2011)**

### **.1 Origin for Change:**

Suggestion by non-IACS entities (The Aluminum Association and European Aluminium Association)



## **.2 Main Reason for Change:**

- To add reference to ASTM standards for corrosion testing
- To add Temper H111 for Alloys 5083, 5383, 5059, 5086, and 5754 in Table 2
- To update UR W25 as necessary

## **.3 List of non-IACS Member classification societies contributing through the TC Forum and/or participating in IACS Working Group:**

None

## **.4 History of Decisions Made:**

- 1) Two separate requests were made to IACS by outside organizations to update or modify UR W25. These requests were taken into consideration by the Hull Panel and a proposal was developed.
- 2) In November 2010, The Aluminum Association requested a modification to Section 8.5: Corrosion Testing. There were two main requests.
  - a) References to ASTM B928 in Section 8.5.2 and 8.5.3.

ASTM B928 provides instructions for the preparation of reference photomicrographs and the batch acceptance of metallography. The Aluminum Association was concerned that UR W25 had neither of these instructions nor references to them. Therefore, a reference to ASTM B928, Section 9.4.1 was added to Section 8.5.2 for the photomicrographs and a reference to ASTM B928, Section 9.6.1 was added to Section 8.5.3 for the metallographic examination.
  - b) Acceptance criteria in Section 8.5.3 for the Corrosion tests.

The Aluminum Association was concerned that the acceptance criteria for the corrosion tests was neither stated explicitly nor contained within the referenced standards, ASTM G66 and G67. These standards only contained the detailed instruction for conducting the corrosion tests. Therefore, the acceptance criteria (as set in ASTM B928) were added to Section 8.5.3.

In addition to the changes in UR W25, the Aluminum Association requested clarification of the origin of the under-thickness tolerances for rolled products, as the tolerances specified in UR W28 are stricter than the current industry standards. The Hull Panel was in favour of maintaining the current UR W25 underthickness tolerances. A response was sent to the Aluminum Association.

- 3) In August 2011, the European Aluminium Association (EAA) requested an update to the alloys and tempers covered by UR W25 (Section 3: Aluminium Alloys and Their Temper Conditions) to Table 2: Mechanical Properties for Rolled Products,  $3\text{mm} \leq t \leq 50\text{mm}$ . The EAA requested that Temper H111 for Alloy 5083 for rolled products be reintroduced into the UR W25 and that corrosion tests, as specified for H116 and H321, be required for Tempers H111 and H112

Even though their mechanical properties are the same, Temper H111 was separated from temper O for all alloys and relocated to a new line in Table 2 and Table 3 during Rev.3 to avoid any conflict with dual certification. At this time,

Temper H111 was removed from Alloy 5083 for rolled products (Table 2) because it was not registered or specified by ASTM for sheets and plates (ASTM B209 and B928). However, it was also removed from all of the rolled product alloys.

Since several of these alloys with temper H111 are specified by European Standards (EN 13195 and EN 485-2) for rolled products, they have been reintroduced into Table 2. The alloys that now specify temper H111 are: 5083, 5383, 5059, 5086, and 5754. Alloy 5456 was not specified in the European Standard.

In Section 8.5.1, Tempers H111 and H112 were added to the list of tempers that require corrosion testing for exfoliation and intergranular corrosion resistance.

- 4) Additional to the requested modifications, Table 2 was updated. In the "Elongation" columns, missing values were added and values not applicable for given thickness ranges were deleted for alloy 5059. In the "Yield Strength" header, the phrase "or range" was added, since several values are given as ranges. This phrase was originally in the header, but was dropped during Rev.3.

In Section 14; Documentation, "h) Corrosion Test Results" was added to the list of details to be supplied by the manufacturer.

For Technical Background, see Annex 4.

## **.5 Other Resolutions Changes**

None

## **.6 Dates:**

Original proposal: *November 2010 Made by: Non-IACS entities (The Aluminum Association and European Aluminium Association)*

Panel Approval: *23 September 2011 by: Hull Panel*

GPG Approval: *2 December 2011 (Ref. 10175\_IGg)*

### **• Rev.3 (May 2006)**

To modify the UR in accordance with newly developed ASTM standard for marine alloys – ASTM B928.

See TB in Part B, Annex 3.

### **• Rev.2 (Dec 2004)**

To review comments from ASTM task group and relevant standards, in particular ASTM B 928-04.

See TB in Part B, Annex 2.

- **Rev.1 (May 2004)**

To rationalize all UR Ws procedures on mechanical testing by reference to the new UR W2 (Rev.2, 2003) and to revise the UR W25 from the viewpoint of the consistency between the special requirements and industry practices regarding thickness tolerances and use of alloy 5083-H321 in marine environments.

See TB in Part B, Annex 1.

- **New (May 1998)**

No TB document available.

## **Part B. Technical Background**

List of Technical Background (TB) documents for UR W25:

Annex 1. **TB for Rev.1 (May 2004)**

See separate TB document in Annex 1.

Annex 2. **TB for Rev.2 (Dec 2004)**

See separate TB document in Annex 2.

Annex 3. **TB for Rev.3 (May 2006)**

See separate TB document in Annex 3.

Annex 4. **TB for Rev.4 (Dec 2011)**

See separate TB document in Annex 4.

Annex 5. **TB for Rev.5 (June 2014)**

See separate TB document in Annex 5.

Annex 6. **TB for Rev.6 (Sep 2021)**

See separate TB document in Annex 6.

**Note:** *There is no separate Technical Background (TB) document for New (May 1998).*

**IACS Unified Requirement W25 (Rev.1):  
Technical Background**

**Aluminium Alloys for Hull Construction and Marine Structure**

**a) Objective/Scope**

The objective were as follows:

1. To rationalize all UR Ws procedures on mechanical testing by reference to the new UR W2 (Rev.2, 2003).
2. To revise the UR W25 from the viewpoint of the consistency between the special requirements and industry practices regarding thickness tolerances and use of alloy 5083-H321 in marine environments.

**b) Source of Proposed Requirements**

The revised draft UR was developed referring to the existing requirements of the UR W25 “Aluminium Alloys for Hull Construction and Marine Structure” and ASTM G66 and G67.

**c) Points of Discussion**

The discussion on the following technical points for the above a) objective/Scope 2 had been made and achieved full agreement of the members:

Aluminium alloys;

The alloys of type 5383 and 5059 are to be newly specified for both rolled and extruded products.

Chemical composition and Mechanical properties;

Chemical composition and mechanical properties of the above alloys are also to be specified accordingly.

Tolerances;

Dimensional tolerances other than underthickness tolerances for rolled products are to be in accordance with the requirements of recognized international or national standard.

Corrosion testing;

1. Rolled 5xxx-alloys of type 5083, 5383, 5059 and 5086 in the H116 and H321 tempers intended for use in marine hull construction or in marine applications where frequent direct contact with seawater is expected are to be corrosion tested with respect to exfoliation and intergranular corrosion resistance.
2. The corrosion tests are to be in accordance with ASTM G66 and G67 or equivalent method.
3. The manufacturers shall establish the relationship between microstructure and resistance to corrosion when the above alloys are approved. A reference photomicrograph shall be established and approved for each of the alloy tempers and thickness ranges relevant.
4. For batch acceptance, metallographic examination of one sample selected from the product is to be carried out. The microstructure of the sample is to be compared to the reference photomicrograph of acceptable material in the presence of the Surveyor.

Branding;

Tempers corrosion-tested are to be marked “M” after the temper condition, e.g. 5083 H321 M.

*Note: GPG added the changes to W25.1.4(..or ANSI H35.1) and W25.4.3 (chemical composition – product analysis). 3004aIGd of 4 May 2004 refers.*

\* \* \*

**Technical Background  
Unified Requirement W25 (Rev.2)**

**Aluminium Alloys for Hull Construction and Marine Structure**

**a) Objective/Scope**

To review comments from ASTM Task Group and relevant standards, in particular ASTM B 928-04, and propose changes to UR W25 Rev.1.

**b) Source of Proposed Requirements**

The revised draft UR was developed referring to the existing requirements of the UR W25 “Aluminium Alloys for Hull Construction and Marine Structure” and ASTM B 209-04 and B 928-04.

**c) Points of Discussion**

The discussion on the following technical points for the above a) objective/Scope had been made and achieved full agreement of the members:

Tempers:

- To delete the temper H32 from UR W25 Rev.1, since this temper will be exempted from corrosion testing in the ASTM standards.

- To add temper H116 for alloy 5086.

New grades:

- To add alloy 5456 with the tempers 0, H116 and H321.

\* \* \* \* \*

Submitted by WP/MW Chairman  
17 September 2004

**TECHNICAL BACKGROUND DOCUMENT  
IACS UR W25 (REV.3, MAY 2006)**

**1. Scope and objective**

To modify the unified requirements UR W25 in accordance with the newly developed ASTM standard for marine aluminium alloys – ASTM B928.

**2. Background**

Recent changes have been made to IACS UR W25 at Rev.2, these were based on problems experienced in service with corrosion, and subsequent investigations by the US Coast Guard. Minor issues have been raised with Rev. 2, including the need for the provision of a US alloy that is used in the marine market, this need to be addressed.

The US alloy referred to above is 5456, which actually was included in connection with the previous revision of UR W25 (Rev.2). However, we also received a number of comments from the ASTM Marine Task Group regarding other issues that needed to be changed/modified (see email from 2006-12-12). One of the important issues was to list the different tempers (e.g. O/H111) separately to discourage dual certification, as the processing of the tempers is different. Further, the ASTM Marine Task Group/Harold Bushfield proposed to change some of the specified properties to be more in line with recognised ASTM standards.

**3. Points of discussions or possible discussions**

- H111 was deleted from Table 2 due to the fact that the H111 temper is not registered and not specified by ASTM for sheets and plates. However, if it is used we may include H111 in a separate row with values taken from the EN-standard.
- NV 5086 H321 is neither specified in ASTM B209M/B928 nor in EN 485-2, and is therefore deleted from Table 2.
- IACS should not specify higher values than the ones specified in recognised standards, especially in standards like ASTM, hence some of the specified strength values have been somewhat modified.
- Previously the values for the O and H111 tempers were identical. This is not considered correct as pointed out by the ASTM Task Group. They are separated in the present proposal to discourage dual certification, due to the fact that these tempers actually represent different processing.

**4. Source/derivation of proposed requirements**

- ASTM B928

**5. Decision by Voting**

A member expresses their reservation to UR W25(Rev.3) with the following comments:  
*\_n the past it was our understanding of IACS objectives to establish own technical regulations valid for the specific fields of application for ship classification.*

*The consideration and to some extent the implementation of international standards had been done as deemed necessary and based on an internal approach. The adjustment to one single national standard such as ASTM seems to be quite questionable as other national standards do exist too.*

*Any change of strength and elongation values or cancellation of temper conditions within the UR shall be done based on technical investigations. The formal change*

*and following one national standard does not consider the good experience gained with the "old" UR W 25 or other existing standards.*

*Therefore we still prefer that H111 temper condition shall remain in the table as it is produced today by the manufacturers and applied in the industry.*

*With respect to our point of view both temper condition O/H111 shall remain in the same line of table 2 and 3 as this table does not reflect certification status of the plates. The mechanical properties of the products mentioned in the tables are one part of certification. Dual certification just exist if both conditions are mentioned on the material certificate which is not the intention of these tables.*

*The cancellation of temper condition H321 for 5086 is accepted.*

*Any other change shall be considered on a technical base or kept as it was proposed recently for Rev. 02.*

## **6. Appendix**

N.A.

Submitted by Hull Panel Chairman  
10 April 2006

### **Note:**

The member removed its reservation at GPG level as follows:

### **Quote:**

To: IACS GPG Chairman, 2006-04-28  
CC: IACS GPG Members  
CC: IACS Permanent Secretariat

1. Regarding the acceptance of UR W25 Rev. 3 GL is going to accept the modifications.

2. In addition to the material specifications as listed in Table 2 we will continue to use the temper conditions  
H111 for grades 5083, 5383, 5059, 5086, 5754  
H321 for grade 5086

3. We account these temper conditions as equivalent or even superior (with regard to fabrication aspects) to the materials as listed in Table 2 of Rev. 3.

Best regards,

IACS GPG Member

### **Unquote:**



## Technical Background for UR W25 Rev.4, Dec 2011

### 1. Scope and objectives

To modify the unified requirements UR W25, following multiple requests from industry associations.

### 2. Engineering background for technical basis and rationale

Two industry associations, the Aluminum Association and the European Aluminium Association, requested modification to UR W25.

The Aluminum Association requested:

- (1) References to ASTM B928 be added in Section 8.5.2 and 8.5.3, to provided instructions for the preparation of reference photomicrographs and the batch acceptance of metallography.
- (2) Acceptance criteria for the corrosion test be added in Section 8.5.3.
- (3) Clarification of the origin of the under-thickness tolerances for rolled products and the reason the IACS requirements differ from industry requirements.

The European Aluminium Association requested

- (1) H111 temper for Alloy 5083 be included for rolled products in Table 2.
- (2) Corrosion tests be required for temper H111.

### 3. Source/derivation of proposed IACS Resolution

- ASTM B928
- EN 13195
- EN 485-2

### 4. Summary of changes intended for the revised Resolution

#### Alloys:

- Temper H111 was added to the list of temper conditions covered by UR W25 in Section 3.1
- Temper H111 was added to Table 2 for the alloys 5083, 5383, 5059, 5086, and 5754, as specified by European Standard EN13195 and EN 485-2 . Alloy 5456 was not specified in the European Standards.
- Table 2 was corrected to specify that yield strength may be given as a range.
- In Table 2, missing values were added and values not applicable for given thickness ranges were deleted from the Elongation column.

#### Corrosion Tests:

- In Section 8.5.1, Tempers H111 and H112 were added to the list of tempers that require corrosion testing for exfoliation and intergranular corrosion resistance.

- A reference to ASTM B928, Section 9.4.1 was added to UR W25, Section 8.5.2 for instruction on the preparation of photomicrographs.
- A reference to ASTM B928, Section 9.6.1 was added to UR W25, Section 8.5.3 for instruction on the preparation of the metallographic examination.
- The acceptance criteria for the corrosion tests (as set out in ASTM B928) were added to UR W25, Section 8.5.3.
- In Section 14; Documentation, "h) Corrosion Test Results" was added to the list of details to be supplied by the manufacturer.

Thickness Tolerance:

- It is understood that the thickness tolerance values were taken from an old Standard and it was noted that vessels designed with aluminium are typically done so on close margins. The thickness tolerances on extruded products in UR W25 were changed in 2004/2005 in order to bring them in line with recognized standards. This was due to the fact that most extrusions were manufactured in accordance with recognized standards with respect to thickness tolerances. We are aware that the under-thickness tolerances for rolled products differ from recognized standards, however IACS wanted to keep the somewhat stricter under-thickness tolerances compared to recognized standards.

**5. Points of discussions or possible discussions**

None

**6. Attachments if any**

None

## **Technical Background for UR W25 (Rev.5, June 2014)**

### **1. Scope and objectives**

To modify the Unified Requirement UR W25, following discussions at the annual meeting of the IACS EG/MW.

### **2. Engineering background for technical basis and rationale**

At the IACS EG/MW 2012 meeting a number of members questioned the UR W25 requirement for corrosion testing of 5083, 5383, 5059, 5086 and 5456 in the H111 and H112 temper conditions.

The corrosion tests specified in UR W25 are intended to demonstrate freedom from exfoliation and intergranular corrosion. The risk of sensitisation to exfoliation and intergranular corrosion is considered to be low due to the production methods associated with manufacture of H111 and H112 temper condition products.

The corrosion testing of temper conditions H111 and H112 is considered technically unnecessary and out of step with industry practice and is therefore to be removed from UR W25.

### **3. Source/derivation of proposed IACS Resolution**

IACS EG/MW 2012 meeting minutes.

### **4. Summary of changes intended for the revised Resolution**

Corrosion Tests:

- In Section 8.5.1, Tempers H111 and H112 were deleted from the list of tempers that require corrosion testing for exfoliation and intergranular corrosion resistance.

### **5. Points of discussions or possible discussions**

None

### **6. Attachments if any**

None

**Technical Background (TB) document for UR W25 (Rev.6 Sep 2021)**

**1. Scope and objectives**

Review and update industry standards format according to GPG instructions.

**2. Engineering background for technical basis and rationale**

N.A.

**3. Source/derivation of the proposed IACS Resolution**

ANSI H35.1:2017

ASTM B928:2015

ASTM G66:2018

ASTM G67:2018

EN 515:2017

**4. Summary of Changes intended for the revised Resolution:**

Industry standards format has been updated according to GPG instructions.

**5. Points of discussions or possible discussions**

None.

**6. Attachments if any**

None.

## UR W26 "Requirements for Welding Consumables for Aluminium Alloys"

### Summary

Review and update industry standards format according to GPG instructions

### Part A. Revision History

Version no.	Approval date	Implementation date when applicable
Rev.2 (Sep 2021)	21 September 2021	1 January 2023
Rev.1 (June 2005)	June 2005	-
New (July 1999)	July 1999	-

#### Rev. 2 (Sep 2021)

##### 1 Origin of Change:

- Suggestion by IACS member

##### 2 Main Reason for Change:

To update industry standards format according to GPG instructions given in GPG Vice-chair message 19000\_IRC.

##### 3 List of non-IACS Member classification societies contributing through the TC Forum and/or participating in IACS Working Group:

None.

##### 4 History of Decisions Made:

Original proposal was made according to GPG Vice-chair message 19000\_IRC. Proposal to revise the IACS URs and RECs only to refer to a dated version of the industry standard as per GPG instructions was made at IACS EG/MW meeting in September 2019. Three drafts have been discussed by the group.

##### 5 Other Resolutions Changes:

None.

##### 6 Any hinderance to MASS, including any other new technologies:

None.

**7 Dates:**

Original Proposal : April 2019 (Made by: GPG)  
EG M&W Approval : July 2021  
GPG Approval : 21 September 2021 (Ref: 19000\_IGq)

- **Rev. 1 (June 2005)**

No records available.

- **New (July 1999)**

No records available.

\*\*\*\*\*

## **Part B. Technical Background**

List of Technical Background (TB) documents for UR W26:

Annex 1. **TB for New (July 1999)**

See separate TB document in Annex 1.

Annex 2. **TB for Rev.1 (June 2005)**

See separate TB document in Annex 2.

Annex 3. **TB for Rev.2 (Sep 2021)**

See separate TB document in Annex 3.

IACS UR W26 (Rev.0)  
**Requirements for Welding Consumables for Aluminium Alloys**

**Technical Backgrounds**

a) **Objective / Scope**

The objective was to newly elaborate the Unified Requirement for Welding Consumables for Aluminium Alloys. The consumables specified in this draft UR are applicable to welding of the aluminium alloys for hull construction / marine structure specified in UR W25, which was formerly established.

b) **Source of Proposed Requirements**

The requirements in this draft UR were elaborated referring to UR W17 "Approval of Consumables for Welding Normal and Higher Strength Hull Structural Steels" and corresponding National / International Standards.

c) **Points of Discussion**

The discussions had been held mainly upon the following three points of view and achieved full agreement in the AHG/MW :

• Quality grades :

The requirements for manufacturing were decided in line with ones in UR W17. The grades of consumables were categorized based on the kinds of consumables (rod/wire) and the materials grade of base metals for which the consumables are used.

• Approval test procedures :

The approval test procedures (including the requirements on annual test) were decided in line with ones in UR W17, i.e; the tests required are carried out by using the test pieces taken from both deposited metals and butt-weld test assemblies.

• Required properties :

The requirements concerning tensile/bend tests on butt-weld assemblies were specified. The minimum tensile strength's level is basically equal to the lower limit of the ones for O-materials (annealing) of the base metals to be used in the tests.

△△



**Technical Background Document  
UR W26 (Rev.1 June 2005)**

**Requirements for Welding Consumables for Aluminium Alloys**

**a) Objective/Scope**

The objective was to develop requirements of welding consumables for aluminium alloys 5383 and 5059.

**b) Source of Proposed Requirements**

The revised draft UR was developed referring to the existing requirements of the UR W26 "Requirements for Welding Consumables for Aluminium Alloys".

**c) Points of Discussion**

The discussion on the following technical points for the above a) objective/Scope had been made and achieved full agreement of the members:

Base materials for test;

Aluminium alloys 5383, 5456, 5059, 6005A and 6061 are to be added as base material for the test.

Requirements for the transverse tensile and bend test;

The requirements of tensile strength of quality grade RC/WC are to be amended depending on the base material applied for the tests.

Approval range;

It is understood that a welding consumable of quality grade RC/WC can be qualified using any base materials within that quality grade.

The WP pointed out the need to specify the tensile strength of butt joint for each base material and the range of application of the different welding consumables to the base materials should be specified in matrix of IACS Recommendation 70 "Guidelines on welding procedure qualification tests of aluminium alloys for hull construction and marine structures".

This matter should be considered under Task No.54.

Submitted by WP/MW Chair  
28/12/2004

**Technical Background (TB) document for UR W26 (Rev.2 Sep 2021)**

**1. Scope and objectives**

Review and update industry standards format according to GPG instructions.

**2. Engineering background for technical basis and rationale**

N.A.

**3. Source/derivation of the proposed IACS Resolution**

ISO 4063:2009

**4. Summary of Changes intended for the revised Resolution:**

Industry standards format has been updated according to GPG instructions.

**5. Points of discussions or possible discussions**

None.

**6. Attachments if any**

None.

## UR W27 – Cast Steel Propellers

### Summary

This UR provides requirements for the manufacture, inspection and repair procedures of cast steel propellers, blades and bosses. This revision has the following technical change:

Paragraph 11.5: Repair of defects in zone A:

- the permissibility of a modified Zone A, is now deleted.

Opportunity was taken to carry out other minor edits and clarifications.

Updated the definitions of linear and non-linear indications to align with ISO 23277:2015

### Part A. Revision History

Version no.	Approval date	Implementation date when applicable
Rev.3 (Sep 2023)	11 Sep 2023	1 January 2025
Corr.1 (Sep 2020)	29 Sep 2020	-
Rev.2 (July 2020)	16 July 2020	1 July 2021
Rev.1 (May 2004)	<i>No records</i>	-
NEW (May 2000)	<i>No records</i>	-

#### • Revision No. 3, July 2023

##### 1 Origin of Change:

- ✓ Suggestion by IACS member

##### 2 Main Reason for Change:

To revise paragraph 11.5 of UR W27 Rev.2 Corr.1 to exclude such a permissibility of a modified Zone A.

##### 3 List of non-IACS Member classification societies contributing or participating in IACS Working Group:

No contribution by non-IACS Member classification societies.

##### 4 History of Decisions Made:

The previous (Rev.2 Corr.1) Resolution introduced the permissibility of modification of Zone A in case of repair by welding on an individual approach. However, the lack of criteria for the application of these modification and the inconsistency of the applied

approach (with feedback from the IACS Machinery Panel) caused several IACS Members to have difficulties in implementing UR W27 Rev.2 Corr.1 in their Classification Rules.

Responding to statements of interest from a number of IACS members, EG/M&W decided that it is necessary to revise the above Unified Requirements to exclude this permissibility. Since there are no detailed requirements for the basis of a modified Zone A, it is left to the Classification Society to decide the technical basis for such a decision. Every effort should be made to rectify a discontinuity within Zone A without recourse to welding.

## **5 Other Resolutions Changes:**

None.

## **6 Any hinderance to MASS, including any other new technologies:**

None.

## **7 Dates:**

Original Proposal : 10 February 2022 Made by: EG M&W  
EG/M&W Approval : 30 June 2020 (Ref: 18149\_EMWe)  
GPG Approval : 11 September 2023 (Ref: 22023\_IGf)

### **• Corr.1 (Sep 2020)**

#### **1 Origin of Change:**

Suggestion by an IACS member

#### **2 Main Reason for Change:**

The application statement of UR W27(Rev.2) "Cast Steel Propeller", needs to be corrected as follows:

#### **Quote**

*1. Changes introduced in Rev.2 are to be uniformly implemented by IACS Societies on ships contracted for construction on or after 1 July 2021, or when the application for certification of cast copper alloy steel propellers is dated on or after 1 July 2021, or the application for certification of manufacturer approval is dated on or after 1 July 2021.*

#### **Unquote**

#### **3 List of non-IACS Member classification societies contributing or participating in IACS Working Group:**

None

#### **4 History of Decisions Made:**

Having noted this proposal could be regarded as minor editorial correction to the

application statement, it was approved by GPG as a corrigenda without further involvement of EG/M&W.

**5 Other Resolutions Changes:**

None

**6 Any hinderance to MASS, including any other new technologies:**

None

**7 Dates:**

Original Proposal: 11 September 2020 (Ref: 18149\_IRd)  
GPG Approval: 29 Sep 2020 (Ref: 18149aIGb)

• **Rev.2 (July 2020)**

**1 Origin of Change:**

Suggestion by an IACS member

**2 Main Reason for Change:**

Review and harmonize non-destructive testing requirements in URW24 and URW27. Review the repair welding requirements.

**3 List of non-IACS Member classification societies contributing or participating in IACS Working Group:**

No contribution by non-IACS Member classification societies.

**4 History of Decisions Made:**

Original proposal to revise IACS UR W24 and UR W27 for consistency of the definition of liquid penetrant indications and for evaluation of technical requirements was made at IACS EG/MW meeting in September 2016. Four drafts have been discussed by the group.

Discussions took place about UR W24 article 11.3 & UR W27 article 11.5- repair of defects in Zone A. Members decided to reword these articles to introduce cases where propeller designer submit technical documentation to propose a modified Zone A. Discussions took place about UR W27 article 7.1 – Mechanical properties. Members decided to make reference to recognized standard for the thickness of test coupon.

**5 Other Resolutions Changes:**

None

**6 Any hinderance to MASS, including any other new technologies:**

None

**7 Dates:**

Original Proposal: September 2016 Made by: EG M&W  
EG M&W Approval: 30 June 2020 (Ref: 18149\_EMWe)  
GPG Approval: 16 July 2020 (Ref: 18149\_IGh)

• **Rev.1 (May 2004)**

No records available.

• **New (May 2000)**

No records available.

\*\*\*\*\*

## Part B. Technical Background

List of Technical Background (TB) documents for UR W24:

Annex 1. **TB for the new (May 2000)**

See separate TB document in Annex 1.

Annex 2. **TB for Rev.1 (May 2004)**

See separate TB document in Annex 2.

Annex 3. **TB for Rev.2 (July 2020)**

See separate TB document in Annex 3.

Annex 4. **TB for Rev.3 (Sep 2023)**

See separate TB document in Annex 4.

**Note:** *There are no separate Technical Background (TB) document available for Corr.1 (Sep 2020).*

IACS Unified Requirement W [27]

## Cast steel propellers

### Technical Backgrounds:

#### a) Objective / Scope

The objective was to newly elaborate the Unified requirement for cast steel propellers. This draft UR applies to Cr-Ni alloyed cast steel propellers.

#### b) Source of Proposed Requirements

The requirements in this draft UR were developed referring to the UR W24 “Cast copper alloy propellers”, in addition to the corresponding specifications of individual Society’s Rules and National/International Standards.

#### c) Points of Discussion

The discussion had been mainly made on the following technical points and achieved full agreement of the members:

##### Type of alloy steels;

Typical 4 types of Cr-Ni alloy steels are to be specified according to their microstructures and chemical components (major elements only).

Heat treatment required for each type is to be specified, i.e., austenitization and temper for martensitic castings and solution treatment for austenitic castings.

##### Test procedures and required properties;

Mechanical properties such as proof stress, tensile strength, elongation, reduction of area and CVN energy, tested with the integrally cast test specimens are to be specified. Basically, one set of test specimens is to be taken for each casting. CVN test is not required in the case of the use of general service and the lowest Ice class notation. Also, separately cast test specimens and/or batch testing procedures may be allowed subject to the prior approval of the individual Society.

##### NDE and repair procedures;

NDE procedures/criteria and repair procedures (include repair welding) are to be given according to the severity Zones which divide the propeller surface into Zones A to C, that is in line with the corresponding specifications of UR W24 for better use. Also, procedure qualification tests for repair weldings are to be specified in the Appendix, in the same manner as UR W24.

\* \* \* \* \*



**IACS Unified Requirement W27(Rev.1)  
Technical Background**

**Cast Steel Propellers**

**a) Objective/Scope**

The objective was to rationalize all UR Ws procedures on mechanical testing by reference to the new UR W2 (Rev.2, 2003).

**b) Source of Proposed Requirements**

The revised draft UR was developed referring to the existing requirements of the UR W27 “Cast Steel Propellers” and the UR W2 “Test specimens and mechanical testing procedures for materials”.

**c) Points of Discussion**

Nil.

\* \* \* \* \*

## **Technical Background (TB) document for UR W27 (Rev.2, July 2020)**

### **1. Scope and objectives**

The objectives were to review:

- the definition of severity zones with regards to current propeller design established by the marine industry.
- the status of sampling and testing requirements for mechanical properties.
- the repair welding requirements.

Review and harmonize non-destructive testing requirements in URW24 and URW27.

### **2. Engineering background for technical basis and rationale**

UR W24 "Cast copper alloy propellers" and UR W27 "Cast steel propellers" have been reviewed for consistency and for evaluation of technical requirements. It was noted that non-destructive testing requirements are to be harmonized between both URs. The conditions for the execution of welding repair procedure qualification must be revised with regards to the recognized standards and current foundries practice.

### **3. Source/derivation of the proposed IACS Resolution**

Existing Classification Societies Rules as well as international standard ISO 11970:2016 have been considered.

The UR refers to the following international standard:

ISO 3452-1:2013 "Non-destructive testing -- Penetrant testing -- Part 1: General principles".  
ISO 9934-1:2016 "Non-destructive testing – Magnetic Particle Testing -- Part 1: General principles".

### **4. Summary of Changes intended for the revised Resolution:**

The content of UR W27 has been fully reworked and revised with major changes summarised hereafter:

- Revised and update requirements for NDT,
- Revised and develop requirements for welding procedure qualification tests for repairs.

### **5. Points of discussions or possible discussions**

UR W27 article 7.1 – Mechanical properties: testing sampling has been discussed. It was agreed to make reference to recognized standard for the thickness of test coupon.

UR W24 article 11.3 & UR W27 article 11.5- repair of defects in Zone A: Requirement has been discussed and reworded to introduce cases where propeller designer submit technical documentation to propose a modified Zone A.

### **6. Attachments if any**

None

\*\*\*

## **Technical Background for UR W27 (Rev.3 Sep 2023)**

### **1. Scope and objectives**

The objectives were to:

- either provide detailed requirements for the basis of a modified zone A, or;
- to exclude such permissibility of modifying the zone A

### **2. Engineering background for technical basis and rationale**

The lack of detailed criteria for the application of a modified zone A, and the inconsistency of the applied approach (upon discussions with the IACS Machinery Panel) caused several IACS Members to have difficulties in implementing UR W27 in their Classification Rules.

Responding to statements of interest from a number of IACS members, a decision was taken by EG/M&W that it was necessary to revise UR W27 to either detail the requirements for the permissibility of modification of Zone A (and agree the chosen approach with the Machinery Panel), or to exclude such a permissibility.

#### **2a. Specification of the data utilised in the development/revision of the proposed IACS Resolution, if any**

None

### **3. Source/derivation of the proposed IACS Resolution**

Existing Classification Societies Rules

IACS UR W24

IACS UR W27

ISO 23277:2015. Non-destructive testing of welds — Penetrant testing — Acceptance levels.

### **4. Summary of Changes intended for the revised Resolution:**

- Referring to paragraph 11. Repair of defects, and specifically 11.5 - it was unanimously agreed to exclude such a permissibility of a modified Zone A, and it is left to the member Society to decide any technical basis for such a decision. Therefore, the text relating to this clause is deleted.
- Minor (non-technical) typographical/editorial changes were made to other paragraphs.
- Updated the definitions of linear and non-linear indications to align with ISO 23277:2015

### **5. Points of discussions or possible discussions**

- Members unanimously agreed that it was not possible to specify detailed requirements within this UR as to how (or on what basis) a modified zone A could be achieved.

- IACS Machinery Panel were also consulted, and they agreed that no detailed requirements could be included in this UR for such a modified zone A
- It was noted amongst members that other paragraphs within the UR make some provision that upon special agreement with the Classification Society, weld repair may take place (it is left to the member Society to decide the technical basis for such a decision)
- It was further noted amongst members that the UR advises that grinding may be carried out in zone A (where possible), to rectify any defects within this zone.

## **6. Attachments if any**

None.

\*\*\*

## UR W28 “Welding procedure qualification tests of steels for hull construction and marine structures”

### Part A. Revision History

Version no.	Approval date	Implementation date when applicable
Rev.2 (Mar 2012)	26 March 2012	1 January 2013
Rev.1 (Nov 2006)	14 November 2006	1 January 2007
NEW (June 2005)	27 June 2005	1 January 2007

#### • Rev.2 (Mar 2012)

##### .1 Origin for Change:

- Suggestion by a IACS member

##### .2 Main Reason for Change:

The objective was to modify the range of approval depending on type of welded joint for test assemblies specified in Table 3 “Range of approval for type of welded joint”.

##### .3 List of non-IACS Member classification societies contributing through the TC Forum and/or participating in IACS Working Group:

None

##### .4 History of Decisions Made:

With regard to Table 3, it was proposed to remove “D” (both sides without gouging) from the range of approval of “A” (one side with backing) and also proposed to add “A” to the range of approval of “D”.

As a result of Hull Panel discussions regarding these proposals, the Hull Panel agreed to the proposal to remove “D” at the 14<sup>th</sup> Hull Panel meeting held in February 2011. However, the proposal to add “A” was unable to attain the 2/3 majority of Hull Panel members needed for approval because five members did not support the proposal.

##### .5 Other Resolutions Changes

None

##### .6 Dates:

Original proposal: 28 December 2009 Made by: HP member  
 Panel Approval: 15 February 2011 by: Hull Panel  
 GPG Approval: 26 March 2012 (Ref. 12020\_IGc)

- **Rev.1 (Nov 2006)**

See TB in Part B, Annex 2.

- **NEW (Jun 2005)**

See TB in Part B, Annex 1.

## **Part B. Technical Background**

List of Technical Background (TB) documents for UR W28:

Annex 1. **TB for NEW (June 2005)**

See separate TB document in Annex 1.

Annex 2. **TB for Rev.1 (November 2006)**

See separate TB document in Annex 2.

Annex 3. **TB for Rev.2 (March 2012)**

See separate TB document in Annex 3.



**Technical Background Document  
UR W28 (June 2005)**

**Welding procedure qualification tests of steels for hull construction and marine structures**

**a) Objective/Scope**

The objective was to develop a new UR concerning welding procedure qualification test for hull construction, referring to the existing Rec.32.

**b) Source of Proposed Requirements**

The revised draft UR was developed referring to the existing IACS Recommendation 32 "Guidelines on welding procedure qualification tests for hull construction", ISO 15614-1 "Specification and qualification of welding procedures for metallic materials –Welding procedure test-" and other recognized standards.

**c) Points of Discussion**

The discussion on the following technical points had been made and achieved full agreement of the members:

Scope:

The requirements are applicable to the welding procedure qualification tests for steels specified in UR W7, W8, W11 and W16.

Preliminary welding procedure specification and welding procedure specification:

A preliminary welding procedure specification (pWPS) is to be submitted prior to the tests. A pWPS may be approved as a welding procedure specification, upon satisfactory completion of the test.

Qualification of welding procedure (Longitudinal tensile test):

The test is to be carried in case where the welding consumable is not approved by the Society.

Qualification of welding procedure (Impact test):

- 1) Sampling position and notch location are to be developed depending on the thickness and the heat input.
- 2) The requirements(test temperature and required energy) for steels specified in UR W11 are to be specified for steels with thickness not more than 50mm and are to follow the Rec.32 which are based on the impact test requirements of welding consumable specified in UR W17.
- 3) The requirements for steels specified in UR W16 are to follow the requirements of base metals.
- 4) Test for cast and forged structural steels are to be carried out only in case where the tests are required for the base metals.



Range of approval:

1) Base metal

The Range of approval for steel grade is to be specified with the following key concepts:

- For each strength level, welding procedures are considered applicable to the same and lower toughness grades as that tested.
- For each toughness grade, welding procedures are considered applicable to the same and two lower strength levels as that tested.
- For high heat input processes above 50kJ/cm, welding procedure is applicable to that toughness grade tested and one strength level below.

2) Welding position

Test assemblies are to be welded with the highest heat input position and the lowest heat input position, i.e. two positions are usually tested for approval of all positions, and all applicable tests are to be made.

3) Welding consumable

Welding consumable having the same grade marks including all suffixes with that tested are to be included.

4) Heat input

The upper limits of heat input for high heat input welding is to be stricter than normal heat input welding.

5) Type of joint

The range of approval is to be specified with the concept that one side welding is superior to both side welding.

Test records:

The statement included in test record that the test piece was made according to the particular welding procedure is to be signed by the surveyor witnessing the test.

Permsec Note: In connection with approval of new UR W28, GPG decided to delete Recommendation No.32 from the Blue Book.

Submitted by WP/MW Chair  
28/12/2004

**Technical Background Document  
UR W28 (Rev. 1 November 2006)**

**Welding procedure qualification tests of steels for hull construction and marine structures**

**a) Objective/Scope**

Prior to the implementation of UR W28 (June 2005), which was adopted by the Council on 27 June 2005, the member societies found difficulties in the implementation of the UR based on the contracted for construction date as specified therein. As unanimously agreed upon by WP/MW, Hull Panel, GPG and Council, the contents of the requirements for welding procedure qualification tests remain unchanged. Revision 1 to the UR aims to clarify the application date of the requirements.

**b) Source of Proposed Requirements**

No changes are made from W28 (June 2005)

**c) Points of Discussion**

Issues of W28 (June 2005)

- 1) In the footnote 1 of the UR, it specifies that the UR is to be uniformly implemented on ships contracted for construction from 1 January 2007 as well as the manufacturing of which is commenced on or after 1 January 2007.
- 2) This means that all current welding procedures approved by the members' societies in the past and being used by shipyards/manufacturers for long time, are no longer valid as the qualified welding procedures and new qualification tests are required to be performed for compliance with the UR W28.
- 3) There should be no point for introduction of the situation as mentioned in 2 above.

Solutions by W28 (Rev. 1 October 2006)

- 1) In order to solve the implementation issue, the following limit statements are provided in the new paragraphs 1.3 and 1.4:

*1.3 All new welding procedure qualification tests are to be carried out in accordance with this document from 1 July 2007.*

*1.4 This document does not invalidate welding procedure qualification tests made and accepted by the Classification Society before 1 July 2007 provided the welding procedure qualification tests are considered by the Classification Society to meet the technical intent of this UR or have been qualified in accordance with the recognized standards such as ISO, EN, AWS, JIS or ASME.*

- 2) The above new descriptions clarify the application/scope of the UR W28 without deletion of the footnotes 1 and 2 of W28 (June 2005) as approved by Council on 27 June 2005.
- 3) The accepted welding procedures according to each Classification Society's rules are considered to meet the technical intent of this UR.

**d) Others**

A member advised of the need for them to reserve on certain technical aspects of the UR as a result of its governance body review. Member will detail its reservations to Council as soon as possible.

Submitted by Hull Panel Chair, October 2006

**Permanent Secretariat Note (November 2006):**

- Item (d) added by GPG following their discussion.
- Revised W28 approved by GPG and Council, 14 November 2006 (6183\_IGd)

**Technical Background Document  
UR W28 (Rev. 2 March 2012)**

**Welding procedure qualification tests of steels for hull construction and marine structures**

**1. Objective/Scope**

To modify the range of approval depending on type of welded joint for test assemblies specified in Table 3 “Range of approval for type of welded joint”.

**2. Engineering Background for Technical Basis and Rationale**

Qualifying a welding procedure from one side with backing implies a technique with a designated joint geometry (root face, root opening, and groove angle), a designated backing material, and a heat input to achieve a sound weld in the root against the backing whether the backing remains in place or is removed. Utilizing this same technique within the limits of the (one side) procedure variables in a weld made from both sides may or may not provide a satisfactory root weld depending on joint geometry and heat input limits of the procedure.

**3. Source/Derivation of Proposed Requirements**

- Hull Panel Member
- ISO 15614-1

**4. Summary of Changes Intended for the Revised Resolution**

- In Table 3, item “D” was removed from the range of approval for item “A”.

**5. Points of Discussion and Decision by Voting**

Associated International Standards

Rev. 1 of UR W28 was in line with the international standard ISO 15614. There was some concern regarding the fact that the changes made in Rev. 2 made the IACS requirements stricter than the ISO requirement.

However, ISO is an international standard that is used for not only ships but also other industries, while an IACS UR is a requirement dedicated to ships. There is precedent among this UR and other URs where the requirements are stricter than their ISO equivalent.

Additionally, there appears to be a contradiction among the more important welding qualification standards used in industry (ie ISO 15614, AWS D1.1, ASME IX) in this regard.

Removing “D” from the range of approval of “A”

Table 3 showed that, in cases where the welding procedure specifications of “A” were approved, “C” (both side welding with gouging) and “D” could be also included in the range of approval for the welding procedure specifications.

Regarding “D”, it is important not to leave any defects in the root pass for quality control of welded joints. The condition of a groove in the root pass is similar to that of “B” and the root pass is required to be a penetration bead. Accordingly, the welding condition is different from “A”.

Therefore, it was suggested that it was not appropriate to include “D” in the range of approval of “A”. That suggestion was accepted by the Hull Panel.

Adding “A” to the range of approval of both side without gouging “D”

In addition to the above, it was also proposed to add “A” to the range of approval of “D”, since “A” would be technically covered by the qualifications for “D” if the qualification level required for “D” is properly achieved,.

However, some Hull Panel members commented that the qualifications for the welding procedure for “D” should not cover the procedure for “A”, given that certain factors for “A” such as the type of backing strip, heat input, and weld gaps are different from those applicable to “D”.

As a 2/3 majority was not achieved, the proposal was rejected.

**6. Attachments, if any**

None

**Technical Background Document  
UR W29 (June 2005)**

**Requirements for manufacture of anchors**

**a) Objective/Scope**

The objective was to develop the requirements for the manufacture and certification of anchors.

**b) Source of Proposed Requirements**

The revised draft UR was developed referring to UR A1 "Equipment" and JIS F 3301 "Anchors".

**c) Points of Discussion**

The discussion on the following technical points had been made and achieved full agreement of the members:

Scope;

The requirements are to be specified for manufacture of any types of anchors specified in UR A1.

Materials;

Cast steel, forged steel and rolled steel used for anchor are to be manufactured and tested in accordance with the UR W to be applied.

Product test programme;

The Society can require, in addition to proof load test, either of two kinds of product test programme to anchors, depending of product form i.e. cast, forged or fabricated anchor. In stead of drop test and hammering test required in Programme A, Charpy V notch impact tests for cast anchor and extended NDE are required in Programme B. In this regards, requirement of NDE for locations of anchor was specified based on UR A1.

Repair criteria

Repair is not permitted for fracture and unsoundness defected in hammering test and drop test.

Certification;

The Classification Society issues the certificate to the manufacturer, including the information of type, mass, ID No., grade of materials, proof test load, heat treatment, and marking the applied to anchor etc.

Submitted by WP/MW Chair  
28/12/2004

## UR W30 “Normal and higher strength corrosion resistant steels for cargo oil tanks”

### Part A. Revision History

Version no.	Approval date	Implementation date when applicable
New (Feb 2013)	18 February 2013	01 January 2014

#### • New (Feb 2013)

##### .1 Origin for Change:

Suggestion by IACS members

##### .2 Main Reason for Change:

None - new document.

##### .3 List of non-IACS Member Classification Societies contributing through the TC Forum and/or participating in IACS Working Group:

Nippon Steel Corporation, Kobe Steel Ltd, JFE Steel Corporation and Sumitomo Metal industries Ltd.

##### .4 History of Decisions Made:

See technical background.

##### .5 Other Resolutions Changes

None

##### .6 Dates:

Original Proposal: *07 March 2012 (By PT59)*

Panel Approval: *13 November 2012 (By Hull Panel)*

GPG Approval: *18 February 2013 (10105\_IGk)*

## **Part B. Technical Background**

Annex 1. **TB for New (Feb 2013)**

See separate TB document in Annex 1.



## Technical Background document for UR W30 (New, Feb 2013)

### 1. Scope and objectives

The Performance Standard for Alternative Means of Corrosion Protection for Cargo Oil Tanks of Crude Oil Tankers (IMO Resolution MSC.289 (87)) allows for the use of "*Corrosion Resistant Steel*". This steel is modified ship steel with micro additions of certain chemical elements that have been found to have a beneficial effect by retarding the corrosion rate in the environments found in cargo tanks of crude oil carriers.

Many issues arise because Corrosion resistant Steels are newly developed materials. It has therefore been necessary to produce a new IACS UR W30, to explain the manufacture, testing and certification of these steels.

### 2. Engineering background for technical basis and rationale

Several issues were highlighted that IACS needed to address:

- a) The materials need to comply with strength and toughness in accordance with UR W11.
- b) There is no IACS unified approach to the approval, manufacture, certification and shipyard application of these steels. Their application has no effect on fabrication in shipbuilding, but there are no requirements in the IMO resolution addressing approval, manufacture and certification and these processes need to be addressed.
- c) The steel must be approved to confirm the corrosion resistance.
- d) No practicable production release test is available for these steels. Although a type approval test method has been developed in the IMO PSPC it is noted that this test method allows variation in the composition of the test medium, such as concentration of H<sub>2</sub>S. This creates uncertainty in the assessment of the corrosion resistance of the steel.

Taking the above into account a project team PT59 was asked to draft a new IACS UR W30, to explain the manufacture, testing and certification of these steels.

### 3. Source/derivation of the proposed IACS Resolution

The IMO Performance Standard comes into effect on 1 January 2013 for new building contracts. It was aimed to have a UI in place by 1 June 2012 to allow time for designs to be considered before contracts are signed.

### 4. Summary of Changes intended for the revised Resolution:

Not applicable

### 5. Points of discussions or possible discussions

None

**6. Attachments if any**

None

## UR W31 “YP47 Steels and Brittle Crack Arrest Steels”

### Summary

Latest revision is dealing with the approval scheme of small-scale test methods for brittle crack arrest steels. Requirements for testing and approval procedures have been revised and developed.

### Part A. Revision History

Version no.	Approval date	Implementation date when applicable
Rev.3 (Mar 2023)	07 March 2023	01 July 2024
Rev.2 (Dec 2019)	3 December 2019	01 January 2021
Rev.1 (Sept 2015)	30 September 2015	01 January 2017
New (Jan 2013)	21 January 2013	01 January 2014

#### • Rev.3 (Mar 2023)

##### 1 Origin of Change:

- Suggestion by an IACS member

##### 2 Main Reason for Change:

- 1) Stipulate the approval scheme of small-scale test methods for brittle crack arrest steels
- 2) Update the “Annex 3 Test Method for Brittle Crack Arrest Toughness, Kca” reflecting ISO20064: 2019.

##### 3 List of non-IACS Member classification societies contributing through the TC Forum and/or participating in IACS Working Group:

None

##### 4 History of Decisions Made:

- Members agreed that small-scale test methods are approved by each manufacturer’s proposed test method, not unified test method, since small-scale test methods are to be determined based on manufacturer’s own technical philosophy with regard to achieving the brittle crack arrest properties of brittle crack arrest steels.
- Members agreed that the examples of small-scale test method are stipulated for manufacturer’s reference and the other test methods which are not stipulated in Annex 5 are also acceptable as small-scale test method.

- Members agreed that Charpy V Notch test, if proposed as a single test method for small scale testing, is not suitable to provide robust correlation or determination of crack arrest properties
- Members agreed that the correlation in brittle crack arrest properties between the calculated values from small scale tests and the brittle crack arrest test results shall be assured by using the value of twice the standard deviation ( $2\sigma$ ) which is obtained from at least 12 test plates.
- Members agreed that the product testing acceptance criterion of brittle crack arrest steels by the small-scale tests is to be determined so that regression equation can predict brittle crack arrest properties on safety side, considering the scatter of brittle crack arrest properties from the predicted value by the regression equation.

## 5 Other Resolutions Changes

None

## 6 Any hinderance to MASS, including any other new technologies:

None

## 7 Dates:

Original Proposal	: 04 February 2020	(Made by: EG M&W Member)
EG M&W Approval	: 23 January 2023	(Ref: EMW1401)
GPG Approval	: 07 March 2023	(Ref: 15198_IGI)

## • Rev.2 (Dec 2019)

### 1 Origin of Change:

- Suggestion by an IACS member

### 2 Main Reason for Change:

Specify the required brittle crack arrest toughness  $K_{ca}$  for brittle crack arrest steels (hereinafter "BCA steels") referred to in UR S33 with thickness exceeding 80mm and up to 100mm.

Specify the required Crack Arrest Temperature (CAT) for BCA steels.

Amend the unified requirements on temperature-gradient brittle crack arrest test procedure to evaluate  $K_{ca}$  of BCA steels specified in Annex 1 of UR W31 in accordance with Japan Welding Engineering Society Standard of WES 2815:Jan 2014.

Specify unified requirements on isothermal brittle crack arrest test procedure to evaluate CAT of BCA steels.

Specify unified requirements on the manufacturing approval scheme of BCA steels.

Specify unified requirements on product inspection of BCA steels.

### **3 List of non-IACS Member classification societies contributing through the TC Forum and/or participating in IACS Working Group:**

None

### **4 History of Decisions Made:**

Members agreed that the grade of BCA steels is generally only "EH" considering the past actual records of application of BCA steels of the Classification Societies.

Members agreed that the thickness range of BCA steels is over 50mm and up to 100mm considering the consistency between UR W31 and UR S33.

The majority of Hull Panel agreed to the following items in response to the EG/MW's inquiry concerned:

(a) Required Kca for BCA steels with thickness exceeding 80mm and up to 100mm are as follows:

- Upper deck: required Kca is to be  $6,000\text{N/mm}^{3/2}$  or over at -10 degree C
- Hatch side coaming: required Kca is to be  $8,000\text{N/mm}^{3/2}$  or over at -10 degree C

(b) Large-scale structural model test conditions are reasonable

(c) Requirements of YP36 BCA steels should be specified in UR W31.

Members and Hull Panel agreed that the specific required brittle crack arrest properties for each the structural member (i.e. upper deck and hatch side coaming) are to be specified in UR S33.

Members agreed that only the material specifications of brittle crack arrest properties are specified in UR W31.

Members agreed unified requirements on isothermal brittle crack arrest test procedure to evaluate CAT of BCA steels and the specific CAT criteria.

### **5 Other Resolutions Changes**

None

### **6 Any hinderance to MASS, including any other new technologies:**

None

## **7 Dates:**

Original Proposal: 28 July 2016 (Made by: EG M&W Member)

Panel Approval: 11 February 2019

GPG Approval: 3 December 2019 (Ref: 15198\_IGe)

## **• Rev.1 (Sept 2015)**

### **1 Origin of Change:**

- Suggestion by an IACS member

### **2 Main Reason for Change:**

Amend UR W31 by removing design related content and transferring this to UR S33.

Amend UR W31 by transferring material related content from UR S33.

### **3 List of non-IACS Member classification societies contributing through the TC Forum and/or participating in IACS Working Group:**

None

### **4 History of Decisions Made:**

Members concurred that annex 2 standard ESSO test in UR S33 should be transferred to UR W31. Also they agreed that the paragraph 2.1 hull structures (design) should be transferred from UR W31 to UR S33.

One member proposed to include double tension test for CAT as Annex 2 of UR W31 and to determine the required Kca value for the steel exceeding 80mm. Members agreed that this task should be transferred to EG/M&W.

Panel agreed that the crack arrest properties for brittle design should be transferred from UR S33 and defined in UR W31. Two members indicated that they would prefer the crack arrest properties for brittle design should be included in UR S33.

Panel approved that the ownership of UR W31 should be transferred to EG/M&W.

No TB is expected for the present revision.

### **5 Other Resolutions Changes**

None.

## **6 Dates:**

Original Proposal: 20 September 2013 made by: Panel Member

Panel Approval: 09 July 2015 (Ref: PH13026\_IHy)

GPG Approval: 30 September 2015 (Ref: 14139\_IGf)

- **New (Jan 2013)**

**1 Origin of Change:**

- Suggestion by the Japan Society of Naval Architects and Ocean Engineers (JASNAOE)

**2 Main Reason for Change:**

None – new document.

**3 List of non-IACS Member classification societies contributing through the TC Forum and/or participating in IACS Working Group:**

None

**4 History of Decisions Made:**

See technical background.

**5 Other Resolutions Changes**

None

**6 Dates:**

Panel Approval: *26 November 2012 (By Hull Panel)*  
GPG Approval: *21 January 2013 (12215\_IGc)*

## **Part B. Technical Background**

List of Technical Background (TB) documents for UR W32:

Annex 1. **TB for New (Jan 2013)**

See separate TB document in Annex 1.

Annex 2. **TB for Rev.2 (Dec 2019)**

See separate TB document in Annex 2.

Annex 3. **TB for Rev.3 (Mar 2023)**

See separate TB document in Annex 3.

**Note:** *There is no Technical Background (TB) document available for Rev.1 (Sept 2015).*



## **Technical Background (TB) document for UR W31 (New, Jan 2013)**

### **1. Scope and objectives**

An increase in the size of container ships has led to an increase in the thickness of steel materials used, thus causing problem such as making welding work difficult as well as increasing brittle fracture problem. In order to alleviate these problems, YP47 class steel plates has been developed.

YP47 is a new kind of high tensile steel plate. Various kinds of studies are necessary for the application to ship structures.

At the time of October 2010, some classification societies have their own guidelines which need to be unified. And some shipyards already applied YP47 steels in their container ships.

IACS recognized that it is necessary to develop the unified requirements (UR) on the application of YP47 steel plates, rather than amending the existing URs, covering following items;

- HT factor and material selection
- Material specification
- Manufacturing process approval
- Welding consumables
- Welding procedure qualification test(WPQT)
- Others such as welding work, etc.

### **2. Engineering background for technical basis and rationale**

Several issues were highlighted that IACS needed to address:

- a) Considering the application trend of steel thickness for ultra-large container carriers, maximum thickness of YP47 steel plate is to be up to 100mm. For steel plates exceeding 100mm, special consideration is to be given by each Classification Society.
- b) YP47 steel plates are to be applied to longitudinal structural members in the upper deck region of container carriers (such as hatch side coaming, hatch coaming top and the attached longitudinals). Special consideration is to be given to the application of YP47 steels for other hull structures.
- c) Supply condition of YP47 steels is to be TMCP. Other supply condition is to be each classification society's criteria.
- d) The requirements for material specification and manufacturing process approval have been developed based on the UR W11. However the specified min. average impact energy should depend on the thickness of steels.
- e) When YP47 steel plates are used in the longitudinal structural members in the upper deck region of container carriers, it is important that the steel plates possess brittle crack arrestability to prevent brittle crack propagation as a back up function in case a brittle crack unexpectedly occurs. So brittle crack arrest test such as standard ESSO test or CAT (Crack Arrest Temperature) should be conducted in the manufacturing approval test.

- f) Fatigue property of YP47 steels need not be specified because fatigue problems are basically regarded as, not material-related matters, but design-related matters involving details such as structural discontinuities or shape, welded joint, flame cuts, etc. PT52 confirmed that the design S-N curves are applicable to YP47 steel plates as well as YP32, YP36 etc.

Accordingly, in this material-related UR, Section 2.1.2 clarifies that fatigue assessment for structural details is the task of each society.

- g) Brittle fracture initiation test in weldment is meaningless because a notch of the test specimen is placed across WM, HAZ and BM as long as V groove is applied to the actual welding procedures in shipyards and test result will be easily affected by the combination of WM, HAZ and BM on the notch.

Taking the above into account a project team PT52 was asked to draft a new IACS UR, W31, to explain the application, manufacture, testing and certification of these steels.

Based on review comments made during development, the following TB items are noted:

Section 2.5.4: the hardness requirement of 380 Hv is included in this UR. It is noted that the hardness requirement of 420 Hv used in URW28 is for quenched and tempered steel, and the quality control is different from that of hull structural steels. This section also includes the text "as defined in UR W28" which refers to the hardness test method in Annex B of UR W28.

### **3. Source/derivation of the proposed IACS Resolution**

- Application of YP47 steel Plates prepared by PM for discussion in PT52.
- A : Guide for application of higher-strength hull structural thick steel plates in container carriers
- B : Classification notes no. 30.10, Extra high strength steel material NV47 for hull structural application in container ships
- C : Supplementary Rules for Application of Steel with Yield Strength of 460 N/mm<sup>2</sup>
- D : Circular No. 2011-09-E, Instruction for the approval and inspection of YP47 Steel plates used for Large Container Carriers
- E : Guidelines on the Application of YP47 Steel for Hull Structures of Large Container Carriers

### **4. Summary of Changes intended for the revised Resolution:**

Not applicable

### **5. Points of discussions or possible discussions**

None

**6. Attachments if any**

None

## Technical Background (TB) document for UR W31 (Rev.2, Dec 2019)

### 1. Scope and objectives

In UR W31, the requirements of YP47 steels used for large container ships have been specified.

Furthermore, the specific required brittle crack arrest properties of YP47 steels has been specified in UR W31 as follows:

- i)  $K_{ca} \geq 6,000 \text{ N/mm}^{3/2}$  at -10 degree C
- ii) Crack Arrest Temperature (CAT)

Note 1: The specific value of the required Kca has not been specified for brittle crack arrest steels (hereinafter "BCA steels") with thickness exceeding 80mm.

Note 2: The specific required CAT has not been specified.

Apart from the above, the industry demands strongly that the specific required brittle crack arrest toughness for BCA steels with thickness up to 100mm should be specified in IACS UR due to emerging 20,000 TEU-class ultra-large container ships.

Also, the relevant material requirements on manufacturing approval scheme and product inspection of the BCA steels have not been specified in UR W31 whereas the application of the BCA steels has been required for large container ships contracted for construction on or after 1 January 2014.

In light of the above, IACS recognized that it is necessary to amend UR W31 including the following items:

- (a) Specify the required crack arrest toughness Kca for BCA steels with thickness exceeding 80mm and up to 100mm
- (b) Specify the required CAT for BCA steels
- (c) Amend the unified requirements on temperature-gradient brittle crack arrest test procedure to evaluate Kca of BCA steels
- (d) Specify unified requirements on isothermal brittle crack arrest test procedure to evaluate CAT of BCA steels
- (e) Specify unified requirements on the manufacturing approval scheme of BCA steels
- (f) Specify unified requirements on product inspection of BCA steels.

### 2. Engineering background for technical basis and rationale

- (a) Based on the results of verification test using the large-scale structural model test specimens simulating the upper deck region (hatch side coaming and upper deck) of large container ships with 100mm-thick test plates submitted by the Japanese Welding Engineering Society, brittle crack arrest properties as the material specifications are specified in UR W31 as follows:

- i) BCA steels with suffix BCA1:  $K_{ca}$  is  $6,000 \text{ N/mm}^{3/2}$  or over at -10 degree C
- ii) BCA steels with suffix BCA2:  $K_{ca}$  is  $8,000 \text{ N/mm}^{3/2}$  or over at -10 degree C

- (b) Industrial research was undertaken to assess the various parameters and the influence on the CAT values and compatibility with corresponding Kca value. Based on the results of research project related to isothermal brittle crack arrest test

procedure to evaluate CAT and relationship between CAT and Kca, the said test procedure is specified in Annex 4 and specific CAT criteria of BCA1 is specified as - 10 degree C.

It was agreed that specific CAT criteria of BCA2 is to be approved by the Classification Societies.

- (c) The unified requirements on temperature-gradient brittle crack arrest test procedure to evaluate Kca of BCA steels are amended based on Japan Welding Engineering Society Standard of WES 2815:Jan 2014.

### **3. Source/derivation of the proposed IACS Resolution**

Japan Welding Engineering Society Standard of WES 2815:Jan 2014 is referred in order to amend the unified requirements on temperature-gradient brittle crack arrest test procedure to evaluate Kca of BCA steels.

### **4. Summary of Changes intended for the revised Resolution:**

- (a) The required brittle crack arrest toughness Kca for BCA steels with thickness exceeding 50mm and up to 100mm are specified.
- (b) The required Crack Arrest Temperature (CAT) for BCA steels corresponding to Kca = 6000 N/ mm<sup>3/2</sup> is specified.
- (c) The chemical composition of YP47 non-BCA steels is specified.
- (d) The chemical composition and brittle crack arrest properties of BCA steels (YP36, YP40 and YP47 BCA steels) are specified.
- (e) Unified requirements on the manufacturing approval scheme of BCA steels are specified.
- (f) The unified requirements on temperature-gradient brittle crack arrest test procedure to evaluate Kca of BCA steels are amended.
- (g) Unified requirements on isothermal brittle crack arrest test procedure to evaluate CAT of BCA steels are specified.

### **5. Points of discussions or possible discussions**

- (a) In reference to 1.3.3 and Table 3, it was agreed that the thickness range of BCA steels is above 50mm and the thickness range of BCA steels with suffix BCA2 is generally above 80mm considering the ultra large structural test results and the consistency between UR W31 and UR S33.
- (b) In reference to Table 3, it was agreed that brittle crack arrest properties of BCA steels are specified as the material specification in UR W31.
- (c) In reference to 4.1.4, it was agreed that criteria of hardness test in Welding Procedure Qualification Test (WPQT) for YP47 non-BCA steels is changed considering the criteria of hardness test in WPQT for YP460 steels specified in UR W16 and past actual test records of the welding procedure qualification tests.
- (d) In reference to 4.2.1, it was agreed that Welding Procedure Specification (WPS) for the non-BCA steels can applied to the same welding procedure of BCA steels only when heat input is 50kJ/cm or below.
- (e) In reference to 4.2.2, criteria of hardness test in welding procedure qualification test for YP47 BCA steels is specified considering the deference between the

specification of chemical composition of YP47 non-BCA steels and YP47 BCA steels.

- (f) In reference to Table 5 and Table 6, it was agreed that criteria of impact test for welding consumables for YP47 steels is changed in order to harmonize the said criteria for welding consumables and welding procedure qualification test for YP47 steels.

**6. Attachments if any**

None

## **Technical Background (TB) document for UR W31 (Rev.3 Mar 2023)**

### **1. Scope and objectives**

In UR W31, the requirements of YP47 steels used for large container ships have been specified.

The industry is to conduct the brittle crack arrest tests for BCA steels in product testing to assure that their steels obtain the sufficient brittle crack toughness.

Corresponding the above, in UR W31, it is specified that small-scale tests approved by the Classification Society can be used for product testing (batch release testing) as the brittle crack arrest tests for BCA steels.

However, the clear approval scheme of small-scale test method for brittle crack arrest steels has not been specified.

In addition, ISO20064 was published in July 2019 based on WES2815.

In light of the above, IACS recognized that it is necessary to amend UR W31 including the following items:

- 1) Stipulate the approval scheme of small-scale test methods for brittle crack arrest steels
- 2) Update the "Annex 3 Test Method for Brittle Crack Arrest Toughness, Kca" reflecting ISO20064: 2019.

### **2. Engineering background for technical basis and rationale**

- (a) Stipulate the examples of small-scale test method which is used by representative Industries.
- (b) Consideration was given to the various testing methodologies, and concluded that Charpy V Notch test, if proposed as a single test method for small scale testing, is not suitable to provide robust correlation or determination of crack arrest properties
- (c) With regard to the acceptance criterion of brittle crack arrest steels by the small-scale tests and the correlation in brittle crack arrest properties between the calculated values from small scale tests and the brittle crack arrest test results, it was agreed that the industry shall be assured by using the value of twice the standard deviation ( $2\sigma$ ).  
In addition, necessary test plates (i.e. 12 test plates) which can reliably estimate brittle crack arrest properties of brittle crack arrest steels were determined considering the actual data submitted by some industries.
- (d) With regard to the accuracy of correlation in brittle crack arrest properties between the calculated values from small scale tests and the brittle crack arrest test results, it was agreed that the upper limit of value of twice the standard deviation ( $2\sigma$ ) was determined considering the actual data submitted by some industries.

### **3. Source/derivation of the proposed IACS Resolution**

(a) IACS EG/MW Members networks with BCA steel manufacturers and academia has provided valuable research and in-depth studies into the nature and mechanisms of brittle failure, and insight into determination of crack-arrest mechanisms as applied to a variety of manufacturers.

Furthermore, determination of small-scale tests and their correlation with both large-scale testing and statistical formulae has provided a valuable basis for the detailed content within this revised UR W31.

#### **4. Summary of Changes intended for the revised Resolution:**

- (a) Stipulate the approval scheme of small-scale test methods for brittle crack arrest steels
- (b) Update the "Annex 3 Test Method for Brittle Crack Arrest Toughness,  $K_{ca}$ " reflecting ISO20064: 2019.
- (c) Detailed requirements are now provided for acceptable statistical correlations for small scale tests, for both CAT and  $K_{ca}$  values.

#### **5. Points of discussions or possible discussions**

- (a) In reference to Table A5-1 to Table A5-3, it was agreed that these examples of small-scale test method are stipulated for manufacturer's reference and the other test methods which are not stipulated in Annex 5 are also acceptable as small-scale test method.
- (b) In reference to A5.3.3.1, necessary test plates (i.e. 12 test plates) are stipulated to reliably estimate brittle crack arrest properties of brittle crack arrest steels. However, a decrease of the total of the indicated number of test plates may be accepted by the Classification Society as specified in A5.3.3.1.6.
- (c) In reference to A5.3.3.1, A5.3.4.2 and A5.3.5.2, the acceptance criterion of brittle crack arrest steels by the small-scale tests and the correlation in brittle crack arrest properties between the calculated values from small scale tests and the brittle crack arrest test results shall be considered the value of twice the standard deviation ( $2\sigma$ ).
- (d) In reference to A5.3.4.2, the upper limit of value of twice the standard deviation ( $2\sigma$ ) was determined considering the accuracy of correlation in brittle crack arrest properties between the calculated values from small scale tests and the brittle crack arrest test results. Its value when using temperature for brittle crack arrest property was determined that  $2\sigma$  shall not be greater than  $20^\circ\text{C}$ . In other cases (e.g.  $K_{ca}$  value at  $-10^\circ\text{C}$ ), an upper limit of  $2\sigma$  shall be established with the agreement of the Classification Society since it is difficult to determine the equivalent value to the upper limit of value when using temperature.
- (e) In reference to A5.3.5, the acceptance criterion of brittle crack arrest steels by the small-scale tests is to be determined so that regression equation can predict brittle crack arrest properties on safety side, considering the scatter of brittle crack arrest properties from the predicted value by the regression equation as shown in A5.3.5.2. The other methods determining acceptance criterion of brittle crack arrest steels by the small-scale tests are also acceptable if it can predict brittle crack arrest properties on safety side.



- (f) Discussion and considerations were given to the approval test plan (reference A5.4.), with potentially further testing requirements, depending on the results. Decisions would consider a variety of items, examples of which could be:
- (i) data clustering producing a biased correlation curve;
  - (ii) small-scale tests providing a wide variance;
  - (iii) inconclusive small-scale test results.

**6. Attachments if any**

None

**Technical Background (TB) document for UR W31 (New, Jan 2013)****1. Scope and objectives**

An increase in the size of container ships has led to an increase in the thickness of steel materials used, thus causing problem such as making welding work difficult as well as increasing brittle fracture problem. In order to alleviate these problems, YP47 class steel plates has been developed.

YP47 is a new kind of high tensile steel plate. Various kinds of studies are necessary for the application to ship structures.

At the time of October 2010, some classification societies have their own guidelines which need to be unified. And some shipyards already applied YP47 steels in their container ships.

IACS recognized that it is necessary to develop the unified requirements (UR) on the application of YP47 steel plates, rather than amending the existing URs, covering following items;

- HT factor and material selection
- Material specification
- Manufacturing process approval
- Welding consumables
- Welding procedure qualification test(WPQT)
- Others such as welding work, etc.

**2. Engineering background for technical basis and rationale**

Several issues were highlighted that IACS needed to address:

- a) Considering the application trend of steel thickness for ultra-large container carriers, maximum thickness of YP47 steel plate is to be up to 100mm. For steel plates exceeding 100mm, special consideration is to be given by each Classification Society.
- b) YP47 steel plates are to be applied to longitudinal structural members in the upper deck region of container carriers (such as hatch side coaming, hatch coaming top and the attached longitudinals). Special consideration is to be given to the application of YP47 steels for other hull structures.
- c) Supply condition of YP47 steels is to be TMCP. Other supply condition is to be each classification society's criteria.
- d) The requirements for material specification and manufacturing process approval have been developed based on the UR W11. However the specified min. average impact energy should depend on the thickness of steels.
- e) When YP47 steel plates are used in the longitudinal structural members in the upper deck region of container carriers, it is important that the steel plates possess brittle crack arrestability to prevent brittle crack propagation as a back up function in case a brittle crack unexpectedly occurs. So brittle crack arrest test such as standard ESSO test or CAT (Crack Arrest Temperature) should be conducted in the manufacturing approval test.
- f) Fatigue property of YP47 steels need not be specified because fatigue problems are basically regarded as, not material-related matters, but design-related matters involving details such as structural discontinuities or shape, welded joint, flame cuts, etc. PT52 confirmed that the design S-N curves are applicable to YP47 steel plates as well as YP32, YP36 etc.

Accordingly, in this material-related UR, Section 2.1.2 clarifies that fatigue assessment for structural details is the task of each society.

- g) Brittle fracture initiation test in weldment is meaningless because a notch of the test specimen is placed across WM, HAZ and BM as long as V groove is applied to the actual welding procedures in shipyards and test result will be easily affected by the combination of WM, HAZ and BM on the notch.

Taking the above into account a project team PT52 was asked to draft a new IACS UR, W31, to explain the application, manufacture, testing and certification of these steels.

Based on review comments made during development, the following TB items are noted:

Section 2.5.4: the hardness requirement of 380 Hv is included in this UR. It is noted that the hardness requirement of 420 Hv used in URW28 is for quenched and tempered steel, and the quality control is different from that of hull structural steels. This section also includes the text "as defined in UR W28" which refers to the hardness test method in Annex B of UR W28.

### **3. Source/derivation of the proposed IACS Resolution**

- Application of YP47 steel Plates prepared by PM for discussion in PT52.
- A : Guide for application of higher-strength hull structural thick steel plates in container carriers
- B : Classification notes no. 30.10, Extra high strength steel material NV47 for hull structural application in container ships
- C : Supplementary Rules for Application of Steel with Yield Strength of 460 N/mm<sup>2</sup>
- D : Circular No. 2011-09-E, Instruction for the approval and inspection of YP47 Steel plates used for Large Container Carriers
- E : Guidelines on the Application of YP47 Steel for Hull Structures of Large Container Carriers

### **4. Summary of Changes intended for the revised Resolution:**

Not applicable

### **5. Points of discussions or possible discussions**

None

### **6. Attachments if any**

None

## Technical Background (TB) document for UR W31 (Rev.2, Dec 2019)

### 1. Scope and objectives

In UR W31, the requirements of YP47 steels used for large container ships have been specified. Furthermore, the specific required brittle crack arrest properties of YP47 steels has been specified in UR W31 as follows:

- i)  $K_{ca} \geq 6,000 \text{ N/mm}^{3/2}$  at -10 degree C
- ii) Crack Arrest Temperature (CAT)

Note 1: The specific value of the required  $K_{ca}$  has not been specified for brittle crack arrest steels (hereinafter "BCA steels") with thickness exceeding 80mm.

Note 2: The specific required CAT has not been specified.

Apart from the above, the industry demands strongly that the specific required brittle crack arrest toughness for BCA steels with thickness up to 100mm should be specified in IACS UR due to emerging 20,000 TEU-class ultra-large container ships.

Also, the relevant material requirements on manufacturing approval scheme and product inspection of the BCA steels have not been specified in UR W31 whereas the application of the BCA steels has been required for large container ships contracted for construction on or after 1 January 2014.

In light of the above, IACS recognized that it is necessary to amend UR W31 including the following items:

- (a) Specify the required crack arrest toughness  $K_{ca}$  for BCA steels with thickness exceeding 80mm and up to 100mm
- (b) Specify the required CAT for BCA steels
- (c) Amend the unified requirements on temperature-gradient brittle crack arrest test procedure to evaluate  $K_{ca}$  of BCA steels
- (d) Specify unified requirements on isothermal brittle crack arrest test procedure to evaluate CAT of BCA steels
- (e) Specify unified requirements on the manufacturing approval scheme of BCA steels
- (f) Specify unified requirements on product inspection of BCA steels.

### 2. Engineering background for technical basis and rationale

- (a) Based on the results of verification test using the large-scale structural model test specimens simulating the upper deck region (hatch side coaming and upper deck) of large container ships with 100mm-thick test plates submitted by the Japanese Welding Engineering Society, brittle crack arrest properties as the material specifications are specified in UR W31 as follows:

- i) BCA steels with suffix BCA1:  $K_{ca}$  is  $6,000 \text{ N/mm}^{3/2}$  or over at -10 degree C
- ii) BCA steels with suffix BCA2:  $K_{ca}$  is  $8,000 \text{ N/mm}^{3/2}$  or over at -10 degree C

- (b) Industrial research was undertaken to assess the various parameters and the influence on the CAT values and compatibility with corresponding  $K_{ca}$  value. Based on the results of research project related to isothermal brittle crack arrest test procedure to evaluate CAT and relationship between CAT and  $K_{ca}$ , the said test procedure is specified in Annex 4 and specific CAT criteria of BCA1 is specified as -10 degree C.

It was agreed that specific CAT criteria of BCA2 is to be approved by the Classification Societies.

- (c) The unified requirements on temperature-gradient brittle crack arrest test procedure to evaluate Kca of BCA steels are amended based on Japan Welding Engineering Society Standard of WES 2815:Jan 2014.

### **3. Source/derivation of the proposed IACS Resolution**

Japan Welding Engineering Society Standard of WES 2815:Jan 2014 is referred in order to amend the unified requirements on temperature-gradient brittle crack arrest test procedure to evaluate Kca of BCA steels.

### **4. Summary of Changes intended for the revised Resolution:**

- (a) The required brittle crack arrest toughness Kca for BCA steels with thickness exceeding 50mm and up to 100mm are specified.
- (b) The required Crack Arrest Temperature (CAT) for BCA steels corresponding to  $Kca = 6000 \text{ N/mm}^{3/2}$  is specified.
- (c) The chemical composition of YP47 non-BCA steels is specified.
- (d) The chemical composition and brittle crack arrest properties of BCA steels (YP36, YP40 and YP47 BCA steels) are specified.
- (e) Unified requirements on the manufacturing approval scheme of BCA steels are specified.
- (f) The unified requirements on temperature-gradient brittle crack arrest test procedure to evaluate Kca of BCA steels are amended.
- (g) Unified requirements on isothermal brittle crack arrest test procedure to evaluate CAT of BCA steels are specified.

### **5. Points of discussions or possible discussions**

- (a) In reference to 1.3.3 and Table 3, it was agreed that the thickness range of BCA steels is above 50mm and the thickness range of BCA steels with suffix BCA2 is generally above 80mm considering the ultra large structural test results and the consistency between UR W31 and UR S33.
- (b) In reference to Table 3, it was agreed that brittle crack arrest properties of BCA steels are specified as the material specification in UR W31.
- (c) In reference to 4.1.4, it was agreed that criteria of hardness test in Welding Procedure Qualification Test (WPQT) for YP47 non-BCA steels is changed considering the criteria of hardness test in WPQT for YP460 steels specified in UR W16 and past actual test records of the welding procedure qualification tests.
- (d) In reference to 4.2.1, it was agreed that Welding Procedure Specification (WPS) for the non-BCA steels can applied to the same welding procedure of BCA steels only when heat input is 50kJ/cm or below.
- (e) In reference to 4.2.2, criteria of hardness test in welding procedure qualification test for YP47 BCA steels is specified considering the deference between the specification of chemical composition of YP47 non-BCA steels and YP47 BCA steels.
- (f) In reference to Table 5 and Table 6, it was agreed that criteria of impact test for welding consumables for YP47 steels is changed in order to harmonize the said criteria for welding consumables and welding procedure qualification test for YP47 steels.

### **6. Attachments if any**

None

## **Technical Background (TB) document for UR W31 (Rev.3 Mar 2023)**

### **1. Scope and objectives**

In UR W31, the requirements of YP47 steels used for large container ships have been specified.

The industry is to conduct the brittle crack arrest tests for BCA steels in product testing to assure that their steels obtain the sufficient brittle crack toughness.

Corresponding the above, in UR W31, it is specified that small-scale tests approved by the Classification Society can be used for product testing (batch release testing) as the brittle crack arrest tests for BCA steels.

However, the clear approval scheme of small-scale test method for brittle crack arrest steels has not been specified.

In addition, ISO20064 was published in July 2019 based on WES2815.

In light of the above, IACS recognized that it is necessary to amend UR W31 including the following items:

- 1) Stipulate the approval scheme of small-scale test methods for brittle crack arrest steels
- 2) Update the "Annex 3 Test Method for Brittle Crack Arrest Toughness, Kca" reflecting ISO20064: 2019.

### **2. Engineering background for technical basis and rationale**

- (a) Stipulate the examples of small-scale test method which is used by representative Industries.
- (b) Consideration was given to the various testing methodologies, and concluded that Charpy V Notch test, if proposed as a single test method for small scale testing, is not suitable to provide robust correlation or determination of crack arrest properties
- (c) With regard to the acceptance criterion of brittle crack arrest steels by the small-scale tests and the correlation in brittle crack arrest properties between the calculated values from small scale tests and the brittle crack arrest test results, it was agreed that the industry shall be assured by using the value of twice the standard deviation ( $2\sigma$ ).  
In addition, necessary test plates (i.e. 12 test plates) which can reliably estimate brittle crack arrest properties of brittle crack arrest steels were determined considering the actual data submitted by some industries.
- (d) With regard to the accuracy of correlation in brittle crack arrest properties between the calculated values from small scale tests and the brittle crack arrest test results, it was agreed that the upper limit of value of twice the standard deviation ( $2\sigma$ ) was determined considering the actual data submitted by some industries.

### **3. Source/derivation of the proposed IACS Resolution**

(a) IACS EG/MW Members networks with BCA steel manufacturers and academia has provided valuable research and in-depth studies into the nature and mechanisms of brittle failure, and insight into determination of crack-arrest mechanisms as applied to a variety of manufacturers.

Furthermore, determination of small-scale tests and their correlation with both large-scale testing and statistical formulae has provided a valuable basis for the detailed content within this revised UR W31.

### **4. Summary of Changes intended for the revised Resolution:**

- (a) Stipulate the approval scheme of small-scale test methods for brittle crack arrest steels
- (b) Update the "Annex 3 Test Method for Brittle Crack Arrest Toughness,  $K_{ca}$ " reflecting ISO20064: 2019.
- (c) Detailed requirements are now provided for acceptable statistical correlations for small scale tests, for both CAT and  $K_{ca}$  values.

### **5. Points of discussions or possible discussions**

- (a) In reference to Table A5-1 to Table A5-3, it was agreed that these examples of small-scale test method are stipulated for manufacturer's reference and the other test methods which are not stipulated in Annex 5 are also acceptable as small-scale test method.
- (b) In reference to A5.3.3.1, necessary test plates (i.e. 12 test plates) are stipulated to reliably estimate brittle crack arrest properties of brittle crack arrest steels. However, a decrease of the total of the indicated number of test plates may be accepted by the Classification Society as specified in A5.3.3.1.6.
- (c) In reference to A5.3.3.1, A5.3.4.2 and A5.3.5.2, the acceptance criterion of brittle crack arrest steels by the small-scale tests and the correlation in brittle crack arrest properties between the calculated values from small scale tests and the brittle crack arrest test results shall be considered the value of twice the standard deviation ( $2\sigma$ ).
- (d) In reference to A5.3.4.2, the upper limit of value of twice the standard deviation ( $2\sigma$ ) was determined considering the accuracy of correlation in brittle crack arrest properties between the calculated values from small scale tests and the brittle crack arrest test results. Its value when using temperature for brittle crack arrest property was determined that  $2\sigma$  shall not be greater than  $20^\circ\text{C}$ . In other cases (e.g.  $K_{ca}$  value at  $-10^\circ\text{C}$ ), an upper limit of  $2\sigma$  shall be established with the agreement of the Classification Society since it is difficult to determine the equivalent value to the upper limit of value when using temperature.
- (e) In reference to A5.3.5, the acceptance criterion of brittle crack arrest steels by the small-scale tests is to be determined so that regression equation can predict brittle crack arrest properties on safety side, considering the scatter of brittle crack arrest properties from the predicted value by the regression equation as shown in A5.3.5.2. The other methods determining acceptance criterion of brittle crack

arrest steels by the small-scale tests are also acceptable if it can predict brittle crack arrest properties on safety side.

- (f) Discussion and considerations were given to the approval test plan (reference A5.4.), with potentially further testing requirements, depending on the results. Decisions would consider a variety of items, examples of which could be:
- (i) data clustering producing a biased correlation curve;
  - (ii) small-scale tests providing a wide variance;
  - (iii) inconclusive small-scale test results.

**6. Attachments if any**

None



## UR W32 “Qualification scheme for welders of hull structural steels”

### Summary

This revision is primarily for coping with the concern raised by a shipyards' association on the revalidation of qualification for welders.

### Part A. Revision History

Version no.	Approval date	Implementation date when applicable
Rev.1 (Sep 2020)	1 September 2020	1 January 2022
New (Sep 2016)	18 September 2016	1 January 2018

#### • Rev.1 (Sep 2020)

##### 1 Origin of Change:

- Request by non-IACS entity (*KOSHIPA*)
- Suggestion by IACS member

##### 2 Main Reason for Change:

Add one more option of revalidation measure of the qualification for welders apart from article 6.2.1.a) and 6.2.1.b), based on the request by KOSHIPA and the reservations made by two IACS Members as well.

##### 3 List of non-IACS Member classification societies contributing or participating in IACS Working Group:

None

##### 4 History of Decisions Made:

Since 26<sup>th</sup> Jan.,2017, Korea Offshore & Shipbuilding Association (hereinafter as referred to KOSHIPA in short) repeatedly raised their concerns about implementation of article 6.2.1 and 6.2.2 regarding to revalidation of qualification for welders.

Concerning the same issue, some of IACS Members respectively made their reservations to GPG.

The discussion also took place within EG/M&W and survey panel, GPG's concluded this matter with message 17017\_IGi dated 23 August 2017, with task on EG/M&W to reconsider the inquiries of KOSHIPA's letter as a matter of urgent and identify possible solution.

Based on above-mentioned background and subsequent internal discussion within EG/M&W, revision of article 2.5 and 6.2 of UR W32 has been decided by EG/M&W.

Remarks from some Members invite the expert group to consider the wording of article 5 for possible clarification.

**5 Other Resolutions Changes:**

None

**6 Any hinderance to MASS, including any other new technologies:**

None.

**7 Dates:**

Original Proposal: 23<sup>rd</sup> August 2017 (Made by: IACS GPG)  
Panel Approval: 28 August 2020 (Ref: 17017\_EMWk)  
GPG Approval: 1 September 2020 (Ref: 17017\_IGv)

• **New (Sept 2016)**

**1 Origin for Change:**

Other (Development of a new UR based on existing Rec 104)

**2 Main Reason for Change:**

None

**3 List of non-IACS Member Classification Societies contributing through the TC Forum and/or participating in IACS Working Group:**

None

**4 History of Decisions Made:**

See Form A EG/M&W Task No. EMW1204, minutes of EG/M&W meeting October 2013, September 2014 and September 2015, technical background.

**5 Other Resolutions Changes**

Rec 104 shall be withdrawn upon implementation of this new UR W32.

**6 Dates:**

Original Proposal: November 2013	Made by: EG/M&W Member
Panel Approval: 30 November 2015	(Ref: EMW1204)
GPG Approval: 18 September 2016	(Ref:12108_IGw)

\*\*\*\*\*

## **Part B. Technical Background**

List of Technical Background (TB) documents:

Annex 1. **TB for New (Sep 2016)**

See separate TB document in Annex 1.

Annex 2. **TB for Rev.1 (Sep 2020)**

See separate TB document in Annex 2.



## **Technical Background (TB) document for UR W32 (New Sept 2016)**

### **1. Scope and objectives**

The objective was to develop a new UR concerning Qualification Scheme for Welders based on the existing Rec.104.

This qualification scheme applies to the welders engaged in the welding processes used for the construction of steel ship hull structures, except oxy-acetylene welding and welding of pipes.

### **2. Engineering background for technical basis and rationale**

The IACS Rec.104 has been available and used for many years by industry and classification societies. The application of welder qualifications is an accepted and developed practice in other construction industries and worldwide standards exist. It was agreed to produce an UR based on the experience of Rec 104.

Welder's skill practice is one of the important factors which influence the quality of welds. Examination of welder's skill depends on technical parameters like: welding process / base metal / welding position / type of welded joint, etc.

### **3. Source/derivation of the proposed IACS Resolution**

The revised draft UR was developed from the existing IACS Recommendation 104 "Qualification scheme for welders of steels", and taking into consideration the standards ISO 9606-1 "Qualification testing of welders –Fusion welding – Part 1: Steels" and EN 287-1"Qualification testing of welders –Fusion welding – Part 1: Steels".

### **4. Summary of Changes intended for the revised Resolution:**

Starting from Rec.104, there are some major amendments reviewed as shown below:

- Clarified the applicable strength range of the base metal.
- Agreed that the type of welding consumable is one of the variables for qualification of welders.
- Agreed that some welding processes may be grouped together for welder's qualification testing
- Defined the examination methods for welder engaged in tack welding only.
- Included a typical certificate format.

### **5. Points of discussions or possible discussions**

#### 1. Scope

The range of steel grades covered has been discussed and agreed. The steel grades of URW16 have not been included in the UR as the scope of the UR is steel grades for hull structure.

#### 2. General

Discussion on welding processes usually used in shipyards. Needs for qualification reviewed and agreed for welders engaged in manual welding and semi-automatic welding/partly mechanized welding and operators responsible for setting up and adjustment of fully mechanized and automatic equipment.

### 3. Range of qualification of welders

It has been considered that the welding of structural steel grades with specified minimum yield strength lower or equal to 460 N/mm<sup>2</sup> needed similar welder's skill. It was agreed to group them together.

### 4. Qualification test

Since Rec.104 was issued, it is considered that butt welding may cover fillet welding according to the experienced practice.

A tack welding is usually fused in the structural weld joint. Tack welding may be assigned to dedicated welders in some shipyards or manufacturers. Requirements to qualify tack welders were discussed and agreed.

When used in place of bend tests, the use of ultrasonic testing to replace radiography has been reviewed and has not been considered appropriate in that case.

### 5. Certification

Classification societies practices about cancellation of certificates were reviewed. It was found that some societies allow the shipyard to cancel the welder's qualification directly, but some cancel the welder's qualification after being informed by the shipyard. It has been agreed to keep the practice at the discretion of the classification society.

### 6.2 Maintenance of the approval

The three ways to maintain the certification according to the ISO standard 9606-1 were discussed. Based on current classification societies practices, requalification has been agreed only by testing or recorded evidence of testing.

## **6. Attachments if any**

None

## **Technical Background (TB) document for UR W32 (Rev.1 Sep 2020)**

### **1. Scope and objectives**

IACS UR W32 gives technical requirements and procedures for a qualification scheme for welders intended to engage in the fusion welding of steels as specified in UR W7, W8, W11 and W31 for hull structures.

This qualification scheme does not cover welders engaged in oxy-acetylene welding.

This qualification scheme does not cover welding of pipes and pressure vessels.

### **2. Engineering background for technical basis and rationale**

According to clause 6.2.1 in the UR W32 rev.0 Sept., 2016, there are only 2 maintenance options available for industry in term of revalidation of qualification for welders. While other international standards allow industry to take other maintenance option than in UR W32, such as AWS D1.1, ISO 9606-1 etc. which give more self-control to industry based on their own welder quality management system, in place.

KOSHIPA, representing at least part of the offshore and ship builders in South Korea, raised this concern to IACS, in searching for grant of such maintenance option of revalidation of qualification for welder in IACS UR W32. Which are supported by some IACS members by making reservations.

In light of such industry inquiry and reservations made by IACS members, it is valuable to revisit UR W32, adapting to the current industry practice.

### **3. Source/derivation of the proposed IACS Resolution**

The UR refers to the following IACS resolutions and international standards

IACS UR W2 Rev.2 July 2003 "Test specimens and mechanical testing procedures for materials"

IACS UR W7 Rev.3 May 2004 "Hull and machinery steel forgings"

IACS UR W8 Rev.2 May 2004 "Hull and machinery steel castings"

IACS UR W11 Rev.9 May 2017 "Normal and higher strength hull structural steels"

IACS UR W17 Rev.5 March 2018 "Approval of consumables for welding normal and higher strength hull structural steels"

IACS UR W31 Rev.1 Sept.2015 "Application of YP47 steel plates"

ISO 14732:2013 "Welding personnel -Qualification testing of welding operators and weld setters for mechanized and automatic welding of metallic materials"

ISO 4063:2009 "Welding and allied processes -Nomenclature of processes and reference numbers"

ISO 5817:2014 "Fusion-welded joints in steel, nickel, titanium and their alloys (beam welding excluded)-Quality levels for imperfections"

ISO 9017:2017 "Destructive tests on welds in metallic materials-Fracture test"

**4. Summary of Changes intended for the revised Resolution:**

Main changes are listed as following

- Further limitation of application scope of the UR was added in clause 1.3, with qualification of welders involved in welding of pressure vessel excluded from the UR.

During the discussion of this change, the EG members' attention was drawn to one EU Directive 2014/68/EU, which doesn't allow to apply clause 9.3 c) in ISO 9606-1, which is quite similar as requested by KOSHIPA, for revalidation of qualification for welders welding pressure vessels in categories II, III and IV.

For easy reference, the extract of the correspondence between ISO 9601-1 and EU directive is put below

-Quote-

Table ZA.1 — Correspondence between this European Standard and Directive 2014/68/EU (PED) [2014 OJ L 189]

Essential Requirements of Directive 2014/68/EU (PED)	Clause(s)/sub-clause(s) of this EN	Remarks/Notes
Annex I, 3.1.2	Clauses 5, 6.2 to 6.6, 7, 8, 10, 11	Qualification testing
	Clauses 6.1, 9.1, 9.3 a), 9.3 b)	For pressure equipment in categories II, III and IV the examiner/examining body (according to 3.3 and 3.4) is a competent third party – a notified body or a recognized third party organization.
	Clause 9.3 c)	Not permitted for categories II, III and IV products.

-End quote-

- Section 6.2.1.c) and it's sub-section are newly added in the UR, in order to establish a new maintenance option in term of revalidation of qualification for welders. For the purpose of dealing with KOSHIPA concerns and IACS internal reservation from some of IACS Members, which is primary duty of this revision.
- Some editorial changes take place in Note 2, clause 2.5 , 2.5.1, 2.5.2, 5.1, 6.2.1, 6.2.1.a) for better understanding.
- Clause 1.4 is added, in order to provide a consistency throughout relevant UR's.
- The implementation dates are amended accordingly in Note.
- The amendments in clause 6.1.4 and Annex add the requirement of stating chosen maintenance option of qualification in accordance with 6.2.1.a) or b) or c) on the certificate at the time of issue. which is supported by the intent

outlined in ISO 9606-1, section 9.1 (second paragraph), as quoted as below for easy reference.

-Quote-

*“The validity of the certificate may be extended as specified in 9.3. The chosen method of the extension of qualification in accordance with 9.3, a) or b) or c), shall be stated on the certificate at the time of issue.”*

-End quote-

- All the referred industry standards are revised in format based on IACS Procedures Volume 1, C5.2.1, paragraph 8 protocol as quoted as below: “The following format is to be used for referring to industry standards: [Standard Designation], [version/revision, if applicable], [year of publication] (examples: API Spec 2F (R2015); ISO 4309, 2017), where [version/revision, if applicable] and/or [year of publication] are decided by IACS and are not necessarily to be the current/latest version.”

## **5. Points of discussions or possible discussions**

- After many discussion back and forth within EG/M&W over the newly added clause 6.2.1.c), the group finally agrees on and develops a set of requirements of welder quality management system in the UR, which is to be further consummated by the group based on industry practice.
- Some of EG member raised proposal of using qualified staff of shipyard/manufacturer to verify the welder quality management system defined in 6.2.1.c) of the UR, instead of Society’s surveyor. Currently the group doesn’t take this proposal, considering it is not suitable to be commonly stipulated in the UR, as this approach is at discretion of each Society. However, this proposal might be valuable to be further discussed in the future.
- How the shipyard/manufacturer to manage/control the qualification of the subcontracted welders has been discussing in the group. Which is to be further clarified in the following revision of the UR.
- How to set common criteria of evaluation on the welder performance has been raised and under discussion, it is commonly sensed uneasy to be dealt with at this moment. It is suggested that each Society needs to monitor and share experience at later stage.
- Regarding to “Identification system for welders and WPS used on welds”, which is one requirements of welder quality management system set out in clause 6.2.1.c) II of the UR, there has been a discussion on if the traceability from specific welder to all welds that he/she have performed is necessary. For this revision of the UR, the group concluded that it is not compulsory due to it doesn’t reflect reality in shipyard/manufacturer. However, this requirement of traceability from welder to welds does exist in some industry with high-level safety, so it might be valuable our group re-visit this issue in future.

## **6. Attachments if any**

None.

\*\*\*



## UR W33 – Non-destructive testing of ship hull steel welds

### Summary

The first Revision of the UR W33 developed to introduce the terms and definitions as used in IACS URs. The UR was slightly corrected to align the definition of welding types with the internationally used terminology.

### Part A. Revision History

Version no.	Approval date	Implementation date when applicable
Corr.1 (Aug 2021)	11 August 2021	-
Rev.1 (May 2020)	15 May 2020	1 July 2021
New (Dec 2019)	18 December 2019	1 July 2021

#### Corr.1 (Aug 2021)

##### 1 Origin of Change:

Suggestion by IACS member

##### 2 Main Reason for Change:

The wording "automatic (mechanized)" in paras. 5.8, 6.5.2 and 9.2 needs to be corrected to "automatic or fully mechanized".

##### 3 List of non-IACS Member classification societies contributing or participating in IACS Working Group:

None

##### 4 History of Decisions Made:

Having noted this proposal could be regarded as minor editorial correction to the used wording, it was agreed by EG/M&W without revision of the Resolution.

##### 5 Other Resolutions Changes:

None

##### 6 Any hinderance to MASS, including any other new technologies:

None

##### 7 Dates:

Original Proposal: June 2021

Made by: IACS EG/M&W

EG/M&W Approval: 07 July 2021

GPG Approval: 11 August 2021 (Ref: 13202\_IGzx)

## **Rev.1 (May 2020)**

### **1 Origin of Change:**

Suggestion by IACS member

### **2 Main Reason for Change:**

In order to keep consistency UR W33 needed to be aligned with UR Z23. In these and others IACS resolutions terms "NDT" and "NDE" (which mean the same process), applicate separately without definitions. This circumstance could potentially mislead users and holders of these URs. In order to prevent such cases, the necessary definition was introduced into the text of the UR W33.

### **3 List of non-IACS Member classification societies contributing through the TC Forum and/or participating in IACS Working Group:**

None

### **4 History of Decisions Made:**

Decision was taken to harmonize the "NDT" definition text with the corresponding definition from ISO/TS 18173: 2005 Non-destructive testing — General terms and definitions.

### **5 Other Resolutions Changes:**

UR W35

### **6 Any hinderance to MASS, including any other new technologies:**

None.

### **7 Dates:**

Original Proposal:	January 2020 (IACS Survey Panel)
EG/M&W Approval:	March 2020 (Ref: 13202_EMWo)
GPG Approval:	15 May 2020 (Ref: 13202_IGzs)

## **New (Dec 2019)**

### **1 Origin of Change:**

Suggestion by IACS member

### **2 Main Reason for Change:**

Noting the major importance of NDT in shipbuilding, it was agreed to update and revise the content of IACS Recommendation 20 to develop minimum requirements into a UR.

### **3 List of non-IACS Member classification societies contributing through the TC Forum and/or participating in IACS Working Group:**

No contribution by non-IACS Member classification societies.

### **4 History of Decisions Made:**

Decision was taken to make reference to ISO standards for the NDT techniques used as well as the acceptance levels.

Decision was taken to require approval of the NDT plan for each construction which shall contain the extent of testing and the quality levels.

### **5 Other Resolutions Changes:**

Withdraw IACS Recommendation 20.

Update IACS Recommendation 47 to make reference to this UR.

Update UR Z23 to make reference to this UR.

### **6 Any hinderance to MASS, including any other new technologies:**

None.

### **7 Dates:**

Original Proposal: January 2014 Made by: EG/M&W

EG/M&W Approval: October 2019

GPG Approval: 18 December 2019

## **Part B. Technical Background**

List of Technical Background (TB) documents for UR W33:

Annex 1. **TB for New (Dec 2019)**

See separate TB document in Annex 1.

Annex 2. **TB for Rev.1 (May 2020)**

See separate TB document in Annex 2.

**Note:** There is no separate Technical Background (TB) document for Corr.1 (Aug 2021).

## Technical Background (TB) document for UR W33 (New Dec 2019)

### 1. Scope and objectives

The scope of this UR is to give minimum requirements on the methods and quality levels that are to be adopted for the non-destructive testing (NDT) of ship hull steel welds during new building. The quality levels to be developed refer to production quality and not to fitness- for-purpose of the welds considered.

The objective of this UR is to replace the content of IACS Recommendation 20 by minimum requirements into a UR while assessing if they are sufficient for current ship building.

### 2. Engineering background for technical basis and rationale

The IACS Recommendation 20 has been available for use by Industry classification societies since 1988 and revised in 2007. Noting the major importance of NDT in shipbuilding, it was agreed to update and revise the content of Rec 20 to produce minimum requirements into a UR.

### 3. Source/derivation of the proposed IACS Resolution

The UR was developed from the existing IACS Recommendation 20 "Non-destructive testing of ship hull steel welds". Existing Classification Societies Rules as well as the set of international standards available in the field of NDT have been considered, used and referred to as relevant.

The UR refers to the following international standards:

ISO 4063:2009 "Welding and allied processes -- Nomenclature of processes and reference numbers",

ISO 3452-1:2013 "Non-destructive testing -- Penetrant testing -- Part 1: General principles",

ISO 17638:2016 "Non-destructive testing of welds -- Magnetic particle testing",

ISO 17636-1:2013 "Non-destructive testing of welds -- Radiographic testing -- Part 1: X- and gamma-ray techniques with film",

ISO 17637:2016 "Non-destructive testing of welds -- Visual testing of fusion-welded joints",

ISO 17640:2018 "Non-destructive testing of welds -- Ultrasonic testing -- Techniques, testing levels, and assessment",

ISO 23279:2017 "Non-destructive testing of welds -- Ultrasonic testing -- Characterization of discontinuities in welds",

ISO 11666:2010 "Non-destructive testing of welds -- Ultrasonic testing -- Acceptance levels",

ISO 17635:2016 "Non-destructive testing of welds -- General rules for metallic materials",

ISO 5817:2014 "Welding -- Fusion-welded joints in steel, nickel, titanium and their alloys (beam welding excluded) -- Quality levels for imperfections",

ISO 23277:2015 "Non-destructive testing of welds -- Penetrant testing -- Acceptance levels",

ISO 23278:2015 "Non-destructive testing of welds -- Magnetic particle testing -- Acceptance levels",

ISO 10675-1:2016 "Non-destructive testing of welds -- Acceptance levels for radiographic testing -- Part 1: Steel, nickel, titanium and their alloys",  
ISO 9712:2012 "Non-destructive testing -- Qualification and certification of NDT personnel"

SNT-TC-1A, 2016, Recommended Practice "Personnel Qualification and Certification in Nondestructive Testing"

ASNT-CP-189, 2016 "Standard for Qualification and Certification of Nondestructive Testing Personnel"

#### **4. Summary of Changes intended for the revised Resolution:**

The content of Rec. 20 has been fully reworked and revised with major changes summarised hereafter:

- Update of the scope, base metal, welding processes and weld joints,
- Revised and develop requirements for timing of NDT,
- Update the applicable methods,
- Revised requirements for qualification of personnel,
- Revised and develop requirements for NDT plan,
- Revised and develop requirements for testing techniques,
- Revised and develop requirements for quality levels and acceptance levels for each NDT technique used. The quality levels and acceptance levels are based on recognised international standards.
- Revised and develop requirements for reporting of NDT in each NDT technique.

#### **5. Points of discussions or possible discussions**

The group progressed the work while recognizing that the task is highly complex due to the differences contained in the current Societies Rules.

The group discussed and agreed to avoid to detail the requirements for the testing techniques and agreed to refer to recognized standards.

The group discussed mainly the question of the reference to international standards for the NDT techniques used, the extent of NDTs, the rejection/acceptance criteria and the length of examined portion by UT or RT.

About rejection/acceptance criteria, the group agreed to use reference to the ISO standards using the appropriate acceptance level. About the acceptance levels, it was noted that the acceptance levels in the current Rec 20 are similar to the level C of standard ISO 5817:2014 while it was agreed that it is not possible to match exactly;

The group agreed to not use examples of formula for the number of check points and agreed that the number of checkpoints is to be on the NDT plan;  
The group agreed that the survey activities are to be removed from this UR as survey activities are defined in UR Z23 as far as NDE & NDT of hull welds are concerned;  
Extensive discussions took place about the UT checkpoint length. It was discussed that the UT checkpoint length cannot be regarded independently from the number of checkpoints; the group concluded that it was not possible to find a reasonable consensus to define a minimum requirement and the group defined that a checkpoint length is to be the entire weld length or a length agreed with the Class.

Apart from the UT checkpoint length, it was determined that the RT checkpoint length is 300mm based on the length of a RT film which is generally used.

**6. Attachments if any**

None

## **Technical Background (TB) document for UR W33 (Rev.1 May 2020)**

### **1. Scope and objectives**

The objective of the first Revision of UR W33 is to keep consistency UR W33 needed to be aligned with UR Z23. In these and others IACS resolutions terms "NDT" and "NDE" (which mean the same process), applicate separately without definitions. This circumstance could potentially mislead users and holders of these URs. In order to prevent such cases, the necessary definition was introduced into the text of the UR W33.

### **2. Engineering background for technical basis and rationale**

None

### **3. Source/derivation of the proposed IACS Resolution**

ISO/TS 18173: 2005 Non-destructive testing — General terms and definitions

### **4. Summary of Changes intended for the revised Resolution:**

The content of UR W33 has been supplemented by definitions of NDT and types of NDT.

### **5. Points of discussions or possible discussions**

The group discussed on the proposed variation of definitions.

### **6. Attachments if any**

None



## UR W34 – Advanced non-destructive testing of materials and welds

### Summary

This UR is a new development to provide unified requirements for the advanced non-destructive testing of materials and welds.

### Part A. Revision History

Version no.	Approval date	Implementation date when applicable
New (Dec 2019)	17 December 2019	1 July 2021

- **New (Dec 2019)**

#### 1 Origin of Change:

Suggestion by IACS member

#### 2 Main Reason for Change:

Noting that advanced non-destructive testing (NDT) techniques like Phased Array Ultrasonic Testing (PAUT) or Digital Radiography (RT-D) are more and more used by the industry, it has been agreed to develop unified requirements (UR) on the application of advanced non-destructive testing (NDT) techniques.

#### 3 List of non-IACS Member classification societies contributing through the TC Forum and/or participating in IACS Working Group:

No contribution by non-IACS Member classification societies.

#### 4 History of Decisions Made:

Members agreed that the UR shall focus on PAUT, TOFD and RT-D.

Members agreed that Manual PAUT is not covered in the UR as there is no encoder to record the locations, noting that it is consistent with the ISO standard.

Decision was taken to make reference to ISO standards for the NDT techniques used as well as the acceptance levels.

#### 5 Other Resolutions Changes:

None

**6 Any hinderance to MASS, including any other new technologies:**

None.

**7 Dates:**

Original Proposal: November 2016    Made by: EG M&W  
EG M&W Approval: October 2019  
GPG Approval:        17 December 2019 (Ref: 19100\_IGf)

## **Part B. Technical Background**

List of Technical Background (TB) documents:

Annex 1. **TB for New (Dec 2019)**

See separate TB document in Annex 1.



## Technical Background (TB) document for UR W34 (New Dec 2019)

### 1 Scope and objectives

Nowadays, advanced non-destructive testing (NDT) techniques (Phased Array Ultrasonic Testing (PAUT), Time of Flight Diffraction (TOFD) and Automated Ultrasonic Testing (AUT), etc) are being more and more applied by the industry and IACS members in the day-to-day survey and inspections. There is a growing need from the industry for uniform rules and standards to be developed and applied.

All Members agreed that the application of advanced non-destructive testing technology is very important for IACS future development, and such issue was strategic and in IACS' interest, thus unanimously supported the initiatives. In the same time, IACS recognized that it is necessary to develop the unified requirements (UR) on the application of advanced non-destructive testing (NDT) techniques.

New UR covered following techniques;

- PAUT (only automated/semi-automated PAUT)
- TOFD
- Digital Radiography (RT-D)

### 2 Engineering background for technical basis and rationale

Several issues were highlighted that IACS needed to address:

- a) More and more advanced NDT methods are used in shipbuilding, but the basic requirements are not covered in the IACS resolutions.
- b) In UR S33 mentions *enhanced NDT particularly time of flight diffraction (TOFD) technique*, but the detailed requirements are not provided by IACS.
- c) Using PAUT, TOFD or RT-D in lieu of RT or UT becomes a trend in development of NDT work, especially in pipeline welds testing, extremely thickness butt plate welds testing and etc.
- d) When using PAUT examine austenitic stainless steels, Special probe, calibration / reference blocks and setup should be used, such as Dual Matrix Array probe with longitudinal wave. These equipment, blocks and setup should be qualified with classification society when doing Procedure Qualification.

Taking the above into account a project team PT EMW1609 was asked to draft a new IACS UR to explain the basic requirements of testing methods, procedure approval, testing requirements, acceptance levels and etc.

### 3 Source/derivation of the proposed IACS Resolution

The primary reference standards for new UR *Advanced non-destructive testing of materials and welds* are as following:

- ISO 4063:2009 "Welding and allied processes -- Nomenclature of processes and reference numbers"
- ISO 13588:2019 "Non-destructive testing of welds -Ultrasonic testing-Use of automated phased array technology"
- ISO 18563-1:2015 "Non-destructive testing—Characterization and verification of ultrasonic phased array equipment—Part 1"
- ISO 18563-2:2017 "Non-destructive testing -- Characterization and verification of ultrasonic phased array equipment -- Part 2: Probes"
- ISO 18563-3:2015 "Non-destructive testing—Characterization and verification of ultrasonic phased array equipment-Part 3"
- ISO 19285:2017 "Non-destructive testing of welds -- Phased Array technique (PA) -- Acceptance levels"
- ISO 10863:2011 "Non-destructive testing of welds—Ultrasonic testing—Use of time-of-flight diffraction technique (TOFD)"
- ISO 15626:2018 "Non-destructive testing of welds — time of flight diffraction technique (TOFD)—Acceptance levels"

- ISO 17636-2:2013 "Non-destructive testing of welds - Radiographic testing Part 2: X- and gamma-ray techniques with digital detectors"
- ISO 5817:2014 "Welding -- Fusion-welded joints in steel, nickel, titanium and their alloys (beam welding excluded) -- Quality levels for imperfections"
- ISO 10042:2018 "Welding -- Arc-welded joints in aluminium and its alloys -- Quality levels for imperfections"
- ISO 10675-1:2016 "Non-destructive testing of welds -- Acceptance levels for radiographic testing -- Part 1: Steel, nickel, titanium and their alloys"
- ISO 10675-2:2017 "Non-destructive testing of welds -- Acceptance levels for radiographic testing -- Part 2: Aluminium and its alloys"
- ISO 9712:2012 "Non-destructive testing -- Qualification and certification of NDT personnel"
- SNT-TC-1A, 2016, Recommended Practice "Personnel Qualification and Certification in Nondestructive Testing"
- ASNT-CP-189, 2016 "Standard for Qualification and Certification of Nondestructive Testing Personnel"

#### **4 Summary of Changes intended for the revised Resolution**

Not applicable.

#### **5 Points of discussions or possible discussions**

- a) In section 2.5.1, PAUT was specified on only automated / semi-automated PAUT.
- b) Applicable PAUT for testing of the different types of materials and weld joints are given in Table 2. Especially the following materials and weld joints.
  - Ferritic cruciform joints with full penetration
  - Austenitic stainless steel butt welds with full penetration
  - Austenitic stainless steel tee joints, corner joints with full penetration
  - Aluminium cruciform joints with full penetration
- c) In section 7.2.2.6, Indications detected when applying testing procedure shall be evaluated either by length and height or by length and maximum amplitude.
- d) Section 6.3.2 describes the requirement of angles of incidence. When testing is carried out with transverse waves and techniques that require the ultrasonic beam to be reflected from an opposite surface, care shall be taken to ensure that the angle between the beam and the normal to the opposite reflecting surface is between 35° and 70°. Where more than one probe angle is used, at least one of the angle probes used shall conform with this requirement. One of the probe angles used shall ensure that the weld fusion faces are examined at, or as near as possible to, normal incidence. When the use of two or more probe angles is specified, the difference between the nominal beam angles shall be 10° or greater.

During its meeting of September 2019, the EG M&W agreed to exclude the reference to offshore and repair from the scope of the UR. The group agreed to exclude UR W22 from the scope and to start a task on the revision of UR W22 to include a reference to UR W34 or to develop appropriate requirements for PAUT of offshore chain cable links.

Additional details may be consulted in the following documents made available to the EG M&W Members;

- a) Codes and standards list ( EMW1609 )
- b) PT EMW012016 (EMW1609) 1st MEETING MINUTES
- c) PT EMW012016 (EMW1609) 2nd MEETING MINUTES
- d) Revision suggestions for IACS Resolutions

#### **6 Attachments if any**

None

\*\*\*

## UR W35 “Requirements for NDT Service Suppliers”

### Summary

This latest revision (revision 1) of IACS UR W35 addresses issues raised by the NDT industry regarding implementation of this UR W35, particularly regarding level 3 supervisor.

This UR has been revised to address this item, and other changes afforded by this revision are summarised thus:

- UR document title changes to: ‘Requirements for NDT Service Suppliers’.
- Updated standards references.
- Revisions to scope, applicability, and definitions of NDT service supplier.
- Revisions to employer-based certification route for level 3 supervisor.
- Revisions to terms and definitions.
- Provision for an alternative route for level 2 supervisor.
- Clarified (and revised) level 3 supervisor responsibilities.
- Requirement upon the Class Society to verify the compliance with this UR
- Allowance for the NDT Service Supplier to also satisfy the requirements of a Type C inspection body, as per ISO/IEC 17020:2012, with the stipulation that production staff shall not be allowed to inspect their own work in the case of Type C).

### Part A. Revision History

Version no.	Approval date	Implementation date when applicable
Rev. 1 (October 2023)	20 October 2023	1 January 2025
New (June 2019)	27 June 2019	1 July 2020

#### • Rev. 1 (October 2023)

##### 1 Origin of Change:

- ✓ Other (Specify: Industry best practice and feedback from industry)

##### 2 Main Reason for Change:

1. Provision for an alternative route for level 2 supervisor.
2. Revisions to scope, applicability, and definitions of NDT service supplier.
3. To reflect feedback from various shipyards (and industry) received by Class Societies.

##### 3 List of non-IACS Member classification societies contributing or participating in IACS Working Group:

None.

#### **4 History of Decisions Made:**

1. September 2019, EG/M&W annual meeting. One Society requested that this topic should be discussed further regarding the applicability and scope of the UR.
2. Q4, 2019, the task was formally approved by IACS GPG.
3. September 2020, EG/M&W annual meeting: one Society requested that this topic should be discussed further, as industry (and Class Society) feedback suggested that some NDT companies were having practical difficulties in implementing the UR, particularly with the level 3 supervisor requirements.
4. The topic was further discussed, and the task lead changed to the Society who proposed the implementation feedback. The Form A was revised and re-issued, and GPG approved the revised Form A on 20 October 2021.
5. The task was prolonged to reach consensus amongst members, including meetings, feedback, and discussions with the IACS Survey Panel.
6. Full consensus was reached in July 2023.
7. Fourteen drafts have been discussed by the group.
8. Summary of topics that have been revised and updated during this task:
  - Revised scope and applicability of the UR with respect to products, shipyards, and new construction.
  - A decision was taken to limit the applicability of the UR to new construction (although individual Societies may also adopt the requirements for existing ships if they so wish).
  - UR document title changes to: 'Requirements for NDT Service Suppliers'.
  - Updated standards reference.
  - Revisions to employer-based certification route for level 3 supervisor.
  - Revisions to terms and definitions.
  - Provision for an alternative route for level 2 supervisor.
  - Clarified (and revised) level 3 supervisor responsibilities.
  - Requirement upon the Class Society to verify the compliance with this UR (although the method of verification is to be decided by each Society).
  - Allowance for the NDT Service Supplier to also satisfy the requirements of a Type C inspection body, as per ISO/IEC 17020:2012, with the stipulation that production staff shall not be allowed to inspect their own work in the case of Type C).

9. Discussions took place during the reviews for the items as stated in the Technical Background.

## 5 Other Resolutions Changes:

UR W33 Rev 1 Corr.1 – Non-destructive testing of ship hull steel welds

UR W34 - Advanced non-destructive testing of materials and welds

## 6 Any hinderance to MASS, including any other new technologies:

None.

## 7 Dates:

Original Proposal:	September 2019	Made by: EG/M&W
Panel Approval:	02 October 2023	Ref: 14165_EMWg
GPG Approval:	20 October 2023	Ref: 14165_IGq

## • New (June 2019)

### 1 Origin of Change:

Suggestion by IACS member

### 2 Main Reason for Change:

Considering the importance of non-destructive testing to ensure that the required quality in manufacturing and assembling is achieved, IACS has decided to develop unified requirements to set a common way of handling the firms supplying NDT services and the qualification of their operators.

### 3 List of non-IACS Member classification societies contributing through the TC Forum and/or participating in IACS Working Group:

No contribution by non-IACS Member classification societies.

### 4 History of Decisions Made:

- Discussions took place about the need to develop additional requirements to the existing national or international schemes for qualification of NDT operators. Decision was taken to use the existing national or international schemes as basis without supplementary requirements.
- Discussions took place about the need to develop a scheme to recognise the NDT suppliers. Having consulted the IACS Survey Panel, the Members decided to develop requirements for NDT suppliers without requiring a specific certification scheme, leaving the matter to individual societies.
- Noting the final content of the UR, Members decided to develop a separate UR instead of proposing an amendment to UR Z17.



- One member considered that the document should be a recommendation while the majority of members decided to issue it as an UR.

**5 Other Resolutions Changes:**

None.

**6 Any hinderance to MASS, including any other new technologies:**

None.

**7 Dates:**

Original Proposal:	November 2014	Made by: EG M&W
EG M&W Approval:	10 May 2019	Ref: 14165_EMWd
GPG Approval:	27 June 2019	Ref: 14165_IGI

\*\*\*\*\*

## **Part B. Technical Background**

List of Technical Background (TB) documents for UR W35:

Annex 1. **TB for NEW (June 2019)**

See separate TB document in Annex 1.

Annex 2. **TB for Rev. 1 (Oct 2023)**

See separate TB document in Annex 2.



## **Technical Background (TB) document for UR W35 (NEW June 2019)**

### **1. Scope and objectives**

Suppliers providing NDT (Non-Destructive Testing) services on ship and offshore structures/components subject to classification, need to fulfil the requirements set out in this UR.

The objective of this UR is to ensure that the Supplier is using appropriate procedures, has qualified and certified personnel and has implemented written procedures for training, experience, education, examination, certification, performance, application, control, verification and reporting of NDT. In addition, the Supplier shall furnish appropriate equipment and facilities commensurate with providing a professional service.

### **2. Engineering background for technical basis and rationale**

Considering the importance of NDT to ensure the integrity of a construction, and that in many cases NDT are carried out by companies contracted by the shipbuilders or manufacturers, the IACS members considered that it was necessary to develop IACS minimum requirements for NDT suppliers and operators.

Considering the maturity of existing schemes in Industry, these requirements are not intended to replace the recognised approval schemes used today.

The UR describes the minimum requirements for suppliers of NDT services with reference to quality management, documentation, qualification of personnel, supervision, equipment, sub-contracting, reporting, etc.

### **3. Source/derivation of the proposed IACS Resolution**

Especially with reference to the qualification and certification of NDT personnel reference to the international standard ISO 9712:2012 is made.

Reference is also made to:

SNT-TC-1A, 2016, Recommended Practice "Personnel Qualification and Certification in Nondestructive Testing"

ASNT-CP-189, 2016 "Standard for Qualification and Certification of Nondestructive Testing Personnel"

Reference is made to international standards ISO/IEC 17020:2012, ISO/IEC 17024:2012 and ISO 9001:2015 for quality management matters.

### **4. Summary of Changes intended for the revised Resolution:**

Not applicable – new document

### **5. Points of discussions or possible discussions**

During the development the main discussion points were

- if the resolution is going to be a separate UR or a part of UR Z17 (decision was finally to have a separate UR)
- if an approval/certification procedure will be included in the UR (after rejection of the Survey Panel it was finally decided not to include such a procedure)

**6. Attachments if any**

None.

\*\*\*

## **Technical Background (TB) document for UR W35 (Rev.1 October2023)**

### **1. Scope and objectives**

The objective of this revised UR is to provide a practical way for industry to fully implement NDT services in the marine industry (with a focus on new construction activities), particularly concerning the level 3 supervisor responsibilities and duties within an NDT service supplier organisation.

Thus, the overall aim of this revision was to provide industry with a practical way forward to comply with IACS requirements, in order to deliver a professional NDT service, which shall be verified by the Classification Society.

The objectives of the task were to:

1. Review information from all Class Societies, where they have received feedback questioning the requirements of UR W35.
2. Clarify (and revise where deemed appropriate) the scope of the UR in terms of what it applies to, and clarify the definition of NDT Service Supplier (i.e. who is deemed to be a service supplier according to this UR)
3. Consider the role of level 3 supervisor, in terms of role, duties and responsibilities, certification route, and whether it is considered as a knowledge activity, an organisational role activity, or both.
4. Where necessary, consider updating other IACS Resolutions (e.g., UR W33 and UR W34).

### **2. Engineering background for technical basis and rationale**

During the revision of this UR W33 Rev 1, it was necessary to consider the following technical points:

1. Scope and applicability of the UR.
2. Certification route of employer-based level 3 (now revised to allow certification for a full-time employed level 3 via the examination method).
3. The practical considerations (and requirements) for allowing a supervisor to be employed as a full-time level 2 (via an alternative route to be agreed with the Classification Society) – noting that some smaller organisations may not easily obtain level 3 personnel (for a variety of reasons, including geographical location, size of company, etc.)
4. Limited to new construction, and applicability within a revised scope
5. Not mandatory applicable to internal department of equipment and material manufacturers (although an individual Class Society may apply this UR to such manufacturers)

6. The requirement for a Class Society to verify the compliance with this UR (although the method of verification is to be decided by each Society).

### **3. Source/derivation of the proposed IACS Resolution**

- ISO 9712:2021; Non-destructive testing-Qualification and certification of NDT personnel
- ISO/IEC 17020:2012; Conformity assessment-Requirements for the operation of various types of bodies performing inspection
- ISO/IEC 17024:2012; Conformity assessment-General requirements for bodies operating certification of persons
- ISO 9001:2015; Quality Management Systems-Requirements
- SNT-TC-1A: 2020; Personnel Qualification and Certification in Nondestructive Testing
- ANSI/ASNT CP-189:2020; ASNT Standard for Qualification and Certification of Nondestructive Testing Personnel

### **4. Summary of Changes intended for the revised Resolution:**

- Revised scope and applicability of the UR with respect to products, shipyards, and new construction.
- A decision was taken to limit the applicability of the UR to new construction (although individual Societies may also adopt the requirements for existing ships if they so wish).
- UR document title changes to: 'Requirements for NDT Service Suppliers'.
- Updated standards references.
- Revisions to employer-based certification route for level 3 supervisor.
- Revisions to terms and definitions.
- Provision for an alternative route for level 2 supervisor.
- Clarified (and revised) level 3 supervisor responsibilities.
- Requirement upon the Class Society to verify the compliance with this UR (although the method of verification is to be decided by each Society).
- Allowance for the NDT Service Supplier to also satisfy the requirements of a Type C inspection body, as per ISO/IEC 17020:2012, with the stipulation that production staff shall not be allowed to inspect their own work in the case of Type C).

## 5. Points of discussions or possible discussions

Members had involved discussions with the following points, which also involved IACS Survey Panel (hence there were fourteen drafts produced).

- separating these requirements from UR Z17 and no inference in mandating a Class Approval Scheme for NDT companies – although there is now a requirement upon the Class Society to verify the compliance with this UR (the method of verification is to be decided by each Society).
- The NDT supplier is now deemed to be an 'NDT Service Supplier', although no requirements as per UR Z17. (the title of this revised UR also reflects this change).
- Whether or not to extend the scope of UR W35 to the ships in service (existing ships). It was confirmed by majority to only include new construction (although individual Societies may also adopt the requirements for existing ships if they so wish).
- Qualification of level 3 NDT personnel through employer-based scheme (via examination route only, and not via an 'appointed route')
- Alternative approach of taking level 2 NDT personnel as a supervisor into consideration subject to certain conditions (a new paragraph in section 2.4 of UR W35 has been added, to allow this alternative approach, subject to agreement from the Class Society)
- Revised definition of NDT
- Applicability of rudders of welded construction (majority agreed for inclusion)
- The applicability of this UR to internal departments of equipment and material manufacturers – the majority agreed to make this not applicable to such manufacturers, although an individual Class Society may apply this UR to these manufacturers should they wish to.
- Allowance for the NDT Supplier to also satisfy the requirements of a Type C inspection body, as per ISO/IEC 17020:2012, (but with the stipulation that production staff shall not be allowed to inspect their own work in the case of Type C).

Agreement on the final wording was possible following discussions and consensus between members.

## 6. Attachments if any

None

# IACS

INTERNATIONAL ASSOCIATION OF CLASSIFICATION SOCIETIES LTD.

PERMANENT SECRETARIAT: 4 Matthew Parker Street

Westminster, London SW1H 9NP, UNITED KINGDOM

TEL: +44(0)207 976 0660

INTERNET: [permsec@iacs.org.uk](mailto:permsec@iacs.org.uk) Web Site: [www.iacs.org.uk](http://www.iacs.org.uk)

May 2024

## History Files (HF) and Technical Background (TB) documents for URs concerning Survey and Certification (UR Z)

Res. No.	Title	Current Rev.	HF/TB?
UR Z1	Annual and intermediate classification survey coverage of IMO Resolution A.1156(32)	Rev.9 July 2022	HF
UR Z2	Special hull survey of oil tanker	Deleted (1994) <i>Superseded by UR Z10.1</i>	No
UR Z3	Periodical survey of the outside of the ship's bottom and related items	Rev.8 Apr 2019	HF
UR Z4	Surveys of hatch covers and coamings	Deleted May 2013	No
UR Z5	In-service testing of large permanently installed breathing gas containers on-board diving vessels	Deleted (May 1998) <i>Re-categorised as Rec.59</i>	No
UR Z6	Continuous system for hull special survey	Rev.6 June 2015	HF
UR Z7	Hull Classification Surveys	Rev.29 Corr.1 May 2024	HF
UR Z7.1	Hull Surveys for General Dry Cargo Ships	Rev.15 Corr.1 May 2024	HF
UR Z7.2	Hull Surveys for Liquefied Gas Carriers	Rev.8 May 2019	HF
UR Z8	Corrosion Protection Coating for Salt Water Ballast Spaces	Rev.1 1995	No
UR Z9	Corrosion Protection Coatings for Cargo Hold Spaces on Bulk Carriers	Rev.2, Corr. 1997	No
UR Z10.1	Hull Surveys of Oil Tankers	Rev.25 Feb 2023	HF
UR Z10.2	Hull Surveys of Bulk Carriers	Rev.37 Feb 2023	HF
UR Z10.3	Hull Surveys of Chemical Tankers	Rev.21 Aug 2023	HF
UR Z10.4	Hull Surveys of Double Hull Oil Tankers	Rev.18 Feb 2023	HF



<b>Res. No.</b>	<b>Title</b>	<b>Current Rev.</b>	<b>HF/TB?</b>
UR Z10.5	Hull Surveys of Double Skin Bulk Carriers	Rev.20 Feb 2023	HF
UR Z10.6	Hull Surveys for General Dry Cargo Ships	Deleted (June 2003) <i>Re-categorised as UR Z7.1</i>	TB
UR Z11	Mandatory Ship Type and Enhanced Survey Programme (ESP) Notations	Rev.6 May 2023	HF
UR Z12	Requirements for Safe Entry to Confined Spaces	Deleted (Sept 2000)	No
UR Z13	Voyage Repairs and Maintenance	Rev.3 Jan 2011	HF
UR Z14	No record		
UR Z15	Hull, Structure, Equipment and Machinery Surveys of Mobile Offshore Drilling Units	Rev.3 May 2019	HF
UR Z16	Periodical surveys of cargo installations on ships carrying liquefied gases in bulk	Corr.1 May 2022	HF
UR Z17	Procedural Requirements for Service Suppliers	Corr.1 May 2023	HF
UR Z18	Survey of Machinery	Rev.9 Apr 2020	HF
UR Z19	Calibration of Measuring Equipment	Apr 1999	TB
UR Z20	Planned Maintenance Scheme (PMS) for Machinery	Rev.2 May 2019	HF
UR Z21	Surveys of Propeller Shafts and Tube Shafts	Rev.4 Oct 2015	HF
UR Z22	Survey Requirements for Automatic Air Pipe Heads	Deleted July 2014	TB
UR Z23	Hull Survey for New Construction	Corr.2 May 2023	HF
UR Z24	Survey Requirements for Shell and Inner Doors of Ro-Ro Ships	Corr.1 July 2011	HF
UR Z25	Periodic Survey of Fuel Installations on Ships other than Liquefied Gas Carriers utilizing gas or other low flash point fuels	Rev.1 Sep 2017	HF
UR Z26	Alternative Certification Scheme (ACS)	Feb 2015	HF
UR Z27	Condition Monitoring and Condition Based Maintenance	July 2018	HF
UR Z28	Surveys of Watertight Cable Transits	Corr.1 June 2021	HF
UR Z29	Remote Classification Surveys	New Mar 2022	HF

## UR Z1 “Annual and intermediate classification survey coverage of IMO Resolution A.1156(32)”<sup>1</sup>

### Summary

To revise the survey items following the publication of IMO Res. A.1156(32).

### Part A. Revision History

Version no.	Approval date	Implementation date when applicable
Rev.9 (July 2022)	28 July 2022	-
Rev.8 (July 2020)	21 July 2020	-
Rev.7 (May 2019)	29 May 2019	-
Rev.6 (Apr 2016)	13 April 2016	-
Rev.5 (Mar 2015)	23 Mar 2015	-
Corr.1 (Jan 2011)	05 Jan 2011	-
Rev.4 (May 2010)	18 May 2010	-
Rev.3 (Sept 2005)	18 September 2005	-
Rev.2 (June 1999)	11 June 1999	-
Rev.1 (1994)	<i>No record</i>	-
New (1982)	<i>No record</i>	-
New (1982)	<i>No record</i>	-

#### • Rev.9 (July 2022)

##### .1 Origin for Change:

- Other (following the publication of IMO Res. A.1156(32))

##### .2 Main Reason for Change:

IMO Res. A.1140(31), which is incorporated in UR Z1(Rev.8), had been revoked by IMO Res. A.1156(32).

##### .3 List of non-IACS Member classification societies contributing or participating in IACS Working Group:

None

##### .4 History of Decisions Made:

Following the publication of the IMO Res. A.1156(32), Survey Panel proceeded to review the revision 9 of the UR Z1.

<sup>1</sup> Title changed from 'Annual and intermediate classification survey coverage of IMO Resolution A.1156(32)' at Rev.9. Note that the title was also changed at Rev.2 to 8.

By making the comparisons between the IMO Res. A.1140(31) and IMO Res. A.1156(32) it was noted that some items have been renumbered, and the panel agreed to revise UR Z1 according to Res.A.1156(32).

No TB is expected for this revision.

### **5 Other Resolutions Changes:**

None

### **6 Any hindrance to MASS, including any other new technologies:**

None

### **7 Dates:**

Original Proposal	: 27 June 2022	(Proposed by Panel Chair)
Panel Approval	: 08 July 2022	(Ref: PSU22037)
GPG Approval	: 28 July 2022	(Ref: 22115_IGb)

## **• Rev. 8 (July 2020)**

### **.1 Origin for Change:**

Other (following the publication of IMO Res. A.1140(31))

### **.2 Main Reason for Change:**

IMO Res. A.1120(30), which is incorporated in UR Z1(Rev.7), had been revoked by IMO Res. A.1140(31).

### **.3 List of non-IACS Member classification societies contributing or participating in IACS Working Group:**

None

### **.4 History of Decisions Made:**

Following the publication of the IMO Res. A.1140(31), Survey Panel proceeded to review the revision 7 of the UR Z1.

By making the comparisons between the IMO Res. A.1120(30) and IMO Res. A.1140(31) it was noted that some items have been renumbered, and the panel agreed to revise UR Z1 according to Res. A.1140(31).

No TB is expected for this revision.

---

<sup>1</sup> Title changed from 'Annual and intermediate classification survey coverage of IMO Resolution A.1140' at Rev.8. Note that the title was also changed at Rev.2 to 7.

**.5 Other Resolutions Changes:**

None

**.6 Any hinderance to MASS, including any other new technologies:**

None

**.7 Dates:**

Original Proposal : 12 December 2019 (suggested by Panel Chair)  
Panel Approval : 01 July 2020 (Ref: PSU19056)  
GPG Approval : 21 July 2020 (Ref: 20126\_IGb)

• **Rev. 7 (May 2019)**

**1. Origin for Change:**

Other (following the publication of IMO Res. A.1120(30))

**2. Main Reason for Change:**

IMO Res. A.1104(29), which is incorporated in UR Z1(Rev.6), had been revoked by IMO Res. A.1120(30).

**3. List of non-IACS Member classification societies contributing through the TC Forum and/or participating in IACS Working Group:**

None

**4. History of Decisions Made:**

Following the publication of the IMO Res. A.1120(30), Survey Panel proceeded to review the revision 6 of the UR Z1.

By making the comparisons between the IMO Res. A.1104(29) and IMO Res. A.1120(30) it was noted that some items have been renumbered with some items newly inserted, and the panel agreed to revise UR Z1 according to Res. A.1120(30).

No TB is expected for this revision.

**5. Other Resolutions Changes:**

None

**6. Any hinderance to MASS, including any other new technologies:**

None

## 7. Dates:

Original Proposal: 14 March 2019 decided at Panel Spring Meeting  
Panel Approval: 11 May 2019 (PSU19011)  
GPG Approval: 29 May 2019 (19099\_IGb)

### • Rev.6 (Apr 2016)

#### .1 Origin for Change:

Other (following the publication of IMO Res. A.1104(29))

#### .2 Main Reason for Change:

IMO Res.A.1053(27), amended by IMO Res. A.1078(28), which is incorporated in UR Z1(Rev.5) had been revoked by IMO Res.A.1104(29).

#### .3 List of non-IACS Member classification societies contributing through the TC Forum and/or participating in IACS Working Group:

None

#### .4 History of Decisions Made:

According to the permanent task of the Survey Panel and following the publication of the IMO Res. A .1104(29), Members proceeded to review the revision 5 of the UR Z1.

By making the comparisons between the IMO Res.A.1053(27), amended by IMO Res. A.1078(28) and IMO Res.A.1104(29) it has noted that some items have been renumbered. The renumbering influences the references contained in the unified requirements and then the revision 6 has been agreed by the Panel.

Likewise, during the discussion Members agreed to update the resolution number referred to in the "Preamble".

No technical background has been produced for this revision.

### • Rev.5 (Mar 2015)

#### .1 Origin for Change:

Suggestion by IACS member

#### .2 Main Reason for Change:

IMO Res.A.997(25), amended by IMO Res. A.1020(26), which is incorporated in UR Z1(Rev.4 Corr. 1) had been revoked by IMO Res.A.1053(27), as amended by IMO Res.A.1076(28).

#### .3 List of non-IACS Member classification societies contributing through the TC Forum and/or participating in IACS Working Group:

None

#### **.4 History of Decisions Made:**

Discussion was open by noting the Rev.4 Corr. 1 was not duly updated with the new IMO Res.A.1053(27) and subsequent Amendments contained into the IMO Res. A.1076(28).

By making the comparisons between the IMO Res.A.997(25), amended by IMO Res. A.1020(26) and IMO Res.A.1053(27), as amended by IMO Res.A.1076(28), it has noted that some items have been renumbered and new survey items have been added as detailed in the attached Technical Background. Moreover, during the discussion Members agreed the deletion of the last sentence of the "Preamble" because deemed unnecessary.

Following the first review by GPG, the Unified Requirement was returned to the Survey Panel in order to evaluate whether there are the technical grounds which may allow a modification of the items Z1.3.3 and Z1.3.4, by excluding (respectively) the items Din 1.2.3.5. and Gin 2.3.2.4 of the IMO Resolution A.1053(27) as amended by IMO resolution A. 1076(28), and so address the existing Member reservation. The qualified majority of the Panel Members concurred that spare gear is no longer an item which is commonly a class requirement.

Accordingly, Z1.3.3 and Z.1.3.4 have been modified by excluding the two items relevant to the spare parts of the ventilators.

#### **.5 Other Resolutions Changes**

None

#### **.6 Dates:**

Original Proposal: 10 March 2014 made by IACS Member  
Survey Panel Approval: 16 December 2014 (Ref: PSU14005)  
GPG Approval: 23 March 2015 (Ref: 14202\_IGe)

#### **• Corr.1 (Jan 2011)**

##### **.1 Origin of Change:**

Suggestion by IACS members

##### **.2 Main Reason for Change:**

To ensure that UR Z1 do not include requirements for classification surveys of items which purely fall within the scope of the statutory certification.

A number of IACS Members raised the point that the following items, which are currently required to be surveyed within the scope of classification, as per UR Z1, are in fact outside the scope of classification surveys:

Item ref. (CA) 2.2.2.29 of IMO Res.A997(25) as amended, related to the confirmation that new equipment containing asbestos was not fitted on board since last survey (SOLAS 74/00/04 reg. II-1/3-5).

Item (CA) 2.2.2.33 of IMO Res.A997(25) as amended, related to the confirmation that ship's identification number is permanently marked (SOLAS74/02, reg. XI-1/3).

Item (CA) 2.2.2.35 of IMO Res.A997(25) as amended, related to the confirmation (for ships other than CSR bulk carriers and CSR oil tankers), that the coating system in dedicated SWB tanks is maintained and that maintenance, repair and partial recoating are recorded in the coating technical file (SOLAS 74/00/06 reg. II-1/3-2).

**.3 List of non-IACS Member classification societies contributing through the TC Forum and/or participating in IACS Working Group:**

None

**.4 History of Decisions Made:**

The decision was made to clearly exclude the three above items, which are covered by the Safety Construction Annual Survey through IMO Res.A.997(25) as amended, from the annual survey requirements of UR Z.1.

**.5 Other Resolutions Changes**

None

**.6 Dates:**

Original Proposal: *September 2010 Made by the Survey Panel*  
Panel Approval: *December 2010*  
GPG Approval: *05 January 2011 (Ref: 10052aIGb)*

• **Rev.4 (May 2010)**

**.1 Origin for Change:**

Suggestion by IACS member

**.2 Main Reason for Change:**

IMO Res.A.948(23) which is incorporated in UR Z1(Rev.3) had been revoked by IMO Res.A.997(25).

**.3 History of Decisions Made:**

KRS volunteered for drafting UR Z1(Rev. 4) taking into accounts of new requirements in IMO Res.A.997(25). During drafting, IMO Res.A.1020(26) which is the amendment to IMO Res.A.997(25) was published, therefore this was also taken into account in Rev.4.

**.4 Other Resolutions Changes**

None

## **.5 Any dissenting views**

None

## **.6 Dates:**

Original Proposal: *17 February 2010 made by Survey Panel*

Survey Panel Approval: *7 April 2010*

GPG Approval: *18 May 2010 (ref. 10052\_IGb)*

- **Rev.3 (Sept 2005)**

See TB document in Part B.

The existing references to Res. A.746(18) were updated to A.948(23), including within the title.

- **Rev.2 (June 1999)**

Complete revision – see TB document in Part B.

The existing reference to IMCO Res. A.413(XI) was replaced with A.746(18).

Title changed from "*Annual survey of all cargo vessels and intermediate survey of tankers covering class matters in IMCO Resolution A.413(XI)*" to "*Annual and intermediate classification survey coverage of IMO Resolution A.746(18)*"

- **Rev.1 (1994)**

No TB document available.

- **New (1982)**

No TB document available.



## **Part B. Technical Background**

List of Technical Background (TB) documents for UR Z1:

Annex 1. **TB for Rev.2 (June 1999)**

See separate TB document in Annex 1.

Annex 2. **TB for Rev.3 (Sept 2005)**

See separate TB document in Annex 2.

Annex 3. **TB for Rev.4 (May 2010)**

See separate TB document in Annex 3.

Annex 4. **TB for Corr.1 (Jan 2011)**

See separate TB document in Annex 4.

Annex 5. **TB for Rev.5 (Mar 2015)**

See separate TB document in Annex 5.

**Note:** *There are no separate Technical Background (TB) documents available for the original resolution (1982), Rev.1 (1994), Rev.6 (Mar 2016), Rev.7 (May 2019), Rev.8 (July 2020) and Rev.9 (July 2022)*

**Technical Background Document**  
**WP/SRC Task 1**  
**UR Z 1 – Proposed Rev. 2**

**Objective and Scope:**

To review existing UR Z 1 and update as required.

**Source of Proposed Requirements:**

WP/SRC members discussed and reviewed the requirements contained in IMO Resolution A.746(18) and UR Z 1 through correspondence and their meeting. UR Z 1 was updated to reflect the changes in IMO Res. A.746(18).

**Points of Discussion:**

WP/SRC unanimously agreed to the proposed draft UR Z 1.

Date of submission: 6 May 1999  
By WP/SRC Chairman's e-mail

## **Technical Background**

### **UR Z1 (Rev.3) Annual and Intermediate Classification Survey coverage of IMO Resolution A.746(18)**

WP/SRC Task 3 – Review of IACS URs Relating to Surveys, set as a continuous Task, discussed at the October 2004 meeting that a revision of UR Z1 was required due to the replacement of IMO Resolution A.746(18) with IMO Resolution A.948(23), which defines the annual and intermediate coverage of classification as related to IMO.

WP/SRC set a deadline to complete the Task by 31 December 2004, but was not able to complete a draft by that time. This Task was then turned over to the Survey Panel at the Panel's initial meeting in February of 2005.

#### **Survey Panel Discussion**

A draft was submitted to Survey Panel members by the Survey Panel Secretary with comments from Panel members, mainly editorial, in addition to the following:

ABS Panel member stated in PSU5011\_ABa "In item 2.1 Load Line survey: ABS questions the need to have reference to paragraphs 1.2.3.1 through 1.2.3.2 of Annex 2 as these paragraphs refer to signing of the Load Line Certificate. We did not make reference to signing the Safety Construction certificate in other items. Z1 is a classification document only.

Item 2.3 Machinery and electrical systems: ABS noted that revision did not include paragraph 2.2.2.27; "examining visually the condition of any expansion joints in sea water systems". It is suggested that this item be included as a classification item as expansion joints are extremely important and usually visually examined anyway by any experienced classification surveyor during annual machinery surveys as part of the piping systems. A failure of a large expansion joint could lead to rapid engine room flooding.

RINA Panel member stated in PSU5011\_RIa "As regards item 3.2 - Oil tanker additional items, it is suggested to amend the text in brackets as follows to be consistent with the contents: "(Piping systems and cargo tanks and electrical circuits in dangerous zones)".

As regards item 3.3 - Chemical tanker additional items, the last item 1.3.2.6 (which refers to noxious substances) is not to be included as similarly made for annual surveys.

#### **Survey Panel Decision**

All Panel members agreed with the attached comments, in addition to other Panel members editorial comments, and a final draft was submitted for GPG for approval by the Survey Panel Chairman.

#### **Note:**

- GPG agreed that no uniform application date for this revision was needed(4181aIGf)

Submitted by Survey Panel Chairman  
17 August 2005

## **Technical Background for UR Z1 Rev.4 (May 2010)**

### **1. Scope and objectives**

To amend the current UR Z1 referring to IMO Res.A.948(23) which had been revoked by IMO Res.A.997(25) as amended by IMO Res.A.1020(26).

### **2. Engineering background for technical basis and rationale**

As new amendments to the survey guidelines under the harmonized system of survey and certification, 2007, IMO Res.A.1020(26), had been published, the current UR Z 1 referring to IMO Res.A.948(23) was revised in accordance with IMO Res.A.997(25) as amended by IMO Res.A.1020(26).

### **3. Source/derivation of the proposed IACS Resolution**

N/A

### **4. Summary of Changes intended for the revised Resolution:**

- 1) To add new requirements introduced in IMO Res.A.997(25) as amended by IMO Res.A.1020(26)
- 2) To re-arrange items reflecting the requirement number's changes in IMO Res.A.997(25) as amended by IMO Res.A.1020(26)
- 3) To remove invalid requirements including the reference to Annex 1 para 1.2.3.5 in para 2.5 of UR Z1 as proposed from GPG

### **5. Points of discussions or possible discussions**

None

### **6. Attachments if any**

None

## Technical Background for UR Z1 Corr.1, Jan 2011

### 1. Scope and objectives

To remove from UR Z1 items which should not be covered by classification surveys, but remain subject to statutory surveys.

### 2. Engineering background for technical basis and rationale

Marking of ship's identification number, the issue of asbestos, the coating of WBT according to the IMO PSPC for ships other than CSR bulk carriers and CSR oil tankers contracted for construction on or after 8th December 2006, are items which are not covered by classification.

### 3. Source/derivation of the proposed IACS Resolution

UR Z1 and IMO Res.A.997(25) as amended.

### 4. Summary of Changes intended for the revised Resolution:

The following amendment is made to the annual survey requirements in UR Z1:

"2.2 Hull items - Annex 1 Paragraphs 2.2.2.1 through 2.2.2.6 and 2.2.2.28 through 2.2.2.34 except for 2.2.2.29 and 2.2.2.33."

### 5. Points of discussions or possible discussions

None

### 6. Attachments if any

None

## Technical Background for UR Z1 Rev.5, Mar 2015

### 1. Scope and objectives

To remove a reservation and update UR Z1 by inserting/removing items according to the modifications introduced by IMO Res. A. 1053(27) as amended by IMO Res. A.1076(28).

### 2. Engineering background for technical basis and rationale

None

### 3. Source/derivation of the proposed IACS Resolution

UR Z1 and IMO Res. A. 1053(27) as Amended by IMO Res. 1076(28).

### 4. Summary of Changes intended for the revised Resolution:

The following amendment is made to the annual survey requirements in UR Z1:

#### Annual Survey

**Loadline Items:** No modifications

**Hull Items :** following modification have been noted

- 1) A new paragraph has been introduced as follows  
(CA) 2.2.2.2bis examining, for bulk carriers of 150 m and above, where appropriate, the ship's structure in accordance with the Ship Construction File, taking into account identified areas that need special attention (SOLAS 10 reg. II-1/3-10 and MSC.287(87)); since it is numbered with a *bis* the numbering from 2.2.2.1 to 2.2.2.4 is not modified.
- 2) Following the renumbering of the item 2.2.2.4 bis (see Res.1020) as 2.2.2.5 the items 2.2.2.5 and 2.2.2.6 are now renumbered as 2.2.2.6 and 2.2.7 (respectively).
- 3) A new subparagraph has been introduced under the renamed item 2.7 as follows  
 CA) 2.2.2.7.1 examining visually the drainage facilities for blockage or other damage and confirming the provision of means to prevent blockage of drainage arrangements, for closed vehicle and ro-ro spaces and special category spaces where fixed pressure water-spraying systems are used (SOLAS 08 reg.II-2/20.6.1.5);
- 4) Moreover the hull items 2.2.2.28 through 2.2.2.34 are now renumbered as follows 2.2.2.29 to 2.2.2.35. Consequently the two exceptions represented by paragraphs 2.2.2.29 and 2.2.2.33 are now renumbered as 2.2.2.30 and 2.2.2.34.
- 5) New paragraphs 2.2.2.37, 2.2.2.38 (under the already renamed 2.2.2.35) has been introduced as follows:
  - 5.1) (CA) 2.2.2.37 confirming, for bulk carriers constructed before 1 July 1999 with restrictions imposed with respect to the carriage of cargoes with a density of 1,780 kg/m<sup>3</sup> and above, that a triangle is permanently marked at midship (SOLAS 74/97/04 reg.XII/8.3);

5.2 (CA) 2.2.2.38 confirming, for bulk carriers, that the loading instrument is on board and functioning (SOLAS 74/97/04 reg.XII/11)

No further renumbering of paragraphs has been done because after paragraph 2.2.2.38 the paragraph 2.2.3 starts.

**Machinery and electrical items:** following modification have been noted

- 1) Following the renumbering of item 2.2.2.4bis the machinery items 2.2.2.7 through 2.2.2.27 have been renumbered as follow from 2.2.2.8 to 2.2.2.28. Consequently the two exceptions represented by paragraphs 2.2.2.17 and 2.2.2.26 are now renumbered as 2.2.2.18 and 2.2.2.27
- 2) A new paragraph has been introduced as follows  
(CA) 2.2.2.24bis examining, where applicable, the alternative design and arrangements for machinery or electrical installations, or fire safety, in accordance with the test, inspection and maintenance requirements, if any, specified in the approved documentation (SOLAS 00/06 regs. II-1/55 and II-2/17): since it is numbered with a *bis* the numbering from NEW 2.2.2.8 to new 2.2.2.28 (see above) is not modified.

**Fire fighting equipment:** following modification have been noted

- 1) A new paragraph has been introduced as follows  
(EA) 1.2.2.7 checking that fixed carbon dioxide fire-extinguishing systems for the protection of machinery spaces and cargo pump-rooms, where applicable, are provided with two separate controls, one for opening of the gas piping and one for discharging the gas from the storage container, each of them located in a release box clearly identified for the particular space (SOLAS 08 reg.II-2/10.4.1.5);
- 2) Following the insertion of the new paragraph the items 1.2.2.7 through 1.2.2.13 has been renamed from 1.2.2.8 to 1.2.2.14

**Oil tanker additional items:** following modification have been noted

- 1) A new paragraph has been introduced as follows:  
CA) 2.2.3.15bis confirming that the coating system in cargo oil tanks of crude oil tankers, when appropriate, is maintained and that in-service maintenance and repair activities are recorded in the coating technical file (SOLAS 10 reg. II-1/3-11 and MSC.288(87)). Since it is numbered with a *bis* the numbering from 2.2.3.1 to 2.2.3.16 is not modified.
- 2) A new paragraph has been introduced as follows:  
(CA) 2.2.3.17 examining, for oil tankers of 150 m in length and above, where appropriate, the ship's structure in accordance with the Ship Construction File, taking into account identified areas that need special attention (SOLAS reg. II-1/3-10 and MSC.287(87));

No further renumbering of paragraphs has been done because after paragraph 2.2.3.16 the paragraph 2.2.4 starts.

**Chemical tanker additional items** following modification have been noted

- 1) Following the renumbering of the item 1.2.2.16 bis (see Res.1020) as 1.2.2.17, the items from 1.2.2.17 to 1.2.2.19.7 are now renumbered as 1.2.2.18 and 1.2.2.20.7. Item 1.2.2.21 has been renumbered as 1.2.2.22 (respectively).

**Gas carrier additional items.** No modifications

### **Intermediate Survey**

**Chemical tanker additional items** following modification have been noted:

Z1.3.3. of the Unified Requirement has have been modified by removing the item relevant to the spare parts of the ventilators: excluded paragraph 1.3.2.5 of annex 4, of the IMO Res. A 1053(27) as amended.

**Gas carrier additional items** following modification have been noted:

Z.1.3.4 of the Unified Requirement has have been modified by removing the item relevant to the spare parts of the ventilators: excluded paragraph 2.3.2.4 of annex 4, of the IMO Res. A 1053(27) as amended.

Both items are no longer belonging into the class requirements: No modifications at all.

### **5. Points of discussions or possible discussions**

None

### **6. Attachments if any**

None



## UR Z3 “Periodical Survey of the Outside of the Ship’s Bottom and Related Items”

### Summary

This resolution was revised for addressing the inconsistency between UR Z7 2.2.2.1 and UR Z3.1.6 relevant to the dry dock survey requirements for Liquefied Gas Carriers.

### Part A. Revision History

Version no.	Approval date	Implementation date when applicable
Rev.8 (Apr 2019)	11 April 2019	1 July 2020
Rev.7 (Jan 2018)	16 January 2018	1 January 2019
Rev.6 (Dec 2013)	21 Dec 2013	1 July 2014
Rev.5 (Apr 2011)	14 Apr 2011	1 January 2012
Rev.4 (Oct 2006)	29 Oct 2006	1 January 2008
Rev.3 (Aug 2004)	4 Aug 2004	1 July 2005
Corr.1 (Feb 2004)	11 Feb 2004	-
Rev.2 (Aug 2002)	30 Aug 2002	1 July 2003
Rev.1 (1996)	No record	1 July 1996
NEW (1984)	No record	-

#### • Rev.8 (Apr 2019)

##### .1 Origin of Change:

- Suggestion by IACS member

##### .2 Main Reason for Change:

One IACS member indicated that for Liquefied Gas Carriers the UR Z7.2 requirement, “A survey in dry dock is to be a part of the Special Survey”, is not reflected in UR Z3 and Rec.133, and proposed to revise UR Z3 and Rec.133 to address this inconsistency.

##### .3 List of non-IACS Member classification societies contributing through the TC Forum and/or participating in IACS Working Group:

None.

##### .4 History of Decisions Made:

Survey Panel discussed the proposed revisions to UR Z3 and Rec.133, and agreed to only revise UR Z3.1.6 for aligning with UR Z7.2 and leave Rec. 133 as it is with a view that according to the discussions during the drafting of Rec 133 it was decided by the panel that gas carriers could apply for EDD.

The implementation date of this revision was agreed to be set as 1<sup>st</sup> July 2020.

**.5 Other Resolutions Changes:**

None.

**.6 Any hinderance to MASS, including any other new technologies:**

None.

**.7 Dates:**

Original Proposal: 22<sup>nd</sup> February 2018 Made by: One IACS Member  
Panel Approval: 27 March 2019 (ref: 19061\_PYa)  
GPG Approval: 11 April 2019 (ref: 19061\_IGb)

• **Rev.7 (Jan 2018)**

**.1 Origin of Change:**

Suggestion by an IACS member

**.2 Main Reason for Change:**

To address the FUA 11 of C73, raised by the Council of the IACS in respect to the future work directions on the implications of new technology on survey regime. A revision of UR Z3 is in order to consider the use of Remotely Operated Vehicle (ROV) and to propose the possible list of the service suppliers that need to be certified.

**.3 List of non-IACS Member classification societies contributing through the TC Forum and/or participating in IACS Working Group:**

None

**.4 History of Decisions Made:**

Task assigned by GPG on 21th October 2016. Panel discussed and agreed to add clarification in UR Z3 for details of In-Water Survey regarding ROV and service suppliers. Accordingly, Panel agreed with the amendment to Para Z3.3.

No TB is expected for the present revision.

**.5 Other Resolutions Changes**

UR Z7, UR Z10.3, UR Z17

**.6 Dates:**

Original Proposal: 21 October 2016 assigned by GPG  
Panel Approval: 08 December 2017 by Survey Panel (Ref: PSU16056)

GPG Approval: 16 January 2018 (Ref: 16151\_IGq)

- **Rev.6 (Dec 2013)**

**.1 Origin of Change:**

- Suggestion by an IACS member

**.2 Main Reason for Change:**

A member of Survey Panel initiated this discussion with reference to a recent external audit observation that class society procedures and checklists do not address clearly details of inspection to be carried out on Directional Propulsion Systems during an IWS or Docking Survey.

**.3 List of non-IACS Member classification societies contributing through the TC Forum and/or participating in IACS Working Group:**

None

**.4 History of Decisions Made:**

Panel discussed and agreed to add clarification in UR Z3 for details of inspection regarding other types of propulsion and manoeuvring systems such as directional propulsion systems, vertical axis propellers, water jet units etc. Accordingly, Panel agreed with the amendment to Para Z3.2.6.

**.5 Other Resolutions Changes**

None

**.6 Dates:**

Original Proposal: *05 June 2013 Made by a Member of the Survey Panel*  
Panel Approval: *31 July 2013 by Survey Panel*  
GPG Approval: *21 Dec 2013 (Ref: 13205\_IGd)*

- **Rev.5 (April 2011)**

**.1 Origin of Change:**

- Suggestion by an IACS member

Item 1.

A member of IACS raised the point that, although the issue of IWS visibility requirements has been discussed at various times, UR Z3 states "The in-water visibility is to be good" which can lead to surveyors being put under pressure to accept marginal visibility.

Item 2.

Continuous harmonisation between IMO Res.A744(18) as amended (ESP Guidelines) and IACS survey requirements.

**.2 Main Reason for Change:**

1. To improve the wording of UR Z3 to resolve this issue.
2. The following proposed amendment to IMO Res.A744(18) as amended was not accepted at DE54:  
"For ships of over 15 years of age ~~and over~~ , inspection of the outside.... For ships of ~~less than~~ 15 years of age or less, alternate inspections.."

**.3 List of non-IACS Member classification societies contributing through the TC Forum and/or participating in IACS Working Group:**

None

**.4 History of Decisions Made:**

1. The decision was made to clarify UR Z3, para. 3.3.2.
2. The decision was made to amend UR Z3, para. 3.1.3 in accordance with IMO Res. A744(18) as amended.

**.5 Other Resolutions Changes**

UR Z10s related to ESP ships, through a separate task.

**.6 Dates:**

Original Proposal: *September 2010 Made by the Survey Panel*

Panel Approval: *January 2011*

GPG Approval: *14 April 2011 (Ref: 11050\_IGd)*

• **Rev.4 (Oct 2006)**

See TB document in Part B.

• **Rev.3 (Aug 2004)**

See TB document in Part B.

• **Corr.1 (Feb 2004)**

This correction amends reference to UR Z10.6 to read Z7.1.  
Subject number: *1060g*

• **Rev.2 (Aug 2002)**

See TB document in Part B.

- **Rev.1 (1996)**

No TB document available.

- **NEW (1984)**

No TB document available.

## Part B. Technical Background

List of Technical Background (TB) documents for UR Z3:

Annex 1. **TB for Rev.2 (Aug 2002)**

See separate TB document in Annex 1.



Annex 2. **TB for Rev.3 (Aug 2004)**

See separate TB document in Annex 2.



Annex 3. **TB for Rev.4 (Oct 2006)**

See separate TB document in Annex 3.



Annex 4. **TB for Rev.5 (Apr 2011)**

See separate TB document in Annex 4.



Annex 5. **TB for Rev.6 (Dec 2013)**

See separate TB document in Annex 5.



**Note:** *There are no separate Technical Background (TB) documents for the original resolution (1984), Rev.1 (1996), Corr.1 (Feb 2004), Rev.7 (Jan 2018) and Rev.8 (Apr 2019).*

**Technical Background Document**  
**UR Z3 Rev.2 August 2002**

**Revised UR Z3-Periodical Survey of the Outside of the Ship's Bottom and Related Items**  
**(WP/SRC Task 101)**

**Objective and Scope:**

To revise the dry-docking survey requirements in UR Z10.2, 10.3, 10.4 and UR Z3 to harmonise them with those in Z10.1 (Rev.9) and reflect in UR Z3 the interim application of bottom survey requirements as introduced in MSC/Circ.1013 (Res.A746(18))

**Source of Proposed Requirements:**

WP/SRC developed the revised UR Z3 through correspondence and at their Spring meeting this year. The revised UR Z3 is in accordance with the interim application of bottom survey requirements as introduced in the revised MSC/CIRC: 1013 which was approved at MSC 75 in May 2002. A new circular number will be assigned by IMO.

The dry-docking requirements in UR Z10.1(Rev 9), Z 10.2(Rev 12) and Z10.3(Rev 5) need not be further amended as a result of this revised MSC/CIRC.

UR Z10.4 para 2.2.2.1 is to be updated to correspond with the text in the same para of UR Z10.1.

**Points of Discussion:**

1. The revised UR Z3 was unanimously agreed by WP/SRC.
2. BV proposed to suppress for the time being the reference to UR Z10,5 as same has not been submitted to GPG for approval. (ref 1060hBVa) The chairman of WP/SRC is in agreement with BV's proposal and suggests that UR Z10.4, UR Z10.5 and UR Z10.6 should be considered in the harmonisation project. (WP/SRC-Task 102)
3. The chairmen of WP/SRC and GPG asked Mr Gil-Yong Han to verify the use of the term "special/class renewal survey, which appears in para 1.2 and 2.3. Mr Han suggests to use the term "special survey" throughout the document and add a note to Z3 para 1.2:  
 "Some member Societies use the term "Special Periodical Survey, others use the term Class Renewal Survey". The chairman of WP/SRC agrees to inserting this note.
4. With respect to the definition of "any five period" in SOLAS 88 and Res A.746(18), the following text was approved at MSC 75.  
 "Any five-year period is the five-year validity of the Cargo Ship Safety Construction Certificate(SC) or the Cargo Ship Safety Certificate."  
 (See FSI 10/17/Annex 5. MSC 75/WP.11/Add.1/13.9 reads the Committee approved it.)  
 The chairman of WP/SRC advises that WP/SRC found it not necessary to introduce the above interpretation into UR Z3 with change of SC to Class Certificate. Instead, WP/SRC agreed to use "during each five year special survey period".
5. The revised MSC/CIRC is applicable as from 1.July 2002.  
 The chairman of WP/SRC recommends that the revised UR Z3 is given high priority and adopted from the same date.

**Note by the Permanent Secretariat:**

After a considerable length of discussion on Z3.1.1(The Owner is to notify...), GPG decided to keep it as it was. (GPG subject number 1060h)

### **Technical Background UR Z 3 Rev.3.**

This is a partial outcome of WP/SRC's Task 110 *Develop an IACS resolution on the control of extensions of class beyond the special survey due date (UR Z 7, 2.1.2) and similar extensions to drydocking due dates* which was to:

- a). define the "Exceptional Circumstances" under which an extension to special (renewal) survey and/or drydocking may be granted;
- b). provide a specific and consistent policy and procedures for extension surveys.

The task was triggered by complaints by the Marshall Islands Administration at its meeting with its ROs in 2002 of a lack of consistency in this area.

Under 2222bNVb of 21 January 2004, WP/SRC submitted amendments to UR Z3 to clarify the drydocking aspects. They confirm that an extension may be granted in exceptional circumstances, which term is to be defined in a revision of PR1A. In addition, the requirements for an in-water survey in lieu of dry-docking are made more specific.

GPG approved the revision to UR Z3 on 1 April 2004 (2222bIGc).

In Council discussion, the definition of 'exceptional circumstances' agreed for the revision of PR1A was added as a footnote to para 3.1.2. The wording of para 3.1.2 itself was simplified.

Adopted by Council on 4 August 2004 (2222bICd).

Permanent Secretariat 13/04/04 and 09/08/04.



## TECHNICAL BACKGROUND

### UR Z3 (Rev. 4), Z 7 (Rev. 14), Z18 (Rev. 2) and Z21 (Rev. 2)

#### Survey Panel Meeting March 2006 New Business Item – Applying UR Z3, Z7, Z18 and Z21 for Military Vessels.

#### 1. Objective

To add the following new paragraph to UR Z3, Z7, Z18 and Z21 to reflect that special consideration may be used for military vessels:

**“Special consideration may be given in application of relevant sections of this Unified Requirement to military vessels or commercial vessels owned or chartered by Governments, which are utilized in support of military operations or service”.**

#### 2. Background

This task was originally discussed during the Survey Panel meeting, which took place at ABS Houston on the 1<sup>st</sup> to 3<sup>rd</sup> March 2006; it was subsequently recorded under paragraph 3 “new business” of the minutes of this meeting.

This initial started as a proposal for ABS to remove their reservation (see below) for military vessels against UR Z3 and Z7s. However all of the members agreed to the proposal.

Current ABS Reservation: “ABS allows variations in survey interval in agreement with US Government for military vessels or commercial vessels owned or chartered by the Government which are utilized in support of military operations or service.”

#### 3. Methodology of Work

Survey Panel members through correspondence.

#### 4. Discussion

Survey Panel member from ABS raised this issue at the March 2006 Survey Panel meeting and volunteered to propose amendments to the applicable URs for Panel members to review and comment on through correspondence. At the Fall meeting of the Survey Panel, it was agreed upon by all Panel members that the proposed amendments for UR Z3, Z7, Z18 and Z21, which were proposed by ABS, were acceptable.

#### 5. Implementation

The Survey Panel is of the view that the Members need 12 months from the adoption date to implement these amendments into their class rules. Assuming that GPG and Council approve to the amendments, the Survey Panel would propose January 2008 as an

implementation date. However due to other on going revisions to UR Z21 this UR will be held abeyance until the other revisions are completed.

**6. Discussion at GPG:** GPG amended the proposal by deleting the phrase “military vessels or” on the basis that military vessels and other government ships operated for non-commercial purposes are out of the scope of IACS URs. The adopted amendment therefore reads:

**“Special consideration may be given in application of relevant sections of this Unified Requirement to commercial vessels owned or chartered by Governments, which are utilized in support of military operations or service”.**

Submitted by Survey Panel Chair, October 2006  
Updated by GPG to reflect their discussion

## **Technical Background for UR Z3 Rev.5, Apr 2011**

### **1. Scope and objectives**

#### Item 1.

To clarify the requirements in UR Z3 with respect to the in-water visibility during an in-water survey.

#### Item 2.

To harmonise IMO Res.A744(18) and IACS Unified Requirements with respect to the age limit above which the bottom survey is to be carried out in dry-dock.

### **2. Engineering background for technical basis and rationale**

Panel members agreed not to use a defined visibility distance.

### **3. Source/derivation of the proposed IACS Resolution**

UR Z3 and IMO Res.A744(18) as amended and IMO Res.A997(25) as amended.

### **4. Summary of Changes intended for the revised Resolution:**

#### 1. The following amendment is made to UR Z3:

Z3.3.2 The In-water Survey is to be carried out with the ship in sheltered water and preferably with weak tidal streams and currents. The in-water visibility and the cleanliness of the hull below the waterline is to be clear enough to permit a meaningful examination which allows the surveyor and diver to determine the condition of the plating, appendages and the welding. The Classification Society is to be satisfied with the methods of orientation of the divers on the plating, which should make use where necessary of permanent markings on the plating at selected points.

#### 2. The following amendment is made to UR Z3:

Z3.1.3 Examinations of the outside of the ship's bottom and related items of ships is normally to be carried out with the ship in drydock. However, consideration may be given to alternate examination while the ship is afloat as an In-water Survey, subject to provisions of Z3.3. Special consideration is to be given to ships of 15 years or over before being permitted to have such examinations. For ESP ships of 15 years of age and over, such examinations are to be carried out with the ship in drydock.

### **5. Points of discussions or possible discussions**

None

### **6. Attachments if any**

None

Technical Background (TB) document for UR Z3 (Rev.6 Dec 2013)

**1. Scope and objectives**

Clarify the inspection requirements in UR Z3 for Directional Propulsion Systems.

**2. Engineering background for technical basis and rationale**

Panel discussed and agreed to add clarification in UR Z3 for details of inspection regarding other types of propulsion and manoeuvring systems such as directional propulsion systems, vertical axis propellers, water jet units etc.

**3. Source/derivation of the proposed IACS Resolution**

UR Z3

**4. Summary of Changes intended for the revised Resolution**

The following amendment is made to UR Z3.2.6:

Z3.2.6 Visible parts of side thrusters are to be examined. Other propulsion systems which also have manoeuvring characteristics (such as directional propellers, vertical axis propellers, water jet units) are to be examined externally with focus on the condition of gear housing, propeller blades, bolt locking and other fastening arrangements. Sealing arrangement of propeller blades, propeller shaft and steering column shall be verified.

Also minor editorial corrections are done in paragraphs Z3.2.2 and Z3.2.4.

**5. Points of discussions or possible discussions**

None

**6. Attachments if any**

None

## UR Z6 “Continuous system for hull special survey”

### Part A. Revision History

Version no.	Approval date	Implementation date when applicable
Rev.6 (June 2015)	19 June 2015	01 July 2016
Rev.5 (July 2005)	<i>No record</i>	01 July 2006
Rev.4 (April 2004)	<i>No record</i>	-
Rev.3 (March 1999)	<i>No record</i>	-
Rev.2 (1996)	<i>No record</i>	-
Rev.1 (1993)	<i>No record</i>	-
New (1993)	<i>No record</i>	-

#### • Rev.6 (June 2015)

##### .1 Origin for Change:

- Suggestion by IACS member

##### .2 Main Reason for Change:

Note 3, relevant to the change over from continuous survey to special survey for dry cargo ships following the introduction of UR Z7.1, is no longer applicable.

##### .3 List of non-IACS Member classification societies contributing through the TC Forum and/or participating in IACS Working Group:

None

##### .4 History of Decisions Made:

During the discussion under Panel task PSU14016 a Member noted that the note 3 of UR Z6 was outdated and no longer necessary. Panel at the 21<sup>st</sup> meeting agreed that the note need to be deleted and agreed the amendment of UR Z6.

No technical background has been expected for this revision.

##### .5 Other Resolutions Changes

None

##### .6 Dates:

Original Proposal: 17 March 2015 made by IACS Member  
 Survey Panel Approval: 17 March 2015 (21<sup>st</sup> Survey Panel Meeting)  
 GPG Approval: 19 June 2015 (Ref: 15098\_IGb)

- **Rev.5 (July 2005)**

Refer to the Technical Background document in Part B.

- **Rev.4 (April 2004)**

Refer to the Technical Background document in Part B.

- **Rev.3 (March 1999)**

Refer to the Technical Background document in Part B.

- **Rev.2 (1996)**

No records are available.

- **Rev.1 (1993)**

No records are available.

- **New (1993)**

No records are available.

## **Part B. Technical Background**

List of Technical Background (TB) documents for UR Z6:

Annex 1. **TB for Rev.3 (Mar 1999)**

See separate TB document in Annex 1.

Annex 2. **TB for Rev.4 (Apr 2004)**

See separate TB document in Annex 2.

Annex 3. **TB for Rev.5 (July 2005)**

See separate TB document in Annex 3.



**Note:** *There are no separate Technical Background (TB) documents for the original resolution (1993), Rev.1 (1993), Rev.2 (1996) and Rev.6 (June 2015).*

**Technical Background Document  
WP/SRC Task 59  
UR Z 6 – Proposed Rev. 3**

**Objective and Scope:**

To remove the ambiguity of survey requirements for ballast tanks for ships on hull continuous survey.

**Source of Proposed Requirements:**

WP/SRC members discussed this issue and agreed that it is an administrative problem for each society to track due dates of ballast tanks survey. However, a footnote was added to UR Z 6 to clarify that ships on CHS are not exempt from other periodical surveys.

**Points of Discussion:**

WP/SRC unanimously agreed -to the draft UR Z 6.



## Technical Background

### Revision (4) of UR Z6-Continuous System for Hull Special Survey

As part of its continuous review of IACS URs relating to surveys, the WP/SRC has revised the UR Z6-Continuous System for Hull Special Survey. The following draft amendments were agreed unanimously by the WP and submitted to GPG for approval.

#### Amendments

First sentence below the title to be amended to read: For ships other than ESP ships (Oil Tankers, Combination Tankers, Bulk Carriers and Chemical Tankers) subject to UR Z10s and ships other than General Dry Cargo Ships subject to UR Z7.1

Paragraph 6.4, the following sentence to be added at the end of the paragraph: The survey in dry-dock may be held at any time within the five-year class period.

New Note 3: General Dry Cargo Ships. For the application of the new requirements, a General Dry Cargo Ship is defined as a self-propelled ship of 500 gross tonnes or above, constructed generally with a tween deck and intended to carry solid cargoes. This excludes bulk carriers, refrigerated cargo ships, roll on-roll off ships and ships dedicated for the carriage of containers, forest products (but not log or timber carriers), woodchips or cement as well as livestock carriers and dock/deck ships. The changeover from continuous survey to special survey is to be carried out as early as possible and should be no later than the due date of the next intermediate survey, or the due date for completion of the current Continuous survey hull cycle, whichever is earlier.

In this connection:-

(i) all items credited for Continuous survey within the previous 15 months may be accepted without further survey at the Surveyor's discretion.

(ii) all other items are to be surveyed and credited at the date of conversion.

#### Phasing-in of UR Z7.1

The members of WP/SRC agreed unanimously that for general dry cargo ships the phasing-in period of UR Z7.1 will be latest by the first Intermediate Survey or Special Survey, whatever comes first after 1 January 2004.

GPG proposed that as 1 January 2004 had already passed, the changeover from continuous survey to special survey should be carried out as soon as possible but not later than the due date of the next Intermediate or Special Survey or the due date of the end of the five year class period, whichever comes first after 1 July 2005.

April 2004 (corr May 2004)

\*\*\*\*\*

## **Technical Background Document UR Z6 ( Rev. 5 July 2005)**

### **1. Objective:**

Revise text of Z6 to ensure that vessels 10 years of age and over where the survey requirements are based upon Z7 and the vessel is also on a Continuous Survey of Hull in accordance with Z6 that the ballast tanks are being surveyed twice in each five year Special Survey Period.

### **2. Background**

ABS had requested that WP/SRC review the requirements for ballast tanks in Z7 and how they should be applied under Z6 (Continuous Hull Surveys) for vessels 10 years of age and over where the survey requirements require all ballast tanks are to be internally examined at the intermediate survey and special surveys.

WP/SRC developed a draft revision to Z6 and WP/SRC Chairman submitted the revision of Z6 to GPG following the October 2004 meeting.

The revision was considered a minor amendment however at GPG several issues were raised and no consensus could be reached so GPG tasked the Survey Panel to review the matter again taking into account the GPG Correspondence.

### **3. Discussion**

- 3.1 WP/SRC developed a draft revision to Z6 in October 2004.
- 3.2 GPG had several issues that were raised and no decision was made to amend Z6. Survey Panel, in the beginning of 2005, was tasked to review the issues again and amend Z6 as necessary.
- 3.3 Z6.4 was amended by the IACS Survey Panel members, which clearly defined requirements for internal examination of ballast tanks for vessels over 10 years of age as required in Z7, for vessels on Continuous Survey of Hull.

Submitted by Survey Panel Chairman  
20 June 2005

## UR Z7 “Hull Classification Surveys”

### Summary

By this corrigendum, Para. 1.5 of this UR and its footnotes were updated due to withdrawal of UR S21A and merger of its contents into UR S21.

### Part A. Revision History

Version no.	Approval date	Implementation date when applicable
Corr.1 (May 2024)	10 May 2024	-
Rev.29 (May 2022)	11 May 2022	1 July 2023
Corr.1 (Dec 2020)	07 December 2020	-
Rev.28 (May 2019)	30 May 2019	1 July 2020
Rev.27 (Oct 2018)	28 October 2018	1 January 2020
Rev.26 (Jan 2018)	16 January 2018	1 January 2019
Rev.25 (June 2016)	20 June 2016	1 July 2017
Rev.24 (Feb 2016)	12 February 2016	1 July 2017
Rev.23 (Jul 2015)	08 July 2015	1 July 2016
Rev.22 (Feb 2015)	05 February 2015	1 July 2016
Rev.21 (Jan 2014)	14 January 2014	1 January 2015
Rev.20 (May 2013)	22 May 2013	1 July 2014
Rev.19 (July 2011)	27 July 2011	1 July 2012
Rev.18 (Jan 2011)	04 January 2011	1 January 2012
Rev.17 (May 2010)	20 May 2010	1 July 2011
Rev.16 (Mar 2009)	18 March 2009	1 July 2010
Rev.15 (Nov 2007)	15 November 2007	1 January 2009
Rev.14 (Oct 2006)	29 October 2006	1 January 2008
Rev.13 (Aug 2006)	17 August 2006	1 July 2007
Rev.12 (Jan 2006)	4 January 2006	1 January 2007
Rev.11 (Jun 2005)	27 June 2005	1 July 2006
Rev.10 (Apr 2004)	21 April 2004	21 April 2004
Rev.9 (Oct 2002)	22 November 2002	-
Rev.8 (Mar 2002)	22 March 2002	-
Rev.7 (Nov 2000)	20 November 2000	1 July 2001
Rev.6 (Apr 1999)	28 April 1999	-
Rev.5 (Jul 1998)	1 July 1998	-
Rev.4 (1996)	No record	-
Rev.3 (1994)	No record	-
Rev.2 (1992)	No record	-
Rev.1 (1990)	No record	-
New (1990)	No record	-

- **Corr.1 (May 2024)**

**1 Origin of Change:**

- Suggestion by IACS member

**2 Main Reason for Change:**

UR S21A was withdrawn, and its content was merged into UR S21 (with the implementation date of 1 July 2024). Accordingly, there was a need to update Para. 1.5 of UR Z7 and its footnotes.

**3 Surveyability review of UR and Auditability review of PR**

Survey Panel checked the correctness of this corrigendum.

**4 List of non-IACS Member classification societies contributing or participating in IACS Working Group:**

None

**5 History of Decisions Made:**

During the 39<sup>th</sup> Survey Panel meeting, the suggested correction of this UR in the form of corrigendum was unanimously agreed.

No TB is expected for the present revision.

**6 Other Resolutions Changes:**

None

**7 Any hinderance to MASS, including any other new technologies:**

None

**8 Dates:**

Original Proposal	:	22 January 2024	(Ref. PSU24006_ISUa)
Panel Approval	:	7 March 2024	(Ref: 39 <sup>th</sup> Survey Panel meeting)
GPG Approval	:	10 May 2024	(Ref: 24057_IGb)

- **Rev.29 (May 2022)**

**1 Origin of Change:**

- Suggestion by an IACS member

**2 Main Reason for Change:**

To clarify the requirements for thickness measurements for ships without cargo space.

### **3 List of non-IACS Member classification societies contributing or participating in IACS Working Group:**

None

### **4 History of Decisions Made:**

A member of Survey Panel raised the issue how to apply the requirements to ships without cargo space because the thickness measurement requirements within the amidships 0.5L are stipulates only cargo space(s) in table 1. Survey panel reviewed it and agreed to revise the wording considering ships without cargo spaces.

No TB is expected for the present revision.

### **5 Other Resolutions Changes:**

None

### **6 Any hinderance to MASS, including any other new technologies:**

None

### **7 Dates:**

Original Proposal	: 13 January 2021	(Made by a Survey Panel member)
Panel Approval	: 13 April 2022	(Ref: PSU21002)
GPG Approval	: 11 May 2022	(Ref: 22062_IGb)

## **• Corr.1 (Dec 2020)**

### **1 Origin of Change:**

Suggestion by an IACS member

### **2 Main Reason for Change:**

This modification is to correct a reference (change from "2.2.12" to "2.2.9") in para.2.2.2.

### **3 List of non-IACS Member classification societies contributing or participating in IACS Working Group:** None

### **4 History of Decisions Made:**

A member of Survey Panel found one wrong reference in para.2.2.2. Para.2.2.2 is a requirement regarding the hull examination so it should refer to para.2.2.9, but refers to para.2.2.12 which is regarding the examination for piping systems.

### **5 Other Resolutions Changes:**

None

**6 Any hinderance to MASS, including any other new technologies:**

None

**7 Dates:**

Original Proposal: 8 September 2020 Made by a Survey Panel member (PSU20041)

Panel Approval: 23 November 2020 (Ref: 20168\_PYb)

GPG Approval: 07 December 2020 (Ref: 20168\_IGd)

**• Rev.28 (May 2019)****1 Origin of Change:**

- Suggestion by an IACS member

**2 Main Reason for Change:**

2.1 This revision is to address the policy decision made by GPG using the common terminology 'Condition of Class'(CoC) instead of the terms 'Recommendation/Condition of Class' based on the outcome of III 5. (PSU19010)

2.2 Additionally, further revision was agreed to use the harmonized terms of ballast tanks for their survey requirements. (PSU18070)

**3 List of non-IACS Member classification societies contributing through the TC Forum and/or participating in IACS Working Group:**

None

**4 History of Decisions Made:**

4.1 Harmonization of the terms "Recommendation" and "Condition of Class" (PSU19010)

During the 29th panel meeting, the panel discussed about the comments of members, and concurred with the view to retain the present definitions of CoC in the IACS resolutions with the wording 'Recommendation' to be removed. The panel also agreed to use the term 'Statutory Condition' for the 'recommendation' of the statutory certificates in IACS resolutions and RECs, and when discussing the proposal of a member to consider the harmonization of the terms of 'recommendation' and 'condition of class' in RO Code, the panel unanimously agreed to take no action on the IMO instruments, leaving the relevant actions to be decided by the relevant IMO bodies when IACS feeds back to IMO the IACS action on the harmonization of the two terms.

Before the implementation date of 1st July 2020 for using the common terminology 'Condition of Class' only, 'Recommendations' and 'Condition of Class' are to be read as being different terms used by Societies for the same thing, i.e. requirements to the effect that specific measures, repairs, surveys etc. are to be carried out within a specific time limit in order to retain Classification.

Panel members concurred with the view that it is not necessary to develop a new procedure requirement, and agreed to set the implementation date of these IACS resolutions (other than RECs) as 1st July 2020.

4.2 Additional revision to use the harmonized terms of ballast tanks for their survey requirements (PSU18070)

Upon the discussions within Survey Panel under task No. PSU18070, the following changes were decided to be made to UR Z7, Z7.1 and Z7.2:

1. To use "ballast tanks" in lieu of "ballast spaces", "water ballast tanks", "tanks used for water ballast" or "spaces used for water ballast"; and
2. To use "double bottom ballast tanks" in lieu of "water ballast double bottom tanks".

No TB is expected for the present revision.

## **5 Other Resolutions Changes:**

The following IACS resolutions and Recommendations (RECs) were agreed to be revised: (PSU19010)

- Procedural Requirements: PR1A, PR1B, PR1C, PR1D, PR1 Annex, PR3, PR12, PR20, PR35 and the attachment of PR16;
- Unified Requirements: Z7, Z7.1, Z7.2, Z10.1, Z10.2, Z10.3, Z10.4, Z10.5, Z15 and Z20
- Unified Interpretations: GC13
- Recommendations: Rec.41, Rec.96, Rec.98

URs Z7.1 and Z7.2 (PSU18070)

## **6 Any hinderance to MASS, including any other new technologies:**

None

## **7 Dates:**

Original Proposal: 14 January 2019 tasked by GPG (17044bIGm) (PSU19010)  
19 December 2018 Made by: a Survey Panel member (PSU18070)

Panel Approval: 22 March 2019 (PSU19010)  
3 May 2019 (PSU18070)

GPG Approval: 30 May 2019 (Ref: 17044bIGu)

## **• Rev.27 (Oct 2018)**

### **.1 Origin of Change:**

- Suggestion by IACS members

### **.2 Main Reasons for Change:**

To revise UR Z7 to clarify the applicability of FP and AP tanks in UR Z7 Table 1. The relevant text in Recommendation 82 is also to be aligned with the UR Z7.

**.3 List of non-IACS Member Classification Societies contributing through the TC Forum and/or participating in IACS Working Group:**

None

**.4 History of Decisions Made:**

A member noted that the description of current FP and AP tanks in UR Z7 Table 1 and Rec.82 are not completely accurate and recommended to be revised.

During the 27th Survey Panel Meeting, the members reviewed the UR Z7 & Rec.82 and agreed to modify the item 4) of UR Z7 table 1 as "Internals in forepeak and afterpeak ballast tanks."

During the 28th Survey Panel Meeting, the members finalized the revisions of UR Z7 and Rec. 82 and their HFs.

No TB is expected for the present revision.

**.5 Other Resolutions Changes**

Rec.82

**.6 Dates:**

Original Proposal: 07 December 2017 Made by a Survey Panel Member

Panel Approval: 12 October 2018 (Ref: PSU17044)

GPG Approval: 28 October 2018 (Ref: 18160\_IGc)

**• Rev.26 (Jan 2018)**

**.1 Origin of Change:**

- Suggestion by IACS members
- Others (GPG task)

**.2 Main Reasons for Change:**

To introduce:

- The criteria for the steel renewal which belongs under the unified requirements of series S and are related to the net scantling approach.
- The definition of Remote Inspection Technologies
- The criteria for the survey of the downflooding ducts and ventilations ducts which are integrated to the ship's structures.



**.3 List of non-IACS Member Classification Societies contributing through the TC Forum and/or participating in IACS Working Group:**

None

**.4 History of Decisions Made:**

- (1) A member noted that some Unified Requirements of series S (Strength of Ships), such as UR S18, contain criteria addressing the steel renewal for dedicated structures such as transverse bulkheads, cargo hatch coamings and plating. These criteria (based on the net scantling approach) are applicable also to units designed with the gross scantling approach because they refers to particular structures for which it is foresaw the dimensioning (or the design verification) according to the net scantling approach.

Under the task PSU16044 the Panel analysed all URs looking for those containing any structural renewal criteria based on the net scantling approach.

Having found that UR S18 and UR S21a contain steel renewal criteria that need to be taken into account during the thickness measurements review process, the members agreed a new paragraph 1.5, "Thickness measurements Acceptance Criteria", and inserted it in the present revision of UR Z7.

- (2) Members discussed under Panel task PSU 16056 the issue allocated by GPG on 21th October 2016. The subject deals with the review of the UR and Recommendation under Panel responsibility in order to determine whether a revision could need in order to consider the new technologies on Remote Inspections (RIT). The Panel Members concurred to discuss the possible revisions of the UR Z7 in order to address the issue.

A new paragraph 1.2.15 with definition of RIT and new section 1.6 "Remote Inspection Techniques (RIT)" were agreed and inserted in the present revision of UR Z7.

- (3) During 25<sup>th</sup> Survey Panel Meeting, the Panel discussed the proposal made by a Member and relevant to the inspection of the downflooding ducts and ventilations ducts which are integrated to the ship's structures under task PSU17002. The qualified majority of the members agreed to modify the paragraph 2.2.5 of the UR Z7 by introducing the survey requirements for these arrangements to be applied to ship having age of 15 years or more.

No TB is expected for the present revision.

**.5 Other Resolutions Changes**

UR Z3, UR Z7.1, UR Z7.2, UR Z10.3, UR Z17

**.6 Dates:**

Original Proposal: 09 September 2016 (24<sup>th</sup> Survey Panel meeting) Made by a Survey Panel Member. 21 October 2016 assigned by GPG.

02 February 2017 Made by a Survey Panel Member.

Panel Approval: 08 February 2017 (Ref: PSU16044),  
08 December 2017 by Survey Panel (Ref: PSU16056)  
22 May 2017 by Survey Panel (Ref: PSU17002)

GPG Approval: 16 January 2018 (Ref: 16151\_IGq)

## • **Rev.25 (June 2016)**

### **.1 Origin of Change:**

- Suggestion by an IACS member

### **.2 Main Reasons for Change:**

As consequence of review of the paragraph 2.3.1 of UR Z10.2 and UR Z10.5.

### **.3 List of non-IACS Member classification societies contributing through the TC Forum and/or participating in IACS Working Group:**

None

### **.4 History of Decisions Made:**

A member proposed to review paragraph 2.3.1 of UR Z10.2 and UR Z10.5 with the aim to delete the embedded table dealing with the survey requirements of Fuel Oil Tanks located in cargo length area of ESP bulk carriers.

Panel, under task PSU15059, evaluated the reasons of the request since, apparently, the requirements of the said paragraph are the same as those contained in Table 3 of the UR Z7, which is applicable to all ships.

Panel noted the following:

- The revision 17 of June 2005 (harmonisation) of the UR Z10.2 and the revision 1 of June 2005 (harmonisation) of the UR Z10.5 introduced the table into the paragraph 2.3.1. According the technical background of these revisions the matter has been dealt with by a dedicated PT on the basis of a specific task assigned by the GPG
- The requirements for overall inspection of Fuel Oil Tanks located within cargo length area of a ESP Bulk Carrier have to be applied starting from the Special/Renewal surveys no.2. This requirement has the same consistency as those contained in table 3 of the UR Z7 which are applicable to all ship.
- According to the provisions of paragraph 1.1.2 of UR Z10.2 and paragraph 1.1.3 of the UR Z10.5, the fuel oil tanks located within cargo length area are not subjected to the survey provisions of UR Z7
- According to the provisions of paragraphs 4.2.3.1 and 4.2.4.1 of the UR Z10.2 and UR Z10.5 the extent of the intermediate survey (after the ship reached ten years of age) is the same as the previous special/renewal survey. Therefore

the fuel oil tanks might be part of the compartments to be inspected (in fact the same paragraphs leave to the Surveyor the decision whether these need to be inspected).

- The requirements of both UR Z10.2 and UR Z10.5 reflect those set by the ESP Code. Hence any modification of these URs needs to be reflected in the ESP Code, but whereas the removal of these survey requirements from the URs may be supported by the existence of the same requirement in UR Z7 (to which it is always possible to make reference), this is not possible in the ESP Code since this is a self standing document.

Panel agreed that no modification to UR Z10.2 and UR Z10.5 should be applied but, at the same time, concurred that the table 3 of UR Z7 would need to be updated in order to clarify that the survey requirements for fuel oil tanks located within cargo area, are not applicable to ESP bulk carriers subject to UR Z10.2 or UR Z10.5. However, after further discussions, the majority of the Panel members agreed it was not necessary to include such clarification in table 3 since UR Z10.2 and UR Z10.5 clearly state that UR Z7 applies only to the remainder parts of the ship not covered by Z10.2 and Z10.5 which do not include fuel oil tanks.

Moreover Panel noted that the survey requirements of table 3, for fuel oil tanks, are not based on the typology of the service carried out by these but, rather, by their location on board. In fact the possible difference in number of fuel oil tanks to be inspected, for two ships having the same age, depends only on the fact whether one of the two has fuel oil tanks located in cargo area length (since in engine room there is, at least, one or two fuel oil tanks, e.g. daily and/or settling tank).

Panel members agreed to introduce a new row into the table3 of UR Z7, so that the number of fuel oil tanks, to be inspected at special survey, can assure that, regardless the ship configuration and tanks layout, the adequate number of tanks are internally examined.

During the 23<sup>rd</sup> Survey Panel Meeting, Members found a final agreement for the modification of table 3 of UR Z7 by introducing the requirements for the surveys of fuel oil tanks not located in engine room or in the cargo length area.

No TB is expected for the present revision.

## **.5 Other Resolutions Changes**

Nil

## **.6 Dates:**

Original Proposal: 01 December 2015 Made by Survey Panel Member

Panel Approval: 16 March 2016 (Ref: PSU15059)

GPG Approval: 20 June 2016 (Ref: 16104\_IGb)

## **• Rev.24 (Feb 2016)**

### **.1 Origin of Change:**

- Suggestion by an IACS member

## **.2 Main Reasons for Change:**

Review of the paragraph S11A.1.3 of UR S11A (issued in June 2015)

## **.3 List of non-IACS Member classification societies contributing through the TC Forum and/or participating in IACS Working Group:**

None

## **.4 History of Decisions Made:**

Panel evaluated, under task PSU 15036, the newly introduced requirements for the evaluation of the longitudinal strength standard for container ships with particular reference to paragraph S11A.1.3 dealing with the corrosion margin and net thickness.

Members sought the advice of Hull Panel in order to understand whether the requirements are applicable also to the existing ships and whether the thickness measurements of the longitudinal elements contributing to the longitudinal strength of the ship should be evaluated by the surveyor by using the net scantling approach ( $t_{net}$ ).

The Hull Panel provided the following reply:

- The provisions of the new UR S11A are applicable only to new container ships
- The use of the net scantling approach is limited to the evaluation of the residual midship section moduli, however it would be advisable to set a simple criterion in order to allow the evaluation of the residual area of a transverse section which may be handled by the surveyor during the revision of the thickness measurement report.

Panel by acknowledging the contents of the reply wondered if the use of the net scantling approach does not require providing the surveyor with appropriate reporting forms for thickness measurements.

Moreover Members tried to consider the issue of reporting of thickness measurements in a broader way by keeping in mind that there could be Societies that may expect in their own rules for ships (i.e. those not subjected to CSR) two types of hull design verification:

- The traditional by which the calculated thickness is inclusive of the corrosion margins
- The net scantling design.

Considering that the reports of thickness measurements should be prepared every time thickness measurements are required (e.g. during special/renewal surveys), Members concurred that it would be advisable that the thickness measurement reporting forms were provided for both systems (traditional and net scantling design).

During the 22<sup>nd</sup> Survey Panel Meeting Members discussed the issue and agreed that two annexes to UR Z7 containing the thickness measurement report forms, similar to those provided for the UR Z10.2, UR Z10.4 and UR Z10.5, needed to be added. These annexes are not a mandatory requirement under UR Z7, but of recommendatory nature.

The further details of the revision 24 of UR Z7 have been agreed by correspondence.

No TB is expected for the present revision.

## **.5 Other Resolutions Changes**

Nil

## **.6 Dates:**

Original Proposal: 17 July 2015 Made by *Survey Panel Member*

Panel Approval: 28 December 2015 (Ref: PSU15036)

GPG Approval: 12 February 2016 (Ref: 15209\_IGb)

## **• Rev.23 (Jul 2015)**

### **.1 Origin of Change:**

- Suggestion by an IACS member

### **.2 Main Reasons for Change:**

Consider the possibility to have different criteria relevant to the thickness measurements for ships built with metallic material other than steel.

### **.3 List of non-IACS Member classification societies contributing through the TC Forum and/or participating in IACS Working Group:**

None

### **.4 History of Decisions Made:**

Panel evaluated, under task PSU 14042, the issue relevant the consistency (amount) of the thickness measurements to be applied to ships built in metallic material different from steel, such as light alloys.

Members concurred that in the cases where the materials used for the hull construction are corrosion resistant, e.g. light alloys, aluminium, the requisite to apply the same extension of thickness measurements of a steel ship would seem excessive.

Keeping in consideration the above some Members argued that these ships should be excluded by the application thickness measurement campaign at special/renewal survey.

Other Members concurred that notwithstanding the extension of the thickness measurement campaign, expected by the actual provisions of UR Z7, might be excessive for ships built in non-steel metallic materials these ships should be

anyway subjected to a tailored campaign of measurements in order to assess the whole strength of the hull.

During the 21<sup>st</sup> Survey Panel Meeting members discussed the issue and agreed that the consistency of the thickness measurement campaign, for ship's built with metallic materials different from steel, shall be left to the Societies determination in accordance with its own rules.

Panel also agreed the modification of the paragraph 1.4 of the UR Z7 in consistency with the decisions taken

No TB is expected for the present revision.

## **.5 Other Resolutions Changes**

Nil

## **.6 Dates:**

Original Proposal: 22 October 2014 Made by: *Survey Panel Member*

Panel Approval: At 21<sup>st</sup> Survey Panel Meeting (18 March 2015)

GPG Approval: 08 July 2015 (Ref: 15109\_IGb)

## **• Rev.22 (Feb 2015)**

### **.1 Origin of Change:**

- Suggestion by an IACS member

### **.2 Main Reasons for Change:**

Consider appropriate text in IACS document regarding the applicability of the Thickness Measurements when the Close up survey is performed.

- a) Consider appropriate text in IACS document regarding the applicability of the Thickness Measurements when the Close up survey is performed.
- b) To consider the impracticability of the internal structure close up inspection of cargo hold hatch covers which have no access structurally (from the approved design) and it is possible to survey and gauge plating only.

### **.3 List of non-IACS Member classification societies contributing through the TC Forum and/or participating in IACS Working Group:**

None

### **.4 History of Decisions Made:**

- a) Following an ACB query an IACS member proposed to add suitable text in appropriate IACS documents regarding the application of the Thickness Measurements when the close up surveys are performed as survey requirement due at the Intermediate/ Renewal Class surveys. This Member expressed the view that the requirements to execute the Thickness Measurements of the area subject

to Close Up Surveys are expected into the "MINIMUM REQUIREMENTS FOR THICKNESS MEASUREMENTS AT SPECIAL SURVEY" while the paragraph 1.4 of the document contains only the requirement that "Thickness Measurements of the areas subject to close up surveys shall be taken in conjunction with the close up survey".

Panel discussed the matter under item PSU13051 and considered that wordings of Para 1.4 of current UR Z7s/10s need to be revised in order to clarify this issue; finally Panel agreed to add additional wording to Para.1.4.

- b) Panel, following the proposal submitted by a Member, concurred and agreed that in case the cargo hold hatch covers have a configuration that does not permit the ingress of the surveyor for the internal inspection (e.g. box type panel), the close up survey should be limited to external parts as well as the Thickness Measurements that should be performed only on the external plating. The technical background, on which is based the modification of the requirement, is that the internal structure of a hatch cover of box type construction are reasonably not subject to any corrosion phenomenon. Hence, unless the external plating of the box is damaged, no depletion of the internal structures is expectable.

Panel discussed the matter under item PSU13051 and considered that an additional wording to Para 2.2.10.1 and table 1, of current UR Z7, need to be added to clarify this issue.

- c) With this revision the following clerical errors have been corrected:
- in table 1 (MINIMUM REQUIREMENTS FOR THICKNESS MEASUREMENTS AT SPECIAL SURVEY), row 4, column 4 has been corrected as follow: from "4) Internals in forepeak and after tanks." to "4) Internals in forepeak and afterpeak tanks".
  - in paragraph 1.2.10 the definition of FAIR (related to coating condition) has been corrected by adding the missing wording "AND/OR" so that now it reads:

FAIR: condition with local breakdown at edges of stiffeners and weld connections and/or light rusting over 20% or more of areas under consideration, but less than as defined for POOR condition

## **.5 Other Resolutions Changes**

The amendment a) affects UR Z7.1, UR Z7.2, UR Z10.1, UR Z10.2, UR Z10.3, UR Z10.4 and UR Z 10.5.

The amendment b) affects also UR Z7.1, UR Z10.2 and UR Z10.5.

## **.6 Dates:**

Panel Approval: At 19th Survey Panel Meeting (6 March 2014)  
GPG Approval: 05 February 2015 (Ref: 14193\_IGc)

## **• Rev.21 (Jan 2014)**

### **.1 Origin of Change:**

- Suggestion by an IACS member

## **.2 Main Reasons for Change:**

Consider appropriate text in IACS document regarding class period for lengthy conversions.

## **.3 List of non-IACS Member classification societies contributing through the TC Forum and/or participating in IACS Working Group:**

None

## **.4 History of Decisions Made:**

With reference to IMO Res. A1053 (27) (5.5 Application of "special circumstances") an IACS member proposed to add suitable text in appropriate IACS document regarding class period for lengthy conversions. This Member expressed that when a renewal survey has been completed, the new 5 year class period would normally be calculated from the expiry of previous class period/class certificate and in some cases this might result in unreasonably short time from one renewal survey completion until the next renewal would be due.

Panel discussed and considered that wordings of Para 2.13 of current UR Z7s/10s (second sentence) could address this issue but finally agreed to add additional text to Para.2.1.3 in order to clarify this matter.

## **.5 Other Resolutions Changes**

The identical amendment affects UR Z7.1, UR Z7.2, UR Z10.1, UR Z10.2, UR Z10.3, UR Z10.4 and UR Z 10.5.

## **.6 Dates:**

Panel Approval: At 18th Survey Panel Meeting (5 September 2013)

GPG Approval: 14 January 2014 (Ref: 12011aIGd)

## **• Rev.20 (May 2013)**

### **.1 Origin of Change:**

- Suggestion by an IACS member

### **.2 Main Reason for Change:**

a) An inquiry from a member whether the 'Other equivalent means' referred in Para 5.3.2 of IACS UR Z10.2 include the use of Cherry Pickers for survey of other structures. (PSU 12022)

b) A member suggested that UR Z4 and UR Z22 are no longer needed since they have been incorporated into UR Z7. (PSU12038)



### **.3 List of non-IACS Member classification societies contributing through the TC Forum and/or participating in IACS Working Group:**

None

### **.4 History of Decisions Made:**

- a) Discussion of this matter initiated by a Panel member regarding the use of Cherry Pickers in Cargo Holds with reference of IACS URZ10.2. In accordance with UI SC191 and Rec 91, the Cherry Picker is allowed up to 17m height for Cargo Hold structure (ships constructed after 2006 for Alternative means of access). As per the provisions of URZ10.2, Cherry pickers are allowed for survey of side shell frames only.

Panel discussed and considered that Para 5.3.2 of UR Z10.2 allows the use of Cherry Pickers as 'Other equivalent means'. Accordingly, Panel agreed to clarify this matter by including text "hydraulic arm vehicles such as conventional cherry pickers" to UR Z10s and UR Z7s for a ship not subject to the above 17m restriction.

- b) Panel reviewed the suggestion of an IACS member to delete UR Z4 and UR Z22. In order to delete UR Z4 Panel discussed two options, that is- last survey item from Para 4.5 of UR Z4 either to be included as new Para 2.2.10.4 in UR Z7 or there is no need to change the existing text of UR Z7 since Para 2.2.11 covers the survey requirements needed by UR Z4. During 17<sup>th</sup> Panel meeting Panel agreed to delete UR Z4 without any modification of UR Z7.

Panel also agreed to delete IACS UR Z22 with inclusion a new "note" in Table 4, column 3 of UR Z7.

### **.5 Other Resolutions Changes**

- a) The identical amendment affects UR Z7.1, UR Z10.1, UR Z10.2, UR Z10.3, UR Z10.4 and UR Z 10.5.

### **.6 Dates:**

Panel Approval: 7 March 2013 during Survey Panel Meeting  
GPG Approval: 22 May 2013 (Ref: 9640\_IGn)

## **• Rev.19 (July 2011)**

### **.1 Origin of Change:**

- Suggestion by an IACS member

### **.2 Main Reason for Change:**

Following external audit a member was advised that a small temporary doubler on a cross-deck strip of a bulk carrier should have been promptly and thoroughly repaired at the time of survey. The member carried out an investigation and found that the actions of the surveyor were fully justifiable, the temporary repair and short term

Condition of Class imposed were an appropriate method of dealing with such a situation. The member advised that the current requirements for 'Prompt and Thorough Repair' stipulated under the UR 7 and UR 10 series do not give any leeway for carrying out temporary repairs (and imposing a Recommendation/Condition of Class in accordance PR 35) where the damage in question is isolated and localised, and in which the ship's structural integrity is not impaired.

The Survey Panel discussed the matter and agreed that under carefully defined circumstances a temporary repair and short term Recommendation/Condition of Class would be an appropriate course of action.

**.3 List of non-IACS Member classification societies contributing through the TC Forum and/or participating in IACS Working Group:**

None

**.4 History of Decisions Made:**

The matter was discussed by correspondence within the Survey Panel and at the Autumn 2010 Panel Meeting. Following discussion at which the possibility of a Unified Interpretation being raised was considered, it was eventually decided to make direct amendment to the relevant Unified Requirements.

The wording of the new paragraph to be inserted as Para 1.3.3 in all relevant Unified Requirements was extensively discussed prior to agreement.

The proposal was unanimously agreed by Survey Panel Members.

**.5 Other Resolutions Changes**

The identical amendment affects UR Z7, UR Z7.1, UR Z7.2, UR Z10.1, UR Z10.2, UR Z10.3, UR Z10.4 and UR Z 10.5.

**.6 Dates:**

Original Proposal: *September 2010 Made by a Member*

Panel Approval: *March 2011*

GPG Approval: *27 July 2011 (Ref: 11118\_IGb)*

**• Rev.18 (Jan 2011)**

**.1 Origin of Change:**

- Suggestion by an IACS member, further to an external audit, where the question of the applicable requirements for intermediate survey of cargo tanks of supply vessels over 10 years of age was raised.

**.2 Main Reason for Change:**

To include classification requirements in UR Z7, for the intermediate survey of cargo spaces of ships over 10 years of age, for ships other than ships engaged in the carriage of dry cargoes only or ships subject to Z10.1, Z10.3, Z10.4 or Z7.2.

This is in order to align UR Z7 with UR Z1: UR Z1 identifies intermediate survey requirements based on IMO Res.A.997(25) as amended by IMO Res. A.1020(26) which are, as a minimum, to be covered by classification surveys.

**.3 List of non-IACS Member classification societies contributing through the TC Forum and/or participating in IACS Working Group:**

None

**.4 History of Decisions Made:**

The decision was made to keep the current para. 4.2.5 of UR Z7 which reflects item (CIn) 2.3.2.4 of the IMO Res. (dry cargo ships over 15 years of age, other than bulk carriers ESP or general dry cargo ships subject to Z7.1) and to add a requirement in a new para. 4.2.6 to reflect item (CIn) 2.3.2.3 of the IMO Res. Both the items are already part of UR Z1.

The Panel was also of the view that supply vessels cannot be considered as "General Dry Cargo Ships" carrying solid cargoes and thus they fall automatically outside the scope of UR Z 7.1. Consequently, no reference to "supply vessels" is needed in the exemption list in para. 1.1.1 of UR Z 7.1.

**.5 Other Resolutions Changes**

None

**.6 Dates:**

Original Proposal: *July 2010 Made by the Survey Panel*

Panel Approval: *October 2010*

GPG Approval: *04 January 2011 (Ref: 10167\_IGd)*

**• Rev.17 (May 2010)**

**.1 Origin for Change:**

Suggestion by IACS member

**.2 Main Reason for Change:**

To improve requirements in UR Z7 for access to structure for survey.

**.3 History of Decisions Made:**

The Survey Panel reviewed the AVC Chairman's report to C59 on Quality Management Review with respect to thickness measurements in the context of PR 19, but following correspondence and discussions during the '10th Survey Panel meeting', members

agreed that the provisions of PR 19 were adequate though the implementation might be inconsistent.

In this context ABS pointed out possible difficulties in surveying bulkheads of general dry cargo ships protected by wooden insulation. Accordingly, this issue was discussed within the Panel.

Draft form A for Survey Panel Task 68 was submitted to GPG on 29 Dec 2009. GPG approved Form A on 29 Jan 2010 and invited the Panel to take into consideration the following issue raised by RINA: *"it is not clear to us the reason why the Panel agreed that the proposed amendments to UR Z7 would apply to "ships other than those covered by UR Z 7.1, Z 7.2 and Z 10s" (see the last sentence of the "Background" section). In fact, we are of the opinion that the proposed amendments to UR Z7 should apply also to the ships subject to UR Z7.1, Z7.2 and Z10s in the zones outside the scope of UR Z7.1, Z7.2 and Z10s (i.e. zones other than cargo area and ballast tanks)."* At the Panel's March 2010 meeting, the RINA member explained the grounds of the above-mentioned issue and the Panel agreed to delete the proposed Note indicating that the amendments would "apply to all ships except those subject to UR Z 7.1, Z 7.2 and Z 10s".

#### **.4 Other Resolutions Changes**

None

#### **.5 Any dissenting views**

RS Survey Panel Member recommended that specific requirements about new types of insulation to be removed for examination of underlying structure be included in the UR, even if in a different way and to a different extent from other types of insulation, such as loose insulation. However, this recommendation was not supported by the majority of the panel.

#### **.6 Dates:**

Original Proposal: *16 August 2009, made by Survey Panel*  
Survey Panel Approval: *2 February 2010*  
GPG Approval: *20 May 2010 (Ref. 10002\_IGb)*

#### **• Rev.16 (Mar 2009)**

Survey Panel Task 62 – see TB document in Part B.

#### **• Rev.15 (Nov 2007)**

Survey Panel Task 1 (*Concurrent crediting of tanks*) – see TB document in Part B.

- **Rev.14 (Oct 2006)**

Survey Panel Meeting March 2006 New Business Item – *Applying UR Z3, Z7, Z18 and Z21 for Military Vessels.*

See TB document in Part B.

- **Rev.13 (Aug 2006)**

Survey Panel Task 39 – see TB document in Part B.

- **Rev.12 (Jan 2006)**

Survey Panel Task 22 – see TB document in Part B.

- **Rev.11 (Jun 2005)**

WP/SRC Task 102 – *Harmonisation of UR Z7s and Z10s*

See TB document in Part B.

- **Rev.10 (Apr 2004)**

Deletion of para 5.4.5 – no TB document available.

- **Rev.9 (Oct 2002)**

WP/SRC Tasks 91, 93, 95, 98 – no TB document available.

- **Rev.8 (Mar 2002)**

WP/SRC Task 83 – see TB document in Part B.

- **Rev.7 (Nov 2000)**

WP/SRC Task 77 – see TB document in Part B.

- **Rev.6 (Apr 1999)**

WP/SRC Task 44 – see TB document in Part B.

- **Rev.5 (Jul 1998)**

No TB document available.

- **Rev.4 (1996)**

No TB document available.

- **Rev.3 (1994)**

No TB document available.

- **Rev.2 (1992)**

No TB document available.

- **Rev.1 (1990)**

No TB document available.

- **New (1990)**

No TB document available.

## **Part B. Technical Background**

List of Technical Background (TB) documents for UR Z7:

Annex 1. **TB for Rev.6 (Apr 1999)**

See separate TB document in Annex 1.

Annex 2. **TB for Rev.7 (Nov 2000)**

See separate TB document in Annex 2.

Annex 3. **TB for Rev.8 (Mar 2002)**

See separate TB document in Annex 3.

Annex 4. **TB for Rev.11 (Jun 2005)**

See separate TB document in Annex 4.

Annex 5. **TB for Rev.12 (Jan 2006)**

See separate TB document in Annex 5.

Annex 6. **TB for Rev.13 (Aug 2006)**

See separate TB document in Annex 6.

Annex 7. **TB for Rev.14 (Oct 2006)**

See separate TB document in Annex 7.

Annex 8. **TB for Rev.15 (Nov 2007)**

See separate TB document in Annex 8.

Annex 9. **TB for Rev.16 (Mar 2009)**

See separate TB document in Annex 9.

Annex 10. **TB for Rev.17 (May 2010)**

See separate TB document in Annex 10.

Annex 11. **TB for Rev.18 (Jan 2011)**

See separate TB document in Annex 11.

Annex 12. **TB for Rev.19 (July 2011)**

See separate TB document in Annex 12.

Annex 13. **TB for Rev.21 (Jan 2014)**

See separate TB document in Annex 13.

**Note:** *There are no separate Technical Background (TB) documents for the original resolution (1990), Rev.1 (1990), Rev.2 (1992), Rev.3 (1994), Rev.4 (1996), Rev.5 (Jul 1998), Rev.9 (Oct 2002), Rev.10 (Apr 2004), Rev.20 (May 2013), Rev.22 (Feb 2015), Rev.23 (Jul 2015), Rev.24 (Feb 2016), Rev.25 (June 2016), Rev.26 (Jan 2018), Rev.27 (Oct 2018), Rev.28 (May 2019) Corr.1 (Dec 2020), Rev.29 (May 2022) and Corr.1 (May 2024).*



**Technical Background Document  
WP/SRC Task 44 (Z 7)**

**Objective and Scope:**

Develop requirements for examination of specific components of ship's bow, stern, side and inner weathertight doors by specialist company at annual, intermediate and special classification surveys.

**Source of Proposed Requirements:**

The proposed requirements were developed by WP/SRC members through their experience in the examination of the weathertight doors. IACS Guidelines No. 8, Checksheet for Surveyors of Ro-Ro Ships Shell and Inner Doors Guidelines for Surveyors was referenced for requirements.

**Points of Discussion:**

WP/SRC unanimously agreed to the draft UR.

Date of submission: 31/3/99  
By: WP/SRC Chairman's e-mail

**Technical Background Document**  
**WP/SRC Task 1-A**  
**UR Z 7 – Proposed Rev. 6**

**Objective and Scope:**

To review existing UR Z 7 to which a reservation has been lodged with a view to eliminating the cause for the reservation and achieving full implementation.

**Source of Proposed Requirements:**

WP/SRC members discussed and reviewed the reservation lodged against the UR. A proposal based upon the member's experience with soft coatings in small tanks was agreed to and contained in the proposed draft.

**Points of Discussion:**

WP/SRC unanimously agreed to the proposed draft UR Z 7.

**Technical Background Document**  
**WP/SRC Task 77**  
**UR Z7 – Proposed Draft Revision 7**  
**(Including Rev.8 of Z10.1, Rev.11 of Z10.2, Rev.4 of Z10.3)**

**Objective and Scope:**

Extend the requirements for permanent repairs at the time of survey in UR Z 10.2 to all ships.

**Source of Proposed Requirements:**

The proposed requirements were developed by WP/SRC members through correspondence and discussions at the September 2000 meeting.

**Points of Discussion:**

UR Z7 was amended to apply “prompt and thorough” repairs to all vessels. The new wording defines a prompt and thorough repair to be a repair as a result of wastage and not an incident such as contact damage where a temporary repair or deferral of repairs could be permitted. This wording is more explicit than the wording in UR Z10.2 and should achieve a uniform application among the Members.

WP/SRC also agreed to include these requirements in Z10.1, Z10.2 and Z10.3 in order to not effect A.744(18).

WP/SRC unanimously agreed to the draft UR.

Note by Permsec

GPG 49 (11-13 Oct. 2000) agreed that the same changes be introduced to Z10's and carried out editorial review of Z 10's.

**Technical Background Document**  
**WP/SRC Task 83**  
**Rev.8 of Z7 (para. 2.2.6 + Table 1, also see the attached)**

**Objective and Scope:**

To introduce additional survey requirements to address machinery failures and engine room flooding problems.

**Source of Proposed Requirements:**

WP/SRC Chairman reported by e-mail 15 January 2002 that WP/SRC Members had discussed and reviewed the requirements contained in UR Z7 through correspondence and at their last meeting.

When dealing with this task the WP/SRC agreed not to address the issue of machinery component failures due to the fact that the necessary competence was not available within the WP. The WP members were also of the opinion that WP/MCH was more able to deal with this part of the task.

**Points of Discussion:**

- WP/SRC unanimously agreed to the proposed amendments to Z7.

Note by the Permanent Secretariat (0065fIGc of 19 February 2002)

- GPG agreed with ABS that in lieu of the WP's proposed additional wording to item 9 of Table 1, **an additional item 10** should be added to the table in order to provide clarification with regard to the plating of the sea chest.
- With respect to the issues of machinery component failures, GPG decided as follows:
  - AHG/CMC review the casualty report and database developed under 9168e at their March 2002 meeting with a view to assessing the additional info on machinery/equipment damages reported therein in relation to the database of machinery/equipment failures the AHG has been developing (AHG/CMC Task 01 Rev.1);
  - AHG/CMC is to provide both databases (information) to WP/MCH with their comments in time for WP/MCH to review and discuss the materials at their Fall 2002 annual meeting;
  - WP/MCH is then to assess and identify problem areas and provide recommendations for improvement (MCH Task 68).
  - WP/MCH is to provide proposals to AHG/CMC and WP/SRC(Task 83 Rev.1) for their review during 2004.

Date of submission: 5 March 2002  
By the Permanent Secretariat

**Technical Background Document**  
**WP/SRC Task 1**  
**New UR Z 18, Z21 and deletion of M20**  
**(+ Rev.8 of Z7)**

**Objective and Scope:**

To review existing UR M 20 and relocate it as a UR under UR Z.

**Source of Proposed Requirements:**

WP/SRC Chairman reported by e-mail 6 May 1999 that WP/SRC Members had discussed and reviewed the requirements contained in UR M20 through correspondence and at their last meeting and had relocated the text of M20 to a new UR Z18. A proposal for resolving ABS' existing reservations against M20 is included in the proposed UR Z18.

**Points of Discussion:**

WP/SRC unanimously agreed to the proposed draft UR Z 18.

Note by the Permanent Secretariat

GPG did not accept WP/SRC's proposal for resolving ABS' reservations since the proposal would not, in fact, lead to any greater uniformity in practice than by simply retaining ABS' existing reservations, and therefore did not approve the proposed UR Z18, pending receipt and consideration of an acceptable means of resolving ABS' reservations from the ABS GPG representative. The ABS GPG representative reported to GPG, at its 51<sup>st</sup> meeting on 2-4 October 2001 that ABS was not prepared to change its practice and that he could not identify any means of resolving ABS' reservations without significant change to other Members practices, which other Members were not prepared to accept.

Therefore, GPG expressed its preparedness to live with ABS reservation to the tail shaft survey requirements of ex M20 (now Z21), agreed to isolate it from Z18.

Outcome:

- Delete M 20;
- Create new Z18 excluding tail shaft survey requirements;
- Create new Z21 for the tail shaft survey requirements.
- Revision 8 of Z7 to have the same descriptions of special survey as those in Z10s and Z18.

(GPG considered it prudent to keep Revision 8 of Z7 in abeyance until WP/SRC complete its Task 83 "revision of Z7".)

Date of submission: 6 May 1999  
By WP/SRC Chairman's e-mail

**WP/SRC Task 102**  
**HARMONIZATION OF UR Z7s AND Z10s**

**Technical Background**

**UR Z7 (Rev. 11)**

**UR Z7.1 (Rev. 2)**

**UR Z10.1 (Rev. 12)**

**UR Z10.2 (Rev. 17)**

**UR Z10.3 (Rev. 7)**

**UR Z10.4 (Rev. 2)**

**UR Z10.5 (Rev. 1)**

Contents:

TB for Harmonization

**Annex 1.** TB for UR **Z10.1(Rev.12**, C49 amendments(coating-related))

**Appendix 1:** Memo for Coating, submitted to Council  
49(June 2004).

**Appendix 2:** DNV proposal (25 May 2005) agreed by Council

**Annex 2.** TB for "Verification/Signature of TM Forms" for records.

**Annex 3.** TB for revision of UR Zs concerning "anodes".

**1. Objective**

To amend UR Z7s and Z10s in order to make the texts of the above-mentioned URs consistent eliminating all the differences both in substance and in wording (WP/SRC Task 102).

**2. Background**

In the process of approving UR Z10.4, GPG found it necessary to amend the other existing URs Z10.1, Z10.2, Z10.3, Z10.6 and Z7 in order to eliminate any inconsistencies existing among them.

**3. Methodology of work**

The WP has progressed its work through many sessions, both during the periodical meetings and dedicated meetings restricted to a Small Group of Members (BV, DNV, GL, LR, RINA) who developed the work in order to be more efficient. All the proposed amendments of the Small Group have regularly been circulated to all Members for comment and agreement.

## 4. Discussion

4.1 The WP/SRC has completed a comprehensive comparative review of UR Z7 and Z10s, and identified inconsistencies which existed among them. During this review, attention was given to the severity of the requirements applicable to the same spaces/structural areas on different types of ESP ships. As a result, the inconsistencies were eliminated making the URZs harmonized. However, there has been no change to the scope and extent of the survey requirements.

4.2 The starting point for each UR was the most updated version available at the time of commencement. Any revision to the URZs, which were introduced during this task, was taken into account. As for instance, the UR Z10.1 was initially amended based on Rev. 9, while the last amendments are based on Rev. 11 and the UR Z10.2 was initially amended based on Rev. 13, while the last amendments are based on Rev. 16. The proposed revisions of URs Z10.1 and Z10.4 have not been numbered, as there will be revisions to those URs before the revisions introduced by the Task 102 are adopted. In fact, GPG is currently developing a Revision 12 of Z10.1 with the view to introducing significant improvements in the survey regime for ballast tanks (including combined cargo/ballast tanks) of oil tankers and UR Z10s applicable to oil tankers will also have to be revised by incorporating the amendments to A.744(18) contained in Resolution MSC 144(77), which enter into force 1 January 2005 (see 4.3 below).

4.3 Also, in harmonizing UR Z10.1 and Z10.2 care has been taken to align the corresponding text with that of IMO Res. A.744(18). However, it has been noted that the amendments to A.744(18) contained in Resolution MSC 144(77), which enter into force 1 January 2005, have not been incorporated into the IACS UR Z10s applicable to oil tankers. It seems that the updating of the above-said UR Z10s will be done by the Perm Sec and reviewed by the WP/SRC Chairman and then circulated for adoption by GPG with concurrence of Council Members for uniform application from 1 January 2005. It is understood that the revisions of the UR Z10s affected by those amendments will not include the changes introduced by the Task 102, as the implementation date proposed for those changes is 1 January 2006 (see below **6. Implementation**).

4.4 In the course of the work the WP has been developing for more than two years, several additional Tasks were assigned to the WP by GPG which affected the development of Task 102. The additional tasks which have been taken into account are the following:

- 1) In the course of Council discussion on UR Z10.6 (General Cargo Ships), certain inconsistencies were identified between Z10.6 and other Z10s. WP was instructed to expedite Task 102 (1060gIAa, 12 June 2002);
- 2) WP was instructed to include "Survey Planning for Intermediate Survey" into harmonization work (2108\_IAa, 12 July 2002);
- 3) GPG instructed WP to consider whether Z10.6 should be re-assigned as Z7.1, in connection with the harmonization work. 1060gIAb, 20 Sept 2002.

- Z7.1 developed;
- 4) Partial outcome (Z7 and Z7.1) was submitted to GPG on 17 July 2003(1060g). Council decided that approval of Z7(Rev.10) and Z7.1(Rev.2) is postponed until the harmonization is completed (1060gICb, 6 April 2004);  
[Council Chairman instructed WP/SRC to Members' comments on the draft revision of UR Z7 and Z7.1 \(collected under s/n 1060g, 1060gNKi \(30/03/2004\) in particular\) on 6 April 2004.](#)
  - 5) GPG tasked WP to include the amendments to Z10.2 / Z11 (BCs with hybrid cargo hold arrangements), deleting sheets 15 and 16 for ore carriers, into the harmonized UR Z10s (2212aIGa, 19 Jan 2004);
  - 6) GPG tasked WP to consider whether the requirements relevant to examination of Fuel Oil Tanks in the cargo area at each Special Survey should be put into Z10s, and internal examination of FOT at Intermediate Survey after SS 2 is needed. (1060gIAf, 30 Jan 2004);
  - 7) GPG tasked WP to harmonize tank testing requirements in Z7s and Z10s. (3006IIAa, 5 April 2004);
  - 8) GPG tasked WP with Task 108 - Develop uniform survey requirements for air vent pipes including the welded connection to deck. Z22 developed. GPG instructed WP to incorporate Z22 into the harmonized Z10s;
  - 9) GPG tasked WP with Task 114 - Verification and signature of TM reports. REC 77(Rev.1) developed and approved on 29 July 2004. Council approved parallel amendments to Z7.1 and Z10s (TM Forms included) and instructed WP to incorporate these into the harmonized Z10s:
    - [Recommendation No.77 was revised \(Rev.1, July 2004\);](#)
    - [Z7.1 para.6.3.2 and Z10s para.7.3.2 so amended.](#)
    - ["Surveyor's signature" is deleted from all TM Forms in Z10s;](#)
    - [A note is added to Annex II\(Z10s\) declaring that Annex II is recommendatory.](#)

WP/SRC's investigation into Members' practice in dealing with verification and signature of TM reports is annexed for record keeping purpose. [See Annex 2.](#)
  - 10) GPG tasked WP to consider the BV comments on "TM may be dispensed with..." and include the findings into the harmonized Z10s ( 2219iIAa, 7 April 2004).

## **5. Agreement within the WP/SRC**

All Members have unanimously agreed the attached final versions of UR's.

## **6. Implementation**

WP/SRC is of the view that the Members need 12 months from the adoption date to implement these amendments into their class rules. Assuming Council adoption in December 2004, WP/SRC would propose January 2006 as implementation date.



- Annex 1:** TB for UR Z10.1(Rev.12, C49 amendments, see Permsec's note 1 below)  
**Annex 2:** WP/SRC Task 114, verification and signature of TM reports(see 9 above).  
**Annex 3:** TB for revision of UR Zs concerning "anodes".

### **Note by the Permanent Secretariat**

1. Annex 1 to this TB contains background for amendments to UR Z 10.1(Rev.12) relating to FAIR/POOR/GOOD (C49 amendments). Council at its 49<sup>th</sup> meeting (June 2004) agreed/decided that comparable changes should be added to Z10.3 and Z10.4.
  
2. Appendix 3 "TM sampling method" has been added to UR Z10.1 and Z10.4 to keep them consistent with IMO Res.MSC.144(77). The amendments to A.744 contained in MSC.144(77) entered into force on 1 January 2005. (*GPG s/n 4181*)  
  
Under s/n 4072g, paragraph **2.4.6** of UR Z10.1 and **2.4.6** and of UR Z10.4 (paragraph numbering is now harmonized) were amended in order to provide a link between the main text of the UR Z10.1 and 10.4 and the new Annex III Appendix 3 containing the MSC Res.144(77).  
Further, it was agreed that the requirements for evaluation of longitudinal strength of the hull girder (as written in MSC.144(77)) should not be required for Intermediate Survey unless deemed necessary by the attending Surveyor. This is covered in 4.2.3.1 and 4.2.4.1 of Z10.1 and Z10.4.
  
3. GPG agreed that the amended UR Zs should be implemented from 1 July 2006 altogether.
  
4. DNV's proposed amendments to UR Z10.1, Z10.3 and Z10.4 concerning annual survey of ballast tanks were agreed by Council (1060gICq, 27 June 2005). See Appendix 2 to Annex 1.
  
5. Annex 3 contains a TB for revision of UR Zs concerning "anodes".

Date: September 2004  
Prepared by the WP/SRC

---

## **Annex 1 to Technical Background**

### **UR Z 10.1 (Rev.12, C49 amendments(coating-related))**

#### **1. Objective**

To introduce significant improvements in the survey regime for ballast tanks (including combined/ballast tanks) of oil tankers as matter of strategic concern and urgency to IACS, given the aging of both the single and double hull tanker fleets and the problems encountered with corrosion of ballast tanks in several shipping casualties.

#### **2. Background**

Draft amendments to UR Z10.1 were submitted to Council 47 (June 2003) and agreed in principle.

#### **3. Discussion**

There was particular concern over accelerated corrosion with age (as the thinner the material, the more rapidly the allowable diminution margin percentage disappears) especially where coatings have broken down. There is also a disincentive for any spend on maintenance of the structure of a ship within a few years of its statutory scrapping date.

Council discussion by correspondence had evolved to the position of substantive proposals – summed as follows (3095\_ABa, 2 June 2003):

1. Enhance the Intermediate Survey in Z10.1, Z10.3 and 10.4 for Tankers after 2<sup>nd</sup> Special / Renewal Survey to the same level (scope of work) as the preceding Special / Renewal Survey). This corresponds to the latest revision to UR Z10.2.
2. At Annual Survey of ballast tanks with substantial corrosion, the overall survey is to be replaced by close-up survey with thickness measurements of the exposed area.
3. Proposed to task WP/SRC to re-consider the acceptance criteria for the rating FAIR further. For this, eliminate FAIR, leaving only GOOD and POOR redefined as appropriate.
4. Proposed to task WP/SRC to explicitly require close-up survey of Suspect Areas identified at the previous Special Survey.

Council 47 discussed the proposals(June 2003) as follows:

##### **1. Definition of FAIR**

Council 47 agreed that “FAIR” would be retained as a rating and that GPG should instruct WP/SRC to redefine FAIR, so that there would be a clear differences between FAIR, POOR and GOOD. It was also agreed that for oil tankers the Intermediate Survey following Special Survey No.2 would have the same scope as Special Survey No.2(Z10.1). WP/SRC should also clarify the definition of satisfactory repair.

Based on the strong majority, Council agreed to discuss with Industry annual surveys of ballast tanks when coating is found in LESS than GOOD condition at special survey, with the objective to encourage the owner to carry out repairs and maintenance of coating to GOOD condition.

*DNV and NK stated that they could not accept a requirement for annual surveys of ballast tanks when the coating condition is less*

*than GOOD and proposed that GOOD be changed to FAIR (3095\_IGc, 30 June 2003)*

2. ABS' proposed amendments to Z10.1(annual examination of BWTs in certain conditions) were approved.
3. C 47 agreed that the BWT coating requirements (Z10.1.2.2.3) for intermediate Survey after SS 2 should be the same extent to the previous SS.
4. Given the substance of the changes, the revised Z10.1 should be shown to Industry before adoption.
5. A guidance for coating repairs needs to be developed by WP/SRC with reference to TSCF Guidelines.

Following Council 47, the draft text of Z10.1(Rev.12) was distributed to Industry and discussed at the IACS/Industry meeting on 29 August 2003. Industry indicated that UR Z10.1(Rev.12) is acceptable, provided that appropriate IACS guidelines on coating repairs are developed.

The Small Group on Coating (SG/Coating) under WP/SRC prepared draft guidelines on coating repairs and considered the definitions of GOOD / FAIR / POOR. The SG/Coating did not change the definitions and found that the Guidelines provide useful clarifications on the definitions and criteria in achieving an industry wide uniform judgement of coating conditions as well as what is needed to restore GOOD conditions.

Further, an IACS/Industry JWG/Corrosion was established and met in February 2004. The outcome is (3095\_IGh, 4 June 2004):

- Draft Guidelines on Coating Repair (IACS REC 87)
- Draft UR Zxx (mandatory coating of cargo tanks on oil tankers)
- Draft UI SC 122 (Rev.2) – mandatory coating of ballast tanks

#### **4. Others**

1. Z10.11.2.2bis - Definition of “Combined Cargo/Ballast Tank. ...as a routine part of the vessel's operation and will be treated as a Ballast Tank. ...”. By so amending, Z10s do not need to repeat “Ballast Tanks and Combined cargo/salt water Ballast Tanks” in addressing the ballast tanks. Hence, all the references to “and Combined cargo/salt water Ballast Tanks” were deleted.
2. Z10.1.2.2.1.2: The aim of the examination is to be sufficient to discover substantial corrosion...  
Comparable changes are to be added to other UR Zs wherever the same sentence occurs.
3. “IACS Guidelines for Coating Maintenance & Repairs for Ballast Tanks and Combined/Ballast tanks on Oil Tankers” are referenced where relevant.
4. Comparable changes are to be added to UR Z10.3 and Z10.4, after adoption of Z10.1(Rev.12).

**Attached: Memo on Coating Matters (GPG Chairman)**

9 June 2004  
Prepared by the Permsec

## **Appendix 1 to Annex 1:**

## **MEMO on Coating matters**

### **1. Background and discussion within IACS on UR Z10.1 (draft Rev.12) between 29/01/03 and 14/08/03**

In view of the survey experience with oil tankers, it was proposed that all ballast tanks should be examined, routinely and uniformly, at annual surveys on ESP tankers exceeding 15 years of age. IACS should amend UR Z10.1 to require the examination of ballast tanks on such ships at each annual survey. This is simple, clear and thorough and not subject to interpretation. (2242\_ABq dated 29/1/03)

Then, ABS modified the proposal asking, for tankers subject to URs Z10.1, Z10.3 and Z10.4, exceeding 15 years of age, that the current requirement - pertaining to annual examination of Ballast Tanks adjacent to cargo tanks with any means of heating - be deleted and replaced by a simpler and more stringent requirement that all Ballast Tanks be subject to survey at each subsequent annual survey where either substantial corrosion is found within the tank or the protective coating is found to be in less than GOOD condition and the protective coating is not renewed at special survey or intermediate survey. This will ensure that all Ballast Tanks with substantial corrosion or protective coating which is not in GOOD condition at the time of special survey or intermediate survey will be examined at each subsequent annual survey on tankers exceeding 15 years of age. (2242\_ABzb dated 14/3/03)

This was later expanded to include all tanks used routinely for ballast water, both ballast-only and cargo/ballast tanks (2242\_ABzc dated 14/3/03).

ABS further reviewed the issue of the survey of salt water ballast spaces and combined cargo/salt water ballast spaces with ABS' governing bodies in light of recent casualties and survey findings on other tankers. Their review found an increasing amount of coating breakdown/failure and subsequent rapid wastage in key structures after Special Survey No. 2, i.e. after 10 years of age. These conditions are most prevalent in the under deck structure and the side shell structure in way of the deep loadline. In a number of cases the serious wastage has caused fracturing of the under deck longitudinals and in some cases fracturing has extended to the main deck structure. This led ABS to refine proposed amendments to URs Z10.1, Z10.3 and Z10.4 to require (2242\_ABzf dated 9/5/03):

#### **a. For Tankers exceeding 10 years of age**

Salt Water Ballast Spaces and Combined Cargo/Salt Water Ballast Spaces. For tankers exceeding 10 years of age, salt water ballast spaces and combined cargo/salt water ballast spaces are to be internally examined at each subsequent Annual Survey where substantial corrosion is found within the tank or where the protective coating is found to be less than GOOD condition and protective coating is not repaired. Internal examination to be an Overall Survey.

#### **b. For Tankers exceeding 15 years of age:**

Salt Water Ballast Spaces and Combined Cargo/Ballast Spaces. For tankers exceeding 15 years of age, salt water ballast spaces and combined cargo/ballast spaces are to be examined internally at each subsequent Annual Survey. Where substantial corrosion is found within the tank, or where the protective coating is found to be in less than GOOD condition and the protective coating is not repaired then in addition to an Overall Survey, under deck structure and the side shell structure in way of the deep loadline is to be subject to Close-up Survey.

NK and BV replied that the proposed amendments made by ABS need to be substantiated in a transparent manner with technical data that ABS may possess and put forward for further assessment and discussion. (2242\_NK<sub>n</sub> dated 14/5/03 and 2242\_BV<sub>z</sub> dated 16/5/03)

**DNV** (2242\_NV<sub>n</sub> dated 2/6/03), having carefully considered the practical consequences of taking the ship off-hire for gas freeing etc. and being concerned about the difficulties to have these surveys executed in a safe manner and whether the intended safety benefits in implementing the proposed extended scope of the annual survey of Ballast tanks will be met, **proposed the following alternative measures** which would be as effective and may not have such delaying effects to the ship:

- 1) Enhance the Intermediate Survey in UR Z10.1, 10.3, and 10.4 for Tankers after the 2 Special / Renewal Survey to the same level (scope of work) as the preceding Special / Renewal Survey. (This will correspond to the latest revised requirements of UR Z10.2 for Bulk Carriers.)
- 2) At Annual Survey of ballast tanks with substantial corrosion the overall survey should be replaced by close up survey with thickness measurements of the exposed area. (An overall survey of these tanks does not give sufficient information of the development of the areas with substantial corrosion.)
- 3) Further we will not fail to mention that the WP/SRC has proposed to extend the close up survey in cargo and combination tanks to 30% from the 3 Special / Renewal Surveys.
- 4) **Experience has shown that the coating condition rating category FAIR has a tendency to be stretched too far into the POOR condition. We will therefore propose that we task the WP/SRC to reconsider the acceptance criteria for the rating FAIR further.**
- 5) We do also question the need for redefining the definition of combination tanks, particularly since the category I tankers which are the ships that normally are fitted with these type of tanks are to be phased out 2 to 4 years from now. However DNV will not oppose to such a redefinition.

**DNV requested Members to consider the above as an alternative to the ABS proposal, bearing in mind that we ought to present this to the industry prior to deciding.**

ABS (3095\_Aba dated 2/6/03), having further considered its earlier proposals in light of NV<sub>n</sub>, submitted a revised proposal for consideration by Council at C47 and replied to the above 5 DNV proposals as follows:

- 1) ABS fully supports this proposal.
- 2) While ABS agrees with this proposal, it is in fact already provided for in Z7 (3.2.3) and Z10.1 (3.2.5.1)--which require that "Suspect areas (which include any area where substantial corrosion is found) identified at previous Special Survey are to be examined. Areas of substantial corrosion identified at previous special or intermediate survey are to have thickness measurements taken." To us, this implies that close-up survey of these areas is to be done at annual survey in conjunction with the thickness measurements. However, we can

agree to tasking WP/SRC to explicitly require "close-up" survey in this connection and to amend Z7, and all the Z10's, appropriately to make this explicit, if there is majority support for this.

3) We agree that this has been put forward to GPG by WP/SRC via 0237hNVb, 27 May. However, these additional CAS close-up survey requirements do not apply to salt water ballast tanks; only to cargo oil tanks and combined cargo/ballast tanks.

4) **We agree with this assessment and we propose that the only way to eliminate the subjectivity and raise the standard is to eliminate the category "FAIR" completely; leaving only "GOOD" and "POOR" redefined as follows:**

**"GOOD -- condition with no breakdown or rusting or only minor spot rusting.**

**POOR -- any condition which is not GOOD condition."**

5) ABS does not agree with this proposal. We are particularly concerned that we need a very thorough and robust survey regime for these tankers precisely because they are subject to mandatory phase out over the next several years. We are very concerned that without additional IACS requirements, these tanks will receive little or no inspection and maintenance by owners or others after their last special or intermediate survey, if no substantial corrosion is found at that time. Rapid, localized wastage in way of deteriorating coatings may pose significant hazard if the survey regime is not further tightened as we are proposing.

In conjunction with the above comments on DNV proposals, ABS further considered their previous proposal in ABzf and modified it as follows:

- **ABS simplified the proposal to require annual examination of all salt water Ballast Tanks and combined Cargo/salt water Ballast Tanks irrespective of age, when either substantial corrosion is found within the tank or the protective coating is found to be in less than GOOD condition and is not repaired.**
- the requirement for annual (close-up) examination of salt water ballast tanks and combined tanks is already required in Z10.1 (3.2.5.1). ABS proposed adding it to 2.2.3 for clarity and emphasis so that all the conditions which may lead to annual examination of such tanks are listed together in one place.
- Since the principal problem that we are trying to address is rapid, localized corrosion in way of breakdown or deterioration of the protective coating, we are proposing that the coating condition should be found and kept in "GOOD" condition to obviate the need for annual examination. **The attached proposal is made together with the proposals in items 3.1 (intermediate following Special survey 2 to have same scope as prior Special survey) and 3.4 (eliminating "FAIR" and redefining "POOR" as any condition other than "GOOD" condition.**

ABS requested to decide on a course of action at C47 for tightening the survey regime for tankers. They agreed that industry be informed of Council's decisions in this regard prior to IACS making the decision public, but IACS should maintain its independence and take decisive action in this matter. Debate with industry can only lead to delay and to a watering down and compromising of these important requirements.

NK agreed to task WP/SRC to reconsider the acceptance criteria of "FAIR" for clearly define the border between "FAIR" and "POOR" condition. However, **NK strongly opposed the elimination of "FAIR" coating condition from UR Zs** because this can not resolve to remove subjectivity of coating assessment. The three-categorization system of coating condition should be retained. (3095\_NKa dated 5/5/03)

## **Outcome of C47**

At C47, it was agreed that "Fair" would be retained as a rating and that GPG should instruct WP/SRC to redefine "Fair", so that there would be a clear differentiation between "Fair", "Poor" and "Good". It was also agreed that for oil tankers the Intermediate Survey following Special Survey No.2 would have same scope as Special Survey No.2 (Z10.1). WP/SRC should also clarify the definition of satisfactory repair.

Based on strong majority support Council agreed to discuss with Industry annual surveys of ballast tanks when coating is found in LESS than GOOD condition at special survey, with the objective to encourage the owner to carry out repairs and maintenance of coating to GOOD condition.

This matter should be discussed with Industry prior to adoption of any UR by Council.

In a final summary, the Chairman proposed that a constructive dialogue with Industry should take place on the IACS proposal as set out in WP1 plus maintaining 3.2.5.2 modified to say that ballast/combined ballast/cargo tanks will be subject to annual survey when considered necessary by surveyors.

After discussion in the JWG (Industry/IACS), GPG should propose final rules for this matter to Council, including acceptable repair definition.

**FUA 17:** *To instruct WP/SRC to develop guidance on coating repairs and more precise definition of "Fair" coating condition.*

Once approved, these requirements should be incorporated into Z10.3 and Z10.4.

### **FUA 15**

1) *To prepare a draft revision to UR Z10.1 incorporating C 47 decisions:*

- *The definition of "FAIR" remains as it is;*
- *ABS proposed amendments to Z10.1 (annual examination of BWTs in certain conditions) were approved;*
- *C47 agreed that the BWT coating requirements (Z10.1.2.2.3) for Intermediate Survey after Special Survey No.2 should be the same extent to the previous Special Survey.*
- *Given the substance of the changes, the revised UR Z10.1 should be shown to Industry (OCIMG/Intertanko first among others) before adoption for their review and comments.*
- *A guidance for coating repairs needs to be developed by WP/SRC with reference to TSCF Guidelines.*

2) *GPG Members are to confirm the draft revision to Z10.1 in consultation with their WP/SRC members by correspondence. See 3095\_IGa of 13/06/03.*

According to C47 FUA 15, GPG Chairman circulated (3095\_IGa dated 13/6/03) draft amendments to UR Z10.1 as agreed in principle at C47.

Having received a number on comments, GPG Chairman (3095\_IGb dated 27/6/03) informed that the Council Chairman confirmed that GPG is not to amend the principles agreed at C47, i.e. we are not empowered to change "GOOD" to "FAIR" as proposed by DNV and NK, nor to amend the definitions of "FAIR" and "POOR" as proposed by DNV.

DNV's intention to possibly lodge a reservation was noted, however the matter should be raised at Council and not be dealt with by GPG. An amended draft text incorporating the non-substantive changes proposed by Members was circulated.

DNV said that its understanding was that the draft should be circulated to the Industry (ICS, INTERTANKO, and BIMCO) prior to adoption by Council. (3095\_NVc dated 30/6/03)

GPG Chairman (3095\_IGc dated 30/6/03) circulated a draft amendment of UR Z10.1 for Council's agreement and use in discussions with the industry associations.

The draft was generally agreed by GPG but individual Members have requested that the following matters (which were deemed to be outside the remit of GPG in this task) be brought to Council's attention for further consideration:

- 1 DNV and NK stated that they can not accept a requirement for annual surveys of ballast tanks when the coating condition is less than GOOD and propose that GOOD be changed to FAIR.
- 2 In connection with item 1 above, DNV also propose to amend the definitions of FAIR and POOR in order to raise the standard of FAIR.

Council Chairman (3095\_ICb dated 14/8/03) concluded that Council has agreed that the draft amendments to UR Z10.1 attached to IGc reflect Councils' decision taken at C47 and that they be circulated to industry associations.

Perm Sec was therefore invited to submit the draft to OCIMF and INTERTANKO in view of discussion at the IACS/ industry meeting on 29 August.

## **2. Discussion with Industry (29/08/2003 – 11/10/2003)**

As requested by Council, the whole matter was presented to Industry during the “general matters” meeting with IACS held on 29 August 2003; comments from Industry were requested. In the following an extract from the minutes of the meeting (see message 3100aIAb dated 5 September 2003):

\_\_\_\_\_ from Meeting minutes \_\_\_\_\_

## **4. & 5. Annual surveys of ballast tanks and IACS guidelines on coating repairs**

M. Dogliani introduced the matter ([see Items 4&5 in Appendix](#)).

A. LinoCosta gave a presentation to show where concerns and decisions stand: too many cases when coating was considered fair at SS but problems occurred just after one/two years.

N. Mikelis commented on draft amendments to Z10.1 (Rev.11) stating that the extent of annual survey is not clear; it should be limited to the affected zones, e.g. coating breakdowns, only.

M. Guyader clarified that, in this draft amendments, it is expected an overall survey of the whole tank and a close up survey of the affected zones.

N. Mikelis noted that, in the draft amendments to Z10.1 (Rev.11), the intermediate survey at 12.5 years would have the same scope as the previous special survey and that needed a justification. See 7 a).

M. Dogliani said that Z10.1 (Rev.11) was adopted in August 2003 and will be introduced into IACS Societies' Rules over the next year.

### Conclusions:

4.1 Industry shared IACS concerns on coatings and, in general, agreed with the draft amendments to Z10.1 (Rev.11) suggesting also extending them to Z10.2 on bulk carriers



4.2 Industry agreed that a guideline for surveyor on coating would greatly improve uniform application of so-amended Z10.1 including issues such as how to consider load bearing elements when judging GOOD/FAIR/POOR status and how to consider bottom pitting in connection with GOOD conditions

4.3 Industry will more precisely comment, by the end of September, the draft Z10.1 so as for IACS to finalise the matter, as planned, for the Council's December meeting.

Item	Title	Industry recommendation	IACS/ M. Dogliani Introduction
4 & 5	Annual survey of ballast tanks IACS guidelines on coating repairs	NN	<p><b>1. IACS is considering the following:</b></p> <ul style="list-style-type: none"> <li>- <b>amend UR Z10.1 (draft circulated to Industry) to the effect that in case at Special Survey or Intermediate Survey the coating in a ballast tank is found less than GOOD, either GOOD conditions are restored or the tank's coating is inspected at each annual survey;</b></li> <li>- <b>develop IACS guideline to assist an uniform application of the so modified (if adopted) UR Z10.1; the guideline should address which repairs are necessary to restore GOOD conditions from FAIR and POOR respectively and which are the criteria for the restored (after repair) situation to be rated as GOOD.</b></li> </ul>

\_\_\_\_\_ End of extract from minutes \_\_\_\_\_

INTERTANKO commented (see R. Leslie email to GPG dated 25 September 2003):

- expressing their concern for the draft Z10.1 and underlining
  - a) targeting: concerns that, if not properly dealt with, Z10.1 would target all ships and not just those which need intervention; the view was expressed that guidelines would probably solve the matter;
  - b) definition: indicating that the current definitions of GOOD, FAIR and POOR is not clear enough and that the matter would be even worst with GOOD and NON GOOD; again it was indicated that guidelines could solve the matter;
  - c) expertise: expressing doubts on IACS' surveyors expertise and ability to judge coating conditions; in this respect they (hiddenly) suggest that IACS position is unclear when we say that we are not competent to judge the coating during construction but then we are competent to judge coating during operational life. Even if not explicitly stated, the impression is that also in this case guidelines would help.

Additionally, INTERTANKO suggested a (quite detailed) set of assessment criteria.

The matter was then finally addressed at the TRIPARTITE Meeting (held in Soul on 29/30 September 2003). There Industry agreed that the way forward was the (joint) development of IACS guidelines (see minutes attached to message 3100\_RIe dated 11 October 2003, an extract of which is reproduced below).

\_\_\_\_\_ Extract from the TRIPARTITE minutes \_\_\_\_\_

Industry is concerned by the definition of GOOD/NOT GOOD in relation to coating repairs and acceptance criteria. Industry agreed that new guideline on this, which IACS is already producing, was the way forward.

\_\_\_\_\_ End of the extract from the minutes \_\_\_\_\_

### **3. Further developments**

- a) from the above, it was concluded that, provided the guidelines are sound, Industry would accept the concept of Z10.1 (draft) Rev. 12, therefore an IACS team and a JWG were established in order to progress the matter of the guidelines (among other related matters).
- b) the team of IACS experts on coating developed draft guidelines and provided recommendations to GPG on the way forward (attached to message 3095bNVc dated 20 November 2003).
- c) the guidelines were discussed within the JWG with Industry (see draft minutes circulated within GPG with messages 3095cIGd and 3095cIGe both dated 13 March 2004)
- d) further suggestions and comments (as requested at the meeting) were provided by Industry (not circulated to GPG)
- e) Bulk Carrier Industry is recommending that similar guidelines are developed in due time also for bulk carriers
- f) at DE47 and MSC78, IMO is asking Industry and IACS to develop (compulsory) performance standards for coating of newbuilding (double hull spaces of DSS Bulk Carriers), a matter which is, indirectly related to the above one.

1 June 2004

M. Dogliani

IACS GPG Chairman

IACS JWG/COR Chairman

Appendix 2 to Annex 1: [DNV proposal to Z10.1, Z10.3 and z10.4](#) ▶

Sent Monday, July 4, 2005 4:45 pm

To [Gil-Yong <gilyonghan@iacs.org.uk>](mailto:Gil-Yong <gilyonghan@iacs.org.uk>)

Cc

Bcc

Subject Fw: 1060gNVs; WP/SRC - Task 102 - Harmonization of UR Z 7 and Z 7.1

Attachments [Doc1.doc](#)

25K

----- Original Message -----

From: "Debbie Fihosy" <[debbiefihosy@iacs.org.uk](mailto:debbiefihosy@iacs.org.uk)>

To: "CCS" <[iacs@ccs.org.cn](mailto:iacs@ccs.org.cn)>

Cc: "IACS Permanent Secretariat" <[permsec@iacs.org.uk](mailto:permsec@iacs.org.uk)>

Sent: Friday, June 03, 2005 2:52 PM

Subject: FW: 1060gNVs; WP/SRC - Task 102 - Harmonization of UR Z 7 and Z 7.1

Forwarding as requested

-----Original Message-----

From: Arve.Myklebust@dnv.com [[Arve.Myklebust@dnv.com](mailto:Arve.Myklebust@dnv.com)]

Sent: 25 May 2005 15:49

To: [AIACS@eagle.org](mailto:AIACS@eagle.org); [iacs@bureauveritas.com](mailto:iacs@bureauveritas.com); [iacs@ccs.org.cn](mailto:iacs@ccs.org.cn);

[johnderose@iacs.org.uk](mailto:johnderose@iacs.org.uk); [iacs@dnv.com](mailto:iacs@dnv.com); [iacs@gl-group.com](mailto:iacs@gl-group.com);

[gilyonghan@iacs.org.uk](mailto:gilyonghan@iacs.org.uk); [helenbutcher@iacs.org.uk](mailto:helenbutcher@iacs.org.uk); [efs@iacs.org.uk](mailto:efs@iacs.org.uk);

[krsiacs@krs.co.kr](mailto:krsiacs@krs.co.kr); [richardleslie@iacs.org.uk](mailto:richardleslie@iacs.org.uk); [external-rep@lr.org](mailto:external-rep@lr.org);

[clnkiacs@classnk.or.jp](mailto:clnkiacs@classnk.or.jp); [terryperkins@iacs.org.uk](mailto:terryperkins@iacs.org.uk); [iacs@rina.org](mailto:iacs@rina.org);

[iacs@rs-head.spb.ru](mailto:iacs@rs-head.spb.ru); [colinwright@iacs.org.uk](mailto:colinwright@iacs.org.uk)

Subject: FW: 1060gNVs; WP/SRC - Task 102 - Harmonization of UR Z 7 and Z 7.1

25 May 2005

To: Mr. B. Anne, Chairman of IACS Council,

cc: Council Members, IACS Perm. Sec.

Ref.: My mail NVr dated 20 May 2005

DNV have further studied the amendments to UR Z10.1, Z10.3, and Z10.4, and as a result are presenting the following as a compromise solution:

General comment:

From the comments by other Members it is obvious that there is reluctance to accept annual surveys of ballast tanks with a common plane boundary to heated cargo tanks in the case where the coating is in good condition. This is particularly unreasonable as at the same time we enhance the Intermediate survey of Tankers between 10 and 15 years to also include examination of all ballast tanks, meaning that all ballast tanks will be close up surveyed with 2-3 years intervals from the ship is 10 years old, with the possibility for the surveyor to require thickness measurements and testing of the tanks to ensure the structural integrity of the tanks if necessary.

It is also proposed for the Intermediate survey between 5 and 10 years, to increase the scope from representative to all ballast tanks, a requirement DNV find to strict, and require that we here keep the original text.

If a ballast tank is found to have coating in GOOD condition at the renewal or intermediate survey, a deterioration of the tank beyond structural reliability is very unlikely even if the tank has a common plane boundary to a heated cargo tank.

DNV finds it particularly unreasonable to have this requirement to apply to double hull tankers for the following reasons:

- these ships have double hull and the risk of pollution is here much reduced,
- the double hull is constructed with small spaces giving improved structural reliability,
- almost all double hull tankers below VLLC have heated cargo tanks, and all ballast tanks have common plane boundaries to these tanks, meaning that this requirement will apply to a major part of the tanker fleet in the future,
- the ballast tanks of double hull tankers are so designed that a general examination of these tanks will be identical to a close up survey,
- survey of ballast tanks of double hull tankers will mean either gas freeing of all cargo tanks or at least dropping the inert gas pressure of all cargo tanks in addition to proper airing of all ballast tanks.

Since the single hull tankers will be faced out in the near future, and for clear political reasons, DNV will as a compromise proposal to keep paragraph 2.2.3.1 and 4.2.2.2 in Z 10.1 as amended by Council (ref. IAo) but amend it to not include 2.2.3.1.e, 4.2.2.2.e and last paragraph of 3.2.5.1 in Z10.3 and Z10.4. In addition we request that the original text of 4.2.2.1 is kept.

If BV, ABS and other Members can accept this DNV is willing to drop our reservation presented at C49.

DNV's proposal will then be as follows:

Z10.1:

2.2.3.1: This paragraph can be accepted as is for the reasons stated above.

3.2.5.1: This paragraph is accepted as amended.

4.2.2.2: This paragraph can be accepted as is for reasons stated above.

For other comments to Z10.1 see NVo and NVp.

Z10.3:

2.2.3.1.e to be deleted.

3.2.5.1 delete last paragraph

4.2.2.1 the original text to be kept. "For tanks used for water ballast ---"

4.2.2.2.e to be deleted

Z10.4

2.2.3.1e to be deleted

3.2.5.1 delete last paragraph

4.2.2.1 the original text to be kept, "For tanks used for water ballast --"

4.2.2.2.e to be deleted.

For details see attached document where the text for the requirements in Z10.3 and Z10.4 that DNV will accept is stated.

Best Regards

Arve Myklebust  
on behalf of  
Terje Staalstrom  
DNV IACS Council Member  
<<Doc1.doc>>

\*\*\*\*\*

Neither the confidentiality nor the integrity of this message can be vouched

Annex 2 to TB (Harmonization Z10s)

**WP/SRC Task 114 “Clarify the procedure of verification and signature of the thickness measurement report”**

Item No.	Item	ABS	BV <sup>1)</sup>	CCS	CRS	DNV	GL	IRS	KR	LR	NK	RINA	RS
<b>1</b>	<b>Verification onboard</b>												
1.1	Minimum extent of measuring points for direct verification by attending surveyor specified	No	No	No	No	No	No	No	Yes	No	No	Yes	No
1.2	Preliminary TM record to be signed upon completion of the measurements onboard	Yes	Yes <sup>7)</sup>	Yes	No (copy taken)	No <sup>3)</sup>	No <sup>6)</sup>	Yes	Yes	Yes	Yes	No <sup>8)</sup>	No
<b>2</b>	<b>Final TM report</b>												
2.1	Signature of all pages in TM record required	No	No	No	Yes	No	Yes	Yes	No	No	No <sup>5)</sup>	Yes	Yes
2.2	Signature of ‘cover’ (‘general particulars’) page only	Yes	Yes	Yes	No	Yes	No	No	No <sup>4)</sup>	Yes	Yes	Yes	No
2.3	Measuring points verified by attending surveyor required identified in TM record and signature of the corresponding pages required	No	No	Yes Without signature	Yes	No	No	No	Yes	No	No	No	No

2004-04-20

<sup>1)</sup> Instructions not clear regarding signature of the thickness measurement record

<sup>2)</sup> Signature on front and last page, stamp on all other pages, or signature on each page (IACS TM forms)

<sup>3)</sup> Upon completion of measurements onboard a draft report in electronic format (DNV TM template, including operator’s notes as relevant) to be given to attending surveyor

<sup>4)</sup> Signature of cover page, pages of meeting record and pages of attended measuring points

<sup>5)</sup> Each page to be signed in case of ‘loose-leaf’ type record

<sup>6)</sup> Preliminary TM record has to be passed to the Surveyor, signed by the Operator

<sup>7)</sup> The only measures which the Surveyors can certify exact are those for which that they have seen the results on the screen of the apparatus. That means in fact few points in comparison with the numbers of recorded measures.

<sup>8)</sup> The Surveyor reviews the TM record for completeness and assessment of TM readings, but no signature required.

UR Z7s and Z10s (Corrosion Prevention System)

1. Objective:

To clarify whether the survey of anodes is a class matter, and if so, whether acceptance criteria for anode should be developed.

2. Method: GPG by correspondence (5037\_)

3. Discussion

3.1 BV initiated GPG discussion as follows:

Paris La Défense, 8 Mars 05

1 - We have noticed that, in the draft UR Z's ( 7.1, 10.1 to 10.5) issued further to the WP/SRC Task 102, the original sentence ".....the examination may be limited to a verification that the hard protective coating remains efficient....." has been replaced by ....that the corrosion prevention system remains efficient....". in a number of paragraphs (such as , for instance, Z 7.1, 4.2.3.1 a) ; Z 10.2 4.2.3.3 ; ), in line with IMO Res.A744(18).

2 - However, a corrosion prevention system is defined, in the same UR Z's and in IMO Res.A744(18) , as being either a full hard protective coating or a full hard protective coating supplemented by anodes.

3 - The above would mean that the survey of the anodes is a classification matter.

4 - However, whereas coating conditions are defined as good or fair or poor, there are no criteria in the IACS URs and IMO Res. A744(18) for the anodes condition.

5 - Assessing the anodes condition to confirm that they "remain efficient" looks to BV to be a quite difficult task for the ships in service Surveyor.

6 - Member's view and interpretations on the following would consequently be appreciated:

- do Members consider that the above requirements in IACS URs imply that survey of anodes is part of the classification ?
- do Members consider that the above requirements in IMO Res. A 744 (18) imply that survey of anodes is mandatory?
- if yes, what is the acceptance criteria to conclude that the anodes" remain efficient" ?

3.2 The majority of GPG Members replied that they did not include requirements for anodes in their class rules.

LR / ABS / DNV / KR / NK / RINA / RS were of the view that the condition of any anodes fitted should be recorded for information purposes as the survey of anodes is neither a classification matter nor a mandatory requirement in IMO A.744(18) and has no impact on future surveys (5037\_LRa). [Note; LR further clarified that "Whilst I agree that the performance of anodes is not normally a class matter LR does require that as part of Special Survey on oil tankers : "The attachment to the structure and condition of anodes in tanks are to be examined ." Therefore we cannot say that 'the survey of anodes is not a classification matter'. 5037\_LRb]

However, GL said that “for GL, anodes are a matter of class and as such are subject to plan approval as well as surveys. In case of missing or worn-out anodes we issue a condition of class”(5037\_GLa&b).

CCS advised that its rules have a general requirement relating to anode survey, which is only conducted, through sampling, during construction, docking survey or where there is a definite requirement for the survey of ballast tanks.

NK proposed that the following footnote be added to Z7s and Z10s:  
“The survey of anodes is not a classification matter.” No majority support was achieved.

#### **4. Conclusion**

RINA suggested to simply amend the definition of "Corrosion Prevention System" in paragraph 1.2.9 of UR Z7 (and, of course, the paragraphs in all the other UR Zs containing the definition of "Corrosion Prevention System") in order to eliminate any reference to anodes. This proposal would leave room for Societies willing to include additional class requirements for anodes to do so in their Rules.

GPG agreed.

### **RINA proposed amendments to paragraph 1.2.9 of UR Z7 and corresponding paragraphs in all other UR Zs (5037\_RIb, 6 April 2005)**

#### 1.2.9 Corrosion Prevention System

A corrosion prevention system is normally considered ~~either: a full hard protective coating, or~~  
~~1 a full hard protective coating, or~~  
~~2 a full hard protective coating supplemented by anodes.~~

Hard protective coating is usually to be epoxy coating or equivalent. Other coating systems may be considered acceptable as alternatives provided that they are applied and maintained in compliance with the manufacturer's specifications.

Where soft coatings have been applied, safe access is to be provided for the surveyor to verify the effectiveness of the coating and to carry out an assessment of the conditions of internal structures which may include spot removal of the coating. When safe access cannot be provided, the soft coating is to be removed.

[Annex: Council Chair's conclusive message.](#)

6 May 2005  
Permsec

## **Annex. (5037\_ICb, 15 May 2005)**

To : All IACS Council Members  
c.c : Mr. R. Leslie, IACS Permanent Secretariat

Ref. Mr G-Y. Han's message IAa dated 6 May 05  
Message ICa dated 6 May 05  
Admiral R.E. Kramek's message ABb dated 13 May 05

Paris La Défense, 15 May 05

- 1 - All Members have agreed with the texts attached to Mr Han's message.
- 2 - Further to ABS comments the reference to anodes is to be deleted in Annex I and in tables IX (IV) and IX(II).
- 3 - further to ABS questions regarding what IACS plan to do regarding IMO and A.744(18) further to IACS deletion of reference to anodes from the UR Z7's and UR Z10's it is to be noted that:

The Item 1.2.9 in UR Z10.1 and relative items in these URs states  
*1.2.9 10 Corrosion Prevention System: A corrosion prevention system is normally considered either:*

- .1 a full hard protective coating, or*
- .2 a full hard protective coating supplemented by anodes.*

*Hard Pprotective Ccoating is to usually to be epoxy coating or equivalent. Other coating systems may be considered acceptable as alternatives provided that they are applied and maintained in compliance with the manufacturer's specification.*

*Where Soft Coatings have been applied, safe access is to be provided for the surveyor to verify the effectiveness of the coating and to carry out an assessment of the conditions of internal structures which may include spot removal of the coating. When safe access cannot be provided, the soft coating is to be removed.*

- therefore the anodes are not considered as the main means of protection against the corrosion It is only a supplement;
- there is no provision in UR Z7's and Z10's to evaluate the level efficiency of the anodes;
- there is no specific requirements in case of lack of efficiency of the anodes.

The experience has shown that ballast tanks only protected by anodes are subject to corrosion when the anodes are becoming less efficient.

The anodes are active only when immersed by sea water. Therefore the upper part of the ballast tanks are not protected when the ballast is full of water and the ballast is not protected when it is empty..

The ships operators are reluctant to replace the anodes especially in upper part which request fitting of scaffolding fo welding the anode supports to the structure.

[The above arguments justify the reasons why IACS consider that the anodes are not class item.](#)

[4 - These arguments can be used by IACS Members](#) attending the WG bulk carriers at MSC 80 to try to obtain deletion of the reference to anodes in A. 744(18).

Best regards,

Bernard Anne  
IACS Council Chairman.



**Survey Panel Task 22 – Amend applicable URZ7s and Z10s to align Close-Up Survey and Thickness measurements to be carried out at the same time and location allowing for a more structured control of the thickness measurement process.**

**Technical Background**

**Z7(Rev.12)**

**Z7.1(Rev.3)**

**Z10.1(Rev.13, para.1.4 & 7.1.3)**

**Z10.2(Rev.18, para. 1.4 & 7.1.3)**

**Z10.3(Rev.8, para. 1.4 & 7.1.3)**

**Z10.4(Rev.3, para. 1.4 & 7.1.3)**

**Z10.5(Rev.2, para. 1.4 & 7.1.3)**

**1. Objective**

To amend the applicable URZ7s and Z10s to align Close-Up Survey and Thickness measurements to be carried out at the same time and location allowing for a more structured control of the thickness measurement process.

**2. Background**

IACS QC findings, through audits of numerous Societies, which indicated concerns over Surveyor attendance and control of thickness measurement processes.

**3. Methodology of Work**

Survey Panel members through correspondence.

**4. Discussion**

To align Close-up survey requirements and thickness measurements in the applicable URZ7s and URZ10s, in accordance with PR19, all Panel members agreed through correspondence and a final vote at the fall Survey Panel meeting, that URZ7, Z7.1, Z10.1, Z10.2, Z10.3, Z10.4 and Z10.5 should include in the applicable sections of the noted URs as proposed by the Survey Panel the wording “ In any kind of survey, i.e. special, intermediate, annual, or other surveys having the scope of the foregoing ones, thickness measurements of structures in areas where close-up surveys are required, shall be carried out simultaneously with close-ups surveys.”

**5. Implementation**

The Survey Panel is of the view that the Members need 12 months from the adoption date to implement these amendments into their class rules. Assuming that GPG and Council approve to the amendments, the Survey Panel would propose January 2007 as an implementation date.

## TECHNICAL BACKGROUND

### UR Z7.1 (REV. 4) AND UR Z7 (REV.13)

*SURVEY PANEL TASK 39 – Amend URZ7.1 to align with the requirements of URZ10.2 and URZ10.5 in accordance with SOLAS reg. II-I/23-3 and II-I/25 regarding Water level detectors on single hold cargo ships other than bulk carriers, and to propose to IMO that these requirements be included in relevant sections of IMO resolution A.948(23).*

#### 1. Objective

To amend UR Z7.1 Section 2.6 and 3.3 to include survey requirements related to SOLAS reg. II-I/23-3 and II-I/25 and to propose to IMO that these requirements be included in relevant sections of IMO resolution A.948(23).

#### 2. Background

GPG member from LR requested that URZ7.1 should be amended to meet SOLAS regulations II-I/23-3(entry into force :1 January 2007) and II-I/25 (entry into force: 1 January 2009)

#### 3. Methodology of Work

Survey Panel

#### 4. Discussion

Survey Panel members at the spring 2006 meeting discussed how to address these changes in a similar manner as were carried out in Survey Panel Task 11 for URZ10.2 and Z10.5, for URZ7.1. During the discussion, the member from RINA proposed that URZ7 also be amended to refer to the applicable changes in URZ7.1.

All members agreed and made necessary amendments to URZ7 section 1.1.5 and added note 5 as far as the implementation date.

For URZ7.1 it was agreed that sections 2.6 and 3.3 be added to add these additional requirements.

#### 5. Implementation

The Survey Panel is of the view that the Members need 12 months from the adoption date to implement these amendments into their class rules. Assuming that GPG and Council

approve to the amendments, the Survey Panel would propose July 2007 as an implementation date.

**Submitted by Survey Panel Chair,  
13 July 2006**

**Permanent Secretariat note:**

- Council approved URZ7.1 Rev.4 and URZ7 Rev.13 on 17 August 2006 (5031fICb).
- In addition to the proposed changes a typographical error was corrected in Table 4 of UR Z7.

## TECHNICAL BACKGROUND

### UR Z3 (Rev. 4), Z 7 (Rev. 14), Z18 (Rev. 2) and Z21 (Rev. 2)

#### Survey Panel Meeting March 2006 New Business Item – Applying UR Z3, Z7, Z18 and Z21 for Military Vessels.

#### 1. Objective

To add the following new paragraph to UR Z3, Z7, Z18 and Z21 to reflect that special consideration may be used for military vessels:

**“Special consideration may be given in application of relevant sections of this Unified Requirement to military vessels or commercial vessels owned or chartered by Governments, which are utilized in support of military operations or service”.**

#### 2. Background

This task was originally discussed during the Survey Panel meeting, which took place at ABS Houston on the 1<sup>st</sup> to 3<sup>rd</sup> March 2006; it was subsequently recorded under paragraph 3 “new business” of the minutes of this meeting.

This initial started as a proposal for ABS to remove their reservation (see below) for military vessels against UR Z3 and Z7s. However all of the members agreed to the proposal.

Current ABS Reservation: “ABS allows variations in survey interval in agreement with US Government for military vessels or commercial vessels owned or chartered by the Government which are utilized in support of military operations or service.”

#### 3. Methodology of Work

Survey Panel members through correspondence.

#### 4. Discussion

Survey Panel member from ABS raised this issue at the March 2006 Survey Panel meeting and volunteered to propose amendments to the applicable URs for Panel members to review and comment on through correspondence. At the Fall meeting of the Survey Panel, it was agreed upon by all Panel members that the proposed amendments for UR Z3, Z7, Z18 and Z21, which were proposed by ABS, were acceptable.

#### 5. Implementation

The Survey Panel is of the view that the Members need 12 months from the adoption date to implement these amendments into their class rules. Assuming that GPG and Council approve to the amendments, the Survey Panel would propose January 2008 as an

implementation date. However due to other on going revisions to UR Z21 this UR will be held abeyance until the other revisions are completed.

**6. Discussion at GPG:** GPG amended the proposal by deleting the phrase “military vessels or” on the basis that military vessels and other government ships operated for non-commercial purposes are out of the scope of IACS URs. The adopted amendment therefore reads:

**“Special consideration may be given in application of relevant sections of this Unified Requirement to commercial vessels owned or chartered by Governments, which are utilized in support of military operations or service”.**

Submitted by Survey Panel Chair, October 2006  
Updated by GPG to reflect their discussion

## **Technical Background**

**URs Z7(Rev.15), Z7.1(Rev.5), Z7.2(Rev.1), Z10.1(Rev.15),  
Z10.2(Rev.26), Z10.3(Rev. 9), Z10.4(Rev.6), Z10.5(Rev.8) – November  
2007**

### ***Survey Panel Task 1 – Annual Review of Implementation of IACS Resolutions***

#### **1. Objective**

To review IACS Resolutions annually and discuss or propose amendments as deemed necessary.

#### **2. Background**

This proposed amendment to all URZ7s and URZ 10s was raised by the Panel member from DNV due to Owners crediting tanks concurrently under intermediate and special survey.

#### **3. Methodology of Work**

Survey Panel members through correspondence.

#### **4. Discussion**

The Panel member from DNV raised the issue of Owners having the ability of crediting spaces and thickness measurements only once in a 54 month interval, due to the availability of concurrent crediting of spaces and thickness measurements due to the flexible time window that is currently allowed between the intermediate survey and the special survey.

After a presentation and discussion lead by the DNV Panel member, all Survey Panel members agreed to the argument given by DNV, and further agreed to make the necessary changes in all URZ7s and URZ10s where Owners are not allowed to concurrently credit surveys and thickness measurements of spaces.

#### **5. Implementation**

The Survey Panel is of the view that the Members need 12 months from the adoption date to implement these amendments into their class rules. Assuming that GPG approve to the amendments, the Survey Panel would propose January 2009 as an implementation date.

Submitted by Survey Panel Chairman  
22 October 2007

**Permanent Secretariat note (December 2007):**

During GPG discussion DNV proposed that *“since this matter will be discussed between Owner and Class mainly in connection with the forthcoming Special Survey, DNV would prefer to locate this text, not only as part of Intermediate Survey, but also as a new text for the Special Survey.”* This was supported by BV, ABS, RINA and KR.

The revised documents were approved, with DNV’s proposal and an implementation date of 1 January 2009, on 15 November 2007 (ref. 7690\_IGb).

## Technical Background

### URs Z7(Rev.16), Z7.1(Rev.6), Z7.2(Rev.2), Z10.1(Rev.16), Z10.2(Rev.27), Z10.3(Rev.11), Z10.4(Rev.7) and Z10.5(Rev.9) - March 2009

#### Survey Panel Task 62:

- A) *Harmonization of UR Z10.1, Z10.2, Z10.4 and Z10.5 with UR Z10.3 with respect to items 5.5.4.4 and 5.6.2.*
- B) *Harmonization of UR Z7, Z7.1, Z10.1, Z10.2, Z10.3, Z10.4 and Z10.5 with UR Z7.2 with respect to the definition of the corrosion prevention system and with respect to the footnote 1 related to semi-hard coatings.*
- C) *Harmonization of the definition of Ballast Tank in UR Z7(Rev.14)*

#### 1. Objective

- A) Amend the texts of items 5.5.4.4 and 5.6.2 in Unified Requirements Z10.1, Z10.2, Z10.4 and Z10.5 in order to align them with those in UR Z10.3, in which they were changed while performing Task 55, whereas in the other UR Z10s they were kept unchanged on the grounds that this change was out of the scope of Task 55.
- B) Amend the definition of “Corrosion Prevention System” and include a Footnote 1 related to semi-hard coatings in Unified Requirements Z7, Z7.1, Z10.1, Z10.2, Z10.3, Z10.4 and Z10.5 in order to align them with those adopted in UR Z7.2, when this new UR was issued.
- C) Amend UR Z7 (Rev. 14) in all items where the term “Ballast Tank” is used in order to get them harmonized with the definition itself.

#### 2. Background

The task, as regards item A), was triggered by a Member Society, while performing Task 55, on the grounds that this part was out of the scope of the task and then should have been dealt with in a separate task.

The task, as regards item B), was triggered as a consequence of the “New Business action item 2” of the Minutes of the September 2008 Survey Panel meeting, for sake of harmonization of the various URZs.

The task, as regards item C), was triggered as a consequence of the “Task 54-Examination of Double Bottom Ballast Tanks at annual surveys” of the Minutes of March 2008 Survey Panel meeting, for sake of harmonization of the definition of Ballast Tank in UR Z7(Rev.14).

#### 3. Discussion

The task was carried out by correspondence. All the amended texts for the affected URs were prepared by the Survey Panel Member who had chaired the PT on Task 55, in accordance with the Form A approved by GPG. In addition to the objectives outlined in the Form A, an amendment was added to item 1.3.1 of UR Z10.2 and UR Z10.5 in which the reference 3.2.3.6 in the last item of the list was replaced by 3.2.3.10 as can be correctly verified in the text.

The amended URs were circulated to all Survey Panel Members for review, comments and agreement. The texts of the URs were unanimously agreed by all Members.



#### **4. Implementation**

The Survey Panel is of the view that the Member Societies need at least 12 months from the adoption date to implement these amendments into their class rules/procedures. Therefore, in the first version of all amended URs the following implementation sentence should be proposed:

*Changes introduced in Rev .xx are to be uniformly applied by Member Societies and Associates for surveys commenced on or after [not less than 12 months after the adoption by GPG/Council].*

Since it is common practice and convenience to have implementation dates either on 1<sup>st</sup> January or on 1<sup>st</sup> July of the year, the Survey Panel proposes the 1<sup>st</sup> July 2010 as implementation date, if GPG/Council approve the URs not later than 30 June 2009.

**Submitted by Survey Panel Chairman  
28 February 2009**

#### **Permanent Secretariat notes (April 2009):**

1. The amended URs were approved by GPG on 18 March 2009 (ref. 7718bIGd).
2. During the typesetting process it was noted that para 5.1.5 of UR 7.2 was inconsistent with the amended URs and so following consultation with the Survey Panel this was also amended at this time.
3. Regarding the implementation date, GPG agreed to use 1<sup>st</sup> July 2010 provided that it was consistently used for the amended URs.

## **Technical Background for UR Z7 Rev.17 (May 2010)\***

### **1. Scope and objectives**

Amend UR Z7 to include requirements for partial removal of casings, ceilings or linings, and loose insulation.

### **2. Engineering background for technical basis and rationale**

To improve requirements in UR Z7 for access to structure for survey.

### **3. Source/derivation of the proposed IACS Resolution**

- C59 Follow - up Action Item 29 – AVC Chairman’s report
- UR Z7

### **4. Summary of Changes intended for the revised Resolution:**

To allow partial removal of casings, ceilings or linings, and loose insulation, where fitted, to the satisfaction of the attending Surveyor upon findings (such as indents, scratches, etc.) detected during surveys of shell plating from the outside.

### **5. Points of discussions or possible discussions**

N/A

### **6. Attachments if any**

None

---

\* Survey Panel Task 68 - *To make amendments to UR Z7 to allow only partial removal of casings, ceilings or linings, and loose insulation, where fitted, to the satisfaction of the attending Surveyor, for examination of plating and framing and to allow for TMs'*

## **Technical Background for UR Z7 Rev.18, Jan 2011**

### **1. Scope and objectives**

Starting from the example of supply vessels, to align UR Z7, Z7.1, Z1 and IMO Res. A997(25) as amended consistently.

### **2. Engineering background for technical basis and rationale**

Supply vessels may carry different types of cargo which do not fall into category of dry cargo, such as brine, mud etc. and therefore this type of ship is subject to the intermediate survey requirements of item (CIn) 2.3.2.3 of IMO Res.A.997(25) as amended, through UR Z1. This requirement is to be added to UR Z7 as well.

### **3. Source/derivation of the proposed IACS Resolution**

UR Z1 and IMO Res.A.997(25) as amended.

### **4. Summary of Changes intended for the revised Resolution:**

The following requirement is included in UR Z7, for intermediate surveys:

"4.2.6 In the case of ships over 10 years of age, other than ships engaged in the carriage of dry cargoes only or ships subject to Z10.1, Z10.3, Z10.4 or Z7.2, an internal examination of selected cargo spaces is to be carried out."

### **5. Points of discussions or possible discussions**

The Panel agreed that the above requirement was intended to cover the internal examination of selected cargo spaces intended for carriage of liquid cargo.

### **6. Attachments if any**

None

## **Technical Background for UR Z7 Rev.19, July 2011**

### **1. Scope and objectives**

Review the requirement for repairs within IACS UR 7 and UR 10 series, in particular the requirement for Prompt and Thorough Repair, with a view to developing wording that would permit a temporary repair and the imposition of a Recommendation/ Condition of Class under specific and controlled circumstances, and in accordance with PR35.

### **2. Engineering background for technical basis and rationale**

There are instances, for example a localised, isolated and very minor hole in a cross-deck strip, at which a suitable temporary repair, for example by welding or doubling, and the imposition of a suitable short term Recommendation/ Condition of Class for permanent repair at a later date, are considered very adequate methodology for dealing with the defect.

Current IACS Requirements in the UR Z7 and Z10 series, for Prompt and Thorough repair, would not permit this to be an option, the defect would have to be permanently Promptly and Thoroughly repaired, which might require removing cargo, moving to a repair berth and staging inner spaces.

Under the Requirements of IACS Procedural Requirement PR 35 the methodology of Temporary Repair and imposition of a suitable short term Recommendation/ Condition of Class for permanent repair at a later date is fully permissible.

### **3. Source/derivation of the proposed IACS Resolution**

Based upon discussion within the IACS Survey Panel.

### **4. Summary of Changes intended for the revised Resolution:**

Following the definition of Prompt and Thorough Repair in the Unified Requirement, a new paragraph is proposed to be added:-

"1.3.3 Where the damage found on structure mentioned in Para. 1.3.1 is isolated and of a localised nature which does not affect the ship's structural integrity, consideration may be given by the surveyor to allow an appropriate temporary repair to restore watertight or weather tight integrity and impose a Recommendation/Condition of Class in accordance with IACS PR 35, with a specific time limit."

### **5. Points of discussions or possible discussions**

a) The points of discussion are as indicated in Sections 2 and 4 above.

b) Discussion took place on whether to prepare this amendment as a Unified Interpretation of IMO Resolution A.744(18)/UR Z7 and Z10 series, finally it was agreed to make direct amendment to the relevant URs.

c) It is proposed that this amendment be submitted directly to the IMO DE/MSC Committees for consideration of amending directly IMO Res. A744(18)

**6. Attachments if any**

None

## **Technical Background for UR Z7 Rev.21, Jan 2014**

### **1. Scope and objectives**

Consider appropriate text in IACS document regarding class period for lengthy conversions.

### **2. Engineering background for technical basis and rationale**

As per the IMO Res. A1053 (27), lengthy conversions (not necessarily of major character) or other major repair work can be assigned for a 5 year period from the date of completion of conversion/repairs/surveys.

### **3. Source/derivation of the proposed IACS Resolution**

None

### **4. Summary of Changes intended for the revised Resolution**

Following additional text was included to section 2.1.3 to clarify the class period for lengthy conversions

“In cases where the vessel has been laid up or has been out of service for a considerable period because of a major repair or modification and the owner elects to only carry out the overdue surveys, the next period of class will start from the expiry date of the special survey. If the owner elects to carry out the next due special survey, the period of class will start from the survey completion date.”

### **5. Points of discussions or possible discussions**

Additional text to Para.2.1.3 was discussed in order to clarify class period.

### **6. Attachments if any**

None

## UR Z7.1 “Hull Surveys for General Dry Cargo Ships”

### Summary

By this corrigendum, Para. 1.6 of this UR and its footnotes were updated due to withdrawal of UR S21A and merger of its contents into UR S21.

### Part A. Revision History

Version no.	Approval date	Implementation date when applicable
Corr.1 (May 2024)	10 May 2024	-
Rev.15 (June 2019)	15 June 2019	1 July 2020
Rev.14 (Jan 2018)	16 January 2018	1 January 2019
Rev.13 (Aug 2017)	23 August 2017	1 January 2019
Rev.12 (June 2016)	06 June 2016	1 July 2017
Rev.11 (Feb 2015)	05 February 2015	1 July 2016
Rev.10 (Jan 2014)	14 January 2014	1 January 2015
Rev.9 (May 2013)	22 May 2013	1 July 2014
Rev.8 (Oct 2011)	19 October 2011	1 January 2013
Rev.7 (July 2011)	27 July 2011	1 July 2012
Rev.6 (Mar 2009)	18 March 2009	1 July 2010
Rev.5 (Nov 2007)	15 November 2007	1 January 2009
Rev.4 (Aug 2006)	17 August 2006	1 July 2007
Rev.3 (Jan 2006)	04 January 2006	1 January 2007
Rev.2 (June 2005)	27 June 2005	1 July 2006
Rev.1 (June 2003)	18 June 2003	-
New (June 2002)	No record	-

#### • Corr.1 (May 2024)

##### 1 Origin of Change:

- Suggestion by IACS member

##### 2 Main Reason for Change:

UR S21A was withdrawn, and its content was merged into UR S21 (with the implementation date of 1 July 2024). Accordingly, there was a need to update Para. 1.6 of UR Z7.1 and its footnotes.

##### 3 Surveyability review of UR and Auditability review of PR

Survey Panel checked the correctness of this corrigendum.

##### 4 List of non-IACS Member classification societies contributing or participating in IACS Working Group:

None

## **5 History of Decisions Made:**

During the 39<sup>th</sup> Survey Panel meeting, the suggested correction of this UR in the form of corrigendum was unanimously agreed.

No TB is expected for the present revision.

## **6 Other Resolutions Changes:**

None

## **7 Any hinderance to MASS, including any other new technologies:**

None

## **8 Dates:**

Original Proposal	:	22 January 2024	(Ref. PSU24006_ISUa)
Panel Approval	:	7 March 2024	(Ref: 39 <sup>th</sup> Survey Panel meeting)
GPG Approval	:	10 May 2024	(Ref: 24057_IGb)

## **• Rev. 15 (June 2019)**

### **1 Origin of Change:**

- Suggestion by an IACS member

### **2 Main Reason for Change:**

2.1 This revision is to address the policy decision made by GPG using the common terminology 'Condition of Class'(CoC) instead of the terms 'Recommendation/Condition of Class' based on the outcome of III 5. (PSU19010)

2.2 Additionally, further revision was agreed to enable special consideration of classification societies in the assessment of cargo hold designs containing only short single side skin area in forward/aft cargo hold. (PSU18040)

2.3 Additionally, further revision was agreed to use the harmonized terms of ballast tanks for their survey requirements. (PSU18070)

2.4 Furthermore, in view of that in accordance with Res. MSC.194(80) the SOLAS regulation II-1/23-3 in the annex 1 was completely replaced by regulation II-1/25 in the annex 2 since 1 January 2009, regarding the additional requirements for single hold cargo ships, the references to SOLAS II-1/23-3 in this UR was agreed to be removed from Paragraphs 2.6 and 3.3.

### **3 List of non-IACS Member classification societies contributing through the TC Forum and/or participating in IACS Working Group:**

None



## **4 History of Decisions Made:**

### **4.1 Harmonization of the terms "Recommendation" and "Condition of Class" (PSU19010)**

During the 29th panel meeting, the panel discussed about the comments of members, and concurred with the view to retain the present definitions of CoC in the IACS resolutions with the wording 'Recommendation' to be removed. The panel also agreed to use the term 'Statutory Condition' for the 'recommendation' of the statutory certificates in IACS resolutions and RECs, and when discussing the proposal of a member to consider the harmonization of the terms of 'recommendation' and 'condition of class' in RO Code, the panel unanimously agreed to take no action on the IMO instruments, leaving the relevant actions to be decided by the relevant IMO bodies when IACS feeds back to IMO the IACS action on the harmonization of the two terms.

Panel members concurred with the view that it is not necessary to develop a new procedure requirement, and agreed to set the implementation date of these IACS resolutions (other than RECs) as 1st July 2020.

Before the implementation date of 1st July 2020 for using the common terminology 'Condition of Class' only, 'Recommendations' and 'Condition of Class' are to be read as being different terms used by Societies for the same thing, i.e. requirements to the effect that specific measures, repairs, surveys etc. are to be carried out within a specific time limit in order to retain Classification.

### **4.2 Additional revision to Paragraph 1.1.1 (PSU18040)**

Survey Panel members concurred with the view that the application of UR Z7.1 was inappropriate and did not improve level of safety for general dry cargo ships that were of double side-skin construction, but with single skin in way of several frame spaces e.g. in way of a cargo hold entrance or at the forward end of the forward cargo hold in way of forebody hull form.

The panel agreed to modify paragraph 1.1.1 of UR Z7.1 with a belonging note being additionally developed, which enabled the classification society an assessment of respective cargo hold designs with special consideration.

### **4.3 Additional revision to use the harmonized terms of ballast tanks for their survey requirements (PSU18070)**

Upon the discussions within Survey Panel under task No. PSU18070, the following changes were decided to be made to UR Z7, Z7.1 and Z7.2:

- 1) To use "ballast tanks" in lieu of "ballast spaces", "water ballast tanks", "tanks used for water ballast" or "spaces used for water ballast"; and
- 2) To use "double bottom ballast tanks" in lieu of "water ballast double bottom tanks".

### **4.4 Additional revision to Paragraphs 2.6 and 3.3 (PSU19028)**

Upon the discussions within Survey Panel under task No. PSU19028, in view of that in accordance with Res. MSC.194(80) the SOLAS regulation II-1/23-3 in the annex 1 was completely replaced by regulation II-1/25 in the annex 2 since 1 January 2009, regarding the additional requirements for single hold cargo ships, the references to SOLAS II-1/23-3 in this UR was agreed to be removed from Paragraphs 2.6 and 3.3.

No TB is expected for the present revision.

## **5 Other Resolutions Changes:**

PSU19010;

The following IACS resolutions and Recommendations (RECs) were agreed to be revised:

- Procedural Requirements: PR1A, PR1B, PR1C, PR1D, PR1 Annex, PR3, PR12, PR20, PR35 and the attachment of PR16;
- Unified Requirements: Z7, Z7.1, Z7.2, Z10.1, Z10.2, Z10.3, Z10.4, Z10.5, Z15 and Z20
- Unified Interpretations: GC13
- Recommendations: Rec.41, Rec.96, Rec.98

PSU18070;

URs Z7 and Z7.2

## **6 Any hinderance to MASS, including any other new technologies:**

None.

## **7 Dates:**

Original Proposal: 14 January 2019 tasked by GPG (17044bIGm) (PSU19010)  
21 July 2018 Made by a Survey Panel Member (PSU18040)  
19 December 2018 Made by: a Survey Panel member (PSU18070)  
14 May 2019 Made by: a Survey Panel member (PSU19028)

Panel Approval: 22 March 2019 (PSU19010)  
8 April 2019 (PSU18040)  
3 May 2019 (PSU18070)  
31 May 2019 (PSU19028)

GPG Approval: 15 June 2019 (17044bIGy)

### **• Rev.14 (Jan 2018)**

#### **.1 Origin of Change:**

- Suggestion by IACS members

#### **.2 Main Reasons for Change:**

To address the FUA 11 of C73, raised by the Council of the IACS in respect to the future work directions on the implications of new technology on survey regime. A revision of UR Z7.1 is in order to consider the new technologies on Remote Inspections (RIT).

**.3 List of non-IACS Member Classification Societies contributing through the TC Forum and/or participating in IACS Working Group:**

None

**.4 History of Decisions Made:**

Members discussed under Panel task PSU 16056 the issue allocated by GPG on 21th October 2016. The subject deals with the review of the UR and Recommendation under Panel responsibility in order to determine whether a revision could need in order to consider the new technologies on Remote Inspections (RIT). The Panel Members concurred to discuss the possible revision of the UR Z7.1 in order to address the issue.

Panel agreed the revised paragraph 1.4, 1.5 and 5.2.3. In addition, a new paragraph 1.2.15 with definition of RIT was agreed and inserted in the present revision of UR Z7.1.

No TB is expected for the present revision.

**.5 Other Resolutions Changes**

UR Z7, UR Z7.2, UR Z10.3

**.6 Dates:**

Original Proposal: 21 October 2016 assigned by GPG

Panel Approval: 08 December 2017 by Survey Panel (Ref: PSU16056)

GPG Approval: 16 January 2018 (Ref: 16151\_IGp)

**• Rev.13 (Aug 2017)**

**.1 Origin of Change:**

- Suggestion by an IACS member

**.2 Main Reasons for Change:**

2.1 To introduce the criteria for the steel renewal which belongs under the unified requirements of series S and are related to the net scantling approach, discussed under the task No. PSU16044;

2.2 To clarify the applicability of hybrid cargo hold arrangements by adding paragraph 1.1.2, discussed under the task No. PSU17005.

**.3 List of non-IACS Member classification societies contributing through the TC Forum and/or participating in IACS Working Group:**

None

#### **.4 History of Decisions Made:**

4.1 Criteria for the steel renewal which belongs under the unified requirements of series S and are related to the net scantling approach

4.1.1 A member noted that some Unified Requirements of series S (Strength of Ships), such as UR S18, contain criteria addressing the steel renewal for dedicated structures such as transverse bulkheads, cargo hatch coamings and plating. These criteria (based on the net scantling approach) are applicable also to units designed with the gross scantling approach because they refer to particular structures for which it is foreseen that the dimensioning (or the design verification) according to the net scantling approach is applicable.

4.1.2 During the 24<sup>th</sup> Survey Panel Meeting the members agreed to review all UR of the S series in order to identify those containing any steel renewal criteria with the scope to review them.

4.1.3 Having found that UR S18 and UR S21a contain steel renewal criteria that need to be taken in to account during the thickness measurements review process, the members agreed that a new paragraph dealing with this issue needed to be added under the general section of the UR Z7.1.

4.1.4 The paragraph 1.5, "Thickness measurements Acceptance Criteria", has been agreed and inserted in the present revision of UR Z7.1.

4.2 Applicability of hybrid cargo hold arrangements

4.2.1 A member noted that the clarification of current UR Z7.1 is not clear for the situation of hybrid cargo hold arrangements and proposed to add new paragraph 1.1.2 into UR Z7.1.

4.2.2 During the 25<sup>th</sup> Survey Panel Meeting, the members reviewed the UR Z7.1 and agreed to add the new paragraph 1.1.2 into UR Z7.1.

No TB is expected for the present revision.

#### **.5 Other Resolutions Changes**

UR Z7, UR Z10.2, UR Z10.5

#### **.6 Dates:**

Original Proposal:	09 September 2016 (24 <sup>th</sup> Survey Panel meeting) Made by a Survey Panel Member
	15 February 2017 Made by a Survey Panel Member.
Panel Approval:	08 February 2017 (Ref: PSU16044)
	22 May 2017 (Ref: PSU17005)
GPG Approval:	23 August 2017 (Ref: 17017_IGb)

#### **• Rev.12 (June 2016)**

## **.1 Origin of Change:**

- Suggestion by an IACS members

## **.2 Main Reasons for Change:**

To consider appropriate text of paragraph 2.4.2 in order to replace the vague wording "dispensed" and provide a definition of the sentence "*hard protective coating where applied remains efficient*".

## **.3 List of non-IACS Member classification societies contributing through the TC Forum and/or participating in IACS Working Group:**

None

## **.4 History of Decisions Made:**

Following an ACB query an IACS member sought the Members opinion to clarify the meaning of the sentence "*The thickness measurements may be dispensed with provided the surveyor is satisfied by the close-up examination, that there is no structural diminution, and the hard protective coating where applied remains efficient*", in particular if the thickness measurements might be totally avoided when the pre-requisites are fulfilled.

Panel Members offered their interpretation to this sentence and the common view of the majority is that the thickness measurements should not be totally avoided since surveyor shall demonstrate: "*that is no structural diminution*". Panel agreed to remove the word "*dispensed*" from the last sentence of paragraph 2.4.2 and insert the new wording "specially considered".

A margin of the discussion Panel examined the pre-requisite relevant to the condition of the coating; in fact the wording "*hard protective coating where applied remains efficient*" does not provide clarity when compared with the definitions under paragraph 1.2.11 of the unified requirement.

The common view of the Members is that the coating condition of the structural area under examination shall be in "GOOD" condition to be considered "efficient", whilst the overall coating condition of the compartment/space under examination might be "FAIR". Panel agreed to add in the text a footnote which explains the meaning of "efficient".

According to a latest proposal made by a Member, the paragraph 2.4.2 has been further modified to clarify better the structures to be subjected to examination. The Panel agreed that for the "water ballast tanks" the wording "*transverse webs of*" has to be added before and for the transverse bulkhead the wording "*and framing*" has to be inserted after "bulkhead plating".

During the 23<sup>rd</sup> Survey Panel meeting, the modifications to paragraph 2.4.2 have been re-examined by the Members. The review has been performed by taking in account the whole history files of the UR Z7.1. Members concurred that the paragraph 2.4.2

(both the original and the revised versions) might be misleading if it is read in association to paragraph 2.4.4.

Therefore Members agreed:

- to include the cargo holds in paragraph 2.4.4 so that the special considerations can be applied also to these compartments.
- the deletion of paragraph 2.4.2 and the consequent renumbering of the subsequent paragraph.

The Panel common view on the "Minimum quantity of thickness measurements to be taken in case special considerations have been applied" has been developed and agreed.

No TB is expected for this revision.

## **.5 Other Resolutions Changes**

None

## **.6 Dates:**

Original Proposal 02 September 2015 made by IACS Member  
Panel Approval: At 20th Survey Panel Meeting (Ref: PSU15045)  
GPG Approval: 06 June 2016 (Ref: 16093\_IGb)

## **• Rev.11 (Feb 2015)**

### **.1 Origin of Change:**

- Suggestion by an IACS members

### **.2 Main Reasons for Change:**

- a) To consider appropriate text in IACS document regarding the applicability of the Thickness Measurements when the Close up survey is performed.
- b) To consider the impracticability of the internal structure close up inspection of cargo hold hatch covers which have no access structurally (from the approved design) and it is possible to survey and gauge plating only..

### **.3 List of non-IACS Member classification societies contributing through the TC Forum and/or participating in IACS Working Group:**

None

### **.4 History of Decisions Made:**

- a) Following an ACB query an IACS member proposed to add suitable text in appropriate IACS documents regarding the application of the Thickness Measurements when the close up surveys are performed as survey requirement due at the Intermediate/ Renewal Class surveys. This Member expressed the view

that the requirements to execute the Thickness Measurements of the area subject to Close Up Surveys are expected into the table relevant to "MINIMUM REQUIREMENTS FOR THICKNESS MEASUREMENTS AT SPECIAL SURVEY ....." while the paragraph 1.4 of the document contains only the requirement that "Thickness Measurements of the areas subject to close up surveys shall be taken in conjunction with the close up survey".

Panel discussed and considered that wordings of Para 1.4 of current UR Z7s/10s need to be revised in order to clarify this issue; finally Panel agreed to add additional wording to Para.1.4.

- b) Panel, following the proposal submitted by a Member, concurred and agreed that in case the cargo hold hatch covers have a configuration that does not permit the ingress of the surveyor for the internal inspection (e.g. box type panel), the close up survey should be limited to external parts as well as the Thickness Measurements that should be performed only on the external plating. The technical background, on which is based the modification of the requirement, is that the internal structure of a hatch cover of box type construction are reasonably not subject to any corrosion phenomenon. Hence, unless the external plating of the box is damaged, no depletion of the internal structures is expectable.

Panel discussed the matter under item PSU13051 and considered that an explanation note to Para 2.2.4.1 and to Table 1 of current UR Z7.1 need to be added to clarify this issue.

## **.5 Other Resolutions Changes**

The amendment a) affects UR Z7, UR Z7.1, UR Z7.2, UR Z10.1, UR Z10.3, UR Z10.4 and UR Z 10.5.

The amendment b) affects also UR Z 10.2 and UR Z 10.5.

## **.6 Dates:**

Panel Approval: At 20th Survey Panel Meeting (5 September 2014)  
GPG Approval: 05 February 2015 (14193\_IGc)

## **• Rev.10 (Jan 2014)**

### **.1 Origin of Change:**

- Suggestion by an IACS member

### **.2 Main Reason for Change:**

Consider appropriate text in IACS document regarding class period for lengthy conversions.

### **.3 List of non-IACS Member classification societies contributing through the TC Forum and/or participating in IACS Working Group:**

None

#### **.4 History of Decisions Made:**

With reference to IMO Res. A1053 (27) (5.5 Application of "special circumstances") an IACS member proposed to add suitable text in appropriate IACS document regarding class period for lengthy conversions. This Member expressed that when a renewal survey has been completed, the new 5 year class period would normally be calculated from the expiry of previous class period/class certificate and in some cases this might result in unreasonably short time from one renewal survey completion until the next renewal would be due.

Panel discussed the matter under item PSU13051 and considered that wordings of Para 2.13 of current UR Z7s/10s (second sentence) could address this issue but finally agreed to add additional text to Para.2.1.3 in order to clarify this matter.

#### **.5 Other Resolutions Changes**

The identical amendment affects UR Z7, UR Z7.2, UR Z10.1, UR Z10.2, UR Z10.3, UR Z10.4 and UR Z 10.5.

#### **.6 Dates:**

Panel Approval: At 18th Survey Panel Meeting (5 September 2013)  
GPG Approval: 14 January 2014 (Ref: 12011aIGd)

### **• Rev.9 (May 2013)**

#### **.1 Origin of Change:**

Suggestion by IACS members

#### **.2 Main Reason for Change:**

- a) An inquiry from a member whether the 'Other equivalent means' referred in Para 5.3.2 of IACS UR Z10.2 include the use of Cherry Pickers for survey of other structures. (PSU 12022)
- b) A Panel member raised a query about the definition of "dedicated forest product carrier" and how does it differ from a timber or log carrier. (PSU12040)

#### **.3 List of non-IACS Member classification societies contributing through the TC Forum and/or participating in IACS Working Group:**

None

#### **.4 History of Decisions Made:**

- a) Discussion of this matter initiated by a Panel member regarding the use of Cherry Pickers in Cargo Holds with reference of IACS URZ10.2. In accordance with UI SC191 and Rec 91, the Cherry Picker is allowed up to 17m height for Cargo Hold structure (ships constructed after 2006 for Alternative means of access). As per



the provisions of URZ10.2, Cherry pickers are allowed for survey of side shell frames only.

Panel discussed and considered that Para 5.3.2 of UR Z10.2 allows the use of Cherry Pickers as 'Other equivalent means'. Accordingly, Panel agreed to clarify this matter by including text "hydraulic arm vehicles such as conventional cherry pickers" to UR Z10s and UR Z7s for a ship not subject to the above 17m restriction.

- b) Panel discussed to define "dedicated forest product carrier" under PSU 12040. However, Panel was unable to define this type of ship in terms of the "dedicated forest product". Panel agreed to delete this type of ship from URZ7.1 considering that this type of ship might also be a general dry cargo ship and could be surveyed accordingly.

## **.5 Other Resolutions Changes**

- a) The identical amendment affects UR Z7, UR Z10.1, UR Z10.2, UR Z10.3, UR Z10.4 and UR Z 10.5.

## **.6 Dates:**

Panel Approval: 7 March 2013 during Survey Panel Meeting  
GPG Approval: 22 May 2013 (Ref: 9640\_IGn)

## **• Rev.8 (Oct 2011)**

### **.1 Origin of Change:**

- Suggestion by an IACS member

### **.2 Main Reason for Change:**

The design of General Dry Cargo Ships has evolved significantly in recent years. Many of these modern multi-purpose ships are now with a double-side skin extending for the entire length and height of the cargo-carrying area, with in-built container-carrying capability.

The traditional general dry cargo ship was of single-side skin construction with tween decks, as indicated in Figures 1 and 2 of UR Z7.1, and it is for this structural configuration that the need was perceived to enhance surveys to include Close-Up Surveys.

IMO Resolution MSC 277(85) Para 1.6.1 also makes the distinction that double-side skin general dry cargo ships are of significantly different construction from conventional general dry cargo ships.

The double-side skin construction ship is afforded significantly more protection to cargo spaces than the traditional single-side skin design, and is akin to a container ship in configuration. For these reasons it was considered correct to exclude double-side skin general cargo ships, with the double-side skin extending over the entire length and height (to the upper deck) of the cargo carrying area from the requirements of IACS UR Z7.1.

### **.3 List of non-IACS Member classification societies contributing through the TC Forum and/or participating in IACS Working Group:**

None

### **.4 History of Decisions Made:**

The matter was raised by a member and agreed by the majority of panel members under job PSU 10051. Some detail discussion ensued on wording, implementation dates and definitions, both by correspondence and at the Spring Meeting of the Panel 2011.

One member did not agree with the proposal, citing concerns with specific types of damages, including grab damages and other aspects associated with the carriage of bulk cargoes on double-side skin general dry cargo ships, and most particularly river/sea navigation type ships.

### **.5 Other Resolutions Changes**

None

### **.6 Dates:**

Original Proposal: *17 November 2010 Made by a Member*

Panel Approval: *02 March 2011*

GPG Approval: *19 October 2011 (Ref: 11153\_IGb)*

## **• Rev.7 (July 2011)**

### **.1 Origin of Change:**

Suggestion by an IACS member

### **.2 Main Reason for Change:**

Following external audit a member was advised that a small temporary doubler on a cross-deck strip of a bulk carrier should have been promptly and thoroughly repaired at the time of survey. The member carried out an investigation and found that the actions of the surveyor were fully justifiable, the temporary repair and short term Condition of Class imposed were an appropriate method of dealing with such a situation. The member advised that the current requirements for 'Prompt and Thorough Repair' stipulated under the UR 7 and UR 10 series do not give any leeway for carrying out temporary repairs (and imposing a Recommendation/Condition of Class in accordance PR 35) where the damage in question is isolated and localised, and in which the ship's structural integrity is not impaired.

The Survey Panel discussed the matter and agreed that under carefully defined circumstances a temporary repair and short term Recommendation/Condition of Class would be an appropriate course of action.

### **.3 List of non-IACS Member classification societies contributing through the TC Forum and/or participating in IACS Working Group:**

None

### **.4 History of Decisions Made:**

The matter was discussed by correspondence within the Survey Panel and at the Autumn 2010 Panel Meeting. Following discussion at which the possibility of a Unified Interpretation being raised was considered, it was eventually decided to make direct amendment to the relevant Unified Requirements.

The wording of the new paragraph to be inserted as Para 1.3.3 in all relevant Unified Requirements was extensively discussed prior to agreement.

The proposal was unanimously agreed by Survey Panel Members.

### **.5 Other Resolutions Changes**

The identical amendment affects UR Z7, UR Z7.1, UR Z7.2, UR Z10.1, UR Z10.2, UR Z10.3, UR Z10.4 and UR Z 10.5.

### **.6 Dates:**

Original Proposal: *September 2010 Made by a Member*

Panel Approval: *March 2011*

GPG Approval: *27 July 2011 (Ref: 11118\_IGb)*

#### **• Rev.6 (March 2009)**

Survey Panel Task 62 - Harmonization of UR Z10s to UR Z10.3(Rev.10) – GPG Subject No: 7718b

See TB document in Part B.

#### **• Rev.5 (Nov 2007)**

Survey Panel Task 1 – Concurrent crediting of tanks- GPG Subject No: 7690

See TB document in Part B.

#### **• Rev.4 (Aug 2006)**

GPG Subject No: 5031f

See TB document in Part B.

- **Rev.3 (Jan 2006)**

GPG Subject No: 5066

See TB document in Part B.

- **Rev.2 (June 2005)**

GPG Subject No: 1060g

WP/SRC Task 102 - harmonization of UR Zs (also some substantive amendments).  
Subject nos 4072c WP/SRC Task 114 re TM report. WP/SRC harmonisation Task 102  
outcome submitted to GPG 13/10/04 by 10/10/04 by 1060gNVI and as  
GPG57/6.1/WP-1.

- **Rev.1 (June 2003)**

Previously Z10.6.

See TB document in Part B.

- **NEW (June 2002)**

No TB document available.

## **Part B. Technical Background**

List of Technical Background (TB) documents for UR Z7.1:

Annex 1. **TB for Rev.1 (June 2003)**

See separate TB document in Annex 1.

Annex 2. **TB for Rev.2 (June 2005)**

See separate TB document in Annex 2.

Annex 3. **TB for Rev.3 (Jan 2006)**

See separate TB document in Annex 3.

Annex 4. **TB for Rev.4 (Aug 2006)**

See separate TB document in Annex 4.

Annex 5. **TB for Rev.5 (Nov 2007)**

See separate TB document in Annex 5.

Annex 6. **TB for Rev.6 (Mar 2009)**

See separate TB document in Annex 6.

Annex 7. **TB for Rev.7 (July 2011)**

See separate TB document in Annex 7.

Annex 8. **TB for Rev.8 (Oct 2011)**

See separate TB document in Annex 8.

Annex 9. **TB for Rev.10 (Jan 2014)**

See separate TB document in Annex 9.

**Note:** *There are no separate Technical Background (TB) documents for the original resolution (June 2002), Rev.9 (May 2013), Rev.11 (Feb 2015), Rev.12 (June 2016), Rev.13 (Aug 2017), Rev.14 (Jan 2018), Rev.15 (June 2019) and Corr.1 (May 2024).*

## **UR Z7.1 (Rev.1)**

**(Re-categorization of Z10.6 as Z7.1, June 2003)**

### **Technical background**

#### **1. Objective**

WP/SRC in its Progress Report to GPG 54 reported that under their Task "Harmonization of UR Z10s" WP agreed that Z10.6 should be re-categorized as Z7.1 since it did not contain the whole of essential ESP requirements such as survey planning document and executive hull summary.

GPG agreed.

#### **2. Points of discussion**

At GPG 53 meeting, DNV raised a concern that ships whose tonnage is in excess of 500 GRT but exempted from SOLAS requirements may fall under the scope of application of UR ex-Z10.6. DNV suggested to change the application scheme in Z7.1.1.1 from "500 grt" to "ships having SOLAS SC certificate".

DnV further clarified that IACS Members are not always the organizations issuing the SAFCON certificate and therefore the issue on whether or not a ship is issued with a SAFCON is not evident. Finally, the application scheme remains unchanged.

BV suggested that livestock carriers and deck/dock ships be excluded from the application of UR Z7.1. Agreed. See 1.1.1 and a footnote of the UR 7.1.

\*\*\*

submitted by the Permanent Secretariat

30 June 2003

**WP/SRC Task 102**  
**HARMONIZATION OF UR Z7s AND Z10s**

**Technical Background**

**UR Z7 (Rev. 11)**

**UR Z7.1 (Rev. 2)**

**UR Z10.1 (Rev. 12)**

**UR Z10.2 (Rev. 17)**

**UR Z10.3 (Rev. 7)**

**UR Z10.4 (Rev. 2)**

**UR Z10.5 (Rev. 1)**

Contents:

TB for Harmonization

**Annex 1.** TB for UR **Z10.1(Rev.12**, C49 amendments(coating-related))

**Appendix 1:** Memo for Coating, submitted to Council  
49(June 2004).

**Appendix 2:** DNV proposal (25 May 2005) agreed by Council

**Annex 2.** TB for "Verification/Signature of TM Forms" for records.

**Annex 3.** TB for revision of UR Zs concerning "anodes".

**1. Objective**

To amend UR Z7s and Z10s in order to make the texts of the above-mentioned URs consistent eliminating all the differences both in substance and in wording (WP/SRC Task 102).

**2. Background**

In the process of approving UR Z10.4, GPG found it necessary to amend the other existing URs Z10.1, Z10.2, Z10.3, Z10.6 and Z7 in order to eliminate any inconsistencies existing among them.

**3. Methodology of work**

The WP has progressed its work through many sessions, both during the periodical meetings and dedicated meetings restricted to a Small Group of Members (BV, DNV, GL, LR, RINA) who developed the work in order to be more efficient. All the proposed amendments of the Small Group have regularly been circulated to all Members for comment and agreement.



## 4. Discussion

4.1 The WP/SRC has completed a comprehensive comparative review of UR Z7 and Z10s, and identified inconsistencies which existed among them. During this review, attention was given to the severity of the requirements applicable to the same spaces/structural areas on different types of ESP ships. As a result, the inconsistencies were eliminated making the URZs harmonized. However, there has been no change to the scope and extent of the survey requirements.

4.2 The starting point for each UR was the most updated version available at the time of commencement. Any revision to the URZs, which were introduced during this task, was taken into account. As for instance, the UR Z10.1 was initially amended based on Rev. 9, while the last amendments are based on Rev. 11 and the UR Z10.2 was initially amended based on Rev. 13, while the last amendments are based on Rev. 16. The proposed revisions of URs Z10.1 and Z10.4 have not been numbered, as there will be revisions to those URs before the revisions introduced by the Task 102 are adopted. In fact, GPG is currently developing a Revision 12 of Z10.1 with the view to introducing significant improvements in the survey regime for ballast tanks (including combined cargo/ballast tanks) of oil tankers and UR Z10s applicable to oil tankers will also have to be revised by incorporating the amendments to A.744(18) contained in Resolution MSC 144(77), which enter into force 1 January 2005 (see 4.3 below).

4.3 Also, in harmonizing UR Z10.1 and Z10.2 care has been taken to align the corresponding text with that of IMO Res. A.744(18). However, it has been noted that the amendments to A.744(18) contained in Resolution MSC 144(77), which enter into force 1 January 2005, have not been incorporated into the IACS UR Z10s applicable to oil tankers. It seems that the updating of the above-said UR Z10s will be done by the Perm Sec and reviewed by the WP/SRC Chairman and then circulated for adoption by GPG with concurrence of Council Members for uniform application from 1 January 2005. It is understood that the revisions of the UR Z10s affected by those amendments will not include the changes introduced by the Task 102, as the implementation date proposed for those changes is 1 January 2006 (see below **6. Implementation**).

4.4 In the course of the work the WP has been developing for more than two years, several additional Tasks were assigned to the WP by GPG which affected the development of Task 102. The additional tasks which have been taken into account are the following:

- 1) In the course of Council discussion on UR Z10.6 (General Cargo Ships), certain inconsistencies were identified between Z10.6 and other Z10s. WP was instructed to expedite Task 102 (1060gIAa, 12 June 2002);
- 2) WP was instructed to include "Survey Planning for Intermediate Survey" into harmonization work (2108\_IAa, 12 July 2002);
- 3) GPG instructed WP to consider whether Z10.6 should be re-assigned as Z7.1, in connection with the harmonization work. 1060gIAb, 20 Sept 2002.

- Z7.1 developed;
- 4) Partial outcome (Z7 and Z7.1) was submitted to GPG on 17 July 2003(1060g). Council decided that approval of Z7(Rev.10) and Z7.1(Rev.2) is postponed until the harmonization is completed (1060gICb, 6 April 2004);  
[Council Chairman instructed WP/SRC to Members' comments on the draft revision of UR Z7 and Z7.1 \(collected under s/n 1060g, 1060gNKi \(30/03/2004\) in particular\) on 6 April 2004.](#)
  - 5) GPG tasked WP to include the amendments to Z10.2 / Z11 (BCs with hybrid cargo hold arrangements), deleting sheets 15 and 16 for ore carriers, into the harmonized UR Z10s (2212aIGa, 19 Jan 2004);
  - 6) GPG tasked WP to consider whether the requirements relevant to examination of Fuel Oil Tanks in the cargo area at each Special Survey should be put into Z10s, and internal examination of FOT at Intermediate Survey after SS 2 is needed. (1060gIAf, 30 Jan 2004);
  - 7) GPG tasked WP to harmonize tank testing requirements in Z7s and Z10s. (3006IIAa, 5 April 2004);
  - 8) GPG tasked WP with Task 108 - Develop uniform survey requirements for air vent pipes including the welded connection to deck. Z22 developed. GPG instructed WP to incorporate Z22 into the harmonized Z10s;
  - 9) GPG tasked WP with Task 114 - Verification and signature of TM reports. REC 77(Rev.1) developed and approved on 29 July 2004. Council approved parallel amendments to Z7.1 and Z10s (TM Forms included) and instructed WP to incorporate these into the harmonized Z10s:
    - [Recommendation No.77 was revised \(Rev.1, July 2004\);](#)
    - [Z7.1 para.6.3.2 and Z10s para.7.3.2 so amended.](#)
    - ["Surveyor's signature" is deleted from all TM Forms in Z10s;](#)
    - [A note is added to Annex II\(Z10s\) declaring that Annex II is recommendatory.](#)

WP/SRC's investigation into Members' practice in dealing with verification and signature of TM reports is annexed for record keeping purpose. [See Annex 2.](#)
  - 10) GPG tasked WP to consider the BV comments on "TM may be dispensed with..." and include the findings into the harmonized Z10s ( 2219iIAa, 7 April 2004).

## **5. Agreement within the WP/SRC**

All Members have unanimously agreed the attached final versions of UR's.

## **6. Implementation**

WP/SRC is of the view that the Members need 12 months from the adoption date to implement these amendments into their class rules. Assuming Council adoption in December 2004, WP/SRC would propose January 2006 as implementation date.

- Annex 1:** TB for UR Z10.1(Rev.12, C49 amendments, see Permsec's note 1 below)  
**Annex 2:** WP/SRC Task 114, verification and signature of TM reports(see 9 above).  
**Annex 3:** TB for revision of UR Zs concerning "anodes".

### **Note by the Permanent Secretariat**

1. Annex 1 to this TB contains background for amendments to UR Z 10.1(Rev.12) relating to FAIR/POOR/GOOD (C49 amendments). Council at its 49<sup>th</sup> meeting (June 2004) agreed/decided that comparable changes should be added to Z10.3 and Z10.4.
  
2. Appendix 3 "TM sampling method" has been added to UR Z10.1 and Z10.4 to keep them consistent with IMO Res.MSC.144(77). The amendments to A.744 contained in MSC.144(77) entered into force on 1 January 2005. (*GPG s/n 4181*)  
  
Under s/n 4072g, paragraph **2.4.6** of UR Z10.1 and **2.4.6** and of UR Z10.4 (paragraph numbering is now harmonized) were amended in order to provide a link between the main text of the UR Z10.1 and 10.4 and the new Annex III Appendix 3 containing the MSC Res.144(77).  
Further, it was agreed that the requirements for evaluation of longitudinal strength of the hull girder (as written in MSC.144(77)) should not be required for Intermediate Survey unless deemed necessary by the attending Surveyor. This is covered in 4.2.3.1 and 4.2.4.1 of Z10.1 and Z10.4.
  
3. GPG agreed that the amended UR Zs should be implemented from 1 July 2006 altogether.
  
4. DNV's proposed amendments to UR Z10.1, Z10.3 and Z10.4 concerning annual survey of ballast tanks were agreed by Council (1060gICq, 27 June 2005). See Appendix 2 to Annex 1.
  
5. Annex 3 contains a TB for revision of UR Zs concerning "anodes".

Date: September 2004  
Prepared by the WP/SRC

---

## **Annex 1 to Technical Background**

### **UR Z 10.1 (Rev.12, C49 amendments(coating-related))**

#### **1. Objective**

To introduce significant improvements in the survey regime for ballast tanks (including combined/ballast tanks) of oil tankers as matter of strategic concern and urgency to IACS, given the aging of both the single and double hull tanker fleets and the problems encountered with corrosion of ballast tanks in several shipping casualties.

#### **2. Background**

Draft amendments to UR Z10.1 were submitted to Council 47 (June 2003) and agreed in principle.

#### **3. Discussion**

There was particular concern over accelerated corrosion with age (as the thinner the material, the more rapidly the allowable diminution margin percentage disappears) especially where coatings have broken down. There is also a disincentive for any spend on maintenance of the structure of a ship within a few years of its statutory scrapping date.

Council discussion by correspondence had evolved to the position of substantive proposals – summed as follows (3095\_ABa, 2 June 2003):

1. Enhance the Intermediate Survey in Z10.1, Z10.3 and 10.4 for Tankers after 2<sup>nd</sup> Special / Renewal Survey to the same level (scope of work) as the preceding Special / Renewal Survey). This corresponds to the latest revision to UR Z10.2.
2. At Annual Survey of ballast tanks with substantial corrosion, the overall survey is to be replaced by close-up survey with thickness measurements of the exposed area.
3. Proposed to task WP/SRC to re-consider the acceptance criteria for the rating FAIR further. For this, eliminate FAIR, leaving only GOOD and POOR redefined as appropriate.
4. Proposed to task WP/SRC to explicitly require close-up survey of Suspect Areas identified at the previous Special Survey.

Council 47 discussed the proposals(June 2003) as follows:

##### **1. Definition of FAIR**

Council 47 agreed that “FAIR” would be retained as a rating and that GPG should instruct WP/SRC to redefine FAIR, so that there would be a clear differences between FAIR, POOR and GOOD. It was also agreed that for oil tankers the Intermediate Survey following Special Survey No.2 would have the same scope as Special Survey No.2(Z10.1). WP/SRC should also clarify the definition of satisfactory repair.

Based on the strong majority, Council agreed to discuss with Industry annual surveys of ballast tanks when coating is found in LESS than GOOD condition at special survey, with the objective to encourage the owner to carry out repairs and maintenance of coating to GOOD condition.

*DNV and NK stated that they could not accept a requirement for annual surveys of ballast tanks when the coating condition is less*

*than GOOD and proposed that GOOD be changed to FAIR (3095\_IGc, 30 June 2003)*

2. ABS' proposed amendments to Z10.1(annual examination of BWTs in certain conditions) were approved.
3. C 47 agreed that the BWT coating requirements (Z10.1.2.2.3) for intermediate Survey after SS 2 should be the same extent to the previous SS.
4. Given the substance of the changes, the revised Z10.1 should be shown to Industry before adoption.
5. A guidance for coating repairs needs to be developed by WP/SRC with reference to TSCF Guidelines.

Following Council 47, the draft text of Z10.1(Rev.12) was distributed to Industry and discussed at the IACS/Industry meeting on 29 August 2003. Industry indicated that UR Z10.1(Rev.12) is acceptable, provided that appropriate IACS guidelines on coating repairs are developed.

The Small Group on Coating (SG/Coating) under WP/SRC prepared draft guidelines on coating repairs and considered the definitions of GOOD / FAIR / POOR. The SG/Coating did not change the definitions and found that the Guidelines provide useful clarifications on the definitions and criteria in achieving an industry wide uniform judgement of coating conditions as well as what is needed to restore GOOD conditions.

Further, an IACS/Industry JWG/Corrosion was established and met in February 2004. The outcome is (3095\_IGh, 4 June 2004):

- Draft Guidelines on Coating Repair (IACS REC 87)
- Draft UR Zxx (mandatory coating of cargo tanks on oil tankers)
- Draft UI SC 122 (Rev.2) – mandatory coating of ballast tanks

#### **4. Others**

1. Z10.11.2.2bis - Definition of “Combined Cargo/Ballast Tank. ...as a routine part of the vessel's operation and will be treated as a Ballast Tank. ...”. By so amending, Z10s do not need to repeat “Ballast Tanks and Combined cargo/salt water Ballast Tanks” in addressing the ballast tanks. Hence, all the references to “and Combined cargo/salt water Ballast Tanks” were deleted.
2. Z10.1.2.2.1.2: The aim of the examination is to be sufficient to discover substantial corrosion...  
Comparable changes are to be added to other UR Zs wherever the same sentence occurs.
3. “IACS Guidelines for Coating Maintenance & Repairs for Ballast Tanks and Combined/Ballast tanks on Oil Tankers” are referenced where relevant.
4. Comparable changes are to be added to UR Z10.3 and Z10.4, after adoption of Z10.1(Rev.12).

**Attached: Memo on Coating Matters (GPG Chairman)**

9 June 2004  
Prepared by the Permsec

## **Appendix 1 to Annex 1:**

## **MEMO on Coating matters**

### **1. Background and discussion within IACS on UR Z10.1 (draft Rev.12) between 29/01/03 and 14/08/03**

In view of the survey experience with oil tankers, it was proposed that all ballast tanks should be examined, routinely and uniformly, at annual surveys on ESP tankers exceeding 15 years of age. IACS should amend UR Z10.1 to require the examination of ballast tanks on such ships at each annual survey. This is simple, clear and thorough and not subject to interpretation. (2242\_ABq dated 29/1/03)

Then, ABS modified the proposal asking, for tankers subject to URs Z10.1, Z10.3 and Z10.4, exceeding 15 years of age, that the current requirement - pertaining to annual examination of Ballast Tanks adjacent to cargo tanks with any means of heating - be deleted and replaced by a simpler and more stringent requirement that all Ballast Tanks be subject to survey at each subsequent annual survey where either substantial corrosion is found within the tank or the protective coating is found to be in less than GOOD condition and the protective coating is not renewed at special survey or intermediate survey. This will ensure that all Ballast Tanks with substantial corrosion or protective coating which is not in GOOD condition at the time of special survey or intermediate survey will be examined at each subsequent annual survey on tankers exceeding 15 years of age. (2242\_ABzb dated 14/3/03)

This was later expanded to include all tanks used routinely for ballast water, both ballast-only and cargo/ballast tanks (2242\_ABzc dated 14/3/03).

ABS further reviewed the issue of the survey of salt water ballast spaces and combined cargo/salt water ballast spaces with ABS' governing bodies in light of recent casualties and survey findings on other tankers. Their review found an increasing amount of coating breakdown/failure and subsequent rapid wastage in key structures after Special Survey No. 2, i.e. after 10 years of age. These conditions are most prevalent in the under deck structure and the side shell structure in way of the deep loadline. In a number of cases the serious wastage has caused fracturing of the under deck longitudinals and in some cases fracturing has extended to the main deck structure. This led ABS to refine proposed amendments to URs Z10.1, Z10.3 and Z10.4 to require (2242\_ABzf dated 9/5/03):

#### a. For Tankers exceeding 10 years of age

Salt Water Ballast Spaces and Combined Cargo/Salt Water Ballast Spaces. For tankers exceeding 10 years of age, salt water ballast spaces and combined cargo/salt water ballast spaces are to be internally examined at each subsequent Annual Survey where substantial corrosion is found within the tank or where the protective coating is found to be less than GOOD condition and protective coating is not repaired. Internal examination to be an Overall Survey.

#### b. For Tankers exceeding 15 years of age:

Salt Water Ballast Spaces and Combined Cargo/Ballast Spaces. For tankers exceeding 15 years of age, salt water ballast spaces and combined cargo/ballast spaces are to be examined internally at each subsequent Annual Survey. Where substantial corrosion is found within the tank, or where the protective coating is found to be in less than GOOD condition and the protective coating is not repaired then in addition to an Overall Survey, under deck structure and the side shell structure in way of the deep loadline is to be subject to Close-up Survey.

NK and BV replied that the proposed amendments made by ABS need to be substantiated in a transparent manner with technical data that ABS may possess and put forward for further assessment and discussion. (2242\_NK<sub>n</sub> dated 14/5/03 and 2242\_BV<sub>z</sub> dated 16/5/03)

**DNV** (2242\_NV<sub>n</sub> dated 2/6/03), having carefully considered the practical consequences of taking the ship off-hire for gas freeing etc. and being concerned about the difficulties to have these surveys executed in a safe manner and whether the intended safety benefits in implementing the proposed extended scope of the annual survey of Ballast tanks will be met, **proposed the following alternative measures** which would be as effective and may not have such delaying effects to the ship:

- 1) Enhance the Intermediate Survey in UR Z10.1, 10.3, and 10.4 for Tankers after the 2 Special / Renewal Survey to the same level (scope of work) as the preceding Special / Renewal Survey. (This will correspond to the latest revised requirements of UR Z10.2 for Bulk Carriers.)
- 2) At Annual Survey of ballast tanks with substantial corrosion the overall survey should be replaced by close up survey with thickness measurements of the exposed area. (An overall survey of these tanks does not give sufficient information of the development of the areas with substantial corrosion.)
- 3) Further we will not fail to mention that the WP/SRC has proposed to extend the close up survey in cargo and combination tanks to 30% from the 3 Special / Renewal Surveys.
- 4) **Experience has shown that the coating condition rating category FAIR has a tendency to be stretched too far into the POOR condition. We will therefore propose that we task the WP/SRC to reconsider the acceptance criteria for the rating FAIR further.**
- 5) We do also question the need for redefining the definition of combination tanks, particularly since the category I tankers which are the ships that normally are fitted with these type of tanks are to be phased out 2 to 4 years from now. However DNV will not oppose to such a redefinition.

**DNV requested Members to consider the above as an alternative to the ABS proposal, bearing in mind that we ought to present this to the industry prior to deciding.**

ABS (3095\_Aba dated 2/6/03), having further considered its earlier proposals in light of NV<sub>n</sub>, submitted a revised proposal for consideration by Council at C47 and replied to the above 5 DNV proposals as follows:

- 1) ABS fully supports this proposal.
- 2) While ABS agrees with this proposal, it is in fact already provided for in Z7 (3.2.3) and Z10.1 (3.2.5.1)--which require that "Suspect areas (which include any area where substantial corrosion is found) identified at previous Special Survey are to be examined. Areas of substantial corrosion identified at previous special or intermediate survey are to have thickness measurements taken." To us, this implies that close-up survey of these areas is to be done at annual survey in conjunction with the thickness measurements. However, we can

agree to tasking WP/SRC to explicitly require "close-up" survey in this connection and to amend Z7, and all the Z10's, appropriately to make this explicit, if there is majority support for this.

3) We agree that this has been put forward to GPG by WP/SRC via 0237hNVb, 27 May. However, these additional CAS close-up survey requirements do not apply to salt water ballast tanks; only to cargo oil tanks and combined cargo/ballast tanks.

4) **We agree with this assessment and we propose that the only way to eliminate the subjectivity and raise the standard is to eliminate the category "FAIR" completely; leaving only "GOOD" and "POOR" redefined as follows:**

**"GOOD -- condition with no breakdown or rusting or only minor spot rusting.**

**POOR -- any condition which is not GOOD condition."**

5) ABS does not agree with this proposal. We are particularly concerned that we need a very thorough and robust survey regime for these tankers precisely because they are subject to mandatory phase out over the next several years. We are very concerned that without additional IACS requirements, these tanks will receive little or no inspection and maintenance by owners or others after their last special or intermediate survey, if no substantial corrosion is found at that time. Rapid, localized wastage in way of deteriorating coatings may pose significant hazard if the survey regime is not further tightened as we are proposing.

In conjunction with the above comments on DNV proposals, ABS further considered their previous proposal in ABzf and modified it as follows:

- **ABS simplified the proposal to require annual examination of all salt water Ballast Tanks and combined Cargo/salt water Ballast Tanks irrespective of age, when either substantial corrosion is found within the tank or the protective coating is found to be in less than GOOD condition and is not repaired.**
- the requirement for annual (close-up) examination of salt water ballast tanks and combined tanks is already required in Z10.1 (3.2.5.1). ABS proposed adding it to 2.2.3 for clarity and emphasis so that all the conditions which may lead to annual examination of such tanks are listed together in one place.
- Since the principal problem that we are trying to address is rapid, localized corrosion in way of breakdown or deterioration of the protective coating, we are proposing that the coating condition should be found and kept in "GOOD" condition to obviate the need for annual examination. **The attached proposal is made together with the proposals in items 3.1 (intermediate following Special survey 2 to have same scope as prior Special survey) and 3.4 (eliminating "FAIR" and redefining "POOR" as any condition other than "GOOD" condition.**

ABS requested to decide on a course of action at C47 for tightening the survey regime for tankers. They agreed that industry be informed of Council's decisions in this regard prior to IACS making the decision public, but IACS should maintain its independence and take decisive action in this matter. Debate with industry can only lead to delay and to a watering down and compromising of these important requirements.

NK agreed to task WP/SRC to reconsider the acceptance criteria of "FAIR" for clearly define the border between "FAIR" and "POOR" condition. However, **NK strongly opposed the elimination of "FAIR" coating condition from UR Zs** because this can not resolve to remove subjectivity of coating assessment. The three-categorization system of coating condition should be retained. (3095\_NKa dated 5/5/03)



## **Outcome of C47**

At C47, it was agreed that "Fair" would be retained as a rating and that GPG should instruct WP/SRC to redefine "Fair", so that there would be a clear differentiation between "Fair", "Poor" and "Good". It was also agreed that for oil tankers the Intermediate Survey following Special Survey No.2 would have same scope as Special Survey No.2 (Z10.1). WP/SRC should also clarify the definition of satisfactory repair.

Based on strong majority support Council agreed to discuss with Industry annual surveys of ballast tanks when coating is found in LESS than GOOD condition at special survey, with the objective to encourage the owner to carry out repairs and maintenance of coating to GOOD condition.

This matter should be discussed with Industry prior to adoption of any UR by Council.

In a final summary, the Chairman proposed that a constructive dialogue with Industry should take place on the IACS proposal as set out in WP1 plus maintaining 3.2.5.2 modified to say that ballast/combined ballast/cargo tanks will be subject to annual survey when considered necessary by surveyors.

After discussion in the JWG (Industry/IACS), GPG should propose final rules for this matter to Council, including acceptable repair definition.

**FUA 17:** *To instruct WP/SRC to develop guidance on coating repairs and more precise definition of "Fair" coating condition.*

Once approved, these requirements should be incorporated into Z10.3 and Z10.4.

### **FUA 15**

1) *To prepare a draft revision to UR Z10.1 incorporating C 47 decisions:*

- *The definition of "FAIR" remains as it is;*
- *ABS proposed amendments to Z10.1 (annual examination of BWTs in certain conditions) were approved;*
- *C47 agreed that the BWT coating requirements (Z10.1.2.2.3) for Intermediate Survey after Special Survey No.2 should be the same extent to the previous Special Survey.*
- *Given the substance of the changes, the revised UR Z10.1 should be shown to Industry (OCIMG/Intertanko first among others) before adoption for their review and comments.*
- *A guidance for coating repairs needs to be developed by WP/SRC with reference to TSCF Guidelines.*

2) *GPG Members are to confirm the draft revision to Z10.1 in consultation with their WP/SRC members by correspondence. See 3095\_IGa of 13/06/03.*

According to C47 FUA 15, GPG Chairman circulated (3095\_IGa dated 13/6/03) draft amendments to UR Z10.1 as agreed in principle at C47.

Having received a number on comments, GPG Chairman (3095\_IGb dated 27/6/03) informed that the Council Chairman confirmed that GPG is not to amend the principles agreed at C47, i.e. we are not empowered to change "GOOD" to "FAIR" as proposed by DNV and NK, nor to amend the definitions of "FAIR" and "POOR" as proposed by DNV.

DNV's intention to possibly lodge a reservation was noted, however the matter should be raised at Council and not be dealt with by GPG. An amended draft text incorporating the non-substantive changes proposed by Members was circulated.

DNV said that its understanding was that the draft should be circulated to the Industry (ICS, INTERTANKO, and BIMCO) prior to adoption by Council. (3095\_NVc dated 30/6/03)

GPG Chairman (3095\_IGc dated 30/6/03) circulated a draft amendment of UR Z10.1 for Council's agreement and use in discussions with the industry associations.

The draft was generally agreed by GPG but individual Members have requested that the following matters (which were deemed to be outside the remit of GPG in this task) be brought to Council's attention for further consideration:

- 1 DNV and NK stated that they can not accept a requirement for annual surveys of ballast tanks when the coating condition is less than GOOD and propose that GOOD be changed to FAIR.
- 2 In connection with item 1 above, DNV also propose to amend the definitions of FAIR and POOR in order to raise the standard of FAIR.

Council Chairman (3095\_ICb dated 14/8/03) concluded that Council has agreed that the draft amendments to UR Z10.1 attached to IGc reflect Councils' decision taken at C47 and that they be circulated to industry associations.

Perm Sec was therefore invited to submit the draft to OCIMF and INTERTANKO in view of discussion at the IACS/ industry meeting on 29 August.

## **2. Discussion with Industry (29/08/2003 – 11/10/2003)**

As requested by Council, the whole matter was presented to Industry during the “general matters” meeting with IACS held on 29 August 2003; comments from Industry were requested. In the following an extract from the minutes of the meeting (see message 3100aIAb dated 5 September 2003):

\_\_\_\_\_ from Meeting minutes \_\_\_\_\_

## **4. & 5. Annual surveys of ballast tanks and IACS guidelines on coating repairs**

M. Dogliani introduced the matter ([see Items 4&5 in Appendix](#)).

A. LinoCosta gave a presentation to show where concerns and decisions stand: too many cases when coating was considered fair at SS but problems occurred just after one/two years.

N. Mikelis commented on draft amendments to Z10.1 (Rev.11) stating that the extent of annual survey is not clear; it should be limited to the affected zones, e.g. coating breakdowns, only.

M. Guyader clarified that, in this draft amendments, it is expected an overall survey of the whole tank and a close up survey of the affected zones.

N. Mikelis noted that, in the draft amendments to Z10.1 (Rev.11), the intermediate survey at 12.5 years would have the same scope as the previous special survey and that needed a justification. See 7 a).

M. Dogliani said that Z10.1 (Rev.11) was adopted in August 2003 and will be introduced into IACS Societies' Rules over the next year.

### Conclusions:

4.1 Industry shared IACS concerns on coatings and, in general, agreed with the draft amendments to Z10.1 (Rev.11) suggesting also extending them to Z10.2 on bulk carriers

4.2 Industry agreed that a guideline for surveyor on coating would greatly improve uniform application of so-amended Z10.1 including issues such as how to consider load bearing elements when judging GOOD/FAIR/POOR status and how to consider bottom pitting in connection with GOOD conditions

4.3 Industry will more precisely comment, by the end of September, the draft Z10.1 so as for IACS to finalise the matter, as planned, for the Council's December meeting.

Item	Title	Industry recommendation	IACS/ M. Dogliani Introduction
4 & 5	Annual survey of ballast tanks IACS guidelines on coating repairs	NN	<p><b>1. IACS is considering the following:</b></p> <ul style="list-style-type: none"> <li>- <b>amend UR Z10.1 (draft circulated to Industry) to the effect that in case at Special Survey or Intermediate Survey the coating in a ballast tank is found less than GOOD, either GOOD conditions are restored or the tank's coating is inspected at each annual survey;</b></li> <li>- <b>develop IACS guideline to assist an uniform application of the so modified (if adopted) UR Z10.1; the guideline should address which repairs are necessary to restore GOOD conditions from FAIR and POOR respectively and which are the criteria for the restored (after repair) situation to be rated as GOOD.</b></li> </ul>

\_\_\_\_\_ End of extract from minutes \_\_\_\_\_

INTERTANKO commented (see R. Leslie email to GPG dated 25 September 2003):

- expressing their concern for the draft Z10.1 and underlining
  - a) targeting: concerns that, if not properly dealt with, Z10.1 would target all ships and not just those which need intervention; the view was expressed that guidelines would probably solve the matter;
  - b) definition: indicating that the current definitions of GOOD, FAIR and POOR is not clear enough and that the matter would be even worst with GOOD and NON GOOD; again it was indicated that guidelines could solve the matter;
  - c) expertise: expressing doubts on IACS' surveyors expertise and ability to judge coating conditions; in this respect they (hiddenly) suggest that IACS position is unclear when we say that we are not competent to judge the coating during construction but then we are competent to judge coating during operational life. Even if not explicitly stated, the impression is that also in this case guidelines would help.

Additionally, INTERTANKO suggested a (quite detailed) set of assessment criteria.

The matter was then finally addressed at the TRIPARTITE Meeting (held in Soul on 29/30 September 2003). There Industry agreed that the way forward was the (joint) development of IACS guidelines (see minutes attached to message 3100\_RIe dated 11 October 2003, an extract of which is reproduced below).

\_\_\_\_\_ Extract from the TRIPARTITE minutes \_\_\_\_\_

Industry is concerned by the definition of GOOD/NOT GOOD in relation to coating repairs and acceptance criteria. Industry agreed that new guideline on this, which IACS is already producing, was the way forward.

\_\_\_\_\_ End of the extract from the minutes \_\_\_\_\_

### **3. Further developments**

- a) from the above, it was concluded that, provided the guidelines are sound, Industry would accept the concept of Z10.1 (draft) Rev. 12, therefore an IACS team and a JWG were established in order to progress the matter of the guidelines (among other related matters).
- b) the team of IACS experts on coating developed draft guidelines and provided recommendations to GPG on the way forward (attached to message 3095bNVc dated 20 November 2003).
- c) the guidelines were discussed within the JWG with Industry (see draft minutes circulated within GPG with messages 3095cIGd and 3095cIGe both dated 13 March 2004)
- d) further suggestions and comments (as requested at the meeting) were provided by Industry (not circulated to GPG)
- e) Bulk Carrier Industry is recommending that similar guidelines are developed in due time also for bulk carriers
- f) at DE47 and MSC78, IMO is asking Industry and IACS to develop (compulsory) performance standards for coating of newbuilding (double hull spaces of DSS Bulk Carriers), a matter which is, indirectly related to the above one.

1 June 2004

M. Dogliani

IACS GPG Chairman

IACS JWG/COR Chairman

Appendix 2 to Annex 1: [DNV proposal to Z10.1, Z10.3 and z10.4](#) ▶

Sent Monday, July 4, 2005 4:45 pm

To [Gil-Yong <gilyonghan@iacs.org.uk>](mailto:Gil-Yong <gilyonghan@iacs.org.uk>)

Cc

Bcc

Subject Fw: 1060gNVs; WP/SRC - Task 102 - Harmonization of UR Z 7 and Z 7.1

Attachments [Doc1.doc](#)

25K

----- Original Message -----

From: "Debbie Fihosy" <[debbiefihosy@iacs.org.uk](mailto:debbiefihosy@iacs.org.uk)>

To: "CCS" <[iacs@ccs.org.cn](mailto:iacs@ccs.org.cn)>

Cc: "IACS Permanent Secretariat" <[permsec@iacs.org.uk](mailto:permsec@iacs.org.uk)>

Sent: Friday, June 03, 2005 2:52 PM

Subject: FW: 1060gNVs; WP/SRC - Task 102 - Harmonization of UR Z 7 and Z 7.1

Forwarding as requested

-----Original Message-----

From: Arve.Myklebust@dnv.com [[Arve.Myklebust@dnv.com](mailto:Arve.Myklebust@dnv.com)]

Sent: 25 May 2005 15:49

To: [AIACS@eagle.org](mailto:AIACS@eagle.org); [iacs@bureauveritas.com](mailto:iacs@bureauveritas.com); [iacs@ccs.org.cn](mailto:iacs@ccs.org.cn);

[johnderose@iacs.org.uk](mailto:johnderose@iacs.org.uk); [iacs@dnv.com](mailto:iacs@dnv.com); [iacs@gl-group.com](mailto:iacs@gl-group.com);

[gilyonghan@iacs.org.uk](mailto:gilyonghan@iacs.org.uk); [helenbutcher@iacs.org.uk](mailto:helenbutcher@iacs.org.uk); [efs@iacs.org.uk](mailto:efs@iacs.org.uk);

[krsiacs@krs.co.kr](mailto:krsiacs@krs.co.kr); [richardleslie@iacs.org.uk](mailto:richardleslie@iacs.org.uk); [external-rep@lr.org](mailto:external-rep@lr.org);

[clnkiacs@classnk.or.jp](mailto:clnkiacs@classnk.or.jp); [terryperkins@iacs.org.uk](mailto:terryperkins@iacs.org.uk); [iacs@rina.org](mailto:iacs@rina.org);

[iacs@rs-head.spb.ru](mailto:iacs@rs-head.spb.ru); [colinwright@iacs.org.uk](mailto:colinwright@iacs.org.uk)

Subject: FW: 1060gNVs; WP/SRC - Task 102 - Harmonization of UR Z 7 and Z 7.1

25 May 2005

To: Mr. B. Anne, Chairman of IACS Council,

cc: Council Members, IACS Perm. Sec.

Ref.: My mail NVr dated 20 May 2005

DNV have further studied the amendments to UR Z10.1, Z10.3, and Z10.4, and as a result are presenting the following as a compromise solution:

General comment:

From the comments by other Members it is obvious that there is reluctance to accept annual surveys of ballast tanks with a common plane boundary to heated cargo tanks in the case where the coating is in good condition. This is particularly unreasonable as at the same time we enhance the Intermediate survey of Tankers between 10 and 15 years to also include examination of all ballast tanks, meaning that all ballast tanks will be close up surveyed with 2-3 years intervals from the ship is 10 years old, with the possibility for the surveyor to require thickness measurements and testing of the tanks to ensure the structural integrity of the tanks if necessary.

It is also proposed for the Intermediate survey between 5 and 10 years, to increase the scope from representative to all ballast tanks, a requirement DNV find to strict, and require that we here keep the original text.

If a ballast tank is found to have coating in GOOD condition at the renewal or intermediate survey, a deterioration of the tank beyond structural reliability is very unlikely even if the tank has a common plane boundary to a heated cargo tank.

DNV finds it particularly unreasonable to have this requirement to apply to double hull tankers for the following reasons:

- these ships have double hull and the risk of pollution is here much reduced,
- the double hull is constructed with small spaces giving improved structural reliability,
- almost all double hull tankers below VLLC have heated cargo tanks, and all ballast tanks have common plane boundaries to these tanks, meaning that this requirement will apply to a major part of the tanker fleet in the future,
- the ballast tanks of double hull tankers are so designed that a general examination of these tanks will be identical to a close up survey,
- survey of ballast tanks of double hull tankers will mean either gas freeing of all cargo tanks or at least dropping the inert gas pressure of all cargo tanks in addition to proper airing of all ballast tanks.

Since the single hull tankers will be faced out in the near future, and for clear political reasons, DNV will as a compromise proposal to keep paragraph 2.2.3.1 and 4.2.2.2 in Z 10.1 as amended by Council (ref. IAo) but amend it to not include 2.2.3.1.e, 4.2.2.2.e and last paragraph of 3.2.5.1 in Z10.3 and Z10.4. In addition we request that the original text of 4.2.2.1 is kept.

If BV, ABS and other Members can accept this DNV is willing to drop our reservation presented at C49.

DNV's proposal will then be as follows:

Z10.1:

2.2.3.1: This paragraph can be accepted as is for the reasons stated above.

3.2.5.1: This paragraph is accepted as amended.

4.2.2.2: This paragraph can be accepted as is for reasons stated above.

For other comments to Z10.1 see NVo and NVp.

Z10.3:

2.2.3.1.e to be deleted.

3.2.5.1 delete last paragraph

4.2.2.1 the original text to be kept. "For tanks used for water ballast ---"

4.2.2.2.e to be deleted

Z10.4

2.2.3.1e to be deleted

3.2.5.1 delete last paragraph

4.2.2.1 the original text to be kept, "For tanks used for water ballast --"

4.2.2.2.e to be deleted.

For details see attached document where the text for the requirements in Z10.3 and Z10.4 that DNV will accept is stated.

Best Regards

Arve Myklebust  
on behalf of  
Terje Staalstrom  
DNV IACS Council Member  
<<Doc1.doc>>

\*\*\*\*\*

Neither the confidentiality nor the integrity of this message can be vouched

Annex 2 to TB (Harmonization Z10s)

**WP/SRC Task 114 “Clarify the procedure of verification and signature of the thickness measurement report”**

Item No.	Item	ABS	BV <sup>1)</sup>	CCS	CRS	DNV	GL	IRS	KR	LR	NK	RINA	RS
<b>1</b>	<b>Verification onboard</b>												
1.1	Minimum extent of measuring points for direct verification by attending surveyor specified	No	No	No	No	No	No	No	Yes	No	No	Yes	No
1.2	Preliminary TM record to be signed upon completion of the measurements onboard	Yes	Yes <sup>7)</sup>	Yes	No (copy taken)	No <sup>3)</sup>	No <sup>6)</sup>	Yes	Yes	Yes	Yes	No <sup>8)</sup>	No
<b>2</b>	<b>Final TM report</b>												
2.1	Signature of all pages in TM record required	No	No	No	Yes	No	Yes	Yes	No	No	No <sup>5)</sup>	Yes	Yes
2.2	Signature of ‘cover’ (‘general particulars’) page only	Yes	Yes	Yes	No	Yes	No	No	No <sup>4)</sup>	Yes	Yes	Yes	No
2.3	Measuring points verified by attending surveyor required identified in TM record and signature of the corresponding pages required	No	No	Yes Without signature	Yes	No	No	No	Yes	No	No	No	No

2004-04-20

<sup>1)</sup> Instructions not clear regarding signature of the thickness measurement record

<sup>2)</sup> Signature on front and last page, stamp on all other pages, or signature on each page (IACS TM forms)

<sup>3)</sup> Upon completion of measurements onboard a draft report in electronic format (DNV TM template, including operator’s notes as relevant) to be given to attending surveyor

<sup>4)</sup> Signature of cover page, pages of meeting record and pages of attended measuring points

<sup>5)</sup> Each page to be signed in case of ‘loose-leaf’ type record

<sup>6)</sup> Preliminary TM record has to be passed to the Surveyor, signed by the Operator

<sup>7)</sup> The only measures which the Surveyors can certify exact are those for which that they have seen the results on the screen of the apparatus. That means in fact few points in comparison with the numbers of recorded measures.

<sup>8)</sup> The Surveyor reviews the TM record for completeness and assessment of TM readings, but no signature required.

UR Z7s and Z10s (Corrosion Prevention System)

1. Objective:

To clarify whether the survey of anodes is a class matter, and if so, whether acceptance criteria for anode should be developed.

2. Method: GPG by correspondence (5037\_)

3. Discussion

3.1 BV initiated GPG discussion as follows:

Paris La Défense, 8 Mars 05

1 - We have noticed that, in the draft UR Z's ( 7.1, 10.1 to 10.5) issued further to the WP/SRC Task 102, the original sentence ".....the examination may be limited to a verification that the hard protective coating remains efficient....." has been replaced by ....that the corrosion prevention system remains efficient....". in a number of paragraphs (such as , for instance, Z 7.1, 4.2.3.1 a) ; Z 10.2 4.2.3.3 ; ), in line with IMO Res.A744(18).

2 - However, a corrosion prevention system is defined, in the same UR Z's and in IMO Res.A744(18) , as being either a full hard protective coating or a full hard protective coating supplemented by anodes.

3 - The above would mean that the survey of the anodes is a classification matter.

4 - However, whereas coating conditions are defined as good or fair or poor, there are no criteria in the IACS URs and IMO Res. A744(18) for the anodes condition.

5 - Assessing the anodes condition to confirm that they "remain efficient" looks to BV to be a quite difficult task for the ships in service Surveyor.

6 - Member's view and interpretations on the following would consequently be appreciated:

- do Members consider that the above requirements in IACS URs imply that survey of anodes is part of the classification ?
- do Members consider that the above requirements in IMO Res. A 744 (18) imply that survey of anodes is mandatory?
- if yes, what is the acceptance criteria to conclude that the anodes" remain efficient" ?

3.2 The majority of GPG Members replied that they did not include requirements for anodes in their class rules.

LR / ABS / DNV / KR / NK / RINA / RS were of the view that the condition of any anodes fitted should be recorded for information purposes as the survey of anodes is neither a classification matter nor a mandatory requirement in IMO A.744(18) and has no impact on future surveys (5037\_LRa). [Note; LR further clarified that "Whilst I agree that the performance of anodes is not normally a class matter LR does require that as part of Special Survey on oil tankers : "The attachment to the structure and condition of anodes in tanks are to be examined ." Therefore we cannot say that 'the survey of anodes is not a classification matter'. 5037\_LRb]



However, GL said that “for GL, anodes are a matter of class and as such are subject to plan approval as well as surveys. In case of missing or worn-out anodes we issue a condition of class”(5037\_GLa&b).

CCS advised that its rules have a general requirement relating to anode survey, which is only conducted, through sampling, during construction, docking survey or where there is a definite requirement for the survey of ballast tanks.

NK proposed that the following footnote be added to Z7s and Z10s:  
“The survey of anodes is not a classification matter.” No majority support was achieved.

#### **4. Conclusion**

RINA suggested to simply amend the definition of "Corrosion Prevention System" in paragraph 1.2.9 of UR Z7 (and, of course, the paragraphs in all the other UR Zs containing the definition of "Corrosion Prevention System") in order to eliminate any reference to anodes. This proposal would leave room for Societies willing to include additional class requirements for anodes to do so in their Rules.

GPG agreed.

### **RINA proposed amendments to paragraph 1.2.9 of UR Z7 and corresponding paragraphs in all other UR Zs (5037\_R1b, 6 April 2005)**

#### 1.2.9 Corrosion Prevention System

A corrosion prevention system is normally considered ~~either: a full hard protective coating, or~~  
~~1 a full hard protective coating, or~~  
~~2 a full hard protective coating supplemented by anodes.~~

Hard protective coating is usually to be epoxy coating or equivalent. Other coating systems may be considered acceptable as alternatives provided that they are applied and maintained in compliance with the manufacturer's specifications.

Where soft coatings have been applied, safe access is to be provided for the surveyor to verify the effectiveness of the coating and to carry out an assessment of the conditions of internal structures which may include spot removal of the coating. When safe access cannot be provided, the soft coating is to be removed.

[Annex: Council Chair's conclusive message.](#)

6 May 2005  
Permsec

## **Annex. (5037\_ICb, 15 May 2005)**

To : All IACS Council Members  
c.c : Mr. R. Leslie, IACS Permanent Secretariat

Ref. Mr G-Y. Han's message IAa dated 6 May 05  
Message ICa dated 6 May 05  
Admiral R.E. Kramek's message ABb dated 13 May 05

Paris La Défense, 15 May 05

- 1 - All Members have agreed with the texts attached to Mr Han's message.
- 2 - Further to ABS comments the reference to anodes is to be deleted in Annex I and in tables IX (IV) and IX(II).
- 3 - further to ABS questions regarding what IACS plan to do regarding IMO and A.744(18) further to IACS deletion of reference to anodes from the UR Z7's and UR Z10's it is to be noted that:

The Item 1.2.9 in UR Z10.1 and relative items in these URs states  
*1.2.9 10 Corrosion Prevention System: A corrosion prevention system is normally considered either:*

- .1 a full hard protective coating, or*
- .2 a full hard protective coating supplemented by anodes.*

*Hard Pprotective Ccoating is to usually to be epoxy coating or equivalent. Other coating systems may be considered acceptable as alternatives provided that they are applied and maintained in compliance with the manufacturer's specification.*

*Where Soft Coatings have been applied, safe access is to be provided for the surveyor to verify the effectiveness of the coating and to carry out an assessment of the conditions of internal structures which may include spot removal of the coating. When safe access cannot be provided, the soft coating is to be removed.*

- therefore the anodes are not considered as the main means of protection against the corrosion It is only a supplement;
- there is no provision in UR Z7's and Z10's to evaluate the level efficiency of the anodes;
- there is no specific requirements in case of lack of efficiency of the anodes.

The experience has shown that ballast tanks only protected by anodes are subject to corrosion when the anodes are becoming less efficient.

The anodes are active only when immersed by sea water. Therefore the upper part of the ballast tanks are not protected when the ballast is full of water and the ballast is not protected when it is empty..

The ships operators are reluctant to replace the anodes especially in upper part which request fitting of scaffolding fo welding the anode supports to the structure.

[The above arguments justify the reasons why IACS consider that the anodes are not class item.](#)

[4 - These arguments can be used by IACS Members](#) attending the WG bulk carriers at MSC 80 to try to obtain deletion of the reference to anodes in A. 744(18).

Best regards,

Bernard Anne  
IACS Council Chairman.

**Survey Panel Task 22 – Amend applicable URZ7s and Z10s to align Close-Up Survey and Thickness measurements to be carried out at the same time and location allowing for a more structured control of the thickness measurement process.**

**Technical Background**

**Z7(Rev.12)**

**Z7.1(Rev.3)**

**Z10.1(Rev.13, para.1.4 & 7.1.3)**

**Z10.2(Rev.18, para. 1.4 & 7.1.3)**

**Z10.3(Rev.8, para. 1.4 & 7.1.3)**

**Z10.4(Rev.3, para. 1.4 & 7.1.3)**

**Z10.5(Rev.2, para. 1.4 & 7.1.3)**

**1. Objective**

To amend the applicable URZ7s and Z10s to align Close-Up Survey and Thickness measurements to be carried out at the same time and location allowing for a more structured control of the thickness measurement process.

**2. Background**

IACS QC findings, through audits of numerous Societies, which indicated concerns over Surveyor attendance and control of thickness measurement processes.

**3. Methodology of Work**

Survey Panel members through correspondence.

**4. Discussion**

To align Close-up survey requirements and thickness measurements in the applicable URZ7s and URZ10s, in accordance with PR19, all Panel members agreed through correspondence and a final vote at the fall Survey Panel meeting, that URZ7, Z7.1, Z10.1, Z10.2, Z10.3, Z10.4 and Z10.5 should include in the applicable sections of the noted URs as proposed by the Survey Panel the wording “ In any kind of survey, i.e. special, intermediate, annual, or other surveys having the scope of the foregoing ones, thickness measurements of structures in areas where close-up surveys are required, shall be carried out simultaneously with close-ups surveys.”

**5. Implementation**

The Survey Panel is of the view that the Members need 12 months from the adoption date to implement these amendments into their class rules. Assuming that GPG and Council approve to the amendments, the Survey Panel would propose January 2007 as an implementation date.

## TECHNICAL BACKGROUND

### UR Z7.1 (REV. 4) AND UR Z7 (REV.13)

*SURVEY PANEL TASK 39 – Amend URZ7.1 to align with the requirements of URZ10.2 and URZ10.5 in accordance with SOLAS reg. II-I/23-3 and II-I/25 regarding Water level detectors on single hold cargo ships other than bulk carriers, and to propose to IMO that these requirements be included in relevant sections of IMO resolution A.948(23).*

#### 1. Objective

To amend UR Z7.1 Section 2.6 and 3.3 to include survey requirements related to SOLAS reg. II-I/23-3 and II-I/25 and to propose to IMO that these requirements be included in relevant sections of IMO resolution A.948(23).

#### 2. Background

GPG member from LR requested that URZ7.1 should be amended to meet SOLAS regulations II-I/23-3(entry into force :1 January 2007) and II-I/25 (entry into force: 1 January 2009)

#### 3. Methodology of Work

Survey Panel

#### 4. Discussion

Survey Panel members at the spring 2006 meeting discussed how to address these changes in a similar manner as were carried out in Survey Panel Task 11 for URZ10.2 and Z10.5, for URZ7.1. During the discussion, the member from RINA proposed that URZ7 also be amended to refer to the applicable changes in URZ7.1.

All members agreed and made necessary amendments to URZ7 section 1.1.5 and added note 5 as far as the implementation date.

For URZ7.1 it was agreed that sections 2.6 and 3.3 be added to add these additional requirements.

#### 5. Implementation

The Survey Panel is of the view that the Members need 12 months from the adoption date to implement these amendments into their class rules. Assuming that GPG and Council

approve to the amendments, the Survey Panel would propose July 2007 as an implementation date.

**Submitted by Survey Panel Chair,  
13 July 2006**

**Permanent Secretariat note:**

- Council approved URZ7.1 Rev.4 and URZ7 Rev.13 on 17 August 2006 (5031fICb).
- In addition to the proposed changes a typographical error was corrected in Table 4 of UR Z7.

## **Technical Background**

**URs Z7(Rev.15), Z7.1(Rev.5), Z7.2(Rev.1), Z10.1(Rev.15),  
Z10.2(Rev.26), Z10.3(Rev. 9), Z10.4(Rev.6), Z10.5(Rev.8) – November  
2007**

### ***Survey Panel Task 1 – Annual Review of Implementation of IACS Resolutions***

#### **1. Objective**

To review IACS Resolutions annually and discuss or propose amendments as deemed necessary.

#### **2. Background**

This proposed amendment to all URZ7s and URZ 10s was raised by the Panel member from DNV due to Owners crediting tanks concurrently under intermediate and special survey.

#### **3. Methodology of Work**

Survey Panel members through correspondence.

#### **4. Discussion**

The Panel member from DNV raised the issue of Owners having the ability of crediting spaces and thickness measurements only once in a 54 month interval, due to the availability of concurrent crediting of spaces and thickness measurements due to the flexible time window that is currently allowed between the intermediate survey and the special survey.

After a presentation and discussion lead by the DNV Panel member, all Survey Panel members agreed to the argument given by DNV, and further agreed to make the necessary changes in all URZ7s and URZ10s where Owners are not allowed to concurrently credit surveys and thickness measurements of spaces.

#### **5. Implementation**

The Survey Panel is of the view that the Members need 12 months from the adoption date to implement these amendments into their class rules. Assuming that GPG approve to the amendments, the Survey Panel would propose January 2009 as an implementation date.

Submitted by Survey Panel Chairman  
22 October 2007

**Permanent Secretariat note (December 2007):**

During GPG discussion DNV proposed that *“since this matter will be discussed between Owner and Class mainly in connection with the forthcoming Special Survey, DNV would prefer to locate this text, not only as part of Intermediate Survey, but also as a new text for the Special Survey.”* This was supported by BV, ABS, RINA and KR.

The revised documents were approved, with DNV’s proposal and an implementation date of 1 January 2009, on 15 November 2007 (ref. 7690\_IGb).

## Technical Background

### URs Z7(Rev.16), Z7.1(Rev.6), Z7.2(Rev.2), Z10.1(Rev.16), Z10.2(Rev.27), Z10.3(Rev.11), Z10.4(Rev.7) and Z10.5(Rev.9) - March 2009

#### Survey Panel Task 62:

- A) *Harmonization of UR Z10.1, Z10.2, Z10.4 and Z10.5 with UR Z10.3 with respect to items 5.5.4.4 and 5.6.2.*
- B) *Harmonization of UR Z7, Z7.1, Z10.1, Z10.2, Z10.3, Z10.4 and Z10.5 with UR Z7.2 with respect to the definition of the corrosion prevention system and with respect to the footnote 1 related to semi-hard coatings.*
- C) *Harmonization of the definition of Ballast Tank in UR Z7(Rev.14)*

### 1. Objective

- A) Amend the texts of items 5.5.4.4 and 5.6.2 in Unified Requirements Z10.1, Z10.2, Z10.4 and Z10.5 in order to align them with those in UR Z10.3, in which they were changed while performing Task 55, whereas in the other UR Z10s they were kept unchanged on the grounds that this change was out of the scope of Task 55.
- B) Amend the definition of “Corrosion Prevention System” and include a Footnote 1 related to semi-hard coatings in Unified Requirements Z7, Z7.1, Z10.1, Z10.2, Z10.3, Z10.4 and Z10.5 in order to align them with those adopted in UR Z7.2, when this new UR was issued.
- C) Amend UR Z7 (Rev. 14) in all items where the term “Ballast Tank” is used in order to get them harmonized with the definition itself.

### 2. Background

The task, as regards item A), was triggered by a Member Society, while performing Task 55, on the grounds that this part was out of the scope of the task and then should have been dealt with in a separate task.

The task, as regards item B), was triggered as a consequence of the “New Business action item 2” of the Minutes of the September 2008 Survey Panel meeting, for sake of harmonization of the various URZs.

The task, as regards item C), was triggered as a consequence of the “Task 54-Examination of Double Bottom Ballast Tanks at annual surveys” of the Minutes of March 2008 Survey Panel meeting, for sake of harmonization of the definition of Ballast Tank in UR Z7(Rev.14).

### 3. Discussion

The task was carried out by correspondence. All the amended texts for the affected URs were prepared by the Survey Panel Member who had chaired the PT on Task 55, in accordance with the Form A approved by GPG. In addition to the objectives outlined in the Form A, an amendment was added to item 1.3.1 of UR Z10.2 and UR Z10.5 in which the reference 3.2.3.6 in the last item of the list was replaced by 3.2.3.10 as can be correctly verified in the text.

The amended URs were circulated to all Survey Panel Members for review, comments and agreement. The texts of the URs were unanimously agreed by all Members.



#### **4. Implementation**

The Survey Panel is of the view that the Member Societies need at least 12 months from the adoption date to implement these amendments into their class rules/procedures. Therefore, in the first version of all amended URs the following implementation sentence should be proposed:

*Changes introduced in Rev .xx are to be uniformly applied by Member Societies and Associates for surveys commenced on or after [not less than 12 months after the adoption by GPG/Council].*

Since it is common practice and convenience to have implementation dates either on 1<sup>st</sup> January or on 1<sup>st</sup> July of the year, the Survey Panel proposes the 1<sup>st</sup> July 2010 as implementation date, if GPG/Council approve the URs not later than 30 June 2009.

**Submitted by Survey Panel Chairman  
28 February 2009**

#### **Permanent Secretariat notes (April 2009):**

1. The amended URs were approved by GPG on 18 March 2009 (ref. 7718bIGd).
2. During the typesetting process it was noted that para 5.1.5 of UR 7.2 was inconsistent with the amended URs and so following consultation with the Survey Panel this was also amended at this time.
3. Regarding the implementation date, GPG agreed to use 1<sup>st</sup> July 2010 provided that it was consistently used for the amended URs.

## **Technical Background for UR Z7.1 Rev.7, July 2011**

### **1. Scope and objectives**

Review the requirement for repairs within IACS UR 7 and UR 10 series, in particular the requirement for Prompt and Thorough Repair, with a view to developing wording that would permit a temporary repair and the imposition of a Recommendation/ Condition of Class under specific and controlled circumstances, and in accordance with PR35.

### **2. Engineering background for technical basis and rationale**

There are instances, for example a localised, isolated and very minor hole in a cross-deck strip, at which a suitable temporary repair, for example by welding or doubling, and the imposition of a suitable short term Recommendation/ Condition of Class for permanent repair at a later date, are considered very adequate methodology for dealing with the defect.

Current IACS Requirements in the UR Z7 and Z10 series, for Prompt and Thorough repair, would not permit this to be an option, the defect would have to be permanently Promptly and Thoroughly repaired, which might require removing cargo, moving to a repair berth and staging inner spaces.

Under the Requirements of IACS Procedural Requirement PR 35 the methodology of Temporary Repair and imposition of a suitable short term Recommendation/ Condition of Class for permanent repair at a later date is fully permissible.

### **3. Source/derivation of the proposed IACS Resolution**

Based upon discussion within the IACS Survey Panel.

### **4. Summary of Changes intended for the revised Resolution:**

Following the definition of Prompt and Thorough Repair in the Unified Requirement, a new paragraph is proposed to be added:-

"1.3.3 Where the damage found on structure mentioned in Para. 1.3.1 is isolated and of a localised nature which does not affect the ship's structural integrity, consideration may be given by the surveyor to allow an appropriate temporary repair to restore watertight or weather tight integrity and impose a Recommendation/Condition of Class in accordance with IACS PR 35, with a specific time limit."

### **5. Points of discussions or possible discussions**

a) The points of discussion are as indicated in Sections 2 and 4 above.

b) Discussion took place on whether to prepare this amendment as a Unified Interpretation of IMO Resolution A.744(18)/UR Z7 and Z10 series, finally it was agreed to make direct amendment to the relevant URs.

c) It is proposed that this amendment be submitted directly to the IMO DE/MSC Committees for consideration of amending directly IMO Res. A744(18)

**6. Attachments if any**

None

## Technical Background for UR Z7.1 Rev.8, Oct 2011

### 1. Scope and objectives

Double Skin General Dry Cargo Ships are increasingly common and are of a completely different structural configuration to the conventional single skin General Dry Cargo Ship.

The scope and objective was to review and examine UR Z7.1 with a view to adding Double Skin General Dry Cargo Ships to the list of exempted ship types under Para 1.1.1. on the basis that their double skin configuration afforded significantly enhanced protection to the cargo holds.

### 2. Engineering background for technical basis and rationale

The design of General Dry Cargo Ships has been evolving over the last 20 years. Modern multipurpose general cargo ships are designed around containers configuration, ie with double skin. They are primarily intended to carry other cargoes and only occasionally carry containers. However, because of the double skin configuration the risks associated with carriage of other cargoes are significantly lower than for an older single skin general cargo ship (the side shell and frames are protected from the impact of cargo handling by the double skin).

UR Z7.1 was introduced in June 2002 (as Z10.6) and focussed on traditional General Cargo Ship Construction, with tween-decks and single skin. The drawings (Figs 1 and 2) of Z7.1 indicate this structural configuration.

IMO Resolution MSC 277(85) Para 1.6.1 also makes the distinction that double-skin general dry cargo ships are of significantly different construction from conventional general dry cargo ships.

The Survey Panel is of the view that the traditional risks associated with the single skin configuration of General Cargo Ship are mitigated in the double-skin design, and as such, they should be exempted from the requirements of UR Z7.1, given their strong similarity to Container Ship design.

### 3. Source/derivation of the proposed IACS Resolution

IACS UR Z7.1

### 4. Summary of Changes intended for the revised Resolution:

In IACS UR Z7.1, para 1.1.1, the existing list of ship types exempted from the requirements of UR Z7.1 is to be augmented by the addition of:-

- general dry cargo ships of double side-skin construction, with double side-skin extending for the entire length of the cargo area, and for the entire height of the cargo hold to the upper deck.

### 5. Points of discussions or possible discussions

Discussion was held on the following aspects:-

- a) The extent of double skin required – it was agreed that this would apply only to General Cargo Ships with complete double-skin for the entire length and height of the cargo area.
- b) River-Sea Navigation ships – it was agreed that these ship types did not form a specific sub-type of the General Cargo Ship group and that all General Cargo Ships have some river-sea capability. Pure river navigation general cargo ships were considered outside the remit of IACS.
- c) The carriage of bulk cargoes aboard such ships was considered in view of the propensity for grab and other damages associated with these cargoes, however, general opinion was that the double skin arrangements mitigated this.

**6. Attachments if any**

None

## **Technical Background for UR Z7.1 Rev.10, Jan 2014**

### **1. Scope and objectives**

Consider appropriate text in IACS document regarding class period for lengthy conversions.

### **2. Engineering background for technical basis and rationale**

As per the IMO Res. A1053 (27), lengthy conversions (not necessarily of major character) or other major repair work can be assigned for a 5 year period from the date of completion of conversion/repairs/surveys.

### **3. Source/derivation of the proposed IACS Resolution**

None

### **4. Summary of Changes intended for the revised Resolution**

Following additional text was included to section 2.1.3 to clarify the class period for lengthy conversions

"In cases where the vessel has been laid up or has been out of service for a considerable period because of a major repair or modification and the owner elects to only carry out the overdue surveys, the next period of class will start from the expiry date of the special survey. If the owner elects to carry out the next due special survey, the period of class will start from the survey completion date."

### **5. Points of discussions or possible discussions**

Additional text to Para.2.1.3 was discussed in order to clarify class period.

### **6. Attachments if any**

None

## UR Z7.2 "Hull Surveys for Liquefied Gas Carriers"

### Summary

1. This revision is to harmonize the terms of 'recommendation' and 'condition of class' with only the term 'condition of class' being retained.
2. Additionally, this UR was revised to use the harmonized terms of ballast tanks for their survey requirements.

### Part A. Revision History

Version no.	Approval date	Implementation date when applicable
Rev.8 (May 2019)	30 May 2019	1 July 2020
Rev.7 (Jan 2018)	16 January 2018	1 January 2019
Rev.6 (Feb 2015)	05 February 2015	1 July 2016
Rev.5 (Jan 2014)	14 Jan 2014	1 January 2015
Rev.4 (May 2013)	22 May 2013	1 July 2014
Rev.3 (July 2011)	27 July 2011	1 July 2012
Rev.2 (Mar 2009)	18 March 2009	1 July 2010
Rev.1 (Nov 2007)	15 November 2007	1 January 2009
New (May 2007)	08 May 2007	1 July 2008

#### • Rev. 8 (May 2019)

##### 1 Origin of Change:

- Suggestion by an IACS member

##### 2 Main Reason for Change:

2.1 This revision is to address the policy decision made by GPG using the common terminology 'Condition of Class'(CoC) instead of the terms 'Recommendation/ Condition of Class' based on the outcome of III 5. (PSU19010)

2.2 Additionally, further revision was agreed to use the harmonized terms of ballast tanks for their survey requirements. (PSU18070)

##### 3 List of non-IACS Member classification societies contributing through the TC Forum and/or participating in IACS Working Group:

None

##### 4 History of Decisions Made:

4.1 Harmonization of the terms "Recommendation" and "Condition of Class" (PSU19010)

During the 29th panel meeting, the panel discussed about the comments of members, and concurred with the view to retain the present definitions of CoC in the IACS resolutions with the wording 'Recommendation' to be removed. The panel also agreed to use the term 'Statutory Condition' for the 'recommendation' of the statutory certificates in IACS resolutions and RECs, and when discussing the proposal of a member to consider the harmonization of the terms of 'recommendation' and 'condition of class' in RO Code, the panel unanimously agreed to take no action on the IMO instruments, leaving the relevant actions to be decided by the relevant IMO bodies when IACS feeds back to IMO the IACS action on the harmonization of the two terms.

Panel members concurred with the view that it is not necessary to develop a new procedure requirement, and agreed to set the implementation date of these IACS resolutions (other than RECs) as 1st July 2020.

Before the implementation date of 1st July 2020 for using the common terminology 'Condition of Class' only, 'Recommendations' and 'Condition of Class' are to be read as being different terms used by Societies for the same thing, i.e. requirements to the effect that specific measures, repairs, surveys etc. are to be carried out within a specific time limit in order to retain Classification.

4.2 Additional revision to use the harmonized terms of ballast tanks for their survey requirements (PSU18070)

Upon the discussions within Survey Panel under task No. PSU18070, the following changes were decided to be made to UR Z7, Z7.1 and Z7.2:

1. To use "ballast tanks" in lieu of "ballast spaces", "water ballast tanks", "tanks used for water ballast" or "spaces used for water ballast"; and
2. To use "double bottom ballast tanks" in lieu of "water ballast double bottom tanks".

Furthermore, Definition "Ballast tank" in UR Z7.2-para.1.2.1 was agreed to be revised in consistence with UR Z7- para. 1.2.1.

No TB is expected for the present revision.

## **5 Other Resolutions Changes:**

The following IACS resolutions and Recommendations (RECs) were agreed to be revised: (PSU19010)

- Procedural Requirements: PR1A, PR1B, PR1C, PR1D, PR1 Annex, PR3, PR12, PR20, PR35 and the attachment of PR16;
- Unified Requirements: Z7, Z7.1, Z7.2, Z10.1, Z10.2, Z10.3, Z10.4, Z10.5, Z15 and Z20
- Unified Interpretations: GC13
- Recommendations: Rec.41, Rec.96, Rec.98

URs Z7 and Z7.1 (PSU18070)

## **6 Any hinderance to MASS, including any other new technologies:**

None.



**7 Dates:**

Original Proposal: 14 January 2019 tasked by GPG (17044bIGm) (PSU19010)

19 December 2018 Made by: a Survey Panel member (PSU18070)

Panel Approval: 22 March 2019 (PSU19010)

3 May 2019 (PSU18070)

GPG Approval: 30 May 2019 (Ref: 17044bIGu)

• **Rev.7 (Jan 2018)**

**.1 Origin of Change:**

- Suggestion by IACS members

**.2 Main Reasons for Change:**

To address the FUA 11 of C73, raised by the Council of the IACS in respect to the future work directions on the implications of new technology on survey regime. A revision of UR Z7.2 is in order to consider the new technologies on Remote Inspections (RIT).

**.3 List of non-IACS Member Classification Societies contributing through the TC Forum and/or participating in IACS Working Group:**

None

**.4 History of Decisions Made:**

Members discussed under Panel task PSU 16056 the issue allocated by GPG on 21th October 2016. The subject deals with the review of the UR and Recommendation under Panel responsibility in order to determine whether a revision could need in order to consider the new technologies on Remote Inspections (RIT). The Panel Members concurred to discuss the possible revision of the UR Z7.2 in order to address the issue.

Panel agreed the revised paragraph 1.4, 1.5 and 5.2.3. In addition, a new paragraph 1.2.14 with definition of RIT was agreed and inserted in the present revision of UR Z7.2.

No TB is expected for the present revision.

**.5 Other Resolutions Changes**

UR Z7, UR Z7.1, UR Z10.3

**.6 Dates:**

Original Proposal: 21 October 2016 assigned by GPG

Panel Approval: 08 December 2017 by Survey Panel (Ref: PSU16056)

GPG Approval: 16 January 2018 (Ref: 16151\_IGq)

- **Rev.6 (Feb 2015)**

**.1 Origin of Change:**

- Suggestion by an IACS member

**.2 Main Reasons for Change:**

Consider appropriate text in IACS document regarding the applicability of the Thickness Measurements when the Close up survey is performed.

**.3 List of non-IACS Member classification societies contributing through the TC Forum and/or participating in IACS Working Group:**

None

**.4 History of Decisions Made:**

Following an ACB query an IACS member proposed to add suitable text in appropriate IACS documents regarding the application of the Thickness Measurements when the close up surveys are performed as survey requirement due at the Intermediate/Renewal Class surveys. This Member expressed the view that the requirements to execute the Thickness Measurements of the area subject to Close Up Surveys are expected into the table relevant to "MINIMUM REQUIREMENTS FOR THICKNESS MEASUREMENTS AT SPECIAL SURVEY ....." while the paragraph 1.4 of the document contains only the requirement that "Thickness Measurements of the areas subject to close up surveys shall be taken in conjunction with the close up survey".

Panel discussed and considered that wordings of Para 1.4 of current UR Z7s/10s need to be revised in order to clarify this issue; finally Panel agreed to add additional wording to Para.1.4.

**.5 Other Resolutions Changes**

The identical amendment affects UR Z7, UR Z7.1, UR Z10.1, UR Z10.2, UR Z10.3, UR Z10.4 and UR Z 10.5.

**.6 Dates:**

Panel Approval: At 19th Survey Panel Meeting (6 March 2014)  
GPG Approval: 05 February 2015 (Ref: 14193\_IGc)

- **Rev.5 (Jan 2014)**

**.1 Origin of Change:**

- Suggestion by an IACS member

**.2 Main Reason for Change:**

Consider appropriate text in IACS document regarding class period for lengthy conversions.

**.3 List of non-IACS Member classification societies contributing through the TC Forum and/or participating in IACS Working Group:**

None

**.4 History of Decisions Made:**

With reference to IMO Res. A1053(27) (5.5 Application of "special circumstances") an IACS member proposed to add suitable text in appropriate IACS document regarding class period for lengthy conversions. This Member expressed that when a renewal survey has been completed, the new 5 year class period would normally be calculated from the expiry of previous class period/class certificate and in some cases this might result in unreasonably short time from one renewal survey completion until the next renewal would be due.

Panel discussed the matter under item PSU13051 and considered that wordings of Para 2.13 of current UR Z7s/10s (second sentence) could address this issue but finally agreed to add additional text to Para.2.1.3 in order to clarify this matter.

**.5 Other Resolutions Changes**

The identical amendment affects UR Z7, UR Z7.1, UR Z10.1, UR Z10.2, UR Z10.3, UR Z10.4 and UR Z 10.5.

**.6 Dates:**

Original Proposal: At 18th Survey Panel Meeting (5 September 2013)  
GPG Approval: 14 January 2014 (Ref: 12011aIGd)

**• Rev.4 (May 2013)**

**.1 Origin of Change:**

Suggestion by an IACS member

**.2 Main Reason for Change:**

A Member suggested clarifying the paragraph 6.2.1 of UR Z7.2 regarding the approval of thickness measurement firms in respect of thickness measurements of ships less than 500 gross tonnage (PSU 13005).

**.3 List of non-IACS Member classification societies contributing through the TC Forum and/or participating in IACS Working Group:**

None

**.4 History of Decisions Made:**

This matter was discussed by correspondence within the Survey Panel and at the Survey Panel meeting. Members expressed that clarification is not necessary since UR Z17 has been referenced which states firms carrying out thickness measurements on non-ESP vessels under 500 GT do not require certification. However the member who proposed to discuss this issue referred that other UR 7s and 10s are synchronized with UR Z17 for propelled ships of "...of 500gt and above...." and only UR Z7.2 needs some clarification.

Panel during 17<sup>th</sup> Panel agreed to clarify the paragraph 6.2.1 of UR Z7.2.

**.5 Other Resolutions Changes**

None

**.6 Dates:**

Original Proposal: 4 February 2013 Made by a Member  
 Panel Approval: 7 March 2013 during 17<sup>th</sup> Survey Panel meeting  
 GPG Approval: 22 May 2013 (Ref: 9640\_IGn)

- **Rev.3 (July 2011)**

**.1 Origin of Change:**

Suggestion by an IACS member

**.2 Main Reason for Change:**

Following external audit a member was advised that a small temporary doubler on a cross-deck strip of a bulk carrier should have been promptly and thoroughly repaired at the time of survey. The member carried out an investigation and found that the actions of the surveyor were fully justifiable, the temporary repair and short term Condition of Class imposed were an appropriate method of dealing with such a situation. The member advised that the current requirements for 'Prompt and Thorough Repair' stipulated under the UR 7 and UR 10 series do not give any leeway for carrying out temporary repairs (and imposing a Recommendation/Condition of Class in accordance PR 35) where the damage in question is isolated and localised, and in which the ship's structural integrity is not impaired.

The Survey Panel discussed the matter and agreed that under carefully defined circumstances a temporary repair and short term Recommendation/Condition of Class would be an appropriate course of action.

**.3 List of non-IACS Member classification societies contributing through the TC Forum and/or participating in IACS Working Group:**

None

#### **.4 History of Decisions Made:**

The matter was discussed by correspondence within the Survey Panel and at the Autumn 2010 Panel Meeting. Following discussion at which the possibility of a Unified Interpretation being raised was considered, it was eventually decided to make direct amendment to the relevant Unified Requirements.

The wording of the new paragraph to be inserted as Para 1.3.3 in all relevant Unified Requirements was extensively discussed prior to agreement.

The proposal was unanimously agreed by Survey Panel Members.

#### **.5 Other Resolutions Changes**

The identical amendment affects UR Z7, UR Z7.1, UR Z7.2, UR Z10.1, UR Z10.2, UR Z10.3, UR Z10.4 and UR Z 10.5.

#### **.6 Dates:**

Original Proposal: *September 2010 Made by a Member*

Panel Approval: *March 2011*

GPG Approval: *27 July 2011 (Ref: 11118\_IGb)*

- **Rev.2 (March 2009)**

Survey Panel Task 62 - Harmonization of UR Z10s to UR Z10.3(Rev.10) – GPG Subject No: 7718b

See TB document in Part B.

- **Rev.1 (Nov 2007)**

Survey Panel Task 1 – Concurrent crediting of tanks- GPG Subject No: 7690

See TB document in Part B.

- **New (May 2007)**

GPG Subject No: 5031h

Survey Panel Task 9 - develop survey requirements for gas tanker ballast spaces

See TB document in Part B.

## Part B. Technical Background

List of Technical Background (TB) documents for UR Z7.2:

Annex 1. **TB for New (May 2007)**

See separate TB document in Annex 1.



Annex 2. **TB for Rev.1 (Nov 2007)**

See separate TB document in Annex 2.



Annex 3. **TB for Rev.2 (Mar 2009)**

See separate TB document in Annex 3.



Annex 4. **TB for Rev.3 (July 2011)**

See separate TB document in Annex 4.



Annex 5. **TB for Rev.5 (Jan 2014)**

See separate TB document in Annex 5.



*Note: There is no separate Technical Background (TB) document available for Rev.4 (May 2013), Rev.6(Feb 2015), Rev.7 (Jan 2018) and Rev.8 (May 2019).*

## Technical Background Document

### UR Z7.2 (NEW May 2007)

*(Survey Panel Task 9 – Develop survey requirements for Gas Tanker Ballast Spaces)*

#### **1. Objective:**

Develop survey requirements for ballast spaces of gas tankers.

#### **2. Background**

DNV requested at WP/SRC Annual meeting October 2004 to develop survey requirements for ballast spaces of gas tankers.

#### **3. Discussion**

The task has been carried out by a Project Team chaired by DNV Survey Panel member and with Survey Panel members from BV, LR, NK and RINA.

The Project Team drafted a new Unified Requirement UR Z7.2 « Hull Surveys for Liquefied Gas Carriers » applicable to surveys of hull structure and piping systems, except piping covered by Z16, in way of pump rooms, compressor rooms, cofferdams, pipe tunnels, void spaces and fuel oil tanks within the cargo area and all ballast tanks.

The requirements are additional to the classification requirements applicable to the remainder of the ship, for which Z7 is to be referred.

Z16 is to be referred to for periodical surveys of cargo installations on ships carrying liquefied gases in bulk.

The draft UR Z 7.2 was presented to the Survey Panel members on the 13th-15th September 2006 meeting at ABS Headquarters in Houston and was agreed upon in principle by the Panel members.

Further comments by members were considered by the Project Team which proposed an updated version of the UR Z7.2 including some optional items. This version was submitted to the Panel for final decisions at the Spring meeting in February 2007.

#### **4. Implementation**

The Survey Panel is of the view that the Members need 12 months from the adoption date to implement these amendments into their class rules/procedures. Assuming that GPG and Council approve the amendments during the first half of 2007, the Survey Panel would propose **July 2008** as implementation date.

**Submitted by Survey Panel Chairman  
18 April 2007**

#### **Permsec note (June 2007):**

New UR Z7.2 adopted by GPG 8 May 2007 (5031hIGi) with an implementation date of 1 July 2008.

## **Technical Background**

**URs Z7(Rev.15), Z7.1(Rev.5), Z7.2(Rev.1), Z10.1(Rev.15),  
Z10.2(Rev.26), Z10.3(Rev. 9), Z10.4(Rev.6), Z10.5(Rev.8) – November  
2007**

### ***Survey Panel Task 1 – Annual Review of Implementation of IACS Resolutions***

#### **1. Objective**

To review IACS Resolutions annually and discuss or propose amendments as deemed necessary.

#### **2. Background**

This proposed amendment to all URZ7s and URZ 10s was raised by the Panel member from DNV due to Owners crediting tanks concurrently under intermediate and special survey.

#### **3. Methodology of Work**

Survey Panel members through correspondence.

#### **4. Discussion**

The Panel member from DNV raised the issue of Owners having the ability of crediting spaces and thickness measurements only once in a 54 month interval, due to the availability of concurrent crediting of spaces and thickness measurements due to the flexible time window that is currently allowed between the intermediate survey and the special survey.

After a presentation and discussion lead by the DNV Panel member, all Survey Panel members agreed to the argument given by DNV, and further agreed to make the necessary changes in all URZ7s and URZ10s where Owners are not allowed to concurrently credit surveys and thickness measurements of spaces.

#### **5. Implementation**

The Survey Panel is of the view that the Members need 12 months from the adoption date to implement these amendments into their class rules. Assuming that GPG approve to the amendments, the Survey Panel would propose January 2009 as an implementation date.

Submitted by Survey Panel Chairman  
22 October 2007



**Permanent Secretariat note (December 2007):**

During GPG discussion DNV proposed that *“since this matter will be discussed between Owner and Class mainly in connection with the forthcoming Special Survey, DNV would prefer to locate this text, not only as part of Intermediate Survey, but also as a new text for the Special Survey.”* This was supported by BV, ABS, RINA and KR.

The revised documents were approved, with DNV’s proposal and an implementation date of 1 January 2009, on 15 November 2007 (ref. 7690\_IGb).

## Technical Background

### URs Z7(Rev.16), Z7.1(Rev.6), Z7.2(Rev.2), Z10.1(Rev.16), Z10.2(Rev.27), Z10.3(Rev.11), Z10.4(Rev.7) and Z10.5(Rev.9) - March 2009

#### Survey Panel Task 62:

- A) *Harmonization of UR Z10.1, Z10.2, Z10.4 and Z10.5 with UR Z10.3 with respect to items 5.5.4.4 and 5.6.2.*
- B) *Harmonization of UR Z7, Z7.1, Z10.1, Z10.2, Z10.3, Z10.4 and Z10.5 with UR Z7.2 with respect to the definition of the corrosion prevention system and with respect to the footnote 1 related to semi-hard coatings.*
- C) *Harmonization of the definition of Ballast Tank in UR Z7(Rev.14)*

### 1. Objective

- A) Amend the texts of items 5.5.4.4 and 5.6.2 in Unified Requirements Z10.1, Z10.2, Z10.4 and Z10.5 in order to align them with those in UR Z10.3, in which they were changed while performing Task 55, whereas in the other UR Z10s they were kept unchanged on the grounds that this change was out of the scope of Task 55.
- B) Amend the definition of “Corrosion Prevention System” and include a Footnote 1 related to semi-hard coatings in Unified Requirements Z7, Z7.1, Z10.1, Z10.2, Z10.3, Z10.4 and Z10.5 in order to align them with those adopted in UR Z7.2, when this new UR was issued.
- C) Amend UR Z7 (Rev. 14) in all items where the term “Ballast Tank” is used in order to get them harmonized with the definition itself.

### 2. Background

The task, as regards item A), was triggered by a Member Society, while performing Task 55, on the grounds that this part was out of the scope of the task and then should have been dealt with in a separate task.

The task, as regards item B), was triggered as a consequence of the “New Business action item 2” of the Minutes of the September 2008 Survey Panel meeting, for sake of harmonization of the various URZs.

The task, as regards item C), was triggered as a consequence of the “Task 54-Examination of Double Bottom Ballast Tanks at annual surveys” of the Minutes of March 2008 Survey Panel meeting, for sake of harmonization of the definition of Ballast Tank in UR Z7(Rev.14).

### 3. Discussion

The task was carried out by correspondence. All the amended texts for the affected URs were prepared by the Survey Panel Member who had chaired the PT on Task 55, in accordance with the Form A approved by GPG. In addition to the objectives outlined in the Form A, an amendment was added to item 1.3.1 of UR Z10.2 and UR Z10.5 in which the reference 3.2.3.6 in the last item of the list was replaced by 3.2.3.10 as can be correctly verified in the text.

The amended URs were circulated to all Survey Panel Members for review, comments and agreement. The texts of the URs were unanimously agreed by all Members.

#### **4. Implementation**

The Survey Panel is of the view that the Member Societies need at least 12 months from the adoption date to implement these amendments into their class rules/procedures. Therefore, in the first version of all amended URs the following implementation sentence should be proposed:

*Changes introduced in Rev .xx are to be uniformly applied by Member Societies and Associates for surveys commenced on or after [not less than 12 months after the adoption by GPG/Council].*

Since it is common practice and convenience to have implementation dates either on 1<sup>st</sup> January or on 1<sup>st</sup> July of the year, the Survey Panel proposes the 1<sup>st</sup> July 2010 as implementation date, if GPG/Council approve the URs not later than 30 June 2009.

**Submitted by Survey Panel Chairman  
28 February 2009**

#### **Permanent Secretariat notes (April 2009):**

1. The amended URs were approved by GPG on 18 March 2009 (ref. 7718bIGd).
2. During the typesetting process it was noted that para 5.1.5 of UR 7.2 was inconsistent with the amended URs and so following consultation with the Survey Panel this was also amended at this time.
3. Regarding the implementation date, GPG agreed to use 1<sup>st</sup> July 2010 provided that it was consistently used for the amended URs.

## **Technical Background for UR Z7.2 Rev.3, July 2011**

### **1. Scope and objectives**

Review the requirement for repairs within IACS UR 7 and UR 10 series, in particular the requirement for Prompt and Thorough Repair, with a view to developing wording that would permit a temporary repair and the imposition of a Recommendation/ Condition of Class under specific and controlled circumstances, and in accordance with PR35.

### **2. Engineering background for technical basis and rationale**

There are instances, for example a localised, isolated and very minor hole in a cross-deck strip, at which a suitable temporary repair, for example by welding or doubling, and the imposition of a suitable short term Recommendation/ Condition of Class for permanent repair at a later date, are considered very adequate methodology for dealing with the defect.

Current IACS Requirements in the UR Z7 and Z10 series, for Prompt and Thorough repair, would not permit this to be an option, the defect would have to be permanently Promptly and Thoroughly repaired, which might require removing cargo, moving to a repair berth and staging inner spaces.

Under the Requirements of IACS Procedural Requirement PR 35 the methodology of Temporary Repair and imposition of a suitable short term Recommendation/ Condition of Class for permanent repair at a later date is fully permissible.

### **3. Source/derivation of the proposed IACS Resolution**

Based upon discussion within the IACS Survey Panel.

### **4. Summary of Changes intended for the revised Resolution:**

Following the definition of Prompt and Thorough Repair in the Unified Requirement, a new paragraph is proposed to be added:-

"1.3.3 Where the damage found on structure mentioned in Para. 1.3.1 is isolated and of a localised nature which does not affect the ship's structural integrity, consideration may be given by the surveyor to allow an appropriate temporary repair to restore watertight or weather tight integrity and impose a Recommendation/Condition of Class in accordance with IACS PR 35, with a specific time limit."

### **5. Points of discussions or possible discussions**

a) The points of discussion are as indicated in Sections 2 and 4 above.

b) Discussion took place on whether to prepare this amendment as a Unified Interpretation of IMO Resolution A.744(18)/UR Z7 and Z10 series, finally it was agreed to make direct amendment to the relevant URs.

c) It is proposed that this amendment be submitted directly to the IMO DE/MSC Committees for consideration of amending directly IMO Res. A744(18)

**6. Attachments if any**

None

## **Technical Background for UR Z7.2 Rev.5, Jan 2014**

### **1. Scope and objectives**

Consider appropriate text in IACS document regarding class period for lengthy conversions.

### **2. Engineering background for technical basis and rationale**

As per the IMO Res. A1053 (27), lengthy conversions (not necessarily of major character) or other major repair work can be assigned for a 5 year period from the date of completion of conversion/repairs/surveys.

### **3. Source/derivation of the proposed IACS Resolution**

None

### **4. Summary of Changes intended for the revised Resolution**

Following additional text was included to section 2.1.3 to clarify the class period for lengthy conversions

“In cases where the vessel has been laid up or has been out of service for a considerable period because of a major repair or modification and the owner elects to only carry out the overdue surveys, the next period of class will start from the expiry date of the special survey. If the owner elects to carry out the next due special survey, the period of class will start from the survey completion date.”

### **5. Points of discussions or possible discussions**

Additional text to Para.2.1.3 was discussed in order to clarify class period.

### **6. Attachments if any**

None

## UR Z10.1 "Hull Surveys of Oil Tankers"

### Summary

This revision is to harmonize the revised requirements in line with the amendments made to ESP Code vide Res.MSC.525(106)

### Part A. Revision History

Version no.	Approval date	Implementation date when applicable
Rev.25 (Feb 2023)	08 February 2023	1 July 2024
Rev.24 (May 2018)	30 May 2019	1 July 2020
Rev.23 (Jan 2018)	15 January 2017	1 January 2019
Rev.22 (Feb 2015)	05 February 2015	1 July 2016
Rev.21 (Jan 2014)	14 January 2014	1 January 2015
Rev.20 (May 2013)	22 May 2013	1 July 2014
Rev.19 (Jul 2011)	27 July 2011	1 July 2012
Rev.18 (Mar 2011)	24 March 2011	1 July 2012
Rev.17 (Feb 2010)	17 February 2010	
Rev.16 (Mar 2009)	18 March 2009	1 July 2010
Rev.15 (Nov 2007)	15 November 2007	1 January 2009
Rev.14 (Feb 2007)	10 February 2007	1 January 2007 / 1 January 2008 * <sup>1</sup>
Corr.1 (Sept 2006)	14 September 2006	
Rev.13 (Jan 2006)	4 January 2006	1 January 2007
Rev.12 (Jun 2005)	27 June 2005	1 July 2006
Rev.11 (Aug 2003)	8 August 2003	
Rev.10 (Oct 2002)	22 November 2002	
Rev.9 (Mar 2002)	19 March 2002	1 July 2002 / 1 year after Council adoption * <sup>2</sup>
Rev.8.1 (Jun 2001)	22 June 2001	1 July 2001
Rev.8 (Nov 2000)	20 November 2000	1 July 2001
Rev.7 (Sept 2000)	14 September 2000	1 July 2001
Rev.6.1 (Dec 1999)	30 November 1999	1 July 2000
Rev.6 (Jul 1999)	16 July 1999	1 September 1999
Rev.5 (1997)	10 December 1997	
Rev.4 (1996)	No record	1 January 1997
Rev.3 (1995)	No record	
Rev.2 (1994)	No record	
Rev.1 (1994)	No record	
NEW (1992)	No record	

**\* Notes:**

1. Changes introduced in Rev.14 are to be uniformly implemented for surveys commenced on or after 1 January 2008, whereas statutory requirements of IMO Res. MSC 197(80) apply on 1 January 2007.

2. *Changes introduced in Rev.9 to UR Z10.1, which come from Res. MSC.105(73) and MSC.108(73) are to be applied by all Member Societies and Associates from 1 July 2002.*

*Changes introduced in Rev.9 to UR Z10.1, other than the above, are to be implemented by all Member Societies and Associates within one year of the adoption by Council.*

- **Rev.25 (Feb 2023)**

**.1 Origin of Change:**

- o Suggestion by an IACS member
- o Based on IMO Regulation

**.2 Main Reason for Change:**

To revise the definition of Oil Tanker to exclude ships carrying oil in independent tanks not part of the ship's hull such as asphalt carriers in line with the amendments made to ESP Code vide Res.MSC.525(106).

To revise the definition of Ballast tank from use of 'solely' carriage of salt water to 'primarily' use in line with other IACS URs and ESP Code.

To refine the wording of tank testing requirements in line with the amendments made to ESP Code vide Res.MSC.525(106).

To refine the wording of ballast tanks examination requirements at annual surveys in line with the amendments made to ESP Code vide Res.MSC.525(106).

To delete a reference, IACS UR Z10.1, in line with other IACS URs and the amendments made to ESP Code vide Res.MSC.525(106).

**.3 List of non-IACS Member classification societies contributing and/or participating in IACS Working Group:**

None

**.4 History of Decisions Made:**

- One survey panel member raised a question whether oil tankers having independent tanks like asphalt carriers are applicable to the ESP Code because the current definition of oil tankers includes those tankers. Survey panel unanimously agreed to the view that those ships carrying oil in independent tanks not part of the ship's hull such as asphalt carriers are not subject to the ESP Code and decided to modify the definition in UR 10s and the ESP Code. It was accepted in SDC8 and published as Res.MSC.525(106). (PSU19047)



- One survey panel member pointed out the definition of ballast tank in UR 10s are different from other URs like UR7/7.1/7.2 and the ESP Code, so panel decided to modify the wording 'solely' to 'primarily'. (PSU20004)

- One survey panel member proposed to accept tank testing carried out by crew under the direction of the Master like oil tankers and decided to insert the requirements for oil tankers after minor modification of wording. However, at SDC8, the proposal for bulk carriers was rejected but the minor modification of wording for oil tankers was accepted. Survey panel considered to resubmit this issue to next SDC but decided not to do because it was disagreed by Ship owners/operators associations like INTERCARGO and ICS. (PSU17030/17039)

- One survey panel member suggested to refine the wording 'extended annual/intermediate survey' to 'examination of ballast tanks at annual surveys' in Executive Hull Summary and panel decided to modify it in the ESP Code first. It was submitted to SDC8 and included in Res.MSC.525(106). (PSU18056)

- One survey panel member pointed out that the references in UR Z10s need to be deleted to be in line with other UR Z10s. And panel decided to delete the reference of itself in UR Z10.1 in line with the amendments made to ESP Code vide Res.MSC.525(106). (PSU19057)

No TB is expected for the present revision.

#### **.5 Other Resolutions Changes:**

Unified Requirements: Z10.2, Z10.4 and Z10.5

#### **.6 Any hinderance to MASS, including any other new technologies:**

None

#### **.7 Dates:**

Original Proposal:	19 September 2019	(PSU19047)
	28 January 2020	(PSU20004)
	19 September 2017	(PSU17030)
	17 November 2017	(PSU17039)
	24 October 2017	(PSU18056)
	18 December 2019	(PSU19057)
Panel Approval:	12 October 2021	(PSU21026_ISUf)
GPG Approval:	08 February 2023	(22198_IGd)

- **Rev.24 (May 2019)**

- .1 Origin of Change:**

- o Suggestion by an IACS member

- .2 Main Reason for Change:**

This revision is to address the policy decision made by GPG using the common terminology 'Condition of Class'(CoC) instead of the terms 'Recommendation/ Condition of Class' based on the outcome of III 5.

- .3 List of non-IACS Member classification societies contributing through the TC Forum and/or participating in IACS Working Group:**

None

- .4 History of Decisions Made:**

During the 29th panel meeting, the panel discussed about the comments of members, and concurred with the view to retain the present definitions of CoC in the IACS resolutions with the wording 'Recommendation' to be removed. The panel also agreed to use the term 'Statutory Condition' for the 'recommendation' of the statutory certificates in IACS resolutions and RECs, and when discussing the proposal of a member to consider the harmonization of the terms of 'recommendation' and 'condition of class' in RO Code, the panel unanimously agreed to take no action on the IMO instruments, leaving the relevant actions to be decided by the relevant IMO bodies when IACS feeds back to IMO the IACS action on the harmonization of the two terms.

Panel members concurred with the view that it is not necessary to develop a new procedure requirement, and agreed to set the implementation date of these IACS resolutions (other than RECs) as 1st July 2020.

Before the implementation date of 1st July 2020 for using the common terminology 'Condition of Class' only, 'Recommendations' and 'Condition of Class' are to be read as being different terms used by Societies for the same thing, i.e. requirements to the effect that specific measures, repairs, surveys etc. are to be carried out within a specific time limit in order to retain Classification.

No TB is expected for the present revision.

- .5 Other Resolutions Changes:**

The following IACS resolutions and Recommendations (RECs) were agreed to be revised:

- Procedural Requirements: PR1A, PR1B, PR1C, PR1D, PR1 Annex, PR3, PR12, PR20, PR35 and the attachment of PR16;
- Unified Requirements: Z7, Z7.1, Z7.2, Z10.1, Z10.2, Z10.3, Z10.4, Z10.5, Z15 and Z20
- Unified Interpretations: GC13
- Recommendations: Rec.41, Rec.75, Rec.96, Rec.98

**.6 Any hinderance to MASS, including any other new technologies:**

None

**.7 Dates:**

Original Proposal: 14 January 2019 tasked by GPG (17044bIGm)

Panel Approval: 22 March 2019 (PSU19010)

GPG Approval: 30 May 2019 (17044bIGu)

**• Rev.23 (Jan 2018)**

**.1 Origin of Change:**

- Suggestion by IACS members

**.2 Main Reason for Change:**

In order to introduce new provisions into the ESP Code which were found among the ESP Code and relevant UR Z10s, a series of items of UR Z10s shall be amended accordingly with ESP Code.

**.3 List of non-IACS Member Classification Societies contributing through the TC Forum and/or participating in IACS Working Group:**

None

**.4 History of Decisions Made:**

Panel members discussed this issue under PSU17018: "Thickness measurement company" was replaced with "Thickness measurement firm" throughout the UR; some paragraphs were to be revised for consisting with ESP Code; etc.

During the 26<sup>th</sup> Survey Panel Meeting, the Panel discussed the divergence and reached the agreements with the revisions.

No TB is expected for the present revision.

**.5 Other Resolutions Changes**

UR Z10.2, UR Z10.3, UR Z10.4, UR Z10.5

**.6 Dates:**

Original Proposal: 22 October 2016 by a Survey Panel Member

Panel Approval: 24 December 2017 by Survey Panel (Ref: PSU17018)

GPG Approval: 15 January 2018 (Ref: 17189\_IGc)

- **Rev.22 (Feb 2015)**

**.1 Origin of Change:**

- Suggestion by an IACS member

**.2 Main Reasons for Change:**

- a) To consider appropriate text in IACS document regarding the applicability of the Thickness Measurements when the Close up survey is performed.
- b) To specify the minimum content of the Tank Testing guideline cited at paragraph 2.5.1.bullet a).

**.3 List of non-IACS Member classification societies contributing through the TC Forum and/or participating in IACS Working Group:**

None

**.4 History of Decisions Made:**

- a) Following an ACB query an IACS member proposed to add suitable text in appropriate IACS documents regarding the application of the Thickness Measurements when the close up surveys are performed as survey requirement due at the Intermediate/ Renewal Class surveys. This Member expressed the view that the requirements to execute the Thickness Measurements of the area subject to Close Up Surveys are expected into the table relevant to "MINIMUM REQUIREMENTS FOR THICKNESS MEASUREMENTS AT SPECIAL SURVEY ....." while the paragraph 1.4 of the document contains only the requirement that "Thickness Measurements of the areas subject to close up surveys shall be taken in conjunction with the close up survey".

Panel discussed the matter under item PSU13051 and considered that wordings of Para 1.4 of current UR Z7s/10s need to be revised in order to clarify this issue; finally Panel agreed to add additional wording to Para.1.4.

- b) An IACS Member following the discussion of PSU 14017 (relevant to the drafting of a Guidelines for Master tank testing) proposed to improve the content of the bullet a) of paragraph 2.5.1 of the UR by inserting the description of the minimum requirements that need to be specified inside the "Cargo Tank Testing Procedure" to be used when Master of a Tanker is allowed to perform the cargo tank testing. Panel concurred with the proposal (ref, message PSU14017...ISUc), the sentence has been modified as follow  
"a tank testing procedure, specifying fill heights, tanks being filled and bulkheads being tested, has been submitted by the owner and reviewed by the Society prior to the testing being carried out";

**.5 Other Resolutions Changes**

- i) The identical amendment affects UR Z7, UR Z7.1, UR Z7.2, UR Z10.2, UR Z10.3, UR Z10.4 and UR Z 10.5.
- ii) The amendment b) affects also UR Z10.3, UR Z10.4.

## **.6 Dates:**

Panel Approval: Amendment a) at 19th Survey Panel Meeting (6 March 2014)  
Amendment B) on 29 July 2014 by correspondence under PSU14017.

GPG Approval: 05 February 2015 (Ref: 14193\_IGc)

## **• Rev.21 (Jan 2014)**

### **.1 Origin of Change:**

- Suggestion by IACS members
- Suggestion by GPG

### **.2 Main Reason for Change:**

- a) To consider appropriate text in IACS document regarding class period for lengthy conversions.
- b) To align the difference between PR37 and URZ's regarding safe entry to confined spaces.

### **.3 List of non-IACS Member classification societies contributing through the TC Forum and/or participating in IACS Working Group:**

None

### **.4 History of Decisions Made:**

- a) With reference to IMO Res. A1053 (27) (5.5 Application of "special circumstances") an IACS member proposed to add suitable text in appropriate IACS document regarding class period for lengthy conversions. This Member expressed that when a renewal survey has been completed, the new 5 year class period would normally be calculated from the expiry of previous class period/class certificate and in some cases this might result in unreasonably short time from one renewal survey completion until the next renewal would be due.

Panel discussed and considered that wordings of Para 2.1.3 of current UR Z7s/10s (second sentence) could address this issue but finally agreed to add additional text to Para 2.1.3 in order to clarify this matter. (PSU13024)

- b) Panel discussed to clarify the survey requirements in PR37 and URZ's regarding safe entry to confined spaces. Panel considered that the safety issues of surveyor should be dealt by PR37. At 18<sup>th</sup> Panel meeting, Panel concluded to delete requirements from UR Z10s which were already covered by the PR37. (PSU13032)

### **.5 Other Resolutions Changes**

- a) The identical amendment affects UR Z7, UR Z7.1, UR Z7.2, UR Z10.2, UR Z10.3, UR Z10.4 and UR Z 10.5.

b) The identical amendment affects UR Z10.2, UR Z10.3, UR Z10.4 and UR Z 10.5.

**.6 Dates:**

Panel Approval: 7 November 2013 by Survey Panel

GPG Approval: 14 January 2014 (Ref: 12011aIGd)

• **Rev.20 (May 2013)**

**.1 Origin of Change:**

- Suggestion by IACS members
- Suggestion by GPG in response to the request of EG/SoS

**.2 Main Reason for Change:**

- a) To establish a consistent practice among Members through amendments to the requirements related to pressure testing of cargo tanks with the correct level of safety for accepting Master's statement that the pressure testing has been carried out according to requirements. (PSU 9014, GPG 9640)
- b) To introduce provision in UR Z10s that Rescue and emergency response equipment must be suitable for the configuration of the space being surveyed including the size of the access points.(PSU 12032, GPG 12138\_)
- c) An inquiry from an IACS member whether the 'Other equivalent means' referred in Para 5.3.2 of IACS UR Z10.2 include the use of Cherry Pickers for survey of other structures. (PSU 12022)

**.3 List of non-IACS Member classification societies contributing through the TC Forum and/or participating in IACS Working Group:**

None

**.4 History of Decisions Made:**

- a) Panel considered revising the requirements in UR Z10.1 and Z10.4 for pressure testing of cargo tank bulkheads which are not adjacent to non-cargo tanks/space for oil tankers in order to accept Master's statement at class renewal survey.

Survey Panel reported this issue to GPG and asked further instruction, and accordingly, GPG instructed Survey Panel to consider this issue based on two major opinions from GPG members (i. e. the 1st view was that IACS should expand UR Z10.1 and UR Z10.4 item 2.5.1 with a text similar to the one accepted for Chemical Carriers in UR Z10.3 item 2.5.1 while the 2nd view was that external boundaries of all cargo tank bulkheads adjacent to non-cargo tanks/spaces (e.g. facing ballast tanks, void spaces, pipe tunnels, fuel oil tanks, pump rooms or cofferdams) shall still be required to be tested in the presence of a Surveyor.

Panel discussed and agreed to amend the requirement of para 2.5.1 of UR Z10.1 and UR Z10.4 in order to accept master's statement for cargo tank testing.

- b) GPG Chairman requested to consider the suggestion of EG/SoS to clarify the wording in UR Z 10.1 – 10.5 to make it compliance with draft PR37 submitted by EG/SoS.

The Survey Panel discussed this matter and introduced a new (sub-)section 5.5 "Rescue and emergency response equipment" in line with the suggestion of EG/SOS.

- c) Discussion of this matter initiated by a Panel member regarding the use of Cherry Pickers in Cargo Holds with reference of IACS URZ10.2. In accordance with UI SC191 and Rec 91, the Cherry Picker is allowed up to 17m height for Cargo Hold structure (ships constructed after 2006 for Alternative means of access). As per the provisions of URZ10.2, Cherry pickers are allowed for survey of side shell frames only.

Panel discussed and considered that Para 5.3.2 of UR Z10.2 allows the use of Cherry Pickers as 'Other equivalent means'. Accordingly, Panel agreed to clarify this matter by including text "hydraulic arm vehicles such as conventional cherry pickers" to UR Z10s and UR Z7s for a ship not subject to the above 17m restriction.

## **.5 Other Resolutions Changes**

- a) The identical amendment affects UR Z10.4  
b) The identical amendment affects UR Z10.2, UR Z10.3, UR Z10.4 and UR Z 10.5.  
c) The identical amendment affects UR Z7, UR Z7.1, UR Z10.2, UR Z10.3, UR Z10.4 and UR Z 10.5.

## **.6 Dates:**

Survey Panel Approval: 7 March 2013 during 17th Survey Panel Meeting  
GPG Approval: 22 May 2013 (Ref: 9640\_IGn)

## **• Rev.19 (July 2011)**

### **.1 Origin of Change:**

- Suggestion by an IACS member

### **.2 Main Reason for Change:**

Following external audit a member was advised that a small temporary doubler on a cross-deck strip of a bulk carrier should have been promptly and thoroughly repaired at the time of survey. The member carried out an investigation and found that the actions of the surveyor were fully justifiable, the temporary repair and short term Condition of Class imposed were an appropriate method of dealing with such a situation. The member advised that the current requirements for 'Prompt and Thorough Repair' stipulated under the UR 7 and UR 10 series do not give any leeway for carrying out temporary repairs (and imposing a Recommendation/Condition of Class in accordance PR 35) where the damage in question is isolated and localised, and in which the ship's structural integrity is not impaired.

The Survey Panel discussed the matter and agreed that under carefully defined circumstances a temporary repair and short term Recommendation/Condition of Class would be an appropriate course of action.

**.3 List of non-IACS Member classification societies contributing through the TC Forum and/or participating in IACS Working Group:**

None

**.4 History of Decisions Made:**

The matter was discussed by correspondence within the Survey Panel and at the Autumn 2010 Panel Meeting. Following discussion at which the possibility of a Unified Interpretation being raised was considered, it was eventually decided to make direct amendment to the relevant Unified Requirements.

The wording of the new paragraph to be inserted as Para 1.3.3 in all relevant Unified Requirements was extensively discussed prior to agreement.

The proposal was unanimously agreed by Survey Panel Members.

**.5 Other Resolutions Changes**

The identical amendment affects UR Z7, UR Z7.1, UR Z7.2, UR Z10.1, UR Z10.2, UR Z10.3, UR Z10.4 and UR Z 10.5.

**.6 Dates:**

Original Proposal: *September 2010 Made by a Member*

Panel Approval: *March 2011*

GPG Approval: *27 July 2011 (Ref: 11118\_IGb)*

**• Rev.18 (Mar 2011)**

**.1 Origin for Change:**

Suggestion by IACS member

**.2 Main Reason for Change:**

1) Inconsistency of the definition of transverse section of the ship given in URZ7 and URZ10s.

2) Update of references in the Executive Hull Summary Table IX.

**.3 List of non-IACS Member classification societies contributing through the TC Forum and/or participating in IACS Working Group:**

None.



#### **.4 History of Decisions Made:**

Item 1) was proposed by RS and item 2) was proposed by GL. Both amendments were agreed by the Panel.

#### **.5 Other Resolutions Changes**

UR Z10.2, Z10.3, Z10.4 and Z10.5.

#### **.6 Dates:**

Original Proposal: *January 2010, made by Survey Panel*

Survey Panel Approval: *July/November 2010*

GPG Approval: *24 March 2011 (Ref: 10170\_IGe)*

#### **• Rev.17 (Feb 2010)**

##### **.1 Origin for Change:**

Suggestion by IACS member

##### **.2 Main Reason for Change:**

As MARPOL I was revised, the reference to MARPOL I/13 (3) in paragraph 1.2.2bis should be changed.

##### **.3 History of Decisions Made:**

GL proposed the change and it was agreed by the panel.

##### **.4 Other Resolutions Changes**

UR Z10.4

##### **.5 Any dissenting views**

None

##### **.6 Dates:**

Original Proposal: *January 2010, made by Survey Panel*

Survey Panel Approval: *January 2010*

GPG Approval: *17 February 2010 (ref. 10009\_IGd)*

#### **• Rev.16 (Mar 2009)**

Survey Panel Task 62 - *Harmonization of UR Z10s to UR Z10.3(Rev.10).*

See TB document in Part B.

- **Rev.15 (Nov 2007)**

Survey Panel Task 1 – *Concurrent crediting of tanks.*

See TB document in Part B.

- **Rev.14 (Feb 2007)**

Survey Panel Task 3 – *Maintenance of Alignment/Compatibility of IACS URs and IMO survey requirements.*

See TB document in Part B.

- **Corr.1 (Sept 2006)**

Correction of typos as follows:

- In the note at the bottom of Table IX(iv) "POOR" is replaced with 'less than "GOOD"' and 'part G)' is replaced with 'part H)'.
- In para 1 of Annex III, Appendix 2 in the definition of "Cn" for  $130\text{ m} \leq L \leq 300\text{ m}$  'L – 300' has been replaced with '300 – L' in accordance with IMO Resolution MSC.105(73) ( MSC 73/21/Add.2, Annex 13).

No TB document available.

- **Rev.13 (Jan 2006)**

Survey Panel Task 22 – *Amend applicable URZ7s and Z10s to align Close-Up Survey and Thickness measurements to be carried out at the same time and location allowing for a more structured control of the thickness measurement process – plus additional changes relating to access for rafting surveys.*

See TB document in Part B.

- **Rev.12 (Jun 2005)**

WP/SRC Task 102 - *Harmonization of UR Z7s and Z10s*

See TB document in Part B.

- **Rev.11 (Aug 2003)**

WP/SRC Task 80 "*Survey reporting Principles - NMD Report on Leros Strength*" and WP/SRC Task 106 "*Incorporation of CAS requirements into A.744*".

See TB document in Part B.

- **Rev.10 (Oct 2002)**

WP/SRC tasks 91, 93 and 95.

No TB document available.

- **Rev.9 (Mar 2002)**

WP/SRC Task 87 - *Amend Z10.1 & 10.2 to reflect changes introduced to Res A.744 by MSC 73*

See TB document in Part B.

- **Rev.8.1 (Jun 2001)**

Clarification of Section 2.3.1.

See TB document in Part B.

- **Rev.8 (Nov 2000)**

Incorporation of outcome of WP/SRC Task 77 "prompt and thorough repairs" into UR Z10.1.

See TB document in Part B.

- **Rev.7 (Sept 2000)**

Introduction of Extraordinary Council Meeting (Feb 2000) decisions into UR Z10.1.

See TB document in Part B.

- **Rev.6.1 (Dec 1999)**

Clarification of paragraph 2.2.1.3.

See TB document in Part B.

- **Rev.6 (Jul 1999)**

Amendments resulting from trilateral discussions on Enhanced Survey Program with OCIMF and INTERTANKO.

See TB document in Part B.

- **Rev.5 (1997)**

Updated in accordance with amendments to IMO Res. 744(18) as contained in Annex 4 to MSC 68 WP.14.

No TB document available.

- **Rev.4 (1996)**

No TB document available.

- **Rev.3 (1995)**

No TB document available.

- **Rev.2 (1994)**

No TB document available.

- **Rev.1 (1994)**

No TB document available.

- **NEW (1992)**

No TB document available.

## **Part B. Technical Background**

List of Technical Background (TB) documents for UR Z10.1:

- Annex 1.     **TB for Rev.6 (Jul 1999)**  
See separate TB document in Annex 1.
- Annex 2.     **TB for Rev.6.1 (Dec 1999)**  
See separate TB document in Annex 2.
- Annex 3.     **TB for Rev.7 (Sept 2000)**  
See separate TB document in Annex 3.
- Annex 4.     **TB for Rev.8 (Nov 2000)**  
See separate TB document in Annex 4.
- Annex 5.     **TB for Rev.8.1 (Jun 2001)**  
See separate TB document in Annex 5.
- Annex 6.     **TB for Rev.9 (Mar 2002)**  
See separate TB document in Annex 6.
- Annex 7.     **TB for Rev.11 (Aug 2003)**  
See separate TB document in Annex 7.
- Annex 8.     **TB for Rev.12 (Jun 2005)**  
See separate TB document in Annex 8.

Annex 9. **TB for Rev.13 (Jan 2006)**

See separate TB document in Annex 9.

Annex 10. **TB for Rev.14 (Feb 2007)**

See separate TB document in Annex 10.

Annex 11. **TB for Rev.15 (Nov 2007)**

See separate TB document in Annex 11.

Annex 12. **TB for Rev.16 (Mar 2009)**

See separate TB document in Annex 12.

Annex 13. **TB for Rev.17 (Feb 2010)**

See separate TB document in Annex 13.

Annex 14. **TB for Rev.18 (Mar 2011)**

See separate TB document in Annex 14.

Annex 15. **TB for Rev.19 (Jul 2011)**

See separate TB document in Annex 15.

Annex 16. **TB for Rev.21 (Jan 2014)**

See separate TB document in Annex 16.

**Note:** *There are no separate Technical Background (TB) documents for the original resolution (1992), Rev.1 (1994), Rev.2 (1994), Rev.3 (1995), Rev.4 (1996), Rev.5 (1997), Rev.10 (Oct 2002), Corr.1 (Sept 2006), Rev.20 (May 2013), Rev.22 (Feb 2015), Rev.23 (Jan 2018), Rev.24 (May 2019) and Rev.25 (Feb 2023).*

**Technical Background Document  
WP/SRC – Trilateral Discussions  
UR Z 10.1 – Proposed Rev. 6**

**Objective and Scope:**

WP/SRC was tasked to consider OCIMF/INTERTANKO proposals to amend the Enhanced Survey Program.

**Source of Proposed Requirements:**

WP/SRC members discussed and reviewed the proposals extensively through correspondence and their meeting.

**Points of Discussion:**

WP/SRC unanimously agreed to the proposed draft UR Z 10.1. Consensus could not be achieved on any of the other OCIMF/INTERTANKO proposals. Refer to the Chairman's letters to GPG dated 4 February 1999 and 11 March 1999.

## Technical Background for Rev. 6.1, Z10.1

### 1. Scope of objectives

Revise the paragraph 2.2.1.3 to clarify that piping on deck is to be examined.

### 2. Points of discussions or possible discussions

- Before the ESP tripartite group meeting in October 1999, it was agreed to change the para. 2.2.1.3 by inserting "Cargo piping on deck, and" at the beginning of the sentence.

The change from ".....under working CONDITIONS" to "....under working pressure" was made in the last set of amendments of Z10.1--and was considered to have the same meaning as OCIMF's proposed "...to working pressure." We are agreeable to changing "under" to "to".

- However, after the ESP technical working group meeting in October 1999, it was agreed to change the para:  
Cargo piping ondeck, including COW piping, all piping systems within.....

### 3. Source/deviation of proposed requirements

The final minutes of the ESP Working Group meeting reads:

The agreement already reached on piping in tanks was reaffirmed. It was reported by the Chairman of the Working Group, Mr. Bourneuf, that the IACS Council agreed to include cargo piping on deck as per UR Z10.1 para. 2.2.1.3 herein after attached. It was confirmed by IACS, at the request of the Working Group that cargo piping does include COW piping.

Prepared by the IACS Permanent Secretariat



## Technical Background Document

### UR Z10.1 – Revision 7 For ExCM decisions

#### Objective and Scope:

Revise UR Z10.1 to introduce ExCM (Extraordinary Council Meeting in Feb 2000) decision to UR Z10's

- ExCM FUA 2-1: All ballast tanks adjacent to cargo tanks with heating coils shall be examined internally on an annual basis after the ship has reached 15 years of age.
- ExCM FUA 2-2: Intermediate surveys of ships subject to ESP, which are over 15 years of age, will be enhanced to the scope of the preceding special survey with dry docking or under water survey as applicable.

#### Source of Proposed Requirements:

The proposed requirements were developed by WP/SRC Chairman, shortly after GPG 48<sup>th</sup> meeting:

- The para. 3.2.5.2 for ExCM FUA 2-1:
- The para. 4.2.2, 4.2.3 & 4.2.4 for ExCM FUA 2-2.
- The para. 7.1.1 for compatibility with the PR 19 (ABS GPG suggested).

#### Points of Discussion:

-

#### Unresolved Comments:

-

#### Discussions:

WP/SRC Chairman, when submitting draft revision to GPG, raised the following concerns:

- What tanks are required by the term "ADJACENT" ?  
WP/SRC Chairman said that tanks with a common line boundary have not been a problem since there is very little transfer of heat and should not be included.  
GPG exchanged views on this point and agreed to delete the wording "or line" from the para. 3.2.5.2 which reads: Oil Tankers exceeding 15 years of Age: All Ballast Tanks adjacent to (i.e., with a common plane ~~or line~~ boundary) a cargo tank with heating coils is to be examined internally.
- Ships using heating coils in cargo tanks  
Most existing single hull crude oil carriers only use heating coils in the slop tanks which usually do not have ballast tanks as boundaries. White oil product carriers do not need heating and therefore they should not be included in additional annual survey requirements for ballast tanks. Majority of GPG Members agreed.

Submitted by the Permsec  
On 18 Sept 2000

**Technical Background Document**  
**WP/SRC Task 77**  
**UR Z7 – Proposed Draft Revision 7**  
**(Including Rev.8 of Z10.1, Rev.11 of Z10.2, Rev.4 of Z10.3)**

**Objective and Scope:**

Extend the requirements for permanent repairs at the time of survey in UR Z 10.2 to all ships.

**Source of Proposed Requirements:**

The proposed requirements were developed by WP/SRC members through correspondence and discussions at the September 2000 meeting.

**Points of Discussion:**

UR Z7 was amended to apply “prompt and thorough” repairs to all vessels. The new wording defines a prompt and thorough repair to be a repair as a result of wastage and not an incident such as contact damage where a temporary repair or deferral of repairs could be permitted. This wording is more explicit than the wording in UR Z10.2 and should achieve a uniform application among the Members.

WP/SRC also agreed to include these requirements in Z10.1, Z10.2 and Z10.3 in order to not effect A.744(18).

WP/SRC unanimously agreed to the draft UR.

Note by Permsec

GPG 49 (11-13 Oct. 2000) agreed that the same changes be introduced to Z10's and carried out editorial review of Z 10's.

**Technical Background Document**  
**WP/SRC Task 75**  
**UR Z10.1 – Proposed Draft Revision 8**  
**&**  
**Z10.3 – revision 4**

**Objective and Scope:**

Develop a definition of 'related piping' as contained in UR Z10.1 and requirements for survey.

**Source of Proposed Requirements:**

The proposed requirements were developed by WP/SRC members through correspondence.

**Points of Discussion:**

The proposal limits the definition of "related piping" to the piping systems which require testing. This will not include hydraulic oil piping for remote control valves or anchor/mooring equipment which OCIMF may have wanted included. WP/SRC feels that related piping systems are those that are unique to an oil carrier and was the original intent of the wording.

WP/SRC unanimously agreed to the draft UR.

**Note by the Permsec:**

LR GPG proposed to change Z10.1 as follows:

“piping systems for the handling of cargo / cargo residues and water ballast and additionally bilge systems in combination carriers. 8220iLRa, 30/8/2000”

GPG Chairman asked WP/SRC to discuss LR's proposal to include “bilge piping systems” in Z10.1 at their 2000 September meeting.

WP/SRC Chairman reported back to GPG on 22 September 2000 as follows:

1. "Cargo piping" adequately covers and is understood by all members to include cargo stripping piping, just as "Ballast piping" includes ballast stripping piping.
2. WP/SRC is of the opinion that bilge piping on combination carriers should not be added to the proposed revision due to the fact that it is a separate system which usually run through a pipe tunnel and is not hydro tested at new construction. The system also operates on a vacuum and is blanked off when oil is carried.

Therefore, WP/SRC maintains its agreement that the previously submitted text is the preferred by all members.

GPG agreed that a similar amendment be made to Z10.3.

Based on the above discussion at GPG level, the revised of Z10.1 and Z10.3 was finally approved at GPG 49.

Submitted by WP/SRC Chairman

On 27 July 2000

(This view was shared by the majority of GPG Members, however, it has not been codified in Z 10.1 because no need was identified to prescribe it as a Unified Requirement.)

- Identify tanks with heating coils

WP/SRC Chair said that the vessel's survey status does not tell us tanks fitted with heating coils.

- Coating Condition and Substantial Corrosion Survey Requirements

Ballast tanks with poor coating, no coating or substantial corrosion identified at a previous survey already requires annual survey. With enhanced intermediate survey, all ballast/cargo tanks will be examined and gauged at special/intermediate survey and coating condition & substantial corrosion should be identified at that time. If coating condition is reported good or fair, it may be adequate to only verify the coating condition at annual survey of ballast tanks adjacent to cargo tanks fitted with heating coils.

In addition, DNV and LR (GPG) proposed the following additions:

- The 3<sup>rd</sup> sentence in para. 3.2.5.2 (DNV):

"Tanks or areas where coating was found to be in GOOD condition at the previous intermediate or special ~~internal examination~~ are to survey may (ABS' comment) be specially considered by the Classification Society."

The majority GPG agreed.

- The second half of the para. 4.2.4.1(LR)

"except that testing of cargo and ballast tanks is not required unless deemed necessary by the attending surveyor."

The majority GPG agreed.

- The paragraph 7.1.1 of Z10.1 and Z10.3, paragraph 8.1.1 of Z10.2 were revised for their compatibility with the PR 19 "PR for Thickness Measurement".

-----

Submitted by the Permsec  
On 18 Sept 2000

## Technical Background for

**Rev.8.1, Z10.1**

**Rev.11.1, Z10.2**

**Rev.4.1, Z10.3**

(21 June 2001)

### 1. Scope of objectives

Revise section 2.3.1 for clarity.

### 2. Points of discussions or possible discussions

- BV GPG member proposed to revise section 2.3.1 of Z10s on 12 June 2001 (0065j)
- IACS Council considered the ambiguity of the sentence in Special Survey section 2.3.1 "For Fuel Oil Tanks the necessity for the Overall Survey is to be determined based on the ship's age" in the context of its application at intermediate surveys on ships over 15 years. Council agreed that the overall survey of low corrosion risk tanks such as fuel oil, lube oil and fresh water tanks could be subject to special consideration as already addressed in section 2.2.5 of UR Z7 and therefore amended the first sentence of 2.3.1, accordingly, and deleted the last sentence of 2.3.1.
- Adopted on 21 June 2001.

\* \* \* \* \*

**Technical Background Document**  
**WP/SRC Task 87**  
**Amend Z10.1&10.2 to reflect changes introduced to Res A.744 by MSC 73**  
**(Z10.1, Rev.9) + (Z10.2, Rev.12) + (Z10.3, Rev.5)**

**Objective and Scope:**

To harmonise IACS UR Z10.1 and Z10.2 with IMO Res A744(18), as previously amended and as amended by IMO MSC105(73) and MSC 108(73).

These amendments enter into force 1 July 2002.

It was assumed by WP/SRC that the intention of GPG has been to revise UR Z10.3 (chemical tankers) as well with respect to the intermediate dry-docking requirement, but not to include the requirement to evaluation of longitudinal strength.

In addition, the relevant changes to UR Z10.1 based on the changes introduced in IMO Res A744(18) as reported in MSC 74/24/Add1-Annex 17 have been included. These were based on IACS submission DE 44/13/1. These amendments will enter into force 1 January 2004 subject to IMO tacit acceptance procedures.

**POINTS OF DISCUSSION:**

The Chairman of WP/SRC would further draw GPG's attention to paragraph 4.2.4.3, which contains the requirement to intermediate dry-docking for oil tankers exceeding 15 years of age. The corresponding Res.A 744(18) requirement (paragraph 2.2.2) does not link the dry-docking to the intermediate survey. This issue was discussed extensively by correspondence and during three WP meetings this year. A consensus decision was achieved without reservations from any members. This process was time consuming, hence the delay in submitting this document to GPG for approval. However, at the annual meeting of the WP in October 2001 all members agreed that we should not accept the wording of Res. A 744(18) paragraph 2.2.2, but instead require that the intermediate dry-docking is to be linked to the intermediate survey and include a requirement to carry out surveys and thickness measurements of the lower portions of the tanks for oil tankers. (similarly, cargo holds/water ballast tanks for bulk carriers)

GPG is advised to note that the proposed requirement in paragraph 4.2.4.3 may result in a third dry-docking within the 5-year period of the classification certificate in case that a dry-docking is carried out prior to the window for intermediate survey.

The Chairman of WP/SRC suggests that GPG approves UR Z10.1 with high priority and allows PermSec in the meantime to start the work to amend and typeset UR Z10.2 and URZ10.3 with respect to the intermediate dry-docking requirement, as well as introducing the appropriate changes to UR Z10.2 and UR Z10.3 with respect to MSC 74/24/Add 1-Annex 17.

Note:

1. GPG tasked WP/SRC to review dry-docking survey requirements in Z10.2-4 and Z3 to harmonize them with those in Z10.1 (Rev.9) and reflect in Z3 the interim application of bottom survey requirements as introduced in MSC/Circ. 1013 (Res A.746(18)).  
Task 101, Target 2Q-2002
2. GPG confirmed (s/n 1060c) that 7.1.3 of A.744(MSC 74/12/Add.1/Annex 17/page 6), as quoted below, should not be included in Z10s.  
“7.1.3 Thickness measurements are to be carried out within 12 months prior to completion of the periodical survey or of the intermediate survey.”  
**Reason:** The above sentence will restrict the 15 month and 18 month survey window for TM during the intermediate and special surveys respectively.
3. GPG confirmed that 7.1.4 of A.744(MSC 74/12/Add.1/Annex 17/page 6), as quoted below, should not be included in Z10s:  
“7.1.4 In all cases the extend of the thickness measurements should be sufficient as to represent the actual average condition.”  
**Reason:** No compelling need, in view of MSC 74/12/Add.1 being adopted by MSC 75(May 02). IACS will live with this not harmonized sentence.
4. For IACS Council decisions to improve bulk carrier safety, see the TB for Revision 12 of Z10.2.

Submitted by WP/SRC Chairman

## **UR Z10.1(Rev.11) and Z10.2(Rev.14)**

**(July 2003)**

### **Technical background**

#### **Part A: Survey Reporting Principles**

##### **1. Objective**

WP/SRC Task 80 – Survey Reporting Principles

##### **2. Points of discussion**

The WP/SRC carried out this task according to the work specification of Form A (Rev.1) and reported the outcome on 18 December 2002 as follows:

- Review of NMD's report on "Sinking of Leros Strength", dated 6 July 2000 and the recommendations in section 5.3
- Review of IACS Council's reply, dated 22 August 2000 to those recommendations
- For recommendations 1.1, 1.2, 1.3 ,3, 4.2, 5 and 6, best practices have been identified by information exchange amongst Members and discussions at three WP-meetings.
- Harmonised survey reporting practices fulfilling, in so far as practicable, the recommendations of NMD have been included in the revised tables attached.
- Standard survey reporting terminology (recommendation 2) is in the process of being prepared and will be submitted to GPG for approval as an IACS Recommendation with the title "Surveyor's Glossary". The completion of the glossary has been delayed somewhat due to pending illustrations of typical hull structures.

Council approved on 14 July 2003 (2249\_).

\*\*\*



## **Part B: Incorporation of CAS related requirements into UR Z10s**

### **2. Objective**

WP/SRC Task 106 – Incorporation of CAS related requirements into A.744

### **2. Points of discussion**

The WP/SRC carried out this task according to the work specification of Form A and reported the outcome on 27 May 2003.

- Since CAS was developed for tankers only, WP/SRC considered whether there is any need to further develop/modify requirements in CAS with respect to bulk carriers. Hence, amendments to Z10.15.5.5(rafting), 5.6(survey planning), 8.2.2(different survey stations) and Table 1(close-up survey).
  - IACS will submit its proposed amendments to Res A.744 as a result of this revision.
  - NK GPG suggested that the word “alone” be inserted after “rafting” in Z7 and Z10.1(5.5.5)~10.5.
    - WP/SRC had considered this and felt that the insertion of the word "alone" will create a loophole as the text "Rafting alone will only be allowed..." could be interpreted that other means of access have to be used. Besides this wording would impede the use of rafting for survey of side and bottom structures of the spaces.
    - GPG considered that rafts/boats should be accepted as a means to move about within a tank to gain access to any temporary platforms that may be erected. Consequently, the wording of 5.5.5 was re-drafted and split into three parts (5.5.5~5.5.7) beginning with “Rafts or boats alone may be allowed for inspection of the under deck areas...”
- The same wording will be introduced into Z10.3, Z10.4, Z10.5, Z7 and Z7.1.

Approved on 08/08/2003 (0237h)

\*\*\*

Prepared by the Permanent Secretariat

22 July 2003

**WP/SRC Task 102**  
**HARMONIZATION OF UR Z7s AND Z10s**

**Technical Background**

**UR Z7 (Rev. 11)**

**UR Z7.1 (Rev. 2)**

**UR Z10.1 (Rev. 12)**

**UR Z10.2 (Rev. 17)**

**UR Z10.3 (Rev. 7)**

**UR Z10.4 (Rev. 2)**

**UR Z10.5 (Rev. 1)**

Contents:

TB for Harmonization

**Annex 1.** TB for UR **Z10.1(Rev.12**, C49 amendments(coating-related))

**Appendix 1:** Memo for Coating, submitted to Council  
49(June 2004).

**Appendix 2:** DNV proposal (25 May 2005) agreed by Council

**Annex 2.** TB for "Verification/Signature of TM Forms" for records.

**Annex 3.** TB for revision of UR Zs concerning "anodes".

**1. Objective**

To amend UR Z7s and Z10s in order to make the texts of the above-mentioned URs consistent eliminating all the differences both in substance and in wording (WP/SRC Task 102).

**2. Background**

In the process of approving UR Z10.4, GPG found it necessary to amend the other existing URs Z10.1, Z10.2, Z10.3, Z10.6 and Z7 in order to eliminate any inconsistencies existing among them.

**3. Methodology of work**

The WP has progressed its work through many sessions, both during the periodical meetings and dedicated meetings restricted to a Small Group of Members (BV, DNV, GL, LR, RINA) who developed the work in order to be more efficient. All the proposed amendments of the Small Group have regularly been circulated to all Members for comment and agreement.

## 4. Discussion

4.1 The WP/SRC has completed a comprehensive comparative review of UR Z7 and Z10s, and identified inconsistencies which existed among them. During this review, attention was given to the severity of the requirements applicable to the same spaces/structural areas on different types of ESP ships. As a result, the inconsistencies were eliminated making the URZs harmonized. However, there has been no change to the scope and extent of the survey requirements.

4.2 The starting point for each UR was the most updated version available at the time of commencement. Any revision to the URZs, which were introduced during this task, was taken into account. As for instance, the UR Z10.1 was initially amended based on Rev. 9, while the last amendments are based on Rev. 11 and the UR Z10.2 was initially amended based on Rev. 13, while the last amendments are based on Rev. 16. The proposed revisions of URs Z10.1 and Z10.4 have not been numbered, as there will be revisions to those URs before the revisions introduced by the Task 102 are adopted. In fact, GPG is currently developing a Revision 12 of Z10.1 with the view to introducing significant improvements in the survey regime for ballast tanks (including combined cargo/ballast tanks) of oil tankers and UR Z10s applicable to oil tankers will also have to be revised by incorporating the amendments to A.744(18) contained in Resolution MSC 144(77), which enter into force 1 January 2005 (see 4.3 below).

4.3 Also, in harmonizing UR Z10.1 and Z10.2 care has been taken to align the corresponding text with that of IMO Res. A.744(18). However, it has been noted that the amendments to A.744(18) contained in Resolution MSC 144(77), which enter into force 1 January 2005, have not been incorporated into the IACS UR Z10s applicable to oil tankers. It seems that the updating of the above-said UR Z10s will be done by the Perm Sec and reviewed by the WP/SRC Chairman and then circulated for adoption by GPG with concurrence of Council Members for uniform application from 1 January 2005. It is understood that the revisions of the UR Z10s affected by those amendments will not include the changes introduced by the Task 102, as the implementation date proposed for those changes is 1 January 2006 (see below **6. Implementation**).

4.4 In the course of the work the WP has been developing for more than two years, several additional Tasks were assigned to the WP by GPG which affected the development of Task 102. The additional tasks which have been taken into account are the following:

- 1) In the course of Council discussion on UR Z10.6 (General Cargo Ships), certain inconsistencies were identified between Z10.6 and other Z10s. WP was instructed to expedite Task 102 (1060gIAa, 12 June 2002);
- 2) WP was instructed to include "Survey Planning for Intermediate Survey" into harmonization work (2108\_IAa, 12 July 2002);
- 3) GPG instructed WP to consider whether Z10.6 should be re-assigned as Z7.1, in connection with the harmonization work. 1060gIAb, 20 Sept 2002.

- Z7.1 developed;
- 4) Partial outcome (Z7 and Z7.1) was submitted to GPG on 17 July 2003(1060g). Council decided that approval of Z7(Rev.10) and Z7.1(Rev.2) is postponed until the harmonization is completed (1060gICb, 6 April 2004);  
[Council Chairman instructed WP/SRC to Members' comments on the draft revision of UR Z7 and Z7.1 \(collected under s/n 1060g, 1060gNKi \(30/03/2004\) in particular\) on 6 April 2004.](#)
  - 5) GPG tasked WP to include the amendments to Z10.2 / Z11 (BCs with hybrid cargo hold arrangements), deleting sheets 15 and 16 for ore carriers, into the harmonized UR Z10s (2212aIGa, 19 Jan 2004);
  - 6) GPG tasked WP to consider whether the requirements relevant to examination of Fuel Oil Tanks in the cargo area at each Special Survey should be put into Z10s, and internal examination of FOT at Intermediate Survey after SS 2 is needed. (1060gIAf, 30 Jan 2004);
  - 7) GPG tasked WP to harmonize tank testing requirements in Z7s and Z10s. (3006IIAa, 5 April 2004);
  - 8) GPG tasked WP with Task 108 - Develop uniform survey requirements for air vent pipes including the welded connection to deck. Z22 developed. GPG instructed WP to incorporate Z22 into the harmonized Z10s;
  - 9) GPG tasked WP with Task 114 - Verification and signature of TM reports. REC 77(Rev.1) developed and approved on 29 July 2004. Council approved parallel amendments to Z7.1 and Z10s (TM Forms included) and instructed WP to incorporate these into the harmonized Z10s:
    - [Recommendation No.77 was revised \(Rev.1, July 2004\);](#)
    - [Z7.1 para.6.3.2 and Z10s para.7.3.2 so amended.](#)
    - ["Surveyor's signature" is deleted from all TM Forms in Z10s;](#)
    - [A note is added to Annex II\(Z10s\) declaring that Annex II is recommendatory.](#)

WP/SRC's investigation into Members' practice in dealing with verification and signature of TM reports is annexed for record keeping purpose. [See Annex 2.](#)
  - 10) GPG tasked WP to consider the BV comments on "TM may be dispensed with..." and include the findings into the harmonized Z10s ( 2219iIAa, 7 April 2004).

## **5. Agreement within the WP/SRC**

All Members have unanimously agreed the attached final versions of UR's.

## **6. Implementation**

WP/SRC is of the view that the Members need 12 months from the adoption date to implement these amendments into their class rules. Assuming Council adoption in December 2004, WP/SRC would propose January 2006 as implementation date.

- Annex 1:** TB for UR Z10.1(Rev.12, C49 amendments, see Permsec's note 1 below)  
**Annex 2:** WP/SRC Task 114, verification and signature of TM reports(see 9 above).  
**Annex 3:** TB for revision of UR Zs concerning "anodes".

### Note by the Permanent Secretariat

1. Annex 1 to this TB contains background for amendments to UR Z 10.1(Rev.12) relating to FAIR/POOR/GOOD (C49 amendments). Council at its 49<sup>th</sup> meeting (June 2004) agreed/decided that comparable changes should be added to Z10.3 and Z10.4.
  
2. Appendix 3 "TM sampling method" has been added to UR Z10.1 and Z10.4 to keep them consistent with IMO Res.MSC.144(77). The amendments to A.744 contained in MSC.144(77) entered into force on 1 January 2005. (*GPG s/n 4181*)  
  
Under s/n 4072g, paragraph **2.4.6** of UR Z10.1 and **2.4.6** and of UR Z10.4 (paragraph numbering is now harmonized) were amended in order to provide a link between the main text of the UR Z10.1 and 10.4 and the new Annex III Appendix 3 containing the MSC Res.144(77).  
Further, it was agreed that the requirements for evaluation of longitudinal strength of the hull girder (as written in MSC.144(77)) should not be required for Intermediate Survey unless deemed necessary by the attending Surveyor. This is covered in 4.2.3.1 and 4.2.4.1 of Z10.1 and Z10.4.
  
3. GPG agreed that the amended UR Zs should be implemented from 1 July 2006 altogether.
  
4. DNV's proposed amendments to UR Z10.1, Z10.3 and Z10.4 concerning annual survey of ballast tanks were agreed by Council (1060gICq, 27 June 2005). See Appendix 2 to Annex 1.
  
5. Annex 3 contains a TB for revision of UR Zs concerning "anodes".

Date: September 2004  
Prepared by the WP/SRC

---

## **Annex 1 to Technical Background**

### **UR Z 10.1 (Rev.12, C49 amendments(coating-related))**

#### **1. Objective**

To introduce significant improvements in the survey regime for ballast tanks (including combined/ballast tanks) of oil tankers as matter of strategic concern and urgency to IACS, given the aging of both the single and double hull tanker fleets and the problems encountered with corrosion of ballast tanks in several shipping casualties.

#### **2. Background**

Draft amendments to UR Z10.1 were submitted to Council 47 (June 2003) and agreed in principle.

#### **3. Discussion**

There was particular concern over accelerated corrosion with age (as the thinner the material, the more rapidly the allowable diminution margin percentage disappears) especially where coatings have broken down. There is also a disincentive for any spend on maintenance of the structure of a ship within a few years of its statutory scrapping date.

Council discussion by correspondence had evolved to the position of substantive proposals – summed as follows (3095\_ABa, 2 June 2003):

1. Enhance the Intermediate Survey in Z10.1, Z10.3 and 10.4 for Tankers after 2<sup>nd</sup> Special / Renewal Survey to the same level (scope of work) as the preceding Special / Renewal Survey). This corresponds to the latest revision to UR Z10.2.
2. At Annual Survey of ballast tanks with substantial corrosion, the overall survey is to be replaced by close-up survey with thickness measurements of the exposed area.
3. Proposed to task WP/SRC to re-consider the acceptance criteria for the rating FAIR further. For this, eliminate FAIR, leaving only GOOD and POOR redefined as appropriate.
4. Proposed to task WP/SRC to explicitly require close-up survey of Suspect Areas identified at the previous Special Survey.

Council 47 discussed the proposals(June 2003) as follows:

##### **1. Definition of FAIR**

Council 47 agreed that “FAIR” would be retained as a rating and that GPG should instruct WP/SRC to redefine FAIR, so that there would be a clear differences between FAIR, POOR and GOOD. It was also agreed that for oil tankers the Intermediate Survey following Special Survey No.2 would have the same scope as Special Survey No.2(Z10.1). WP/SRC should also clarify the definition of satisfactory repair.

Based on the strong majority, Council agreed to discuss with Industry annual surveys of ballast tanks when coating is found in LESS than GOOD condition at special survey, with the objective to encourage the owner to carry out repairs and maintenance of coating to GOOD condition.

*DNV and NK stated that they could not accept a requirement for annual surveys of ballast tanks when the coating condition is less*

*than GOOD and proposed that GOOD be changed to FAIR (3095\_IGc, 30 June 2003)*

2. ABS' proposed amendments to Z10.1(annual examination of BWTs in certain conditions) were approved.
3. C 47 agreed that the BWT coating requirements (Z10.1.2.2.3) for intermediate Survey after SS 2 should be the same extent to the previous SS.
4. Given the substance of the changes, the revised Z10.1 should be shown to Industry before adoption.
5. A guidance for coating repairs needs to be developed by WP/SRC with reference to TSCF Guidelines.

Following Council 47, the draft text of Z10.1(Rev.12) was distributed to Industry and discussed at the IACS/Industry meeting on 29 August 2003. Industry indicated that UR Z10.1(Rev.12) is acceptable, provided that appropriate IACS guidelines on coating repairs are developed.

The Small Group on Coating (SG/Coating) under WP/SRC prepared draft guidelines on coating repairs and considered the definitions of GOOD / FAIR / POOR. The SG/Coating did not change the definitions and found that the Guidelines provide useful clarifications on the definitions and criteria in achieving an industry wide uniform judgement of coating conditions as well as what is needed to restore GOOD conditions.

Further, an IACS/Industry JWG/Corrosion was established and met in February 2004. The outcome is (3095\_IGh, 4 June 2004):

- Draft Guidelines on Coating Repair (IACS REC 87)
- Draft UR Zxx (mandatory coating of cargo tanks on oil tankers)
- Draft UI SC 122 (Rev.2) – mandatory coating of ballast tanks

#### **4. Others**

1. Z10.11.2.2bis - Definition of “Combined Cargo/Ballast Tank. ...as a routine part of the vessel's operation and will be treated as a Ballast Tank. ...”. By so amending, Z10s do not need to repeat “Ballast Tanks and Combined cargo/salt water Ballast Tanks” in addressing the ballast tanks. Hence, all the references to “and Combined cargo/salt water Ballast Tanks” were deleted.
2. Z10.1.2.2.1.2: The aim of the examination is to be sufficient to discover substantial corrosion...  
Comparable changes are to be added to other UR Zs wherever the same sentence occurs.
3. “IACS Guidelines for Coating Maintenance & Repairs for Ballast Tanks and Combined/Ballast tanks on Oil Tankers” are referenced where relevant.
4. Comparable changes are to be added to UR Z10.3 and Z10.4, after adoption of Z10.1(Rev.12).

**Attached: Memo on Coating Matters (GPG Chairman)**

9 June 2004  
Prepared by the Permsec

## **Appendix 1 to Annex 1:**

## **MEMO on Coating matters**

### **1. Background and discussion within IACS on UR Z10.1 (draft Rev.12) between 29/01/03 and 14/08/03**

In view of the survey experience with oil tankers, it was proposed that all ballast tanks should be examined, routinely and uniformly, at annual surveys on ESP tankers exceeding 15 years of age. IACS should amend UR Z10.1 to require the examination of ballast tanks on such ships at each annual survey. This is simple, clear and thorough and not subject to interpretation. (2242\_ABq dated 29/1/03)

Then, ABS modified the proposal asking, for tankers subject to URs Z10.1, Z10.3 and Z10.4, exceeding 15 years of age, that the current requirement - pertaining to annual examination of Ballast Tanks adjacent to cargo tanks with any means of heating - be deleted and replaced by a simpler and more stringent requirement that all Ballast Tanks be subject to survey at each subsequent annual survey where either substantial corrosion is found within the tank or the protective coating is found to be in less than GOOD condition and the protective coating is not renewed at special survey or intermediate survey. This will ensure that all Ballast Tanks with substantial corrosion or protective coating which is not in GOOD condition at the time of special survey or intermediate survey will be examined at each subsequent annual survey on tankers exceeding 15 years of age. (2242\_ABzb dated 14/3/03)

This was later expanded to include all tanks used routinely for ballast water, both ballast-only and cargo/ballast tanks (2242\_ABzc dated 14/3/03).

ABS further reviewed the issue of the survey of salt water ballast spaces and combined cargo/salt water ballast spaces with ABS' governing bodies in light of recent casualties and survey findings on other tankers. Their review found an increasing amount of coating breakdown/failure and subsequent rapid wastage in key structures after Special Survey No. 2, i.e. after 10 years of age. These conditions are most prevalent in the under deck structure and the side shell structure in way of the deep loadline. In a number of cases the serious wastage has caused fracturing of the under deck longitudinals and in some cases fracturing has extended to the main deck structure. This led ABS to refine proposed amendments to URs Z10.1, Z10.3 and Z10.4 to require (2242\_ABzf dated 9/5/03):

#### a. For Tankers exceeding 10 years of age

Salt Water Ballast Spaces and Combined Cargo/Salt Water Ballast Spaces. For tankers exceeding 10 years of age, salt water ballast spaces and combined cargo/salt water ballast spaces are to be internally examined at each subsequent Annual Survey where substantial corrosion is found within the tank or where the protective coating is found to be less than GOOD condition and protective coating is not repaired. Internal examination to be an Overall Survey.

#### b. For Tankers exceeding 15 years of age:



Salt Water Ballast Spaces and Combined Cargo/Ballast Spaces. For tankers exceeding 15 years of age, salt water ballast spaces and combined cargo/ballast spaces are to be examined internally at each subsequent Annual Survey. Where substantial corrosion is found within the tank, or where the protective coating is found to be in less than GOOD condition and the protective coating is not repaired then in addition to an Overall Survey, under deck structure and the side shell structure in way of the deep loadline is to be subject to Close-up Survey.

NK and BV replied that the proposed amendments made by ABS need to be substantiated in a transparent manner with technical data that ABS may possess and put forward for further assessment and discussion. (2242\_NK<sub>n</sub> dated 14/5/03 and 2242\_BV<sub>z</sub> dated 16/5/03)

**DNV** (2242\_NV<sub>n</sub> dated 2/6/03), having carefully considered the practical consequences of taking the ship off-hire for gas freeing etc. and being concerned about the difficulties to have these surveys executed in a safe manner and whether the intended safety benefits in implementing the proposed extended scope of the annual survey of Ballast tanks will be met, **proposed the following alternative measures** which would be as effective and may not have such delaying effects to the ship:

- 1) Enhance the Intermediate Survey in UR Z10.1, 10.3, and 10.4 for Tankers after the 2 Special / Renewal Survey to the same level (scope of work) as the preceding Special / Renewal Survey. (This will correspond to the latest revised requirements of UR Z10.2 for Bulk Carriers.)
- 2) At Annual Survey of ballast tanks with substantial corrosion the overall survey should be replaced by close up survey with thickness measurements of the exposed area. (An overall survey of these tanks does not give sufficient information of the development of the areas with substantial corrosion.)
- 3) Further we will not fail to mention that the WP/SRC has proposed to extend the close up survey in cargo and combination tanks to 30% from the 3 Special / Renewal Surveys.
- 4) **Experience has shown that the coating condition rating category FAIR has a tendency to be stretched too far into the POOR condition. We will therefore propose that we task the WP/SRC to reconsider the acceptance criteria for the rating FAIR further.**
- 5) We do also question the need for redefining the definition of combination tanks, particularly since the category I tankers which are the ships that normally are fitted with these type of tanks are to be phased out 2 to 4 years from now. However DNV will not oppose to such a redefinition.

**DNV requested Members to consider the above as an alternative to the ABS proposal, bearing in mind that we ought to present this to the industry prior to deciding.**

ABS (3095\_Aba dated 2/6/03), having further considered its earlier proposals in light of NV<sub>n</sub>, submitted a revised proposal for consideration by Council at C47 and replied to the above 5 DNV proposals as follows:

- 1) ABS fully supports this proposal.
- 2) While ABS agrees with this proposal, it is in fact already provided for in Z7 (3.2.3) and Z10.1 (3.2.5.1)--which require that "Suspect areas (which include any area where substantial corrosion is found) identified at previous Special Survey are to be examined. Areas of substantial corrosion identified at previous special or intermediate survey are to have thickness measurements taken." To us, this implies that close-up survey of these areas is to be done at annual survey in conjunction with the thickness measurements. However, we can

agree to tasking WP/SRC to explicitly require "close-up" survey in this connection and to amend Z7, and all the Z10's, appropriately to make this explicit, if there is majority support for this.

3) We agree that this has been put forward to GPG by WP/SRC via 0237hNVb, 27 May. However, these additional CAS close-up survey requirements do not apply to salt water ballast tanks; only to cargo oil tanks and combined cargo/ballast tanks.

4) **We agree with this assessment and we propose that the only way to eliminate the subjectivity and raise the standard is to eliminate the category "FAIR" completely; leaving only "GOOD" and "POOR" redefined as follows:**

**"GOOD -- condition with no breakdown or rusting or only minor spot rusting.**

**POOR -- any condition which is not GOOD condition."**

5) ABS does not agree with this proposal. We are particularly concerned that we need a very thorough and robust survey regime for these tankers precisely because they are subject to mandatory phase out over the next several years. We are very concerned that without additional IACS requirements, these tanks will receive little or no inspection and maintenance by owners or others after their last special or intermediate survey, if no substantial corrosion is found at that time. Rapid, localized wastage in way of deteriorating coatings may pose significant hazard if the survey regime is not further tightened as we are proposing.

In conjunction with the above comments on DNV proposals, ABS further considered their previous proposal in ABzf and modified it as follows:

- **ABS simplified the proposal to require annual examination of all salt water Ballast Tanks and combined Cargo/salt water Ballast Tanks irrespective of age, when either substantial corrosion is found within the tank or the protective coating is found to be in less than GOOD condition and is not repaired.**
- the requirement for annual (close-up) examination of salt water ballast tanks and combined tanks is already required in Z10.1 (3.2.5.1). ABS proposed adding it to 2.2.3 for clarity and emphasis so that all the conditions which may lead to annual examination of such tanks are listed together in one place.
- Since the principal problem that we are trying to address is rapid, localized corrosion in way of breakdown or deterioration of the protective coating, we are proposing that the coating condition should be found and kept in "GOOD" condition to obviate the need for annual examination. **The attached proposal is made together with the proposals in items 3.1 (intermediate following Special survey 2 to have same scope as prior Special survey) and 3.4 (eliminating "FAIR" and redefining "POOR" as any condition other than "GOOD" condition.**

ABS requested to decide on a course of action at C47 for tightening the survey regime for tankers. They agreed that industry be informed of Council's decisions in this regard prior to IACS making the decision public, but IACS should maintain its independence and take decisive action in this matter. Debate with industry can only lead to delay and to a watering down and compromising of these important requirements.

NK agreed to task WP/SRC to reconsider the acceptance criteria of "FAIR" for clearly define the border between "FAIR" and "POOR" condition. However, **NK strongly opposed the elimination of "FAIR" coating condition from UR Zs** because this can not resolve to remove subjectivity of coating assessment. The three-categorization system of coating condition should be retained. (3095\_NKa dated 5/5/03)

## **Outcome of C47**

At C47, it was agreed that "Fair" would be retained as a rating and that GPG should instruct WP/SRC to redefine "Fair", so that there would be a clear differentiation between "Fair", "Poor" and "Good". It was also agreed that for oil tankers the Intermediate Survey following Special Survey No.2 would have same scope as Special Survey No.2 (Z10.1). WP/SRC should also clarify the definition of satisfactory repair.

Based on strong majority support Council agreed to discuss with Industry annual surveys of ballast tanks when coating is found in LESS than GOOD condition at special survey, with the objective to encourage the owner to carry out repairs and maintenance of coating to GOOD condition.

This matter should be discussed with Industry prior to adoption of any UR by Council.

In a final summary, the Chairman proposed that a constructive dialogue with Industry should take place on the IACS proposal as set out in WP1 plus maintaining 3.2.5.2 modified to say that ballast/combined ballast/cargo tanks will be subject to annual survey when considered necessary by surveyors.

After discussion in the JWG (Industry/IACS), GPG should propose final rules for this matter to Council, including acceptable repair definition.

**FUA 17:** *To instruct WP/SRC to develop guidance on coating repairs and more precise definition of "Fair" coating condition.*

Once approved, these requirements should be incorporated into Z10.3 and Z10.4.

### **FUA 15**

1) *To prepare a draft revision to UR Z10.1 incorporating C 47 decisions:*

- *The definition of "FAIR" remains as it is;*
- *ABS proposed amendments to Z10.1 (annual examination of BWTs in certain conditions) were approved;*
- *C47 agreed that the BWT coating requirements (Z10.1.2.2.3) for Intermediate Survey after Special Survey No.2 should be the same extent to the previous Special Survey.*
- *Given the substance of the changes, the revised UR Z10.1 should be shown to Industry (OCIMG/Intertanko first among others) before adoption for their review and comments.*
- *A guidance for coating repairs needs to be developed by WP/SRC with reference to TSCF Guidelines.*

2) *GPG Members are to confirm the draft revision to Z10.1 in consultation with their WP/SRC members by correspondence. See 3095\_IGa of 13/06/03.*

According to C47 FUA 15, GPG Chairman circulated (3095\_IGa dated 13/6/03) draft amendments to UR Z10.1 as agreed in principle at C47.

Having received a number on comments, GPG Chairman (3095\_IGb dated 27/6/03) informed that the Council Chairman confirmed that GPG is not to amend the principles agreed at C47, i.e. we are not empowered to change "GOOD" to "FAIR" as proposed by DNV and NK, nor to amend the definitions of "FAIR" and "POOR" as proposed by DNV.

DNV's intention to possibly lodge a reservation was noted, however the matter should be raised at Council and not be dealt with by GPG. An amended draft text incorporating the non-substantive changes proposed by Members was circulated.

DNV said that its understanding was that the draft should be circulated to the Industry (ICS, INTERTANKO, and BIMCO) prior to adoption by Council. (3095\_NVc dated 30/6/03)

GPG Chairman (3095\_IGc dated 30/6/03) circulated a draft amendment of UR Z10.1 for Council's agreement and use in discussions with the industry associations.

The draft was generally agreed by GPG but individual Members have requested that the following matters (which were deemed to be outside the remit of GPG in this task) be brought to Council's attention for further consideration:

- 1 DNV and NK stated that they can not accept a requirement for annual surveys of ballast tanks when the coating condition is less than GOOD and propose that GOOD be changed to FAIR.
- 2 In connection with item 1 above, DNV also propose to amend the definitions of FAIR and POOR in order to raise the standard of FAIR.

Council Chairman (3095\_ICb dated 14/8/03) concluded that Council has agreed that the draft amendments to UR Z10.1 attached to IGc reflect Councils' decision taken at C47 and that they be circulated to industry associations.

Perm Sec was therefore invited to submit the draft to OCIMF and INTERTANKO in view of discussion at the IACS/ industry meeting on 29 August.

## **2. Discussion with Industry (29/08/2003 – 11/10/2003)**

As requested by Council, the whole matter was presented to Industry during the “general matters” meeting with IACS held on 29 August 2003; comments from Industry were requested. In the following an extract from the minutes of the meeting (see message 3100aIAb dated 5 September 2003):

\_\_\_\_\_ from Meeting minutes \_\_\_\_\_

## **4. & 5. Annual surveys of ballast tanks and IACS guidelines on coating repairs**

M. Dogliani introduced the matter ([see Items 4&5 in Appendix](#)).

A. LinoCosta gave a presentation to show where concerns and decisions stand: too many cases when coating was considered fair at SS but problems occurred just after one/two years.

N. Mikelis commented on draft amendments to Z10.1 (Rev.11) stating that the extent of annual survey is not clear; it should be limited to the affected zones, e.g. coating breakdowns, only.

M. Guyader clarified that, in this draft amendments, it is expected an overall survey of the whole tank and a close up survey of the affected zones.

N. Mikelis noted that, in the draft amendments to Z10.1 (Rev.11), the intermediate survey at 12.5 years would have the same scope as the previous special survey and that needed a justification. See 7 a).

M. Dogliani said that Z10.1 (Rev.11) was adopted in August 2003 and will be introduced into IACS Societies' Rules over the next year.

### Conclusions:

4.1 Industry shared IACS concerns on coatings and, in general, agreed with the draft amendments to Z10.1 (Rev.11) suggesting also extending them to Z10.2 on bulk carriers

4.2 Industry agreed that a guideline for surveyor on coating would greatly improve uniform application of so-amended Z10.1 including issues such as how to consider load bearing elements when judging GOOD/FAIR/POOR status and how to consider bottom pitting in connection with GOOD conditions

4.3 Industry will more precisely comment, by the end of September, the draft Z10.1 so as for IACS to finalise the matter, as planned, for the Council's December meeting.

Item	Title	Industry recommendation	IACS/ M. Dogliani Introduction
4 & 5	Annual survey of ballast tanks IACS guidelines on coating repairs	NN	<p><b>1. IACS is considering the following:</b></p> <ul style="list-style-type: none"> <li>- <b>amend UR Z10.1 (draft circulated to Industry) to the effect that in case at Special Survey or Intermediate Survey the coating in a ballast tank is found less than GOOD, either GOOD conditions are restored or the tank's coating is inspected at each annual survey;</b></li> <li>- <b>develop IACS guideline to assist an uniform application of the so modified (if adopted) UR Z10.1; the guideline should address which repairs are necessary to restore GOOD conditions from FAIR and POOR respectively and which are the criteria for the restored (after repair) situation to be rated as GOOD.</b></li> </ul>

\_\_\_\_\_ End of extract from minutes \_\_\_\_\_

INTERTANKO commented (see R. Leslie email to GPG dated 25 September 2003):

- expressing their concern for the draft Z10.1 and underlining
  - a) targeting: concerns that, if not properly dealt with, Z10.1 would target all ships and not just those which need intervention; the view was expressed that guidelines would probably solve the matter;
  - b) definition: indicating that the current definitions of GOOD, FAIR and POOR is not clear enough and that the matter would be even worst with GOOD and NON GOOD; again it was indicated that guidelines could solve the matter;
  - c) expertise: expressing doubts on IACS' surveyors expertise and ability to judge coating conditions; in this respect they (hiddenly) suggest that IACS position is unclear when we say that we are not competent to judge the coating during construction but then we are competent to judge coating during operational life. Even if not explicitly stated, the impression is that also in this case guidelines would help.

Additionally, INTERTANKO suggested a (quite detailed) set of assessment criteria.

The matter was then finally addressed at the TRIPARTITE Meeting (held in Soul on 29/30 September 2003). There Industry agreed that the way forward was the (joint) development of IACS guidelines (see minutes attached to message 3100\_RIe dated 11 October 2003, an extract of which is reproduced below).

\_\_\_\_\_ Extract from the TRIPARTITE minutes \_\_\_\_\_

Industry is concerned by the definition of GOOD/NOT GOOD in relation to coating repairs and acceptance criteria. Industry agreed that new guideline on this, which IACS is already producing, was the way forward.

\_\_\_\_\_ End of the extract from the minutes \_\_\_\_\_

### **3. Further developments**

- a) from the above, it was concluded that, provided the guidelines are sound, Industry would accept the concept of Z10.1 (draft) Rev. 12, therefore an IACS team and a JWG were established in order to progress the matter of the guidelines (among other related matters).
- b) the team of IACS experts on coating developed draft guidelines and provided recommendations to GPG on the way forward (attached to message 3095bNVc dated 20 November 2003).
- c) the guidelines were discussed within the JWG with Industry (see draft minutes circulated within GPG with messages 3095cIGd and 3095cIGe both dated 13 March 2004)
- d) further suggestions and comments (as requested at the meeting) were provided by Industry (not circulated to GPG)
- e) Bulk Carrier Industry is recommending that similar guidelines are developed in due time also for bulk carriers
- f) at DE47 and MSC78, IMO is asking Industry and IACS to develop (compulsory) performance standards for coating of newbuilding (double hull spaces of DSS Bulk Carriers), a matter which is, indirectly related to the above one.

1 June 2004

M. Dogliani

IACS GPG Chairman

IACS JWG/COR Chairman

Appendix 2 to Annex 1: [DNV proposal to Z10.1, Z10.3 and z10.4](#) ▶

Sent Monday, July 4, 2005 4:45 pm

To [Gil-Yong <gilyonghan@iacs.org.uk>](mailto:Gil-Yong <gilyonghan@iacs.org.uk>)

Cc

Bcc

Subject Fw: 1060gNVs; WP/SRC - Task 102 - Harmonization of UR Z 7 and Z 7.1

Attachments [Doc1.doc](#)

25K

----- Original Message -----

From: "Debbie Fihosy" <[debbiefihosy@iacs.org.uk](mailto:debbiefihosy@iacs.org.uk)>

To: "CCS" <[iacs@ccs.org.cn](mailto:iacs@ccs.org.cn)>

Cc: "IACS Permanent Secretariat" <[permsec@iacs.org.uk](mailto:permsec@iacs.org.uk)>

Sent: Friday, June 03, 2005 2:52 PM

Subject: FW: 1060gNVs; WP/SRC - Task 102 - Harmonization of UR Z 7 and Z 7.1

Forwarding as requested

-----Original Message-----

From: Arve.Myklebust@dnv.com [[Arve.Myklebust@dnv.com](mailto:Arve.Myklebust@dnv.com)]

Sent: 25 May 2005 15:49

To: [AIACS@eagle.org](mailto:AIACS@eagle.org); [iacs@bureauveritas.com](mailto:iacs@bureauveritas.com); [iacs@ccs.org.cn](mailto:iacs@ccs.org.cn);

[johnderose@iacs.org.uk](mailto:johnderose@iacs.org.uk); [iacs@dnv.com](mailto:iacs@dnv.com); [iacs@gl-group.com](mailto:iacs@gl-group.com);

[gilyonghan@iacs.org.uk](mailto:gilyonghan@iacs.org.uk); [helenbutcher@iacs.org.uk](mailto:helenbutcher@iacs.org.uk); [efs@iacs.org.uk](mailto:efs@iacs.org.uk);

[krsiacs@krs.co.kr](mailto:krsiacs@krs.co.kr); [richardleslie@iacs.org.uk](mailto:richardleslie@iacs.org.uk); [external-rep@lr.org](mailto:external-rep@lr.org);

[clnkiacs@classnk.or.jp](mailto:clnkiacs@classnk.or.jp); [terryperkins@iacs.org.uk](mailto:terryperkins@iacs.org.uk); [iacs@rina.org](mailto:iacs@rina.org);

[iacs@rs-head.spb.ru](mailto:iacs@rs-head.spb.ru); [colinwright@iacs.org.uk](mailto:colinwright@iacs.org.uk)

Subject: FW: 1060gNVs; WP/SRC - Task 102 - Harmonization of UR Z 7 and Z 7.1

25 May 2005

To: Mr. B. Anne, Chairman of IACS Council,

cc: Council Members, IACS Perm. Sec.

Ref.: My mail NVr dated 20 May 2005

DNV have further studied the amendments to UR Z10.1, Z10.3, and Z10.4, and as a result are presenting the following as a compromise solution:

General comment:

From the comments by other Members it is obvious that there is reluctance to accept annual surveys of ballast tanks with a common plane boundary to heated cargo tanks in the case where the coating is in good condition. This is particularly unreasonable as at the same time we enhance the Intermediate survey of Tankers between 10 and 15 years to also include examination of all ballast tanks, meaning that all ballast tanks will be close up surveyed with 2-3 years intervals from the ship is 10 years old, with the possibility for the surveyor to require thickness measurements and testing of the tanks to ensure the structural integrity of the tanks if necessary.

It is also proposed for the Intermediate survey between 5 and 10 years, to increase the scope from representative to all ballast tanks, a requirement DNV find to strict, and require that we here keep the original text.

If a ballast tank is found to have coating in GOOD condition at the renewal or intermediate survey, a deterioration of the tank beyond structural reliability is very unlikely even if the tank has a common plane boundary to a heated cargo tank.

DNV finds it particularly unreasonable to have this requirement to apply to double hull tankers for the following reasons:

- these ships have double hull and the risk of pollution is here much reduced,
- the double hull is constructed with small spaces giving improved structural reliability,
- almost all double hull tankers below VLLC have heated cargo tanks, and all ballast tanks have common plane boundaries to these tanks, meaning that this requirement will apply to a major part of the tanker fleet in the future,
- the ballast tanks of double hull tankers are so designed that a general examination of these tanks will be identical to a close up survey,
- survey of ballast tanks of double hull tankers will mean either gas freeing of all cargo tanks or at least dropping the inert gas pressure of all cargo tanks in addition to proper airing of all ballast tanks.

Since the single hull tankers will be faced out in the near future, and for clear political reasons, DNV will as a compromise proposal to keep paragraph 2.2.3.1 and 4.2.2.2 in Z 10.1 as amended by Council (ref. IAo) but amend it to not include 2.2.3.1.e, 4.2.2.2.e and last paragraph of 3.2.5.1 in Z10.3 and Z10.4. In addition we request that the original text of 4.2.2.1 is kept.

If BV, ABS and other Members can accept this DNV is willing to drop our reservation presented at C49.

DNV's proposal will then be as follows:

Z10.1:

2.2.3.1: This paragraph can be accepted as is for the reasons stated above.

3.2.5.1: This paragraph is accepted as amended.

4.2.2.2: This paragraph can be accepted as is for reasons stated above.

For other comments to Z10.1 see NVo and NVp.

Z10.3:

2.2.3.1.e to be deleted.

3.2.5.1 delete last paragraph

4.2.2.1 the original text to be kept. "For tanks used for water ballast ---"

4.2.2.2.e to be deleted

Z10.4

2.2.3.1e to be deleted

3.2.5.1 delete last paragraph

4.2.2.1 the original text to be kept, "For tanks used for water ballast --"

4.2.2.2.e to be deleted.

For details see attached document where the text for the requirements in Z10.3 and Z10.4 that DNV will accept is stated.

Best Regards

Arve Myklebust  
on behalf of  
Terje Staalstrom  
DNV IACS Council Member  
<<Doc1.doc>>

\*\*\*\*\*

Neither the confidentiality nor the integrity of this message can be vouched



Annex 2 to TB (Harmonization Z10s)

**WP/SRC Task 114 “Clarify the procedure of verification and signature of the thickness measurement report”**

Item No.	Item	ABS	BV <sup>1)</sup>	CCS	CRS	DNV	GL	IRS	KR	LR	NK	RINA	RS
<b>1</b>	<b>Verification onboard</b>												
1.1	Minimum extent of measuring points for direct verification by attending surveyor specified	No	No	No	No	No	No	No	Yes	No	No	Yes	No
1.2	Preliminary TM record to be signed upon completion of the measurements onboard	Yes	Yes <sup>7)</sup>	Yes	No (copy taken)	No <sup>3)</sup>	No <sup>6)</sup>	Yes	Yes	Yes	Yes	No <sup>8)</sup>	No
<b>2</b>	<b>Final TM report</b>												
2.1	Signature of all pages in TM record required	No	No	No	Yes	No	Yes	Yes	No	No	No <sup>5)</sup>	Yes	Yes
2.2	Signature of ‘cover’ (‘general particulars’) page only	Yes	Yes	Yes	No	Yes	No	No	No <sup>4)</sup>	Yes	Yes	Yes	No
2.3	Measuring points verified by attending surveyor required identified in TM record and signature of the corresponding pages required	No	No	Yes Without signature	Yes	No	No	No	Yes	No	No	No	No

2004-04-20

<sup>1)</sup> Instructions not clear regarding signature of the thickness measurement record

<sup>2)</sup> Signature on front and last page, stamp on all other pages, or signature on each page (IACS TM forms)

<sup>3)</sup> Upon completion of measurements onboard a draft report in electronic format (DNV TM template, including operator’s notes as relevant) to be given to attending surveyor

<sup>4)</sup> Signature of cover page, pages of meeting record and pages of attended measuring points

<sup>5)</sup> Each page to be signed in case of ‘loose-leaf’ type record

<sup>6)</sup> Preliminary TM record has to be passed to the Surveyor, signed by the Operator

<sup>7)</sup> The only measures which the Surveyors can certify exact are those for which that they have seen the results on the screen of the apparatus. That means in fact few points in comparison with the numbers of recorded measures.

<sup>8)</sup> The Surveyor reviews the TM record for completeness and assessment of TM readings, but no signature required.

UR Z7s and Z10s (Corrosion Prevention System)

1. Objective:

To clarify whether the survey of anodes is a class matter, and if so, whether acceptance criteria for anode should be developed.

2. Method: GPG by correspondence (5037\_)

3. Discussion

3.1 BV initiated GPG discussion as follows:

Paris La Défense, 8 Mars 05

1 - We have noticed that, in the draft UR Z's ( 7.1, 10.1 to 10.5) issued further to the WP/SRC Task 102, the original sentence ".....the examination may be limited to a verification that the hard protective coating remains efficient....." has been replaced by ....that the corrosion prevention system remains efficient....". in a number of paragraphs (such as , for instance, Z 7.1, 4.2.3.1 a) ; Z 10.2 4.2.3.3 ; ), in line with IMO Res.A744(18).

2 - However, a corrosion prevention system is defined, in the same UR Z's and in IMO Res.A744(18) , as being either a full hard protective coating or a full hard protective coating supplemented by anodes.

3 - The above would mean that the survey of the anodes is a classification matter.

4 - However, whereas coating conditions are defined as good or fair or poor, there are no criteria in the IACS URs and IMO Res. A744(18) for the anodes condition.

5 - Assessing the anodes condition to confirm that they "remain efficient" looks to BV to be a quite difficult task for the ships in service Surveyor.

6 - Member's view and interpretations on the following would consequently be appreciated:

- do Members consider that the above requirements in IACS URs imply that survey of anodes is part of the classification ?
- do Members consider that the above requirements in IMO Res. A 744 (18) imply that survey of anodes is mandatory?
- if yes, what is the acceptance criteria to conclude that the anodes" remain efficient" ?

3.2 The majority of GPG Members replied that they did not include requirements for anodes in their class rules.

LR / ABS / DNV / KR / NK / RINA / RS were of the view that the condition of any anodes fitted should be recorded for information purposes as the survey of anodes is neither a classification matter nor a mandatory requirement in IMO A.744(18) and has no impact on future surveys (5037\_LRa). [Note; LR further clarified that "Whilst I agree that the performance of anodes is not normally a class matter LR does require that as part of Special Survey on oil tankers : "The attachment to the structure and condition of anodes in tanks are to be examined ." Therefore we cannot say that 'the survey of anodes is not a classification matter'. 5037\_LRb]

However, GL said that “for GL, anodes are a matter of class and as such are subject to plan approval as well as surveys. In case of missing or worn-out anodes we issue a condition of class”(5037\_GLa&b).

CCS advised that its rules have a general requirement relating to anode survey, which is only conducted, through sampling, during construction, docking survey or where there is a definite requirement for the survey of ballast tanks.

NK proposed that the following footnote be added to Z7s and Z10s:  
“The survey of anodes is not a classification matter.” No majority support was achieved.

#### **4. Conclusion**

RINA suggested to simply amend the definition of "Corrosion Prevention System" in paragraph 1.2.9 of UR Z7 (and, of course, the paragraphs in all the other UR Zs containing the definition of "Corrosion Prevention System") in order to eliminate any reference to anodes. This proposal would leave room for Societies willing to include additional class requirements for anodes to do so in their Rules.

GPG agreed.

### **RINA proposed amendments to paragraph 1.2.9 of UR Z7 and corresponding paragraphs in all other UR Zs (5037\_RIb, 6 April 2005)**

#### 1.2.9 Corrosion Prevention System

A corrosion prevention system is normally considered ~~either: a full hard protective coating, or~~  
~~1 a full hard protective coating, or~~  
~~2 a full hard protective coating supplemented by anodes.~~

Hard protective coating is usually to be epoxy coating or equivalent. Other coating systems may be considered acceptable as alternatives provided that they are applied and maintained in compliance with the manufacturer's specifications.

Where soft coatings have been applied, safe access is to be provided for the surveyor to verify the effectiveness of the coating and to carry out an assessment of the conditions of internal structures which may include spot removal of the coating. When safe access cannot be provided, the soft coating is to be removed.

[Annex: Council Chair's conclusive message.](#)

6 May 2005  
Permsec

## **Annex. (5037\_ICb, 15 May 2005)**

To : All IACS Council Members  
c.c : Mr. R. Leslie, IACS Permanent Secretariat

Ref. Mr G-Y. Han's message IAa dated 6 May 05  
Message ICa dated 6 May 05  
Admiral R.E. Kramek's message ABb dated 13 May 05

Paris La Défense, 15 May 05

- 1 - All Members have agreed with the texts attached to Mr Han's message.
- 2 - Further to ABS comments the reference to anodes is to be deleted in Annex I and in tables IX (IV) and IX(II).
- 3 - further to ABS questions regarding what IACS plan to do regarding IMO and A.744(18) further to IACS deletion of reference to anodes from the UR Z7's and UR Z10's it is to be noted that:

The Item 1.2.9 in UR Z10.1 and relative items in these URs states  
*1.2.9 10 Corrosion Prevention System: A corrosion prevention system is normally considered either:*

- .1 a full hard protective coating, or*
- .2 a full hard protective coating supplemented by anodes.*

*Hard Pprotective Ccoating is to usually to be epoxy coating or equivalent. Other coating systems may be considered acceptable as alternatives provided that they are applied and maintained in compliance with the manufacturer's specification.*

*Where Soft Coatings have been applied, safe access is to be provided for the surveyor to verify the effectiveness of the coating and to carry out an assessment of the conditions of internal structures which may include spot removal of the coating. When safe access cannot be provided, the soft coating is to be removed.*

- therefore the anodes are not considered as the main means of protection against the corrosion It is only a supplement;
- there is no provision in UR Z7's and Z10's to evaluate the level efficiency of the anodes;
- there is no specific requirements in case of lack of efficiency of the anodes.

The experience has shown that ballast tanks only protected by anodes are subject to corrosion when the anodes are becoming less efficient.

The anodes are active only when immersed by sea water. Therefore the upper part of the ballast tanks are not protected when the ballast is full of water and the ballast is not protected when it is empty..

The ships operators are reluctant to replace the anodes especially in upper part which request fitting of scaffolding fo welding the anode supports to the structure.

[The above arguments justify the reasons why IACS consider that the anodes are not class item.](#)

[4 - These arguments can be used by IACS Members](#) attending the WG bulk carriers at MSC 80 to try to obtain deletion of the reference to anodes in A. 744(18).

Best regards,

Bernard Anne  
IACS Council Chairman.

## **Technical Background**

**UR Z10.1(Rev.13, Jan 2006)**

**UR Z10.2(Rev.18, Jan 2006)-separate TB**

**UR Z10.3(Rev.8, Jan 2006)**

**UR Z10.4(Rev.3, Jan 2006)**

**UR Z10.5(Rev.2, Jan 2006)**

**Part 1. Z10s – para. 1.4 and 7.1.3**

**Part 2. Z10s – para. 5.5.4 and 5.5.6**

**Survey Panel Task 22 – Amend applicable URZ7s and Z10s to align Close-Up Survey and Thickness measurements to be carried out at the same time and location allowing for a more structured control of the thickness measurement process.**

**Technical Background**

**Z7(Rev.12)**

**Z7.1(Rev.3)**

**Z10.1(Rev.13, para.1.4 & 7.1.3)**

**Z10.2(Rev.18, para. 1.4 & 7.1.3)**

**Z10.3(Rev.8, para. 1.4 & 7.1.3)**

**Z10.4(Rev.3, para. 1.4 & 7.1.3)**

**Z10.5(Rev.2, para. 1.4 & 7.1.3)**

**1. Objective**

To amend the applicable URZ7s and Z10s to align Close-Up Survey and Thickness measurements to be carried out at the same time and location allowing for a more structured control of the thickness measurement process.

**2. Background**

IACS QC findings, through audits of numerous Societies, which indicated concerns over Surveyor attendance and control of thickness measurement processes.

**3. Methodology of Work**

Survey Panel members through correspondence.

**4. Discussion**

To align Close-up survey requirements and thickness measurements in the applicable URZ7s and URZ10s, in accordance with PR19, all Panel members agreed through correspondence and a final vote at the fall Survey Panel meeting, that URZ7, Z7.1, Z10.1, Z10.2, Z10.3, Z10.4 and Z10.5 should include in the applicable sections of the noted URs as proposed by the Survey Panel the wording “ In any kind of survey, i.e. special, intermediate, annual, or other surveys having the scope of the foregoing ones, thickness measurements of structures in areas where close-up surveys are required, shall be carried out simultaneously with close-ups surveys.”

**5. Implementation**

The Survey Panel is of the view that the Members need 12 months from the adoption date to implement these amendments into their class rules. Assuming that GPG and Council approve to the amendments, the Survey Panel would propose January 2007 as an implementation date.

## **Technical Background**

**UI SC 191 (Rev.2, Oct 2005)**

**&**

**UR Z10.1 (Rev.13, para.5.5.4 and 5.5.6, Jan 2006)**

**UR Z10.2 (Rev.18, para. 5.5.4 and 5.5.6, Jan 2006)**

**UR Z10.3 (Rev.8, para.5.5.4 and 5.5.6, Jan 2006)**

**UR Z10.4 (Rev.3, para.5.5.4 and 5.5.6, Jan 2006)**

**UR Z10.5 (Rev.2, para.5.5.4 and 5.5.6, Jan 2006)**

### **1. Objective**

- to confirm whether the guidelines for approval/acceptance of alternative means of access (now REC91, ex Annex to UI SC191) is mandatory or non-mandatory.
- to consider other safety related proposals.

### **2. Background**

The DNV proposal to submit the UI SC191(Rev.1, May 2005, Annex 1) to IMO DE49 triggered a number of discussion points that led to amendments to the following resolutions:

UI SC191(Rev.2)  
New REC 91  
REC 39(Rev.2)  
UR Z10s

### **Points of Discussion**

3. Is the Annex to UI SC191(Rev.1, May '05, guidelines for approval / acceptance of alternative means of access) mandatory or non-mandatory ?

Answer: Non-mandatory. Hence, re-categorized as new REC 91.

4. Limitation of use of rafts in bulk carrier holds

DNV proposed that conditions for rafting should be limited to areas, such as anchorage or harbour, where swell conditions are limited to 0.5m. After discussion, GPG approved the ABS' alternative proposal to use the swell condition as a basis to determine the appropriateness of rafting, instead of geographic areas(harbours or anchorage). 5.5.4 of Z10.2 refers.

RINA proposed that para 5.5.4 should be included in all the Z10s. NK's objection is recorded as follows (3037hNKq, 29/08/2005):

1. With regard to RIm of 26 August 2005, NK considers that the proposed amendment to 5.5.4 should be limited to UR Z10.2.
2. Rafting survey for tankers are actually carried out on the open sea from a discharge port to a loading port and in such situation the rise of water within the tanks would always exceed 0.25m. It is different situation from rafting survey for hold frames of bulk carriers normally conducted in a harbour or at an anchorage.
3. If the same requirement applies to tankers, any rafting survey for cargo oil tanks and ballast tanks of tankers would be prohibited. This is not practicable under present survey procedure for tankers.
4. Therefore, NK can not support Laura's proposal that the proposed amendment to 5.5.4 of UR Z10.2 is introduced into the other URs and new Recommendation.

For compatibility with the IMO's mandatory requirements\*, GPG decided to add the same amendment to all the UR Z10s.

\*

- Appendix 4 to MEPC.99(48) 'Mandatory requirements for the Safe Conduct of CAS Surveys'
- MSC.197(80) – amendments to A.744918), Annex A for DSS and SSS bulk carriers and Annex B for single and double hull oil tankers.

As a consequence, 5.5.1 of REC 91(ex Annex to UI SC191) was also amended:

- to remove the reference to dynamic /sloshing (as the 0.25m rise was considered negligible);
- to refer to the rafting conditions contained for cargo holds in Z10.2 and Z10.5 and for oil cargo tanks in Z10.1 and Z10.4.

5. Means of access from longitudinal permanent means of access within each bay to rafts

GPG reviewed the proposal that the following text be added to Z10s:

[A means of access to the longitudinal permanent platform from rafts or boats is to be fitted in each bay.](#)

(Technical Background: for the safety of surveyors)

There may be ships which are arranged in accordance with para b, page 8 of the Annex to the current SC 191 (i.e., no means of access from the LPMA in each bay to a raft is required) and therefore could not be rafted if the sentence proposed by RINA ("[A means of access to the longitudinal permanent platform from rafts or boats is to be fitted in each bay](#)") is included in the Z10's.

GPG therefore agreed not to include this sentence in Z10s.

For the same reason, the same sentence was not added to Rec.39.



Finally, GPG added the following sentence to UI SC191(interpretation for II-1/3-6):

*A permanent means of access from the longitudinal platform to the water level indicated above is to be fitted in each bay (e.g permanent rungs on one of the deck webs inboard of the longitudinal permanent platform).*

## **6. Implementation**

It was agreed that the revised UI SC191 be implemented to ships contracted for construction 6 months after adoption by Council.

UI SC191 was also edited in line with IMO MSC/Circular. 1176, leaving its mandatory language (is/are to, shall) unchanged.

(Note: UI SC191(Rev.2) makes references to the following new Recommendations:

- REC 90: Ship Structure Access Manual
- REC 91: Guidelines for approval/acceptance of Alternative Means of Access)

23 September 2005  
Permanent Secretariat  
Updated on 13 Oct 2005.

## **Technical Background**

### **UR Z10.1 (Rev.14), UR Z10.2 (Rev.23), UR Z10.4 (Rev.5) & UR Z10.5 (Rev.5)**

#### **Survey Panel Task 3 – Maintenance of Alignment/ Compatibility of IACS URs and IMO survey requirements**

##### **1. Objective**

Maintenance of alignment/compatibility of IACS URs and IMO survey requirements regarding resolution MSC 197(80) – amendments to A744(18)

##### **2. Background**

IMO survey requirements to ESP vessels as amended in A744(18) as noted in MSC 197(80), with an implementation date of 1 January 2007.

##### **3. Methodology of Work**

Survey Panel members through correspondence.

##### **4. Discussion**

Survey Panel members, at the fall 2006 Survey Panel meeting, finalized the amendments to the applicable URs due to changes adopted at MSC(80). Additionally, Members noted that URZ10.4 paragraphs 2.2.3.1 and 4.2.2.2 does not require examination of ballast tanks adjacent to heated fuel tanks, as required by MSC197(80). The survey panel agreed that if this is the position that IACS would like to take regarding double hull tankers, then it should be brought to the attention of IMO at the next IMO meeting, DE50 in March 2007.

##### **5. Implementation**

The Survey Panel is of the view that the Members need 12 months from the adoption date to implement these amendments into their class rules. Assuming that GPG and Council approve the amendments, the Survey Panel would propose January 2008 as an implementation date, although the IMO implementation date is January 2007.

Submitted by Survey Panel Chairman  
9 January 2007

##### **GPG discussion**

All members agreed to omit the requirement of examination of ballast tanks adjacent to heated fuel tanks, as required by MSC197(80), from URZ10.4 for double hull tankers and

that it should be brought to the attention of IMO at DE50. In addition ABS proposed that paragraphs relating to similar requirements in URZ10.1 should also be deleted for consistency and this was agreed by members.

Members also made a number of minor/editorial corrections to the text prior to their approval of the revised documents.

Added by Permanent Secretariat  
23 April 2007

## **Technical Background**

**URs Z7(Rev.15), Z7.1(Rev.5), Z7.2(Rev.1), Z10.1(Rev.15),  
Z10.2(Rev.26), Z10.3(Rev. 9), Z10.4(Rev.6), Z10.5(Rev.8) – November  
2007**

### ***Survey Panel Task 1 – Annual Review of Implementation of IACS Resolutions***

#### **1. Objective**

To review IACS Resolutions annually and discuss or propose amendments as deemed necessary.

#### **2. Background**

This proposed amendment to all URZ7s and URZ 10s was raised by the Panel member from DNV due to Owners crediting tanks concurrently under intermediate and special survey.

#### **3. Methodology of Work**

Survey Panel members through correspondence.

#### **4. Discussion**

The Panel member from DNV raised the issue of Owners having the ability of crediting spaces and thickness measurements only once in a 54 month interval, due to the availability of concurrent crediting of spaces and thickness measurements due to the flexible time window that is currently allowed between the intermediate survey and the special survey.

After a presentation and discussion lead by the DNV Panel member, all Survey Panel members agreed to the argument given by DNV, and further agreed to make the necessary changes in all URZ7s and URZ10s where Owners are not allowed to concurrently credit surveys and thickness measurements of spaces.

#### **5. Implementation**

The Survey Panel is of the view that the Members need 12 months from the adoption date to implement these amendments into their class rules. Assuming that GPG approve to the amendments, the Survey Panel would propose January 2009 as an implementation date.

Submitted by Survey Panel Chairman  
22 October 2007

**Permanent Secretariat note (December 2007):**

During GPG discussion DNV proposed that *“since this matter will be discussed between Owner and Class mainly in connection with the forthcoming Special Survey, DNV would prefer to locate this text, not only as part of Intermediate Survey, but also as a new text for the Special Survey.”* This was supported by BV, ABS, RINA and KR.

The revised documents were approved, with DNV’s proposal and an implementation date of 1 January 2009, on 15 November 2007 (ref. 7690\_IGb).

## Technical Background

### URs Z7(Rev.16), Z7.1(Rev.6), Z7.2(Rev.2), Z10.1(Rev.16), Z10.2(Rev.27), Z10.3(Rev.11), Z10.4(Rev.7) and Z10.5(Rev.9) - March 2009

#### Survey Panel Task 62:

- A) *Harmonization of UR Z10.1, Z10.2, Z10.4 and Z10.5 with UR Z10.3 with respect to items 5.5.4.4 and 5.6.2.*
- B) *Harmonization of UR Z7, Z7.1, Z10.1, Z10.2, Z10.3, Z10.4 and Z10.5 with UR Z7.2 with respect to the definition of the corrosion prevention system and with respect to the footnote 1 related to semi-hard coatings.*
- C) *Harmonization of the definition of Ballast Tank in UR Z7(Rev.14)*

### 1. Objective

- A) Amend the texts of items 5.5.4.4 and 5.6.2 in Unified Requirements Z10.1, Z10.2, Z10.4 and Z10.5 in order to align them with those in UR Z10.3, in which they were changed while performing Task 55, whereas in the other UR Z10s they were kept unchanged on the grounds that this change was out of the scope of Task 55.
- B) Amend the definition of “Corrosion Prevention System” and include a Footnote 1 related to semi-hard coatings in Unified Requirements Z7, Z7.1, Z10.1, Z10.2, Z10.3, Z10.4 and Z10.5 in order to align them with those adopted in UR Z7.2, when this new UR was issued.
- C) Amend UR Z7 (Rev. 14) in all items where the term “Ballast Tank” is used in order to get them harmonized with the definition itself.

### 2. Background

The task, as regards item A), was triggered by a Member Society, while performing Task 55, on the grounds that this part was out of the scope of the task and then should have been dealt with in a separate task.

The task, as regards item B), was triggered as a consequence of the “New Business action item 2” of the Minutes of the September 2008 Survey Panel meeting, for sake of harmonization of the various URZs.

The task, as regards item C), was triggered as a consequence of the “Task 54-Examination of Double Bottom Ballast Tanks at annual surveys” of the Minutes of March 2008 Survey Panel meeting, for sake of harmonization of the definition of Ballast Tank in UR Z7(Rev.14).

### 3. Discussion

The task was carried out by correspondence. All the amended texts for the affected URs were prepared by the Survey Panel Member who had chaired the PT on Task 55, in accordance with the Form A approved by GPG. In addition to the objectives outlined in the Form A, an amendment was added to item 1.3.1 of UR Z10.2 and UR Z10.5 in which the reference 3.2.3.6 in the last item of the list was replaced by 3.2.3.10 as can be correctly verified in the text.

The amended URs were circulated to all Survey Panel Members for review, comments and agreement. The texts of the URs were unanimously agreed by all Members.

#### **4. Implementation**

The Survey Panel is of the view that the Member Societies need at least 12 months from the adoption date to implement these amendments into their class rules/procedures. Therefore, in the first version of all amended URs the following implementation sentence should be proposed:

*Changes introduced in Rev .xx are to be uniformly applied by Member Societies and Associates for surveys commenced on or after [not less than 12 months after the adoption by GPG/Council].*

Since it is common practice and convenience to have implementation dates either on 1<sup>st</sup> January or on 1<sup>st</sup> July of the year, the Survey Panel proposes the 1<sup>st</sup> July 2010 as implementation date, if GPG/Council approve the URs not later than 30 June 2009.

**Submitted by Survey Panel Chairman  
28 February 2009**

#### **Permanent Secretariat notes (April 2009):**

1. The amended URs were approved by GPG on 18 March 2009 (ref. 7718bIGd).
2. During the typesetting process it was noted that para 5.1.5 of UR 7.2 was inconsistent with the amended URs and so following consultation with the Survey Panel this was also amended at this time.
3. Regarding the implementation date, GPG agreed to use 1<sup>st</sup> July 2010 provided that it was consistently used for the amended URs.

## **Technical Background document for UR Z10.1 Rev.17 (Feb 2010)**

### **1. Scope and objectives**

To amend UR Z10.1 (Rev.16) for the harmonization with currently revised MARPOL Annex I.

### **2. Engineering background for technical basis and rationale**

-

### **3. Source/derivation of the proposed IACS Resolution**

- MARPOL 73/78
- IACS UR Z10.1 (Rev.16)

### **4. Summary of Changes intended for the revised Resolution:**

As MARPOL I was revised, the reference to MARPOL I/13 (3) in paragraph 1.2.2bis should read MARPOL I/18(3).

### **5. Points of discussions or possible discussions**

None

### **6. Attachments if any**

N/A



## **Technical Background for UR Z10.1 Rev.18 (Mar 2011)**

### **1. Scope and objectives**

- 1) To amend UR Z10.1 to harmonize the definition of transverse section.
- 2) Update of references in the Executive Hull Summary Table IX.

### **2. Engineering background for technical basis and rationale**

- 1) Based on that fact that bulk carriers and oil tankers have a transverse framing system applied for example on ship's sides etc. and that UR Z7 is applied to all types of ships and includes an extended definition of transverse section it is necessary to unify this definition in UR Z10s.
- 2) Update of references in the Executive Hull Summary Table IX such that the introduction of extended annual surveys is noted in the 'Memoranda' section rather than under 'Conditions of Class'.

### **3. Source/derivation of the proposed IACS Resolution**

IACS UR Z7.

### **4. Summary of Changes intended for the revised Resolution:**

- 1) The following additional text is added to the definition of transverse section in para 1.2.5:

*"For transversely framed vessels, a transverse section includes adjacent frames and their end connections in way of transverse sections."*

- 2) In the Executive Hull Summary Table IX (iv) the reference to part H) is updated to part I) as per Table IX (ii).

### **5. Points of discussions or possible discussions**

None.

### **6. Attachments if any**

None.

## **Technical Background for UR Z10.1 Rev.19, July 2011**

### **1. Scope and objectives**

Review the requirement for repairs within IACS UR 7 and UR 10 series, in particular the requirement for Prompt and Thorough Repair, with a view to developing wording that would permit a temporary repair and the imposition of a Recommendation/ Condition of Class under specific and controlled circumstances, and in accordance with PR35.

### **2. Engineering background for technical basis and rationale**

There are instances, for example a localised, isolated and very minor hole in a cross-deck strip, at which a suitable temporary repair, for example by welding or doubling, and the imposition of a suitable short term Recommendation/ Condition of Class for permanent repair at a later date, are considered very adequate methodology for dealing with the defect.

Current IACS Requirements in the UR Z7 and Z10 series, for Prompt and Thorough repair, would not permit this to be an option, the defect would have to be permanently Promptly and Thoroughly repaired, which might require removing cargo, moving to a repair berth and staging inner spaces.

Under the Requirements of IACS Procedural Requirement PR 35 the methodology of Temporary Repair and imposition of a suitable short term Recommendation/ Condition of Class for permanent repair at a later date is fully permissible.

### **3. Source/derivation of the proposed IACS Resolution**

Based upon discussion within the IACS Survey Panel.

### **4. Summary of Changes intended for the revised Resolution:**

Following the definition of Prompt and Thorough Repair in the Unified Requirement, a new paragraph is proposed to be added:-

"1.3.3 Where the damage found on structure mentioned in Para. 1.3.1 is isolated and of a localised nature which does not affect the ship's structural integrity, consideration may be given by the surveyor to allow an appropriate temporary repair to restore watertight or weather tight integrity and impose a Recommendation/Condition of Class in accordance with IACS PR 35, with a specific time limit."

### **5. Points of discussions or possible discussions**

a) The points of discussion are as indicated in Sections 2 and 4 above.

b) Discussion took place on whether to prepare this amendment as a Unified Interpretation of IMO Resolution A.744(18)/UR Z7 and Z10 series, finally it was agreed to make direct amendment to the relevant URs.

c) It is proposed that this amendment be submitted directly to the IMO DE/MSC Committees for consideration of amending directly IMO Res. A744(18)

**6. Attachments if any**

None

## **Technical Background for UR Z10.1 Rev.21, Jan 2014**

### **1. Scope and objectives**

- a) To consider appropriate text in IACS document regarding class period for lengthy conversions.
- b) To align the requirements in PR37 and UR Z10s regarding safe entry to confined spaces.

### **2. Engineering background for technical basis and rationale**

- a) As per the IMO Res. A1053 (27), lengthy conversions (not necessarily of major character) or other major repair work can be assigned for a 5 year period from the date of completion of conversion/repairs/surveys.
- b) Safety requirements in IACS PR37 can be applied to carry out survey in safe way for all kind of ships. When there are no indications about the safety of surveyor in UR Z10s then the requirements in PR37 shall be applied.

### **3. Source/derivation of the proposed IACS Resolution**

None

### **4. Summary of Changes intended for the revised Resolution**

- a) Following additional text was included to section 2.1.3 to clarify the class period for lengthy conversions

"In cases where the vessel has been laid up or has been out of service for a considerable period because of a major repair or modification and the owner elects to only carry out the overdue surveys, the next period of class will start from the expiry date of the special survey. If the owner elects to carry out the next due special survey, the period of class will start from the survey completion date."

- b) Existing Section 5.2.6 and 5.2.7 were deleted from UR Z10s since provisions of these sections were covered by PR37. Reference of PR37 was included in Section 5.2.1.1.

### **5. Points of discussions or possible discussions**

- i) Additional text to Para.2.1.3 was discussed in order to clarify class period.
- ii) Panel considered that safety of surveyors should be dealt by PR37.

### **6. Attachments if any**

None

**Technical Background Document  
WP/SRC – Trilateral Discussions  
UR Z 10.1 – Proposed Rev. 6**

**Objective and Scope:**

WP/SRC was tasked to consider OCIMF/INTERTANKO proposals to amend the Enhanced Survey Program.

**Source of Proposed Requirements:**

WP/SRC members discussed and reviewed the proposals extensively through correspondence and their meeting.

**Points of Discussion:**

WP/SRC unanimously agreed to the proposed draft UR Z 10.1. Consensus could not be achieved on any of the other OCIMF/INTERTANKO proposals. Refer to the Chairman's letters to GPG dated 4 February 1999 and 11 March 1999.

## Technical Background for Rev. 6.1, Z10.1

### 1. Scope of objectives

Revise the paragraph 2.2.1.3 to clarify that piping on deck is to be examined.

### 2. Points of discussions or possible discussions

- Before the ESP tripartite group meeting in October 1999, it was agreed to change the para. 2.2.1.3 by inserting "Cargo piping on deck, and" at the beginning of the sentence.

The change from ".....under working CONDITIONS" to "....under working pressure" was made in the last set of amendments of Z10.1--and was considered to have the same meaning as OCIMF's proposed "...to working pressure." We are agreeable to changing "under" to "to".

- However, after the ESP technical working group meeting in October 1999, it was agreed to change the para:  
Cargo piping ondeck, including COW piping, all piping systems within.....

### 3. Source/deviation of proposed requirements

The final minutes of the ESP Working Group meeting reads:

The agreement already reached on piping in tanks was reaffirmed. It was reported by the Chairman of the Working Group, Mr. Bourneuf, that the IACS Council agreed to include cargo piping on deck as per UR Z10.1 para. 2.2.1.3 herein after attached. It was confirmed by IACS, at the request of the Working Group that cargo piping does include COW piping.

Prepared by the IACS Permanent Secretariat

## Technical Background Document

### UR Z10.1 – Revision 7 For ExCM decisions

#### Objective and Scope:

Revise UR Z10.1 to introduce ExCM (Extraordinary Council Meeting in Feb 2000) decision to UR Z10's

- ExCM FUA 2-1: All ballast tanks adjacent to cargo tanks with heating coils shall be examined internally on an annual basis after the ship has reached 15 years of age.
- ExCM FUA 2-2: Intermediate surveys of ships subject to ESP, which are over 15 years of age, will be enhanced to the scope of the preceding special survey with dry docking or under water survey as applicable.

#### Source of Proposed Requirements:

The proposed requirements were developed by WP/SRC Chairman, shortly after GPG 48<sup>th</sup> meeting:

- The para. 3.2.5.2 for ExCM FUA 2-1:
- The para. 4.2.2, 4.2.3 & 4.2.4 for ExCM FUA 2-2.
- The para. 7.1.1 for compatibility with the PR 19 (ABS GPG suggested).

#### Points of Discussion:

-

#### Unresolved Comments:

-

#### Discussions:

WP/SRC Chairman, when submitting draft revision to GPG, raised the following concerns:

- What tanks are required by the term "ADJACENT" ?  
WP/SRC Chairman said that tanks with a common line boundary have not been a problem since there is very little transfer of heat and should not be included.  
GPG exchanged views on this point and agreed to delete the wording "or line" from the para. 3.2.5.2 which reads: Oil Tankers exceeding 15 years of Age: All Ballast Tanks adjacent to (i.e., with a common plane ~~or line~~ boundary) a cargo tank with heating coils is to be examined internally.
- Ships using heating coils in cargo tanks  
Most existing single hull crude oil carriers only use heating coils in the slop tanks which usually do not have ballast tanks as boundaries. White oil product carriers do not need heating and therefore they should not be included in additional annual survey requirements for ballast tanks. Majority of GPG Members agreed.

Submitted by the Permsec  
On 18 Sept 2000

**Technical Background Document**  
**WP/SRC Task 77**  
**UR Z7 – Proposed Draft Revision 7**  
**(Including Rev.8 of Z10.1, Rev.11 of Z10.2, Rev.4 of Z10.3)**

**Objective and Scope:**

Extend the requirements for permanent repairs at the time of survey in UR Z 10.2 to all ships.

**Source of Proposed Requirements:**

The proposed requirements were developed by WP/SRC members through correspondence and discussions at the September 2000 meeting.

**Points of Discussion:**

UR Z7 was amended to apply “prompt and thorough” repairs to all vessels. The new wording defines a prompt and thorough repair to be a repair as a result of wastage and not an incident such as contact damage where a temporary repair or deferral of repairs could be permitted. This wording is more explicit than the wording in UR Z10.2 and should achieve a uniform application among the Members.

WP/SRC also agreed to include these requirements in Z10.1, Z10.2 and Z10.3 in order to not effect A.744(18).

WP/SRC unanimously agreed to the draft UR.

Note by Permsec

GPG 49 (11-13 Oct. 2000) agreed that the same changes be introduced to Z10's and carried out editorial review of Z 10's.



**Technical Background Document**  
**WP/SRC Task 75**  
**UR Z10.1 – Proposed Draft Revision 8**  
**&**  
**Z10.3 – revision 4**

**Objective and Scope:**

Develop a definition of 'related piping' as contained in UR Z10.1 and requirements for survey.

**Source of Proposed Requirements:**

The proposed requirements were developed by WP/SRC members through correspondence.

**Points of Discussion:**

The proposal limits the definition of "related piping" to the piping systems which require testing. This will not include hydraulic oil piping for remote control valves or anchor/mooring equipment which OCIMF may have wanted included. WP/SRC feels that related piping systems are those that are unique to an oil carrier and was the original intent of the wording.

WP/SRC unanimously agreed to the draft UR.

**Note by the Permsec:**

LR GPG proposed to change Z10.1 as follows:

“piping systems for the handling of cargo / cargo residues and water ballast and additionally bilge systems in combination carriers. 8220iLRa, 30/8/2000”

GPG Chairman asked WP/SRC to discuss LR's proposal to include “bilge piping systems” in Z10.1 at their 2000 September meeting.

WP/SRC Chairman reported back to GPG on 22 September 2000 as follows:

1. "Cargo piping" adequately covers and is understood by all members to include cargo stripping piping, just as "Ballast piping" includes ballast stripping piping.
2. WP/SRC is of the opinion that bilge piping on combination carriers should not be added to the proposed revision due to the fact that it is a separate system which usually run through a pipe tunnel and is not hydro tested at new construction. The system also operates on a vacuum and is blanked off when oil is carried.

Therefore, WP/SRC maintains its agreement that the previously submitted text is the preferred by all members.

GPG agreed that a similar amendment be made to Z10.3.

Based on the above discussion at GPG level, the revised of Z10.1 and Z10.3 was finally approved at GPG 49.

Submitted by WP/SRC Chairman

On 27 July 2000

(This view was shared by the majority of GPG Members, however, it has not been codified in Z 10.1 because no need was identified to prescribe it as a Unified Requirement.)

- Identify tanks with heating coils

WP/SRC Chair said that the vessel's survey status does not tell us tanks fitted with heating coils.

- Coating Condition and Substantial Corrosion Survey Requirements

Ballast tanks with poor coating, no coating or substantial corrosion identified at a previous survey already requires annual survey. With enhanced intermediate survey, all ballast/cargo tanks will be examined and gauged at special/intermediate survey and coating condition & substantial corrosion should be identified at that time. If coating condition is reported good or fair, it may be adequate to only verify the coating condition at annual survey of ballast tanks adjacent to cargo tanks fitted with heating coils.

In addition, DNV and LR (GPG) proposed the following additions:

- The 3<sup>rd</sup> sentence in para. 3.2.5.2 (DNV):

"Tanks or areas where coating was found to be in GOOD condition at the previous intermediate or special ~~internal examination~~ are to survey may (ABS' comment) be specially considered by the Classification Society."

The majority GPG agreed.

- The second half of the para. 4.2.4.1(LR)

"except that testing of cargo and ballast tanks is not required unless deemed necessary by the attending surveyor."

The majority GPG agreed.

- The paragraph 7.1.1 of Z10.1 and Z10.3, paragraph 8.1.1 of Z10.2 were revised for their compatibility with the PR 19 "PR for Thickness Measurement".

-----

Submitted by the Permsec  
On 18 Sept 2000

## Technical Background for

**Rev.8.1, Z10.1**

**Rev.11.1, Z10.2**

**Rev.4.1, Z10.3**

(21 June 2001)

### 1. Scope of objectives

Revise section 2.3.1 for clarity.

### 2. Points of discussions or possible discussions

- BV GPG member proposed to revise section 2.3.1 of Z10s on 12 June 2001 (0065j)
- IACS Council considered the ambiguity of the sentence in Special Survey section 2.3.1 "For Fuel Oil Tanks the necessity for the Overall Survey is to be determined based on the ship's age" in the context of its application at intermediate surveys on ships over 15 years. Council agreed that the overall survey of low corrosion risk tanks such as fuel oil, lube oil and fresh water tanks could be subject to special consideration as already addressed in section 2.2.5 of UR Z7 and therefore amended the first sentence of 2.3.1, accordingly, and deleted the last sentence of 2.3.1.
- Adopted on 21 June 2001.

\* \* \* \* \*

**Technical Background Document**  
**WP/SRC Task 87**  
**Amend Z10.1&10.2 to reflect changes introduced to Res A.744 by MSC 73**  
**(Z10.1, Rev.9) + (Z10.2, Rev.12) + (Z10.3, Rev.5)**

**Objective and Scope:**

To harmonise IACS UR Z10.1 and Z10.2 with IMO Res A744(18), as previously amended and as amended by IMO MSC105(73) and MSC 108(73).

These amendments enter into force 1 July 2002.

It was assumed by WP/SRC that the intention of GPG has been to revise UR Z10.3 (chemical tankers) as well with respect to the intermediate dry-docking requirement, but not to include the requirement to evaluation of longitudinal strength.

In addition, the relevant changes to UR Z10.1 based on the changes introduced in IMO Res A744(18) as reported in MSC 74/24/Add1-Annex 17 have been included. These were based on IACS submission DE 44/13/1. These amendments will enter into force 1 January 2004 subject to IMO tacit acceptance procedures.

**POINTS OF DISCUSSION:**

The Chairman of WP/SRC would further draw GPG's attention to paragraph 4.2.4.3, which contains the requirement to intermediate dry-docking for oil tankers exceeding 15 years of age. The corresponding Res.A 744(18) requirement (paragraph 2.2.2) does not link the dry-docking to the intermediate survey. This issue was discussed extensively by correspondence and during three WP meetings this year. A consensus decision was achieved without reservations from any members. This process was time consuming, hence the delay in submitting this document to GPG for approval. However, at the annual meeting of the WP in October 2001 all members agreed that we should not accept the wording of Res. A 744(18) paragraph 2.2.2, but instead require that the intermediate dry-docking is to be linked to the intermediate survey and include a requirement to carry out surveys and thickness measurements of the lower portions of the tanks for oil tankers. (similarly, cargo holds/water ballast tanks for bulk carriers)

GPG is advised to note that the proposed requirement in paragraph 4.2.4.3 may result in a third dry-docking within the 5-year period of the classification certificate in case that a dry-docking is carried out prior to the window for intermediate survey.

The Chairman of WP/SRC suggests that GPG approves UR Z10.1 with high priority and allows PermSec in the meantime to start the work to amend and typeset UR Z10.2 and URZ10.3 with respect to the intermediate dry-docking requirement, as well as introducing the appropriate changes to UR Z10.2 and UR Z10.3 with respect to MSC 74/24/Add 1-Annex 17.

Note:

1. GPG tasked WP/SRC to review dry-docking survey requirements in Z10.2-4 and Z3 to harmonize them with those in Z10.1 (Rev.9) and reflect in Z3 the interim application of bottom survey requirements as introduced in MSC/Circ. 1013 (Res A.746(18)).  
Task 101, Target 2Q-2002
2. GPG confirmed (s/n 1060c) that 7.1.3 of A.744(MSC 74/12/Add.1/Annex 17/page 6), as quoted below, should not be included in Z10s.  
“7.1.3 Thickness measurements are to be carried out within 12 months prior to completion of the periodical survey or of the intermediate survey.”  
**Reason:** The above sentence will restrict the 15 month and 18 month survey window for TM during the intermediate and special surveys respectively.
3. GPG confirmed that 7.1.4 of A.744(MSC 74/12/Add.1/Annex 17/page 6), as quoted below, should not be included in Z10s:  
“7.1.4 In all cases the extend of the thickness measurements should be sufficient as to represent the actual average condition.”  
**Reason:** No compelling need, in view of MSC 74/12/Add.1 being adopted by MSC 75(May 02). IACS will live with this not harmonized sentence.
4. For IACS Council decisions to improve bulk carrier safety, see the TB for Revision 12 of Z10.2.

Submitted by WP/SRC Chairman

## **UR Z10.1(Rev.11) and Z10.2(Rev.14)**

**(July 2003)**

### **Technical background**

#### **Part A: Survey Reporting Principles**

##### **1. Objective**

WP/SRC Task 80 – Survey Reporting Principles

##### **2. Points of discussion**

The WP/SRC carried out this task according to the work specification of Form A (Rev.1) and reported the outcome on 18 December 2002 as follows:

- Review of NMD's report on "Sinking of Leros Strength", dated 6 July 2000 and the recommendations in section 5.3
- Review of IACS Council's reply, dated 22 August 2000 to those recommendations
- For recommendations 1.1, 1.2, 1.3 ,3, 4.2, 5 and 6, best practices have been identified by information exchange amongst Members and discussions at three WP-meetings.
- Harmonised survey reporting practices fulfilling, in so far as practicable, the recommendations of NMD have been included in the revised tables attached.
- Standard survey reporting terminology (recommendation 2) is in the process of being prepared and will be submitted to GPG for approval as an IACS Recommendation with the title "Surveyor's Glossary". The completion of the glossary has been delayed somewhat due to pending illustrations of typical hull structures.

Council approved on 14 July 2003 (2249\_).

\*\*\*

## **Part B: Incorporation of CAS related requirements into UR Z10s**

### **2. Objective**

WP/SRC Task 106 – Incorporation of CAS related requirements into A.744

### **2. Points of discussion**

The WP/SRC carried out this task according to the work specification of Form A and reported the outcome on 27 May 2003.

- Since CAS was developed for tankers only, WP/SRC considered whether there is any need to further develop/modify requirements in CAS with respect to bulk carriers. Hence, amendments to Z10.15.5.5(rafting), 5.6(survey planning), 8.2.2(different survey stations) and Table 1(close-up survey).
  - IACS will submit its proposed amendments to Res A.744 as a result of this revision.
  - NK GPG suggested that the word “alone” be inserted after “rafting” in Z7 and Z10.1(5.5.5)~10.5.
    - WP/SRC had considered this and felt that the insertion of the word "alone" will create a loophole as the text "Rafting alone will only be allowed..." could be interpreted that other means of access have to be used. Besides this wording would impede the use of rafting for survey of side and bottom structures of the spaces.
    - GPG considered that rafts/boats should be accepted as a means to move about within a tank to gain access to any temporary platforms that may be erected. Consequently, the wording of 5.5.5 was re-drafted and split into three parts (5.5.5~5.5.7) beginning with “Rafts or boats alone may be allowed for inspection of the under deck areas...”
- The same wording will be introduced into Z10.3, Z10.4, Z10.5, Z7 and Z7.1.

Approved on 08/08/2003 (0237h)

\*\*\*

Prepared by the Permanent Secretariat

22 July 2003

**WP/SRC Task 102**  
**HARMONIZATION OF UR Z7s AND Z10s**

**Technical Background**

**UR Z7 (Rev. 11)**

**UR Z7.1 (Rev. 2)**

**UR Z10.1 (Rev. 12)**

**UR Z10.2 (Rev. 17)**

**UR Z10.3 (Rev. 7)**

**UR Z10.4 (Rev. 2)**

**UR Z10.5 (Rev. 1)**

Contents:

TB for Harmonization

**Annex 1.** TB for UR **Z10.1(Rev.12**, C49 amendments(coating-related))

**Appendix 1:** Memo for Coating, submitted to Council  
49(June 2004).

**Appendix 2:** DNV proposal (25 May 2005) agreed by Council

**Annex 2.** TB for "Verification/Signature of TM Forms" for records.

**Annex 3.** TB for revision of UR Zs concerning "anodes".

**1. Objective**

To amend UR Z7s and Z10s in order to make the texts of the above-mentioned URs consistent eliminating all the differences both in substance and in wording (WP/SRC Task 102).

**2. Background**

In the process of approving UR Z10.4, GPG found it necessary to amend the other existing URs Z10.1, Z10.2, Z10.3, Z10.6 and Z7 in order to eliminate any inconsistencies existing among them.

**3. Methodology of work**

The WP has progressed its work through many sessions, both during the periodical meetings and dedicated meetings restricted to a Small Group of Members (BV, DNV, GL, LR, RINA) who developed the work in order to be more efficient. All the proposed amendments of the Small Group have regularly been circulated to all Members for comment and agreement.



## 4. Discussion

4.1 The WP/SRC has completed a comprehensive comparative review of UR Z7 and Z10s, and identified inconsistencies which existed among them. During this review, attention was given to the severity of the requirements applicable to the same spaces/structural areas on different types of ESP ships. As a result, the inconsistencies were eliminated making the URZs harmonized. However, there has been no change to the scope and extent of the survey requirements.

4.2 The starting point for each UR was the most updated version available at the time of commencement. Any revision to the URZs, which were introduced during this task, was taken into account. As for instance, the UR Z10.1 was initially amended based on Rev. 9, while the last amendments are based on Rev. 11 and the UR Z10.2 was initially amended based on Rev. 13, while the last amendments are based on Rev. 16. The proposed revisions of URs Z10.1 and Z10.4 have not been numbered, as there will be revisions to those URs before the revisions introduced by the Task 102 are adopted. In fact, GPG is currently developing a Revision 12 of Z10.1 with the view to introducing significant improvements in the survey regime for ballast tanks (including combined cargo/ballast tanks) of oil tankers and UR Z10s applicable to oil tankers will also have to be revised by incorporating the amendments to A.744(18) contained in Resolution MSC 144(77), which enter into force 1 January 2005 (see 4.3 below).

4.3 Also, in harmonizing UR Z10.1 and Z10.2 care has been taken to align the corresponding text with that of IMO Res. A.744(18). However, it has been noted that the amendments to A.744(18) contained in Resolution MSC 144(77), which enter into force 1 January 2005, have not been incorporated into the IACS UR Z10s applicable to oil tankers. It seems that the updating of the above-said UR Z10s will be done by the Perm Sec and reviewed by the WP/SRC Chairman and then circulated for adoption by GPG with concurrence of Council Members for uniform application from 1 January 2005. It is understood that the revisions of the UR Z10s affected by those amendments will not include the changes introduced by the Task 102, as the implementation date proposed for those changes is 1 January 2006 (see below **6. Implementation**).

4.4 In the course of the work the WP has been developing for more than two years, several additional Tasks were assigned to the WP by GPG which affected the development of Task 102. The additional tasks which have been taken into account are the following:

- 1) In the course of Council discussion on UR Z10.6 (General Cargo Ships), certain inconsistencies were identified between Z10.6 and other Z10s. WP was instructed to expedite Task 102 (1060gIAa, 12 June 2002);
- 2) WP was instructed to include "Survey Planning for Intermediate Survey" into harmonization work (2108\_IAa, 12 July 2002);
- 3) GPG instructed WP to consider whether Z10.6 should be re-assigned as Z7.1, in connection with the harmonization work. 1060gIAb, 20 Sept 2002.

- Z7.1 developed;
- 4) Partial outcome (Z7 and Z7.1) was submitted to GPG on 17 July 2003(1060g). Council decided that approval of Z7(Rev.10) and Z7.1(Rev.2) is postponed until the harmonization is completed (1060gICb, 6 April 2004);  
[Council Chairman instructed WP/SRC to Members' comments on the draft revision of UR Z7 and Z7.1 \(collected under s/n 1060g, 1060gNKi \(30/03/2004\) in particular\) on 6 April 2004.](#)
  - 5) GPG tasked WP to include the amendments to Z10.2 / Z11 (BCs with hybrid cargo hold arrangements), deleting sheets 15 and 16 for ore carriers, into the harmonized UR Z10s (2212aIGa, 19 Jan 2004);
  - 6) GPG tasked WP to consider whether the requirements relevant to examination of Fuel Oil Tanks in the cargo area at each Special Survey should be put into Z10s, and internal examination of FOT at Intermediate Survey after SS 2 is needed. (1060gIAf, 30 Jan 2004);
  - 7) GPG tasked WP to harmonize tank testing requirements in Z7s and Z10s. (3006IIAa, 5 April 2004);
  - 8) GPG tasked WP with Task 108 - Develop uniform survey requirements for air vent pipes including the welded connection to deck. Z22 developed. GPG instructed WP to incorporate Z22 into the harmonized Z10s;
  - 9) GPG tasked WP with Task 114 - Verification and signature of TM reports. REC 77(Rev.1) developed and approved on 29 July 2004. Council approved parallel amendments to Z7.1 and Z10s (TM Forms included) and instructed WP to incorporate these into the harmonized Z10s:
    - [Recommendation No.77 was revised \(Rev.1, July 2004\);](#)
    - [Z7.1 para.6.3.2 and Z10s para.7.3.2 so amended.](#)
    - ["Surveyor's signature" is deleted from all TM Forms in Z10s;](#)
    - [A note is added to Annex II\(Z10s\) declaring that Annex II is recommendatory.](#)

WP/SRC's investigation into Members' practice in dealing with verification and signature of TM reports is annexed for record keeping purpose. [See Annex 2.](#)
  - 10) GPG tasked WP to consider the BV comments on "TM may be dispensed with..." and include the findings into the harmonized Z10s ( 2219iIAa, 7 April 2004).

## **5. Agreement within the WP/SRC**

All Members have unanimously agreed the attached final versions of UR's.

## **6. Implementation**

WP/SRC is of the view that the Members need 12 months from the adoption date to implement these amendments into their class rules. Assuming Council adoption in December 2004, WP/SRC would propose January 2006 as implementation date.

- Annex 1:** TB for UR Z10.1(Rev.12, C49 amendments, see Permsec's note 1 below)  
**Annex 2:** WP/SRC Task 114, verification and signature of TM reports(see 9 above).  
**Annex 3:** TB for revision of UR Zs concerning "anodes".

### **Note by the Permanent Secretariat**

1. Annex 1 to this TB contains background for amendments to UR Z 10.1(Rev.12) relating to FAIR/POOR/GOOD (C49 amendments). Council at its 49<sup>th</sup> meeting (June 2004) agreed/decided that comparable changes should be added to Z10.3 and Z10.4.
  
2. Appendix 3 "TM sampling method" has been added to UR Z10.1 and Z10.4 to keep them consistent with IMO Res.MSC.144(77). The amendments to A.744 contained in MSC.144(77) entered into force on 1 January 2005. (*GPG s/n 4181*)  
  
Under s/n 4072g, paragraph **2.4.6** of UR Z10.1 and **2.4.6** and of UR Z10.4 (paragraph numbering is now harmonized) were amended in order to provide a link between the main text of the UR Z10.1 and 10.4 and the new Annex III Appendix 3 containing the MSC Res.144(77).  
Further, it was agreed that the requirements for evaluation of longitudinal strength of the hull girder (as written in MSC.144(77)) should not be required for Intermediate Survey unless deemed necessary by the attending Surveyor. This is covered in 4.2.3.1 and 4.2.4.1 of Z10.1 and Z10.4.
  
3. GPG agreed that the amended UR Zs should be implemented from 1 July 2006 altogether.
  
4. DNV's proposed amendments to UR Z10.1, Z10.3 and Z10.4 concerning annual survey of ballast tanks were agreed by Council (1060gICq, 27 June 2005). See Appendix 2 to Annex 1.
  
5. Annex 3 contains a TB for revision of UR Zs concerning "anodes".

Date: September 2004  
Prepared by the WP/SRC

---

## **Annex 1 to Technical Background**

### **UR Z 10.1 (Rev.12, C49 amendments(coating-related))**

#### **1. Objective**

To introduce significant improvements in the survey regime for ballast tanks (including combined/ballast tanks) of oil tankers as matter of strategic concern and urgency to IACS, given the aging of both the single and double hull tanker fleets and the problems encountered with corrosion of ballast tanks in several shipping casualties.

#### **2. Background**

Draft amendments to UR Z10.1 were submitted to Council 47 (June 2003) and agreed in principle.

#### **3. Discussion**

There was particular concern over accelerated corrosion with age (as the thinner the material, the more rapidly the allowable diminution margin percentage disappears) especially where coatings have broken down. There is also a disincentive for any spend on maintenance of the structure of a ship within a few years of its statutory scrapping date.

Council discussion by correspondence had evolved to the position of substantive proposals – summed as follows (3095\_ABa, 2 June 2003):

1. Enhance the Intermediate Survey in Z10.1, Z10.3 and 10.4 for Tankers after 2<sup>nd</sup> Special / Renewal Survey to the same level (scope of work) as the preceding Special / Renewal Survey). This corresponds to the latest revision to UR Z10.2.
2. At Annual Survey of ballast tanks with substantial corrosion, the overall survey is to be replaced by close-up survey with thickness measurements of the exposed area.
3. Proposed to task WP/SRC to re-consider the acceptance criteria for the rating FAIR further. For this, eliminate FAIR, leaving only GOOD and POOR redefined as appropriate.
4. Proposed to task WP/SRC to explicitly require close-up survey of Suspect Areas identified at the previous Special Survey.

Council 47 discussed the proposals(June 2003) as follows:

##### **1. Definition of FAIR**

Council 47 agreed that “FAIR” would be retained as a rating and that GPG should instruct WP/SRC to redefine FAIR, so that there would be a clear differences between FAIR, POOR and GOOD. It was also agreed that for oil tankers the Intermediate Survey following Special Survey No.2 would have the same scope as Special Survey No.2(Z10.1). WP/SRC should also clarify the definition of satisfactory repair.

Based on the strong majority, Council agreed to discuss with Industry annual surveys of ballast tanks when coating is found in LESS than GOOD condition at special survey, with the objective to encourage the owner to carry out repairs and maintenance of coating to GOOD condition.

*DNV and NK stated that they could not accept a requirement for annual surveys of ballast tanks when the coating condition is less*

*than GOOD and proposed that GOOD be changed to FAIR (3095\_IGc, 30 June 2003)*

2. ABS' proposed amendments to Z10.1(annual examination of BWTs in certain conditions) were approved.
3. C 47 agreed that the BWT coating requirements (Z10.1.2.2.3) for intermediate Survey after SS 2 should be the same extent to the previous SS.
4. Given the substance of the changes, the revised Z10.1 should be shown to Industry before adoption.
5. A guidance for coating repairs needs to be developed by WP/SRC with reference to TSCF Guidelines.

Following Council 47, the draft text of Z10.1(Rev.12) was distributed to Industry and discussed at the IACS/Industry meeting on 29 August 2003. Industry indicated that UR Z10.1(Rev.12) is acceptable, provided that appropriate IACS guidelines on coating repairs are developed.

The Small Group on Coating (SG/Coating) under WP/SRC prepared draft guidelines on coating repairs and considered the definitions of GOOD / FAIR / POOR. The SG/Coating did not change the definitions and found that the Guidelines provide useful clarifications on the definitions and criteria in achieving an industry wide uniform judgement of coating conditions as well as what is needed to restore GOOD conditions.

Further, an IACS/Industry JWG/Corrosion was established and met in February 2004. The outcome is (3095\_IGh, 4 June 2004):

- Draft Guidelines on Coating Repair (IACS REC 87)
- Draft UR Zxx (mandatory coating of cargo tanks on oil tankers)
- Draft UI SC 122 (Rev.2) – mandatory coating of ballast tanks

#### **4. Others**

1. Z10.11.2.2bis - Definition of “Combined Cargo/Ballast Tank. ...as a routine part of the vessel's operation and will be treated as a Ballast Tank. ...”. By so amending, Z10s do not need to repeat “Ballast Tanks and Combined cargo/salt water Ballast Tanks” in addressing the ballast tanks. Hence, all the references to “and Combined cargo/salt water Ballast Tanks” were deleted.
2. Z10.1.2.2.1.2: The aim of the examination is to be sufficient to discover substantial corrosion...  
Comparable changes are to be added to other UR Zs wherever the same sentence occurs.
3. “IACS Guidelines for Coating Maintenance & Repairs for Ballast Tanks and Combined/Ballast tanks on Oil Tankers” are referenced where relevant.
4. Comparable changes are to be added to UR Z10.3 and Z10.4, after adoption of Z10.1(Rev.12).

**Attached: Memo on Coating Matters (GPG Chairman)**

9 June 2004  
Prepared by the Permsec

## **Appendix 1 to Annex 1:**

## **MEMO on Coating matters**

### **1. Background and discussion within IACS on UR Z10.1 (draft Rev.12) between 29/01/03 and 14/08/03**

In view of the survey experience with oil tankers, it was proposed that all ballast tanks should be examined, routinely and uniformly, at annual surveys on ESP tankers exceeding 15 years of age. IACS should amend UR Z10.1 to require the examination of ballast tanks on such ships at each annual survey. This is simple, clear and thorough and not subject to interpretation. (2242\_ABq dated 29/1/03)

Then, ABS modified the proposal asking, for tankers subject to URs Z10.1, Z10.3 and Z10.4, exceeding 15 years of age, that the current requirement - pertaining to annual examination of Ballast Tanks adjacent to cargo tanks with any means of heating - be deleted and replaced by a simpler and more stringent requirement that all Ballast Tanks be subject to survey at each subsequent annual survey where either substantial corrosion is found within the tank or the protective coating is found to be in less than GOOD condition and the protective coating is not renewed at special survey or intermediate survey. This will ensure that all Ballast Tanks with substantial corrosion or protective coating which is not in GOOD condition at the time of special survey or intermediate survey will be examined at each subsequent annual survey on tankers exceeding 15 years of age. (2242\_ABzb dated 14/3/03)

This was later expanded to include all tanks used routinely for ballast water, both ballast-only and cargo/ballast tanks (2242\_ABzc dated 14/3/03).

ABS further reviewed the issue of the survey of salt water ballast spaces and combined cargo/salt water ballast spaces with ABS' governing bodies in light of recent casualties and survey findings on other tankers. Their review found an increasing amount of coating breakdown/failure and subsequent rapid wastage in key structures after Special Survey No. 2, i.e. after 10 years of age. These conditions are most prevalent in the under deck structure and the side shell structure in way of the deep loadline. In a number of cases the serious wastage has caused fracturing of the under deck longitudinals and in some cases fracturing has extended to the main deck structure. This led ABS to refine proposed amendments to URs Z10.1, Z10.3 and Z10.4 to require (2242\_ABzf dated 9/5/03):

#### a. For Tankers exceeding 10 years of age

Salt Water Ballast Spaces and Combined Cargo/Salt Water Ballast Spaces. For tankers exceeding 10 years of age, salt water ballast spaces and combined cargo/salt water ballast spaces are to be internally examined at each subsequent Annual Survey where substantial corrosion is found within the tank or where the protective coating is found to be less than GOOD condition and protective coating is not repaired. Internal examination to be an Overall Survey.

#### b. For Tankers exceeding 15 years of age:

Salt Water Ballast Spaces and Combined Cargo/Ballast Spaces. For tankers exceeding 15 years of age, salt water ballast spaces and combined cargo/ballast spaces are to be examined internally at each subsequent Annual Survey. Where substantial corrosion is found within the tank, or where the protective coating is found to be in less than GOOD condition and the protective coating is not repaired then in addition to an Overall Survey, under deck structure and the side shell structure in way of the deep loadline is to be subject to Close-up Survey.

NK and BV replied that the proposed amendments made by ABS need to be substantiated in a transparent manner with technical data that ABS may possess and put forward for further assessment and discussion. (2242\_NK<sub>n</sub> dated 14/5/03 and 2242\_BV<sub>z</sub> dated 16/5/03)

**DNV** (2242\_NV<sub>n</sub> dated 2/6/03), having carefully considered the practical consequences of taking the ship off-hire for gas freeing etc. and being concerned about the difficulties to have these surveys executed in a safe manner and whether the intended safety benefits in implementing the proposed extended scope of the annual survey of Ballast tanks will be met, **proposed the following alternative measures** which would be as effective and may not have such delaying effects to the ship:

- 1) Enhance the Intermediate Survey in UR Z10.1, 10.3, and 10.4 for Tankers after the 2 Special / Renewal Survey to the same level (scope of work) as the preceding Special / Renewal Survey. (This will correspond to the latest revised requirements of UR Z10.2 for Bulk Carriers.)
- 2) At Annual Survey of ballast tanks with substantial corrosion the overall survey should be replaced by close up survey with thickness measurements of the exposed area. (An overall survey of these tanks does not give sufficient information of the development of the areas with substantial corrosion.)
- 3) Further we will not fail to mention that the WP/SRC has proposed to extend the close up survey in cargo and combination tanks to 30% from the 3 Special / Renewal Surveys.
- 4) **Experience has shown that the coating condition rating category FAIR has a tendency to be stretched too far into the POOR condition. We will therefore propose that we task the WP/SRC to reconsider the acceptance criteria for the rating FAIR further.**
- 5) We do also question the need for redefining the definition of combination tanks, particularly since the category I tankers which are the ships that normally are fitted with these type of tanks are to be phased out 2 to 4 years from now. However DNV will not oppose to such a redefinition.

**DNV requested Members to consider the above as an alternative to the ABS proposal, bearing in mind that we ought to present this to the industry prior to deciding.**

ABS (3095\_Aba dated 2/6/03), having further considered its earlier proposals in light of NV<sub>n</sub>, submitted a revised proposal for consideration by Council at C47 and replied to the above 5 DNV proposals as follows:

- 1) ABS fully supports this proposal.
- 2) While ABS agrees with this proposal, it is in fact already provided for in Z7 (3.2.3) and Z10.1 (3.2.5.1)--which require that "Suspect areas (which include any area where substantial corrosion is found) identified at previous Special Survey are to be examined. Areas of substantial corrosion identified at previous special or intermediate survey are to have thickness measurements taken." To us, this implies that close-up survey of these areas is to be done at annual survey in conjunction with the thickness measurements. However, we can

agree to tasking WP/SRC to explicitly require "close-up" survey in this connection and to amend Z7, and all the Z10's, appropriately to make this explicit, if there is majority support for this.

3) We agree that this has been put forward to GPG by WP/SRC via 0237hNVb, 27 May. However, these additional CAS close-up survey requirements do not apply to salt water ballast tanks; only to cargo oil tanks and combined cargo/ballast tanks.

4) **We agree with this assessment and we propose that the only way to eliminate the subjectivity and raise the standard is to eliminate the category "FAIR" completely; leaving only "GOOD" and "POOR" redefined as follows:**

**"GOOD -- condition with no breakdown or rusting or only minor spot rusting.**

**POOR -- any condition which is not GOOD condition."**

5) ABS does not agree with this proposal. We are particularly concerned that we need a very thorough and robust survey regime for these tankers precisely because they are subject to mandatory phase out over the next several years. We are very concerned that without additional IACS requirements, these tanks will receive little or no inspection and maintenance by owners or others after their last special or intermediate survey, if no substantial corrosion is found at that time. Rapid, localized wastage in way of deteriorating coatings may pose significant hazard if the survey regime is not further tightened as we are proposing.

In conjunction with the above comments on DNV proposals, ABS further considered their previous proposal in ABzf and modified it as follows:

- **ABS simplified the proposal to require annual examination of all salt water Ballast Tanks and combined Cargo/salt water Ballast Tanks irrespective of age, when either substantial corrosion is found within the tank or the protective coating is found to be in less than GOOD condition and is not repaired.**
- the requirement for annual (close-up) examination of salt water ballast tanks and combined tanks is already required in Z10.1 (3.2.5.1). ABS proposed adding it to 2.2.3 for clarity and emphasis so that all the conditions which may lead to annual examination of such tanks are listed together in one place.
- Since the principal problem that we are trying to address is rapid, localized corrosion in way of breakdown or deterioration of the protective coating, we are proposing that the coating condition should be found and kept in "GOOD" condition to obviate the need for annual examination. **The attached proposal is made together with the proposals in items 3.1 (intermediate following Special survey 2 to have same scope as prior Special survey) and 3.4 (eliminating "FAIR" and redefining "POOR" as any condition other than "GOOD" condition.**

ABS requested to decide on a course of action at C47 for tightening the survey regime for tankers. They agreed that industry be informed of Council's decisions in this regard prior to IACS making the decision public, but IACS should maintain its independence and take decisive action in this matter. Debate with industry can only lead to delay and to a watering down and compromising of these important requirements.

NK agreed to task WP/SRC to reconsider the acceptance criteria of "FAIR" for clearly define the border between "FAIR" and "POOR" condition. However, **NK strongly opposed the elimination of "FAIR" coating condition from UR Zs** because this can not resolve to remove subjectivity of coating assessment. The three-categorization system of coating condition should be retained. (3095\_NKa dated 5/5/03)



## **Outcome of C47**

At C47, it was agreed that "Fair" would be retained as a rating and that GPG should instruct WP/SRC to redefine "Fair", so that there would be a clear differentiation between "Fair", "Poor" and "Good". It was also agreed that for oil tankers the Intermediate Survey following Special Survey No.2 would have same scope as Special Survey No.2 (Z10.1). WP/SRC should also clarify the definition of satisfactory repair.

Based on strong majority support Council agreed to discuss with Industry annual surveys of ballast tanks when coating is found in LESS than GOOD condition at special survey, with the objective to encourage the owner to carry out repairs and maintenance of coating to GOOD condition.

This matter should be discussed with Industry prior to adoption of any UR by Council.

In a final summary, the Chairman proposed that a constructive dialogue with Industry should take place on the IACS proposal as set out in WP1 plus maintaining 3.2.5.2 modified to say that ballast/combined ballast/cargo tanks will be subject to annual survey when considered necessary by surveyors.

After discussion in the JWG (Industry/IACS), GPG should propose final rules for this matter to Council, including acceptable repair definition.

**FUA 17:** *To instruct WP/SRC to develop guidance on coating repairs and more precise definition of "Fair" coating condition.*

Once approved, these requirements should be incorporated into Z10.3 and Z10.4.

### **FUA 15**

1) *To prepare a draft revision to UR Z10.1 incorporating C 47 decisions:*

- *The definition of "FAIR" remains as it is;*
- *ABS proposed amendments to Z10.1 (annual examination of BWTs in certain conditions) were approved;*
- *C47 agreed that the BWT coating requirements (Z10.1.2.2.3) for Intermediate Survey after Special Survey No.2 should be the same extent to the previous Special Survey.*
- *Given the substance of the changes, the revised UR Z10.1 should be shown to Industry (OCIMG/Intertanko first among others) before adoption for their review and comments.*
- *A guidance for coating repairs needs to be developed by WP/SRC with reference to TSCF Guidelines.*

2) *GPG Members are to confirm the draft revision to Z10.1 in consultation with their WP/SRC members by correspondence. See 3095\_IGa of 13/06/03.*

According to C47 FUA 15, GPG Chairman circulated (3095\_IGa dated 13/6/03) draft amendments to UR Z10.1 as agreed in principle at C47.

Having received a number on comments, GPG Chairman (3095\_IGb dated 27/6/03) informed that the Council Chairman confirmed that GPG is not to amend the principles agreed at C47, i.e. we are not empowered to change "GOOD" to "FAIR" as proposed by DNV and NK, nor to amend the definitions of "FAIR" and "POOR" as proposed by DNV.

DNV's intention to possibly lodge a reservation was noted, however the matter should be raised at Council and not be dealt with by GPG. An amended draft text incorporating the non-substantive changes proposed by Members was circulated.

DNV said that its understanding was that the draft should be circulated to the Industry (ICS, INTERTANKO, and BIMCO) prior to adoption by Council. (3095\_NVc dated 30/6/03)

GPG Chairman (3095\_IGc dated 30/6/03) circulated a draft amendment of UR Z10.1 for Council's agreement and use in discussions with the industry associations.

The draft was generally agreed by GPG but individual Members have requested that the following matters (which were deemed to be outside the remit of GPG in this task) be brought to Council's attention for further consideration:

- 1 DNV and NK stated that they can not accept a requirement for annual surveys of ballast tanks when the coating condition is less than GOOD and propose that GOOD be changed to FAIR.
- 2 In connection with item 1 above, DNV also propose to amend the definitions of FAIR and POOR in order to raise the standard of FAIR.

Council Chairman (3095\_ICb dated 14/8/03) concluded that Council has agreed that the draft amendments to UR Z10.1 attached to IGc reflect Councils' decision taken at C47 and that they be circulated to industry associations.

Perm Sec was therefore invited to submit the draft to OCIMF and INTERTANKO in view of discussion at the IACS/ industry meeting on 29 August.

## **2. Discussion with Industry (29/08/2003 – 11/10/2003)**

As requested by Council, the whole matter was presented to Industry during the “general matters” meeting with IACS held on 29 August 2003; comments from Industry were requested. In the following an extract from the minutes of the meeting (see message 3100aIAb dated 5 September 2003):

\_\_\_\_\_ from Meeting minutes \_\_\_\_\_

## **4. & 5. Annual surveys of ballast tanks and IACS guidelines on coating repairs**

M. Dogliani introduced the matter ([see Items 4&5 in Appendix](#)).

A. LinoCosta gave a presentation to show where concerns and decisions stand: too many cases when coating was considered fair at SS but problems occurred just after one/two years.

N. Mikelis commented on draft amendments to Z10.1 (Rev.11) stating that the extent of annual survey is not clear; it should be limited to the affected zones, e.g. coating breakdowns, only.

M. Guyader clarified that, in this draft amendments, it is expected an overall survey of the whole tank and a close up survey of the affected zones.

N. Mikelis noted that, in the draft amendments to Z10.1 (Rev.11), the intermediate survey at 12.5 years would have the same scope as the previous special survey and that needed a justification. See 7 a).

M. Dogliani said that Z10.1 (Rev.11) was adopted in August 2003 and will be introduced into IACS Societies' Rules over the next year.

### Conclusions:

4.1 Industry shared IACS concerns on coatings and, in general, agreed with the draft amendments to Z10.1 (Rev.11) suggesting also extending them to Z10.2 on bulk carriers

4.2 Industry agreed that a guideline for surveyor on coating would greatly improve uniform application of so-amended Z10.1 including issues such as how to consider load bearing elements when judging GOOD/FAIR/POOR status and how to consider bottom pitting in connection with GOOD conditions

4.3 Industry will more precisely comment, by the end of September, the draft Z10.1 so as for IACS to finalise the matter, as planned, for the Council's December meeting.

Item	Title	Industry recommendation	IACS/ M. Dogliani Introduction
4 & 5	Annual survey of ballast tanks IACS guidelines on coating repairs	NN	<p><b>1. IACS is considering the following:</b></p> <ul style="list-style-type: none"> <li>- <b>amend UR Z10.1 (draft circulated to Industry) to the effect that in case at Special Survey or Intermediate Survey the coating in a ballast tank is found less than GOOD, either GOOD conditions are restored or the tank's coating is inspected at each annual survey;</b></li> <li>- <b>develop IACS guideline to assist an uniform application of the so modified (if adopted) UR Z10.1; the guideline should address which repairs are necessary to restore GOOD conditions from FAIR and POOR respectively and which are the criteria for the restored (after repair) situation to be rated as GOOD.</b></li> </ul>

\_\_\_\_\_ End of extract from minutes \_\_\_\_\_

INTERTANKO commented (see R. Leslie email to GPG dated 25 September 2003):

- expressing their concern for the draft Z10.1 and underlining
  - a) targeting: concerns that, if not properly dealt with, Z10.1 would target all ships and not just those which need intervention; the view was expressed that guidelines would probably solve the matter;
  - b) definition: indicating that the current definitions of GOOD, FAIR and POOR is not clear enough and that the matter would be even worst with GOOD and NON GOOD; again it was indicated that guidelines could solve the matter;
  - c) expertise: expressing doubts on IACS' surveyors expertise and ability to judge coating conditions; in this respect they (hiddenly) suggest that IACS position is unclear when we say that we are not competent to judge the coating during construction but then we are competent to judge coating during operational life. Even if not explicitly stated, the impression is that also in this case guidelines would help.

Additionally, INTERTANKO suggested a (quite detailed) set of assessment criteria.

The matter was then finally addressed at the TRIPARTITE Meeting (held in Soul on 29/30 September 2003). There Industry agreed that the way forward was the (joint) development of IACS guidelines (see minutes attached to message 3100\_RIe dated 11 October 2003, an extract of which is reproduced below).

\_\_\_\_\_ Extract from the TRIPARTITE minutes \_\_\_\_\_

Industry is concerned by the definition of GOOD/NOT GOOD in relation to coating repairs and acceptance criteria. Industry agreed that new guideline on this, which IACS is already producing, was the way forward.

\_\_\_\_\_ End of the extract from the minutes \_\_\_\_\_

### **3. Further developments**

- a) from the above, it was concluded that, provided the guidelines are sound, Industry would accept the concept of Z10.1 (draft) Rev. 12, therefore an IACS team and a JWG were established in order to progress the matter of the guidelines (among other related matters).
- b) the team of IACS experts on coating developed draft guidelines and provided recommendations to GPG on the way forward (attached to message 3095bNVc dated 20 November 2003).
- c) the guidelines were discussed within the JWG with Industry (see draft minutes circulated within GPG with messages 3095cIGd and 3095cIGe both dated 13 March 2004)
- d) further suggestions and comments (as requested at the meeting) were provided by Industry (not circulated to GPG)
- e) Bulk Carrier Industry is recommending that similar guidelines are developed in due time also for bulk carriers
- f) at DE47 and MSC78, IMO is asking Industry and IACS to develop (compulsory) performance standards for coating of newbuilding (double hull spaces of DSS Bulk Carriers), a matter which is, indirectly related to the above one.

1 June 2004

M. Dogliani

IACS GPG Chairman

IACS JWG/COR Chairman

Appendix 2 to Annex 1: [DNV proposal to Z10.1, Z10.3 and z10.4](#) ▶

Sent Monday, July 4, 2005 4:45 pm

To [Gil-Yong <gilyonghan@iacs.org.uk>](mailto:Gil-Yong <gilyonghan@iacs.org.uk>)

Cc

Bcc

Subject Fw: 1060gNVs; WP/SRC - Task 102 - Harmonization of UR Z 7 and Z 7.1

Attachments [Doc1.doc](#)

25K

----- Original Message -----

From: "Debbie Fihosy" <[debbiefihosy@iacs.org.uk](mailto:debbiefihosy@iacs.org.uk)>

To: "CCS" <[iacs@ccs.org.cn](mailto:iacs@ccs.org.cn)>

Cc: "IACS Permanent Secretariat" <[permsec@iacs.org.uk](mailto:permsec@iacs.org.uk)>

Sent: Friday, June 03, 2005 2:52 PM

Subject: FW: 1060gNVs; WP/SRC - Task 102 - Harmonization of UR Z 7 and Z 7.1

Forwarding as requested

-----Original Message-----

From: Arve.Myklebust@dnv.com [[Arve.Myklebust@dnv.com](mailto:Arve.Myklebust@dnv.com)]

Sent: 25 May 2005 15:49

To: [AIACS@eagle.org](mailto:AIACS@eagle.org); [iacs@bureauveritas.com](mailto:iacs@bureauveritas.com); [iacs@ccs.org.cn](mailto:iacs@ccs.org.cn);

[johnderose@iacs.org.uk](mailto:johnderose@iacs.org.uk); [iacs@dnv.com](mailto:iacs@dnv.com); [iacs@gl-group.com](mailto:iacs@gl-group.com);

[gilyonghan@iacs.org.uk](mailto:gilyonghan@iacs.org.uk); [helenbutcher@iacs.org.uk](mailto:helenbutcher@iacs.org.uk); [efs@iacs.org.uk](mailto:efs@iacs.org.uk);

[krsiacs@krs.co.kr](mailto:krsiacs@krs.co.kr); [richardleslie@iacs.org.uk](mailto:richardleslie@iacs.org.uk); [external-rep@lr.org](mailto:external-rep@lr.org);

[clnkiacs@classnk.or.jp](mailto:clnkiacs@classnk.or.jp); [terryperkins@iacs.org.uk](mailto:terryperkins@iacs.org.uk); [iacs@rina.org](mailto:iacs@rina.org);

[iacs@rs-head.spb.ru](mailto:iacs@rs-head.spb.ru); [colinwright@iacs.org.uk](mailto:colinwright@iacs.org.uk)

Subject: FW: 1060gNVs; WP/SRC - Task 102 - Harmonization of UR Z 7 and Z 7.1

25 May 2005

To: Mr. B. Anne, Chairman of IACS Council,

cc: Council Members, IACS Perm. Sec.

Ref.: My mail NVr dated 20 May 2005

DNV have further studied the amendments to UR Z10.1, Z10.3, and Z10.4, and as a result are presenting the following as a compromise solution:

General comment:

From the comments by other Members it is obvious that there is reluctance to accept annual surveys of ballast tanks with a common plane boundary to heated cargo tanks in the case where the coating is in good condition. This is particularly unreasonable as at the same time we enhance the Intermediate survey of Tankers between 10 and 15 years to also include examination of all ballast tanks, meaning that all ballast tanks will be close up surveyed with 2-3 years intervals from the ship is 10 years old, with the possibility for the surveyor to require thickness measurements and testing of the tanks to ensure the structural integrity of the tanks if necessary.

It is also proposed for the Intermediate survey between 5 and 10 years, to increase the scope from representative to all ballast tanks, a requirement DNV find to strict, and require that we here keep the original text.

If a ballast tank is found to have coating in GOOD condition at the renewal or intermediate survey, a deterioration of the tank beyond structural reliability is very unlikely even if the tank has a common plane boundary to a heated cargo tank.

DNV finds it particularly unreasonable to have this requirement to apply to double hull tankers for the following reasons:

- these ships have double hull and the risk of pollution is here much reduced,
- the double hull is constructed with small spaces giving improved structural reliability,
- almost all double hull tankers below VLLC have heated cargo tanks, and all ballast tanks have common plane boundaries to these tanks, meaning that this requirement will apply to a major part of the tanker fleet in the future,
- the ballast tanks of double hull tankers are so designed that a general examination of these tanks will be identical to a close up survey,
- survey of ballast tanks of double hull tankers will mean either gas freeing of all cargo tanks or at least dropping the inert gas pressure of all cargo tanks in addition to proper airing of all ballast tanks.

Since the single hull tankers will be faced out in the near future, and for clear political reasons, DNV will as a compromise proposal to keep paragraph 2.2.3.1 and 4.2.2.2 in Z 10.1 as amended by Council (ref. IAo) but amend it to not include 2.2.3.1.e, 4.2.2.2.e and last paragraph of 3.2.5.1 in Z10.3 and Z10.4. In addition we request that the original text of 4.2.2.1 is kept.

If BV, ABS and other Members can accept this DNV is willing to drop our reservation presented at C49.

DNV's proposal will then be as follows:

Z10.1:

2.2.3.1: This paragraph can be accepted as is for the reasons stated above.

3.2.5.1: This paragraph is accepted as amended.

4.2.2.2: This paragraph can be accepted as is for reasons stated above.

For other comments to Z10.1 see NVo and NVp.

Z10.3:

2.2.3.1.e to be deleted.

3.2.5.1 delete last paragraph

4.2.2.1 the original text to be kept. "For tanks used for water ballast ---"

4.2.2.2.e to be deleted

Z10.4

2.2.3.1e to be deleted

3.2.5.1 delete last paragraph

4.2.2.1 the original text to be kept, "For tanks used for water ballast --"

4.2.2.2.e to be deleted.

For details see attached document where the text for the requirements in Z10.3 and Z10.4 that DNV will accept is stated.

Best Regards

Arve Myklebust  
on behalf of  
Terje Staalstrom  
DNV IACS Council Member  
<<Doc1.doc>>

\*\*\*\*\*

Neither the confidentiality nor the integrity of this message can be vouched

Annex 2 to TB (Harmonization Z10s)

**WP/SRC Task 114 “Clarify the procedure of verification and signature of the thickness measurement report”**

Item No.	Item	ABS	BV <sup>1)</sup>	CCS	CRS	DNV	GL	IRS	KR	LR	NK	RINA	RS
<b>1</b>	<b>Verification onboard</b>												
1.1	Minimum extent of measuring points for direct verification by attending surveyor specified	No	No	No	No	No	No	No	Yes	No	No	Yes	No
1.2	Preliminary TM record to be signed upon completion of the measurements onboard	Yes	Yes <sup>7)</sup>	Yes	No (copy taken)	No <sup>3)</sup>	No <sup>6)</sup>	Yes	Yes	Yes	Yes	No <sup>8)</sup>	No
<b>2</b>	<b>Final TM report</b>												
2.1	Signature of all pages in TM record required	No	No	No	Yes	No	Yes	Yes	No	No	No <sup>5)</sup>	Yes	Yes
2.2	Signature of ‘cover’ (‘general particulars’) page only	Yes	Yes	Yes	No	Yes	No	No	No <sup>4)</sup>	Yes	Yes	Yes	No
2.3	Measuring points verified by attending surveyor required identified in TM record and signature of the corresponding pages required	No	No	Yes Without signature	Yes	No	No	No	Yes	No	No	No	No

2004-04-20

<sup>1)</sup> Instructions not clear regarding signature of the thickness measurement record

<sup>2)</sup> Signature on front and last page, stamp on all other pages, or signature on each page (IACS TM forms)

<sup>3)</sup> Upon completion of measurements onboard a draft report in electronic format (DNV TM template, including operator’s notes as relevant) to be given to attending surveyor

<sup>4)</sup> Signature of cover page, pages of meeting record and pages of attended measuring points

<sup>5)</sup> Each page to be signed in case of ‘loose-leaf’ type record

<sup>6)</sup> Preliminary TM record has to be passed to the Surveyor, signed by the Operator

<sup>7)</sup> The only measures which the Surveyors can certify exact are those for which that they have seen the results on the screen of the apparatus. That means in fact few points in comparison with the numbers of recorded measures.

<sup>8)</sup> The Surveyor reviews the TM record for completeness and assessment of TM readings, but no signature required.

UR Z7s and Z10s (Corrosion Prevention System)

1. Objective:

To clarify whether the survey of anodes is a class matter, and if so, whether acceptance criteria for anode should be developed.

2. Method: GPG by correspondence (5037\_)

3. Discussion

3.1 BV initiated GPG discussion as follows:

Paris La Défense, 8 Mars 05

1 - We have noticed that, in the draft UR Z's ( 7.1, 10.1 to 10.5) issued further to the WP/SRC Task 102, the original sentence ".....the examination may be limited to a verification that the hard protective coating remains efficient....." has been replaced by ....that the corrosion prevention system remains efficient....". in a number of paragraphs (such as , for instance, Z 7.1, 4.2.3.1 a) ; Z 10.2 4.2.3.3 ; ), in line with IMO Res.A744(18).

2 - However, a corrosion prevention system is defined, in the same UR Z's and in IMO Res.A744(18) , as being either a full hard protective coating or a full hard protective coating supplemented by anodes.

3 - The above would mean that the survey of the anodes is a classification matter.

4 - However, whereas coating conditions are defined as good or fair or poor, there are no criteria in the IACS URs and IMO Res. A744(18) for the anodes condition.

5 - Assessing the anodes condition to confirm that they "remain efficient" looks to BV to be a quite difficult task for the ships in service Surveyor.

6 - Member's view and interpretations on the following would consequently be appreciated:

- do Members consider that the above requirements in IACS URs imply that survey of anodes is part of the classification ?
- do Members consider that the above requirements in IMO Res. A 744 (18) imply that survey of anodes is mandatory?
- if yes, what is the acceptance criteria to conclude that the anodes" remain efficient" ?

3.2 The majority of GPG Members replied that they did not include requirements for anodes in their class rules.

LR / ABS / DNV / KR / NK / RINA / RS were of the view that the condition of any anodes fitted should be recorded for information purposes as the survey of anodes is neither a classification matter nor a mandatory requirement in IMO A.744(18) and has no impact on future surveys (5037\_LRa). [Note; LR further clarified that "Whilst I agree that the performance of anodes is not normally a class matter LR does require that as part of Special Survey on oil tankers : "The attachment to the structure and condition of anodes in tanks are to be examined ." Therefore we cannot say that 'the survey of anodes is not a classification matter'. 5037\_LRb]



However, GL said that “for GL, anodes are a matter of class and as such are subject to plan approval as well as surveys. In case of missing or worn-out anodes we issue a condition of class”(5037\_GLa&b).

CCS advised that its rules have a general requirement relating to anode survey, which is only conducted, through sampling, during construction, docking survey or where there is a definite requirement for the survey of ballast tanks.

NK proposed that the following footnote be added to Z7s and Z10s:  
“The survey of anodes is not a classification matter.” No majority support was achieved.

#### **4. Conclusion**

RINA suggested to simply amend the definition of "Corrosion Prevention System" in paragraph 1.2.9 of UR Z7 (and, of course, the paragraphs in all the other UR Zs containing the definition of "Corrosion Prevention System") in order to eliminate any reference to anodes. This proposal would leave room for Societies willing to include additional class requirements for anodes to do so in their Rules.

GPG agreed.

### **RINA proposed amendments to paragraph 1.2.9 of UR Z7 and corresponding paragraphs in all other UR Zs (5037\_RIb, 6 April 2005)**

#### 1.2.9 Corrosion Prevention System

A corrosion prevention system is normally considered ~~either: a full hard protective coating, or~~  
~~1 a full hard protective coating, or~~  
~~2 a full hard protective coating supplemented by anodes.~~

Hard protective coating is usually to be epoxy coating or equivalent. Other coating systems may be considered acceptable as alternatives provided that they are applied and maintained in compliance with the manufacturer's specifications.

Where soft coatings have been applied, safe access is to be provided for the surveyor to verify the effectiveness of the coating and to carry out an assessment of the conditions of internal structures which may include spot removal of the coating. When safe access cannot be provided, the soft coating is to be removed.

[Annex: Council Chair's conclusive message.](#)

6 May 2005  
Permsec

## **Annex. (5037\_ICb, 15 May 2005)**

To : All IACS Council Members  
c.c : Mr. R. Leslie, IACS Permanent Secretariat

Ref. Mr G-Y. Han's message IAa dated 6 May 05  
Message ICa dated 6 May 05  
Admiral R.E. Kramek's message ABb dated 13 May 05

Paris La Défense, 15 May 05

- 1 - All Members have agreed with the texts attached to Mr Han's message.
- 2 - Further to ABS comments the reference to anodes is to be deleted in Annex I and in tables IX (IV) and IX(II).
- 3 - further to ABS questions regarding what IACS plan to do regarding IMO and A.744(18) further to IACS deletion of reference to anodes from the UR Z7's and UR Z10's it is to be noted that:

The Item 1.2.9 in UR Z10.1 and relative items in these URs states  
*1.2.9 10 Corrosion Prevention System: A corrosion prevention system is normally considered either:*

- .1 a full hard protective coating, or*
- .2 a full hard protective coating supplemented by anodes.*

*Hard Pprotective Ccoating is to usually to be epoxy coating or equivalent. Other coating systems may be considered acceptable as alternatives provided that they are applied and maintained in compliance with the manufacturer's specification.*

*Where Soft Coatings have been applied, safe access is to be provided for the surveyor to verify the effectiveness of the coating and to carry out an assessment of the conditions of internal structures which may include spot removal of the coating. When safe access cannot be provided, the soft coating is to be removed.*

- therefore the anodes are not considered as the main means of protection against the corrosion It is only a supplement;
- there is no provision in UR Z7's and Z10's to evaluate the level efficiency of the anodes;
- there is no specific requirements in case of lack of efficiency of the anodes.

The experience has shown that ballast tanks only protected by anodes are subject to corrosion when the anodes are becoming less efficient.

The anodes are active only when immersed by sea water. Therefore the upper part of the ballast tanks are not protected when the ballast is full of water and the ballast is not protected when it is empty..

The ships operators are reluctant to replace the anodes especially in upper part which request fitting of scaffolding fo welding the anode supports to the structure.

[The above arguments justify the reasons why IACS consider that the anodes are not class item.](#)

[4 - These arguments can be used by IACS Members](#) attending the WG bulk carriers at MSC 80 to try to obtain deletion of the reference to anodes in A. 744(18).

Best regards,

Bernard Anne  
IACS Council Chairman.

## **Technical Background**

**UR Z10.1(Rev.13, Jan 2006)**

**UR Z10.2(Rev.18, Jan 2006)-separate TB**

**UR Z10.3(Rev.8, Jan 2006)**

**UR Z10.4(Rev.3, Jan 2006)**

**UR Z10.5(Rev.2, Jan 2006)**

**Part 1. Z10s – para. 1.4 and 7.1.3**

**Part 2. Z10s – para. 5.5.4 and 5.5.6**

**Survey Panel Task 22 – Amend applicable URZ7s and Z10s to align Close-Up Survey and Thickness measurements to be carried out at the same time and location allowing for a more structured control of the thickness measurement process.**

**Technical Background**

**Z7(Rev.12)**

**Z7.1(Rev.3)**

**Z10.1(Rev.13, para.1.4 & 7.1.3)**

**Z10.2(Rev.18, para. 1.4 & 7.1.3)**

**Z10.3(Rev.8, para. 1.4 & 7.1.3)**

**Z10.4(Rev.3, para. 1.4 & 7.1.3)**

**Z10.5(Rev.2, para. 1.4 & 7.1.3)**

**1. Objective**

To amend the applicable URZ7s and Z10s to align Close-Up Survey and Thickness measurements to be carried out at the same time and location allowing for a more structured control of the thickness measurement process.

**2. Background**

IACS QC findings, through audits of numerous Societies, which indicated concerns over Surveyor attendance and control of thickness measurement processes.

**3. Methodology of Work**

Survey Panel members through correspondence.

**4. Discussion**

To align Close-up survey requirements and thickness measurements in the applicable URZ7s and URZ10s, in accordance with PR19, all Panel members agreed through correspondence and a final vote at the fall Survey Panel meeting, that URZ7, Z7.1, Z10.1, Z10.2, Z10.3, Z10.4 and Z10.5 should include in the applicable sections of the noted URs as proposed by the Survey Panel the wording “ In any kind of survey, i.e. special, intermediate, annual, or other surveys having the scope of the foregoing ones, thickness measurements of structures in areas where close-up surveys are required, shall be carried out simultaneously with close-ups surveys.”

**5. Implementation**

The Survey Panel is of the view that the Members need 12 months from the adoption date to implement these amendments into their class rules. Assuming that GPG and Council approve to the amendments, the Survey Panel would propose January 2007 as an implementation date.

## **Technical Background**

**UI SC 191 (Rev.2, Oct 2005)**

**&**

**UR Z10.1 (Rev.13, para.5.5.4 and 5.5.6, Jan 2006)**

**UR Z10.2 (Rev.18, para. 5.5.4 and 5.5.6, Jan 2006)**

**UR Z10.3 (Rev.8, para.5.5.4 and 5.5.6, Jan 2006)**

**UR Z10.4 (Rev.3, para.5.5.4 and 5.5.6, Jan 2006)**

**UR Z10.5 (Rev.2, para.5.5.4 and 5.5.6, Jan 2006)**

### **1. Objective**

- to confirm whether the guidelines for approval/acceptance of alternative means of access (now REC91, ex Annex to UI SC191) is mandatory or non-mandatory.
- to consider other safety related proposals.

### **2. Background**

The DNV proposal to submit the UI SC191(Rev.1, May 2005, Annex 1) to IMO DE49 triggered a number of discussion points that led to amendments to the following resolutions:

UI SC191(Rev.2)  
New REC 91  
REC 39(Rev.2)  
UR Z10s

### **Points of Discussion**

3. Is the Annex to UI SC191(Rev.1, May '05, guidelines for approval / acceptance of alternative means of access) mandatory or non-mandatory ?

Answer: Non-mandatory. Hence, re-categorized as new REC 91.

4. Limitation of use of rafts in bulk carrier holds

DNV proposed that conditions for rafting should be limited to areas, such as anchorage or harbour, where swell conditions are limited to 0.5m. After discussion, GPG approved the ABS' alternative proposal to use the swell condition as a basis to determine the appropriateness of rafting, instead of geographic areas(harbours or anchorage). 5.5.4 of Z10.2 refers.

RINA proposed that para 5.5.4 should be included in all the Z10s. NK's objection is recorded as follows (3037hNKq, 29/08/2005):

1. With regard to RIm of 26 August 2005, NK considers that the proposed amendment to 5.5.4 should be limited to UR Z10.2.
2. Rafting survey for tankers are actually carried out on the open sea from a discharge port to a loading port and in such situation the rise of water within the tanks would always exceed 0.25m. It is different situation from rafting survey for hold frames of bulk carriers normally conducted in a harbour or at an anchorage.
3. If the same requirement applies to tankers, any rafting survey for cargo oil tanks and ballast tanks of tankers would be prohibited. This is not practicable under present survey procedure for tankers.
4. Therefore, NK can not support Laura's proposal that the proposed amendment to 5.5.4 of UR Z10.2 is introduced into the other URs and new Recommendation.

For compatibility with the IMO's mandatory requirements\*, GPG decided to add the same amendment to all the UR Z10s.

\*

- Appendix 4 to MEPC.99(48) 'Mandatory requirements for the Safe Conduct of CAS Surveys'
- MSC.197(80) – amendments to A.744918), Annex A for DSS and SSS bulk carriers and Annex B for single and double hull oil tankers.

As a consequence, 5.5.1 of REC 91(ex Annex to UI SC191) was also amended:

- to remove the reference to dynamic /sloshing (as the 0.25m rise was considered negligible);
- to refer to the rafting conditions contained for cargo holds in Z10.2 and Z10.5 and for oil cargo tanks in Z10.1 and Z10.4.

5. Means of access from longitudinal permanent means of access within each bay to rafts

GPG reviewed the proposal that the following text be added to Z10s:

[A means of access to the longitudinal permanent platform from rafts or boats is to be fitted in each bay.](#)

(Technical Background: for the safety of surveyors)

There may be ships which are arranged in accordance with para b, page 8 of the Annex to the current SC 191 (i.e., no means of access from the LPMA in each bay to a raft is required) and therefore could not be rafted if the sentence proposed by RINA ("[A means of access to the longitudinal permanent platform from rafts or boats is to be fitted in each bay](#)") is included in the Z10's.

GPG therefore agreed not to include this sentence in Z10s.

For the same reason, the same sentence was not added to Rec.39.

Finally, GPG added the following sentence to UI SC191(interpretation for II-1/3-6):

*A permanent means of access from the longitudinal platform to the water level indicated above is to be fitted in each bay (e.g permanent rungs on one of the deck webs inboard of the longitudinal permanent platform).*

## **6. Implementation**

It was agreed that the revised UI SC191 be implemented to ships contracted for construction 6 months after adoption by Council.

UI SC191 was also edited in line with IMO MSC/Circular. 1176, leaving its mandatory language (is/are to, shall) unchanged.

(Note: UI SC191(Rev.2) makes references to the following new Recommendations:

- REC 90: Ship Structure Access Manual
- REC 91: Guidelines for approval/acceptance of Alternative Means of Access)

23 September 2005  
Permanent Secretariat  
Updated on 13 Oct 2005.

## **Technical Background**

### **UR Z10.1 (Rev.14), UR Z10.2 (Rev.23), UR Z10.4 (Rev.5) & UR Z10.5 (Rev.5)**

#### **Survey Panel Task 3 – Maintenance of Alignment/ Compatibility of IACS URs and IMO survey requirements**

##### **1. Objective**

Maintenance of alignment/compatibility of IACS URs and IMO survey requirements regarding resolution MSC 197(80) – amendments to A744(18)

##### **2. Background**

IMO survey requirements to ESP vessels as amended in A744(18) as noted in MSC 197(80), with an implementation date of 1 January 2007.

##### **3. Methodology of Work**

Survey Panel members through correspondence.

##### **4. Discussion**

Survey Panel members, at the fall 2006 Survey Panel meeting, finalized the amendments to the applicable URs due to changes adopted at MSC(80). Additionally, Members noted that URZ10.4 paragraphs 2.2.3.1 and 4.2.2.2 does not require examination of ballast tanks adjacent to heated fuel tanks, as required by MSC197(80). The survey panel agreed that if this is the position that IACS would like to take regarding double hull tankers, then it should be brought to the attention of IMO at the next IMO meeting, DE50 in March 2007.

##### **5. Implementation**

The Survey Panel is of the view that the Members need 12 months from the adoption date to implement these amendments into their class rules. Assuming that GPG and Council approve the amendments, the Survey Panel would propose January 2008 as an implementation date, although the IMO implementation date is January 2007.

Submitted by Survey Panel Chairman  
9 January 2007

##### **GPG discussion**

All members agreed to omit the requirement of examination of ballast tanks adjacent to heated fuel tanks, as required by MSC197(80), from URZ10.4 for double hull tankers and



that it should be brought to the attention of IMO at DE50. In addition ABS proposed that paragraphs relating to similar requirements in URZ10.1 should also be deleted for consistency and this was agreed by members.

Members also made a number of minor/editorial corrections to the text prior to their approval of the revised documents.

Added by Permanent Secretariat  
23 April 2007

## **Technical Background**

**URs Z7(Rev.15), Z7.1(Rev.5), Z7.2(Rev.1), Z10.1(Rev.15),  
Z10.2(Rev.26), Z10.3(Rev. 9), Z10.4(Rev.6), Z10.5(Rev.8) – November  
2007**

### ***Survey Panel Task 1 – Annual Review of Implementation of IACS Resolutions***

#### **1. Objective**

To review IACS Resolutions annually and discuss or propose amendments as deemed necessary.

#### **2. Background**

This proposed amendment to all URZ7s and URZ 10s was raised by the Panel member from DNV due to Owners crediting tanks concurrently under intermediate and special survey.

#### **3. Methodology of Work**

Survey Panel members through correspondence.

#### **4. Discussion**

The Panel member from DNV raised the issue of Owners having the ability of crediting spaces and thickness measurements only once in a 54 month interval, due to the availability of concurrent crediting of spaces and thickness measurements due to the flexible time window that is currently allowed between the intermediate survey and the special survey.

After a presentation and discussion lead by the DNV Panel member, all Survey Panel members agreed to the argument given by DNV, and further agreed to make the necessary changes in all URZ7s and URZ10s where Owners are not allowed to concurrently credit surveys and thickness measurements of spaces.

#### **5. Implementation**

The Survey Panel is of the view that the Members need 12 months from the adoption date to implement these amendments into their class rules. Assuming that GPG approve to the amendments, the Survey Panel would propose January 2009 as an implementation date.

Submitted by Survey Panel Chairman  
22 October 2007

**Permanent Secretariat note (December 2007):**

During GPG discussion DNV proposed that *“since this matter will be discussed between Owner and Class mainly in connection with the forthcoming Special Survey, DNV would prefer to locate this text, not only as part of Intermediate Survey, but also as a new text for the Special Survey.”* This was supported by BV, ABS, RINA and KR.

The revised documents were approved, with DNV’s proposal and an implementation date of 1 January 2009, on 15 November 2007 (ref. 7690\_IGb).

## Technical Background

### URs Z7(Rev.16), Z7.1(Rev.6), Z7.2(Rev.2), Z10.1(Rev.16), Z10.2(Rev.27), Z10.3(Rev.11), Z10.4(Rev.7) and Z10.5(Rev.9) - March 2009

#### Survey Panel Task 62:

- A) *Harmonization of UR Z10.1, Z10.2, Z10.4 and Z10.5 with UR Z10.3 with respect to items 5.5.4.4 and 5.6.2.*
- B) *Harmonization of UR Z7, Z7.1, Z10.1, Z10.2, Z10.3, Z10.4 and Z10.5 with UR Z7.2 with respect to the definition of the corrosion prevention system and with respect to the footnote 1 related to semi-hard coatings.*
- C) *Harmonization of the definition of Ballast Tank in UR Z7(Rev.14)*

#### 1. Objective

- A) Amend the texts of items 5.5.4.4 and 5.6.2 in Unified Requirements Z10.1, Z10.2, Z10.4 and Z10.5 in order to align them with those in UR Z10.3, in which they were changed while performing Task 55, whereas in the other UR Z10s they were kept unchanged on the grounds that this change was out of the scope of Task 55.
- B) Amend the definition of “Corrosion Prevention System” and include a Footnote 1 related to semi-hard coatings in Unified Requirements Z7, Z7.1, Z10.1, Z10.2, Z10.3, Z10.4 and Z10.5 in order to align them with those adopted in UR Z7.2, when this new UR was issued.
- C) Amend UR Z7 (Rev. 14) in all items where the term “Ballast Tank” is used in order to get them harmonized with the definition itself.

#### 2. Background

The task, as regards item A), was triggered by a Member Society, while performing Task 55, on the grounds that this part was out of the scope of the task and then should have been dealt with in a separate task.

The task, as regards item B), was triggered as a consequence of the “New Business action item 2” of the Minutes of the September 2008 Survey Panel meeting, for sake of harmonization of the various URZs.

The task, as regards item C), was triggered as a consequence of the “Task 54-Examination of Double Bottom Ballast Tanks at annual surveys” of the Minutes of March 2008 Survey Panel meeting, for sake of harmonization of the definition of Ballast Tank in UR Z7(Rev.14).

#### 3. Discussion

The task was carried out by correspondence. All the amended texts for the affected URs were prepared by the Survey Panel Member who had chaired the PT on Task 55, in accordance with the Form A approved by GPG. In addition to the objectives outlined in the Form A, an amendment was added to item 1.3.1 of UR Z10.2 and UR Z10.5 in which the reference 3.2.3.6 in the last item of the list was replaced by 3.2.3.10 as can be correctly verified in the text.

The amended URs were circulated to all Survey Panel Members for review, comments and agreement. The texts of the URs were unanimously agreed by all Members.

#### **4. Implementation**

The Survey Panel is of the view that the Member Societies need at least 12 months from the adoption date to implement these amendments into their class rules/procedures. Therefore, in the first version of all amended URs the following implementation sentence should be proposed:

*Changes introduced in Rev .xx are to be uniformly applied by Member Societies and Associates for surveys commenced on or after [not less than 12 months after the adoption by GPG/Council].*

Since it is common practice and convenience to have implementation dates either on 1<sup>st</sup> January or on 1<sup>st</sup> July of the year, the Survey Panel proposes the 1<sup>st</sup> July 2010 as implementation date, if GPG/Council approve the URs not later than 30 June 2009.

**Submitted by Survey Panel Chairman  
28 February 2009**

#### **Permanent Secretariat notes (April 2009):**

1. The amended URs were approved by GPG on 18 March 2009 (ref. 7718bIGd).
2. During the typesetting process it was noted that para 5.1.5 of UR 7.2 was inconsistent with the amended URs and so following consultation with the Survey Panel this was also amended at this time.
3. Regarding the implementation date, GPG agreed to use 1<sup>st</sup> July 2010 provided that it was consistently used for the amended URs.

## **Technical Background document for UR Z10.1 Rev.17 (Feb 2010)**

### **1. Scope and objectives**

To amend UR Z10.1 (Rev.16) for the harmonization with currently revised MARPOL Annex I.

### **2. Engineering background for technical basis and rationale**

-

### **3. Source/derivation of the proposed IACS Resolution**

- MARPOL 73/78
- IACS UR Z10.1 (Rev.16)

### **4. Summary of Changes intended for the revised Resolution:**

As MARPOL I was revised, the reference to MARPOL I/13 (3) in paragraph 1.2.2bis should read MARPOL I/18(3).

### **5. Points of discussions or possible discussions**

None

### **6. Attachments if any**

N/A

## **Technical Background for UR Z10.1 Rev.18 (Mar 2011)**

### **1. Scope and objectives**

- 1) To amend UR Z10.1 to harmonize the definition of transverse section.
- 2) Update of references in the Executive Hull Summary Table IX.

### **2. Engineering background for technical basis and rationale**

- 1) Based on that fact that bulk carriers and oil tankers have a transverse framing system applied for example on ship's sides etc. and that UR Z7 is applied to all types of ships and includes an extended definition of transverse section it is necessary to unify this definition in UR Z10s.
- 2) Update of references in the Executive Hull Summary Table IX such that the introduction of extended annual surveys is noted in the 'Memoranda' section rather than under 'Conditions of Class'.

### **3. Source/derivation of the proposed IACS Resolution**

IACS UR Z7.

### **4. Summary of Changes intended for the revised Resolution:**

- 1) The following additional text is added to the definition of transverse section in para 1.2.5:

*"For transversely framed vessels, a transverse section includes adjacent frames and their end connections in way of transverse sections."*

- 2) In the Executive Hull Summary Table IX (iv) the reference to part H) is updated to part I) as per Table IX (ii).

### **5. Points of discussions or possible discussions**

None.

### **6. Attachments if any**

None.

## **Technical Background for UR Z10.1 Rev.19, July 2011**

### **1. Scope and objectives**

Review the requirement for repairs within IACS UR 7 and UR 10 series, in particular the requirement for Prompt and Thorough Repair, with a view to developing wording that would permit a temporary repair and the imposition of a Recommendation/ Condition of Class under specific and controlled circumstances, and in accordance with PR35.

### **2. Engineering background for technical basis and rationale**

There are instances, for example a localised, isolated and very minor hole in a cross-deck strip, at which a suitable temporary repair, for example by welding or doubling, and the imposition of a suitable short term Recommendation/ Condition of Class for permanent repair at a later date, are considered very adequate methodology for dealing with the defect.

Current IACS Requirements in the UR Z7 and Z10 series, for Prompt and Thorough repair, would not permit this to be an option, the defect would have to be permanently Promptly and Thoroughly repaired, which might require removing cargo, moving to a repair berth and staging inner spaces.

Under the Requirements of IACS Procedural Requirement PR 35 the methodology of Temporary Repair and imposition of a suitable short term Recommendation/ Condition of Class for permanent repair at a later date is fully permissible.

### **3. Source/derivation of the proposed IACS Resolution**

Based upon discussion within the IACS Survey Panel.

### **4. Summary of Changes intended for the revised Resolution:**

Following the definition of Prompt and Thorough Repair in the Unified Requirement, a new paragraph is proposed to be added:-

"1.3.3 Where the damage found on structure mentioned in Para. 1.3.1 is isolated and of a localised nature which does not affect the ship's structural integrity, consideration may be given by the surveyor to allow an appropriate temporary repair to restore watertight or weather tight integrity and impose a Recommendation/Condition of Class in accordance with IACS PR 35, with a specific time limit."

### **5. Points of discussions or possible discussions**

a) The points of discussion are as indicated in Sections 2 and 4 above.

b) Discussion took place on whether to prepare this amendment as a Unified Interpretation of IMO Resolution A.744(18)/UR Z7 and Z10 series, finally it was agreed to make direct amendment to the relevant URs.



c) It is proposed that this amendment be submitted directly to the IMO DE/MSC Committees for consideration of amending directly IMO Res. A744(18)

**6. Attachments if any**

None

## **Technical Background for UR Z10.1 Rev.21, Jan 2014**

### **1. Scope and objectives**

- a) To consider appropriate text in IACS document regarding class period for lengthy conversions.
- b) To align the requirements in PR37 and UR Z10s regarding safe entry to confined spaces.

### **2. Engineering background for technical basis and rationale**

- a) As per the IMO Res. A1053 (27), lengthy conversions (not necessarily of major character) or other major repair work can be assigned for a 5 year period from the date of completion of conversion/repairs/surveys.
- b) Safety requirements in IACS PR37 can be applied to carry out survey in safe way for all kind of ships. When there are no indications about the safety of surveyor in UR Z10s then the requirements in PR37 shall be applied.

### **3. Source/derivation of the proposed IACS Resolution**

None

### **4. Summary of Changes intended for the revised Resolution**

- a) Following additional text was included to section 2.1.3 to clarify the class period for lengthy conversions

"In cases where the vessel has been laid up or has been out of service for a considerable period because of a major repair or modification and the owner elects to only carry out the overdue surveys, the next period of class will start from the expiry date of the special survey. If the owner elects to carry out the next due special survey, the period of class will start from the survey completion date."

- b) Existing Section 5.2.6 and 5.2.7 were deleted from UR Z10s since provisions of these sections were covered by PR37. Reference of PR37 was included in Section 5.2.1.1.

### **5. Points of discussions or possible discussions**

- i) Additional text to Para.2.1.3 was discussed in order to clarify class period.
- ii) Panel considered that safety of surveyors should be dealt by PR37.

### **6. Attachments if any**

None

## UR Z10.2 "Hull Surveys of Bulk Carriers"

### Summary

This revision is to harmonize the revised requirements in line with the amendments made to ESP Code vide Res.MSC.525(106)

### Part A. Revision History

Version no.	Approval date	Implementation date when applicable
Rev.37 (Feb 2023)	08 February 2023	1 July 2024
Rev.36 (May 2019)	30 May 2019	1 July 2020
Rev.35 (Jan 2018)	15 January 2018	1 January 2019
Rev.34 (Sep 2017)	26 September 2017	1 January 2019
Rev.33 (Nov 2016)	22 November 2016	1 January 2018
Rev.32 (Feb 2015)	05 February 2015	1 July 2016
Rev.31 (Jan 2014)	14 January 2013	1 January 2015
Rev.30 (June 2013)	05 June 2013	1 July 2014/1 July 2016 *3
Rev.29 (Jul 2011)	27 July 2011	1 July 2012
Rev.28 (Mar 2011)	24 March 2011	1 July 2012
Rev.27 (Mar 2009)	18 March 2009	1 July 2010
Rev.26 (Nov 2007)	15 November 2007	1 January 2009
Rev.25 (Jul 2007)	19 July 2007	1 July 2008
Rev.24 (Apr 2007)	12 April 2007	1 July 2008
Rev.23 (Feb 2007)	10 February 2007	1 January 2007 / 1 January 2008 *1
Rev.22 (Jun 2006)	23 June 2006	1 July 2007
Rev.21 (May 2006)	11 May 2006	1 July 2007
Rev.20 (Feb 2006)	10 February 2006	1 January 2007
Rev.19 (Jan 2006)	31 January 2006	1 January 2007
Rev.18, Corr.1 (Jan 2006)	11 January 2006	1 January 2007
Rev.18 (Jan 2006)	4 January 2006	1 January 2007
Rev.17 (Jun 2005)	27 June 2005	1 July 2006
Rev.16 (Feb 2004)	23 February 2004	1 January 2005
Corr.1 (Feb 2004)	23 February 2004	1 January 2004
Rev.15 (Dec 2003)	23 December 2003	
Rev.14 (Aug 2003)	8 August 2003	
Rev.13 (Oct 2002)	22 November 2002	
Rev.12 (Mar 2002)	19 March 2002	1 January 2003 / 1 July 2002 / 1 year after Council adoption *2
Rev.11.1 (Jun 2001)	22 June 2001	1 July 2001
Rev.11 (Nov 2000)	23 November 2000	1 July 2001
Rev.10.1 (Sept 2000)	29 September 2000	
Rev.10 (Sept 2000)	14 September 2000	1 July 2001
Rev.9 (July 1999)	16 July 1999	1 September 1999

Rev.8 (April 1998)	No record	Not later than 1 July 1998
Rev.7 (1997)	10 December 1997C36	
Rev.6 (1996)	No record	Not later than 1 January 1997
Rev.5 (1996)	No record	Not later than 1 January 1997
Rev.4 (1996)	No record	Not later than 1 January 1997
Rev.3 (1995)	No record	
Rev.2 (1994)	No record	
Rev.1 (1994)	No record	
NEW (1992)	No record	

**\* Notes:**

1. Changes introduced in Rev.23 are to be uniformly implemented for surveys commenced on or after 1 January 2008, whereas statutory requirements of IMO Res. MSC 197(80) apply on 1 January 2007.
2. The amendments to Table I and 4.2.3 introduced in Rev.12 are to further increase the requirements for close-up survey at Special Survey No.2 and to require the scope of the Intermediate Survey thereafter to have the scope of Special Survey No.2. These requirements are to be implemented for any Special Survey No.2 or the Intermediate Survey subsequent to Special Survey No.2 commenced after 1 January 2003.  
Paragraph 4.2.4.3 is newly introduced in Rev.12 in accordance with Res.MSC 105(73) and is to be implemented from 1 July 2002.  
The other changes introduced in Rev.12 are to be implemented within one year of the adoption by Council.
3. The changes to section 6 introduced in Rev.30 are to be uniformly applied by IACS Societies for surveys commenced on or after 1 July 2016.  
The other changes introduced in Rev.30 are to be uniformly applied by IACS Societies for surveys commenced on or after 1 July 2014.

• **Rev. 37 (Feb 2023)**

**1 Origin of Change:**

- o Suggestion by an IACS member
- o Based on IMO Regulation

**2 Main Reason for Change:**

To revise the definition of Ballast tank from use of 'solely' carriage of salt water to 'primarily' use in line with other IACS URs and ESP Code.

To revise the criteria for annual examination of ballast tanks from POOR condition to condition less than GOOD in line with the amendments made to ESP Code vide Res.MSC.525(106).

To refine the wording of ballast tanks examination requirements at annual surveys in line with the amendments made to ESP Code vide Res.MSC.525(106).

To revise a reference changed to IACS Recommendation in line with other IACS URs and the amendments made to ESP Code vide Res.MSC.525(106).

**3 List of non-IACS Member classification societies contributing and/or participating in IACS Working Group:**

None

#### **4 History of Decisions Made:**

- One survey panel member pointed out the definition of ballast tank in UR 10s are different from other URs like UR7/7.1/7.2 and the ESP Code, so panel decided to modify the wording 'solely' to 'primarily'. (PSU20004)
- Due to the marine casualty of M/V"STELLAR DAISY", enhancement of ballast tank examination for bulk carriers, that increase the criteria of annual examination from 'POOR' condition to the condition less than 'GOOD', was submitted to SDC8. Although IACS has objected to the view and submitted commenting papers continuously, the proposal was agreed at SDC8 and published as Res.MSC.525(106).
- One survey panel member suggested to refine the wording 'extended annual/intermediate survey' to 'examination of ballast tanks at annual surveys' in Executive Hull Summary and panel decided to modify it in the ESP Code first. It was submitted to SDC8 and included in Res.MSC.525(106). (PSU18056)
- One survey panel member pointed out that the references in UR Z10s need to updated (referred documents have been changed to IACS Recommendations) and deleted to be in line with other UR Z10s. And panel decided to delete the reference of itself in UR Z10.2 in line with the amendments made to ESP Code vide Res.MSC.525(106). (PSU19057)

No TB is expected for the present revision.

#### **5 Other Resolutions Changes:**

Unified Requirements: Z10.2, Z10.4 and Z10.5

#### **6 Any hinderance to MASS, including any other new technologies:**

None

#### **7 Dates:**

Original Proposal:	28 January 2020	(PSU20004)
	24 October 2017	(PSU18056)
	18 December 2019	(PSU19057)
Panel Approval:	12 October 2021	(PSU21026_ISUf)
GPG Approval:	08 February 2023	(22198_IGd)

## **Rev. 36 (May 2019)**

### **.1 Origin of Change:**

- o Suggestion by an IACS member

### **.2 Main Reason for Change:**

This revision is to address the policy decision made by GPG using the common terminology 'Condition of Class' (CoC) instead of the terms 'Recommendation/Condition of Class' based on the outcome of III 5.

### **.3 List of non-IACS Member classification societies contributing through the TC Forum and/or participating in IACS Working Group:**

None

### **.4 History of Decisions Made:**

During the 29th panel meeting, the panel discussed about the comments of members, and concurred with the view to retain the present definitions of CoC in the IACS resolutions with the wording 'Recommendation' to be removed. The panel also agreed to use the term 'Statutory Condition' for the 'recommendation' of the statutory certificates in IACS resolutions and RECs, and when discussing the proposal of a member to consider the harmonization of the terms of 'recommendation' and 'condition of class' in RO Code, the panel unanimously agreed to take no action on the IMO instruments, leaving the relevant actions to be decided by the relevant IMO bodies when IACS feeds back to IMO the IACS action on the harmonization of the two terms.

Panel members concurred with the view that it is not necessary to develop a new procedure requirement, and agreed to set the implementation date of these IACS resolutions (other than RECs) as 1st July 2020.

Before the implementation date of 1st July 2020 for using the common terminology 'Condition of Class' only, 'Recommendations' and 'Condition of Class' are to be read as being different terms used by Societies for the same thing, i.e. requirements to the effect that specific measures, repairs, surveys etc. are to be carried out within a specific time limit in order to retain Classification.

No TB is expected for the present revision.

### **.5 Other Resolutions Changes:**

The following IACS resolutions and Recommendations (RECs) were agreed to be revised:

- Procedural Requirements: PR1A, PR1B, PR1C, PR1D, PR1 Annex, PR3, PR12, PR20, PR35 and the attachment of PR16;
- Unified Requirements: Z7, Z7.1, Z7.2, Z10.1, Z10.2, Z10.3, Z10.4, Z10.5, Z15 and Z20
- Unified Interpretations: GC13
- Recommendations: Rec.41, Rec.75, Rec.96, Rec.98

**.6 Any hinderance to MASS, including any other new technologies:**

None

**.7 Dates:**

Original Proposal: 14 January 2019 tasked by GPG (17044bIGm)

Panel Approval: 22 March 2019 (PSU19010)

GPG Approval: 30 May 2019 (17044bIGu)

**• Rev.35 (Jan 2018)**

**.1 Origin of Change:**

- Suggestion by an IACS member

**.2 Main Reasons for Change:**

In order to introduce new provisions into the ESP Code which were found among the ESP Code and relevant URZ10s, a series of items of UR Z10s shall be amended accordingly with ESP Code.

**.3 List of non-IACS Member Classification Societies contributing through the TC Forum and/or participating in IACS Working Group:**

None

**.4 History of Decisions Made:**

Panel members discussed this issue under PSU17018: updating the CSR reference for both HCSR and CSR for Bulk Carriers; figures 6 in paragraph 7.3 and figure 4 in paragraph 4.3 of Annex V were to be replaced with new accurate figures; Item 31 in sheet 12 of Annex 2 was to be deleted and renumbered other items as well; The item 1 in Notes to TM6-BC of Annex 2 was to be replaced with correct text; The paragraphs 3.2.1.1, 3.2.3.4 and 3.2.3.6 were to be revised for consisting with ESP Code; "Thickness measurement company" was to be replaced with "Thickness measurement firm" throughout the UR; etc.

During the 26<sup>th</sup> Survey Panel Meeting, the Panel discussed the divergence and reached agreements with the revisions.

No TB is expected for the present revision.

**.5 Other Resolutions Changes**

UR Z10.1, UR Z10.3, UR Z10.4, UR Z10.5

## **.6 Dates:**

Original Proposal: 22 October 2016 by a Survey Panel Member  
Panel Approval: 24 December 2017 by Survey Panel (Ref: PSU17018)  
GPG Approval: 15 January 2018 (Ref:17189\_IGc)

## **• Rev.34 (Sep 2017)**

### **.1 Origin of Change:**

- Suggestion by an IACS member

### **.2 Main Reasons for Change:**

To introduce the criteria for the steel renewal which belongs under the unified requirements of series S and are related to the net scantling approach.

To introduce the method for close-up surveys of the cargo hold shell frames of bulk carriers 100,000 dwt and above.

### **.3 List of non-IACS Member Classification Societies contributing through the TC Forum and/or participating in IACS Working Group:**

None

### **.4 History of Decisions Made:**

A member noted that some Unified Requirements of series S (Strength of Ships), such as UR S18, contain criteria addressing the steel renewal for dedicated structures such as transverse bulkheads, cargo hatch coamings and plating. These criteria (based on the net scantling approach) are applicable also to units designed with the gross scantling approach because they refer to particular structures for which it is foresaw the dimensioning (or the design verification) according to the net scantling approach.

During the 24<sup>th</sup> Survey Panel Meeting the members agreed to review all UR of the S series in order to identify those containing any steel renewal criteria with the scope to review them.

Having found that UR S18, UR S19 and UR S21 contain steel renewal criteria that need to be taken in to account during the thickness measurements review process, the members agreed that a new paragraph dealing with this issue needed to be added under section 8 of UR Z10.2.

The paragraph 8.1.2, "Thickness measurements Acceptance Criteria", has been agreed and inserted in the present revision of UR Z10.2.

A Member proposed the modification of paragraph 5.3.4 of the UR Z10.2 in order to include in the list of the means of access to the upper part of the cargo hold side shell frames, of bulk carrier having DWT equal or more 100000, also the use of the cherry picker by taking in account that the maximum allowed working height should not be more than 17 m (according to the provisions set in IACS Recommendation 136).



Members reviewed the history file related to UR Z10.2 and found that the prohibition of the use of cherry pickers (hydraulic arms and similar equipment) on board of ships, having DWT equal or more 100000, was knowingly decided by the Panel following to an incident occurred to the ship CAPE AFRICA. Members discussed the issue during the 23rd meeting and concurred that in order to modify the UR Z10.2 it need a solid background which may counterweighted the negative issue of the CAPE AFRICA. So Members agreed to prepare a questionnaire to distribute to the qualified and experienced (on ESP bulk carriers) surveyors of each classification Society. The aim of the questionnaire is to build a solid background based on the interview to the personnel which daily operates on board.

The questionnaire was sent to each Society on May 2016 and 413 replies received. Members used the result of the consultation to decide whether the paragraph 5.3.4 of the UR Z10.2 might be modified according to the proposal.

The paragraph 5.3.4" The use of hydraulic arm vehicles or aerial lifts ("Cherry picker")" has been agreed and inserted in the present revision of Z10.2.

No TB is expected for the present revision.

## **.5 Other Resolutions Changes**

UR Z7, UR Z7.1, UR Z10.5

## **.6 Dates:**

Original Proposal:	01 July 2016 Made by a Survey Panel Member
	09 September 2016 (24 <sup>th</sup> Survey Panel meeting)
	Made by a Survey Panel Member
Panel Approval:	25 August 2017 (Ref: PSU16044 and PSU16002)
GPG Approval:	26 September 2017 (Ref: 17107aIGb)

## **• Rev.33 (Nov 2016)**

### **.1 Origin of Change:**

Suggestion by IACS members

### **.2 Main Reasons for Change:**

To address the Observation 04, raised by the IMO Auditing Team 5 of the IACS common package 1 in respect to the functional requirements (FR) 9-15.

### **.3 List of non-IACS Member Classification Societies contributing through the TC Forum and/or participating in IACS Working Group:**

None

#### **.4 History of Decisions Made:**

Based upon a GPG Member's proposal, the Panel examined, under the task PSU16017, the possible modification of the UR Z10.2 in order to include the verification of the Ship Construction File (SCF) during the class periodical surveys for those ships subjected to the requirements of SOLAS reg. II-1/3-10.

The suggested text was discussed by the Members and it was agreed that since the issue might be regarded as a proactive extension of the corrective action to OBS 04 this should be inserted under paragraph 6.4.2 of UR Z10.2.

Members reviewed the proposed text together with the relevant proposals of its modification; during the 24th Survey Panel meeting agreed to add the new paragraphs 6.4.2.1 and 6.4.2.2 dealing with the verifications of the Ship Construction File to be performed during the periodical surveys.

No technical background is expected for this revision.

#### **.5 Other Resolutions Changes**

The amendment affects UR Z10.4 and UR Z 10.5.

#### **.6 Dates:**

Panel Approval: 09 September 2016 - 24th Survey Panel Meeting  
GPG Approval: 22 November 2016 (Ref: 16077\_IGd)

#### **• Rev.32 (Feb 2015)**

##### **.1 Origin of Change:**

- Suggestion by IACS members

##### **.2 Main Reasons for Change:**

- a) To consider appropriate text in IACS document regarding the applicability of the Thickness Measurements when the Close up survey is performed.
- b) To consider the impracticability of the internal structure close up inspection of cargo hold hatch covers which have no access structurally (from the approved design) and it is possible to survey and gauge plating only.

##### **.3 List of non-IACS Member classification societies contributing through the TC Forum and/or participating in IACS Working Group:**

None

#### **.4 History of Decisions Made:**

- a) Following an ACB query an IACS member proposed to add suitable text in appropriate IACS documents regarding the application of the Thickness Measurements when the close up surveys are performed as survey requirement due at the Intermediate/ Renewal Class surveys. This Member expressed the view

that the requirements to execute the Thickness Measurements of the area subject to Close Up Surveys are expected into the table relevant to "MINIMUM REQUIREMENTS FOR THICKNESS MEASUREMENTS AT SPECIAL SURVEY ....." while the paragraph 1.4 of the document contains only the requirement that "Thickness Measurements of the areas subject to close up surveys shall be taken in conjunction with the close up survey".

Panel discussed the matter under item PSU13051 and considered that wordings of Para 1.4 of current UR Z7s/10s need to be revised in order to clarify this issue; finally Panel agreed to add additional wording to Para.1.4.

- b) Panel, following the proposal submitted by a Member, concurred and agreed that in case the cargo hold hatch covers have a configuration that does not permit the ingress of the surveyor for the internal inspection (e.g. box type panel), the close up survey should be limited to external parts as well as the Thickness Measurements that should be performed only on the external plating. The technical background, on which is based the modification of the requirement, is that the internal structure of a hatch cover of box type construction are reasonably not subject to any corrosion phenomenon. Hence, unless the external plating of the box is damaged, no depletion of the internal structures is expectable.

Panel discussed the matter under item PSU13051 and considered that an explanation note to Para 2.2.4.1 and to Table 1 of current UR Z10.2 need to be added to clarify this issue.

## **.5 Other Resolutions Changes**

The amendment a) affects UR Z7, UR Z7.1, UR Z7.2, UR Z10.1, UR Z10.3, UR Z10.4 and UR Z 10.5.

The amendment b) affects also UR Z 7.1 and UR Z 10.5.

## **.6 Dates:**

Panel Approval: Amendment a) at 19th Survey Panel Meeting (6 March 2014)  
Amendment b) by correspondence under PSU 13051  
GPG Approval: 05 February 2015 (Ref: 14193\_IGc)

## **• Rev.31 (Jan 2014)**

### **.1 Origin of Change:**

- Suggestion by IACS members
- Suggestion by GPG

### **.2 Main Reason for Change:**

- a) To consider appropriate text in IACS document regarding class period for lengthy conversions.

- b) To align the difference between PR37 and URZ's regarding safe entry to confined spaces.

**.3 List of non-IACS Member classification societies contributing through the TC Forum and/or participating in IACS Working Group:**

None

**.4 History of Decisions Made:**

- a) With reference to IMO Res. A1053 (27) (5.5 Application of "special circumstances") an IACS member proposed to add suitable text in appropriate IACS document regarding class period for lengthy conversions. This Member expressed that when a renewal survey has been completed, the new 5 year class period would normally be calculated from the expiry of previous class period/class certificate and in some cases this might result in unreasonably short time from one renewal survey completion until the next renewal would be due.

Panel discussed and considered that wordings of Para 2.1.3 of current UR Z7s/10s (second sentence) could address this issue but finally agreed to add additional text to Para 2.1.3 in order to clarify this matter. (PSU13024)

Panel discussed to clarify the survey requirements in PR37 and URZ's regarding safe entry to confined spaces. Panel considered that the safety issues of surveyor should be dealt by PR37. At 18<sup>th</sup> Panel meeting, Panel concluded to delete requirements from UR Z10s which were already covered by the PR37. (PSU13032)

**.5 Other Resolutions Changes**

- a) The identical amendment affects UR Z7, UR Z7.1, UR Z7.2, UR Z10.1, UR Z10.3, UR Z10.4 and UR Z 10.5.  
b) The identical amendment affects UR Z10.1, UR Z10.3, UR Z10.4 and UR Z 10.5.

**.6 Dates:**

Panel Approval: 7 November 2013 by Survey Panel  
GPG Approval: 14 January 2014 (Ref: 12011aIGd)

**• Rev.30 (June 2013)**

**.1 Origin of Change:**

- Suggestion by an IACS Member
- Suggestion by GPG in response to the request of EG/SoS
- Suggestion by EG/GBS in response to GPG Chairman's request in 10060fIGg.

## **.2 Main Reason for Change:**

- a) An inquiry from a member whether the 'Other equivalent means' referred in Para 5.3.2 of IACS UR Z10.2 include the use of Cherry Pickers for survey of other structures. (PSU 12022)
- b) To introduce provision in UR Z10s that Rescue and emergency response equipment must be suitable for the configuration of the space being surveyed including the size of the access points.(PSU 12032, GPG 12138\_)
- c) In order to comply with the IMO Goal Based Standard (GBS), it is required to update the Ship Construction File (SCF) throughout the ship's service life. Therefore, procedures for updating SCF have been added in UR Z10s.

## **.3 List of non-IACS Member classification societies contributing through the TC Forum and/or participating in IACS Working Group:**

None

## **.4 History of Decisions Made:**

- a) Discussion of this matter initiated by a Panel member regarding the use of Cherry Pickers in Cargo Holds with reference of IACS URZ10.2. In accordance with UI SC191 and Rec 91, the Cherry Picker is allowed up to 17m height for Cargo Hold structure (ships constructed after 2006 for Alternative means of access). As per the provisions of URZ10.2, Cherry pickers are allowed for survey of side shell frames only.

Panel discussed and considered that Para 5.3.2 of UR Z10.2 allows the use of Cherry Pickers as 'Other equivalent means'. Accordingly, Panel agreed to clarify this matter by including text "hydraulic arm vehicles such as conventional cherry pickers" to UR Z10s and UR Z7s for a ship not subject to the above 17m restriction.

- b) GPG Chairman requested to consider the suggestion of EG/SoS to clarify the wording in UR Z 10.1 – 10.5 to make it compliance with draft PR37 submitted by EG/SoS.

The Survey Panel discussed this matter and introduced a new (sub-)section 5.5 "Rescue and emergency response equipment" in line with the suggestion of EG/SOS.

- c) At the time of reviewing the revised UR Z23 which is followed only for new construction, PT/GBS proposed that URZ10s should have provisions for updating Ship Construction File (SCF) since it would be maintained throughout the ship's service life.

Survey Panel at its 17<sup>th</sup> meeting discussed the proposals of PT/GBS for the revision of UR Z10s in order to comply the IMO GBS requirements for existing vessels. Panel agreed to add new text in URZ10.2 for updating and monitoring the SCF.

## **.5 Other Resolutions Changes**

- a) The identical amendment affects UR Z7, UR Z7.1, UR Z10.1, UR Z10.3, UR Z10.4 and UR Z 10.5.
- b) The identical amendment affects UR Z10.1, UR Z10.3, UR Z10.4 and UR Z 10.5.
- c) The identical amendment affects UR Z10.4 and UR Z10.5.

## **.6 Dates:**

Survey Panel Approval: 7 March 2013 (17<sup>th</sup> Survey Panel meeting)

GPG Approval: 22 May 2013 (Ref: 9640\_IGn) & 05 June 2013 (Ref: 10060fIGn)

## **• Rev.29 (July 2011)**

### **.1 Origin of Change:**

- Suggestion by an IACS member

### **.2 Main Reason for Change:**

Following external audit a member was advised that a small temporary doubler on a cross-deck strip of a bulk carrier should have been promptly and thoroughly repaired at the time of survey. The member carried out an investigation and found that the actions of the surveyor were fully justifiable, the temporary repair and short term Condition of Class imposed were an appropriate method of dealing with such a situation. The member advised that the current requirements for 'Prompt and Thorough Repair' stipulated under the UR 7 and UR 10 series do not give any leeway for carrying out temporary repairs (and imposing a Recommendation/Condition of Class in accordance PR 35) where the damage in question is isolated and localised, and in which the ship's structural integrity is not impaired.

The Survey Panel discussed the matter and agreed that under carefully defined circumstances a temporary repair and short term Recommendation/Condition of Class would be an appropriate course of action.

### **.3 List of non-IACS Member classification societies contributing through the TC Forum and/or participating in IACS Working Group:**

None

### **.4 History of Decisions Made:**

The matter was discussed by correspondence within the Survey Panel and at the Autumn 2010 Panel Meeting. Following discussion at which the possibility of a Unified Interpretation being raised was considered, it was eventually decided to make direct amendment to the relevant Unified Requirements.

The wording of the new paragraph to be inserted as Para 1.3.3 in all relevant Unified Requirements was extensively discussed prior to agreement.

The proposal was unanimously agreed by Survey Panel Members.

## **.5 Other Resolutions Changes**

The identical amendment affects UR Z7, UR Z7.1, UR Z7.2, UR Z10.1, UR Z10.2, UR Z10.3, UR Z10.4 and UR Z 10.5.

## **.6 Dates:**

Original Proposal: *September 2010 Made by a Member*

Panel Approval: *March 2011*

GPG Approval: *27 July 2011 (Ref: 11118\_IGb)*

## **• Rev.28 (Mar 2011)**

### **.1 Origin for Change:**

Suggestion by IACS member

### **.2 Main Reason for Change:**

- 1) Inconsistency of the definition of transverse section of the ship given in UR Z7 and UR Z10s.
- 2) Update of references in the Executive Hull Summary Table VII.
- 3) Correction of "minimum allowable diminution" to "maximum allowable diminution" in Annex II.
- 4) To make the survey requirements in UR Z10.2 compatible with the new requirements contained in CSRs.

### **.3 List of non-IACS Member classification societies contributing through the TC Forum and/or participating in IACS Working Group:**

None.

### **.4 History of Decisions Made:**

Item 1) was proposed by RS and item 2) and 3) were proposed by GL. All amendments were agreed by the panel.

Regarding Item 4) The Survey Panel Members decided that the task would be carried out by a Project Team, rather than through correspondence within the Panel. The PT was composed by three Members from the Survey Panel and one Member, external to the Panel, who was expert both in surveys and in structural matters. Subsequently the PT requested the Small Group on Strategy & Steering Committee that the PT were enlarged with the joining of two additional Members of the Hull Panel, in order to increase the PT's expertise in the CSRs based on the fact that CSRs would be amended, even if limitedly to requirements related to surveys after construction. The Small Group on Strategy & Steering Committee fulfilled the PT request.

Additionally Permsec had received feedback from one of the IACS Audit Managers that the 20% and 25% pitting intensity diagrams were missing from Figure 2 of Annex V. Investigation showed that this appears to have been a typographical error introduced around 2005 and so Permsec have reinstated the missing diagrams.

## **.5 Other Resolutions Changes**

UR Z10.1, Z10.3, Z10.4 and Z10.5.

## **.6 Dates:**

Original Proposal: *January 2010, made by Survey Panel*

Survey Panel Approval: *July/November 2010*

GPG Approval: *24 March 2011 (Ref: 10170\_IGe)*

- **Rev.27 (Mar 2009)**

Survey Panel Task 62 - *Harmonization of UR Z10s to UR Z10.3(Rev.10).*

See TB document in Part B.

- **Rev.26 (Nov 2007)**

Survey Panel Task 1 – *Concurrent crediting of tanks.*

See TB document in Part B.

- **Rev.25 (Jul 2007)**

Replacement of the term “capesize bulk carrier” with “100 000 dwt and above”.

See TB document in Part B.

- **Rev.24 (Apr 2007)**

Survey Panel Task 10 – *Develop survey requirements for void spaces of ore carriers.*

See TB document in Part B.

- **Rev.23 (Feb 2007)**

Survey Panel Task 3 – *Maintenance of Alignment/Compatibility of IACS URs and IMO survey requirements.*

See TB document in Part B.



- **Rev.22 (Jun 2006)**

Survey Panel Task 43 – *Amend the applicable sections of the URs to address the requirements for substantial corrosion in the Common structural rules.*

See TB document in Part B.

- **Rev.21 (May 2006)**

Survey Panel Task 37 –Amend UR Z10.2 to increase the scope of the survey requirements of Special Survey No.2 and the Intermediate Survey between Special Survey No. 2 and No.3 for Cape Size Bulk Carriers.

See TB document in Part B.

- **Rev.20 (Feb 2006)**

Survey Panel Task 4 –Means of Access for Close-Up Surveys of Capesize Bulk Carrier hold frames.

See TB document in Part B.

- **Rev.19 (Jan 2006)**

Survey Panel Task 11 – Unified Periodic Survey Requirements related to SOLAS Reg. XII/12 & Reg. XII/13.

See TB document in Part B.

- **Rev.18, Corr.1 (Jan 2006)**

Noting that Members had not fully agreed the text in para 5.3.4 of UR Z10.2 Rev.18, Rev.18 was withdrawn and a corrected version was circulated with the text of Section 5.3 being that of Rev.17.

No TB document available.

- **Rev.18 (Jan 2006)**

Survey Panel Task 22 – *Amend applicable URZ7s and Z10s to align Close-Up Survey and Thickness measurements to be carried out at the same time and location allowing for a more structured control of the thickness measurement process – plus additional changes relating to access for rafting surveys.*

See TB document in Part B.

- **Rev.17 (Jun 2005)**

WP/SRC Task 102 - *Harmonization of UR Z7s and Z10s*

See TB document in Part B.

- **Rev.16 (Feb 2004)**

Changes to para 1.1.4 and Special Survey 3 in Table 3 relating to close-up surveys – no TB document available.

- **Rev.15, Corr.1(Feb 2004)**

Clarifications separating UR S31 needs from other measures – no TB document available.

- **Rev.15 (Dec 2003)**

WP/SRC Task 111, relating to thickness measurements of frames of single side skin bulk carriers and ensuring consistency between UR S31 and UR Z10.2.

See TB document in Part B.

- **Rev.14 (Aug 2003)**

WP/SRC Task 80 "*Survey reporting Principles - NMD Report on Leros Strength*" and WP/SRC Task 106 "*Incorporation of CAS requirements into A.744*".

See TB document in Part B.

- **Rev.13 (Oct 2002)**

WP/SRC tasks 91, 93 and 95.

No TB document available.

- **Rev.12 (Mar 2002)**

WP/SRC Task 87 – *Amend Z10.1 & 10.2 to reflect changes introduced to Res A.744 by MSC 73*

See TB document in Part B.

- **Rev.11.1 (Jun 2001)**

Clarification of Section 2.3.1.

See TB document in Part B.

- **Rev.11 (Nov 2000)**

Incorporation of outcome of WP/SRC Task 77 “prompt and thorough repairs” into UR Z10.2.

See TB document in Part B.

- **Rev.10.1 (Sept 2000)**

WP/SRC Task No. 62 – revision of UR Z10.2 (Rev.10) to keep the original intention that for the foremost cargo hold of the ships subject to SOLAS XII/9.1, intermediate surveys shall apply.

See TB document in Part B.

- **Rev.10 (Sept 2000)**

WP/SRC Tasks 49 and 62, and introduction of Extraordinary Council Meeting (Feb 2000) decisions into UR Z10.2.

See TB document in Part B.

- **Rev.9 (July 1999)**

Revised according to amendments to Res A.744(18).

No TB document available.

- **Rev.8 (April 1998)**

No TB document available.

- **Rev.7 (1997)**

Updated in accordance with amendments to IMO Res. 744(18) as contained in Annex 4 to MSC 68 WP.14. Adopted at C36.

No TB document available.

- **Rev.6 (1996)**

No TB document available.

- **Rev.5 (1996)**

No TB document available.

- **Rev.4 (1996)**

No TB document available.

- **Rev.3 (1995)**

No TB document available.

- **Rev.2 (1994)**

No TB document available.

- **Rev.1 (1994)**

No TB document available.

- **New (1992)**

No TB document available.

## **Part B. Technical Background**

List of Technical Background (TB) documents for UR Z10.2:

- Annex 1.     **TB for Rev.10 (Sept 2000)**  
See separate TB document in Annex 1.
- Annex 2.     **TB for Rev.10.1 (Sept 2000)**  
See separate TB document in Annex 2.
- Annex 3.     **TB for Rev.11 (Nov 2000)**  
See separate TB document in Annex 3.
- Annex 4.     **TB for Rev.11.1 (Jun 2001)**  
See separate TB document in Annex 4.
- Annex 5.     **TB for Rev.12 (Mar 2002)**  
See separate TB document in Annex 5.
- Annex 6.     **TB for Rev.14 (Aug 2003)**  
See separate TB document in Annex 6.
- Annex 7.     **TB for Rev.15 (Dec 2003)**  
See separate TB document in Annex 7.
- Annex 8.     **TB for Rev.17 (Jun 2005)**  
See separate TB document in Annex 8.
- Annex 9.     **TB for Rev.18 (Jan 2006)**  
See separate TB document in Annex 9.

- Annex 10. **TB for Rev.19 (Jan 2006)**  
See separate TB document in Annex 10.
- Annex 11. **TB for Rev.20 (Feb 2006)**  
See separate TB document in Annex 11.
- Annex 12. **TB for Rev.21 (May 2006)**  
See separate TB document in Annex 12.
- Annex 13. **TB for Rev.22 (Jun 2006)**  
See separate TB document in Annex 13.
- Annex 14. **TB for Rev.23 (Feb 2007)**  
See separate TB document in Annex 14.
- Annex 15. **TB for Rev.24 (Apr 2007)**  
See separate TB document in Annex 15.
- Annex 16. **TB for Rev.25 (Jul 2007)**  
See separate TB document in Annex 16.
- Annex 17. **TB for Rev.26 (Nov 2007)**  
See separate TB document in Annex 17.
- Annex 18. **TB for Rev.27 (Mar 2009)**  
See separate TB document in Annex 18.
- Annex 19. **TB for Rev.28 (Mar 2011)**  
See separate TB document in Annex 19.

Annex 20. **TB for Rev.29 (July 2011)**

See separate TB document in Annex 20.

Annex 21. **TB for Rev.31 (Jan 2014)**

See separate TB document in Annex 21.

**Note:** *There are no separate Technical Background (TB) documents for the original resolution (1992), Rev.1 (1994), Rev.2 (1994), Rev.3 (1995), Rev.4 (1996), Rev.5 (1996), Rev.6 (1996), Rev.7 (1997), Rev.8 (Apr 1998), Rev.9 (Jul 1999), Rev.13 (Oct 2002), Rev.15 Corr.1 (Feb 2004), Rev.16 (Feb 2004), Rev.18, Corr.1 (Jan 2006), Rev.30 (June 2013), Rev.32 (Feb 2015), Rev. 33 (Nov 2016), Rev.34 (Sep 2017), Rev.35 (Jan 2018), Rev.36 (May 2019) and Rev.37 (Feb 2023).*

## Technical Background Document

### UR Z10.2 – Revision 10 For ExCM decisions

#### Objective and Scope:

Revise UR Z10.2 to introduce ExCM (Extraordinary Council Meeting in Feb 2000) decision to UR Z10's

- ExCM FUA 2-2: Intermediate surveys of ships subject to ESP, which are over 15 years of age, will be enhanced to the scope of the preceding special survey with dry docking or under water survey as applicable.

#### Source of Proposed Requirements:

The proposed requirements were developed by WP/SRC Chairman, shortly after GPG 48<sup>th</sup> meeting:

- The para. 4.2.2, 4.2.3 & 4.2.4 for ExCM FUA 2-2.
- For the outcome of WP/SRC Task 49 “application of Z10.2 to ore carriers), the para. 4.2 was re-arranged.
- The paragraph 8.2.1 for compatibility with the PR 19 (ABS GPG suggested.)
- 

#### Points of Discussion:

GPG 48 meeting discussed whether to extend the requirement of ExCM FUA 2-1 to other ships and C 41 confirmed not to extend this requirement to other ships for the time being.

- - ExCM FUA 2-1: All ballast tanks adjacent to cargo tanks with heating coils shall be examined internally on an annual basis after the ship has reached 15 years of age.

#### Unresolved Comments:

-

#### Discussions:

In addition, LR (GPG) proposed the following additions:

- The second half of the para. 4.2.4.1(LR)  
“except that testing of cargo and ballast tanks is not required unless deemed necessary by the attending surveyor.”  
The majority GPG agreed.
- The paragraph 7.1.1 of Z10.1 and Z10.3, paragraph 8.1.2 of Z10.3 were revised for their compatibility with the PR 19 “PR for Thickness Measurement”.



**Technical Background Document**  
**WP/SRC Task 49**  
**UR Z10.2 – Proposed Draft Revision 10**  
(submitted by WP/SRC Chair on 10 June 2000)

**Objective and Scope:**

Review UR Z10.2 for the purpose of verifying that it also fully applies to Ore Carriers as defined in UR Z11.

**Source of Proposed Requirements:**

The proposed requirements were developed by WP/SRC Members, through correspondence and their meeting, identifying the requirements contained in Z 10.1 for Oil/Ore Carriers and incorporating them into UR Z10.2.

**Points of Discussion:**

WP/SRC did not unanimously agreed to either of two draft UR's submitted with this document.(Z102.doc and Z102strict.doc)

**Unresolved Comments:**

WP/SRC agree to the changes in 4.2.1.1 and 4.2.2.5 with the exception of the requirement for close-up survey of Web Frame Rings in Ballast Wing Tanks for vessels  $\geq$  15 years of age.

Seven of the Members agreed to require that All Web Frame Rings in All Ballast Wing Tanks should be close-up surveyed.

Three of the Members did not agree, but did agree to require All Web Frame Rings in One (1) Ballast Wing Tank and One (1) Web Frame Wing in all remaining Ballast Wing Tanks be close-up surveyed.

**Discussions:**

The Members that did agree to require that All Web Frame Rings in All Ballast Wing Tanks should be close-up surveyed, based the decision to remain consistent with the principal adopted in Z10.1 for Oil Tankers and Oil/Ore Carriers. LR and DNV were vocal in their opposition to the less strict requirements supported by BV, RINA, and KR.

The Chairman requested reasons for the opposition to the stricter requirements from the three Members for inclusion in this document and are as follows:

BV - When the ships in caption have 5 ballast tanks each side that means in that case they have 10 ballast tanks in total + peaks. considering 4 web rings per tanks gives in 40 web rings. If the ship's depth is 18 m and tanks' breath 10 m the developed length of a web ring is 56 m considering the 40 web rings we will have to close-up examine  $56 \times 40 = 2240$ m. considering the scaffoldings to be erected, the physical condition requested to the attending Surveyor(s) and the other items to be inspected, it will be simply impossible to comply with the requirements ( which will correspond more or less to a Special Survey) during an intermediate survey. Unless we reduce the class term to 3 years, I do not agree with the proposals.

RINA - RINA is of the opinion that requiring the close-up survey of all web frame rings in all ballast tanks (wing tanks + peak tanks) at the intermediate survey of ore carriers of 15 years of age and over is excessive and not reasonable as the assessment of these tanks can be achieved likewise through the overall survey in all of them and the close-up survey of "ALL web frame rings in ONE ballast wing tank and ONE web frame ring in EACH REMAINING ballast wing tank" and, in any case, should the condition of the web frame rings inspected be found not satisfactory, the survey will have to be extended to other rings in the same tank, as suggested in my message of 15 April. This less strict scope of survey would allow intermediate survey to be feasible and compatible with the commercial

operations of ships (in fact these surveys are usually carried out either during loading and unloading phases or at the end of them and require extensive scaffolding to be erected or rafting to be carried out). In addition, experience in performing intermediate surveys of ore/oil carriers for which the same stricter requirements have already been implemented has proved how it is difficult for a surveyor to have these spaces adequately prepared for this kind of inspection. Thus we do not like to extend the same problem to other kinds of ships and, rather, would like to amend the corresponding requirements related to ore/oil carriers accordingly, although it is recognized that this proposal could be difficult to achieve. Anyhow, even if the majority decides to submit the original text to GPG, we are prepared to maintain our position.

KR - The requirements of close-up survey of "all web frame rings in all salt water wing ballast tanks" at intermediate survey for ships older than 15 years is considered too heavy because all transverse webs in each ballast tank were close-up surveyed already at special survey No.3 as indicated in table 1 of existing UR Z10.2.

---

Note of IACS Permanent Secretariat (Date: 19 July 2000)

1. Numbering of the paragraph 4.2 of Z10.2 was re-arranged due to introduction of the requirements addressing ExCM FUA 2-2 "enhancement of intermediate survey to the preceding special survey for ships over 15 years of age.
2. The WP/SRC's proposed change to the para. 4.2.2.5 (now it stands as para. 4.2.3.1.b)) invited diverging views among GPG Members. However, it was found at GPG 48 meeting in March 2000 that the ExCM decision relating to enhancement of intermediate survey should be taken into account and as a result an urgent task was given to WP/SRC Chairman during GPG 48 to re-draft this paragraph.  
  
(The para. 4.2.2.5 (now 4.2.3.1.b): the extent of close-up survey of ballast tanks at intermediate survey in ore carriers over 15 years of age.)
3. WP/SRC Chairman put forward a re-draft of this requirement in April 2000.
4. GPG Chairman announced unanimous agreement on 14 August 2000 (0065aIGd, 14/8/00).

**Technical Background Document**  
**WP/SRC Task 62**  
**UR Z10.2 – Proposed Draft Revision 10**  
(submitted by WP/SRC Chair on 10 June 2000)

**Objective and Scope:**

Revise UR Z10.2 detailing how intermediate surveys are to be applied annually to the foremost cargo holds of ships subject to SOLAS XII/9.1. Also, draft comparable amendments to A.744(18) for consideration by GPG with a view to their submission to IMO.

**Source of Proposed Requirements:**

The proposed requirements were developed by WP/SRC members through correspondence and their meeting by incorporating the requirements of SOLAS XII/9.1 into UR Z10.2 and A.744(18).

**Points of Discussion:**

WP/SRC unanimously agreed to the draft UR.

(Note: After adoption of Z10.2 (Rev.10), amendment was made to it in order to avoid conflict between WP/SRC Task 62 and ExCM decision to extend the scope of intermediate survey of older bulkers to that of special survey. See the Rev. 10.1 of Z 10.2 (3 October 2000, note by the Permsec))

## Technical Background Document

### UR Z10.2 – Revision 10.1 For WP/SRC Task No. 62

#### Objective and Scope:

Revise UR Z10.2 (Rev.10) to keep the original intention that for the foremost cargo hold of the ships subject to SOLAS XII/9.1, intermediate surveys shall apply.

#### Source of Proposed Requirements:

- The outcome of WP/SRC Task 62.

#### Points of Discussion:

The consequence of Council's decision to extend the scope of intermediate surveys of older bulkers to that of special survey has the effect of making the annual survey required by 3.2.1.2 be a special survey (i.e. a full special hull survey every year for bulk carriers subject to SOLAS XII/9.1).

See the note 5, para. 3.3 and new Annex IV.

#### Unresolved Comments:

-

#### Discussions:

-----

**Technical Background Document**  
**WP/SRC Task 77**  
**UR Z7 – Proposed Draft Revision 7**  
**(Including Rev.8 of Z10.1, Rev.11 of Z10.2, Rev.4 of Z10.3)**

**Objective and Scope:**

Extend the requirements for permanent repairs at the time of survey in UR Z 10.2 to all ships.

**Source of Proposed Requirements:**

The proposed requirements were developed by WP/SRC members through correspondence and discussions at the September 2000 meeting.

**Points of Discussion:**

UR Z7 was amended to apply “prompt and thorough” repairs to all vessels. The new wording defines a prompt and thorough repair to be a repair as a result of wastage and not an incident such as contact damage where a temporary repair or deferral of repairs could be permitted. This wording is more explicit than the wording in UR Z10.2 and should achieve a uniform application among the Members.

WP/SRC also agreed to include these requirements in Z10.1, Z10.2 and Z10.3 in order to not effect A.744(18).

WP/SRC unanimously agreed to the draft UR.

Note by Permsec

GPG 49 (11-13 Oct. 2000) agreed that the same changes be introduced to Z10's and carried out editorial review of Z 10's.

## Technical Background for

**Rev.8.1, Z10.1**

**Rev.11.1, Z10.2**

**Rev.4.1, Z10.3**

(21 June 2001)

1. Scope of objectives

Revise section 2.3.1 for clarity.

2. Points of discussions or possible discussions

- BV GPG member proposed to revise section 2.3.1 of Z10s on 12 June 2001 (0065j)
- IACS Council considered the ambiguity of the sentence in Special Survey section 2.3.1 "For Fuel Oil Tanks the necessity for the Overall Survey is to be determined based on the ship's age" in the context of its application at intermediate surveys on ships over 15 years. Council agreed that the overall survey of low corrosion risk tanks such as fuel oil, lube oil and fresh water tanks could be subject to special consideration as already addressed in section 2.2.5 of UR Z7 and therefore amended the first sentence of 2.3.1, accordingly, and deleted the last sentence of 2.3.1.
- Adopted on 21 June 2001.

\* \* \* \* \*

**Technical Background Document**  
**WP/SRC Task 87**  
**Amend Z10.1&10.2 to reflect changes introduced to Res A.744 by MSC 73**  
**(Z10.1, Rev.9) + (Z10.2, Rev.12) + (Z10.3, Rev.5)**

**Objective and Scope:**

To harmonise IACS UR Z10.1 and Z10.2 with IMO Res A744(18), as previously amended and as amended by IMO MSC105(73) and MSC 108(73).

These amendments enter into force 1 July 2002.

It was assumed by WP/SRC that the intention of GPG has been to revise UR Z10.3 (chemical tankers) as well with respect to the intermediate dry-docking requirement, but not to include the requirement to evaluation of longitudinal strength.

In addition, the relevant changes to UR Z10.1 based on the changes introduced in IMO Res A744(18) as reported in MSC 74/24/Add1-Annex 17 have been included. These were based on IACS submission DE 44/13/1. These amendments will enter into force 1 January 2004 subject to IMO tacit acceptance procedures.

**POINTS OF DISCUSSION:**

The Chairman of WP/SRC would further draw GPG's attention to paragraph 4.2.4.3, which contains the requirement to intermediate dry-docking for oil tankers exceeding 15 years of age. The corresponding Res.A 744(18) requirement (paragraph 2.2.2) does not link the dry-docking to the intermediate survey. This issue was discussed extensively by correspondence and during three WP meetings this year. A consensus decision was achieved without reservations from any members. This process was time consuming, hence the delay in submitting this document to GPG for approval. However, at the annual meeting of the WP in October 2001 all members agreed that we should not accept the wording of Res. A 744(18) paragraph 2.2.2, but instead require that the intermediate dry-docking is to be linked to the intermediate survey and include a requirement to carry out surveys and thickness measurements of the lower portions of the tanks for oil tankers. (similarly, cargo holds/water ballast tanks for bulk carriers)

GPG is advised to note that the proposed requirement in paragraph 4.2.4.3 may result in a third dry-docking within the 5-year period of the classification certificate in case that a dry-docking is carried out prior to the window for intermediate survey.

The Chairman of WP/SRC suggests that GPG approves UR Z10.1 with high priority and allows PermSec in the meantime to start the work to amend and typeset UR Z10.2 and URZ10.3 with respect to the intermediate dry-docking requirement, as well as introducing the appropriate changes to UR Z10.2 and UR Z10.3 with respect to MSC 74/24/Add 1-Annex 17.

Note:

1. GPG tasked WP/SRC to review dry-docking survey requirements in Z10.2-4 and Z3 to harmonize them with those in Z10.1 (Rev.9) and reflect in Z3 the interim application of bottom survey requirements as introduced in MSC/Circ. 1013 (Res A.746(18)).  
Task 101, Target 2Q-2002
2. GPG confirmed (s/n 1060c) that 7.1.3 of A.744(MSC 74/12/Add.1/Annex 17/page 6), as quoted below, should not be included in Z10s.  
“7.1.3 Thickness measurements are to be carried out within 12 months prior to completion of the periodical survey or of the intermediate survey.”  
**Reason:** The above sentence will restrict the 15 month and 18 month survey window for TM during the intermediate and special surveys respectively.
3. GPG confirmed that 7.1.4 of A.744(MSC 74/12/Add.1/Annex 17/page 6), as quoted below, should not be included in Z10s:  
“7.1.4 In all cases the extend of the thickness measurements should be sufficient as to represent the actual average condition.”  
**Reason:** No compelling need, in view of MSC 74/12/Add.1 being adopted by MSC 75(May 02). IACS will live with this not harmonized sentence.
4. For IACS Council decisions to improve bulk carrier safety, see the TB for Revision 12 of Z10.2.

Submitted by WP/SRC Chairman



## **UR Z10.1(Rev.11) and Z10.2(Rev.14)**

**(July 2003)**

### **Technical background**

#### **Part A: Survey Reporting Principles**

##### **1. Objective**

WP/SRC Task 80 – Survey Reporting Principles

##### **2. Points of discussion**

The WP/SRC carried out this task according to the work specification of Form A (Rev.1) and reported the outcome on 18 December 2002 as follows:

- Review of NMD's report on "Sinking of Leros Strength", dated 6 July 2000 and the recommendations in section 5.3
- Review of IACS Council's reply, dated 22 August 2000 to those recommendations
- For recommendations 1.1, 1.2, 1.3 ,3, 4.2, 5 and 6, best practices have been identified by information exchange amongst Members and discussions at three WP-meetings.
- Harmonised survey reporting practices fulfilling, in so far as practicable, the recommendations of NMD have been included in the revised tables attached.
- Standard survey reporting terminology (recommendation 2) is in the process of being prepared and will be submitted to GPG for approval as an IACS Recommendation with the title "Surveyor's Glossary". The completion of the glossary has been delayed somewhat due to pending illustrations of typical hull structures.

Council approved on 14 July 2003 (2249\_).

\*\*\*

## **Part B: Incorporation of CAS related requirements into UR Z10s**

### **2. Objective**

WP/SRC Task 106 – Incorporation of CAS related requirements into A.744

### **2. Points of discussion**

The WP/SRC carried out this task according to the work specification of Form A and reported the outcome on 27 May 2003.

- Since CAS was developed for tankers only, WP/SRC considered whether there is any need to further develop/modify requirements in CAS with respect to bulk carriers. Hence, amendments to Z10.15.5.5(rafting), 5.6(survey planning), 8.2.2(different survey stations) and Table 1(close-up survey).
- IACS will submit its proposed amendments to Res A.744 as a result of this revision.
- NK GPG suggested that the word “alone” be inserted after “rafting” in Z7 and Z10.1(5.5.5)~10.5.
  - WP/SRC had considered this and felt that the insertion of the word "alone" will create a loophole as the text "Rafting alone will only be allowed..." could be interpreted that other means of access have to be used. Besides this wording would impede the use of rafting for survey of side and bottom structures of the spaces.
  - GPG considered that rafts/boats should be accepted as a means to move about within a tank to gain access to any temporary platforms that may be erected. Consequently, the wording of 5.5.5 was re-drafted and split into three parts (5.5.5~5.5.7) beginning with “Rafts or boats alone may be allowed for inspection of the under deck areas...”  
The same wording will be introduced into Z10.3, Z10.4, Z10.5, Z7 and Z7.1.

Approved on 08/08/2003 (0237h)

\*\*\*

Prepared by the Permanent Secretariat

22 July 2003

## Technical Background

UR Z10.2 (Rev.15, Dec 2003)

### 1. Objective :

Develop criteria for the extent and methodology of thickness measurements of frames of single side skin bulk carriers so as to ensure that UR S31 and UR Z10.2 include consistent, accurate and sufficient requirements.

### 2. **WP/SRC Task 111**

WP/SRC Task 111 completed on 10 Nov 2003 with new report form on Thickness Measurements of Cargo Hold Frames.

In addition, WP/SRC proposed the following changes:

1) to enhance the close-up survey requirements of the shell frames at Special Survey No.3 to include all shell frames in the forward and one other selected cargo hold and 50 % of frames in each of the remaining cargo holds. GPG agreed.

2) ships which are required to comply with UR S31 are subject to the additional thickness measurement guidelines for the gauging of side shell frames and brackets as given in the proposed new Annex V. GPG agreed.

### 3. **GPG Discussion**

GPG agreed to the following further changes:

1) Annex V, item 3.1: further modified to indicate that the 5 deepest pits within the cleaned area be gauged and the minimum thickness found recorded;

2) WP/SRC's proposed paragraphs relevant to face plates in both items 4.1 and 4.2 of Annex V were deleted;

3) Gauging method on flange and shell plating for bending check was newly introduced as item 4.3 of Annex V.

\*\*\*

**WP/SRC Task 102**  
**HARMONIZATION OF UR Z7s AND Z10s**

**Technical Background**

**UR Z7 (Rev. 11)**

**UR Z7.1 (Rev. 2)**

**UR Z10.1 (Rev. 12)**

**UR Z10.2 (Rev. 17)**

**UR Z10.3 (Rev. 7)**

**UR Z10.4 (Rev. 2)**

**UR Z10.5 (Rev. 1)**

Contents:

TB for Harmonization

**Annex 1.** TB for UR [Z10.1\(Rev.12](#), C49 amendments(coating-related))

[Appendix 1:](#) Memo for Coating, submitted to Council  
49(June 2004).

[Appendix 2:](#) DNV proposal (25 May 2005) agreed by Council

**Annex 2.** TB for "Verification/Signature of TM Forms" for records.

**Annex 3.** TB for revision of UR Zs concerning "anodes".

**1. Objective**

To amend UR Z7s and Z10s in order to make the texts of the above-mentioned URs consistent eliminating all the differences both in substance and in wording (WP/SRC Task 102).

**2. Background**

In the process of approving UR Z10.4, GPG found it necessary to amend the other existing URs Z10.1, Z10.2, Z10.3, Z10.6 and Z7 in order to eliminate any inconsistencies existing among them.

**3. Methodology of work**

The WP has progressed its work through many sessions, both during the periodical meetings and dedicated meetings restricted to a Small Group of Members (BV, DNV, GL, LR, RINA) who developed the work in order to be more efficient. All the proposed amendments of the Small Group have regularly been circulated to all Members for comment and agreement.

#### 4. Discussion

4.1 The WP/SRC has completed a comprehensive comparative review of UR Z7 and Z10s, and identified inconsistencies which existed among them. During this review, attention was given to the severity of the requirements applicable to the same spaces/structural areas on different types of ESP ships. As a result, the inconsistencies were eliminated making the URZs harmonized. However, there has been no change to the scope and extent of the survey requirements.

4.2 The starting point for each UR was the most updated version available at the time of commencement. Any revision to the URZs, which were introduced during this task, was taken into account. As for instance, the UR Z10.1 was initially amended based on Rev. 9, while the last amendments are based on Rev. 11 and the UR Z10.2 was initially amended based on Rev. 13, while the last amendments are based on Rev. 16. The proposed revisions of URs Z10.1 and Z10.4 have not been numbered, as there will be revisions to those URs before the revisions introduced by the Task 102 are adopted. In fact, GPG is currently developing a Revision 12 of Z10.1 with the view to introducing significant improvements in the survey regime for ballast tanks (including combined cargo/ballast tanks) of oil tankers and UR Z10s applicable to oil tankers will also have to be revised by incorporating the amendments to A.744(18) contained in Resolution MSC 144(77), which enter into force 1 January 2005 (see 4.3 below).

4.3 Also, in harmonizing UR Z10.1 and Z10.2 care has been taken to align the corresponding text with that of IMO Res. A.744(18). However, it has been noted that the amendments to A.744(18) contained in Resolution MSC 144(77), which enter into force 1 January 2005, have not been incorporated into the IACS UR Z10s applicable to oil tankers. It seems that the updating of the above-said UR Z10s will be done by the Perm Sec and reviewed by the WP/SRC Chairman and then circulated for adoption by GPG with concurrence of Council Members for uniform application from 1 January 2005. It is understood that the revisions of the UR Z10s affected by those amendments will not include the changes introduced by the Task 102, as the implementation date proposed for those changes is 1 January 2006 (see below **6. Implementation**).

4.4 In the course of the work the WP has been developing for more than two years, several additional Tasks were assigned to the WP by GPG which affected the development of Task 102. The additional tasks which have been taken into account are the following:

- 1) In the course of Council discussion on UR Z10.6 (General Cargo Ships), certain inconsistencies were identified between Z10.6 and other Z10s. WP was instructed to expedite Task 102 (1060gIAa, 12 June 2002);
- 2) WP was instructed to include "Survey Planning for Intermediate Survey" into harmonization work (2108\_IAa, 12 July 2002);
- 3) GPG instructed WP to consider whether Z10.6 should be re-assigned as Z7.1, in connection with the harmonization work. 1060gIAb, 20 Sept 2002.

- Z7.1 developed;
- 4) Partial outcome (Z7 and Z7.1) was submitted to GPG on 17 July 2003(1060g). Council decided that approval of Z7(Rev.10) and Z7.1(Rev.2) is postponed until the harmonization is completed (1060gICb, 6 April 2004);  
[Council Chairman instructed WP/SRC to Members' comments on the draft revision of UR Z7 and Z7.1 \(collected under s/n 1060g, 1060gNKi \(30/03/2004\) in particular\) on 6 April 2004.](#)
  - 5) GPG tasked WP to include the amendments to Z10.2 / Z11 (BCs with hybrid cargo hold arrangements), deleting sheets 15 and 16 for ore carriers, into the harmonized UR Z10s (2212aIGa, 19 Jan 2004);
  - 6) GPG tasked WP to consider whether the requirements relevant to examination of Fuel Oil Tanks in the cargo area at each Special Survey should be put into Z10s, and internal examination of FOT at Intermediate Survey after SS 2 is needed. (1060gIAf, 30 Jan 2004);
  - 7) GPG tasked WP to harmonize tank testing requirements in Z7s and Z10s. (3006IIAa, 5 April 2004);
  - 8) GPG tasked WP with Task 108 - Develop uniform survey requirements for air vent pipes including the welded connection to deck. Z22 developed. GPG instructed WP to incorporate Z22 into the harmonized Z10s;
  - 9) GPG tasked WP with Task 114 - Verification and signature of TM reports. REC 77(Rev.1) developed and approved on 29 July 2004. Council approved parallel amendments to Z7.1 and Z10s (TM Forms included) and instructed WP to incorporate these into the harmonized Z10s:
    - [Recommendation No.77 was revised \(Rev.1, July 2004\);](#)
    - [Z7.1 para.6.3.2 and Z10s para.7.3.2 so amended.](#)
    - ["Surveyor's signature" is deleted from all TM Forms in Z10s;](#)
    - [A note is added to Annex II\(Z10s\) declaring that Annex II is recommendatory.](#)

WP/SRC's investigation into Members' practice in dealing with verification and signature of TM reports is annexed for record keeping purpose. [See Annex 2.](#)
  - 10) GPG tasked WP to consider the BV comments on "TM may be dispensed with..." and include the findings into the harmonized Z10s ( 2219iIAa, 7 April 2004).

## **5. Agreement within the WP/SRC**

All Members have unanimously agreed the attached final versions of UR's.

## **6. Implementation**

WP/SRC is of the view that the Members need 12 months from the adoption date to implement these amendments into their class rules. Assuming Council adoption in December 2004, WP/SRC would propose January 2006 as implementation date.

- Annex 1:** TB for UR Z10.1(Rev.12, C49 amendments, see Permsec’s note 1 below)  
**Annex 2:** WP/SRC Task 114, verification and signature of TM reports(see 9 above).  
**Annex 3:** TB for revision of UR Zs concerning “anodes”.

**Note by the Permanent Secretariat**

1. Annex 1 to this TB contains background for amendments to UR Z 10.1(Rev.12) relating to FAIR/POOR/GOOD (C49 amendments). Council at its 49<sup>th</sup> meeting (June 2004) agreed/decided that comparable changes should be added to Z10.3 and Z10.4.
  
2. Appendix 3 “TM sampling method” has been added to UR Z10.1 and Z10.4 to keep them consistent with IMO Res.MSC.144(77). The amendments to A.744 contained in MSC.144(77) entered into force on 1 January 2005. (*GPG s/n 4181*)  
  
Under s/n 4072g, paragraph **2.4.6** of UR Z10.1 and **2.4.6** and of UR Z10.4 (paragraph numbering is now harmonized) were amended in order to provide a link between the main text of the UR Z10.1 and 10.4 and the new Annex III Appendix 3 containing the MSC Res.144(77).  
Further, it was agreed that the requirements for evaluation of longitudinal strength of the hull girder (as written in MSC.144(77)) should not be required for Intermediate Survey unless deemed necessary by the attending Surveyor. This is covered in 4.2.3.1 and 4.2.4.1 of Z10.1 and Z10.4.
  
3. GPG agreed that the amended UR Zs should be implemented from 1 July 2006 altogether.
  
4. DNV’s proposed amendments to UR Z10.1, Z10.3 and Z10.4 concerning annual survey of ballast tanks were agreed by Council (1060gICq, 27 June 2005). See Appendix 2 to Annex 1.
  
5. Annex 3 contains a TB for revision of UR Zs concerning “anodes”.

Date: September 2004  
Prepared by the WP/SRC

— — —

# **Annex 1 to Technical Background**

## **UR Z 10.1 (Rev.12, C49 amendments(coating-related))**

### **1. Objective**

To introduce significant improvements in the survey regime for ballast tanks (including combined/ballast tanks) of oil tankers as matter of strategic concern and urgency to IACS, given the aging of both the single and double hull tanker fleets and the problems encountered with corrosion of ballast tanks in several shipping casualties.

### **2. Background**

Draft amendments to UR Z10.1 were submitted to Council 47 (June 2003) and agreed in principle.

### **3. Discussion**

There was particular concern over accelerated corrosion with age (as the thinner the material, the more rapidly the allowable diminution margin percentage disappears) especially where coatings have broken down. There is also a disincentive for any spend on maintenance of the structure of a ship within a few years of its statutory scrapping date.

Council discussion by correspondence had evolved to the position of substantive proposals – summed as follows (3095\_ABa, 2 June 2003):

1. Enhance the Intermediate Survey in Z10.1, Z10.3 and 10.4 for Tankers after 2<sup>nd</sup> Special / Renewal Survey to the same level (scope of work) as the preceding Special / Renewal Survey). This corresponds to the latest revision to UR Z10.2.
2. At Annual Survey of ballast tanks with substantial corrosion, the overall survey is to be replaced by close-up survey with thickness measurements of the exposed area.
3. Proposed to task WP/SRC to re-consider the acceptance criteria for the rating FAIR further. For this, eliminate FAIR, leaving only GOOD and POOR redefined as appropriate.
4. Proposed to task WP/SRC to explicitly require close-up survey of Suspect Areas identified at the previous Special Survey.

Council 47 discussed the proposals(June 2003) as follows:

1. **Definition of FAIR**  
Council 47 agreed that “FAIR” would be retained as a rating and that GPG should instruct WP/SRC to redefine FAIR, so that there would be a clear differences between FAIR, POOR and GOOD. It was also agreed that for oil tankers the Intermediate Survey following Special Survey No.2 would have the same scope as Special Survey No.2(Z10.1). WP/SRC should also clarify the definition of satisfactory repair.

Based on the strong majority, Council agreed to discuss with Industry annual surveys of ballast tanks when coating is found in LESS than GOOD condition at special survey, with the objective to encourage the owner to carry out repairs and maintenance of coating to GOOD condition.

*DNV and NK stated that they could not accept a requirement for annual surveys of ballast tanks when the coating condition is less*



*than GOOD and proposed that GOOD be changed to FAIR  
(3095\_IGc, 30 June 2003)*

2. ABS' proposed amendments to Z10.1(annual examination of BWTs in certain conditions) were approved.
3. C 47 agreed that the BWT coating requirements (Z10.1.2.2.3) for intermediate Survey after SS 2 should be the same extent to the previous SS.
4. Given the substance of the changes, the revised Z10.1 should be shown to Industry before adoption.
5. A guidance for coating repairs needs to be developed by WP/SRC with reference to TSCF Guidelines.

Following Council 47, the draft text of Z10.1(Rev.12) was distributed to Industry and discussed at the IACS/Industry meeting on 29 August 2003. Industry indicated that UR Z10.1(Rev.12) is acceptable, provided that appropriate IACS guidelines on coating repairs are developed.

The Small Group on Coating (SG/Coating) under WP/SRC prepared draft guidelines on coating repairs and considered the definitions of GOOD / FAIR / POOR. The SG/Coating did not change the definitions and found that the Guidelines provide useful clarifications on the definitions and criteria in achieving an industry wide uniform judgement of coating conditions as well as what is needed to restore GOOD conditions.

Further, an IACS/Industry JWG/Corrosion was established and met in February 2004. The outcome is (3095\_IGh, 4 June 2004):

- Draft Guidelines on Coating Repair (IACS REC 87)
- Draft UR Zxx (mandatory coating of cargo tanks on oil tankers)
- Draft UI SC 122 (Rev.2) – mandatory coating of ballast tanks

#### 4. Others

1. Z10.11.2.2bis - Definition of “Combined Cargo/Ballast Tank. ...as a routine part of the vessel's operation and will be treated as a Ballast Tank. ...”. By so amending, Z10s do not need to repeat “Ballast Tanks and Combined cargo/salt water Ballast Tanks” in addressing the ballast tanks. Hence, all the references to “and Combined cargo/salt water Ballast Tanks” were deleted.
2. Z10.1.2.2.1.2: The aim of the examination is ~~to be sufficient~~ to discover substantial corrosion...  
Comparable changes are to be added to other UR Zs wherever the same sentence occurs.
3. “IACS Guidelines for Coating Maintenance & Repairs for Ballast Tanks and Combined/Ballast tanks on Oil Tankers” are referenced where relevant.
4. Comparable changes are to be added to UR Z10.3 and Z10.4, after adoption of Z10.1(Rev.12).

**Attached: Memo on Coating Matters (GPG Chairman)**

9 June 2004  
Prepared by the Permsec

## **Appendix 1 to Annex 1:**

## **MEMO on Coating matters**

### **1. Background and discussion within IACS on UR Z10.1 (draft Rev.12) between 29/01/03 and 14/08/03**

In view of the survey experience with oil tankers, it was proposed that all ballast tanks should be examined, routinely and uniformly, at annual surveys on ESP tankers exceeding 15 years of age. IACS should amend UR Z10.1 to require the examination of ballast tanks on such ships at each annual survey. This is simple, clear and thorough and not subject to interpretation. (2242\_ABq dated 29/1/03)

Then, ABS modified the proposal asking, for tankers subject to URs Z10.1, Z10.3 and Z10.4, exceeding 15 years of age, that the current requirement - pertaining to annual examination of Ballast Tanks adjacent to cargo tanks with any means of heating - be deleted and replaced by a simpler and more stringent requirement that all Ballast Tanks be subject to survey at each subsequent annual survey where either substantial corrosion is found within the tank or the protective coating is found to be in less than GOOD condition and the protective coating is not renewed at special survey or intermediate survey. This will ensure that all Ballast Tanks with substantial corrosion or protective coating which is not in GOOD condition at the time of special survey or intermediate survey will be examined at each subsequent annual survey on tankers exceeding 15 years of age. (2242\_ABzb dated 14/3/03)

This was later expanded to include all tanks used routinely for ballast water, both ballast-only and cargo/ballast tanks (2242\_ABzc dated 14/3/03).

ABS further reviewed the issue of the survey of salt water ballast spaces and combined cargo/salt water ballast spaces with ABS' governing bodies in light of recent casualties and survey findings on other tankers. Their review found an increasing amount of coating breakdown/failure and subsequent rapid wastage in key structures after Special Survey No. 2, i.e. after 10 years of age. These conditions are most prevalent in the under deck structure and the side shell structure in way of the deep loadline. In a number of cases the serious wastage has caused fracturing of the under deck longitudinals and in some cases fracturing has extended to the main deck structure. This led ABS to refine proposed amendments to URs Z10.1, Z10.3 and Z10.4 to require (2242\_ABzf dated 9/5/03):

#### a. For Tankers exceeding 10 years of age

Salt Water Ballast Spaces and Combined Cargo/Salt Water Ballast Spaces. For tankers exceeding 10 years of age, salt water ballast spaces and combined cargo/salt water ballast spaces are to be internally examined at each subsequent Annual Survey where substantial corrosion is found within the tank or where the protective coating is found to be less than GOOD condition and protective coating is not repaired. Internal examination to be an Overall Survey.

#### b. For Tankers exceeding 15 years of age:

Salt Water Ballast Spaces and Combined Cargo/Ballast Spaces. For tankers exceeding 15 years of age, salt water ballast spaces and combined cargo/ballast spaces are to be examined internally at each subsequent Annual Survey. Where substantial corrosion is found within the tank, or where the protective coating is found to be in less than GOOD condition and the protective coating is not repaired then in addition to an Overall Survey, under deck structure and the side shell structure in way of the deep loadline is to be subject to Close-up Survey.

NK and BV replied that the proposed amendments made by ABS need to be substantiated in a transparent manner with technical data that ABS may possess and put forward for further assessment and discussion. (2242\_NK<sub>n</sub> dated 14/5/03 and 2242\_BV<sub>z</sub> dated 16/5/03)

DNV (2242\_NV<sub>n</sub> dated 2/6/03), having carefully considered the practical consequences of taking the ship off-hire for gas freeing etc. and being concerned about the difficulties to have these surveys executed in a safe manner and whether the intended safety benefits in implementing the proposed extended scope of the annual survey of Ballast tanks will be met, **proposed the following alternative measures** which would be as effective and may not have such delaying effects to the ship:

- 1) Enhance the Intermediate Survey in UR Z10.1, 10.3, and 10.4 for Tankers after the 2 Special / Renewal Survey to the same level (scope of work) as the preceding Special / Renewal Survey. (This will correspond to the latest revised requirements of UR Z10.2 for Bulk Carriers.)
- 2) At Annual Survey of ballast tanks with substantial corrosion the overall survey should be replaced by close up survey with thickness measurements of the exposed area. (An overall survey of these tanks does not give sufficient information of the development of the areas with substantial corrosion.)
- 3) Further we will not fail to mention that the WP/SRC has proposed to extend the close up survey in cargo and combination tanks to 30% from the 3 Special / Renewal Surveys.
- 4) **Experience has shown that the coating condition rating category FAIR has a tendency to be stretched too far into the POOR condition. We will therefore propose that we task the WP/SRC to reconsider the acceptance criteria for the rating FAIR further.**
- 5) We do also question the need for redefining the definition of combination tanks, particularly since the category I tankers which are the ships that normally are fitted with these type of tanks are to be phased out 2 to 4 years from now. However DNV will not oppose to such a redefinition.

**DNV requested Members to consider the above as an alternative to the ABS proposal, bearing in mind that we ought to present this to the industry prior to deciding.**

ABS (3095\_Aba dated 2/6/03), having further considered its earlier proposals in light of NV<sub>n</sub>, submitted a revised proposal for consideration by Council at C47 and replied to the above 5 DNV proposals as follows:

- 1) ABS fully supports this proposal.
- 2) While ABS agrees with this proposal, it is in fact already provided for in Z7 (3.2.3) and Z10.1 (3.2.5.1)--which require that "Suspect areas (which include any area where substantial corrosion is found) identified at previous Special Survey are to be examined. Areas of substantial corrosion identified at previous special or intermediate survey are to have thickness measurements taken." To us, this implies that close-up survey of these areas is to be done at annual survey in conjunction with the thickness measurements. However, we can

agree to tasking WP/SRC to explicitly require "close-up" survey in this connection and to amend Z7, and all the Z10's, appropriately to make this explicit, if there is majority support for this.

- 3) We agree that this has been put forward to GPG by WP/SRC via 0237hNVb, 27 May. However, these additional CAS close-up survey requirements do not apply to salt water ballast tanks; only to cargo oil tanks and combined cargo/ballast tanks.
- 4) **We agree with this assessment and we propose that the only way to eliminate the subjectivity and raise the standard is to eliminate the category "FAIR" completely; leaving only "GOOD" and "POOR" redefined as follows:**  
**"GOOD -- condition with no breakdown or rusting or only minor spot rusting.**  
**POOR -- any condition which is not GOOD condition."**
- 5) ABS does not agree with this proposal. We are particularly concerned that we need a very thorough and robust survey regime for these tankers precisely because they are subject to mandatory phase out over the next several years. We are very concerned that without additional IACS requirements, these tanks will receive little or no inspection and maintenance by owners or others after their last special or intermediate survey, if no substantial corrosion is found at that time. Rapid, localized wastage in way of deteriorating coatings may pose significant hazard if the survey regime is not further tightened as we are proposing.

In conjunction with the above comments on DNV proposals, ABS further considered their previous proposal in ABzf and modified it as follows:

- **ABS simplified the proposal to require annual examination of all salt water Ballast Tanks and combined Cargo/salt water Ballast Tanks irrespective of age, when either substantial corrosion is found within the tank or the protective coating is found to be in less than GOOD condition and is not repaired.**
- the requirement for annual (close-up) examination of salt water ballast tanks and combined tanks is already required in Z10.1 (3.2.5.1). ABS proposed adding it to 2.2.3 for clarity and emphasis so that all the conditions which may lead to annual examination of such tanks are listed together in one place.
- Since the principal problem that we are trying to address is rapid, localized corrosion in way of breakdown or deterioration of the protective coating, we are proposing that the coating condition should be found and kept in "GOOD" condition to obviate the need for annual examination. **The attached proposal is made together with the proposals in items 3.1 (intermediate following Special survey 2 to have same scope as prior Special survey) and 3.4 (eliminating "FAIR" and redefining "POOR" as any condition other than "GOOD" condition.**

ABS requested to decide on a course of action at C47 for tightening the survey regime for tankers. They agreed that industry be informed of Council's decisions in this regard prior to IACS making the decision public, but IACS should maintain its independence and take decisive action in this matter. Debate with industry can only lead to delay and to a watering down and compromising of these important requirements.

NK agreed to task WP/SRC to reconsider the acceptance criteria of "FAIR" for clearly define the border between "FAIR" and "POOR" condition. However, **NK strongly opposed the elimination of "FAIR" coating condition from UR Zs** because this can not resolve to remove subjectivity of coating assessment. The three-categorization system of coating condition should be retained. (3095\_NKa dated 5/5/03)

## **Outcome of C47**

At C47, it was agreed that "Fair" would be retained as a rating and that GPG should instruct WP/SRC to redefine "Fair", so that there would be a clear differentiation between "Fair", "Poor" and "Good". It was also agreed that for oil tankers the Intermediate Survey following Special Survey No.2 would have same scope as Special Survey No.2 (Z10.1). WP/SRC should also clarify the definition of satisfactory repair.

Based on strong majority support Council agreed to discuss with Industry annual surveys of ballast tanks when coating is found in LESS than GOOD condition at special survey, with the objective to encourage the owner to carry out repairs and maintenance of coating to GOOD condition.

This matter should be discussed with Industry prior to adoption of any UR by Council.

In a final summary, the Chairman proposed that a constructive dialogue with Industry should take place on the IACS proposal as set out in WP1 plus maintaining 3.2.5.2 modified to say that ballast/combined ballast/cargo tanks will be subject to annual survey when considered necessary by surveyors.

After discussion in the JWG (Industry/IACS), GPG should propose final rules for this matter to Council, including acceptable repair definition.

**FUA 17:** *To instruct WP/SRC to develop guidance on coating repairs and more precise definition of "Fair" coating condition.*

Once approved, these requirements should be incorporated into Z10.3 and Z10.4.

### **FUA 15**

1) *To prepare a draft revision to UR Z10.1 incorporating C 47 decisions:*

- *The definition of "FAIR" remains as it is;*
- *ABS proposed amendments to Z10.1 (annual examination of BWTs in certain conditions) were approved;*
- *C47 agreed that the BWT coating requirements (Z10.1.2.2.3) for Intermediate Survey after Special Survey No.2 should be the same extent to the previous Special Survey.*
- *Given the substance of the changes, the revised UR Z10.1 should be shown to Industry (OCIMG/Intertanko first among others) before adoption for their review and comments.*
- *A guidance for coating repairs needs to be developed by WP/SRC with reference to TSCF Guidelines.*

2) *GPG Members are to confirm the draft revision to Z10.1 in consultation with their WP/SRC members by correspondence. See 3095\_IGa of 13/06/03.*

According to C47 FUA 15, GPG Chairman circulated (3095\_IGa dated 13/6/03) draft amendments to UR Z10.1 as agreed in principle at C47.

Having received a number on comments, GPG Chairman (3095\_IGb dated 27/6/03) informed that the Council Chairman confirmed that GPG is not to amend the principles agreed at C47, i.e. we are not empowered to change "GOOD" to "FAIR" as proposed by DNV and NK, nor to amend the definitions of "FAIR" and "POOR" as proposed by DNV.

DNV's intention to possibly lodge a reservation was noted, however the matter should be raised at Council and not be dealt with by GPG. An amended draft text incorporating the non-substantive changes proposed by Members was circulated.

DNV said that its understanding was that the draft should be circulated to the Industry (ICS, INTERTANKO, and BIMCO) prior to adoption by Council. (3095\_NVc dated 30/6/03)

GPG Chairman (3095\_IGc dated 30/6/03) circulated a draft amendment of UR Z10.1 for Council's agreement and use in discussions with the industry associations.

The draft was generally agreed by GPG but individual Members have requested that the following matters (which were deemed to be outside the remit of GPG in this task) be brought to Council's attention for further consideration:

- 1 DNV and NK stated that they can not accept a requirement for annual surveys of ballast tanks when the coating condition is less than GOOD and propose that GOOD be changed to FAIR.
- 2 In connection with item 1 above, DNV also propose to amend the definitions of FAIR and POOR in order to raise the standard of FAIR.

Council Chairman (3095\_ICb dated 14/8/03) concluded that Council has agreed that the draft amendments to UR Z10.1 attached to IGc reflect Councils' decision taken at C47 and that they be circulated to industry associations.

Perm Sec was therefore invited to submit the draft to OCIMF and INTERTANKO in view of discussion at the IACS/ industry meeting on 29 August.

## **2. Discussion with Industry (29/08/2003 – 11/10/2003)**

As requested by Council, the whole matter was presented to Industry during the “general matters” meeting with IACS held on 29 August 2003; comments from Industry were requested. In the following an extract from the minutes of the meeting (see message 3100aIAb dated 5 September 2003):

\_\_\_\_\_ from Meeting minutes \_\_\_\_\_

## **4. & 5. Annual surveys of ballast tanks and IACS guidelines on coating repairs**

M. Dogliani introduced the matter ([see Items 4&5 in Appendix](#)).

A. LinoCosta gave a presentation to show where concerns and decisions stand: too many cases when coating was considered fair at SS but problems occurred just after one/two years.

N. Mikelis commented on draft amendments to Z10.1 (Rev.11) stating that the extent of annual survey is not clear; it should be limited to the affected zones, e.g. coating breakdowns, only.

M. Guyader clarified that, in this draft amendments, it is expected an overall survey of the whole tank and a close up survey of the affected zones.

N. Mikelis noted that, in the draft amendments to Z10.1 (Rev.11), the intermediate survey at 12.5 years would have the same scope as the previous special survey and that needed a justification. See 7 a).

M. Dogliani said that Z10.1 (Rev.11) was adopted in August 2003 and will be introduced into IACS Societies' Rules over the next year.

### Conclusions:

4.1 Industry shared IACS concerns on coatings and, in general, agreed with the draft amendments to Z10.1 (Rev.11) suggesting also extending them to Z10.2 on bulk carriers



4.2 Industry agreed that a guideline for surveyor on coating would greatly improve uniform application of so-amended Z10.1 including issues such as how to consider load bearing elements when judging GOOD/FAIR/POOR status and how to consider bottom pitting in connection with GOOD conditions

4.3 Industry will more precisely comment, by the end of September, the draft Z10.1 so as for IACS to finalise the matter, as planned, for the Council's December meeting.

Item	Title	Industry recommendation	IACS/ M. Dogliani Introduction
4 & 5	Annual survey of ballast tanks IACS guidelines on coating repairs	NN	<p><b>1. IACS is considering the following:</b></p> <ul style="list-style-type: none"> <li>- <b>amend UR Z10.1 (draft circulated to Industry) to the effect that in case at Special Survey or Intermediate Survey the coating in a ballast tank is found less than GOOD, either GOOD conditions are restored or the tank's coating is inspected at each annual survey;</b></li> <li>- <b>develop IACS guideline to assist an uniform application of the so modified (if adopted) UR Z10.1; the guideline should address which repairs are necessary to restore GOOD conditions from FAIR and POOR respectively and which are the criteria for the restored (after repair) situation to be rated as GOOD.</b></li> </ul>

\_\_\_\_\_ End of extract from minutes \_\_\_\_\_

INTERTANKO commented (see R. Leslie email to GPG dated 25 September 2003):

- expressing their concern for the draft Z10.1 and underlining
  - a) targeting: concerns that, if not properly dealt with, Z10.1 would target all ships and not just those which need intervention; the view was expressed that guidelines would probably solve the matter;
  - b) definition: indicating that the current definitions of GOOD, FAIR and POOR is not clear enough and that the matter would be even worst with GOOD and NON GOOD; again it was indicated that guidelines could solve the matter;
  - c) expertise: expressing doubts on IACS' surveyors expertise and ability to judge coating conditions; in this respect they (hiddenly) suggest that IACS position is unclear when we say that we are not competent to judge the coating during construction but then we are competent to judge coating during operational life. Even if not explicitly stated, the impression is that also in this case guidelines would help.

Additionally, INTERTANKO suggested a (quite detailed) set of assessment criteria.

The matter was then finally addressed at the TRIPARTITE Meeting (held in Soul on 29/30 September 2003). There Industry agreed that the way forward was the (joint) development of IACS guidelines (see minutes attached to message 3100\_RIe dated 11 October 2003, an extract of which is reproduced below).

\_\_\_\_\_ Extract from the TRIPARTITE minutes \_\_\_\_\_

Industry is concerned by the definition of GOOD/NOT GOOD in relation to coating repairs and acceptance criteria. Industry agreed that new guideline on this, which IACS is already producing, was the way forward.

\_\_\_\_\_ End of the extract from the minutes \_\_\_\_\_

### **3. Further developments**

- a) from the above, it was concluded that, provided the guidelines are sound, Industry would accept the concept of Z10.1 (draft) Rev. 12, therefore an IACS team and a JWG were established in order to progress the matter of the guidelines (among other related matters).
- b) the team of IACS experts on coating developed draft guidelines and provided recommendations to GPG on the way forward (attached to message 3095bNVc dated 20 November 2003).
- c) the guidelines were discussed within the JWG with Industry (see draft minutes circulated within GPG with messages 3095cIGd and 3095cIGe both dated 13 March 2004)
- d) further suggestions and comments (as requested at the meeting) were provided by Industry (not circulated to GPG)
- e) Bulk Carrier Industry is recommending that similar guidelines are developed in due time also for bulk carriers
- f) at DE47 and MSC78, IMO is asking Industry and IACS to develop (compulsory) performance standards for coating of newbuilding (double hull spaces of DSS Bulk Carriers), a matter which is, indirectly related to the above one.

1 June 2004

M. Dogliani

IACS GPG Chairman

IACS JWG/COR Chairman



Appendix 2 to Annex 1: [DNV proposal to Z10.1, Z10.3 and z10.4](#) ▶

Sent Monday, July 4, 2005 4:45 pm  
 To [Gil-Yong <gilyonghan@iacs.org.uk>](mailto:Gil-Yong <gilyonghan@iacs.org.uk>)  
 Cc  
 Bcc  
 Subject Fw: 1060gNVs; WP/SRC - Task 102 - Harmonization of UR Z 7 and Z 7.1  
 Attachments [Doc1.doc](#) 25K

----- Original Message -----

From: "Debbie Fihosy" <[debbiefihosy@iacs.org.uk](mailto:debbiefihosy@iacs.org.uk)>  
 To: "CCS" <[iacs@ccs.org.cn](mailto:iacs@ccs.org.cn)>  
 Cc: "IACS Permanent Secretariat" <[permsec@iacs.org.uk](mailto:permsec@iacs.org.uk)>  
 Sent: Friday, June 03, 2005 2:52 PM  
 Subject: FW: 1060gNVs; WP/SRC - Task 102 - Harmonization of UR Z 7 and Z 7.1

Forwarding as requested

-----Original Message-----

From: Arve.Myklebust@dnv.com [[Arve.Myklebust@dnv.com](mailto:Arve.Myklebust@dnv.com)]  
 Sent: 25 May 2005 15:49  
 To: [AIACS@eagle.org](mailto:AIACS@eagle.org); [iacs@bureauveritas.com](mailto:iacs@bureauveritas.com); [iacs@ccs.org.cn](mailto:iacs@ccs.org.cn);  
[johnderose@iacs.org.uk](mailto:johnderose@iacs.org.uk); [iacs@dnv.com](mailto:iacs@dnv.com); [iacs@gl-group.com](mailto:iacs@gl-group.com);  
[gilyonghan@iacs.org.uk](mailto:gilyonghan@iacs.org.uk); [helenbutcher@iacs.org.uk](mailto:helenbutcher@iacs.org.uk); [efs@iacs.org.uk](mailto:efs@iacs.org.uk);  
[krsiacs@krs.co.kr](mailto:krsiacs@krs.co.kr); [richardleslie@iacs.org.uk](mailto:richardleslie@iacs.org.uk); [external-rep@lr.org](mailto:external-rep@lr.org);  
[clnkiacs@classnk.or.jp](mailto:clnkiacs@classnk.or.jp); [terryperkins@iacs.org.uk](mailto:terryperkins@iacs.org.uk); [iacs@rina.org](mailto:iacs@rina.org);  
[iacs@rs-head.spb.ru](mailto:iacs@rs-head.spb.ru); [colinwright@iacs.org.uk](mailto:colinwright@iacs.org.uk)  
 Subject: FW: 1060gNVs; WP/SRC - Task 102 - Harmonization of UR Z 7 and Z 7.1

25 May 2005

To: Mr. B. Anne, Chairman of IACS Council,  
 cc: Council Members, IACS Perm. Sec.

Ref.: My mail NVr dated 20 May 2005

DNV have further studied the amendments to UR Z10.1, Z10.3, and Z10.4, and as a result are presenting the following as a compromise solution:

General comment:

From the comments by other Members it is obvious that there is reluctance to accept annual surveys of ballast tanks with a common plane boundary to heated cargo tanks in the case where the coating is in good condition. This is particularly unreasonable as at the same time we enhance the Intermediate survey of Tankers between 10 and 15 years to also include examination of all ballast tanks, meaning that all ballast tanks will be close up surveyed with 2-3 years intervals from the ship is 10 years old, with the possibility for the surveyor to require thickness measurements and testing of the tanks to ensure the structural integrity of the tanks if necessary.

It is also proposed for the Intermediate survey between 5 and 10 years, to increase the scope from representative to all ballast tanks, a requirement DNV find to strict, and require that we here keep the original text.

If a ballast tank is found to have coating in GOOD condition at the renewal or intermediate survey, a deterioration of the tank beyond structural reliability is very unlikely even if the tank has a common plane boundary to a heated cargo tank.

DNV finds it particularly unreasonable to have this requirement to apply to double hull tankers for the following reasons:

- these ships have double hull and the risk of pollution is here much reduced,
- the double hull is constructed with small spaces giving improved structural reliability,
- almost all double hull tankers below VLLC have heated cargo tanks, and all ballast tanks have common plane boundaries to these tanks, meaning that this requirement will apply to a major part of the tanker fleet in the future,
- the ballast tanks of double hull tankers are so designed that a general examination of these tanks will be identical to a close up survey,
- survey of ballast tanks of double hull tankers will mean either gas freeing of all cargo tanks or at least dropping the inert gas pressure of all cargo tanks in addition to proper airing of all ballast tanks.

Since the single hull tankers will be faced out in the near future, and for clear political reasons, DNV will as a compromise proposal to keep paragraph 2.2.3.1 and 4.2.2.2 in Z 10.1 as amended by Council (ref. IAO) but amend it to not include 2.2.3.1.e, 4.2.2.2.e and last paragraph of 3.2.5.1 in Z10.3 and Z10.4. In addition we request that the original text of 4.2.2.1 is kept.

If BV, ABS and other Members can accept this DNV is willing to drop our reservation presented at C49.

DNV's proposal will then be as follows:

Z10.1:

2.2.3.1: This paragraph can be accepted as is for the reasons stated above.

3.2.5.1: This paragraph is accepted as amended.

4.2.2.2: This paragraph can be accepted as is for reasons stated above.

For other comments to Z10.1 see NVo and NVp.

Z10.3:

2.2.3.1.e to be deleted.

3.2.5.1 delete last paragraph

4.2.2.1 the original text to be kept. "For tanks used for water ballast ---"

4.2.2.2.e to be deleted

Z10.4

2.2.3.1e to be deleted

3.2.5.1 delete last paragraph

4.2.2.1 the original text to be kept, "For tanks used for water ballast --"

4.2.2.2.e to be deleted.

For details see attached document where the text for the requirements in Z10.3 and Z10.4 that DNV will accept is stated.

Best Regards

Arve Myklebust  
on behalf of  
Terje Staalstrom  
DNV IACS Council Member  
<<Doc1.doc>>

\*\*\*\*\*

Neither the confidentiality nor the integrity of this message can be vouched

Annex 2 to TB (Harmonization Z10s)

**WP/SRC Task 114 “Clarify the procedure of verification and signature of the thickness measurement report”**

Item No.	Item	ABS	BV <sup>1)</sup>	CCS	CRS	DNV	GL	IRS	KR	LR	NK	RINA	RS
<b>1</b>	<b>Verification onboard</b>	.											
1.1	Minimum extent of measuring points for direct verification by attending surveyor specified	No	No	No	No	No	No	No	Yes	No	No	Yes	No
1.2	Preliminary TM record to be signed upon completion of the measurements onboard	Yes	Yes <sup>7)</sup>	Yes	No (copy taken)	No <sup>3)</sup>	No <sup>6)</sup>	Yes	Yes	Yes	Yes	No <sup>8)</sup>	No
<b>2</b>	<b>Final TM report</b>												
2.1	Signature of all pages in TM record required	No	No	No	Yes	No	Yes	Yes	No	No	No <sup>5)</sup>	Yes	Yes
2.2	Signature of ‘cover’ (‘general particulars’) page only	Yes	Yes	Yes	No	Yes	No	No	No <sup>4)</sup>	Yes	Yes	Yes	No
2.3	Measuring points verified by attending surveyor required identified in TM record and signature of the corresponding pages required	No	No	Yes Without signature	Yes	No	No	No	Yes	No	No	No	No

2004-04-20

- 1) Instructions not clear regarding signature of the thickness measurement record
- 2) Signature on front and last page, stamp on all other pages, or signature on each page (IACS TM forms)
- 3) Upon completion of measurements onboard a draft report in electronic format (DNV TM template, including operator’s notes as relevant) to be given to attending surveyor
- 4) Signature of cover page, pages of meeting record and pages of attended measuring points
- 5) Each page to be signed in case of ‘loose-leaf’ type record
- 6) Preliminary TM record has to be passed to the Surveyor, signed by the Operator
- 7) The only measures which the Surveyors can certify exact are those for which that they have seen the results on the screen of the apparatus. That means in fact few points in comparison with the numbers of recorded measures.
- 8) The Surveyor reviews the TM record for completeness and assessment of TM readings, but no signature required.

### UR Z7s and Z10s (Corrosion Prevention System)

#### 1. Objective:

To clarify whether the survey of anodes is a class matter, and if so, whether acceptance criteria for anode should be developed.

#### 2. Method: GPG by correspondence (5037\_)

#### 3. Discussion

##### 3.1 BV initiated GPG discussion as follows:

Paris La Défense, 8 Mars 05

1 - We have noticed that, in the draft UR Z's ( 7.1, 10.1 to 10.5) issued further to the WP/SRC Task 102, the original sentence ".....the examination may be limited to a verification that the hard protective coating remains efficient....." has been replaced by ....that the corrosion prevention system remains efficient....". in a number of paragraphs (such as , for instance, Z 7.1, 4.2.3.1 a) ; Z 10.2 4.2.3.3 ; ), in line with IMO Res.A744(18).

2 - However, a corrosion prevention system is defined, in the same UR Z's and in IMO Res.A744(18) , as being either a full hard protective coating or a full hard protective coating supplemented by anodes.

3 - The above would mean that the survey of the anodes is a classification matter.

4 - However, whereas coating conditions are defined as good or fair or poor, there are no criteria in the IACS URs and IMO Res. A744(18) for the anodes condition.

5 - Assessing the anodes condition to confirm that they "remain efficient" looks to BV to be a quite difficult task for the ships in service Surveyor.

6 - Member's view and interpretations on the following would consequently be appreciated:

- do Members consider that the above requirements in IACS URs imply that survey of anodes is part of the classification ?
- do Members consider that the above requirements in IMO Res. A 744 (18) imply that survey of anodes is mandatory?
- if yes, what is the acceptance criteria to conclude that the anodes" remain efficient" ?

##### 3.2 The majority of GPG Members replied that they did not include requirements for anodes in their class rules.

LR / ABS / DNV / KR / NK / RINA / RS were of the view that the condition of any anodes fitted should be recorded for information purposes as the survey of anodes is neither a classification matter nor a mandatory requirement in IMO A.744(18) and has no impact on future surveys (5037\_LRa). [Note; LR further clarified that "Whilst I agree that the performance of anodes is not normally a class matter LR does require that as part of Special Survey on oil tankers : "The attachment to the structure and condition of anodes in tanks are to be examined ." Therefore we cannot say that 'the survey of anodes is not a classification matter'. 5037\_LRb]

However, GL said that “for GL, anodes are a matter of class and as such are subject to plan approval as well as surveys. In case of missing or worn-out anodes we issue a condition of class”(5037\_GLa&b).

CCS advised that its rules have a general requirement relating to anode survey, which is only conducted, through sampling, during construction, docking survey or where there is a definite requirement for the survey of ballast tanks.

NK proposed that the following footnote be added to Z7s and Z10s:  
“The survey of anodes is not a classification matter.” No majority support was achieved.

#### **4. Conclusion**

RINA suggested to simply amend the definition of "Corrosion Prevention System" in paragraph 1.2.9 of UR Z7 (and, of course, the paragraphs in all the other UR Zs containing the definition of "Corrosion Prevention System") in order to eliminate any reference to anodes. This proposal would leave room for Societies willing to include additional class requirements for anodes to do so in their Rules.

GPG agreed.

### **RINA proposed amendments to paragraph 1.2.9 of UR Z7 and corresponding paragraphs in all other UR Zs (5037\_RIb, 6 April 2005)**

#### 1.2.9 Corrosion Prevention System

A corrosion prevention system is normally considered ~~either:~~ a full hard protective coating.

~~1 a full hard protective coating, or~~

~~2 a full hard protective coating supplemented by anodes.~~

Hard protective coating is usually to be epoxy coating or equivalent. Other coating systems may be considered acceptable as alternatives provided that they are applied and maintained in compliance with the manufacturer’s specifications.

Where soft coatings have been applied, safe access is to be provided for the surveyor to verify the effectiveness of the coating and to carry out an assessment of the conditions of internal structures which may include spot removal of the coating. When safe access cannot be provided, the soft coating is to be removed.

[Annex: Council Chair’s conclusive message.](#)

6 May 2005  
Permsec

## Annex. (5037\_ICb, 15 May 2005)

To : All IACS Council Members  
c.c : Mr. R. Leslie, IACS Permanent Secretariat

Ref. Mr G-Y. Han's message IAa dated 6 May 05  
Message ICa dated 6 May 05  
Admiral R.E. Kramek's message ABb dated 13 May 05

Paris La Défense, 15 May 05

- 1 - All Members have agreed with the texts attached to Mr Han's message.
- 2 - Further to ABS comments the reference to anodes is to be deleted in Annex I and in tables IX (IV) and IX(II).
- 3 - further to ABS questions regarding what IACS plan to do regarding IMO and A.744(18) further to IACS deletion of reference to anodes from the UR Z7's and UR Z10's it is noted that:

The Item 1.2.9 in UR Z10.1 and relative items in these URs states

*1.2.9 10 Corrosion Prevention System: A corrosion prevention system is normally considered either:*

- .1 a full hard protective coating, or*
- .2 a full hard protective coating supplemented by anodes.*

*Hard Pprotective Ccoating is to usually to be epoxy coating or equivalent. Other coating systems may be considered acceptable as alternatives provided that they are applied and maintained in compliance with the manufacturer's specification.*

*Where Soft Coatings have been applied, safe access is to be provided for the surveyor to verify the effectiveness of the coating and to carry out an assessment of the conditions of internal structures which may include spot removal of the coating. When safe access cannot be provided, the soft coating is to be removed.*

- therefore the anodes are not considered as the main means of protection against the corrosion It is only a supplement;
- there is no provision in UR Z7's and Z10's to evaluate the level efficiency of the anodes;
- there is no specific requirements in case of lack of efficiency of the anodes.

The experience has shown that ballast tanks only protected by anodes are subject to corrosion when the anodes are becoming less efficient.

The anodes are active only when immersed by sea water. Therefore the upper part of the ballast tanks are not protected when the ballast is full of water and the ballast is not protected when it is empty..

The ships operators are reluctant to replace the anodes especially in upper part which request fitting of scaffolding fo welding the anode supports to the structure.

[The above arguments justify the reasons why IACS consider that the anodes are not class item.](#)

[4 - These arguments can be used by IACS Members](#) attending the WG bulk carriers at MSC 80 to try to obtain deletion of the reference to anodes in A. 744(18).

Best regards,

Bernard Anne  
IACS Council Chairman.

# **TB**

## **UR Z10.2(Rev.18, Corr.1 Jan 2006)**

- 1. Para. 1.4 and 7.1.3**
- 2. Para. 5.5.4 and 5.5.6**

**Survey Panel Task 22 – Amend applicable URZ7s and Z10s to align Close-Up Survey and Thickness measurements to be carried out at the same time and location allowing for a more structured control of the thickness measurement process.**

**Technical Background**

**Z7(Rev.12)**

**Z7.1(Rev.3)**

**Z10.1(Rev.13, para.1.4 & 7.1.3)**

**Z10.2(Rev.18, para. 1.4 & 7.1.3)**

**Z10.3(Rev.8, para. 1.4 & 7.1.3)**

**Z10.4(Rev.3, para. 1.4 & 7.1.3)**

**Z10.5(Rev.2, para. 1.4 & 7.1.3)**

**1. Objective**

To amend the applicable URZ7s and Z10s to align Close-Up Survey and Thickness measurements to be carried out at the same time and location allowing for a more structured control of the thickness measurement process.

**2. Background**

IACS QC findings, through audits of numerous Societies, which indicated concerns over Surveyor attendance and control of thickness measurement processes.

**3. Methodology of Work**

Survey Panel members through correspondence.

**4. Discussion**

To align Close-up survey requirements and thickness measurements in the applicable URZ7s and URZ10s, in accordance with PR19, all Panel members agreed through correspondence and a final vote at the fall Survey Panel meeting, that URZ7, Z7.1, Z10.1, Z10.2, Z10.3, Z10.4 and Z10.5 should include in the applicable sections of the noted URs as proposed by the Survey Panel the wording “ In any kind of survey, i.e. special, intermediate, annual, or other surveys having the scope of the foregoing ones, thickness measurements of structures in areas where close-up surveys are required, shall be carried out simultaneously with close-ups surveys.”

**5. Implementation**

The Survey Panel is of the view that the Members need 12 months from the adoption date to implement these amendments into their class rules. Assuming that GPG and Council approve to the amendments, the Survey Panel would propose January 2007 as an implementation date.



## **Technical Background**

### **UI SC 191 (Rev.2, Oct 2005)**

&

**UR Z10.1 (Rev.13)**

**UR Z10.2 (Rev.18)**

**UR Z10.3 (Rev.8)**

**UR Z10.4 (Rev.3)**

**UR Z10.5 (Rev.2)**

#### **1. Objective**

- to confirm whether the guidelines for approval/acceptance of alternative means of access (now REC91, ex Annex to UI SC191) is mandatory or non-mandatory.
- to consider other safety related proposals.

#### **2. Background**

The DNV proposal to submit the UI SC191(Rev.1, May 2005, Annex 1) to IMO DE49 triggered a number of discussion points that led to amendments to the following resolutions:

UI SC191(Rev.2)  
New REC 91  
REC 39(Rev.2)  
UR Z10s

#### **Points of Discussion**

3. Is the Annex to UI SC191(Rev.1, May '05, guidelines for approval / acceptance of alternative means of access) mandatory or non-mandatory ?

Answer: Non-mandatory. Hence, re-categorized as new REC 91.

4. Limitation of use of rafts in bulk carrier holds

DNV proposed that conditions for rafting should be limited to areas, such as anchorage or harbour, where swell conditions are limited to 0.5m. After discussion, GPG approved the ABS' alternative proposal to use the swell condition as a basis to determine the appropriateness of rafting, instead of geographic areas(harbours or anchorage). 5.5.4 of Z10.2 refers.

RINA proposed that para 5.5.4 should be included in all the Z10s. NK's objection is recorded as follows (3037hNKq, 29/08/2005):

1. With regard to RIm of 26 August 2005, NK considers that the proposed amendment to 5.5.4 should be limited to UR Z10.2.
2. Rafting survey for tankers are actually carried out on the open sea from a discharge port to a loading port and in such situation the rise of water within the tanks would always exceed 0.25m. It is different situation from rafting survey for hold frames of bulk carriers normally conducted in a harbour or at an anchorage.
3. If the same requirement applies to tankers, any rafting survey for cargo oil tanks and ballast tanks of tankers would be prohibited. This is not practicable under present survey procedure for tankers.
4. Therefore, NK can not support Laura's proposal that the proposed amendment to 5.5.4 of UR Z10.2 is introduced into the other URs and new Recommendation.

For compatibility with the IMO's mandatory requirements\*, GPG decided to add the same amendment to all the UR Z10s.

\*

- Appendix 4 to MEPC.99(48) 'Mandatory requirements for the Safe Conduct of CAS Surveys'
- MSC.197(80) – amendments to A.744918), Annex A for DSS and SSS bulk carriers and Annex B for single and double hull oil tankers.

As a consequence, 5.5.1 of REC 91(ex Annex to UI SC191) was also amended:

- to remove the reference to dynamic /sloshing (as the 0.25m rise was considered negligible);
- to refer to the rafting conditions contained for cargo holds in Z10.2 and Z10.5 and for oil cargo tanks in Z10.1 and Z10.4.

5. Means of access from longitudinal permanent means of access within each bay to rafts

GPG reviewed the proposal that the following text be added to Z10s:

[A means of access to the longitudinal permanent platform from rafts or boats is to be fitted in each bay.](#)

(Technical Background: for the safety of surveyors)

There may be ships which are arranged in accordance with para b, page 8 of the Annex to the current SC 191 (i.e., no means of access from the LPMA in each bay to a raft is required) and therefore could not be rafted if the sentence proposed by RINA("A means of access to the longitudinal permanent platform from rafts or boats is to be fitted in each bay") is included in the Z10's.

GPG therefore agreed not to include this sentence in Z10s.

For the same reason, the same sentence was not added to Rec.39.

Finally, GPG added the following sentence to UI SC191(interpretation for II-1/3-6):

*A permanent means of access from the longitudinal platform to the water level indicated above is to be fitted in each bay (e.g permanent rungs on one of the deck webs inboard of the longitudinal permanent platform).*

## **6. Implementation**

It was agreed that the revised UI SC191 be implemented to ships contracted for construction 6 months after adoption by Council.

UI SC191 was also edited in line with IMO MSC/Circular. 1176, leaving its mandatory language (is/are to, shall) unchanged.

(Note: UI SC191(Rev.2) makes references to the following new Recommendations:

- REC 90: Ship Structure Access Manual
- REC 91: Guidelines for approval/acceptance of Alternative Means of Access)

23 September 2005  
Permanent Secretariat  
Updated on 13 Oct 2005.

**Survey Panel Task 11 – Unified Periodic Survey Requirements related to SOLAS  
Reg. XII/12 & Reg. XII/13.**

**Technical Background**  
**Amendments to UR Z10.2(Rev.19, Jan 2006) and UR Z10.5 (Rev.3, Jan 2006)**

**1. Objective**

To amend UR 10.2 Section 2.6 and 3.4 and UR Z10.5 Section 2.6 and 3.3 to include survey requirements related to SOLAS reg. XII/12 and XII/13.

**2. Background**

This task was originally discussed during the WP/SRC annual meeting which took place at DNV Headquarters on the 26<sup>th</sup> to 28<sup>th</sup> October 2004; it was subsequently recorded under paragraph 9 “any other business” of the minutes of this meeting. While the SOLAS Reg.XII/12 (hold, ballast and dry spaces water level detectors) and XII/13 (availability of pumping systems) retroactive requirements for existing bulk carriers have entered into force on 1<sup>st</sup> July 2004, as required by IMO Res.MSC.134(76), the IACS UR S 24 has been deleted on 1<sup>st</sup> January 2004. In addition, SOLAS does not include any periodical survey requirements for such detection systems and pumping systems.

**3. Methodology of Work**

Survey Panel members through correspondence.

**4. Discussion**

Survey Panel member from BV raised this issue at the February 2005 Survey Panel meeting and volunteered to propose amendments to the applicable URs for Panel members to review and comment on through correspondence. At the Fall meeting of the Survey Panel, it was agreed upon by all Panel members that the proposed amendments for UR Z10.2 and Z10.5 as applicable, which were proposed by BV were acceptable.

**5. Implementation**

The Survey Panel is of the view that the Members need 12 months from the adoption date to implement these amendments into their class rules. Assuming that GPG and Council approve to the amendments, the Survey Panel would propose January 2007 as an implementation date.

Submitted by Survey Panel Chairman  
4 Nov 2005  
approved on 31 Jan 2006 (5031fICa)

**Survey Panel Task 4 –  
Means of Access for Close-Up Surveys of Capesize Bulk Carrier hold frames  
Technical Background  
UR Z10.2 / Section 5.3 (Rev. 20, s/n 4110a, 10 Feb 2006)**

### **1. Objective**

To amend the requirements of UR 10.2 section 5.3.2 regarding the Close-up survey of hold frames with respect to acceptable means of access.

### **2. Background**

In a report to Council at C50 on the loss of side shell on a capesize vessel, it was stated that issues regarding the means of access for survey of hold frames was raised by the incident which had Council request the Survey Panel to review the current requirements for means of access for the surveyor, especially on existing capesize vessels.

### **3. Methodology of Work**

The Survey Panel, at its February 2005 meeting decided that this task should be dealt with by a project team, led by NK with members from BV, ABS, KR and CCS participating.

### **4. Discussion**

The members of the project team, through correspondence and one meeting in Japan, came to an agreement on the revisions to URZ10.2 Section 5.3..2 on how to address the concerns of Council. It was decided that the requirements for means of access be divided into two sections to better define the requirements applicable to each size of vessel; capesize and all bulk carriers under capesize. In addition, the requirements for capesize bulk carriers were then divided to indicate different requirements for annual, intermediate and special survey. Regarding the amendments for acceptable means of access, it was agreed upon by the Project team that hydraulic arm vehicles, boats or rafts, and portable ladders for bulk carriers less than capesize, should be added to the list of equipment for means of access. The Project Team representative at the Fall Survey Panel meeting from BV, presented the project team proposals to the Panel, which after some editorial changes, unanimously agreed to the proposed amendments to URZ10.2 section 5.3.2.

### **5. Implementation**

The Survey Panel is of the view that the Members need 12 months from the adoption date to implement these amendments into their class rules. Assuming that GPG and Council approve to the amendments, the Survey Panel would propose 1 January 2007 as an implementation date.

Submitted by Survey Panel Chairman  
2 Nov 2005

## Permsec's Note

1. LR sought confirmation from the Survey Panel as to whether these amendments did not go against SOLAS regulation II-1/3-6 and TP and IACS UIs and MSC Circular. LR added that Bulk carriers being built today would have Access Manuals which would define means of access for close-up surveys approved by ROs on behalf of Administrations.

2. It was then confirmed that the Survey Panel's proposal was consistent with all IMO and IACS requirements and recommendations except that for capesize and above, it limited the use of portable ladders. In that regard, ABS proposed an editorial modification to achieve consistent text with REC.91 and that REC.91 be revised to refer to the limitation of ladders introduced in 5.3.2 and 5.3.3 of UR Z10.2 (Rev.18). See REC 91, para. 5.6.1 (Rev.1, Nov 2005).

3. For reference, ABS' clarifications to the points raised by LR are attached (4110aABb, 16 Nov 2005).

## 4. Council discussion

### 4.1 Editorial nature:

Council approved the NK proposal to re-number the paragraphs 5.3.2~5.3.4, and to relocate references to "shell frames" / "hold frames" from the bulleted items to the chapeaux of the re-numbered paragraphs by referring to these cargo hold structural members as "cargo hold shell frames". This is consistent with the current text of Z10.2 which predominantly refers to these cargo hold structural members as "shell frames".

### 4.2 Substantive nature - para.5.3.4

#### 4.2.1 NK's first proposal:

The following NK's proposed revision of paragraph 5.3.4 of Z10.2 did not achieve 3/4 majority support by Council Members.

"5.3.4 For close-up surveys of the cargo hold shell frames of capesize bulk carriers (100,000 dwt and above), the use of *free standing* portable ladders *irrespective of their length*, is not accepted, and one or more of the following means for access, acceptable to the surveyor, is to be provided:"

**Not adopted, Reason:** The introduction of "free standing" portable ladders is contrary to what GPG and the Survey Panel unanimously agreed with respect to prohibiting the use of any type of portable ladders (free standing, articulated, or otherwise) for close up surveys of cargo hold shell frames of bulk carriers (100k dwt and above). The text of the re-numbered paragraph 5.3.4 therefore remained without changes.

#### 4.2.2 NK's 2<sup>nd</sup> proposal:

NKc offered a "compromise" proposal with a view to resolving this dilemma which would retain the original text of 5.3.4 but add a paragraph allowing the use of portable ladders fitted with a mechanical device to secure the upper end of the ladder only for Annual Survey of cargo hold shell frames of capesize bulk carriers

Under 5.3.4

Notwithstanding the above requirements, for close-up surveys of the cargo hold shell frames at Annual Survey, the use of portable ladder fitted with a mechanical device to secure the upper end of the ladder is accepted.

#### 4.2.3 LR agreed but expressed the following view:

If the argument for limiting the use of ladders is still valid then there is a need to specify that their use is permitted only for "Close-up examination of sufficient extent, minimum 25% of frames, to establish the condition of the lower region of the shell frames including approx. lower one third length of side frame at side shell and side frame end attachment and the adjacent shell plating in the forward cargo hold", however "Where this level of survey reveals the need for remedial measures, the survey is to be extended to include a Close-up Survey of all of the shell frames and adjacent shell plating of that cargo hold as well as a Close-up survey of sufficient extent of all remaining cargo holds" the ladders should not be used and the hold should be staged.

LR's text was then modified by the Chairman to address the minimum extent of close-up survey of frames of capesize bulkers age 10 and older, at annual survey as required in 3.2.4 of UR Z10.2:

Under 5.3.4:

Notwithstanding the above requirements, the use of a portable ladder fitted with a mechanical device to secure the upper end of the ladder is acceptable for the "close-up examination of sufficient extent, minimum 25% of frames, to establish the condition of the lower region of the shell frames including approx. lower one third length of side frame at side shell and side frame end attachment and the adjacent shell plating of the forward cargo hold" at Annual Survey, required in 3.2.4.1.b, and the "one other selected cargo hold" required in 3.2.4.2.b.

**Adopted on 10 Feb 2006.**

**Attached:** ABS' clarifications to the points raised by LR are attached (4110aABb, 16 Nov 2005).

---

**From:** AIACS@eagle.org  
**Sent:** 16 November 2005 19:46  
**To:** iacs@bureauveritas.com; clnkiacs@classnk.or.jp; colinwright@iacs.org.uk; efs@iacs.org.uk; iacs@lr.org; gilyonghan@iacs.org.uk; helenbutcher@iacs.org.uk; iacs@ccs.org.cn; iacs@dnv.com; iacs@rina.org; iacs@rs-head.spb.ru; iacs@gl-group.com; johnderose@iacs.org.uk; krsiacs@krs.co.kr; richardleslie@iacs.org.uk; terryperkins@iacs.org.uk  
**Subject:** 4110aABb: Close-up surveys of bulk carrier hold frames, P/SU Task [4] (C50 FUA 7)

Date: 16 Nov 05

TO: Mr. Steven McIntyre, IACS GPG Chairman

CC: IACS GPG Members

CC: IACS Permanent Secretary: Mr. R. Leslie

FROM: S. R. McIntyre

File Ref: T-12-2

Subject: 4110aABb: Close-up surveys of bulk carrier hold frames, P/SU Task [4] (C50 FUA 7)

I note Kosta's LRb request to "*know the effect the proposed amendment will have on the designs already formally accepted to comply with SOLAS and IACS UI*" before giving final approval to the amendments. While the effect will only be known for each ship depending on the arrangement provided, I have the following comments to the numbered points Kosta raises:

3. I do not consider that a "*significant impact*" will result if IACS limits the use of portable ladders > 5m in length, since use of these ladders would otherwise greatly increase the time to survey, gauge and, if necessary, repair the side shell relative to employing other alternatives (e.g., cherry pickers). While the owner would have paid for these ladders based on RO's approval, the proposed UR would limit their use for survey only and these ladders are still available for use by the crew (which is included in the objectives of the TP's) to carry out maintenance and inspection.

4. Until such time that the TP's, MSC/Circ.1176 and/or the UI SC 191 are revised, ABS will ensure that those responsible for approving the SSAS are aware of the more limited choice of alternative means of access for capesize bulk carriers as per draft provisions of UR Z10.2.

4.1 The draft proposals for Z10.2 do not address, and therefore allow, the use of portable ladders > 5 m in spaces other than cargo holds.

Regards,

S. R. McIntyre

ABS IACS GPG Member

email protected and scanned by BIS Advanced Spam & Virus Checking - powered by AdvscanTM  
- keeping email useful



**Survey Panel Task 37 – Amend UR Z10.2 to increase the scope of the survey requirements of Special Survey No.2 and the Intermediate Survey between Special Survey No. 2 and No.3 for Cape Size Bulk Carriers**  
**Technical Background Document**  
**UR Z10.2**  
(Rev.21, May 2006)

**1. Objective:**

Amend UR Z10.2 to increase the scope of the survey requirements of Special Survey No.2 and the Intermediate Survey between Special Survey No. 2 and No.3 for Cape Size Bulk Carriers

**2. Background**

The project team from Survey Panel Task 4, which dealt with amending the close-up surveys of bulk carrier hold frames, recommended to the Survey Panel at the Fall 2005 meeting that the Survey Panel should be tasked to amend the relevant sections of UR Z10.2 to increase the scope of requirements for Cape size bulk carriers because of the intermediate survey between SS No2 and & 3 is more critical than Special survey no.2 in respect of the close-up survey of hold frames.

**3. Discussion**

The member from NK proposed the following:

NK does not agree with the draft amendments of special survey No.2 in IAb which are completely same as the requirements of special survey No.3.

There should be some difference between the requirements of special survey No.2 and No.3 because the requirements in the Table I are become stricter as ships become older.

NK proposed to reduce "one other selected cargo hold" from the draft.

All members agreed to the proposal from NK, with further minor amendments from RINA and BV, which was agreed upon unanimously by Panel members at the Spring 2006 meeting.

**4. Implementation**

The Survey Panel is of the view that the Members need 12 months from the adoption date to implement these amendments into their class rules/procedures. Assuming that GPG and Council approve the amendments, the Survey Panel would propose **July 2007** as an implementation date.

**Submitted by Survey Panel Chairman**

**Survey Panel Task 43 – Amend the applicable sections of the URs to address the requirements for substantial corrosion in the Common structural rules.**

**Technical Background**

**(UR Z10.2, Rev.22, June 2006)**

**(UR Z10.4, Rev.4, June 2006)**

**(UR Z10.5, Rev.4, June 2006)**

**1. Objective**

Amend applicable sections of the URs to address the requirements for substantial corrosion in the Common structural rules.

**2. Background**

Due to the different application of substantial corrosion in the CSR from the current Unified Requirements.

**3. Methodology of Work**

Panel members discussed the proposed revisions through correspondence up to the Spring Panel meeting where final amendments were agreed upon for submittal to the IACS Hull Panel for review.

**4. Discussion**

After much discussion between all Panel members at the March 2006 Survey Panel members, a unanimous decision was reached as to the wording of CSR Substantial corrosion in UR Z10.2, 10.4, and 10.5 in section 1.2.9 and was then submitted to the Hull Panel for review and approval. The hull panel concluded that the Survey Panel definition for CSR substantial corrosion was not entirely accurate and recommended further amendments to clarify the actual requirements. The new definition was then circulated to the Survey Panel for a final review and was unanimously agreed upon.

**5. Implementation**

The Survey Panel is of the view that the Members need 12 months from the adoption date to implement these amendments into their class rules/procedures. Assuming that GPG and Council approve the amendments, the Survey Panel would propose **July 2007** as an implementation date.

Submitted by Survey Panel Chairman

## **Technical Background**

### **UR Z10.1 (Rev.14), UR Z10.2 (Rev.23), UR Z10.4 (Rev.5) & UR Z10.5 (Rev.5)**

#### **Survey Panel Task 3 – Maintenance of Alignment/ Compatibility of IACS URs and IMO survey requirements**

##### **1. Objective**

Maintenance of alignment/compatibility of IACS URs and IMO survey requirements regarding resolution MSC 197(80) – amendments to A744(18)

##### **2. Background**

IMO survey requirements to ESP vessels as amended in A744(18) as noted in MSC 197(80), with an implementation date of 1 January 2007.

##### **3. Methodology of Work**

Survey Panel members through correspondence.

##### **4. Discussion**

Survey Panel members, at the fall 2006 Survey Panel meeting, finalized the amendments to the applicable URs due to changes adopted at MSC(80).

Additionally, Members noted that URZ10.4 paragraphs 2.2.3.1 and 4.2.2.2 does not require examination of ballast tanks adjacent to heated fuel tanks, as required by MSC197(80). The survey panel agreed that if this is the position that IACS would like to take regarding double hull tankers, then it should be brought to the attention of IMO at the next IMO meeting, DE50 in March 2007.

##### **5. Implementation**

The Survey Panel is of the view that the Members need 12 months from the adoption date to implement these amendments into their class rules. Assuming that GPG and Council approve the amendments, the Survey Panel would propose January 2008 as an implementation date, although the IMO implementation date is January 2007.

Submitted by Survey Panel Chairman  
9 January 2007

##### **GPG discussion**

All members agreed to omit the requirement of examination of ballast tanks adjacent to heated fuel tanks, as required by MSC197(80), from URZ10.4 for double hull tankers and

that it should be brought to the attention of IMO at DE50. In addition ABS proposed that paragraphs relating to similar requirements in URZ10.1 should also be deleted for consistency and this was agreed by members.

Members also made a number of minor/editorial corrections to the text prior to their approval of the revised documents.

Added by Permanent Secretariat  
23 April 2007

## Technical Background Document

### UR Z10.5 (Rev.6 April 2007) & UR Z10.2 (Rev.24 April 2007)

#### *(Survey Panel Task 10 – Develop survey requirements for void spaces of ore carriers)*

#### **1. Objective:**

Develop survey requirements for void spaces of ore carriers

#### **2. Background**

DNV requested at WP/SRC Annual meeting October 2004 to develop survey requirements void spaces of ore carriers. See the attached document « Ore Carriers, Hull Survey Requirements » for easy reference. NK submitted a « A case study on a certain Ore Carrier » dated 22 October 2004 for this purpose.

#### **3. Discussion**

The task has been carried out by a Project Team chaired by DNV Survey Panel member and with Survey Panel members from BV, LR, NK and RINA.

The Project Team drafted new amendments to Unified Requirement UR Z 10.5 « Hull Surveys of Double Skin Bulk Carriers » using the same principles contained in the survey requirements of UR Z10.1 for ballast spaces of single hull oil tankers with appropriate adjustments recognizing that void spaces do not carry ballast water.

In that respect, a new TABLE I/Sheet 2 was developed to cover the minimum requirements for close-up surveys at special hull surveys of ore carriers. The existing TABLE I, renamed TABLE I/Sheet 1, was made applicable to double skin bulk carriers excluding ore carriers.

Accordingly, TABLE III/Sheet 3 (REQUIREMENTS FOR EXTENT OF THICKNESS MEASUREMENTS AT THOSE AREAS OF SUBSTANTIAL CORROSION OF DOUBLE SKIN BULK CARRIERS WITHIN THE CARGO LENGTH AREA) was renamed STRUCTURE IN DOUBLE SIDE SPACES OF DOUBLE SKIN BULK CARRIERS INCLUDING WING VOID SPACES OF ORE CARRIERS.

In addition, Sheets 15 and 16 of URZ10.2 Annex II are to be removed.

The draft amendments to UR Z10.5 were presented to the Survey Panel members on the 13th-15th September 2006 meeting at ABS Headquarters in Houston and were finally agreed by all members on the 22nd September 2006.

#### **4. Implementation**

The Survey Panel is of the view that the Members need 12 months from the adoption date to implement these amendments into their class Rules/procedures. Assuming that GPG and Council approve the amendments by the end of 2006, the Survey Panel would propose as an implementation date for surveys commenced on or after the **1 July 2008**

Submitted by Survey Panel Chairman  
22nd March 2007

#### **Permsec note (May 2007):**

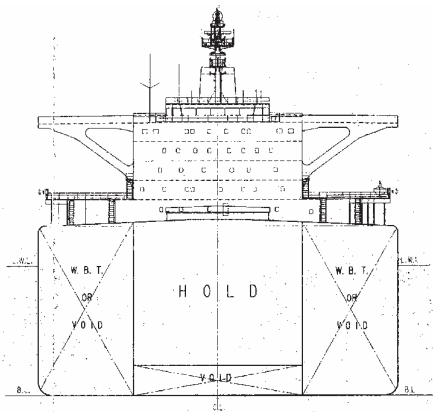
Revisions adopted by GPG 12 April 2007 (5031hIGg).

**Attachment:**

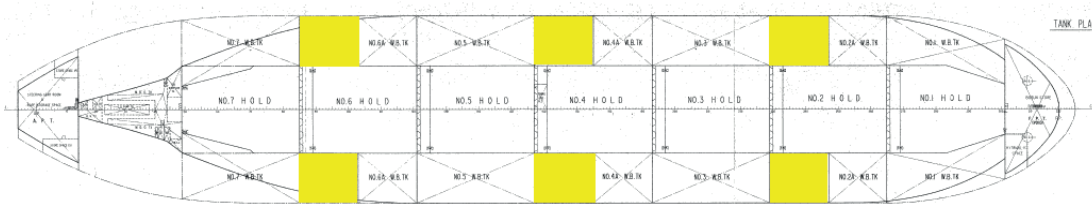
**Ore Carriers, Hull Survey Requirements**

"Ore carrier" means a single deck ship having two longitudinal bulkheads and a double bottom throughout the cargo region and intended for the carriage of ore cargoes in the centre holds only. Side tanks are generally arranged for the carriage of water ballast.

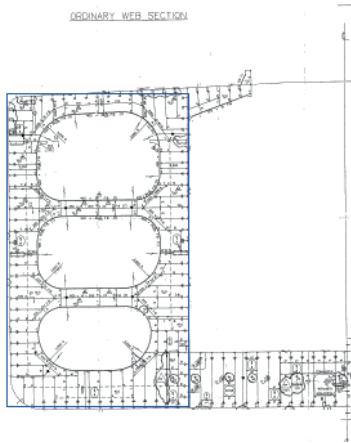
In accordance with UR Z10.5, for close-up surveys of side ballast tanks of ore carriers, the survey requirements of side ballast tanks for oil tankers as given in UR Z10.1 apply.



However, the amount of ballast water required to meet draught requirements for navigation / harbour operations, are generally less than the total capacity of the side tanks. Hence ore carriers are often designed with several side tanks as void spaces.



The internal structures are generally as for side ballast tanks with transverse web frame rings. The protective coating, if any, may be less durable than coating applied for ballast tanks and the void spaces are exposed to corrosion.



Ore carriers are generally large sized vessels and the overall survey of side void spaces may not be sufficient in order to carry out a meaningful survey for detection of corrosion and other structural defects.

**It is proposed to consider minimum requirements for close-up surveys for side void spaces. Requirements given in UR Z10.1 applicable to side cargo tanks may be used as basis.**

DNV 2004-10-19

## **Technical Background**

### **UR Z10.2, Rev.25 (July 2007)** ***Amendments to 5.3.3 , 5.3.4 and Table 1***

*(Survey Panel Task 1 – Annual Review of Implementation of IACS Resolutions)*

#### **1. Objective**

Maintenance of alignment/compatibility of IACS URs and IMO survey requirements

#### **2. Background**

This proposed change was raised by the ABS member from the Survey Panel, due to questions raised by industry.

#### **3. Methodology of Work**

Survey Panel members through correspondence.

#### **4. Discussion**

Due to the many different interpretations of what size a Cape size bulk carrier is, the wording “Cape Size’ is proposed to be removed and replaced with “...100,000 dwt and above.”, to make the additional requirements very clear, regarding applicability. All members of the Survey Panel unanimously agreed to this proposed change.

#### **5. Implementation**

The Survey Panel is of the view that the Members need 12 months from the adoption date to implement these amendments into their class rules. Assuming that GPG and Council approve to the amendments, the Survey Panel would propose July 2008 as an implementation date.

Submitted by Survey Panel Chairman  
22 June 2007

#### **Permanent Secretariat note (July 2007):**

Adopted by GPG with an implementation date of 1 July 2008 on 19 July 2007 (ref. 5031kIGd).



## **Technical Background**

**URs Z7(Rev.15), Z7.1(Rev.5), Z7.2(Rev.1), Z10.1(Rev.15),  
Z10.2(Rev.26), Z10.3(Rev. 9), Z10.4(Rev.6), Z10.5(Rev.8) – November  
2007**

### ***Survey Panel Task 1 – Annual Review of Implementation of IACS Resolutions***

#### **1. Objective**

To review IACS Resolutions annually and discuss or propose amendments as deemed necessary.

#### **2. Background**

This proposed amendment to all URZ7s and URZ 10s was raised by the Panel member from DNV due to Owners crediting tanks concurrently under intermediate and special survey.

#### **3. Methodology of Work**

Survey Panel members through correspondence.

#### **4. Discussion**

The Panel member from DNV raised the issue of Owners having the ability of crediting spaces and thickness measurements only once in a 54 month interval, due to the availability of concurrent crediting of spaces and thickness measurements due to the flexible time window that is currently allowed between the intermediate survey and the special survey.

After a presentation and discussion lead by the DNV Panel member, all Survey Panel members agreed to the argument given by DNV, and further agreed to make the necessary changes in all URZ7s and URZ10s where Owners are not allowed to concurrently credit surveys and thickness measurements of spaces.

#### **5. Implementation**

The Survey Panel is of the view that the Members need 12 months from the adoption date to implement these amendments into their class rules. Assuming that GPG approve to the amendments, the Survey Panel would propose January 2009 as an implementation date.

Submitted by Survey Panel Chairman  
22 October 2007

**Permanent Secretariat note (December 2007):**

During GPG discussion DNV proposed that *“since this matter will be discussed between Owner and Class mainly in connection with the forthcoming Special Survey, DNV would prefer to locate this text, not only as part of Intermediate Survey, but also as a new text for the Special Survey.”* This was supported by BV, ABS, RINA and KR.

The revised documents were approved, with DNV’s proposal and an implementation date of 1 January 2009, on 15 November 2007 (ref. 7690\_IGb).

## Technical Background

### URs Z7(Rev.16), Z7.1(Rev.6), Z7.2(Rev.2), Z10.1(Rev.16), Z10.2(Rev.27), Z10.3(Rev.11), Z10.4(Rev.7) and Z10.5(Rev.9) - March 2009

#### Survey Panel Task 62:

- A) *Harmonization of UR Z10.1, Z10.2, Z10.4 and Z10.5 with UR Z10.3 with respect to items 5.5.4.4 and 5.6.2.*
- B) *Harmonization of UR Z7, Z7.1, Z10.1, Z10.2, Z10.3, Z10.4 and Z10.5 with UR Z7.2 with respect to the definition of the corrosion prevention system and with respect to the footnote 1 related to semi-hard coatings.*
- C) *Harmonization of the definition of Ballast Tank in UR Z7(Rev.14)*

#### 1. Objective

- A) Amend the texts of items 5.5.4.4 and 5.6.2 in Unified Requirements Z10.1, Z10.2, Z10.4 and Z10.5 in order to align them with those in UR Z10.3, in which they were changed while performing Task 55, whereas in the other UR Z10s they were kept unchanged on the grounds that this change was out of the scope of Task 55.
- B) Amend the definition of “Corrosion Prevention System” and include a Footnote 1 related to semi-hard coatings in Unified Requirements Z7, Z7.1, Z10.1, Z10.2, Z10.3, Z10.4 and Z10.5 in order to align them with those adopted in UR Z7.2, when this new UR was issued.
- C) Amend UR Z7 (Rev. 14) in all items where the term “Ballast Tank” is used in order to get them harmonized with the definition itself.

#### 2. Background

The task, as regards item A), was triggered by a Member Society, while performing Task 55, on the grounds that this part was out of the scope of the task and then should have been dealt with in a separate task.

The task, as regards item B), was triggered as a consequence of the “New Business action item 2” of the Minutes of the September 2008 Survey Panel meeting, for sake of harmonization of the various URZs.

The task, as regards item C), was triggered as a consequence of the “Task 54-Examination of Double Bottom Ballast Tanks at annual surveys” of the Minutes of March 2008 Survey Panel meeting, for sake of harmonization of the definition of Ballast Tank in UR Z7(Rev.14).

#### 3. Discussion

The task was carried out by correspondence. All the amended texts for the affected URs were prepared by the Survey Panel Member who had chaired the PT on Task 55, in accordance with the Form A approved by GPG. In addition to the objectives outlined in the Form A, an amendment was added to item 1.3.1 of UR Z10.2 and UR Z10.5 in which the reference 3.2.3.6 in the last item of the list was replaced by 3.2.3.10 as can be correctly verified in the text.

The amended URs were circulated to all Survey Panel Members for review, comments and agreement. The texts of the URs were unanimously agreed by all Members.

#### **4. Implementation**

The Survey Panel is of the view that the Member Societies need at least 12 months from the adoption date to implement these amendments into their class rules/procedures. Therefore, in the first version of all amended URs the following implementation sentence should be proposed:

*Changes introduced in Rev .xx are to be uniformly applied by Member Societies and Associates for surveys commenced on or after [not less than 12 months after the adoption by GPG/Council].*

Since it is common practice and convenience to have implementation dates either on 1<sup>st</sup> January or on 1<sup>st</sup> July of the year, the Survey Panel proposes the 1<sup>st</sup> July 2010 as implementation date, if GPG/Council approve the URs not later than 30 June 2009.

**Submitted by Survey Panel Chairman  
28 February 2009**

#### **Permanent Secretariat notes (April 2009):**

1. The amended URs were approved by GPG on 18 March 2009 (ref. 7718bIGd).
2. During the typesetting process it was noted that para 5.1.5 of UR 7.2 was inconsistent with the amended URs and so following consultation with the Survey Panel this was also amended at this time.
3. Regarding the implementation date, GPG agreed to use 1<sup>st</sup> July 2010 provided that it was consistently used for the amended URs.

## **Technical Background for UR Z10.2 Rev.28 (Mar 2011)**

### **1. Scope and objectives**

- 1) To amend UR Z10.2 to harmonize the definition of transverse section.
- 2) Update of references in the Executive Hull Summary Table VII.
- 3) Correction of "minimum allowable diminution" to "maximum allowable diminution" in Annex II.
- 4) Review IACS URZ10.2 to determine if there are issues which need to be addressed to ensure that the IACS survey regime and the CSRs are compatible.

### **2. Engineering background for technical basis and rationale**

- 1) Based on that fact that bulk carriers and oil tankers have a transverse framing system applied for example on ship's sides etc. and that UR Z7 is applied to all types of ships and includes an extended definition of transverse section it is necessary to unify this definition in UR Z10s.
- 2) Update of references in the Executive Hull Summary Table VII such that the introduction of extended annual surveys is noted in the 'Memoranda' section rather than under 'Conditions of Class'.
- 3) Correction of "minimum allowable diminution" to "maximum allowable diminution" in Annex II to be consistent with the other UR Z10s.
- 4) Some requirements in CSRs for Bulk Carriers were relevant to ships in operation and it was decided to move them from CSRs to UR 10.2 in more consistent way.

### **3. Source/derivation of the proposed IACS Resolution**

CSRs, IACS UR Z7 and other UR Z10s.

Proposed amendments to UR Z10.2 is based on internal discussion of IACS which is always striving to produce consistent and compatible rule requirements.

### **4. Summary of Changes intended for the revised Resolution:**

- 1) The following additional text is added to the definition of transverse section in para 1.2.7:

*"For transversely framed vessels, a transverse section includes adjacent frames and their end connections in way of transverse sections."*

- 2) In the Executive Hull Summary Table VII (iv) the reference to part G) is updated to part H) as per Table VII (ii).
- 3) The wording "minimum allowable diminution" is corrected to "maximum allowable diminution" in Annex II

## Part B

4) The main amendment has consisted in removing the requirements found in the CSRs related to surveys after construction and locating them in the applicable sections of UR Z10.2. The rationale of that is to have only one place where survey requirements are given and avoid any duplication of requirements in different documents, which would give rise to problems of maintenance and alignment.

Another important amendment has been the requirement for annual examination of the identified substantial corrosion areas for bulk carriers. One Member Society was of the opinion that there should be no difference between the CSRs and non-CSRs bulk carriers. The other Member Societies were of the opinion to consider an alternative examination, which was the original requirement in CSRs, and thus the following text was adopted in UR Z10.2:

"For vessel built under IACS Common Structural Rules, the identified substantial corrosion areas may be:

- a) protected by coating applied in accordance with the coating manufacturer's requirements and examined at annual intervals to confirm the coating in way is still in good condition, or alternatively
- b) required to be gauged at annual intervals."

Other important amendments have been made moving the following items from the CSRs to UR Z10.2 as applicable:

- a) the paragraphs regarding the different corrosion patterns, such as pitting corrosion, edge corrosion and grooving corrosion, and their different acceptance criteria,
- b) the items regarding the number and locations of thickness measurements, together with the associated table and referenced figures.

Another notable change has been introduced in the "ANNEX II - Recommended Procedures for Thickness Measurements" of UR Z10.2, which, however, are only recommendatory and not mandatory, where thickness measurements forms specific to CSRs single skin bulk carriers have been produced in addition to the existing ones, which only apply to non-CSRs ships.

Finally, for CSRs bulk carriers the requirement has been introduced which stipulates that "the ship's longitudinal strength is to be evaluated by using the thickness of structural members measured, renewed and reinforced, as appropriate, during the special surveys carried out after the ship reached 15 years of age (or during the special survey no. 3, if this is carried out before the ship reaches 15 years) in accordance with the criteria for longitudinal strength of the ship's hull girder for CSRs bulk carriers specified in Ch 13 of CSRs".

### **5. Points of discussions or possible discussions**

See item 4 above.

### **6. Attachments if any**

None.

## **Technical Background for UR Z10.2 Rev.29, July 2011**

### **1. Scope and objectives**

Review the requirement for repairs within IACS UR 7 and UR 10 series, in particular the requirement for Prompt and Thorough Repair, with a view to developing wording that would permit a temporary repair and the imposition of a Recommendation/ Condition of Class under specific and controlled circumstances, and in accordance with PR35.

### **2. Engineering background for technical basis and rationale**

There are instances, for example a localised, isolated and very minor hole in a cross-deck strip, at which a suitable temporary repair, for example by welding or doubling, and the imposition of a suitable short term Recommendation/ Condition of Class for permanent repair at a later date, are considered very adequate methodology for dealing with the defect.

Current IACS Requirements in the UR Z7 and Z10 series, for Prompt and Thorough repair, would not permit this to be an option, the defect would have to be permanently Promptly and Thoroughly repaired, which might require removing cargo, moving to a repair berth and staging inner spaces.

Under the Requirements of IACS Procedural Requirement PR 35 the methodology of Temporary Repair and imposition of a suitable short term Recommendation/ Condition of Class for permanent repair at a later date is fully permissible.

### **3. Source/derivation of the proposed IACS Resolution**

Based upon discussion within the IACS Survey Panel.

### **4. Summary of Changes intended for the revised Resolution:**

Following the definition of Prompt and Thorough Repair in the Unified Requirement, a new paragraph is proposed to be added:-

"1.3.3 Where the damage found on structure mentioned in Para. 1.3.1 is isolated and of a localised nature which does not affect the ship's structural integrity, consideration may be given by the surveyor to allow an appropriate temporary repair to restore watertight or weather tight integrity and impose a Recommendation/Condition of Class in accordance with IACS PR 35, with a specific time limit."

### **5. Points of discussions or possible discussions**

a) The points of discussion are as indicated in Sections 2 and 4 above.

b) Discussion took place on whether to prepare this amendment as a Unified Interpretation of IMO Resolution A.744(18)/UR Z7 and Z10 series, finally it was agreed to make direct amendment to the relevant URs.

c) It is proposed that this amendment be submitted directly to the IMO DE/MSC Committees for consideration of amending directly IMO Res. A744(18)

**6. Attachments if any**

None



## **Technical Background for UR Z10.2 Rev.31, Jan 2014**

### **1. Scope and objectives**

- a) To consider appropriate text in IACS document regarding class period for lengthy conversions.
- b) To align the requirements in PR37 and UR Z10s regarding safe entry to confined spaces.

### **2. Engineering background for technical basis and rationale**

- a) As per the IMO Res. A1053 (27), lengthy conversions (not necessarily of major character) or other major repair work can be assigned for a 5 year period from the date of completion of conversion/repairs/surveys.
- b) Safety requirements in IACS PR37 can be applied to carry out survey in safe way for all kind of ships. When there are no indications about the safety of surveyor in UR Z10s then the requirements in PR37 shall be applied.

### **3. Source/derivation of the proposed IACS Resolution**

None

### **4. Summary of Changes intended for the revised Resolution**

- a) Following additional text was included to section 2.1.3 to clarify the class period for lengthy conversions

"In cases where the vessel has been laid up or has been out of service for a considerable period because of a major repair or modification and the owner elects to only carry out the overdue surveys, the next period of class will start from the expiry date of the special survey. If the owner elects to carry out the next due special survey, the period of class will start from the survey completion date."

- b) Existing Section 5.2.6 and 5.2.7 were deleted from UR Z10s since provisions of these sections were covered by PR37. Reference of PR37 was included in Section 5.2.1.1.

### **5. Points of discussions or possible discussions**

- i) Additional text to Para.2.1.3 was discussed in order to clarify class period.
- ii) Panel considered that safety of surveyors should be dealt by PR37.

### **6. Attachments if any**

None

## Technical Background Document

### UR Z10.2 – Revision 10 For ExCM decisions

#### Objective and Scope:

Revise UR Z10.2 to introduce ExCM (Extraordinary Council Meeting in Feb 2000) decision to UR Z10's

- ExCM FUA 2-2: Intermediate surveys of ships subject to ESP, which are over 15 years of age, will be enhanced to the scope of the preceding special survey with dry docking or under water survey as applicable.

#### Source of Proposed Requirements:

The proposed requirements were developed by WP/SRC Chairman, shortly after GPG 48<sup>th</sup> meeting:

- The para. 4.2.2, 4.2.3 & 4.2.4 for ExCM FUA 2-2.
- For the outcome of WP/SRC Task 49 “application of Z10.2 to ore carriers), the para. 4.2 was re-arranged.
- The paragraph 8.2.1 for compatibility with the PR 19 (ABS GPG suggested.)
- 

#### Points of Discussion:

GPG 48 meeting discussed whether to extend the requirement of ExCM FUA 2-1 to other ships and C 41 confirmed not to extend this requirement to other ships for the time being.

- - ExCM FUA 2-1: All ballast tanks adjacent to cargo tanks with heating coils shall be examined internally on an annual basis after the ship has reached 15 years of age.

#### Unresolved Comments:

-

#### Discussions:

In addition, LR (GPG) proposed the following additions:

- The second half of the para. 4.2.4.1(LR)  
“except that testing of cargo and ballast tanks is not required unless deemed necessary by the attending surveyor.”  
The majority GPG agreed.
- The paragraph 7.1.1 of Z10.1 and Z10.3, paragraph 8.1.2 of Z10.3 were revised for their compatibility with the PR 19 “PR for Thickness Measurement”.

**Technical Background Document**  
**WP/SRC Task 49**  
**UR Z10.2 – Proposed Draft Revision 10**  
(submitted by WP/SRC Chair on 10 June 2000)

**Objective and Scope:**

Review UR Z10.2 for the purpose of verifying that it also fully applies to Ore Carriers as defined in UR Z11.

**Source of Proposed Requirements:**

The proposed requirements were developed by WP/SRC Members, through correspondence and their meeting, identifying the requirements contained in Z 10.1 for Oil/Ore Carriers and incorporating them into UR Z10.2.

**Points of Discussion:**

WP/SRC did not unanimously agreed to either of two draft UR's submitted with this document.(Z102.doc and Z102strict.doc)

**Unresolved Comments:**

WP/SRC agree to the changes in 4.2.1.1 and 4.2.2.5 with the exception of the requirement for close-up survey of Web Frame Rings in Ballast Wing Tanks for vessels  $\geq$  15 years of age.

Seven of the Members agreed to require that All Web Frame Rings in All Ballast Wing Tanks should be close-up surveyed.

Three of the Members did not agree, but did agree to require All Web Frame Rings in One (1) Ballast Wing Tank and One (1) Web Frame Wing in all remaining Ballast Wing Tanks be close-up surveyed.

**Discussions:**

The Members that did agree to require that All Web Frame Rings in All Ballast Wing Tanks should be close-up surveyed, based the decision to remain consistent with the principal adopted in Z10.1 for Oil Tankers and Oil/Ore Carriers. LR and DNV were vocal in their opposition to the less strict requirements supported by BV, RINA, and KR.

The Chairman requested reasons for the opposition to the stricter requirements from the three Members for inclusion in this document and are as follows:

BV - When the ships in caption have 5 ballast tanks each side that means in that case they have 10 ballast tanks in total + peaks. considering 4 web rings per tanks gives in 40 web rings. If the ship's depth is 18 m and tanks' breath 10 m the developed length of a web ring is 56 m considering the 40 web rings we will have to close-up examine  $56 \times 40 = 2240m$ . considering the scaffoldings to be erected, the physical condition requested to the attending Surveyor(s) and the other items to be inspected, it will be simply impossible to comply with the requirements ( which will correspond more or less to a Special Survey) during an intermediate survey. Unless we reduce the class term to 3 years, I do not agree with the proposals.

RINA - RINA is of the opinion that requiring the close-up survey of all web frame rings in all ballast tanks (wing tanks + peak tanks) at the intermediate survey of ore carriers of 15 years of age and over is excessive and not reasonable as the assessment of these tanks can be achieved likewise through the overall survey in all of them and the close-up survey of "ALL web frame rings in ONE ballast wing tank and ONE web frame ring in EACH REMAINING ballast wing tank" and, in any case, should the condition of the web frame rings inspected be found not satisfactory, the survey will have to be extended to other rings in the same tank, as suggested in my message of 15 April. This less strict scope of survey would allow intermediate survey to be feasible and compatible with the commercial

operations of ships (in fact these surveys are usually carried out either during loading and unloading phases or at the end of them and require extensive scaffolding to be erected or rafting to be carried out). In addition, experience in performing intermediate surveys of ore/oil carriers for which the same stricter requirements have already been implemented has proved how it is difficult for a surveyor to have these spaces adequately prepared for this kind of inspection. Thus we do not like to extend the same problem to other kinds of ships and, rather, would like to amend the corresponding requirements related to ore/oil carriers accordingly, although it is recognized that this proposal could be difficult to achieve. Anyhow, even if the majority decides to submit the original text to GPG, we are prepared to maintain our position.

KR - The requirements of close-up survey of "all web frame rings in all salt water wing ballast tanks" at intermediate survey for ships older than 15 years is considered too heavy because all transverse webs in each ballast tank were close-up surveyed already at special survey No.3 as indicated in table 1 of existing UR Z10.2.

---

Note of IACS Permanent Secretariat (Date: 19 July 2000)

1. Numbering of the paragraph 4.2 of Z10.2 was re-arranged due to introduction of the requirements addressing ExCM FUA 2-2 "enhancement of intermediate survey to the preceding special survey for ships over 15 years of age.
2. The WP/SRC's proposed change to the para. 4.2.2.5 (now it stands as para. 4.2.3.1.b)) invited diverging views among GPG Members. However, it was found at GPG 48 meeting in March 2000 that the ExCM decision relating to enhancement of intermediate survey should be taken into account and as a result an urgent task was given to WP/SRC Chairman during GPG 48 to re-draft this paragraph.  
(The para. 4.2.2.5 (now 4.2.3.1.b): the extent of close-up survey of ballast tanks at intermediate survey in ore carriers over 15 years of age.)
3. WP/SRC Chairman put forward a re-draft of this requirement in April 2000.
4. GPG Chairman announced unanimous agreement on 14 August 2000 (0065alGd, 14/8/00).

**Technical Background Document**  
**WP/SRC Task 62**  
**UR Z10.2 – Proposed Draft Revision 10**  
(submitted by WP/SRC Chair on 10 June 2000)

**Objective and Scope:**

Revise UR Z10.2 detailing how intermediate surveys are to be applied annually to the foremost cargo holds of ships subject to SOLAS XII/9.1. Also, draft comparable amendments to A.744(18) for consideration by GPG with a view to their submission to IMO.

**Source of Proposed Requirements:**

The proposed requirements were developed by WP/SRC members through correspondence and their meeting by incorporating the requirements of SOLAS XII/9.1 into UR Z10.2 and A.744(18).

**Points of Discussion:**

WP/SRC unanimously agreed to the draft UR.

(Note: After adoption of Z10.2 (Rev.10), amendment was made to it in order to avoid conflict between WP/SRC Task 62 and ExCM decision to extend the scope of intermediate survey of older bulkers to that of special survey. See the Rev. 10.1 of Z 10.2 (3 October 2000, note by the Permsec))

## Technical Background Document

### UR Z10.2 – Revision 10.1 For WP/SRC Task No. 62

#### Objective and Scope:

Revise UR Z10.2 (Rev.10) to keep the original intention that for the foremost cargo hold of the ships subject to SOLAS XII/9.1, intermediate surveys shall apply.

#### Source of Proposed Requirements:

- The outcome of WP/SRC Task 62.

#### Points of Discussion:

The consequence of Council's decision to extend the scope of intermediate surveys of older bulkers to that of special survey has the effect of making the annual survey required by 3.2.1.2 be a special survey (i.e. a full special hull survey every year for bulk carriers subject to SOLAS XII/9.1).

See the note 5, para. 3.3 and new Annex IV.

#### Unresolved Comments:

-

#### Discussions:

-----

Submitted by the Permsec  
On 3 Oct 2000

**Technical Background Document**  
**WP/SRC Task 77**  
**UR Z7 – Proposed Draft Revision 7**  
**(Including Rev.8 of Z10.1, Rev.11 of Z10.2, Rev.4 of Z10.3)**

**Objective and Scope:**

Extend the requirements for permanent repairs at the time of survey in UR Z 10.2 to all ships.

**Source of Proposed Requirements:**

The proposed requirements were developed by WP/SRC members through correspondence and discussions at the September 2000 meeting.

**Points of Discussion:**

UR Z7 was amended to apply “prompt and thorough” repairs to all vessels. The new wording defines a prompt and thorough repair to be a repair as a result of wastage and not an incident such as contact damage where a temporary repair or deferral of repairs could be permitted. This wording is more explicit than the wording in UR Z10.2 and should achieve a uniform application among the Members.

WP/SRC also agreed to include these requirements in Z10.1, Z10.2 and Z10.3 in order to not effect A.744(18).

WP/SRC unanimously agreed to the draft UR.

Note by Permsec

GPG 49 (11-13 Oct. 2000) agreed that the same changes be introduced to Z10's and carried out editorial review of Z 10's.

## Technical Background for

**Rev.8.1, Z10.1**

**Rev.11.1, Z10.2**

**Rev.4.1, Z10.3**

(21 June 2001)

### 1. Scope of objectives

Revise section 2.3.1 for clarity.

### 2. Points of discussions or possible discussions

- BV GPG member proposed to revise section 2.3.1 of Z10s on 12 June 2001 (0065j)
- IACS Council considered the ambiguity of the sentence in Special Survey section 2.3.1 "For Fuel Oil Tanks the necessity for the Overall Survey is to be determined based on the ship's age" in the context of its application at intermediate surveys on ships over 15 years. Council agreed that the overall survey of low corrosion risk tanks such as fuel oil, lube oil and fresh water tanks could be subject to special consideration as already addressed in section 2.2.5 of UR Z7 and therefore amended the first sentence of 2.3.1, accordingly, and deleted the last sentence of 2.3.1.
- Adopted on 21 June 2001.

\* \* \* \* \*



**Technical Background Document**  
**WP/SRC Task 87**  
**Amend Z10.1&10.2 to reflect changes introduced to Res A.744 by MSC 73**  
**(Z10.1, Rev.9) + (Z10.2, Rev.12) + (Z10.3, Rev.5)**

**Objective and Scope:**

To harmonise IACS UR Z10.1 and Z10.2 with IMO Res A744(18), as previously amended and as amended by IMO MSC105(73) and MSC 108(73).

These amendments enter into force 1 July 2002.

It was assumed by WP/SRC that the intention of GPG has been to revise UR Z10.3 (chemical tankers) as well with respect to the intermediate dry-docking requirement, but not to include the requirement to evaluation of longitudinal strength.

In addition, the relevant changes to UR Z10.1 based on the changes introduced in IMO Res A744(18) as reported in MSC 74/24/Add1-Annex 17 have been included. These were based on IACS submission DE 44/13/1. These amendments will enter into force 1 January 2004 subject to IMO tacit acceptance procedures.

**POINTS OF DISCUSSION:**

The Chairman of WP/SRC would further draw GPG's attention to paragraph 4.2.4.3, which contains the requirement to intermediate dry-docking for oil tankers exceeding 15 years of age. The corresponding Res.A 744(18) requirement (paragraph 2.2.2) does not link the dry-docking to the intermediate survey. This issue was discussed extensively by correspondence and during three WP meetings this year. A consensus decision was achieved without reservations from any members. This process was time consuming, hence the delay in submitting this document to GPG for approval. However, at the annual meeting of the WP in October 2001 all members agreed that we should not accept the wording of Res. A 744(18) paragraph 2.2.2, but instead require that the intermediate dry-docking is to be linked to the intermediate survey and include a requirement to carry out surveys and thickness measurements of the lower portions of the tanks for oil tankers. (similarly, cargo holds/water ballast tanks for bulk carriers)

GPG is advised to note that the proposed requirement in paragraph 4.2.4.3 may result in a third dry-docking within the 5-year period of the classification certificate in case that a dry-docking is carried out prior to the window for intermediate survey.

The Chairman of WP/SRC suggests that GPG approves UR Z10.1 with high priority and allows PermSec in the meantime to start the work to amend and typeset UR Z10.2 and URZ10.3 with respect to the intermediate dry-docking requirement, as well as introducing the appropriate changes to UR Z10.2 and UR Z10.3 with respect to MSC 74/24/Add 1-Annex 17.

Note:

1. GPG tasked WP/SRC to review dry-docking survey requirements in Z10.2-4 and Z3 to harmonize them with those in Z10.1 (Rev.9) and reflect in Z3 the interim application of bottom survey requirements as introduced in MSC/Circ. 1013 (Res A.746(18)).  
Task 101, Target 2Q-2002
2. GPG confirmed (s/n 1060c) that 7.1.3 of A.744(MSC 74/12/Add.1/Annex 17/page 6), as quoted below, should not be included in Z10s.  
“7.1.3 Thickness measurements are to be carried out within 12 months prior to completion of the periodical survey or of the intermediate survey.”  
**Reason:** The above sentence will restrict the 15 month and 18 month survey window for TM during the intermediate and special surveys respectively.
3. GPG confirmed that 7.1.4 of A.744(MSC 74/12/Add.1/Annex 17/page 6), as quoted below, should not be included in Z10s:  
“7.1.4 In all cases the extend of the thickness measurements should be sufficient as to represent the actual average condition.”  
**Reason:** No compelling need, in view of MSC 74/12/Add.1 being adopted by MSC 75(May 02). IACS will live with this not harmonized sentence.
4. For IACS Council decisions to improve bulk carrier safety, see the TB for Revision 12 of Z10.2.

Submitted by WP/SRC Chairman

## **UR Z10.1(Rev.11) and Z10.2(Rev.14)**

**(July 2003)**

### **Technical background**

#### **Part A: Survey Reporting Principles**

##### **1. Objective**

WP/SRC Task 80 – Survey Reporting Principles

##### **2. Points of discussion**

The WP/SRC carried out this task according to the work specification of Form A (Rev.1) and reported the outcome on 18 December 2002 as follows:

- Review of NMD's report on "Sinking of Leros Strength", dated 6 July 2000 and the recommendations in section 5.3
- Review of IACS Council's reply, dated 22 August 2000 to those recommendations
- For recommendations 1.1, 1.2, 1.3 ,3, 4.2, 5 and 6, best practices have been identified by information exchange amongst Members and discussions at three WP-meetings.
- Harmonised survey reporting practices fulfilling, in so far as practicable, the recommendations of NMD have been included in the revised tables attached.
- Standard survey reporting terminology (recommendation 2) is in the process of being prepared and will be submitted to GPG for approval as an IACS Recommendation with the title "Surveyor's Glossary". The completion of the glossary has been delayed somewhat due to pending illustrations of typical hull structures.

Council approved on 14 July 2003 (2249\_).

\*\*\*

## **Part B: Incorporation of CAS related requirements into UR Z10s**

### **2. Objective**

WP/SRC Task 106 – Incorporation of CAS related requirements into A.744

### **2. Points of discussion**

The WP/SRC carried out this task according to the work specification of Form A and reported the outcome on 27 May 2003.

- Since CAS was developed for tankers only, WP/SRC considered whether there is any need to further develop/modify requirements in CAS with respect to bulk carriers. Hence, amendments to Z10.15.5.5(rafting), 5.6(survey planning), 8.2.2(different survey stations) and Table 1(close-up survey).
  - IACS will submit its proposed amendments to Res A.744 as a result of this revision.
  - NK GPG suggested that the word “alone” be inserted after “rafting” in Z7 and Z10.1(5.5.5)~10.5.
    - WP/SRC had considered this and felt that the insertion of the word "alone" will create a loophole as the text "Rafting alone will only be allowed..." could be interpreted that other means of access have to be used. Besides this wording would impede the use of rafting for survey of side and bottom structures of the spaces.
    - GPG considered that rafts/boats should be accepted as a means to move about within a tank to gain access to any temporary platforms that may be erected. Consequently, the wording of 5.5.5 was re-drafted and split into three parts (5.5.5~5.5.7) beginning with “Rafts or boats alone may be allowed for inspection of the under deck areas...”
- The same wording will be introduced into Z10.3, Z10.4, Z10.5, Z7 and Z7.1.

Approved on 08/08/2003 (0237h)

\*\*\*

Prepared by the Permanent Secretariat

22 July 2003

## Technical Background

UR Z10.2 (Rev.15, Dec 2003)

### 1. Objective :

Develop criteria for the extent and methodology of thickness measurements of frames of single side skin bulk carriers so as to ensure that UR S31 and UR Z10.2 include consistent, accurate and sufficient requirements.

### 2. **WP/SRC Task 111**

WP/SRC Task 111 completed on 10 Nov 2003 with new report form on Thickness Measurements of Cargo Hold Frames.

In addition, WP/SRC proposed the following changes:

1) to enhance the close-up survey requirements of the shell frames at Special Survey No.3 to include all shell frames in the forward and one other selected cargo hold and 50 % of frames in each of the remaining cargo holds. GPG agreed.

2) ships which are required to comply with UR S31 are subject to the additional thickness measurement guidelines for the gauging of side shell frames and brackets as given in the proposed new Annex V. GPG agreed.

### 3. **GPG Discussion**

GPG agreed to the following further changes:

1) Annex V, item 3.1: further modified to indicate that the 5 deepest pits within the cleaned area be gauged and the minimum thickness found recorded;

2) WP/SRC's proposed paragraphs relevant to face plates in both items 4.1 and 4.2 of Annex V were deleted;

3) Gauging method on flange and shell plating for bending check was newly introduced as item 4.3 of Annex V.

\*\*\*

**WP/SRC Task 102**  
**HARMONIZATION OF UR Z7s AND Z10s**

**Technical Background**

**UR Z7 (Rev. 11)**

**UR Z7.1 (Rev. 2)**

**UR Z10.1 (Rev. 12)**

**UR Z10.2 (Rev. 17)**

**UR Z10.3 (Rev. 7)**

**UR Z10.4 (Rev. 2)**

**UR Z10.5 (Rev. 1)**

Contents:

TB for Harmonization

**Annex 1.** TB for UR **Z10.1(Rev.12**, C49 amendments(coating-related))

**Appendix 1:** Memo for Coating, submitted to Council  
49(June 2004).

**Appendix 2:** DNV proposal (25 May 2005) agreed by Council

**Annex 2.** TB for "Verification/Signature of TM Forms" for records.

**Annex 3.** TB for revision of UR Zs concerning "anodes".

**1. Objective**

To amend UR Z7s and Z10s in order to make the texts of the above-mentioned URs consistent eliminating all the differences both in substance and in wording (WP/SRC Task 102).

**2. Background**

In the process of approving UR Z10.4, GPG found it necessary to amend the other existing URs Z10.1, Z10.2, Z10.3, Z10.6 and Z7 in order to eliminate any inconsistencies existing among them.

**3. Methodology of work**

The WP has progressed its work through many sessions, both during the periodical meetings and dedicated meetings restricted to a Small Group of Members (BV, DNV, GL, LR, RINA) who developed the work in order to be more efficient. All the proposed amendments of the Small Group have regularly been circulated to all Members for comment and agreement.

## 4. Discussion

4.1 The WP/SRC has completed a comprehensive comparative review of UR Z7 and Z10s, and identified inconsistencies which existed among them. During this review, attention was given to the severity of the requirements applicable to the same spaces/structural areas on different types of ESP ships. As a result, the inconsistencies were eliminated making the URZs harmonized. However, there has been no change to the scope and extent of the survey requirements.

4.2 The starting point for each UR was the most updated version available at the time of commencement. Any revision to the URZs, which were introduced during this task, was taken into account. As for instance, the UR Z10.1 was initially amended based on Rev. 9, while the last amendments are based on Rev. 11 and the UR Z10.2 was initially amended based on Rev. 13, while the last amendments are based on Rev. 16. The proposed revisions of URs Z10.1 and Z10.4 have not been numbered, as there will be revisions to those URs before the revisions introduced by the Task 102 are adopted. In fact, GPG is currently developing a Revision 12 of Z10.1 with the view to introducing significant improvements in the survey regime for ballast tanks (including combined cargo/ballast tanks) of oil tankers and UR Z10s applicable to oil tankers will also have to be revised by incorporating the amendments to A.744(18) contained in Resolution MSC 144(77), which enter into force 1 January 2005 (see 4.3 below).

4.3 Also, in harmonizing UR Z10.1 and Z10.2 care has been taken to align the corresponding text with that of IMO Res. A.744(18). However, it has been noted that the amendments to A.744(18) contained in Resolution MSC 144(77), which enter into force 1 January 2005, have not been incorporated into the IACS UR Z10s applicable to oil tankers. It seems that the updating of the above-said UR Z10s will be done by the Perm Sec and reviewed by the WP/SRC Chairman and then circulated for adoption by GPG with concurrence of Council Members for uniform application from 1 January 2005. It is understood that the revisions of the UR Z10s affected by those amendments will not include the changes introduced by the Task 102, as the implementation date proposed for those changes is 1 January 2006 (see below **6. Implementation**).

4.4 In the course of the work the WP has been developing for more than two years, several additional Tasks were assigned to the WP by GPG which affected the development of Task 102. The additional tasks which have been taken into account are the following:

- 1) In the course of Council discussion on UR Z10.6 (General Cargo Ships), certain inconsistencies were identified between Z10.6 and other Z10s. WP was instructed to expedite Task 102 (1060gIAa, 12 June 2002);
- 2) WP was instructed to include "Survey Planning for Intermediate Survey" into harmonization work (2108\_IAa, 12 July 2002);
- 3) GPG instructed WP to consider whether Z10.6 should be re-assigned as Z7.1, in connection with the harmonization work. 1060gIAb, 20 Sept 2002.

- Z7.1 developed;
- 4) Partial outcome (Z7 and Z7.1) was submitted to GPG on 17 July 2003(1060g). Council decided that approval of Z7(Rev.10) and Z7.1(Rev.2) is postponed until the harmonization is completed (1060gICb, 6 April 2004);  
[Council Chairman instructed WP/SRC to Members' comments on the draft revision of UR Z7 and Z7.1 \(collected under s/n 1060g, 1060gNKi \(30/03/2004\) in particular\) on 6 April 2004.](#)
  - 5) GPG tasked WP to include the amendments to Z10.2 / Z11 (BCs with hybrid cargo hold arrangements), deleting sheets 15 and 16 for ore carriers, into the harmonized UR Z10s (2212aIGa, 19 Jan 2004);
  - 6) GPG tasked WP to consider whether the requirements relevant to examination of Fuel Oil Tanks in the cargo area at each Special Survey should be put into Z10s, and internal examination of FOT at Intermediate Survey after SS 2 is needed. (1060gIAf, 30 Jan 2004);
  - 7) GPG tasked WP to harmonize tank testing requirements in Z7s and Z10s. (3006IIAa, 5 April 2004);
  - 8) GPG tasked WP with Task 108 - Develop uniform survey requirements for air vent pipes including the welded connection to deck. Z22 developed. GPG instructed WP to incorporate Z22 into the harmonized Z10s;
  - 9) GPG tasked WP with Task 114 - Verification and signature of TM reports. REC 77(Rev.1) developed and approved on 29 July 2004. Council approved parallel amendments to Z7.1 and Z10s (TM Forms included) and instructed WP to incorporate these into the harmonized Z10s:
    - [Recommendation No.77 was revised \(Rev.1, July 2004\);](#)
    - [Z7.1 para.6.3.2 and Z10s para.7.3.2 so amended.](#)
    - ["Surveyor's signature" is deleted from all TM Forms in Z10s;](#)
    - [A note is added to Annex II\(Z10s\) declaring that Annex II is recommendatory.](#)

WP/SRC's investigation into Members' practice in dealing with verification and signature of TM reports is annexed for record keeping purpose. [See Annex 2.](#)
  - 10) GPG tasked WP to consider the BV comments on "TM may be dispensed with..." and include the findings into the harmonized Z10s ( 2219iIAa, 7 April 2004).

## **5. Agreement within the WP/SRC**

All Members have unanimously agreed the attached final versions of UR's.

## **6. Implementation**

WP/SRC is of the view that the Members need 12 months from the adoption date to implement these amendments into their class rules. Assuming Council adoption in December 2004, WP/SRC would propose January 2006 as implementation date.



- Annex 1:** TB for UR Z10.1(Rev.12, C49 amendments, see Permsec's note 1 below)  
**Annex 2:** WP/SRC Task 114, verification and signature of TM reports(see 9 above).  
**Annex 3:** TB for revision of UR Zs concerning "anodes".

### Note by the Permanent Secretariat

1. Annex 1 to this TB contains background for amendments to UR Z 10.1(Rev.12) relating to FAIR/POOR/GOOD (C49 amendments). Council at its 49<sup>th</sup> meeting (June 2004) agreed/decided that comparable changes should be added to Z10.3 and Z10.4.

2. Appendix 3 "TM sampling method" has been added to UR Z10.1 and Z10.4 to keep them consistent with IMO Res.MSC.144(77). The amendments to A.744 contained in MSC.144(77) entered into force on 1 January 2005. (*GPG s/n 4181*)

Under s/n 4072g, paragraph **2.4.6** of UR Z10.1 and **2.4.6** and of UR Z10.4 (paragraph numbering is now harmonized) were amended in order to provide a link between the main text of the UR Z10.1 and 10.4 and the new Annex III Appendix 3 containing the MSC Res.144(77).

Further, it was agreed that the requirements for evaluation of longitudinal strength of the hull girder (as written in MSC.144(77)) should not be required for Intermediate Survey unless deemed necessary by the attending Surveyor. This is covered in 4.2.3.1 and 4.2.4.1 of Z10.1 and Z10.4.

3. GPG agreed that the amended UR Zs should be implemented from 1 July 2006 altogether.

4. DNV's proposed amendments to UR Z10.1, Z10.3 and Z10.4 concerning annual survey of ballast tanks were agreed by Council (1060gICq, 27 June 2005). See Appendix 2 to Annex 1.

5. Annex 3 contains a TB for revision of UR Zs concerning "anodes".

Date: September 2004  
Prepared by the WP/SRC

-- --

## **Annex 1 to Technical Background**

### **UR Z 10.1 (Rev.12, C49 amendments(coating-related))**

#### **1. Objective**

To introduce significant improvements in the survey regime for ballast tanks (including combined/ballast tanks) of oil tankers as matter of strategic concern and urgency to IACS, given the aging of both the single and double hull tanker fleets and the problems encountered with corrosion of ballast tanks in several shipping casualties.

#### **2. Background**

Draft amendments to UR Z10.1 were submitted to Council 47 (June 2003) and agreed in principle.

#### **3. Discussion**

There was particular concern over accelerated corrosion with age (as the thinner the material, the more rapidly the allowable diminution margin percentage disappears) especially where coatings have broken down. There is also a disincentive for any spend on maintenance of the structure of a ship within a few years of its statutory scrapping date.

Council discussion by correspondence had evolved to the position of substantive proposals – summed as follows (3095\_ABa, 2 June 2003):

1. Enhance the Intermediate Survey in Z10.1, Z10.3 and 10.4 for Tankers after 2<sup>nd</sup> Special / Renewal Survey to the same level (scope of work) as the preceding Special / Renewal Survey). This corresponds to the latest revision to UR Z10.2.
2. At Annual Survey of ballast tanks with substantial corrosion, the overall survey is to be replaced by close-up survey with thickness measurements of the exposed area.
3. Proposed to task WP/SRC to re-consider the acceptance criteria for the rating FAIR further. For this, eliminate FAIR, leaving only GOOD and POOR redefined as appropriate.
4. Proposed to task WP/SRC to explicitly require close-up survey of Suspect Areas identified at the previous Special Survey.

Council 47 discussed the proposals(June 2003) as follows:

##### **1. Definition of FAIR**

Council 47 agreed that “FAIR” would be retained as a rating and that GPG should instruct WP/SRC to redefine FAIR, so that there would be a clear differences between FAIR, POOR and GOOD. It was also agreed that for oil tankers the Intermediate Survey following Special Survey No.2 would have the same scope as Special Survey No.2(Z10.1). WP/SRC should also clarify the definition of satisfactory repair.

Based on the strong majority, Council agreed to discuss with Industry annual surveys of ballast tanks when coating is found in LESS than GOOD condition at special survey, with the objective to encourage the owner to carry out repairs and maintenance of coating to GOOD condition.

*DNV and NK stated that they could not accept a requirement for annual surveys of ballast tanks when the coating condition is less*

*than GOOD and proposed that GOOD be changed to FAIR (3095\_IGc, 30 June 2003)*

2. ABS' proposed amendments to Z10.1(annual examination of BWTs in certain conditions) were approved.
3. C 47 agreed that the BWT coating requirements (Z10.1.2.2.3) for intermediate Survey after SS 2 should be the same extent to the previous SS.
4. Given the substance of the changes, the revised Z10.1 should be shown to Industry before adoption.
5. A guidance for coating repairs needs to be developed by WP/SRC with reference to TSCF Guidelines.

Following Council 47, the draft text of Z10.1(Rev.12) was distributed to Industry and discussed at the IACS/Industry meeting on 29 August 2003. Industry indicated that UR Z10.1(Rev.12) is acceptable, provided that appropriate IACS guidelines on coating repairs are developed.

The Small Group on Coating (SG/Coating) under WP/SRC prepared draft guidelines on coating repairs and considered the definitions of GOOD / FAIR / POOR. The SG/Coating did not change the definitions and found that the Guidelines provide useful clarifications on the definitions and criteria in achieving an industry wide uniform judgement of coating conditions as well as what is needed to restore GOOD conditions.

Further, an IACS/Industry JWG/Corrosion was established and met in February 2004. The outcome is (3095\_IGh, 4 June 2004):

- Draft Guidelines on Coating Repair (IACS REC 87)
- Draft UR Zxx (mandatory coating of cargo tanks on oil tankers)
- Draft UI SC 122 (Rev.2) – mandatory coating of ballast tanks

#### **4. Others**

1. Z10.11.2.2bis - Definition of “Combined Cargo/Ballast Tank. ...as a routine part of the vessel's operation and will be treated as a Ballast Tank. ...”. By so amending, Z10s do not need to repeat “Ballast Tanks and Combined cargo/salt water Ballast Tanks” in addressing the ballast tanks. Hence, all the references to “and Combined cargo/salt water Ballast Tanks” were deleted.
2. Z10.1.2.2.1.2: The aim of the examination is to be sufficient to discover substantial corrosion...  
Comparable changes are to be added to other UR Zs wherever the same sentence occurs.
3. “IACS Guidelines for Coating Maintenance & Repairs for Ballast Tanks and Combined/Ballast tanks on Oil Tankers” are referenced where relevant.
4. Comparable changes are to be added to UR Z10.3 and Z10.4, after adoption of Z10.1(Rev.12).

**Attached: Memo on Coating Matters (GPG Chairman)**

9 June 2004  
Prepared by the Permsec

## **Appendix 1 to Annex 1:**

## **MEMO on Coating matters**

### **1. Background and discussion within IACS on UR Z10.1 (draft Rev.12) between 29/01/03 and 14/08/03**

In view of the survey experience with oil tankers, it was proposed that all ballast tanks should be examined, routinely and uniformly, at annual surveys on ESP tankers exceeding 15 years of age. IACS should amend UR Z10.1 to require the examination of ballast tanks on such ships at each annual survey. This is simple, clear and thorough and not subject to interpretation. (2242\_ABq dated 29/1/03)

Then, ABS modified the proposal asking, for tankers subject to URs Z10.1, Z10.3 and Z10.4, exceeding 15 years of age, that the current requirement - pertaining to annual examination of Ballast Tanks adjacent to cargo tanks with any means of heating - be deleted and replaced by a simpler and more stringent requirement that all Ballast Tanks be subject to survey at each subsequent annual survey where either substantial corrosion is found within the tank or the protective coating is found to be in less than GOOD condition and the protective coating is not renewed at special survey or intermediate survey. This will ensure that all Ballast Tanks with substantial corrosion or protective coating which is not in GOOD condition at the time of special survey or intermediate survey will be examined at each subsequent annual survey on tankers exceeding 15 years of age. (2242\_ABzb dated 14/3/03)

This was later expanded to include all tanks used routinely for ballast water, both ballast-only and cargo/ballast tanks (2242\_ABzc dated 14/3/03).

ABS further reviewed the issue of the survey of salt water ballast spaces and combined cargo/salt water ballast spaces with ABS' governing bodies in light of recent casualties and survey findings on other tankers. Their review found an increasing amount of coating breakdown/failure and subsequent rapid wastage in key structures after Special Survey No. 2, i.e. after 10 years of age. These conditions are most prevalent in the under deck structure and the side shell structure in way of the deep loadline. In a number of cases the serious wastage has caused fracturing of the under deck longitudinals and in some cases fracturing has extended to the main deck structure. This led ABS to refine proposed amendments to URs Z10.1, Z10.3 and Z10.4 to require (2242\_ABzf dated 9/5/03):

#### a. For Tankers exceeding 10 years of age

Salt Water Ballast Spaces and Combined Cargo/Salt Water Ballast Spaces. For tankers exceeding 10 years of age, salt water ballast spaces and combined cargo/salt water ballast spaces are to be internally examined at each subsequent Annual Survey where substantial corrosion is found within the tank or where the protective coating is found to be less than GOOD condition and protective coating is not repaired. Internal examination to be an Overall Survey.

#### b. For Tankers exceeding 15 years of age:

Salt Water Ballast Spaces and Combined Cargo/Ballast Spaces. For tankers exceeding 15 years of age, salt water ballast spaces and combined cargo/ballast spaces are to be examined internally at each subsequent Annual Survey. Where substantial corrosion is found within the tank, or where the protective coating is found to be in less than GOOD condition and the protective coating is not repaired then in addition to an Overall Survey, under deck structure and the side shell structure in way of the deep loadline is to be subject to Close-up Survey.

NK and BV replied that the proposed amendments made by ABS need to be substantiated in a transparent manner with technical data that ABS may possess and put forward for further assessment and discussion. (2242\_NK<sub>n</sub> dated 14/5/03 and 2242\_BV<sub>z</sub> dated 16/5/03)

**DNV** (2242\_NV<sub>n</sub> dated 2/6/03), having carefully considered the practical consequences of taking the ship off-hire for gas freeing etc. and being concerned about the difficulties to have these surveys executed in a safe manner and whether the intended safety benefits in implementing the proposed extended scope of the annual survey of Ballast tanks will be met, **proposed the following alternative measures** which would be as effective and may not have such delaying effects to the ship:

- 1) Enhance the Intermediate Survey in UR Z10.1, 10.3, and 10.4 for Tankers after the 2 Special / Renewal Survey to the same level (scope of work) as the preceding Special / Renewal Survey. (This will correspond to the latest revised requirements of UR Z10.2 for Bulk Carriers.)
- 2) At Annual Survey of ballast tanks with substantial corrosion the overall survey should be replaced by close up survey with thickness measurements of the exposed area. (An overall survey of these tanks does not give sufficient information of the development of the areas with substantial corrosion.)
- 3) Further we will not fail to mention that the WP/SRC has proposed to extend the close up survey in cargo and combination tanks to 30% from the 3 Special / Renewal Surveys.
- 4) **Experience has shown that the coating condition rating category FAIR has a tendency to be stretched too far into the POOR condition. We will therefore propose that we task the WP/SRC to reconsider the acceptance criteria for the rating FAIR further.**
- 5) We do also question the need for redefining the definition of combination tanks, particularly since the category I tankers which are the ships that normally are fitted with these type of tanks are to be phased out 2 to 4 years from now. However DNV will not oppose to such a redefinition.

**DNV requested Members to consider the above as an alternative to the ABS proposal, bearing in mind that we ought to present this to the industry prior to deciding.**

ABS (3095\_Aba dated 2/6/03), having further considered its earlier proposals in light of NV<sub>n</sub>, submitted a revised proposal for consideration by Council at C47 and replied to the above 5 DNV proposals as follows:

- 1) ABS fully supports this proposal.
- 2) While ABS agrees with this proposal, it is in fact already provided for in Z7 (3.2.3) and Z10.1 (3.2.5.1)--which require that "Suspect areas (which include any area where substantial corrosion is found) identified at previous Special Survey are to be examined. Areas of substantial corrosion identified at previous special or intermediate survey are to have thickness measurements taken." To us, this implies that close-up survey of these areas is to be done at annual survey in conjunction with the thickness measurements. However, we can

agree to tasking WP/SRC to explicitly require "close-up" survey in this connection and to amend Z7, and all the Z10's, appropriately to make this explicit, if there is majority support for this.

3) We agree that this has been put forward to GPG by WP/SRC via 0237hNVb, 27 May. However, these additional CAS close-up survey requirements do not apply to salt water ballast tanks; only to cargo oil tanks and combined cargo/ballast tanks.

4) **We agree with this assessment and we propose that the only way to eliminate the subjectivity and raise the standard is to eliminate the category "FAIR" completely; leaving only "GOOD" and "POOR" redefined as follows:**

**"GOOD -- condition with no breakdown or rusting or only minor spot rusting.**

**POOR -- any condition which is not GOOD condition."**

5) ABS does not agree with this proposal. We are particularly concerned that we need a very thorough and robust survey regime for these tankers precisely because they are subject to mandatory phase out over the next several years. We are very concerned that without additional IACS requirements, these tanks will receive little or no inspection and maintenance by owners or others after their last special or intermediate survey, if no substantial corrosion is found at that time. Rapid, localized wastage in way of deteriorating coatings may pose significant hazard if the survey regime is not further tightened as we are proposing.

In conjunction with the above comments on DNV proposals, ABS further considered their previous proposal in ABzf and modified it as follows:

- **ABS simplified the proposal to require annual examination of all salt water Ballast Tanks and combined Cargo/salt water Ballast Tanks irrespective of age, when either substantial corrosion is found within the tank or the protective coating is found to be in less than GOOD condition and is not repaired.**
- the requirement for annual (close-up) examination of salt water ballast tanks and combined tanks is already required in Z10.1 (3.2.5.1). ABS proposed adding it to 2.2.3 for clarity and emphasis so that all the conditions which may lead to annual examination of such tanks are listed together in one place.
- Since the principal problem that we are trying to address is rapid, localized corrosion in way of breakdown or deterioration of the protective coating, we are proposing that the coating condition should be found and kept in "GOOD" condition to obviate the need for annual examination. **The attached proposal is made together with the proposals in items 3.1 (intermediate following Special survey 2 to have same scope as prior Special survey) and 3.4 (eliminating "FAIR" and redefining "POOR" as any condition other than "GOOD" condition.**

ABS requested to decide on a course of action at C47 for tightening the survey regime for tankers. They agreed that industry be informed of Council's decisions in this regard prior to IACS making the decision public, but IACS should maintain its independence and take decisive action in this matter. Debate with industry can only lead to delay and to a watering down and compromising of these important requirements.

NK agreed to task WP/SRC to reconsider the acceptance criteria of "FAIR" for clearly define the border between "FAIR" and "POOR" condition. However, **NK strongly opposed the elimination of "FAIR" coating condition from UR Zs** because this can not resolve to remove subjectivity of coating assessment. The three-categorization system of coating condition should be retained. (3095\_NKa dated 5/5/03)

## **Outcome of C47**

At C47, it was agreed that "Fair" would be retained as a rating and that GPG should instruct WP/SRC to redefine "Fair", so that there would be a clear differentiation between "Fair", "Poor" and "Good". It was also agreed that for oil tankers the Intermediate Survey following Special Survey No.2 would have same scope as Special Survey No.2 (Z10.1). WP/SRC should also clarify the definition of satisfactory repair.

Based on strong majority support Council agreed to discuss with Industry annual surveys of ballast tanks when coating is found in LESS than GOOD condition at special survey, with the objective to encourage the owner to carry out repairs and maintenance of coating to GOOD condition.

This matter should be discussed with Industry prior to adoption of any UR by Council.

In a final summary, the Chairman proposed that a constructive dialogue with Industry should take place on the IACS proposal as set out in WP1 plus maintaining 3.2.5.2 modified to say that ballast/combined ballast/cargo tanks will be subject to annual survey when considered necessary by surveyors.

After discussion in the JWG (Industry/IACS), GPG should propose final rules for this matter to Council, including acceptable repair definition.

**FUA 17:** *To instruct WP/SRC to develop guidance on coating repairs and more precise definition of "Fair" coating condition.*

Once approved, these requirements should be incorporated into Z10.3 and Z10.4.

### **FUA 15**

1) *To prepare a draft revision to UR Z10.1 incorporating C 47 decisions:*

- *The definition of "FAIR" remains as it is;*
- *ABS proposed amendments to Z10.1 (annual examination of BWTs in certain conditions) were approved;*
- *C47 agreed that the BWT coating requirements (Z10.1.2.2.3) for Intermediate Survey after Special Survey No.2 should be the same extent to the previous Special Survey.*
- *Given the substance of the changes, the revised UR Z10.1 should be shown to Industry (OCIMG/Intertanko first among others) before adoption for their review and comments.*
- *A guidance for coating repairs needs to be developed by WP/SRC with reference to TSCF Guidelines.*

2) *GPG Members are to confirm the draft revision to Z10.1 in consultation with their WP/SRC members by correspondence. See 3095\_IGa of 13/06/03.*

According to C47 FUA 15, GPG Chairman circulated (3095\_IGa dated 13/6/03) draft amendments to UR Z10.1 as agreed in principle at C47.

Having received a number on comments, GPG Chairman (3095\_IGb dated 27/6/03) informed that the Council Chairman confirmed that GPG is not to amend the principles agreed at C47, i.e. we are not empowered to change "GOOD" to "FAIR" as proposed by DNV and NK, nor to amend the definitions of "FAIR" and "POOR" as proposed by DNV.

DNV's intention to possibly lodge a reservation was noted, however the matter should be raised at Council and not be dealt with by GPG. An amended draft text incorporating the non-substantive changes proposed by Members was circulated.

DNV said that its understanding was that the draft should be circulated to the Industry (ICS, INTERTANKO, and BIMCO) prior to adoption by Council. (3095\_NVc dated 30/6/03)

GPG Chairman (3095\_IGc dated 30/6/03) circulated a draft amendment of UR Z10.1 for Council's agreement and use in discussions with the industry associations.

The draft was generally agreed by GPG but individual Members have requested that the following matters (which were deemed to be outside the remit of GPG in this task) be brought to Council's attention for further consideration:

- 1 DNV and NK stated that they can not accept a requirement for annual surveys of ballast tanks when the coating condition is less than GOOD and propose that GOOD be changed to FAIR.
- 2 In connection with item 1 above, DNV also propose to amend the definitions of FAIR and POOR in order to raise the standard of FAIR.

Council Chairman (3095\_ICb dated 14/8/03) concluded that Council has agreed that the draft amendments to UR Z10.1 attached to IGc reflect Councils' decision taken at C47 and that they be circulated to industry associations.

Perm Sec was therefore invited to submit the draft to OCIMF and INTERTANKO in view of discussion at the IACS/ industry meeting on 29 August.

## **2. Discussion with Industry (29/08/2003 – 11/10/2003)**

As requested by Council, the whole matter was presented to Industry during the “general matters” meeting with IACS held on 29 August 2003; comments from Industry were requested. In the following an extract from the minutes of the meeting (see message 3100aIAb dated 5 September 2003):

\_\_\_\_\_ from Meeting minutes \_\_\_\_\_

## **4. & 5. Annual surveys of ballast tanks and IACS guidelines on coating repairs**

M. Dogliani introduced the matter ([see Items 4&5 in Appendix](#)).

A. LinoCosta gave a presentation to show where concerns and decisions stand: too many cases when coating was considered fair at SS but problems occurred just after one/two years.

N. Mikelis commented on draft amendments to Z10.1 (Rev.11) stating that the extent of annual survey is not clear; it should be limited to the affected zones, e.g. coating breakdowns, only.

M. Guyader clarified that, in this draft amendments, it is expected an overall survey of the whole tank and a close up survey of the affected zones.

N. Mikelis noted that, in the draft amendments to Z10.1 (Rev.11), the intermediate survey at 12.5 years would have the same scope as the previous special survey and that needed a justification. See 7 a).

M. Dogliani said that Z10.1 (Rev.11) was adopted in August 2003 and will be introduced into IACS Societies' Rules over the next year.

### Conclusions:

4.1 Industry shared IACS concerns on coatings and, in general, agreed with the draft amendments to Z10.1 (Rev.11) suggesting also extending them to Z10.2 on bulk carriers



4.2 Industry agreed that a guideline for surveyor on coating would greatly improve uniform application of so-amended Z10.1 including issues such as how to consider load bearing elements when judging GOOD/FAIR/POOR status and how to consider bottom pitting in connection with GOOD conditions

4.3 Industry will more precisely comment, by the end of September, the draft Z10.1 so as for IACS to finalise the matter, as planned, for the Council's December meeting.

Item	Title	Industry recommendation	IACS/ M. Dogliani Introduction
4 & 5	Annual survey of ballast tanks IACS guidelines on coating repairs	NN	<p><b>1. IACS is considering the following:</b></p> <ul style="list-style-type: none"> <li>- <b>amend UR Z10.1 (draft circulated to Industry) to the effect that in case at Special Survey or Intermediate Survey the coating in a ballast tank is found less than GOOD, either GOOD conditions are restored or the tank's coating is inspected at each annual survey;</b></li> <li>- <b>develop IACS guideline to assist an uniform application of the so modified (if adopted) UR Z10.1; the guideline should address which repairs are necessary to restore GOOD conditions from FAIR and POOR respectively and which are the criteria for the restored (after repair) situation to be rated as GOOD.</b></li> </ul>

\_\_\_\_\_ End of extract from minutes \_\_\_\_\_

INTERTANKO commented (see R. Leslie email to GPG dated 25 September 2003):

- expressing their concern for the draft Z10.1 and underlining
  - a) targeting: concerns that, if not properly dealt with, Z10.1 would target all ships and not just those which need intervention; the view was expressed that guidelines would probably solve the matter;
  - b) definition: indicating that the current definitions of GOOD, FAIR and POOR is not clear enough and that the matter would be even worst with GOOD and NON GOOD; again it was indicated that guidelines could solve the matter;
  - c) expertise: expressing doubts on IACS' surveyors expertise and ability to judge coating conditions; in this respect they (hiddenly) suggest that IACS position is unclear when we say that we are not competent to judge the coating during construction but then we are competent to judge coating during operational life. Even if not explicitly stated, the impression is that also in this case guidelines would help.

Additionally, INTERTANKO suggested a (quite detailed) set of assessment criteria.

The matter was then finally addressed at the TRIPARTITE Meeting (held in Soul on 29/30 September 2003). There Industry agreed that the way forward was the (joint) development of IACS guidelines (see minutes attached to message 3100\_RIe dated 11 October 2003, an extract of which is reproduced below).

\_\_\_\_\_ Extract from the TRIPARTITE minutes \_\_\_\_\_

Industry is concerned by the definition of GOOD/NOT GOOD in relation to coating repairs and acceptance criteria. Industry agreed that new guideline on this, which IACS is already producing, was the way forward.

\_\_\_\_\_ End of the extract from the minutes \_\_\_\_\_

### **3. Further developments**

- a) from the above, it was concluded that, provided the guidelines are sound, Industry would accept the concept of Z10.1 (draft) Rev. 12, therefore an IACS team and a JWG were established in order to progress the matter of the guidelines (among other related matters).
- b) the team of IACS experts on coating developed draft guidelines and provided recommendations to GPG on the way forward (attached to message 3095bNVc dated 20 November 2003).
- c) the guidelines were discussed within the JWG with Industry (see draft minutes circulated within GPG with messages 3095cIGd and 3095cIGe both dated 13 March 2004)
- d) further suggestions and comments (as requested at the meeting) were provided by Industry (not circulated to GPG)
- e) Bulk Carrier Industry is recommending that similar guidelines are developed in due time also for bulk carriers
- f) at DE47 and MSC78, IMO is asking Industry and IACS to develop (compulsory) performance standards for coating of newbuilding (double hull spaces of DSS Bulk Carriers), a matter which is, indirectly related to the above one.

1 June 2004

M. Dogliani

IACS GPG Chairman

IACS JWG/COR Chairman

Appendix 2 to Annex 1: [DNV proposal to Z10.1, Z10.3 and z10.4](#) ▶

Sent Monday, July 4, 2005 4:45 pm

To [Gil-Yong <gilyonghan@iacs.org.uk>](mailto:Gil-Yong <gilyonghan@iacs.org.uk>)

Cc

Bcc

Subject Fw: 1060gNVs; WP/SRC - Task 102 - Harmonization of UR Z 7 and Z 7.1

Attachments [Doc1.doc](#)

25K

----- Original Message -----

From: "Debbie Fihosy" <[debbiefihosy@iacs.org.uk](mailto:debbiefihosy@iacs.org.uk)>

To: "CCS" <[iacs@ccs.org.cn](mailto:iacs@ccs.org.cn)>

Cc: "IACS Permanent Secretariat" <[permsec@iacs.org.uk](mailto:permsec@iacs.org.uk)>

Sent: Friday, June 03, 2005 2:52 PM

Subject: FW: 1060gNVs; WP/SRC - Task 102 - Harmonization of UR Z 7 and Z 7.1

Forwarding as requested

-----Original Message-----

From: Arve.Myklebust@dnv.com [[Arve.Myklebust@dnv.com](mailto:Arve.Myklebust@dnv.com)]

Sent: 25 May 2005 15:49

To: [AIACS@eagle.org](mailto:AIACS@eagle.org); [iacs@bureauveritas.com](mailto:iacs@bureauveritas.com); [iacs@ccs.org.cn](mailto:iacs@ccs.org.cn);

[johnderose@iacs.org.uk](mailto:johnderose@iacs.org.uk); [iacs@dnv.com](mailto:iacs@dnv.com); [iacs@gl-group.com](mailto:iacs@gl-group.com);

[gilyonghan@iacs.org.uk](mailto:gilyonghan@iacs.org.uk); [helenbutcher@iacs.org.uk](mailto:helenbutcher@iacs.org.uk); [efs@iacs.org.uk](mailto:efs@iacs.org.uk);

[krsiacs@krs.co.kr](mailto:krsiacs@krs.co.kr); [richardleslie@iacs.org.uk](mailto:richardleslie@iacs.org.uk); [external-rep@lr.org](mailto:external-rep@lr.org);

[clnkiacs@classnk.or.jp](mailto:clnkiacs@classnk.or.jp); [terryperkins@iacs.org.uk](mailto:terryperkins@iacs.org.uk); [iacs@rina.org](mailto:iacs@rina.org);

[iacs@rs-head.spb.ru](mailto:iacs@rs-head.spb.ru); [colinwright@iacs.org.uk](mailto:colinwright@iacs.org.uk)

Subject: FW: 1060gNVs; WP/SRC - Task 102 - Harmonization of UR Z 7 and Z 7.1

25 May 2005

To: Mr. B. Anne, Chairman of IACS Council,

cc: Council Members, IACS Perm. Sec.

Ref.: My mail NVr dated 20 May 2005

DNV have further studied the amendments to UR Z10.1, Z10.3, and Z10.4, and as a result are presenting the following as a compromise solution:

General comment:

From the comments by other Members it is obvious that there is reluctance to accept annual surveys of ballast tanks with a common plane boundary to heated cargo tanks in the case where the coating is in good condition. This is particularly unreasonable as at the same time we enhance the Intermediate survey of Tankers between 10 and 15 years to also include examination of all ballast tanks, meaning that all ballast tanks will be close up surveyed with 2-3 years intervals from the ship is 10 years old, with the possibility for the surveyor to require thickness measurements and testing of the tanks to ensure the structural integrity of the tanks if necessary.

It is also proposed for the Intermediate survey between 5 and 10 years, to increase the scope from representative to all ballast tanks, a requirement DNV find to strict, and require that we here keep the original text.

If a ballast tank is found to have coating in GOOD condition at the renewal or intermediate survey, a deterioration of the tank beyond structural reliability is very unlikely even if the tank has a common plane boundary to a heated cargo tank.

DNV finds it particularly unreasonable to have this requirement to apply to double hull tankers for the following reasons:

- these ships have double hull and the risk of pollution is here much reduced,
- the double hull is constructed with small spaces giving improved structural reliability,
- almost all double hull tankers below VLLC have heated cargo tanks, and all ballast tanks have common plane boundaries to these tanks, meaning that this requirement will apply to a major part of the tanker fleet in the future,
- the ballast tanks of double hull tankers are so designed that a general examination of these tanks will be identical to a close up survey,
- survey of ballast tanks of double hull tankers will mean either gas freeing of all cargo tanks or at least dropping the inert gas pressure of all cargo tanks in addition to proper airing of all ballast tanks.

Since the single hull tankers will be faced out in the near future, and for clear political reasons, DNV will as a compromise proposal to keep paragraph 2.2.3.1 and 4.2.2.2 in Z 10.1 as amended by Council (ref. IAo) but amend it to not include 2.2.3.1.e, 4.2.2.2.e and last paragraph of 3.2.5.1 in Z10.3 and Z10.4. In addition we request that the original text of 4.2.2.1 is kept.

If BV, ABS and other Members can accept this DNV is willing to drop our reservation presented at C49.

DNV's proposal will then be as follows:

Z10.1:

2.2.3.1: This paragraph can be accepted as is for the reasons stated above.

3.2.5.1: This paragraph is accepted as amended.

4.2.2.2: This paragraph can be accepted as is for reasons stated above.

For other comments to Z10.1 see NVo and NVp.

Z10.3:

2.2.3.1.e to be deleted.

3.2.5.1 delete last paragraph

4.2.2.1 the original text to be kept. "For tanks used for water ballast ---"

4.2.2.2.e to be deleted

Z10.4

2.2.3.1e to be deleted

3.2.5.1 delete last paragraph

4.2.2.1 the original text to be kept, "For tanks used for water ballast --"

4.2.2.2.e to be deleted.

For details see attached document where the text for the requirements in Z10.3 and Z10.4 that DNV will accept is stated.

Best Regards

Arve Myklebust  
on behalf of  
Terje Staalstrom  
DNV IACS Council Member  
<<Doc1.doc>>

\*\*\*\*\*

Neither the confidentiality nor the integrity of this message can be vouched

Annex 2 to TB (Harmonization Z10s)

**WP/SRC Task 114 “Clarify the procedure of verification and signature of the thickness measurement report”**

Item No.	Item	ABS	BV <sup>1)</sup>	CCS	CRS	DNV	GL	IRS	KR	LR	NK	RINA	RS
<b>1</b>	<b>Verification onboard</b>												
1.1	Minimum extent of measuring points for direct verification by attending surveyor specified	No	No	No	No	No	No	No	Yes	No	No	Yes	No
1.2	Preliminary TM record to be signed upon completion of the measurements onboard	Yes	Yes <sup>7)</sup>	Yes	No (copy taken)	No <sup>3)</sup>	No <sup>6)</sup>	Yes	Yes	Yes	Yes	No <sup>8)</sup>	No
<b>2</b>	<b>Final TM report</b>												
2.1	Signature of all pages in TM record required	No	No	No	Yes	No	Yes	Yes	No	No	No <sup>5)</sup>	Yes	Yes
2.2	Signature of ‘cover’ (‘general particulars’) page only	Yes	Yes	Yes	No	Yes	No	No	No <sup>4)</sup>	Yes	Yes	Yes	No
2.3	Measuring points verified by attending surveyor required identified in TM record and signature of the corresponding pages required	No	No	Yes Without signature	Yes	No	No	No	Yes	No	No	No	No

2004-04-20

<sup>1)</sup> Instructions not clear regarding signature of the thickness measurement record

<sup>2)</sup> Signature on front and last page, stamp on all other pages, or signature on each page (IACS TM forms)

<sup>3)</sup> Upon completion of measurements onboard a draft report in electronic format (DNV TM template, including operator’s notes as relevant) to be given to attending surveyor

<sup>4)</sup> Signature of cover page, pages of meeting record and pages of attended measuring points

<sup>5)</sup> Each page to be signed in case of ‘loose-leaf’ type record

<sup>6)</sup> Preliminary TM record has to be passed to the Surveyor, signed by the Operator

<sup>7)</sup> The only measures which the Surveyors can certify exact are those for which that they have seen the results on the screen of the apparatus. That means in fact few points in comparison with the numbers of recorded measures.

<sup>8)</sup> The Surveyor reviews the TM record for completeness and assessment of TM readings, but no signature required.

UR Z7s and Z10s (Corrosion Prevention System)

**1. Objective:**

To clarify whether the survey of anodes is a class matter, and if so, whether acceptance criteria for anode should be developed.

**2. Method:** GPG by correspondence (5037\_)

**3. Discussion**

3.1 BV initiated GPG discussion as follows:

Paris La Défense, 8 Mars 05

1 - We have noticed that, in the draft UR Z's ( 7.1, 10.1 to 10.5) issued further to the WP/SRC Task 102, the original sentence ".....the examination may be limited to a verification that the hard protective coating remains efficient....." has been replaced by ....that the corrosion prevention system remains efficient....". in a number of paragraphs (such as , for instance, Z 7.1, 4.2.3.1 a) ; Z 10.2 4.2.3.3 ; ), in line with IMO Res.A744(18).

2 - However, a corrosion prevention system is defined, in the same UR Z's and in IMO Res.A744(18) , as being either a full hard protective coating or a full hard protective coating supplemented by anodes.

3 - The above would mean that the survey of the anodes is a classification matter.

4 - However, whereas coating conditions are defined as good or fair or poor, there are no criteria in the IACS URs and IMO Res. A744(18) for the anodes condition.

5 - Assessing the anodes condition to confirm that they "remain efficient" looks to BV to be a quite difficult task for the ships in service Surveyor.

6 - Member's view and interpretations on the following would consequently be appreciated:

- do Members consider that the above requirements in IACS URs imply that survey of anodes is part of the classification ?
- do Members consider that the above requirements in IMO Res. A 744 (18) imply that survey of anodes is mandatory?
- if yes, what is the acceptance criteria to conclude that the anodes" remain efficient" ?

3.2 The majority of GPG Members replied that they did not include requirements for anodes in their class rules.

LR / ABS / DNV / KR / NK / RINA / RS were of the view that the condition of any anodes fitted should be recorded for information purposes as the survey of anodes is neither a classification matter nor a mandatory requirement in IMO A.744(18) and has no impact on future surveys (5037\_LRa). [Note; LR further clarified that "Whilst I agree that the performance of anodes is not normally a class matter LR does require that as part of Special Survey on oil tankers : "The attachment to the structure and condition of anodes in tanks are to be examined ." Therefore we cannot say that 'the survey of anodes is not a classification matter'. 5037\_LRb]

However, GL said that “for GL, anodes are a matter of class and as such are subject to plan approval as well as surveys. In case of missing or worn-out anodes we issue a condition of class”(5037\_GLa&b).

CCS advised that its rules have a general requirement relating to anode survey, which is only conducted, through sampling, during construction, docking survey or where there is a definite requirement for the survey of ballast tanks.

NK proposed that the following footnote be added to Z7s and Z10s:  
“The survey of anodes is not a classification matter.” No majority support was achieved.

#### **4. Conclusion**

RINA suggested to simply amend the definition of "Corrosion Prevention System" in paragraph 1.2.9 of UR Z7 (and, of course, the paragraphs in all the other UR Zs containing the definition of "Corrosion Prevention System") in order to eliminate any reference to anodes. This proposal would leave room for Societies willing to include additional class requirements for anodes to do so in their Rules.

GPG agreed.

### **RINA proposed amendments to paragraph 1.2.9 of UR Z7 and corresponding paragraphs in all other UR Zs (5037\_RIb, 6 April 2005)**

#### 1.2.9 Corrosion Prevention System

A corrosion prevention system is normally considered ~~either: a full hard protective coating, or~~  
~~1 a full hard protective coating, or~~  
~~2 a full hard protective coating supplemented by anodes.~~

Hard protective coating is usually to be epoxy coating or equivalent. Other coating systems may be considered acceptable as alternatives provided that they are applied and maintained in compliance with the manufacturer's specifications.

Where soft coatings have been applied, safe access is to be provided for the surveyor to verify the effectiveness of the coating and to carry out an assessment of the conditions of internal structures which may include spot removal of the coating. When safe access cannot be provided, the soft coating is to be removed.

[Annex: Council Chair's conclusive message.](#)

6 May 2005  
Permsec

## **Annex. (5037\_ICb, 15 May 2005)**

To : All IACS Council Members  
c.c : Mr. R. Leslie, IACS Permanent Secretariat

Ref. Mr G-Y. Han's message IAa dated 6 May 05  
Message ICa dated 6 May 05  
Admiral R.E. Kramek's message ABb dated 13 May 05

Paris La Défense, 15 May 05

- 1 - All Members have agreed with the texts attached to Mr Han's message.
- 2 - Further to ABS comments the reference to anodes is to be deleted in Annex I and in tables IX (IV) and IX(II).
- 3 - further to ABS questions regarding what IACS plan to do regarding IMO and A.744(18) further to IACS deletion of reference to anodes from the UR Z7's and UR Z10's it is to be noted that:

The Item 1.2.9 in UR Z10.1 and relative items in these URs states  
*1.2.9 10 Corrosion Prevention System: A corrosion prevention system is normally considered either:*

- .1 a full hard protective coating, or*
- .2 a full hard protective coating supplemented by anodes.*

*Hard Pprotective Ccoating is to usually to be epoxy coating or equivalent. Other coating systems may be considered acceptable as alternatives provided that they are applied and maintained in compliance with the manufacturer's specification.*

*Where Soft Coatings have been applied, safe access is to be provided for the surveyor to verify the effectiveness of the coating and to carry out an assessment of the conditions of internal structures which may include spot removal of the coating. When safe access cannot be provided, the soft coating is to be removed.*

- therefore the anodes are not considered as the main means of protection against the corrosion It is only a supplement;
- there is no provision in UR Z7's and Z10's to evaluate the level efficiency of the anodes;
- there is no specific requirements in case of lack of efficiency of the anodes.

The experience has shown that ballast tanks only protected by anodes are subject to corrosion when the anodes are becoming less efficient.

The anodes are active only when immersed by sea water. Therefore the upper part of the ballast tanks are not protected when the ballast is full of water and the ballast is not protected when it is empty..

The ships operators are reluctant to replace the anodes especially in upper part which request fitting of scaffolding fo welding the anode supports to the structure.

[The above arguments justify the reasons why IACS consider that the anodes are not class item.](#)

[4 - These arguments can be used by IACS Members](#) attending the WG bulk carriers at MSC 80 to try to obtain deletion of the reference to anodes in A. 744(18).

Best regards,

Bernard Anne  
IACS Council Chairman.



# **TB**

## **UR Z10.2(Rev.18, Corr.1 Jan 2006)**

- 1. Para. 1.4 and 7.1.3**
  
- 2. Para. 5.5.4 and 5.5.6**

**Survey Panel Task 22 – Amend applicable URZ7s and Z10s to align Close-Up Survey and Thickness measurements to be carried out at the same time and location allowing for a more structured control of the thickness measurement process.**

**Technical Background**

**Z7(Rev.12)**

**Z7.1(Rev.3)**

**Z10.1(Rev.13, para.1.4 & 7.1.3)**

**Z10.2(Rev.18, para. 1.4 & 7.1.3)**

**Z10.3(Rev.8, para. 1.4 & 7.1.3)**

**Z10.4(Rev.3, para. 1.4 & 7.1.3)**

**Z10.5(Rev.2, para. 1.4 & 7.1.3)**

**1. Objective**

To amend the applicable URZ7s and Z10s to align Close-Up Survey and Thickness measurements to be carried out at the same time and location allowing for a more structured control of the thickness measurement process.

**2. Background**

IACS QC findings, through audits of numerous Societies, which indicated concerns over Surveyor attendance and control of thickness measurement processes.

**3. Methodology of Work**

Survey Panel members through correspondence.

**4. Discussion**

To align Close-up survey requirements and thickness measurements in the applicable URZ7s and URZ10s, in accordance with PR19, all Panel members agreed through correspondence and a final vote at the fall Survey Panel meeting, that URZ7, Z7.1, Z10.1, Z10.2, Z10.3, Z10.4 and Z10.5 should include in the applicable sections of the noted URs as proposed by the Survey Panel the wording “ In any kind of survey, i.e. special, intermediate, annual, or other surveys having the scope of the foregoing ones, thickness measurements of structures in areas where close-up surveys are required, shall be carried out simultaneously with close-ups surveys.”

**5. Implementation**

The Survey Panel is of the view that the Members need 12 months from the adoption date to implement these amendments into their class rules. Assuming that GPG and Council approve to the amendments, the Survey Panel would propose January 2007 as an implementation date.

## **Technical Background**

**UI SC 191 (Rev.2, Oct 2005)**

**&**

**UR Z10.1 (Rev.13)**

**UR Z10.2 (Rev.18)**

**UR Z10.3 (Rev.8)**

**UR Z10.4 (Rev.3)**

**UR Z10.5 (Rev.2)**

### **1. Objective**

- to confirm whether the guidelines for approval/acceptance of alternative means of access (now REC91, ex Annex to UI SC191) is mandatory or non-mandatory.
- to consider other safety related proposals.

### **2. Background**

The DNV proposal to submit the UI SC191(Rev.1, May 2005, Annex 1) to IMO DE49 triggered a number of discussion points that led to amendments to the following resolutions:

UI SC191(Rev.2)  
New REC 91  
REC 39(Rev.2)  
UR Z10s

### **Points of Discussion**

3. Is the Annex to UI SC191(Rev.1, May '05, guidelines for approval / acceptance of alternative means of access) mandatory or non-mandatory ?

Answer: Non-mandatory. Hence, re-categorized as new REC 91.

4. Limitation of use of rafts in bulk carrier holds

DNV proposed that conditions for rafting should be limited to areas, such as anchorage or harbour, where swell conditions are limited to 0.5m. After discussion, GPG approved the ABS' alternative proposal to use the swell condition as a basis to determine the appropriateness of rafting, instead of geographic areas(harbours or anchorage). 5.5.4 of Z10.2 refers.

RINA proposed that para 5.5.4 should be included in all the Z10s. NK's objection is recorded as follows (3037hNKq, 29/08/2005):

1. With regard to RIm of 26 August 2005, NK considers that the proposed amendment to 5.5.4 should be limited to UR Z10.2.
2. Rafting survey for tankers are actually carried out on the open sea from a discharge port to a loading port and in such situation the rise of water within the tanks would always exceed 0.25m. It is different situation from rafting survey for hold frames of bulk carriers normally conducted in a harbour or at an anchorage.
3. If the same requirement applies to tankers, any rafting survey for cargo oil tanks and ballast tanks of tankers would be prohibited. This is not practicable under present survey procedure for tankers.
4. Therefore, NK can not support Laura's proposal that the proposed amendment to 5.5.4 of UR Z10.2 is introduced into the other URs and new Recommendation.

For compatibility with the IMO's mandatory requirements\*, GPG decided to add the same amendment to all the UR Z10s.

\*

- Appendix 4 to MEPC.99(48) 'Mandatory requirements for the Safe Conduct of CAS Surveys'
- MSC.197(80) – amendments to A.744918), Annex A for DSS and SSS bulk carriers and Annex B for single and double hull oil tankers.

As a consequence, 5.5.1 of REC 91(ex Annex to UI SC191) was also amended:

- to remove the reference to dynamic /sloshing (as the 0.25m rise was considered negligible);
- to refer to the rafting conditions contained for cargo holds in Z10.2 and Z10.5 and for oil cargo tanks in Z10.1 and Z10.4.

5. Means of access from longitudinal permanent means of access within each bay to rafts

GPG reviewed the proposal that the following text be added to Z10s:

[A means of access to the longitudinal permanent platform from rafts or boats is to be fitted in each bay.](#)

(Technical Background: for the safety of surveyors)

There may be ships which are arranged in accordance with para b, page 8 of the Annex to the current SC 191 (i.e., no means of access from the LPMA in each bay to a raft is required) and therefore could not be rafted if the sentence proposed by RINA ("[A means of access to the longitudinal permanent platform from rafts or boats is to be fitted in each bay](#)") is included in the Z10's.

GPG therefore agreed not to include this sentence in Z10s.

For the same reason, the same sentence was not added to Rec.39.

Finally, GPG added the following sentence to UI SC191(interpretation for II-1/3-6):

*A permanent means of access from the longitudinal platform to the water level indicated above is to be fitted in each bay (e.g permanent rungs on one of the deck webs inboard of the longitudinal permanent platform).*

## **6. Implementation**

It was agreed that the revised UI SC191 be implemented to ships contracted for construction 6 months after adoption by Council.

UI SC191 was also edited in line with IMO MSC/Circular. 1176, leaving its mandatory language (is/are to, shall) unchanged.

(Note: UI SC191(Rev.2) makes references to the following new Recommendations:

- REC 90: Ship Structure Access Manual
- REC 91: Guidelines for approval/acceptance of Alternative Means of Access)

23 September 2005  
Permanent Secretariat  
Updated on 13 Oct 2005.

**Survey Panel Task 11 – Unified Periodic Survey Requirements related to SOLAS  
Reg. XII/12 & Reg. XII/13.**

**Technical Background  
Amendments to UR Z10.2(Rev.19, Jan 2006) and UR Z10.5 (Rev.3, Jan 2006)**

### 1. Objective

To amend UR 10.2 Section 2.6 and 3.4 and UR Z10.5 Section 2.6 and 3.3 to include survey requirements related to SOLAS reg. XII/12 and XII/13.

### 2. Background

This task was originally discussed during the WP/SRC annual meeting which took place at DNV Headquarters on the 26<sup>th</sup> to 28<sup>th</sup> October 2004; it was subsequently recorded under paragraph 9 “any other business” of the minutes of this meeting. While the SOLAS Reg.XII/12 (hold, ballast and dry spaces water level detectors) and XII/13 (availability of pumping systems) retroactive requirements for existing bulk carriers have entered into force on 1<sup>st</sup> July 2004, as required by IMO Res.MSC.134(76), the IACS UR S 24 has been deleted on 1<sup>st</sup> January 2004. In addition, SOLAS does not include any periodical survey requirements for such detection systems and pumping systems.

### 3. Methodology of Work

Survey Panel members through correspondence.

### 4. Discussion

Survey Panel member from BV raised this issue at the February 2005 Survey Panel meeting and volunteered to propose amendments to the applicable URs for Panel members to review and comment on through correspondence. At the Fall meeting of the Survey Panel, it was agreed upon by all Panel members that the proposed amendments for UR Z10.2 and Z10.5 as applicable, which were proposed by BV were acceptable.

### 5. Implementation

The Survey Panel is of the view that the Members need 12 months from the adoption date to implement these amendments into their class rules. Assuming that GPG and Council approve to the amendments, the Survey Panel would propose January 2007 as an implementation date.

Submitted by Survey Panel Chairman  
4 Nov 2005  
approved on 31 Jan 2006 (5031fICa)

**Survey Panel Task 4 –  
Means of Access for Close-Up Surveys of Capesize Bulk Carrier hold frames  
Technical Background  
UR Z10.2 / Section 5.3 (Rev. 20, s/n 4110a, 10 Feb 2006)**

## **1. Objective**

To amend the requirements of UR 10.2 section 5.3.2 regarding the Close-up survey of hold frames with respect to acceptable means of access.

## **2. Background**

In a report to Council at C50 on the loss of side shell on a capesize vessel, it was stated that issues regarding the means of access for survey of hold frames was raised by the incident which had Council request the Survey Panel to review the current requirements for means of access for the surveyor, especially on existing capesize vessels.

## **3. Methodology of Work**

The Survey Panel, at its February 2005 meeting decided that this task should be dealt with by a project team, led by NK with members from BV, ABS, KR and CCS participating.

## **4. Discussion**

The members of the project team, through correspondence and one meeting in Japan, came to an agreement on the revisions to URZ10.2 Section 5.3.2 on how to address the concerns of Council. It was decided that the requirements for means of access be divided into two sections to better define the requirements applicable to each size of vessel; capesize and all bulk carriers under capesize. In addition, the requirements for capesize bulk carriers were then divided to indicate different requirements for annual, intermediate and special survey. Regarding the amendments for acceptable means of access, it was agreed upon by the Project team that hydraulic arm vehicles, boats or rafts, and portable ladders for bulk carriers less than capesize, should be added to the list of equipment for means of access. The Project Team representative at the Fall Survey Panel meeting from BV, presented the project team proposals to the Panel, which after some editorial changes, unanimously agreed to the proposed amendments to URZ10.2 section 5.3.2.

## **5. Implementation**

The Survey Panel is of the view that the Members need 12 months from the adoption date to implement these amendments into their class rules. Assuming that GPG and Council approve to the amendments, the Survey Panel would propose 1 January 2007 as an implementation date.

Submitted by Survey Panel Chairman  
2 Nov 2005

## Permsec's Note

1. LR sought confirmation from the Survey Panel as to whether these amendments did not go against SOLAS regulation II-1/3-6 and TP and IACS UIs and MSC Circular. LR added that Bulk carriers being built today would have Access Manuals which would define means of access for close-up surveys approved by ROs on behalf of Administrations.

2. It was then confirmed that the Survey Panel's proposal was consistent with all IMO and IACS requirements and recommendations except that for capesize and above, it limited the use of portable ladders. In that regard, ABS proposed an editorial modification to achieve consistent text with REC.91 and that REC.91 be revised to refer to the limitation of ladders introduced in 5.3.2 and 5.3.3 of UR Z10.2 (Rev.18). See REC 91, para. 5.6.1 (Rev.1, Nov 2005).

3. For reference, ABS' clarifications to the points raised by LR are attached (4110aABb, 16 Nov 2005).

## 4. Council discussion

### 4.1 Editorial nature:

Council approved the NK proposal to re-number the paragraphs 5.3.2~5.3.4, and to relocate references to "shell frames" / "hold frames" from the bulleted items to the chapeaux of the re-numbered paragraphs by referring to these cargo hold structural members as "cargo hold shell frames". This is consistent with the current text of Z10.2 which predominantly refers to these cargo hold structural members as "shell frames".

### 4.2 Substantive nature - para.5.3.4

#### 4.2.1 NK's first proposal:

The following NK's proposed revision of paragraph 5.3.4 of Z10.2 did not achieve 3/4 majority support by Council Members.

"5.3.4 For close-up surveys of the cargo hold shell frames of capesize bulk carriers (100,000 dwt and above), the use of *free standing* portable ladders *irrespective of their length*, is not accepted, and one or more of the following means for access, acceptable to the surveyor, is to be provided:"

**Not adopted, Reason:** The introduction of "free standing" portable ladders is contrary to what GPG and the Survey Panel unanimously agreed with respect to prohibiting the use of any type of portable ladders (free standing, articulated, or otherwise) for close up surveys of cargo hold shell frames of bulk carriers (100k dwt and above). The text of the re-numbered paragraph 5.3.4 therefore remained without changes.



#### 4.2.2 NK's 2<sup>nd</sup> proposal:

NKc offered a "compromise" proposal with a view to resolving this dilemma which would retain the original text of 5.3.4 but add a paragraph allowing the use of portable ladders fitted with a mechanical device to secure the upper end of the ladder only for Annual Survey of cargo hold shell frames of capesize bulk carriers

Under 5.3.4

Notwithstanding the above requirements, for close-up surveys of the cargo hold shell frames at Annual Survey, the use of portable ladder fitted with a mechanical device to secure the upper end of the ladder is accepted.

#### 4.2.3 LR agreed but expressed the following view:

If the argument for limiting the use of ladders is still valid then there is a need to specify that their use is permitted only for "Close-up examination of sufficient extent, minimum 25% of frames, to establish the condition of the lower region of the shell frames including approx. lower one third length of side frame at side shell and side frame end attachment and the adjacent shell plating in the forward cargo hold", however "Where this level of survey reveals the need for remedial measures, the survey is to be extended to include a Close-up Survey of all of the shell frames and adjacent shell plating of that cargo hold as well as a Close-up survey of sufficient extent of all remaining cargo holds" the ladders should not be used and the hold should be staged.

LR's text was then modified by the Chairman to address the minimum extent of close-up survey of frames of capesize bulkers age 10 and older, at annual survey as required in 3.2.4 of UR Z10.2:

Under 5.3.4:

Notwithstanding the above requirements, the use of a portable ladder fitted with a mechanical device to secure the upper end of the ladder is acceptable for the "close-up examination of sufficient extent, minimum 25% of frames, to establish the condition of the lower region of the shell frames including approx. lower one third length of side frame at side shell and side frame end attachment and the adjacent shell plating of the forward cargo hold" at Annual Survey, required in 3.2.4.1.b, and the "one other selected cargo hold" required in 3.2.4.2.b.

**Adopted on 10 Feb 2006.**

**Attached:** ABS' clarifications to the points raised by LR are attached (4110aABb, 16 Nov 2005).

---

**From:** AIACS@eagle.org  
**Sent:** 16 November 2005 19:46  
**To:** iacs@bureauveritas.com; clnkiacs@classnk.or.jp; colinwright@iacs.org.uk; efs@iacs.org.uk; iacs@lr.org; gilyonghan@iacs.org.uk; helenbutcher@iacs.org.uk; iacs@ccs.org.cn; iacs@dnv.com; iacs@rina.org; iacs@rs-head.spb.ru; iacs@gl-group.com; johnderose@iacs.org.uk; krsiacs@krs.co.kr; richardleslie@iacs.org.uk; terryperkins@iacs.org.uk  
**Subject:** 4110aABb: Close-up surveys of bulk carrier hold frames, P/SU Task [4] (C50 FUA 7)

Date: 16 Nov 05

TO: Mr. Steven McIntyre, IACS GPG Chairman

CC: IACS GPG Members

CC: IACS Permanent Secretary: Mr. R. Leslie

FROM: S. R. McIntyre

File Ref: T-12-2

Subject: 4110aABb: Close-up surveys of bulk carrier hold frames, P/SU Task [4] (C50 FUA 7)

I note Kosta's LRb request to "*know the effect the proposed amendment will have on the designs already formally accepted to comply with SOLAS and IACS U*" before giving final approval to the amendments. While the effect will only be known for each ship depending on the arrangement provided, I have the following comments to the numbered points Kosta raises:

3. I do not consider that a "*significant impact*" will result if IACS limits the use of portable ladders > 5m in length, since use of these ladders would otherwise greatly increase the time to survey, gauge and, if necessary, repair the side shell relative to employing other alternatives (e.g., cherry pickers). While the owner would have paid for these ladders based on RO's approval, the proposed UR would limit their use for survey only and these ladders are still available for use by the crew (which is included in the objectives of the TP's) to carry out maintenance and inspection.

4. Until such time that the TP's, MSC/Circ.1176 and/or the UI SC 191 are revised, ABS will ensure that those responsible for approving the SSAS are aware of the more limited choice of alternative means of access for capesize bulk carriers as per draft provisions of UR Z10.2.

4.1 The draft proposals for Z10.2 do not address, and therefore allow, the use of portable ladders > 5 m in spaces other than cargo holds.

Regards,

S. R. McIntyre

ABS IACS GPG Member

email protected and scanned by BIS Advanced Spam & Virus Checking - powered by AdvascanTM  
- keeping email useful

**Survey Panel Task 37 – Amend UR Z10.2 to increase the scope of the survey requirements of Special Survey No.2 and the Intermediate Survey between Special Survey No. 2 and No.3 for Cape Size Bulk Carriers**  
**Technical Background Document**  
**UR Z10.2**  
(Rev.21, May 2006)

**1. Objective:**

Amend UR Z10.2 to increase the scope of the survey requirements of Special Survey No.2 and the Intermediate Survey between Special Survey No. 2 and No.3 for Cape Size Bulk Carriers

**2. Background**

The project team from Survey Panel Task 4, which dealt with amending the close-up surveys of bulk carrier hold frames, recommended to the Survey Panel at the Fall 2005 meeting that the Survey Panel should be tasked to amend the relevant sections of UR Z10.2 to increase the scope of requirements for Cape size bulk carriers because of the intermediate survey between SS No2 and & 3 is more critical than Special survey no.2 in respect of the close-up survey of hold frames.

**3. Discussion**

The member from NK proposed the following:

NK does not agree with the draft amendments of special survey No.2 in IAb which are completely same as the requirements of special survey No.3.

There should be some difference between the requirements of special survey No.2 and No.3 because the requirements in the Table I are become stricter as ships become older.

NK proposed to reduce "one other selected cargo hold" from the draft.

All members agreed to the proposal from NK, with further minor amendments from RINA and BV, which was agreed upon unanimously by Panel members at the Spring 2006 meeting.

**4. Implementation**

The Survey Panel is of the view that the Members need 12 months from the adoption date to implement these amendments into their class rules/procedures. Assuming that GPG and Council approve the amendments, the Survey Panel would propose **July 2007** as an implementation date.

**Submitted by Survey Panel Chairman**

**Survey Panel Task 43 – Amend the applicable sections of the URs to address the requirements for substantial corrosion in the Common structural rules.**

**Technical Background**

**(UR Z10.2, Rev.22, June 2006)**

**(UR Z10.4, Rev.4, June 2006)**

**(UR Z10.5, Rev.4, June 2006)**

**1. Objective**

Amend applicable sections of the URs to address the requirements for substantial corrosion in the Common structural rules.

**2. Background**

Due to the different application of substantial corrosion in the CSR from the current Unified Requirements.

**3. Methodology of Work**

Panel members discussed the proposed revisions through correspondence up to the Spring Panel meeting where final amendments were agreed upon for submittal to the IACS Hull Panel for review.

**4. Discussion**

After much discussion between all Panel members at the March 2006 Survey Panel members, a unanimous decision was reached as to the wording of CSR Substantial corrosion in UR Z10.2, 10.4, and 10.5 in section 1.2.9 and was then submitted to the Hull Panel for review and approval. The hull panel concluded that the Survey Panel definition for CSR substantial corrosion was not entirely accurate and recommended further amendments to clarify the actual requirements. The new definition was then circulated to the Survey Panel for a final review and was unanimously agreed upon.

**5. Implementation**

The Survey Panel is of the view that the Members need 12 months from the adoption date to implement these amendments into their class rules/procedures. Assuming that GPG and Council approve the amendments, the Survey Panel would propose **July 2007** as an implementation date.

Submitted by Survey Panel Chairman

## **Technical Background**

### **UR Z10.1 (Rev.14), UR Z10.2 (Rev.23), UR Z10.4 (Rev.5) & UR Z10.5 (Rev.5)**

#### **Survey Panel Task 3 – Maintenance of Alignment/ Compatibility of IACS URs and IMO survey requirements**

##### **1. Objective**

Maintenance of alignment/compatibility of IACS URs and IMO survey requirements regarding resolution MSC 197(80) – amendments to A744(18)

##### **2. Background**

IMO survey requirements to ESP vessels as amended in A744(18) as noted in MSC 197(80), with an implementation date of 1 January 2007.

##### **3. Methodology of Work**

Survey Panel members through correspondence.

##### **4. Discussion**

Survey Panel members, at the fall 2006 Survey Panel meeting, finalized the amendments to the applicable URs due to changes adopted at MSC(80).

Additionally, Members noted that URZ10.4 paragraphs 2.2.3.1 and 4.2.2.2 does not require examination of ballast tanks adjacent to heated fuel tanks, as required by MSC197(80). The survey panel agreed that if this is the position that IACS would like to take regarding double hull tankers, then it should be brought to the attention of IMO at the next IMO meeting, DE50 in March 2007.

##### **5. Implementation**

The Survey Panel is of the view that the Members need 12 months from the adoption date to implement these amendments into their class rules. Assuming that GPG and Council approve the amendments, the Survey Panel would propose January 2008 as an implementation date, although the IMO implementation date is January 2007.

Submitted by Survey Panel Chairman  
9 January 2007

##### **GPG discussion**

All members agreed to omit the requirement of examination of ballast tanks adjacent to heated fuel tanks, as required by MSC197(80), from URZ10.4 for double hull tankers and

that it should be brought to the attention of IMO at DE50. In addition ABS proposed that paragraphs relating to similar requirements in URZ10.1 should also be deleted for consistency and this was agreed by members.

Members also made a number of minor/editorial corrections to the text prior to their approval of the revised documents.

Added by Permanent Secretariat  
23 April 2007

## Technical Background Document

### UR Z10.5 (Rev.6 April 2007) & UR Z10.2 (Rev.24 April 2007)

*(Survey Panel Task 10 – Develop survey requirements for void spaces of ore carriers)*

#### **1. Objective:**

Develop survey requirements for void spaces of ore carriers

#### **2. Background**

DNV requested at WP/SRC Annual meeting October 2004 to develop survey requirements void spaces of ore carriers. See the attached document « Ore Carriers, Hull Survey Requirements » for easy reference. NK submitted a « A case study on a certain Ore Carrier » dated 22 October 2004 for this purpose.

#### **3. Discussion**

The task has been carried out by a Project Team chaired by DNV Survey Panel member and with Survey Panel members from BV, LR, NK and RINA.

The Project Team drafted new amendments to Unified Requirement UR Z 10.5 « Hull Surveys of Double Skin Bulk Carriers » using the same principles contained in the survey requirements of UR Z10.1 for ballast spaces of single hull oil tankers with appropriate adjustments recognizing that void spaces do not carry ballast water.

In that respect, a new TABLE I/Sheet 2 was developed to cover the minimum requirements for close-up surveys at special hull surveys of ore carriers. The existing TABLE I, renamed TABLE I/Sheet 1, was made applicable to double skin bulk carriers excluding ore carriers.

Accordingly, TABLE III/Sheet 3 (REQUIREMENTS FOR EXTENT OF THICKNESS MEASUREMENTS AT THOSE AREAS OF SUBSTANTIAL CORROSION OF DOUBLE SKIN BULK CARRIERS WITHIN THE CARGO LENGTH AREA) was renamed STRUCTURE IN DOUBLE SIDE SPACES OF DOUBLE SKIN BULK CARRIERS INCLUDING WING VOID SPACES OF ORE CARRIERS.

In addition, Sheets 15 and 16 of URZ10.2 Annex II are to be removed.

The draft amendments to UR Z10.5 were presented to the Survey Panel members on the 13th-15th September 2006 meeting at ABS Headquarters in Houston and were finally agreed by all members on the 22nd September 2006.

#### **4. Implementation**

The Survey Panel is of the view that the Members need 12 months from the adoption date to implement these amendments into their class Rules/procedures. Assuming that GPG and Council approve the amendments by the end of 2006, the Survey Panel would propose as an implementation date for surveys commenced on or after the **1 July 2008**

**Submitted by Survey Panel Chairman  
22nd March 2007**

#### **Permsec note (May 2007):**

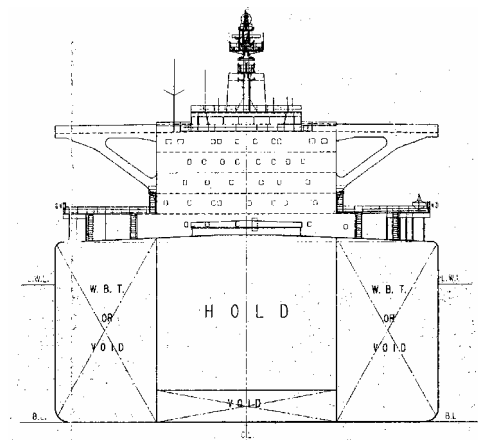
Revisions adopted by GPG 12 April 2007 (5031hIGg).

**Attachment:**

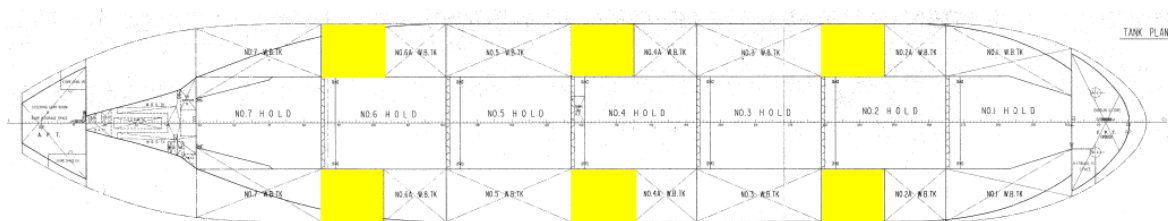
**Ore Carriers, Hull Survey Requirements**

"Ore carrier" means a single deck ship having two longitudinal bulkheads and a double bottom throughout the cargo region and intended for the carriage of ore cargoes in the centre holds only. Side tanks are generally arranged for the carriage of water ballast.

In accordance with UR Z10.5, for close-up surveys of side ballast tanks of ore carriers, the survey requirements of side ballast tanks for oil tankers as given in UR Z10.1 apply.

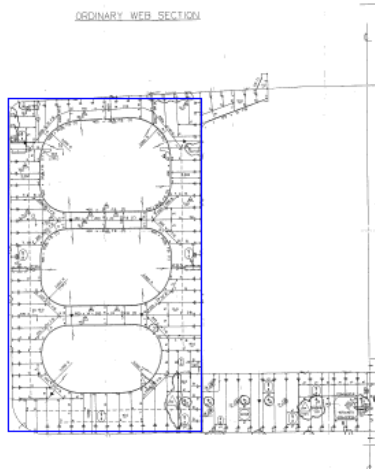


However, the amount of ballast water required to meet draught requirements for navigation / harbour operations, are generally less than the total capacity of the side tanks. Hence ore carriers are often designed with several side tanks as void spaces.



The internal structures are generally as for side ballast tanks with transverse web frame rings. The protective coating, if any, may be less durable than coating applied for ballast tanks and the void spaces are exposed to corrosion.





Ore carriers are generally large sized vessels and the overall survey of side void spaces may not be sufficient in order to carry out a meaningful survey for detection of corrosion and other structural defects.

**It is proposed to consider minimum requirements for close-up surveys for side void spaces. Requirements given in UR Z10.1 applicable to side cargo tanks may be used as basis.**

DNV 2004-10-19

## **Technical Background**

### **UR Z10.2, Rev.25 (July 2007)** ***Amendments to 5.3.3 , 5.3.4 and Table 1***

*(Survey Panel Task 1 – Annual Review of Implementation of IACS Resolutions)*

#### **1. Objective**

Maintenance of alignment/compatibility of IACS URs and IMO survey requirements

#### **2. Background**

This proposed change was raised by the ABS member from the Survey Panel, due to questions raised by industry.

#### **3. Methodology of Work**

Survey Panel members through correspondence.

#### **4. Discussion**

Due to the many different interpretations of what size a Cape size bulk carrier is, the wording ‘Cape Size’ is proposed to be removed and replaced with ‘...100,000 dwt and above.’, to make the additional requirements very clear, regarding applicability. All members of the Survey Panel unanimously agreed to this proposed change.

#### **5. Implementation**

The Survey Panel is of the view that the Members need 12 months from the adoption date to implement these amendments into their class rules. Assuming that GPG and Council approve to the amendments, the Survey Panel would propose July 2008 as an implementation date.

Submitted by Survey Panel Chairman  
22 June 2007

#### **Permanent Secretariat note (July 2007):**

Adopted by GPG with an implementation date of 1 July 2008 on 19 July 2007 (ref. 5031kIGd).

## **Technical Background**

**URs Z7(Rev.15), Z7.1(Rev.5), Z7.2(Rev.1), Z10.1(Rev.15),  
Z10.2(Rev.26), Z10.3(Rev. 9), Z10.4(Rev.6), Z10.5(Rev.8) – November  
2007**

### ***Survey Panel Task 1 – Annual Review of Implementation of IACS Resolutions***

#### **1. Objective**

To review IACS Resolutions annually and discuss or propose amendments as deemed necessary.

#### **2. Background**

This proposed amendment to all URZ7s and URZ 10s was raised by the Panel member from DNV due to Owners crediting tanks concurrently under intermediate and special survey.

#### **3. Methodology of Work**

Survey Panel members through correspondence.

#### **4. Discussion**

The Panel member from DNV raised the issue of Owners having the ability of crediting spaces and thickness measurements only once in a 54 month interval, due to the availability of concurrent crediting of spaces and thickness measurements due to the flexible time window that is currently allowed between the intermediate survey and the special survey.

After a presentation and discussion lead by the DNV Panel member, all Survey Panel members agreed to the argument given by DNV, and further agreed to make the necessary changes in all URZ7s and URZ10s where Owners are not allowed to concurrently credit surveys and thickness measurements of spaces.

#### **5. Implementation**

The Survey Panel is of the view that the Members need 12 months from the adoption date to implement these amendments into their class rules. Assuming that GPG approve to the amendments, the Survey Panel would propose January 2009 as an implementation date.

Submitted by Survey Panel Chairman  
22 October 2007

**Permanent Secretariat note (December 2007):**

During GPG discussion DNV proposed that *“since this matter will be discussed between Owner and Class mainly in connection with the forthcoming Special Survey, DNV would prefer to locate this text, not only as part of Intermediate Survey, but also as a new text for the Special Survey.”* This was supported by BV, ABS, RINA and KR.

The revised documents were approved, with DNV’s proposal and an implementation date of 1 January 2009, on 15 November 2007 (ref. 7690\_IGb).

## Technical Background

### URs Z7(Rev.16), Z7.1(Rev.6), Z7.2(Rev.2), Z10.1(Rev.16), Z10.2(Rev.27), Z10.3(Rev.11), Z10.4(Rev.7) and Z10.5(Rev.9) - March 2009

#### Survey Panel Task 62:

- A) *Harmonization of UR Z10.1, Z10.2, Z10.4 and Z10.5 with UR Z10.3 with respect to items 5.5.4.4 and 5.6.2.*
- B) *Harmonization of UR Z7, Z7.1, Z10.1, Z10.2, Z10.3, Z10.4 and Z10.5 with UR Z7.2 with respect to the definition of the corrosion prevention system and with respect to the footnote 1 related to semi-hard coatings.*
- C) *Harmonization of the definition of Ballast Tank in UR Z7(Rev.14)*

### 1. Objective

- A) Amend the texts of items 5.5.4.4 and 5.6.2 in Unified Requirements Z10.1, Z10.2, Z10.4 and Z10.5 in order to align them with those in UR Z10.3, in which they were changed while performing Task 55, whereas in the other UR Z10s they were kept unchanged on the grounds that this change was out of the scope of Task 55.
- B) Amend the definition of “Corrosion Prevention System” and include a Footnote 1 related to semi-hard coatings in Unified Requirements Z7, Z7.1, Z10.1, Z10.2, Z10.3, Z10.4 and Z10.5 in order to align them with those adopted in UR Z7.2, when this new UR was issued.
- C) Amend UR Z7 (Rev. 14) in all items where the term “Ballast Tank” is used in order to get them harmonized with the definition itself.

### 2. Background

The task, as regards item A), was triggered by a Member Society, while performing Task 55, on the grounds that this part was out of the scope of the task and then should have been dealt with in a separate task.

The task, as regards item B), was triggered as a consequence of the “New Business action item 2” of the Minutes of the September 2008 Survey Panel meeting, for sake of harmonization of the various URZs.

The task, as regards item C), was triggered as a consequence of the “Task 54-Examination of Double Bottom Ballast Tanks at annual surveys” of the Minutes of March 2008 Survey Panel meeting, for sake of harmonization of the definition of Ballast Tank in UR Z7(Rev.14).

### 3. Discussion

The task was carried out by correspondence. All the amended texts for the affected URs were prepared by the Survey Panel Member who had chaired the PT on Task 55, in accordance with the Form A approved by GPG. In addition to the objectives outlined in the Form A, an amendment was added to item 1.3.1 of UR Z10.2 and UR Z10.5 in which the reference 3.2.3.6 in the last item of the list was replaced by 3.2.3.10 as can be correctly verified in the text.

The amended URs were circulated to all Survey Panel Members for review, comments and agreement. The texts of the URs were unanimously agreed by all Members.

#### **4. Implementation**

The Survey Panel is of the view that the Member Societies need at least 12 months from the adoption date to implement these amendments into their class rules/procedures. Therefore, in the first version of all amended URs the following implementation sentence should be proposed:

*Changes introduced in Rev .xx are to be uniformly applied by Member Societies and Associates for surveys commenced on or after [not less than 12 months after the adoption by GPG/Council].*

Since it is common practice and convenience to have implementation dates either on 1<sup>st</sup> January or on 1<sup>st</sup> July of the year, the Survey Panel proposes the 1<sup>st</sup> July 2010 as implementation date, if GPG/Council approve the URs not later than 30 June 2009.

**Submitted by Survey Panel Chairman  
28 February 2009**

#### **Permanent Secretariat notes (April 2009):**

1. The amended URs were approved by GPG on 18 March 2009 (ref. 7718bIGd).
2. During the typesetting process it was noted that para 5.1.5 of UR 7.2 was inconsistent with the amended URs and so following consultation with the Survey Panel this was also amended at this time.
3. Regarding the implementation date, GPG agreed to use 1<sup>st</sup> July 2010 provided that it was consistently used for the amended URs.

## **Technical Background for UR Z10.2 Rev.28 (Mar 2011)**

### **1. Scope and objectives**

- 1) To amend UR Z10.2 to harmonize the definition of transverse section.
- 2) Update of references in the Executive Hull Summary Table VII.
- 3) Correction of "minimum allowable diminution" to "maximum allowable diminution" in Annex II.
- 4) Review IACS URZ10.2 to determine if there are issues which need to be addressed to ensure that the IACS survey regime and the CSRs are compatible.

### **2. Engineering background for technical basis and rationale**

- 1) Based on that fact that bulk carriers and oil tankers have a transverse framing system applied for example on ship's sides etc. and that UR Z7 is applied to all types of ships and includes an extended definition of transverse section it is necessary to unify this definition in UR Z10s.
- 2) Update of references in the Executive Hull Summary Table VII such that the introduction of extended annual surveys is noted in the 'Memoranda' section rather than under 'Conditions of Class'.
- 3) Correction of "minimum allowable diminution" to "maximum allowable diminution" in Annex II to be consistent with the other UR Z10s.
- 4) Some requirements in CSRs for Bulk Carriers were relevant to ships in operation and it was decided to move them from CSRs to UR 10.2 in more consistent way.

### **3. Source/derivation of the proposed IACS Resolution**

CSRs, IACS UR Z7 and other UR Z10s.

Proposed amendments to UR Z10.2 is based on internal discussion of IACS which is always striving to produce consistent and compatible rule requirements.

### **4. Summary of Changes intended for the revised Resolution:**

- 1) The following additional text is added to the definition of transverse section in para 1.2.7:

*"For transversely framed vessels, a transverse section includes adjacent frames and their end connections in way of transverse sections."*

- 2) In the Executive Hull Summary Table VII (iv) the reference to part G) is updated to part H) as per Table VII (ii).
- 3) The wording "minimum allowable diminution" is corrected to "maximum allowable diminution" in Annex II

## Part B

4) The main amendment has consisted in removing the requirements found in the CSRs related to surveys after construction and locating them in the applicable sections of UR Z10.2. The rationale of that is to have only one place where survey requirements are given and avoid any duplication of requirements in different documents, which would give rise to problems of maintenance and alignment.

Another important amendment has been the requirement for annual examination of the identified substantial corrosion areas for bulk carriers. One Member Society was of the opinion that there should be no difference between the CSRs and non-CSRs bulk carriers. The other Member Societies were of the opinion to consider an alternative examination, which was the original requirement in CSRs, and thus the following text was adopted in UR Z10.2:

“For vessel built under IACS Common Structural Rules, the identified substantial corrosion areas may be:

- a) protected by coating applied in accordance with the coating manufacturer’s requirements and examined at annual intervals to confirm the coating in way is still in good condition, or alternatively
- b) required to be gauged at annual intervals.”

Other important amendments have been made moving the following items from the CSRs to UR Z10.2 as applicable:

- a) the paragraphs regarding the different corrosion patterns, such as pitting corrosion, edge corrosion and grooving corrosion, and their different acceptance criteria,
- b) the items regarding the number and locations of thickness measurements, together with the associated table and referenced figures.

Another notable change has been introduced in the "ANNEX II - Recommended Procedures for Thickness Measurements" of UR Z10.2, which, however, are only recommendatory and not mandatory, where thickness measurements forms specific to CSRs single skin bulk carriers have been produced in addition to the existing ones, which only apply to non-CSRs ships.

Finally, for CSRs bulk carriers the requirement has been introduced which stipulates that “the ship’s longitudinal strength is to be evaluated by using the thickness of structural members measured, renewed and reinforced, as appropriate, during the special surveys carried out after the ship reached 15 years of age (or during the special survey no. 3, if this is carried out before the ship reaches 15 years) in accordance with the criteria for longitudinal strength of the ship’s hull girder for CSRs bulk carriers specified in Ch 13 of CSRs”.

### **5. Points of discussions or possible discussions**

See item 4 above.

### **6. Attachments if any**

None.



## **Technical Background for UR Z10.2 Rev.29, July 2011**

### **1. Scope and objectives**

Review the requirement for repairs within IACS UR 7 and UR 10 series, in particular the requirement for Prompt and Thorough Repair, with a view to developing wording that would permit a temporary repair and the imposition of a Recommendation/ Condition of Class under specific and controlled circumstances, and in accordance with PR35.

### **2. Engineering background for technical basis and rationale**

There are instances, for example a localised, isolated and very minor hole in a cross-deck strip, at which a suitable temporary repair, for example by welding or doubling, and the imposition of a suitable short term Recommendation/ Condition of Class for permanent repair at a later date, are considered very adequate methodology for dealing with the defect.

Current IACS Requirements in the UR Z7 and Z10 series, for Prompt and Thorough repair, would not permit this to be an option, the defect would have to be permanently Promptly and Thoroughly repaired, which might require removing cargo, moving to a repair berth and staging inner spaces.

Under the Requirements of IACS Procedural Requirement PR 35 the methodology of Temporary Repair and imposition of a suitable short term Recommendation/ Condition of Class for permanent repair at a later date is fully permissible.

### **3. Source/derivation of the proposed IACS Resolution**

Based upon discussion within the IACS Survey Panel.

### **4. Summary of Changes intended for the revised Resolution:**

Following the definition of Prompt and Thorough Repair in the Unified Requirement, a new paragraph is proposed to be added:-

"1.3.3 Where the damage found on structure mentioned in Para. 1.3.1 is isolated and of a localised nature which does not affect the ship's structural integrity, consideration may be given by the surveyor to allow an appropriate temporary repair to restore watertight or weather tight integrity and impose a Recommendation/Condition of Class in accordance with IACS PR 35, with a specific time limit."

### **5. Points of discussions or possible discussions**

a) The points of discussion are as indicated in Sections 2 and 4 above.

b) Discussion took place on whether to prepare this amendment as a Unified Interpretation of IMO Resolution A.744(18)/UR Z7 and Z10 series, finally it was agreed to make direct amendment to the relevant URs.

c) It is proposed that this amendment be submitted directly to the IMO DE/MSC Committees for consideration of amending directly IMO Res. A744(18)

**6. Attachments if any**

None

## **Technical Background for UR Z10.2 Rev.31, Jan 2014**

### **1. Scope and objectives**

- a) To consider appropriate text in IACS document regarding class period for lengthy conversions.
- b) To align the requirements in PR37 and UR Z10s regarding safe entry to confined spaces.

### **2. Engineering background for technical basis and rationale**

- a) As per the IMO Res. A1053 (27), lengthy conversions (not necessarily of major character) or other major repair work can be assigned for a 5 year period from the date of completion of conversion/repairs/surveys.
- b) Safety requirements in IACS PR37 can be applied to carry out survey in safe way for all kind of ships. When there are no indications about the safety of surveyor in UR Z10s then the requirements in PR37 shall be applied.

### **3. Source/derivation of the proposed IACS Resolution**

None

### **4. Summary of Changes intended for the revised Resolution**

- a) Following additional text was included to section 2.1.3 to clarify the class period for lengthy conversions

"In cases where the vessel has been laid up or has been out of service for a considerable period because of a major repair or modification and the owner elects to only carry out the overdue surveys, the next period of class will start from the expiry date of the special survey. If the owner elects to carry out the next due special survey, the period of class will start from the survey completion date."

- b) Existing Section 5.2.6 and 5.2.7 were deleted from UR Z10s since provisions of these sections were covered by PR37. Reference of PR37 was included in Section 5.2.1.1.

### **5. Points of discussions or possible discussions**

- i) Additional text to Para.2.1.3 was discussed in order to clarify class period.
- ii) Panel considered that safety of surveyors should be dealt by PR37.

### **6. Attachments if any**

None

## UR Z10.3 "Hull Surveys of Chemical Tanker"

### Summary

In revision 21 of this UR, the reference of Owner's Inspection Report has been added in Section 6.3.1 (Supporting Documents) to update this UR and to improve the consistency with the other UR Z10s.

### Part A. Revision History

Version no.	Approval date	Implementation date when applicable
Rev.21 (Aug 2023)	04 August 2023	1 July 2024
Rev.20 (May 2022)	03 May 2022	1 January 2023
Rev.19 (May 2019)	30 May 2019	1 July 2020
Rev.18 (Jan 2018)	15 January 2018	1 January 2019
Rev.17 (Feb 2015)	05 February 2015	1 July 2016
Rev.16 (Jan 2014)	14 January 2014	1 January 2015
Rev.15 (May 2013)	22 May 2013	1 July 2014
Rev.14 (Aug 2012)	20 August 2012	1 July 2013
Rev.13 (July 2011)	28 July 2011	1 July 2012
Rev.12 (Mar 2011)	24 March 2011	1 July 2012
Rev.11 (Mar 2009)	18 March 2009	1 July 2010
Rev.10 (Dec 2008)	2 December 2008	-
Rev.9 (Nov 2007)	15 November 2007	1 January 2009
Corr.1 (Sept 2006)	14 September 2006	1 January 2007
Rev.8 (Jan 2006)	4 January 2006	1 January 2007
Rev.7 (Jun 2005)	27 June 2005	1 July 2006
Rev.6 (Oct 2002)	22 November 2002	-
Rev.5 (Mar 2002)	19 March 2002	1 July 2002 or 1 year after Council adoption *1
Rev.4.1 (Jun 2001)	22 June 2001	1 July 2001
Rev.4 (Nov 2000)	23 November 2000	1 July 2001
Rev.3 (Sept 2000)	14 September 2000	1 July 2001
Rev.2 (July 1999)	16 July 1999	1 September 1999
Rev.1 (1997)	1 October 1997	-
New (1996)	May 1996 at C33	1 July 2007

**\* Notes:**

1. Paragraph 4.2.4.3 is newly introduced in Rev.5 in accordance with Res.MSC 105(73) and is to be implemented from 1 July 2002. The other changes introduced in Rev.5 are to be implemented within one year of the adoption by Council.

• **Rev.21 (August 2023)**

**.1 Origin of Change:**

- Suggestion by an IACS member

**.2 Main Reason for Change:**

An update of this UR to improve the consistency with UR Z10.4.

**.3 List of non-IACS Member classification societies contributing through the TC Forum and/or participating in IACS Working Group:**

None

**.4 History of Decisions Made:**

IACS decided to update this UR to improve the consistency with the outcome of previous work to revise other UR Z10s by including the reference of Owner's Inspection Report in its Section 6.3.1 (Supporting Documents).

**.5 Other Resolutions Changes:**

None

**.6 Any hinderance to MASS, including any other new technologies:**

None

**.7 Dates:**

Original Proposal:	24 February 2023	(Instructed by GPG via 22198_IGe)
Panel Approval:	20 July 2023	(22198_PYb)
GPG Approval:	04 August 2023	(22198_IGg)

• **Rev.20 (May 2022)**

**.1 Origin of Change:**

- Based on IMO Regulation (MSC.Res.483(103))
- Suggested by IACS Member

**.2 Main Reason for Change:**

To amend the minimum requirements of Thickness Measurements at Special Survey No.1 in line with the amendments made to ESP Code vide Res. MSC.483(103).

To make definition of ballast tanks in UR Z10s in line with other IACS Resolutions

**.3 List of non-IACS Member classification societies contributing or participating in IACS Working Group:**

None

**.4 History of Decisions Made:**

- One survey panel member raised issue regarding requirements for thickness measurements at Special Survey No.1. Some require deck plating and measurements for general assessment of items subject to close-up surveys (tankers, chemical carriers, gas carriers) while others only require suspect areas (bulk carriers, ESDC, all Z7 vessels). With PSPC, there should be no wastage in ballast spaces at SS No. 1.

Noting that the mandatory requirement for the coating of cargo oil tanks of Regulation 3-11 of Chapter II-1 of SOLAS was adopted by Res. MSC. 291(87) and entered into force, panel members agreed to remove the requirements of thickness measurements in cargo oil tanks (items 2 and 4) of Special Survey No.1 in the Table II, and agreed to collect data from members about the results of the SS1 of enough vessels with the conditions about wastage, deficiencies in the areas relevant to the survey items 2 and 4 of SS1 in the Table II of UR Z10s.

Totally, 157 Double Hull Oil Tankers were collected and members concluded that based on the analysis to the datas collected by IACS members, it is concluded that the requirements of thickness measurements in cargo oil tanks (items 2 and 4) of Special Survey No.1 in the Table II of UR Z10.3 and Z10.4 could be removed, after a submission to IMO to amend the relevant contents of ESP Code being adopted.

It was submitted to SDC 7 and adopted as MSC.Res.483(103).

- One survey panel member pointed out that the definition of ballast tanks in UR Z10s are different from other IACS Resolution (UR Z7/Z7.1/Z7.2) and ESP Code. Survey panel reviewed and agreed to change "solely" to "primarily" in UR Z10s.

No TB is expected for the present revision.

**.5 Other Resolutions Changes:**

None

**.6 Any hinderance to MASS, including any other new technologies:**

None

**.7 Dates:**

Original Proposal	: 01 March 2018	(Ref: PSU18011)
	28 January 2020	(Ref: PSU20004)
Panel Approval	: 11 April 2022	(Ref: PSU21024)
GPG Approval	: 03 May 2022	(Ref: 22043_IGb)

- **Rev.19 (May 2019)**

**.1 Origin of Change:**

- Suggestion by an IACS member

**.2 Main Reason for Change:**

This revision is to address the policy decision made by GPG using the common terminology 'Condition of Class'(CoC) instead of the terms 'Recommendation/Condition of Class' based on the outcome of III 5.

**.3 List of non-IACS Member classification societies contributing through the TC Forum and/or participating in IACS Working Group:**

None

**.4 History of Decisions Made:**

During the 29th panel meeting, the panel discussed about the comments of members, and concurred with the view to retain the present definitions of CoC in the IACS resolutions with the wording 'Recommendation' to be removed. The panel also agreed to use the term 'Statutory Condition' for the 'recommendation' of the statutory certificates in IACS resolutions and RECs, and when discussing the proposal of a member to consider the harmonization of the terms of 'recommendation' and 'condition of class' in RO Code, the panel unanimously agreed to take no action on the IMO instruments, leaving the relevant actions to be decided by the relevant IMO bodies when IACS feeds back to IMO the IACS action on the harmonization of the two terms.

Panel members concurred with the view that it is not necessary to develop a new procedure requirement, and agreed to set the implementation date of these IACS resolutions (other than RECs) as 1st July 2020.

Before the implementation date of 1st July 2020 for using the common terminology 'Condition of Class' only, 'Recommendations' and 'Condition of Class' are to be read as being different terms used by Societies for the same thing, i.e. requirements to the effect that specific measures, repairs, surveys etc. are to be carried out within a specific time limit in order to retain Classification.

No TB is expected for the present revision.

**.5 Other Resolutions Changes:**

The following IACS resolutions and Recommendations (RECs) were agreed to be revised:

- Procedural Requirements: PR1A, PR1B, PR1C, PR1D, PR1 Annex, PR3, PR12, PR20, PR35 and the attachment of PR16;
- Unified Requirements: Z7, Z7.1, Z7.2, Z10.1, Z10.2, Z10.3, Z10.4, Z10.5, Z15 and Z20
- Unified Interpretations: GC13
- Recommendations: Rec.41, Rec.75, Rec.96, Rec.98

**.6 Any hinderance to MASS, including any other new technologies:**

None

**.7 Dates:**

Original Proposal: 14 January 2019 tasked by GPG (17044bIGm)

Panel Approval: 22 March 2019 (PSU19010)

GPG Approval: 30 May 2019 (17044bIGu)

**• Rev.18 (Jan 2018)**

**.1 Origin of Change:**

- Suggestion by IACS members

**.2 Main Reasons for Change:**

To address the FUA 11 of C73, raised by the Council of the IACS in respect to the future work directions on the implications of new technology on survey regime. A revision of UR Z10.3 is in order to consider the new technologies on Remote Inspections (RIT).

In order to introduce new provisions into the ESP Code which were found among the ESP Code and relevant URZ10s, a series of items of UR Z10s shall be amended accordingly with ESP Code.

**.3 List of non-IACS Member classification societies contributing through the TC Forum and/or participating in IACS Working Group:**

None

**.4 History of Decisions Made:**

Members discussed under Panel task PSU16056 the issue allocated by GPG on 21th October 2016. The subject deals with the review of the UR and Recommendation under Panel responsibility in order to determine whether a revision could need in order to consider the new technologies on Remote Inspections (RIT). The Panel Members concurred to discuss the possible revision of the UR Z10.3 in order to address the issue.

Panel agreed the revised paragraph 1.5 and 5.3.3. In addition, a new paragraph 1.2.15 with definition of RIT was agreed and inserted in the present revision of UR Z10.3.

Panel members discussed this issue under PSU17018 about the proposals of: deleting the superseded Table and renumbering the current table; "Thickness measurement company" was to be replaced with "Thickness measurement firm" throughout the UR; some paragraphs were to be revised for the alignment with other UR Z10s; etc.



During the 26<sup>th</sup> Survey Panel Meeting, the Panel discussed the divergence and reached agreements with the revisions.

No TB is expected for the present revision.

## **.5 Other Resolutions Changes**

UR Z10.1, UR Z10.2, UR Z10.4, UR Z10.5, UR Z3, UR Z7, UR Z17

## **.6 Dates:**

Original Proposal: 22 October 2016 by a Survey Panel Member

Panel Approval: 24 December 2017 by Survey Panel (Ref: PSU16056 & PSU17018)

GPG Approval: 15 January 2018 (Ref: 17189\_IGc)

## **• Rev.17 (Feb 2015)**

### **.1 Origin of Change:**

- Suggestion by IACS members

### **.2 Main Reasons for Change:**

- a) To consider appropriate text in IACS document regarding the applicability of the Thickness Measurements when the Close up survey is performed.
- b) Modification of Table II MINIMUM REQUIREMENTS FOR THICKNESS MEASUREMENTS AT SPECIAL SURVEY FOR CHEMICAL TANKERS
- c) Modification of the wording of note 7 in table I.2 as appropriate, in order to consider also the structures associated to corrugated bulkheads.
- d) To specify the minimum content of the Tank Testing guideline cited at paragraph 2.5.1.bullet a).

### **.3 List of non-IACS Member classification societies contributing through the TC Forum and/or participating in IACS Working Group:**

None

### **.4 History of Decisions Made:**

- a) Following an ACB query an IACS member proposed to add suitable text in appropriate IACS documents regarding the application of the Thickness Measurements when the close up surveys are performed as survey requirement due at the Intermediate/ Renewal Class surveys. This Member expressed the view that the requirements to execute the Thickness Measurements of the area subject to Close Up Surveys are expected into the table relevant to "MINIMUM REQUIREMENTS FOR THICKNESS MEASUREMENTS AT SPECIAL SURVEY ....." while the paragraph 1.4 of the document contains only the requirement that "Thickness Measurements of the areas subject to close up surveys shall be taken in conjunction with the close up survey".

Panel discussed the matter under item PSU13051 and considered that wordings of Para 1.4 of current UR Z7s/10s need to be revised in order to clarify the issue.

- b) An IACS member noted that table II relevant to "MINIMUM REQUIREMENTS FOR THICKNESS MEASUREMENTS AT SPECIAL SURVEY FOR CHEMICAL TANKERS" did not recalled correctly the tables of the close up surveys. In fact the table II was recalling generically table I while it should be necessary specify table I.1 table I.2 as applicable, being two separate tables for Chemical tankers and Double Hull Chemical Tankers in the UR Z10.3. According to the highlight Member proposed the modification of table II of UR Z10.3
- c) An IACS Members proposed to modify the note 7 of table I.2 relevant to the structure of the longitudinal bulkheads in order to consider also the case where corrugated bulkheads are fitted. Being the structural arrangement of the corrugated bulkhead quite different from that of the plain bulkheads, the wording "longitudinal bulkhead vertical girder" was applicable only to plain bulkhead being the vertical girder not existing or differently realised for the corrugated type. Panel agreed to modify the wording from the existing one to "longitudinal bulkhead structural members".
- d) An IACS Member following the discussion of PSU 14017 (relevant to the drafting of a Guidelines for Master tank testing) proposed to improve the content of the bullet a) of paragraph 2.5.1 of the UR by inserting the description of the minimum requirements that need to be specified inside the "Cargo Tank Testing Procedure" to be used when Master of a Tanker is allowed to perform the cargo tank testing. Panel concurred with the proposal (ref, message PSU14017...ISUc).

Considering items a), b) c) and d) Panel agreed

- 1) to add additional wording to Para.1.4;
- 2) to modify table II of UR Z10.3
- 3) to modify note 7 of table I.2
- 4) to modify sentence of bullet a) of paragraph 2.5.1. as follow:

"a tank testing procedure, specifying fill heights, tanks being filled and bulkheads being tested, has been submitted by the owner and reviewed by the Society prior to the testing being carried out";

## **.5 Other Resolutions Changes**

- i) The amendment a) affects UR Z7, UR Z7.1, UR Z7.2, UR Z10.2, UR Z10.4, UR Z10.4 and UR Z 10.5.
- ii) The amendment c) affects also UR Z10.4
- iii) The amendment d) affects also UR Z10.1, UR Z10.5

## **.6 Dates:**

Panel Approval: Amendment a) and b) at 19th Survey Panel Meeting (6 March 2014).  
Amendment c) by correspondence under PSU13051  
Amendment d) on 29 July 2014 by correspondence under PSU14017

• **Rev.16 (Jan 2014)**

**.1 Origin of Change:**

- Suggestion by IACS members
- Suggestion by GPG

**.2 Main Reason for Change:**

- a) To consider appropriate text in IACS document regarding class period for lengthy conversions.
- b) To align the difference between PR37 and URZ's regarding safe entry to confined spaces.

**.3 List of non-IACS Member classification societies contributing through the TC Forum and/or participating in IACS Working Group:**

None

**.4 History of Decisions Made:**

- a) With reference to IMO Res. A1053 (27) (5.5 Application of "special circumstances") an IACS member proposed to add suitable text in appropriate IACS document regarding class period for lengthy conversions. This Member expressed that when a renewal survey has been completed, the new 5 year class period would normally be calculated from the expiry of previous class period/class certificate and in some cases this might result in unreasonably short time from one renewal survey completion until the next renewal would be due.

Panel discussed and considered that wordings of Para 2.1.3 of current UR Z7s/10s (second sentence) could address this issue but finally agreed to add additional text to Para 2.1.3 in order to clarify this matter. (PSU13024)

- b) Panel discussed to clarify the survey requirements in PR37 and URZ's regarding safe entry to confined spaces. Panel considered that the safety issues of surveyor should be dealt by PR37. At 18<sup>th</sup> Panel meeting, Panel concluded to delete requirements from UR Z10s which were already covered by the PR37. (PSU13032)

**.5 Other Resolutions Changes**

- a) The identical amendment affects UR Z7, UR Z7.1, UR Z7.2, UR Z10.1, UR Z10.2, UR Z10.4 and UR Z 10.5.
- b) The identical amendment affects UR Z10.1, UR Z10.2, UR Z10.4 and UR Z 10.5.

**.6 Dates:**

Panel Approval: 7 November 2013 by Survey Panel

• **Rev.15 (May 2013)**

**.1 Origin of Change:**

- Suggestion by an IACS Member
- Suggestion by GPG in response to the request of EG/SoS

**.2 Main Reason for Change:**

- a) An inquiry from a member whether the 'Other equivalent means' referred in Para 5.3.2 of IACS UR Z10.2 include the use of Cherry Pickers for survey of other structures. (PSU 12022)
- b) To introduce provision in UR Z10s that Rescue and emergency response equipment must be suitable for the configuration of the space being surveyed including the size of the access points.(PSU 12032, GPG 12138\_)
- c) To amend paragraph 2.5 to keep in line with the draft amended texts of UR Z10.1 and UR Z10.4.

**.3 List of non-IACS Member classification societies contributing through the TC Forum and/or participating in IACS Working Group:**

None

**.4 History of Decisions Made:**

- a) Discussion of this matter initiated by a Panel member regarding the use of Cherry Pickers in Cargo Holds with reference of IACS URZ10.2. In accordance with UI SC191 and Rec 91, the Cherry Picker is allowed up to 17m height for Cargo Hold structure (ships constructed after 2006 for Alternative means of access). As per the provisions of URZ10.2, Cherry pickers are allowed for survey of side shell frames only.

Panel discussed and considered that Para 5.3.2 of UR Z10.2 allows the use of Cherry Pickers as 'Other equivalent means'. Accordingly, Panel agreed to clarify this matter by including text "hydraulic arm vehicles such as conventional cherry pickers" to UR Z10s and UR Z7s for a ship not subject to the above 17m restriction.

- b) GPG Chairman requested to consider the suggestion of EG/SoS to clarify the wording in UR Z 10.1 – 10.5 to make it compliance with draft PR37 submitted by EG/SoS.

The Survey Panel discussed this matter and introduced a new (sub-)section 5.5 "Rescue and emergency response equipment" in line with the suggestion of EG/SOS.

- c) A GPG member suggested to amend paragraph 2.5 to keep in line with the draft amended texts of UR Z10.1 and UR Z10.4 and this was agreed by GPG.

## **.5 Other Resolutions Changes**

- a) The identical amendment affects UR Z7, UR Z7.1, UR Z10.1, UR Z10.2, UR Z10.4 and UR Z 10.5
- b) The identical amendment affects UR Z10.1, UR Z10.2, UR Z10.4 and UR Z 10.5
- c) The identical amendments affects UR Z10.1 & URZ10.4

## **.6 Dates:**

Panel Approval: 7 March 2013 during Survey Panel Meeting  
GPG Approval: 22 May 2013 (Ref: 9640\_IGn)

## **• Rev.14 (August 2012)**

### **.1 Origin of Change:**

- Suggestion by an IACS member

### **.2 Main Reason for Change:**

To modify the figures showing areas for close up surveys, i.e. Fig.2.1, 2.2 and Fig. 3.1-3.3 in Rev.13, as they are different from typical transverse sections of chemical tankers.

### **.3 List of non-IACS Member classification societies contributing through the TC Forum and/or participating in IACS Working Group:**

None

### **.4 History of Decisions Made:**

A member pointed out that figures showing areas for close up surveys, i.e. Fig.2.1, 2.2 and Fig. 3.1-3.3 seem not to be suitable for chemical tankers because they are different from typical transverse sections of chemical tankers. The member proposed that the above-mentioned figures should be modified to show typical transverse section of chemical tanker such as Fig. 6 of UR Z11, in order to avoid any confusion.

Survey Panel developed the updated the figures and submitted the corrected UR for GPG approval.

GPG agreed to consider this is a revision with an implementation date of 1 July 2013 to provide members with sufficient time to complete the UR implementation process.

## **.5 Other Resolutions Changes**

None

## **.6 Dates:**

Original Proposal: *19 July 2011 Made by a Member*  
Panel Approval: *26 June 2012*

- **Rev.13 (July 2011)**

**.1 Origin of Change:**

- Suggestion by an IACS member

**.2 Main Reason for Change:**

Following external audit a member was advised that a small temporary doubler on a cross-deck strip of a bulk carrier should have been promptly and thoroughly repaired at the time of survey. The member carried out an investigation and found that the actions of the surveyor were fully justifiable, the temporary repair and short term Condition of Class imposed were an appropriate method of dealing with such a situation. The member advised that the current requirements for 'Prompt and Thorough Repair' stipulated under the UR 7 and UR 10 series do not give any leeway for carrying out temporary repairs (and imposing a Recommendation/Condition of Class in accordance PR 35) where the damage in question is isolated and localised, and in which the ship's structural integrity is not impaired.

The Survey Panel discussed the matter and agreed that under carefully defined circumstances a temporary repair and short term Recommendation/Condition of Class would be an appropriate course of action.

Also, Table I was split to into 2 tables for enhanced clarity, Table I.1 for Single Skin and Table I.2 for Double skin ships and miscellaneous editorial errors in the Table I.1 and I.2 are corrected.

**.3 List of non-IACS Member classification societies contributing through the TC Forum and/or participating in IACS Working Group:**

None

**.4 History of Decisions Made:**

The matter was discussed by correspondence within the Survey Panel and at the Autumn 2010 Panel Meeting. Following discussion at which the possibility of a Unified Interpretation being raised was considered, it was eventually decided to make direct amendment to the relevant Unified Requirements.

The wording of the new paragraph to be inserted as Para 1.3.3 in all relevant Unified Requirements was extensively discussed prior to agreement.

The proposal was unanimously agreed by Survey Panel Members.

**.5 Other Resolutions Changes**

The identical amendment affects UR Z7, UR Z7.1, UR Z7.2, UR Z10.1, UR Z10.2, UR Z10.3, UR Z10.4 and UR Z 10.5.

## **.6 Dates:**

Original Proposal: *September 2010 Made by a Member*

Panel Approval: *March 2011*

GPG Approval: *28 July 2011 (Ref: 10079aIGe & 11118\_IGb)*

## **• Rev.12 (Mar 2011)**

### **.1 Origin for Change:**

- Suggestion by IACS member

### **.2 Main Reason for Change:**

1) Due to the fact that the figures showing areas for close-up survey were deleted in Rev.10 of UR Z10.3 and that Table I of UR Z10.3 only has references to zones marked as A-D which are covered by the figures shown in UR Z10.1, references to zones 1-7, as shown in URZ10.4, should be added to Table I of UR Z10.3.

2) Inconsistency of the definition of transverse section of the ship given in UR Z7 and UR Z10s.

3) Update of references in the Executive Hull Summary Table IX.

### **.3 List of non-IACS Member classification societies contributing through the TC Forum and/or participating in IACS Working Group:**

None.

### **.4 History of Decisions Made:**

Items 1) and 2) were proposed by RS and item 3) was proposed by GL. All amendments were agreed by the Panel.

### **.5 Other Resolutions Changes**

UR Z10.1, Z10.2, Z10.4 and Z10.5.

## **.6 Dates:**

Original Proposal: *January 2010, made by Survey Panel*

Survey Panel Approval: *July/November 2010*

GPG Approval: *24 March 2011 (Ref: 10170\_IGe)*

## **• Rev.11 (Mar 2009)**

Survey Panel Task 62 - *Harmonization of UR Z10s to UR Z10.3(Rev.10).*

See TB document in Part B.

- **Rev.10 (Dec 2008)**

Survey Panel Task 55 – *Harmonization of UR Z10.3 to UR Z10.4.*

See TB document in Part B.

- **Rev.9 (Nov 2007)**

Survey Panel Task 1 – *Concurrent crediting of tanks.*

See TB document in Part B.

- **Rev. 8, Corr.1 (Sept 2006)**

Correction to Table III.

No TB document available.

- **Rev.8 (Jan 2006)**

Survey Panel Task 22 – *Amend applicable URZ7s and Z10s to align Close-Up Survey and Thickness measurements to be carried out at the same time and location allowing for a more structured control of the thickness measurement process – plus additional changes relating to access for rafting surveys.*

See TB document in Part B.

- **Rev.7 (Jun 2005)**

WP/SRC Task 102 - *Harmonization of UR Z7s and Z10s*

See TB document in Part B.

- **Rev.6 (Oct 2002)**

WP/SRC tasks 91, 93 and 95.

No TB document available.

- **Rev.5 (Mar 2002)**

Comparable amendments to Z10.3 based on Z10.1(Rev.9) (ref. WP/SRC Task 87 – *Amend Z10.1 & 10.2 to reflect changes introduced to Res A.744 by MSC 73*)



See TB document in Part B.

- **Rev.4.1 (Jun 2001)**

Clarification of Section 2.3.1.

See TB document in Part B.

- **Rev.4 (Nov 2000)**

Incorporation of outcome of WP/SRC Task 77 “prompt and thorough repairs” into UR Z10.2.

See TB document in Part B.

- **Rev.3 (Sept 2000)**

WP/SRC Tasks 49 and 62, and introduction of Extraordinary Council Meeting (Feb 2000) decisions into UR Z10.2.

See TB document in Part B.

- **Rev.2 (July 1999)**

Revised according to amendments to Res A.744(18).

No TB document available.

- **Rev.1 (1997)**

Update to the applicability of UR Z10.3.

No TB document available.

- **New (1996)**

No TB document available.

## **Part B. Technical Background**

List of Technical Background (TB) documents for UR Z10.3:

Annex 1. **TB for Rev.3 (Sept 2000)**

See separate TB document in Annex 1.

Annex 2. **TB for Rev.4 (Nov 2000)**

See separate TB document in Annex 2.

Annex 3. **TB for Rev.4.1 (Jun 2001)**

See separate TB document in Annex 3.

Annex 4. **TB for Rev.5 (Mar 2002)**

See separate TB document in Annex 4.

Annex 5. **TB for Rev.7 (Jun 2005)**

See separate TB document in Annex 5.

Annex 6. **TB for Rev.8 (Jan 2006)**

See separate TB document in Annex 6.

Annex 7. **TB for Rev.9 (Nov 2007)**

See separate TB document in Annex 7.

Annex 8. **TB for Rev.10 (Dec 2008)**

See separate TB document in Annex 8.

Annex 9. **TB for Rev.11 (Mar 2009)**

See separate TB document in Annex 9.

Annex 10. **TB for Rev.12 (Mar 2011)**

See separate TB document in Annex 10.

Annex 11. **TB for Rev.13 (July 2011)**

See separate TB document in Annex 11.

Annex 12. **TB for Rev.16 (Jan 2014)**

See separate TB document in Annex 12.

**Note:** *There are no separate Technical Background (TB) documents for the original resolution (1996), Rev.1 (1997), Rev.2 (July 1999), Rev.6 (Oct 2002), Rev.8, Corr.1 (Sept 2006), Rev.14 (Aug 2012), Rev.15 (May 2013), Rev.17 (Feb 2015), Rev.18 (Jan 2018), Rev.19 (May 2019), Rev.20 (May 2022) and Rev.21 (Aug 2023).*

**Technical Background Document  
UR Z10.3 – Revision 3  
For ExCM decisions**

**Objective and Scope:**

Revise UR Z10.3 to introduce ExCM (Extraordinary Council Meeting in Feb 2000) decision to UR Z10's

- ExCM FUA 2-1: All ballast tanks adjacent to cargo tanks with heating coils shall be examined internally on an annual basis after the ship has reached 15 years of age.
- ExCM FUA 2-2: Intermediate surveys of ships subject to ESP, which are over 15 years of age, will be enhanced to the scope of the preceding special survey with dry docking or under water survey as applicable.

**Source of Proposed Requirements:**

The proposed requirements were developed by WP/SRC Chairman, shortly after GPG 48<sup>th</sup> meeting:

- The para. 3.2.5.2 for ExCM FUA 2-1:
- The para. 4.2.2, 4.2.3 & 4.2.4 for ExCM FUA 2-2.
- The paragraph 7.1.1 for compatibility with the PR 19 (ABS GPG proposed)

**Points of Discussion:**

-

**Unresolved Comments:**

-

**Discussions:**

WP/SRC Chairman, when submitting draft revision to GPG, raised the following concerns:

- What tanks are required by the term "ADJACENT" ?

WP/SRC Chairman said that tanks with a common line boundary have not been a problem since there is very little transfer of heat and should not be included.

GPG exchanged views on this point and agreed to delete the wording "or line" from the para. 3.2.5.2 which reads: Oil Tankers exceeding 15 years of Age: All Ballast Tanks adjacent to (i.e., with a common plane ~~or line~~ boundary) a cargo tank with heating coils is to be examined internally.

- Identify tanks with heating coils

WP/SRC Chair said that the vessel's survey status does not tell us tanks fitted with heating coils.

- Coating Condition and Substantial Corrosion Survey Requirements

Ballast tanks with poor coating, no coating or substantial corrosion identified at a previous survey already requires annual survey. With enhanced intermediate survey, all

Submitted by the Permsec  
On 19 July 2000

ballast/cargo tanks will be examined and gauged at special/intermediate survey and coating condition & substantial corrosion should be identified at that time. If coating condition is reported good or fair, it may be adequate to only verify the coating condition at annual survey of ballast tanks adjacent to cargo tanks fitted with heating coils.

In addition, DNV and LR (GPG) proposed the following additions:

- The 3<sup>rd</sup> sentence in para. 3.2.5.2 (DNV):  
“Tanks or areas where coating was found to be in GOOD condition at the previous intermediate or special ~~internal examination are to~~ survey may be be specially considered by the Classification Society.”  
The majority GPG agreed.
- The second half of the para. 4.2.4.1(LR)  
“except that testing of cargo and ballast tanks is not required unless deemed necessary by the attending surveyor.”  
The majority GPG agreed.
- The paragraph 7.1.1 of Z10.1 and Z10.3, paragraph 8.1.1 of Z10.2 were revised for their compatibility with the PR 19 “PR for Thickness Measurement”.

-----

Submitted by the Permsec  
On 19 July 2000

**Technical Background Document**  
**WP/SRC Task 77**  
**UR Z7 – Proposed Draft Revision 7**  
**(Including Rev.8 of Z10.1, Rev.11 of Z10.2, Rev.4 of Z10.3)**

**Objective and Scope:**

Extend the requirements for permanent repairs at the time of survey in UR Z 10.2 to all ships.

**Source of Proposed Requirements:**

The proposed requirements were developed by WP/SRC members through correspondence and discussions at the September 2000 meeting.

**Points of Discussion:**

UR Z7 was amended to apply “prompt and thorough” repairs to all vessels. The new wording defines a prompt and thorough repair to be a repair as a result of wastage and not an incident such as contact damage where a temporary repair or deferral of repairs could be permitted. This wording is more explicit than the wording in UR Z10.2 and should achieve a uniform application among the Members.

WP/SRC also agreed to include these requirements in Z10.1, Z10.2 and Z10.3 in order to not effect A.744(18).

WP/SRC unanimously agreed to the draft UR.

Note by Permsec

GPG 49 (11-13 Oct. 2000) agreed that the same changes be introduced to Z10's and carried out editorial review of Z 10's.

**Technical Background Document**  
**WP/SRC Task 75**  
**UR Z10.1 – Proposed Draft Revision 8**  
**&**  
**Z10.3 – revision 4**

**Objective and Scope:**

Develop a definition of 'related piping' as contained in UR Z10.1 and requirements for survey.

**Source of Proposed Requirements:**

The proposed requirements were developed by WP/SRC members through correspondence.

**Points of Discussion:**

The proposal limits the definition of "related piping" to the piping systems which require testing. This will not include hydraulic oil piping for remote control valves or anchor/mooring equipment which OCIMF may have wanted included. WP/SRC feels that related piping systems are those that are unique to an oil carrier and was the original intent of the wording.

WP/SRC unanimously agreed to the draft UR.

**Note by the Permsec:**

LR GPG proposed to change Z10.1 as follows:

“piping systems for the handling of cargo / cargo residues and water ballast and additionally bilge systems in combination carriers. 8220iLRa, 30/8/2000”

GPG Chairman asked WP/SRC to discuss LR's proposal to include “bilge piping systems” in Z10.1 at their 2000 September meeting.

WP/SRC Chairman reported back to GPG on 22 September 2000 as follows:

1. "Cargo piping" adequately covers and is understood by all members to include cargo stripping piping, just as "Ballast piping" includes ballast stripping piping.
2. WP/SRC is of the opinion that bilge piping on combination carriers should not be added to the proposed revision due to the fact that it is a separate system which usually run through a pipe tunnel and is not hydro tested at new construction. The system also operates on a vacuum and is blanked off when oil is carried.

Therefore, WP/SRC maintains its agreement that the previously submitted text is the preferred by all members.

GPG agreed that a similar amendment be made to Z10.3.

Based on the above discussion at GPG level, the revised of Z10.1 and Z10.3 was finally approved at GPG 49.

Submitted by WP/SRC Chairman

On 27 July 2000

(This view was shared by the majority of GPG Members, however, it has not been codified in Z 10.1 because no need was identified to prescribe it as a Unified Requirement.)

- Identify tanks with heating coils

WP/SRC Chair said that the vessel's survey status does not tell us tanks fitted with heating coils.

- Coating Condition and Substantial Corrosion Survey Requirements

Ballast tanks with poor coating, no coating or substantial corrosion identified at a previous survey already requires annual survey. With enhanced intermediate survey, all ballast/cargo tanks will be examined and gauged at special/intermediate survey and coating condition & substantial corrosion should be identified at that time. If coating condition is reported good or fair, it may be adequate to only verify the coating condition at annual survey of ballast tanks adjacent to cargo tanks fitted with heating coils.

In addition, DNV and LR (GPG) proposed the following additions:

- The 3<sup>rd</sup> sentence in para. 3.2.5.2 (DNV):

"Tanks or areas where coating was found to be in GOOD condition at the previous intermediate or special ~~internal examination~~ are to survey may (ABS' comment) be specially considered by the Classification Society."

The majority GPG agreed.

- The second half of the para. 4.2.4.1(LR)

"except that testing of cargo and ballast tanks is not required unless deemed necessary by the attending surveyor."

The majority GPG agreed.

- The paragraph 7.1.1 of Z10.1 and Z10.3, paragraph 8.1.1 of Z10.2 were revised for their compatibility with the PR 19 "PR for Thickness Measurement".

-----

Submitted by the Permsec  
On 18 Sept 2000



## Technical Background for

**Rev.8.1, Z10.1**

**Rev.11.1, Z10.2**

**Rev.4.1, Z10.3**

(21 June 2001)

### 1. Scope of objectives

Revise section 2.3.1 for clarity.

### 2. Points of discussions or possible discussions

- BV GPG member proposed to revise section 2.3.1 of Z10s on 12 June 2001 (0065j)
- IACS Council considered the ambiguity of the sentence in Special Survey section 2.3.1 "For Fuel Oil Tanks the necessity for the Overall Survey is to be determined based on the ship's age" in the context of its application at intermediate surveys on ships over 15 years. Council agreed that the overall survey of low corrosion risk tanks such as fuel oil, lube oil and fresh water tanks could be subject to special consideration as already addressed in section 2.2.5 of UR Z7 and therefore amended the first sentence of 2.3.1, accordingly, and deleted the last sentence of 2.3.1.
- Adopted on 21 June 2001.

\* \* \* \* \*

**Technical Background Document**  
**WP/SRC Task 87**  
**Amend Z10.1&10.2 to reflect changes introduced to Res A.744 by MSC 73**  
**(Z10.1, Rev.9) + (Z10.2, Rev.12) + (Z10.3, Rev.5)**

**Objective and Scope:**

To harmonise IACS UR Z10.1 and Z10.2 with IMO Res A744(18), as previously amended and as amended by IMO MSC105(73) and MSC 108(73).

These amendments enter into force 1 July 2002.

It was assumed by WP/SRC that the intention of GPG has been to revise UR Z10.3 (chemical tankers) as well with respect to the intermediate dry-docking requirement, but not to include the requirement to evaluation of longitudinal strength.

In addition, the relevant changes to UR Z10.1 based on the changes introduced in IMO Res A744(18) as reported in MSC 74/24/Add1-Annex 17 have been included. These were based on IACS submission DE 44/13/1. These amendments will enter into force 1 January 2004 subject to IMO tacit acceptance procedures.

**POINTS OF DISCUSSION:**

The Chairman of WP/SRC would further draw GPG's attention to paragraph 4.2.4.3, which contains the requirement to intermediate dry-docking for oil tankers exceeding 15 years of age. The corresponding Res.A 744(18) requirement (paragraph 2.2.2) does not link the dry-docking to the intermediate survey. This issue was discussed extensively by correspondence and during three WP meetings this year. A consensus decision was achieved without reservations from any members. This process was time consuming, hence the delay in submitting this document to GPG for approval. However, at the annual meeting of the WP in October 2001 all members agreed that we should not accept the wording of Res. A 744(18) paragraph 2.2.2, but instead require that the intermediate dry-docking is to be linked to the intermediate survey and include a requirement to carry out surveys and thickness measurements of the lower portions of the tanks for oil tankers. (similarly, cargo holds/water ballast tanks for bulk carriers)

GPG is advised to note that the proposed requirement in paragraph 4.2.4.3 may result in a third dry-docking within the 5-year period of the classification certificate in case that a dry-docking is carried out prior to the window for intermediate survey.

The Chairman of WP/SRC suggests that GPG approves UR Z10.1 with high priority and allows PermSec in the meantime to start the work to amend and typeset UR Z10.2 and URZ10.3 with respect to the intermediate dry-docking requirement, as well as introducing the appropriate changes to UR Z10.2 and UR Z10.3 with respect to MSC 74/24/Add 1-Annex 17.

Note:

1. GPG tasked WP/SRC to review dry-docking survey requirements in Z10.2-4 and Z3 to harmonize them with those in Z10.1 (Rev.9) and reflect in Z3 the interim application of bottom survey requirements as introduced in MSC/Circ. 1013 (Res A.746(18)).  
Task 101, Target 2Q-2002
2. GPG confirmed (s/n 1060c) that 7.1.3 of A.744(MSC 74/12/Add.1/Annex 17/page 6), as quoted below, should not be included in Z10s.  
“7.1.3 Thickness measurements are to be carried out within 12 months prior to completion of the periodical survey or of the intermediate survey.”  
**Reason:** The above sentence will restrict the 15 month and 18 month survey window for TM during the intermediate and special surveys respectively.
3. GPG confirmed that 7.1.4 of A.744(MSC 74/12/Add.1/Annex 17/page 6), as quoted below, should not be included in Z10s:  
“7.1.4 In all cases the extend of the thickness measurements should be sufficient as to represent the actual average condition.”  
**Reason:** No compelling need, in view of MSC 74/12/Add.1 being adopted by MSC 75(May 02). IACS will live with this not harmonized sentence.
4. For IACS Council decisions to improve bulk carrier safety, see the TB for Revision 12 of Z10.2.

Submitted by WP/SRC Chairman

**WP/SRC Task 102**  
**HARMONIZATION OF UR Z7s AND Z10s**

**Technical Background**

**UR Z7 (Rev. 11)**

**UR Z7.1 (Rev. 2)**

**UR Z10.1 (Rev. 12)**

**UR Z10.2 (Rev. 17)**

**UR Z10.3 (Rev. 7)**

**UR Z10.4 (Rev. 2)**

**UR Z10.5 (Rev. 1)**

Contents:

TB for Harmonization

**Annex 1.** TB for UR **Z10.1(Rev.12**, C49 amendments(coating-related))

**Appendix 1:** Memo for Coating, submitted to Council  
49(June 2004).

**Appendix 2:** DNV proposal (25 May 2005) agreed by Council

**Annex 2.** TB for "Verification/Signature of TM Forms" for records.

**Annex 3.** TB for revision of UR Zs concerning "anodes".

**1. Objective**

To amend UR Z7s and Z10s in order to make the texts of the above-mentioned URs consistent eliminating all the differences both in substance and in wording (WP/SRC Task 102).

**2. Background**

In the process of approving UR Z10.4, GPG found it necessary to amend the other existing URs Z10.1, Z10.2, Z10.3, Z10.6 and Z7 in order to eliminate any inconsistencies existing among them.

**3. Methodology of work**

The WP has progressed its work through many sessions, both during the periodical meetings and dedicated meetings restricted to a Small Group of Members (BV, DNV, GL, LR, RINA) who developed the work in order to be more efficient. All the proposed amendments of the Small Group have regularly been circulated to all Members for comment and agreement.

## 4. Discussion

4.1 The WP/SRC has completed a comprehensive comparative review of UR Z7 and Z10s, and identified inconsistencies which existed among them. During this review, attention was given to the severity of the requirements applicable to the same spaces/structural areas on different types of ESP ships. As a result, the inconsistencies were eliminated making the URZs harmonized. However, there has been no change to the scope and extent of the survey requirements.

4.2 The starting point for each UR was the most updated version available at the time of commencement. Any revision to the URZs, which were introduced during this task, was taken into account. As for instance, the UR Z10.1 was initially amended based on Rev. 9, while the last amendments are based on Rev. 11 and the UR Z10.2 was initially amended based on Rev. 13, while the last amendments are based on Rev. 16. The proposed revisions of URs Z10.1 and Z10.4 have not been numbered, as there will be revisions to those URs before the revisions introduced by the Task 102 are adopted. In fact, GPG is currently developing a Revision 12 of Z10.1 with the view to introducing significant improvements in the survey regime for ballast tanks (including combined cargo/ballast tanks) of oil tankers and UR Z10s applicable to oil tankers will also have to be revised by incorporating the amendments to A.744(18) contained in Resolution MSC 144(77), which enter into force 1 January 2005 (see 4.3 below).

4.3 Also, in harmonizing UR Z10.1 and Z10.2 care has been taken to align the corresponding text with that of IMO Res. A.744(18). However, it has been noted that the amendments to A.744(18) contained in Resolution MSC 144(77), which enter into force 1 January 2005, have not been incorporated into the IACS UR Z10s applicable to oil tankers. It seems that the updating of the above-said UR Z10s will be done by the Perm Sec and reviewed by the WP/SRC Chairman and then circulated for adoption by GPG with concurrence of Council Members for uniform application from 1 January 2005. It is understood that the revisions of the UR Z10s affected by those amendments will not include the changes introduced by the Task 102, as the implementation date proposed for those changes is 1 January 2006 (see below **6. Implementation**).

4.4 In the course of the work the WP has been developing for more than two years, several additional Tasks were assigned to the WP by GPG which affected the development of Task 102. The additional tasks which have been taken into account are the following:

- 1) In the course of Council discussion on UR Z10.6 (General Cargo Ships), certain inconsistencies were identified between Z10.6 and other Z10s. WP was instructed to expedite Task 102 (1060gIAa, 12 June 2002);
- 2) WP was instructed to include "Survey Planning for Intermediate Survey" into harmonization work (2108\_IAa, 12 July 2002);
- 3) GPG instructed WP to consider whether Z10.6 should be re-assigned as Z7.1, in connection with the harmonization work. 1060gIAb, 20 Sept 2002.

- Z7.1 developed;
- 4) Partial outcome (Z7 and Z7.1) was submitted to GPG on 17 July 2003(1060g). Council decided that approval of Z7(Rev.10) and Z7.1(Rev.2) is postponed until the harmonization is completed (1060gICb, 6 April 2004);  
[Council Chairman instructed WP/SRC to Members' comments on the draft revision of UR Z7 and Z7.1 \(collected under s/n 1060g, 1060gNKi \(30/03/2004\) in particular\) on 6 April 2004.](#)
  - 5) GPG tasked WP to include the amendments to Z10.2 / Z11 (BCs with hybrid cargo hold arrangements), deleting sheets 15 and 16 for ore carriers, into the harmonized UR Z10s (2212aIGa, 19 Jan 2004);
  - 6) GPG tasked WP to consider whether the requirements relevant to examination of Fuel Oil Tanks in the cargo area at each Special Survey should be put into Z10s, and internal examination of FOT at Intermediate Survey after SS 2 is needed. (1060gIAf, 30 Jan 2004);
  - 7) GPG tasked WP to harmonize tank testing requirements in Z7s and Z10s. (3006IIAa, 5 April 2004);
  - 8) GPG tasked WP with Task 108 - Develop uniform survey requirements for air vent pipes including the welded connection to deck. Z22 developed. GPG instructed WP to incorporate Z22 into the harmonized Z10s;
  - 9) GPG tasked WP with Task 114 - Verification and signature of TM reports. REC 77(Rev.1) developed and approved on 29 July 2004. Council approved parallel amendments to Z7.1 and Z10s (TM Forms included) and instructed WP to incorporate these into the harmonized Z10s:
    - [Recommendation No.77 was revised \(Rev.1, July 2004\);](#)
    - [Z7.1 para.6.3.2 and Z10s para.7.3.2 so amended.](#)
    - ["Surveyor's signature" is deleted from all TM Forms in Z10s;](#)
    - [A note is added to Annex II\(Z10s\) declaring that Annex II is recommendatory.](#)

WP/SRC's investigation into Members' practice in dealing with verification and signature of TM reports is annexed for record keeping purpose. [See Annex 2.](#)
  - 10) GPG tasked WP to consider the BV comments on "TM may be dispensed with..." and include the findings into the harmonized Z10s ( 2219iIAa, 7 April 2004).

## **5. Agreement within the WP/SRC**

All Members have unanimously agreed the attached final versions of UR's.

## **6. Implementation**

WP/SRC is of the view that the Members need 12 months from the adoption date to implement these amendments into their class rules. Assuming Council adoption in December 2004, WP/SRC would propose January 2006 as implementation date.

- Annex 1:** TB for UR Z10.1(Rev.12, C49 amendments, see Permsec's note 1 below)  
**Annex 2:** WP/SRC Task 114, verification and signature of TM reports(see 9 above).  
**Annex 3:** TB for revision of UR Zs concerning "anodes".

### **Note by the Permanent Secretariat**

1. Annex 1 to this TB contains background for amendments to UR Z 10.1(Rev.12) relating to FAIR/POOR/GOOD (C49 amendments). Council at its 49<sup>th</sup> meeting (June 2004) agreed/decided that comparable changes should be added to Z10.3 and Z10.4.

2. Appendix 3 "TM sampling method" has been added to UR Z10.1 and Z10.4 to keep them consistent with IMO Res.MSC.144(77). The amendments to A.744 contained in MSC.144(77) entered into force on 1 January 2005. (*GPG s/n 4181*)

Under s/n 4072g, paragraph **2.4.6** of UR Z10.1 and **2.4.6** and of UR Z10.4 (paragraph numbering is now harmonized) were amended in order to provide a link between the main text of the UR Z10.1 and 10.4 and the new Annex III Appendix 3 containing the MSC Res.144(77).

Further, it was agreed that the requirements for evaluation of longitudinal strength of the hull girder (as written in MSC.144(77)) should not be required for Intermediate Survey unless deemed necessary by the attending Surveyor. This is covered in 4.2.3.1 and 4.2.4.1 of Z10.1 and Z10.4.

3. GPG agreed that the amended UR Zs should be implemented from 1 July 2006 altogether.

4. DNV's proposed amendments to UR Z10.1, Z10.3 and Z10.4 concerning annual survey of ballast tanks were agreed by Council (1060gICq, 27 June 2005). See Appendix 2 to Annex 1.

5. Annex 3 contains a TB for revision of UR Zs concerning "anodes".

Date: September 2004  
Prepared by the WP/SRC

-- --

## **Annex 1 to Technical Background**

### **UR Z 10.1 (Rev.12, C49 amendments(coating-related))**

#### **1. Objective**

To introduce significant improvements in the survey regime for ballast tanks (including combined/ballast tanks) of oil tankers as matter of strategic concern and urgency to IACS, given the aging of both the single and double hull tanker fleets and the problems encountered with corrosion of ballast tanks in several shipping casualties.

#### **2. Background**

Draft amendments to UR Z10.1 were submitted to Council 47 (June 2003) and agreed in principle.

#### **3. Discussion**

There was particular concern over accelerated corrosion with age (as the thinner the material, the more rapidly the allowable diminution margin percentage disappears) especially where coatings have broken down. There is also a disincentive for any spend on maintenance of the structure of a ship within a few years of its statutory scrapping date.

Council discussion by correspondence had evolved to the position of substantive proposals – summed as follows (3095\_ABa, 2 June 2003):

1. Enhance the Intermediate Survey in Z10.1, Z10.3 and 10.4 for Tankers after 2<sup>nd</sup> Special / Renewal Survey to the same level (scope of work) as the preceding Special / Renewal Survey). This corresponds to the latest revision to UR Z10.2.
2. At Annual Survey of ballast tanks with substantial corrosion, the overall survey is to be replaced by close-up survey with thickness measurements of the exposed area.
3. Proposed to task WP/SRC to re-consider the acceptance criteria for the rating FAIR further. For this, eliminate FAIR, leaving only GOOD and POOR redefined as appropriate.
4. Proposed to task WP/SRC to explicitly require close-up survey of Suspect Areas identified at the previous Special Survey.

Council 47 discussed the proposals(June 2003) as follows:

##### **1. Definition of FAIR**

Council 47 agreed that “FAIR” would be retained as a rating and that GPG should instruct WP/SRC to redefine FAIR, so that there would be a clear differences between FAIR, POOR and GOOD. It was also agreed that for oil tankers the Intermediate Survey following Special Survey No.2 would have the same scope as Special Survey No.2(Z10.1). WP/SRC should also clarify the definition of satisfactory repair.

Based on the strong majority, Council agreed to discuss with Industry annual surveys of ballast tanks when coating is found in LESS than GOOD condition at special survey, with the objective to encourage the owner to carry out repairs and maintenance of coating to GOOD condition.

*DNV and NK stated that they could not accept a requirement for annual surveys of ballast tanks when the coating condition is less*



*than GOOD and proposed that GOOD be changed to FAIR (3095\_IGc, 30 June 2003)*

2. ABS' proposed amendments to Z10.1(annual examination of BWTs in certain conditions) were approved.
3. C 47 agreed that the BWT coating requirements (Z10.1.2.2.3) for intermediate Survey after SS 2 should be the same extent to the previous SS.
4. Given the substance of the changes, the revised Z10.1 should be shown to Industry before adoption.
5. A guidance for coating repairs needs to be developed by WP/SRC with reference to TSCF Guidelines.

Following Council 47, the draft text of Z10.1(Rev.12) was distributed to Industry and discussed at the IACS/Industry meeting on 29 August 2003. Industry indicated that UR Z10.1(Rev.12) is acceptable, provided that appropriate IACS guidelines on coating repairs are developed.

The Small Group on Coating (SG/Coating) under WP/SRC prepared draft guidelines on coating repairs and considered the definitions of GOOD / FAIR / POOR. The SG/Coating did not change the definitions and found that the Guidelines provide useful clarifications on the definitions and criteria in achieving an industry wide uniform judgement of coating conditions as well as what is needed to restore GOOD conditions.

Further, an IACS/Industry JWG/Corrosion was established and met in February 2004. The outcome is (3095\_IGh, 4 June 2004):

- Draft Guidelines on Coating Repair (IACS REC 87)
- Draft UR Zxx (mandatory coating of cargo tanks on oil tankers)
- Draft UI SC 122 (Rev.2) – mandatory coating of ballast tanks

#### **4. Others**

1. Z10.11.2.2bis - Definition of “Combined Cargo/Ballast Tank. ...as a routine part of the vessel's operation and will be treated as a Ballast Tank. ...”. By so amending, Z10s do not need to repeat “Ballast Tanks and Combined cargo/salt water Ballast Tanks” in addressing the ballast tanks. Hence, all the references to “and Combined cargo/salt water Ballast Tanks” were deleted.
2. Z10.1.2.2.1.2: The aim of the examination is to be sufficient to discover substantial corrosion...  
Comparable changes are to be added to other UR Zs wherever the same sentence occurs.
3. “IACS Guidelines for Coating Maintenance & Repairs for Ballast Tanks and Combined/Ballast tanks on Oil Tankers” are referenced where relevant.
4. Comparable changes are to be added to UR Z10.3 and Z10.4, after adoption of Z10.1(Rev.12).

**Attached: Memo on Coating Matters (GPG Chairman)**

9 June 2004  
Prepared by the Permsec

## **Appendix 1 to Annex 1:**

## **MEMO on Coating matters**

### **1. Background and discussion within IACS on UR Z10.1 (draft Rev.12) between 29/01/03 and 14/08/03**

In view of the survey experience with oil tankers, it was proposed that all ballast tanks should be examined, routinely and uniformly, at annual surveys on ESP tankers exceeding 15 years of age. IACS should amend UR Z10.1 to require the examination of ballast tanks on such ships at each annual survey. This is simple, clear and thorough and not subject to interpretation. (2242\_ABq dated 29/1/03)

Then, ABS modified the proposal asking, for tankers subject to URs Z10.1, Z10.3 and Z10.4, exceeding 15 years of age, that the current requirement - pertaining to annual examination of Ballast Tanks adjacent to cargo tanks with any means of heating - be deleted and replaced by a simpler and more stringent requirement that all Ballast Tanks be subject to survey at each subsequent annual survey where either substantial corrosion is found within the tank or the protective coating is found to be in less than GOOD condition and the protective coating is not renewed at special survey or intermediate survey. This will ensure that all Ballast Tanks with substantial corrosion or protective coating which is not in GOOD condition at the time of special survey or intermediate survey will be examined at each subsequent annual survey on tankers exceeding 15 years of age. (2242\_ABzb dated 14/3/03)

This was later expanded to include all tanks used routinely for ballast water, both ballast-only and cargo/ballast tanks (2242\_ABzc dated 14/3/03).

ABS further reviewed the issue of the survey of salt water ballast spaces and combined cargo/salt water ballast spaces with ABS' governing bodies in light of recent casualties and survey findings on other tankers. Their review found an increasing amount of coating breakdown/failure and subsequent rapid wastage in key structures after Special Survey No. 2, i.e. after 10 years of age. These conditions are most prevalent in the under deck structure and the side shell structure in way of the deep loadline. In a number of cases the serious wastage has caused fracturing of the under deck longitudinals and in some cases fracturing has extended to the main deck structure. This led ABS to refine proposed amendments to URs Z10.1, Z10.3 and Z10.4 to require (2242\_ABzf dated 9/5/03):

#### a. For Tankers exceeding 10 years of age

Salt Water Ballast Spaces and Combined Cargo/Salt Water Ballast Spaces. For tankers exceeding 10 years of age, salt water ballast spaces and combined cargo/salt water ballast spaces are to be internally examined at each subsequent Annual Survey where substantial corrosion is found within the tank or where the protective coating is found to be less than GOOD condition and protective coating is not repaired. Internal examination to be an Overall Survey.

#### b. For Tankers exceeding 15 years of age:

Salt Water Ballast Spaces and Combined Cargo/Ballast Spaces. For tankers exceeding 15 years of age, salt water ballast spaces and combined cargo/ballast spaces are to be examined internally at each subsequent Annual Survey. Where substantial corrosion is found within the tank, or where the protective coating is found to be in less than GOOD condition and the protective coating is not repaired then in addition to an Overall Survey, under deck structure and the side shell structure in way of the deep loadline is to be subject to Close-up Survey.

NK and BV replied that the proposed amendments made by ABS need to be substantiated in a transparent manner with technical data that ABS may possess and put forward for further assessment and discussion. (2242\_NK<sub>n</sub> dated 14/5/03 and 2242\_BV<sub>z</sub> dated 16/5/03)

**DNV** (2242\_NV<sub>n</sub> dated 2/6/03), having carefully considered the practical consequences of taking the ship off-hire for gas freeing etc. and being concerned about the difficulties to have these surveys executed in a safe manner and whether the intended safety benefits in implementing the proposed extended scope of the annual survey of Ballast tanks will be met, **proposed the following alternative measures** which would be as effective and may not have such delaying effects to the ship:

- 1) Enhance the Intermediate Survey in UR Z10.1, 10.3, and 10.4 for Tankers after the 2 Special / Renewal Survey to the same level (scope of work) as the preceding Special / Renewal Survey. (This will correspond to the latest revised requirements of UR Z10.2 for Bulk Carriers.)
- 2) At Annual Survey of ballast tanks with substantial corrosion the overall survey should be replaced by close up survey with thickness measurements of the exposed area. (An overall survey of these tanks does not give sufficient information of the development of the areas with substantial corrosion.)
- 3) Further we will not fail to mention that the WP/SRC has proposed to extend the close up survey in cargo and combination tanks to 30% from the 3 Special / Renewal Surveys.
- 4) **Experience has shown that the coating condition rating category FAIR has a tendency to be stretched too far into the POOR condition. We will therefore propose that we task the WP/SRC to reconsider the acceptance criteria for the rating FAIR further.**
- 5) We do also question the need for redefining the definition of combination tanks, particularly since the category I tankers which are the ships that normally are fitted with these type of tanks are to be phased out 2 to 4 years from now. However DNV will not oppose to such a redefinition.

**DNV requested Members to consider the above as an alternative to the ABS proposal, bearing in mind that we ought to present this to the industry prior to deciding.**

ABS (3095\_Aba dated 2/6/03), having further considered its earlier proposals in light of NV<sub>n</sub>, submitted a revised proposal for consideration by Council at C47 and replied to the above 5 DNV proposals as follows:

- 1) ABS fully supports this proposal.
- 2) While ABS agrees with this proposal, it is in fact already provided for in Z7 (3.2.3) and Z10.1 (3.2.5.1)--which require that "Suspect areas (which include any area where substantial corrosion is found) identified at previous Special Survey are to be examined. Areas of substantial corrosion identified at previous special or intermediate survey are to have thickness measurements taken." To us, this implies that close-up survey of these areas is to be done at annual survey in conjunction with the thickness measurements. However, we can

agree to tasking WP/SRC to explicitly require "close-up" survey in this connection and to amend Z7, and all the Z10's, appropriately to make this explicit, if there is majority support for this.

3) We agree that this has been put forward to GPG by WP/SRC via 0237hNVb, 27 May. However, these additional CAS close-up survey requirements do not apply to salt water ballast tanks; only to cargo oil tanks and combined cargo/ballast tanks.

4) **We agree with this assessment and we propose that the only way to eliminate the subjectivity and raise the standard is to eliminate the category "FAIR" completely; leaving only "GOOD" and "POOR" redefined as follows:**

**"GOOD -- condition with no breakdown or rusting or only minor spot rusting.**

**POOR -- any condition which is not GOOD condition."**

5) ABS does not agree with this proposal. We are particularly concerned that we need a very thorough and robust survey regime for these tankers precisely because they are subject to mandatory phase out over the next several years. We are very concerned that without additional IACS requirements, these tanks will receive little or no inspection and maintenance by owners or others after their last special or intermediate survey, if no substantial corrosion is found at that time. Rapid, localized wastage in way of deteriorating coatings may pose significant hazard if the survey regime is not further tightened as we are proposing.

In conjunction with the above comments on DNV proposals, ABS further considered their previous proposal in ABzf and modified it as follows:

- **ABS simplified the proposal to require annual examination of all salt water Ballast Tanks and combined Cargo/salt water Ballast Tanks irrespective of age, when either substantial corrosion is found within the tank or the protective coating is found to be in less than GOOD condition and is not repaired.**
- the requirement for annual (close-up) examination of salt water ballast tanks and combined tanks is already required in Z10.1 (3.2.5.1). ABS proposed adding it to 2.2.3 for clarity and emphasis so that all the conditions which may lead to annual examination of such tanks are listed together in one place.
- Since the principal problem that we are trying to address is rapid, localized corrosion in way of breakdown or deterioration of the protective coating, we are proposing that the coating condition should be found and kept in "GOOD" condition to obviate the need for annual examination. **The attached proposal is made together with the proposals in items 3.1 (intermediate following Special survey 2 to have same scope as prior Special survey) and 3.4 (eliminating "FAIR" and redefining "POOR" as any condition other than "GOOD" condition.**

ABS requested to decide on a course of action at C47 for tightening the survey regime for tankers. They agreed that industry be informed of Council's decisions in this regard prior to IACS making the decision public, but IACS should maintain its independence and take decisive action in this matter. Debate with industry can only lead to delay and to a watering down and compromising of these important requirements.

NK agreed to task WP/SRC to reconsider the acceptance criteria of "FAIR" for clearly define the border between "FAIR" and "POOR" condition. However, **NK strongly opposed the elimination of "FAIR" coating condition from UR Zs** because this can not resolve to remove subjectivity of coating assessment. The three-categorization system of coating condition should be retained. (3095\_NKa dated 5/5/03)

## **Outcome of C47**

At C47, it was agreed that "Fair" would be retained as a rating and that GPG should instruct WP/SRC to redefine "Fair", so that there would be a clear differentiation between "Fair", "Poor" and "Good". It was also agreed that for oil tankers the Intermediate Survey following Special Survey No.2 would have same scope as Special Survey No.2 (Z10.1). WP/SRC should also clarify the definition of satisfactory repair.

Based on strong majority support Council agreed to discuss with Industry annual surveys of ballast tanks when coating is found in LESS than GOOD condition at special survey, with the objective to encourage the owner to carry out repairs and maintenance of coating to GOOD condition.

This matter should be discussed with Industry prior to adoption of any UR by Council.

In a final summary, the Chairman proposed that a constructive dialogue with Industry should take place on the IACS proposal as set out in WP1 plus maintaining 3.2.5.2 modified to say that ballast/combined ballast/cargo tanks will be subject to annual survey when considered necessary by surveyors.

After discussion in the JWG (Industry/IACS), GPG should propose final rules for this matter to Council, including acceptable repair definition.

**FUA 17:** *To instruct WP/SRC to develop guidance on coating repairs and more precise definition of "Fair" coating condition.*

Once approved, these requirements should be incorporated into Z10.3 and Z10.4.

### **FUA 15**

1) *To prepare a draft revision to UR Z10.1 incorporating C 47 decisions:*

- *The definition of "FAIR" remains as it is;*
- *ABS proposed amendments to Z10.1 (annual examination of BWTs in certain conditions) were approved;*
- *C47 agreed that the BWT coating requirements (Z10.1.2.2.3) for Intermediate Survey after Special Survey No.2 should be the same extent to the previous Special Survey.*
- *Given the substance of the changes, the revised UR Z10.1 should be shown to Industry (OCIMG/Intertanko first among others) before adoption for their review and comments.*
- *A guidance for coating repairs needs to be developed by WP/SRC with reference to TSCF Guidelines.*

2) *GPG Members are to confirm the draft revision to Z10.1 in consultation with their WP/SRC members by correspondence. See 3095\_IGa of 13/06/03.*

According to C47 FUA 15, GPG Chairman circulated (3095\_IGa dated 13/6/03) draft amendments to UR Z10.1 as agreed in principle at C47.

Having received a number on comments, GPG Chairman (3095\_IGb dated 27/6/03) informed that the Council Chairman confirmed that GPG is not to amend the principles agreed at C47, i.e. we are not empowered to change "GOOD" to "FAIR" as proposed by DNV and NK, nor to amend the definitions of "FAIR" and "POOR" as proposed by DNV.

DNV's intention to possibly lodge a reservation was noted, however the matter should be raised at Council and not be dealt with by GPG. An amended draft text incorporating the non-substantive changes proposed by Members was circulated.

DNV said that its understanding was that the draft should be circulated to the Industry (ICS, INTERTANKO, and BIMCO) prior to adoption by Council. (3095\_NVc dated 30/6/03)

GPG Chairman (3095\_IGc dated 30/6/03) circulated a draft amendment of UR Z10.1 for Council's agreement and use in discussions with the industry associations.

The draft was generally agreed by GPG but individual Members have requested that the following matters (which were deemed to be outside the remit of GPG in this task) be brought to Council's attention for further consideration:

- 1 DNV and NK stated that they can not accept a requirement for annual surveys of ballast tanks when the coating condition is less than GOOD and propose that GOOD be changed to FAIR.
- 2 In connection with item 1 above, DNV also propose to amend the definitions of FAIR and POOR in order to raise the standard of FAIR.

Council Chairman (3095\_ICb dated 14/8/03) concluded that Council has agreed that the draft amendments to UR Z10.1 attached to IGc reflect Councils' decision taken at C47 and that they be circulated to industry associations.

Perm Sec was therefore invited to submit the draft to OCIMF and INTERTANKO in view of discussion at the IACS/ industry meeting on 29 August.

## **2. Discussion with Industry (29/08/2003 – 11/10/2003)**

As requested by Council, the whole matter was presented to Industry during the “general matters” meeting with IACS held on 29 August 2003; comments from Industry were requested. In the following an extract from the minutes of the meeting (see message 3100aIAb dated 5 September 2003):

\_\_\_\_\_ from Meeting minutes \_\_\_\_\_

## **4. & 5. Annual surveys of ballast tanks and IACS guidelines on coating repairs**

M. Dogliani introduced the matter ([see Items 4&5 in Appendix](#)).

A. LinoCosta gave a presentation to show where concerns and decisions stand: too many cases when coating was considered fair at SS but problems occurred just after one/two years.

N. Mikelis commented on draft amendments to Z10.1 (Rev.11) stating that the extent of annual survey is not clear; it should be limited to the affected zones, e.g. coating breakdowns, only.

M. Guyader clarified that, in this draft amendments, it is expected an overall survey of the whole tank and a close up survey of the affected zones.

N. Mikelis noted that, in the draft amendments to Z10.1 (Rev.11), the intermediate survey at 12.5 years would have the same scope as the previous special survey and that needed a justification. See 7 a).

M. Dogliani said that Z10.1 (Rev.11) was adopted in August 2003 and will be introduced into IACS Societies' Rules over the next year.

### Conclusions:

4.1 Industry shared IACS concerns on coatings and, in general, agreed with the draft amendments to Z10.1 (Rev.11) suggesting also extending them to Z10.2 on bulk carriers

4.2 Industry agreed that a guideline for surveyor on coating would greatly improve uniform application of so-amended Z10.1 including issues such as how to consider load bearing elements when judging GOOD/FAIR/POOR status and how to consider bottom pitting in connection with GOOD conditions

4.3 Industry will more precisely comment, by the end of September, the draft Z10.1 so as for IACS to finalise the matter, as planned, for the Council's December meeting.

Item	Title	Industry recommendation	IACS/ M. Dogliani Introduction
4 & 5	Annual survey of ballast tanks IACS guidelines on coating repairs	NN	<p><b>1. IACS is considering the following:</b></p> <ul style="list-style-type: none"> <li>- <b>amend UR Z10.1 (draft circulated to Industry) to the effect that in case at Special Survey or Intermediate Survey the coating in a ballast tank is found less than GOOD, either GOOD conditions are restored or the tank's coating is inspected at each annual survey;</b></li> <li>- <b>develop IACS guideline to assist an uniform application of the so modified (if adopted) UR Z10.1; the guideline should address which repairs are necessary to restore GOOD conditions from FAIR and POOR respectively and which are the criteria for the restored (after repair) situation to be rated as GOOD.</b></li> </ul>

\_\_\_\_\_ End of extract from minutes \_\_\_\_\_

INTERTANKO commented (see R. Leslie email to GPG dated 25 September 2003):

- expressing their concern for the draft Z10.1 and underlining
  - a) targeting: concerns that, if not properly dealt with, Z10.1 would target all ships and not just those which need intervention; the view was expressed that guidelines would probably solve the matter;
  - b) definition: indicating that the current definitions of GOOD, FAIR and POOR is not clear enough and that the matter would be even worst with GOOD and NON GOOD; again it was indicated that guidelines could solve the matter;
  - c) expertise: expressing doubts on IACS' surveyors expertise and ability to judge coating conditions; in this respect they (hiddenly) suggest that IACS position is unclear when we say that we are not competent to judge the coating during construction but then we are competent to judge coating during operational life. Even if not explicitly stated, the impression is that also in this case guidelines would help.

Additionally, INTERTANKO suggested a (quite detailed) set of assessment criteria.

The matter was then finally addressed at the TRIPARTITE Meeting (held in Soul on 29/30 September 2003). There Industry agreed that the way forward was the (joint) development of IACS guidelines (see minutes attached to message 3100\_RIe dated 11 October 2003, an extract of which is reproduced below).

\_\_\_\_\_ Extract from the TRIPARTITE minutes \_\_\_\_\_

Industry is concerned by the definition of GOOD/NOT GOOD in relation to coating repairs and acceptance criteria. Industry agreed that new guideline on this, which IACS is already producing, was the way forward.

\_\_\_\_\_ End of the extract from the minutes \_\_\_\_\_

### **3. Further developments**

- a) from the above, it was concluded that, provided the guidelines are sound, Industry would accept the concept of Z10.1 (draft) Rev. 12, therefore an IACS team and a JWG were established in order to progress the matter of the guidelines (among other related matters).
- b) the team of IACS experts on coating developed draft guidelines and provided recommendations to GPG on the way forward (attached to message 3095bNVc dated 20 November 2003).
- c) the guidelines were discussed within the JWG with Industry (see draft minutes circulated within GPG with messages 3095cIGd and 3095cIGe both dated 13 March 2004)
- d) further suggestions and comments (as requested at the meeting) were provided by Industry (not circulated to GPG)
- e) Bulk Carrier Industry is recommending that similar guidelines are developed in due time also for bulk carriers
- f) at DE47 and MSC78, IMO is asking Industry and IACS to develop (compulsory) performance standards for coating of newbuilding (double hull spaces of DSS Bulk Carriers), a matter which is, indirectly related to the above one.

1 June 2004

M. Dogliani

IACS GPG Chairman

IACS JWG/COR Chairman



Appendix 2 to Annex 1: [DNV proposal to Z10.1, Z10.3 and z10.4](#) ▶

Sent Monday, July 4, 2005 4:45 pm

To [Gil-Yong <gilyonghan@iacs.org.uk>](mailto:Gil-Yong <gilyonghan@iacs.org.uk>)

Cc

Bcc

Subject Fw: 1060gNVs; WP/SRC - Task 102 - Harmonization of UR Z 7 and Z 7.1

Attachments [Doc1.doc](#)

25K

----- Original Message -----

From: "Debbie Fihosy" <[debbiefihosy@iacs.org.uk](mailto:debbiefihosy@iacs.org.uk)>

To: "CCS" <[iacs@ccs.org.cn](mailto:iacs@ccs.org.cn)>

Cc: "IACS Permanent Secretariat" <[permsec@iacs.org.uk](mailto:permsec@iacs.org.uk)>

Sent: Friday, June 03, 2005 2:52 PM

Subject: FW: 1060gNVs; WP/SRC - Task 102 - Harmonization of UR Z 7 and Z 7.1

Forwarding as requested

-----Original Message-----

From: Arve.Myklebust@dnv.com [[Arve.Myklebust@dnv.com](mailto:Arve.Myklebust@dnv.com)]

Sent: 25 May 2005 15:49

To: [AIACS@eagle.org](mailto:AIACS@eagle.org); [iacs@bureauveritas.com](mailto:iacs@bureauveritas.com); [iacs@ccs.org.cn](mailto:iacs@ccs.org.cn);

[johnderose@iacs.org.uk](mailto:johnderose@iacs.org.uk); [iacs@dnv.com](mailto:iacs@dnv.com); [iacs@gl-group.com](mailto:iacs@gl-group.com);

[gilyonghan@iacs.org.uk](mailto:gilyonghan@iacs.org.uk); [helenbutcher@iacs.org.uk](mailto:helenbutcher@iacs.org.uk); [efs@iacs.org.uk](mailto:efs@iacs.org.uk);

[krsiacs@krs.co.kr](mailto:krsiacs@krs.co.kr); [richardleslie@iacs.org.uk](mailto:richardleslie@iacs.org.uk); [external-rep@lr.org](mailto:external-rep@lr.org);

[clnkiacs@classnk.or.jp](mailto:clnkiacs@classnk.or.jp); [terryperkins@iacs.org.uk](mailto:terryperkins@iacs.org.uk); [iacs@rina.org](mailto:iacs@rina.org);

[iacs@rs-head.spb.ru](mailto:iacs@rs-head.spb.ru); [colinwright@iacs.org.uk](mailto:colinwright@iacs.org.uk)

Subject: FW: 1060gNVs; WP/SRC - Task 102 - Harmonization of UR Z 7 and Z 7.1

25 May 2005

To: Mr. B. Anne, Chairman of IACS Council,

cc: Council Members, IACS Perm. Sec.

Ref.: My mail NVr dated 20 May 2005

DNV have further studied the amendments to UR Z10.1, Z10.3, and Z10.4, and as a result are presenting the following as a compromise solution:

General comment:

From the comments by other Members it is obvious that there is reluctance to accept annual surveys of ballast tanks with a common plane boundary to heated cargo tanks in the case where the coating is in good condition. This is particularly unreasonable as at the same time we enhance the Intermediate survey of Tankers between 10 and 15 years to also include examination of all ballast tanks, meaning that all ballast tanks will be close up surveyed with 2-3 years intervals from the ship is 10 years old, with the possibility for the surveyor to require thickness measurements and testing of the tanks to ensure the structural integrity of the tanks if necessary.

It is also proposed for the Intermediate survey between 5 and 10 years, to increase the scope from representative to all ballast tanks, a requirement DNV find to strict, and require that we here keep the original text.

If a ballast tank is found to have coating in GOOD condition at the renewal or intermediate survey, a deterioration of the tank beyond structural reliability is very unlikely even if the tank has a common plane boundary to a heated cargo tank.

DNV finds it particularly unreasonable to have this requirement to apply to double hull tankers for the following reasons:

- these ships have double hull and the risk of pollution is here much reduced,
- the double hull is constructed with small spaces giving improved structural reliability,
- almost all double hull tankers below VLLC have heated cargo tanks, and all ballast tanks have common plane boundaries to these tanks, meaning that this requirement will apply to a major part of the tanker fleet in the future,
- the ballast tanks of double hull tankers are so designed that a general examination of these tanks will be identical to a close up survey,
- survey of ballast tanks of double hull tankers will mean either gas freeing of all cargo tanks or at least dropping the inert gas pressure of all cargo tanks in addition to proper airing of all ballast tanks.

Since the single hull tankers will be faced out in the near future, and for clear political reasons, DNV will as a compromise proposal to keep paragraph 2.2.3.1 and 4.2.2.2 in Z 10.1 as amended by Council (ref. IAo) but amend it to not include 2.2.3.1.e, 4.2.2.2.e and last paragraph of 3.2.5.1 in Z10.3 and Z10.4. In addition we request that the original text of 4.2.2.1 is kept.

If BV, ABS and other Members can accept this DNV is willing to drop our reservation presented at C49.

DNV's proposal will then be as follows:

Z10.1:

2.2.3.1: This paragraph can be accepted as is for the reasons stated above.

3.2.5.1: This paragraph is accepted as amended.

4.2.2.2: This paragraph can be accepted as is for reasons stated above.

For other comments to Z10.1 see NVo and NVp.

Z10.3:

2.2.3.1.e to be deleted.

3.2.5.1 delete last paragraph

4.2.2.1 the original text to be kept. "For tanks used for water ballast ---"

4.2.2.2.e to be deleted

Z10.4

2.2.3.1e to be deleted

3.2.5.1 delete last paragraph

4.2.2.1 the original text to be kept, "For tanks used for water ballast --"

4.2.2.2.e to be deleted.

For details see attached document where the text for the requirements in Z10.3 and Z10.4 that DNV will accept is stated.

Best Regards

Arve Myklebust  
on behalf of  
Terje Staalstrom  
DNV IACS Council Member  
<<Doc1.doc>>

\*\*\*\*\*

Neither the confidentiality nor the integrity of this message can be vouched

Annex 2 to TB (Harmonization Z10s)

**WP/SRC Task 114 “Clarify the procedure of verification and signature of the thickness measurement report”**

Item No.	Item	ABS	BV <sup>1)</sup>	CCS	CRS	DNV	GL	IRS	KR	LR	NK	RINA	RS
<b>1</b>	<b>Verification onboard</b>												
1.1	Minimum extent of measuring points for direct verification by attending surveyor specified	No	No	No	No	No	No	No	Yes	No	No	Yes	No
1.2	Preliminary TM record to be signed upon completion of the measurements onboard	Yes	Yes <sup>7)</sup>	Yes	No (copy taken)	No <sup>3)</sup>	No <sup>6)</sup>	Yes	Yes	Yes	Yes	No <sup>8)</sup>	No
<b>2</b>	<b>Final TM report</b>												
2.1	Signature of all pages in TM record required	No	No	No	Yes	No	Yes	Yes	No	No	No <sup>5)</sup>	Yes	Yes
2.2	Signature of ‘cover’ (‘general particulars’) page only	Yes	Yes	Yes	No	Yes	No	No	No <sup>4)</sup>	Yes	Yes	Yes	No
2.3	Measuring points verified by attending surveyor required identified in TM record and signature of the corresponding pages required	No	No	Yes Without signature	Yes	No	No	No	Yes	No	No	No	No

2004-04-20

<sup>1)</sup> Instructions not clear regarding signature of the thickness measurement record

<sup>2)</sup> Signature on front and last page, stamp on all other pages, or signature on each page (IACS TM forms)

<sup>3)</sup> Upon completion of measurements onboard a draft report in electronic format (DNV TM template, including operator’s notes as relevant) to be given to attending surveyor

<sup>4)</sup> Signature of cover page, pages of meeting record and pages of attended measuring points

<sup>5)</sup> Each page to be signed in case of ‘loose-leaf’ type record

<sup>6)</sup> Preliminary TM record has to be passed to the Surveyor, signed by the Operator

<sup>7)</sup> The only measures which the Surveyors can certify exact are those for which that they have seen the results on the screen of the apparatus. That means in fact few points in comparison with the numbers of recorded measures.

<sup>8)</sup> The Surveyor reviews the TM record for completeness and assessment of TM readings, but no signature required.

UR Z7s and Z10s (Corrosion Prevention System)

1. Objective:

To clarify whether the survey of anodes is a class matter, and if so, whether acceptance criteria for anode should be developed.

2. Method: GPG by correspondence (5037\_)

3. Discussion

3.1 BV initiated GPG discussion as follows:

Paris La Défense, 8 Mars 05

1 - We have noticed that, in the draft UR Z's ( 7.1, 10.1 to 10.5) issued further to the WP/SRC Task 102, the original sentence ".....the examination may be limited to a verification that the hard protective coating remains efficient....." has been replaced by ....that the corrosion prevention system remains efficient....". in a number of paragraphs (such as , for instance, Z 7.1, 4.2.3.1 a) ; Z 10.2 4.2.3.3 ; ), in line with IMO Res.A744(18).

2 - However, a corrosion prevention system is defined, in the same UR Z's and in IMO Res.A744(18) , as being either a full hard protective coating or a full hard protective coating supplemented by anodes.

3 - The above would mean that the survey of the anodes is a classification matter.

4 - However, whereas coating conditions are defined as good or fair or poor, there are no criteria in the IACS URs and IMO Res. A744(18) for the anodes condition.

5 - Assessing the anodes condition to confirm that they "remain efficient" looks to BV to be a quite difficult task for the ships in service Surveyor.

6 - Member's view and interpretations on the following would consequently be appreciated:

- do Members consider that the above requirements in IACS URs imply that survey of anodes is part of the classification ?
- do Members consider that the above requirements in IMO Res. A 744 (18) imply that survey of anodes is mandatory?
- if yes, what is the acceptance criteria to conclude that the anodes" remain efficient" ?

3.2 The majority of GPG Members replied that they did not include requirements for anodes in their class rules.

LR / ABS / DNV / KR / NK / RINA / RS were of the view that the condition of any anodes fitted should be recorded for information purposes as the survey of anodes is neither a classification matter nor a mandatory requirement in IMO A.744(18) and has no impact on future surveys (5037\_LRa). [Note; LR further clarified that "Whilst I agree that the performance of anodes is not normally a class matter LR does require that as part of Special Survey on oil tankers : "The attachment to the structure and condition of anodes in tanks are to be examined ." Therefore we cannot say that 'the survey of anodes is not a classification matter'. 5037\_LRb]

However, GL said that “for GL, anodes are a matter of class and as such are subject to plan approval as well as surveys. In case of missing or worn-out anodes we issue a condition of class”(5037\_GLa&b).

CCS advised that its rules have a general requirement relating to anode survey, which is only conducted, through sampling, during construction, docking survey or where there is a definite requirement for the survey of ballast tanks.

NK proposed that the following footnote be added to Z7s and Z10s:  
“The survey of anodes is not a classification matter.” No majority support was achieved.

#### **4. Conclusion**

RINA suggested to simply amend the definition of "Corrosion Prevention System" in paragraph 1.2.9 of UR Z7 (and, of course, the paragraphs in all the other UR Zs containing the definition of "Corrosion Prevention System") in order to eliminate any reference to anodes. This proposal would leave room for Societies willing to include additional class requirements for anodes to do so in their Rules.

GPG agreed.

### **RINA proposed amendments to paragraph 1.2.9 of UR Z7 and corresponding paragraphs in all other UR Zs (5037\_RIb, 6 April 2005)**

#### 1.2.9 Corrosion Prevention System

A corrosion prevention system is normally considered ~~either: a full hard protective coating, or~~  
~~1 a full hard protective coating, or~~  
~~2 a full hard protective coating supplemented by anodes.~~

Hard protective coating is usually to be epoxy coating or equivalent. Other coating systems may be considered acceptable as alternatives provided that they are applied and maintained in compliance with the manufacturer's specifications.

Where soft coatings have been applied, safe access is to be provided for the surveyor to verify the effectiveness of the coating and to carry out an assessment of the conditions of internal structures which may include spot removal of the coating. When safe access cannot be provided, the soft coating is to be removed.

[Annex: Council Chair's conclusive message.](#)

6 May 2005  
Permsec

## **Annex. (5037\_ICb, 15 May 2005)**

To : All IACS Council Members  
c.c : Mr. R. Leslie, IACS Permanent Secretariat

Ref. Mr G-Y. Han's message IAa dated 6 May 05  
Message ICa dated 6 May 05  
Admiral R.E. Kramek's message ABb dated 13 May 05

Paris La Défense, 15 May 05

- 1 - All Members have agreed with the texts attached to Mr Han's message.
- 2 - Further to ABS comments the reference to anodes is to be deleted in Annex I and in tables IX (IV) and IX(II).
- 3 - further to ABS questions regarding what IACS plan to do regarding IMO and A.744(18) further to IACS deletion of reference to anodes from the UR Z7's and UR Z10's it is to be noted that:

The Item 1.2.9 in UR Z10.1 and relative items in these URs states  
*1.2.9 10 Corrosion Prevention System: A corrosion prevention system is normally considered either:*

- .1 a full hard protective coating, or*
- .2 a full hard protective coating supplemented by anodes.*

*Hard Pprotective Ccoating is to usually to be epoxy coating or equivalent. Other coating systems may be considered acceptable as alternatives provided that they are applied and maintained in compliance with the manufacturer's specification.*

*Where Soft Coatings have been applied, safe access is to be provided for the surveyor to verify the effectiveness of the coating and to carry out an assessment of the conditions of internal structures which may include spot removal of the coating. When safe access cannot be provided, the soft coating is to be removed.*

- therefore the anodes are not considered as the main means of protection against the corrosion It is only a supplement;
- there is no provision in UR Z7's and Z10's to evaluate the level efficiency of the anodes;
- there is no specific requirements in case of lack of efficiency of the anodes.

The experience has shown that ballast tanks only protected by anodes are subject to corrosion when the anodes are becoming less efficient.

The anodes are active only when immersed by sea water. Therefore the upper part of the ballast tanks are not protected when the ballast is full of water and the ballast is not protected when it is empty..

The ships operators are reluctant to replace the anodes especially in upper part which request fitting of scaffolding fo welding the anode supports to the structure.

[The above arguments justify the reasons why IACS consider that the anodes are not class item.](#)

[4 - These arguments can be used by IACS Members](#) attending the WG bulk carriers at MSC 80 to try to obtain deletion of the reference to anodes in A. 744(18).

Best regards,

Bernard Anne  
IACS Council Chairman.

## **Technical Background**

**UR Z10.1(Rev.13, Jan 2006)**

**UR Z10.2(Rev.18, Jan 2006)-separate TB**

**UR Z10.3(Rev.8, Jan 2006)**

**UR Z10.4(Rev.3, Jan 2006)**

**UR Z10.5(Rev.2, Jan 2006)**

**Part 1. Z10s – para. 1.4 and 7.1.3**

**Part 2. Z10s – para. 5.5.4 and 5.5.6**

**Survey Panel Task 22 – Amend applicable URZ7s and Z10s to align Close-Up Survey and Thickness measurements to be carried out at the same time and location allowing for a more structured control of the thickness measurement process.**

**Technical Background**

**Z7(Rev.12)**

**Z7.1(Rev.3)**

**Z10.1(Rev.13, para.1.4 & 7.1.3)**

**Z10.2(Rev.18, para. 1.4 & 7.1.3)**

**Z10.3(Rev.8, para. 1.4 & 7.1.3)**

**Z10.4(Rev.3, para. 1.4 & 7.1.3)**

**Z10.5(Rev.2, para. 1.4 & 7.1.3)**

**1. Objective**

To amend the applicable URZ7s and Z10s to align Close-Up Survey and Thickness measurements to be carried out at the same time and location allowing for a more structured control of the thickness measurement process.

**2. Background**

IACS QC findings, through audits of numerous Societies, which indicated concerns over Surveyor attendance and control of thickness measurement processes.

**3. Methodology of Work**

Survey Panel members through correspondence.

**4. Discussion**

To align Close-up survey requirements and thickness measurements in the applicable URZ7s and URZ10s, in accordance with PR19, all Panel members agreed through correspondence and a final vote at the fall Survey Panel meeting, that URZ7, Z7.1, Z10.1, Z10.2, Z10.3, Z10.4 and Z10.5 should include in the applicable sections of the noted URs as proposed by the Survey Panel the wording “ In any kind of survey, i.e. special, intermediate, annual, or other surveys having the scope of the foregoing ones, thickness measurements of structures in areas where close-up surveys are required, shall be carried out simultaneously with close-ups surveys.”

**5. Implementation**

The Survey Panel is of the view that the Members need 12 months from the adoption date to implement these amendments into their class rules. Assuming that GPG and Council approve to the amendments, the Survey Panel would propose January 2007 as an implementation date.



## **Technical Background**

**UI SC 191 (Rev.2, Oct 2005)**

**&**

**UR Z10.1 (Rev.13, para.5.5.4 and 5.5.6, Jan 2006)**

**UR Z10.2 (Rev.18, para. 5.5.4 and 5.5.6, Jan 2006)**

**UR Z10.3 (Rev.8, para.5.5.4 and 5.5.6, Jan 2006)**

**UR Z10.4 (Rev.3, para.5.5.4 and 5.5.6, Jan 2006)**

**UR Z10.5 (Rev.2, para.5.5.4 and 5.5.6, Jan 2006)**

### **1. Objective**

- to confirm whether the guidelines for approval/acceptance of alternative means of access (now REC91, ex Annex to UI SC191) is mandatory or non-mandatory.
- to consider other safety related proposals.

### **2. Background**

The DNV proposal to submit the UI SC191(Rev.1, May 2005, Annex 1) to IMO DE49 triggered a number of discussion points that led to amendments to the following resolutions:

UI SC191(Rev.2)  
New REC 91  
REC 39(Rev.2)  
UR Z10s

### **Points of Discussion**

3. Is the Annex to UI SC191(Rev.1, May '05, guidelines for approval / acceptance of alternative means of access) mandatory or non-mandatory ?

Answer: Non-mandatory. Hence, re-categorized as new REC 91.

4. Limitation of use of rafts in bulk carrier holds

DNV proposed that conditions for rafting should be limited to areas, such as anchorage or harbour, where swell conditions are limited to 0.5m. After discussion, GPG approved the ABS' alternative proposal to use the swell condition as a basis to determine the appropriateness of rafting, instead of geographic areas(harbours or anchorage). 5.5.4 of Z10.2 refers.

RINA proposed that para 5.5.4 should be included in all the Z10s. NK's objection is recorded as follows (3037hNKq, 29/08/2005):

1. With regard to RIm of 26 August 2005, NK considers that the proposed amendment to 5.5.4 should be limited to UR Z10.2.
2. Rafting survey for tankers are actually carried out on the open sea from a discharge port to a loading port and in such situation the rise of water within the tanks would always exceed 0.25m. It is different situation from rafting survey for hold frames of bulk carriers normally conducted in a harbour or at an anchorage.
3. If the same requirement applies to tankers, any rafting survey for cargo oil tanks and ballast tanks of tankers would be prohibited. This is not practicable under present survey procedure for tankers.
4. Therefore, NK can not support Laura's proposal that the proposed amendment to 5.5.4 of UR Z10.2 is introduced into the other URs and new Recommendation.

For compatibility with the IMO's mandatory requirements\*, GPG decided to add the same amendment to all the UR Z10s.

\*

- Appendix 4 to MEPC.99(48) 'Mandatory requirements for the Safe Conduct of CAS Surveys'
- MSC.197(80) – amendments to A.744918), Annex A for DSS and SSS bulk carriers and Annex B for single and double hull oil tankers.

As a consequence, 5.5.1 of REC 91(ex Annex to UI SC191) was also amended:

- to remove the reference to dynamic /sloshing (as the 0.25m rise was considered negligible);
- to refer to the rafting conditions contained for cargo holds in Z10.2 and Z10.5 and for oil cargo tanks in Z10.1 and Z10.4.

5. Means of access from longitudinal permanent means of access within each bay to rafts

GPG reviewed the proposal that the following text be added to Z10s:

[A means of access to the longitudinal permanent platform from rafts or boats is to be fitted in each bay.](#)

(Technical Background: for the safety of surveyors)

There may be ships which are arranged in accordance with para b, page 8 of the Annex to the current SC 191 (i.e., no means of access from the LPMA in each bay to a raft is required) and therefore could not be rafted if the sentence proposed by RINA ("[A means of access to the longitudinal permanent platform from rafts or boats is to be fitted in each bay](#)") is included in the Z10's.

GPG therefore agreed not to include this sentence in Z10s.

For the same reason, the same sentence was not added to Rec.39.

Finally, GPG added the following sentence to UI SC191(interpretation for II-1/3-6):

*A permanent means of access from the longitudinal platform to the water level indicated above is to be fitted in each bay (e.g permanent rungs on one of the deck webs inboard of the longitudinal permanent platform).*

## **6. Implementation**

It was agreed that the revised UI SC191 be implemented to ships contracted for construction 6 months after adoption by Council.

UI SC191 was also edited in line with IMO MSC/Circular. 1176, leaving its mandatory language (is/are to, shall) unchanged.

(Note: UI SC191(Rev.2) makes references to the following new Recommendations:

- REC 90: Ship Structure Access Manual
- REC 91: Guidelines for approval/acceptance of Alternative Means of Access)

23 September 2005  
Permanent Secretariat  
Updated on 13 Oct 2005.

## **Technical Background**

**URs Z7(Rev.15), Z7.1(Rev.5), Z7.2(Rev.1), Z10.1(Rev.15),  
Z10.2(Rev.26), Z10.3(Rev. 9), Z10.4(Rev.6), Z10.5(Rev.8) – November  
2007**

### ***Survey Panel Task 1 – Annual Review of Implementation of IACS Resolutions***

#### **1. Objective**

To review IACS Resolutions annually and discuss or propose amendments as deemed necessary.

#### **2. Background**

This proposed amendment to all URZ7s and URZ 10s was raised by the Panel member from DNV due to Owners crediting tanks concurrently under intermediate and special survey.

#### **3. Methodology of Work**

Survey Panel members through correspondence.

#### **4. Discussion**

The Panel member from DNV raised the issue of Owners having the ability of crediting spaces and thickness measurements only once in a 54 month interval, due to the availability of concurrent crediting of spaces and thickness measurements due to the flexible time window that is currently allowed between the intermediate survey and the special survey.

After a presentation and discussion lead by the DNV Panel member, all Survey Panel members agreed to the argument given by DNV, and further agreed to make the necessary changes in all URZ7s and URZ10s where Owners are not allowed to concurrently credit surveys and thickness measurements of spaces.

#### **5. Implementation**

The Survey Panel is of the view that the Members need 12 months from the adoption date to implement these amendments into their class rules. Assuming that GPG approve to the amendments, the Survey Panel would propose January 2009 as an implementation date.

Submitted by Survey Panel Chairman  
22 October 2007

**Permanent Secretariat note (December 2007):**

During GPG discussion DNV proposed that *“since this matter will be discussed between Owner and Class mainly in connection with the forthcoming Special Survey, DNV would prefer to locate this text, not only as part of Intermediate Survey, but also as a new text for the Special Survey.”* This was supported by BV, ABS, RINA and KR.

The revised documents were approved, with DNV’s proposal and an implementation date of 1 January 2009, on 15 November 2007 (ref. 7690\_IGb).

# Technical Background Document

## UR Z10.3 (Rev.10 Dec 2008)

### **Survey Panel Task 55: *Harmonization of UR Z10.3 – Requirements for Chemical Tankers to UR Z10.4 – Requirements for Double Hull Oil Tankers, as they both follow the ESP requirements for ESP Tankers***

#### **1. Objective**

Amend UR Z10.3 – Requirements for Chemical Tankers with a view to harmonizing to UR Z10.4 – Requirements for Double Hull oil Tankers, taking into account that both URs follow ESP requirements for ESP tankers.

#### **2. Background**

The task was triggered by the DNV Member, at the September 2007 Survey Panel meeting, on the grounds that UR Z10.3, which deals with survey requirements for chemical tankers, is not harmonized with UR Z10.4, which deals with survey requirements for double hull oil tankers, while the two types of ships often have identical structural arrangements.

DNV's initial proposal was to merge the two URs into a single UR, but after discussion within the Panel (by correspondence and at the March 2008 Survey Panel meeting) the decision was made to retain the two URs separate. The task was performed by setting up a Project Team, with members from RINA, acting as PT Manager, BV, CCS, DNV and GL.

#### **3. Discussion**

The Member from DNV, who had triggered the task, prepared a first partial draft highlighting the differences between the two URs. The PT Manager developed the first draft completing the comparison between the two URs.

The Project Team held one-day meeting in June 2008, during which a final draft was prepared, which, after further discussion by correspondence among the PT Members, was submitted to all Survey Panel Members for comments / agreement with the view to finalizing the task at the September 2008 Survey Panel meeting. At that meeting, the task could not be finalized and it was decided that Members would review the draft once more and provide their comments in due course by correspondence.

The task was then finalized on 24 October 2008 upon unanimous agreement from all the Survey Panel Members.

The harmonization process has mainly consisted in introducing in UR Z10.3 those requirements of UR Z10.4 that had been adopted for all the other UR Z10s, except for UR Z10.3 as they had come from IMO Resolution A.744(18).

An important amendment has been made to "TABLE I - MINIMUM REQUIREMENTS FOR CLOSE-UP SURVEY AT SPECIAL SURVEY OF CHEMICAL TANKERS", where different survey requirements have been introduced for chemical tankers of single hull construction and double hull construction. Also "TABLE IV - Requirements for extent of Thickness Measurements at those areas of substantial corrosion - Special Survey of Chemical

tankers within the Cargo Area Length”, which is composed of four sheets, has been amended in accordance with the aforementioned differences between single and double hull chemical tankers.

Another notable change has been introduced in the "ANNEX II - Recommended Procedures for Thickness Measurements of Chemical Tankers” which, however, is only recommendatory and not mandatory, where the existing thickness measurements forms have been suppressed and reference has been made to ANNEX II of URZ10.1 for Single Hull Chemical and to Annex II of URZ10.4 for Double Hull Chemical Tankers.

#### **4. Implementation**

The Survey Panel is of the view that the implementation date for the revision 10 of UR Z10.3 should be after 12 months from the adoption date by GPG and Council. Therefore the implementation sentence (Note 9 of the UR) should read “Changes introduced in Rev.10 are to be uniformly applied by IACS Societies for surveys commenced on or after the *[one year after the adoption by GPG/Council]*”.

**Submitted by Survey Panel Chairman  
12 November 2008**

**Permanent Secretariat note (December 2008):**

Rev.10 of UR Z10.3 was approved by GPG on 2 December 2008 (ref. 7718aIGb) with an implementation date of 1 January 2010

## Technical Background

### URs Z7(Rev.16), Z7.1(Rev.6), Z7.2(Rev.2), Z10.1(Rev.16), Z10.2(Rev.27), Z10.3(Rev.11), Z10.4(Rev.7) and Z10.5(Rev.9) - March 2009

#### Survey Panel Task 62:

- A) *Harmonization of UR Z10.1, Z10.2, Z10.4 and Z10.5 with UR Z10.3 with respect to items 5.5.4.4 and 5.6.2.*
- B) *Harmonization of UR Z7, Z7.1, Z10.1, Z10.2, Z10.3, Z10.4 and Z10.5 with UR Z7.2 with respect to the definition of the corrosion prevention system and with respect to the footnote 1 related to semi-hard coatings.*
- C) *Harmonization of the definition of Ballast Tank in UR Z7(Rev.14)*

### 1. Objective

- A) Amend the texts of items 5.5.4.4 and 5.6.2 in Unified Requirements Z10.1, Z10.2, Z10.4 and Z10.5 in order to align them with those in UR Z10.3, in which they were changed while performing Task 55, whereas in the other UR Z10s they were kept unchanged on the grounds that this change was out of the scope of Task 55.
- B) Amend the definition of “Corrosion Prevention System” and include a Footnote 1 related to semi-hard coatings in Unified Requirements Z7, Z7.1, Z10.1, Z10.2, Z10.3, Z10.4 and Z10.5 in order to align them with those adopted in UR Z7.2, when this new UR was issued.
- C) Amend UR Z7 (Rev. 14) in all items where the term “Ballast Tank” is used in order to get them harmonized with the definition itself.

### 2. Background

The task, as regards item A), was triggered by a Member Society, while performing Task 55, on the grounds that this part was out of the scope of the task and then should have been dealt with in a separate task.

The task, as regards item B), was triggered as a consequence of the “New Business action item 2” of the Minutes of the September 2008 Survey Panel meeting, for sake of harmonization of the various URZs.

The task, as regards item C), was triggered as a consequence of the “Task 54-Examination of Double Bottom Ballast Tanks at annual surveys” of the Minutes of March 2008 Survey Panel meeting, for sake of harmonization of the definition of Ballast Tank in UR Z7(Rev.14).

### 3. Discussion

The task was carried out by correspondence. All the amended texts for the affected URs were prepared by the Survey Panel Member who had chaired the PT on Task 55, in accordance with the Form A approved by GPG. In addition to the objectives outlined in the Form A, an amendment was added to item 1.3.1 of UR Z10.2 and UR Z10.5 in which the reference 3.2.3.6 in the last item of the list was replaced by 3.2.3.10 as can be correctly verified in the text.

The amended URs were circulated to all Survey Panel Members for review, comments and agreement. The texts of the URs were unanimously agreed by all Members.



#### **4. Implementation**

The Survey Panel is of the view that the Member Societies need at least 12 months from the adoption date to implement these amendments into their class rules/procedures. Therefore, in the first version of all amended URs the following implementation sentence should be proposed:

*Changes introduced in Rev .xx are to be uniformly applied by Member Societies and Associates for surveys commenced on or after [not less than 12 months after the adoption by GPG/Council].*

Since it is common practice and convenience to have implementation dates either on 1<sup>st</sup> January or on 1<sup>st</sup> July of the year, the Survey Panel proposes the 1<sup>st</sup> July 2010 as implementation date, if GPG/Council approve the URs not later than 30 June 2009.

**Submitted by Survey Panel Chairman  
28 February 2009**

#### **Permanent Secretariat notes (April 2009):**

1. The amended URs were approved by GPG on 18 March 2009 (ref. 7718bIGd).
2. During the typesetting process it was noted that para 5.1.5 of UR 7.2 was inconsistent with the amended URs and so following consultation with the Survey Panel this was also amended at this time.
3. Regarding the implementation date, GPG agreed to use 1<sup>st</sup> July 2010 provided that it was consistently used for the amended URs.

## **Technical Background for UR Z10.3 Rev.12 (Mar 2011)**

### **1. Scope and objectives**

- 1) To amend UR Z10.3 Table I to include references on zones of ship's structures subject to close-up survey according to URZ10.4.
- 2) To amend UR Z10.3 to harmonize the definition of transverse section.
- 3) Update of references in the Executive Hull Summary Table IX.

### **2. Engineering background for technical basis and rationale**

- 1) Assignment of zones subject to close-up survey in URZ10.1 and UR10.4 is different. Chemical tankers may be of single hull as well as double hull construction.
- 2) Based on that fact that bulk carriers and oil tankers have a transverse framing system applied for example on ship's sides etc. and that UR Z7 is applied to all types of ships and includes an extended definition of transverse section it is necessary to unify this definition in UR Z10s.
- 3) Update of references in the Executive Hull Summary Table IX such that the introduction of extended annual surveys is noted in the 'Memoranda' section rather than under 'Conditions of Class'.

### **3. Source/derivation of the proposed IACS Resolution**

IACS UR Z10.1 and Z10.4 for item 1) and UR Z7 for item 2).

### **4. Summary of Changes intended for the revised Resolution:**

1) In Table I references to figures of areas (1) to (7) illustrated in URZ10.4 are added to be used for chemical tankers of double hull construction and references to figures of areas (A) to (D) illustrated in URZ10.1 are added to be used for chemical tankers of single hull construction.

2) The following additional text is added to the definition of transverse section in para 1.2.5:

*"For transversely framed vessels, a transverse section includes adjacent frames and their end connections in way of transverse sections."*

3) In the Executive Hull Summary Table IX (iv) the reference to part H) is updated to part I) as per Table IX (ii).

### **5. Points of discussions or possible discussions**

None.

### **6. Attachments if any**

None.

## **Technical Background for UR Z10.3 Rev.13, July 2011**

### **1. Scope and objectives**

Review the requirement for repairs within IACS UR 7 and UR 10 series, in particular the requirement for Prompt and Thorough Repair, with a view to developing wording that would permit a temporary repair and the imposition of a Recommendation/ Condition of Class under specific and controlled circumstances, and in accordance with PR35.

### **2. Engineering background for technical basis and rationale**

There are instances, for example a localised, isolated and very minor hole in a cross-deck strip, at which a suitable temporary repair, for example by welding or doubling, and the imposition of a suitable short term Recommendation/ Condition of Class for permanent repair at a later date, are considered very adequate methodology for dealing with the defect.

Current IACS Requirements in the UR Z7 and Z10 series, for Prompt and Thorough repair, would not permit this to be an option, the defect would have to be permanently Promptly and Thoroughly repaired, which might require removing cargo, moving to a repair berth and staging inner spaces.

Under the Requirements of IACS Procedural Requirement PR 35 the methodology of Temporary Repair and imposition of a suitable short term Recommendation/ Condition of Class for permanent repair at a later date is fully permissible.

### **3. Source/derivation of the proposed IACS Resolution**

Based upon discussion within the IACS Survey Panel.

### **4. Summary of Changes intended for the revised Resolution:**

Following the definition of Prompt and Thorough Repair in the Unified Requirement, a new paragraph is proposed to be added:-

"1.3.3 Where the damage found on structure mentioned in Para. 1.3.1 is isolated and of a localised nature which does not affect the ship's structural integrity, consideration may be given by the surveyor to allow an appropriate temporary repair to restore watertight or weather tight integrity and impose a Recommendation/Condition of Class in accordance with IACS PR 35, with a specific time limit."

Also, Table I was split to into 2 tables for enhanced clarity, Table I.1 for Single Skin and Table I.2 for Double skin ships and miscellaneous editorial errors in the Table I.1 and I.2 are corrected.

### **5. Points of discussions or possible discussions**

a) The points of discussion are as indicated in Sections 2 and 4 above.

b) Discussion took place on whether to prepare this amendment as a Unified Interpretation of IMO Resolution A.744(18)/UR Z7 and Z10 series, finally it was agreed to make direct amendment to the relevant URs.

c) It is proposed that this amendment be submitted directly to the IMO DE/MSC Committees for consideration of amending directly IMO Res. A744(18)

**6. Attachments if any**

None

## **Technical Background for UR Z10.3 Rev.16 Jan 2014**

### **1. Scope and objectives**

- a) To consider appropriate text in IACS document regarding class period for lengthy conversions.
- b) To align the requirements in PR37 and UR Z10s regarding safe entry to confined spaces.

### **2. Engineering background for technical basis and rationale**

- a) As per the IMO Res. A1053 (27), lengthy conversions (not necessarily of major character) or other major repair work can be assigned for a 5 year period from the date of completion of conversion/repairs/surveys.
- b) Safety requirements in IACS PR37 can be applied to carry out survey in safe way for all kind of ships. When there are no indications about the safety of surveyor in UR Z10s then the requirements in PR37 shall be applied.

### **3. Source/derivation of the proposed IACS Resolution**

None

### **4. Summary of Changes intended for the revised Resolution**

- a) Following additional text was included to section 2.1.3 to clarify the class period for lengthy conversions

"In cases where the vessel has been laid up or has been out of service for a considerable period because of a major repair or modification and the owner elects to only carry out the overdue surveys, the next period of class will start from the expiry date of the special survey. If the owner elects to carry out the next due special survey, the period of class will start from the survey completion date."

- b) Existing Section 5.2.6 and 5.2.7 were deleted from UR Z10s since provisions of these sections were covered by PR37. Reference of PR37 was included in Section 5.2.1.1.

### **5. Points of discussions or possible discussions**

- i) Additional text to Para.2.1.3 was discussed in order to clarify class period.
- ii) Panel considered that safety of surveyors should be dealt by PR37.

### **6. Attachments if any**

None

## UR Z10.4 “Hull Surveys of Double Hull Oil Tankers”

### Summary

This revision is to harmonize the revised requirements in line with the amendments made to ESP Code vide Res.MSC.525(106)

### Part A. Revision History

Version no.	Approval date	Implementation date when applicable
Rev.18 (Feb 2023)	08 Feb 2023	1 July 2024
Rev.17 (May 2022)	03 May 2022	1 January 2023
Rev.16 (May 2019)	30 May 2019	1 July 2019
Rev.15 (Jan 2018)	15 January 2018	1 January 2019
Rev.14 (Nov 2016)	22 November 2016	1 January 2018
Rev.13 (Feb 2015)	05 February 2015	1 July 2016
Rev.12 (Jan 2014)	14 January 2014	1 January 2015
Rev.11 (June 2013)	05 June 2013	1 July 2014/1 July 2016 * <sup>2</sup>
Rev.10 (Jul 2011)	27 July 2011	1 July 2012
Rev.9 (Mar 2011)	24 March 2011	1 July 2012
Rev.8 (Feb 2010)	17 February 2010	
Rev.7 (Mar. 2009)	18 March 2009	1 July 2010
Rev.6 (Nov. 2007)	15 November 2007	1 January 2009
Rev.5 (Feb. 2007)	10 February 2007	1 January 2007 / 1 January 2008 * <sup>1</sup>
Corr.1 (Sept. 2006)	14 September 2006	
Rev.4 (Jun. 2006)	23 June 2006	1 July 2007
Rev.3 (Jan. 2006)	4 January 2006	1 January 2007
Rev.2 (Jun. 2005)	27 June 2005	1 July 2006
Rev.1 (Oct. 2002)	22 November 2002	
New (Dec. 2001)	14 December 2001	

**\* Notes:**

1. Changes introduced in Rev.5 are to be uniformly implemented for surveys commenced on or after 1 January 2008, whereas statutory requirements of IMO Res. MSC 197(80) apply on 1 January 2007.
2. The changes to section 6 introduced in Rev.11 are to be uniformly applied by IACS Societies for surveys commenced on or after 1 July 2016. The other changes introduced in Rev.11 are to be uniformly applied by IACS Societies for surveys commenced on or after 1 July 2014.

## ● Rev.18 (Feb 2023)

### **.1 Origin of Change:**

- o Suggestion by an IACS member
- o Based on IMO Regulation

### **.2 Main Reason for Change:**

To revise the definition of Oil Tanker to exclude ships carrying oil in independent tanks not part of the ship's hull such as asphalt carriers in line with the amendments made to ESP Code vide Res.MSC.525(106).

To refine the wording of tank testing requirements in line with the amendments made to ESP Code vide Res.MSC.525(106).

To refine the wording of ballast tanks examination requirements at annual surveys in line with the amendments made to ESP Code vide Res.MSC.525(106).

To delete a reference, IACS UR Z10.1, in line with other IACS URs and the amendments made to ESP Code vide Res.MSC.525(106).

### **.3 List of non-IACS Member classification societies contributing or participating in IACS Working Group:**

None

### **.4 History of Decisions Made:**

- One survey panel member raised a question whether oil tankers having independent tanks like asphalt carriers are applicable to the ESP Code because the current definition of oil tankers includes those tankers. Survey panel unanimously agreed to the view that those ships carrying oil in independent tanks not part of the ship's hull such as asphalt carriers are not subject to the ESP Code and decided to modify the definition in UR 10s and the ESP Code. It was accepted in SDC8 and published as Res.MSC.525(106). (PSU19047)

- One survey panel member proposed to accept tank testing carried out by crew under the direction of the Master like oil tankers and decided to insert the requirements for oil tankers after minor modification of wording. However, at SDC8, the proposal for bulk carriers was rejected but the minor modification of wording for oil tankers was accepted. Survey panel considered to resubmit this issue to next SDC but decided not to do because it was disagreed by Ship owners/operators associations like INTERCARGO and ICS. (PSU17030/17039)

- One survey panel member suggested to refine the wording 'extended annual/intermediate survey' to 'examination of ballast tanks at annual surveys' in Executive Hull Summary and panel decided to modify it in the ESP Code first. It was submitted to SDC8 and included in Res.MSC.525(106). (PSU18056)

- One survey panel member pointed out that the references in UR Z10s need to be deleted to be in line with other UR Z10s. And panel decided to delete the reference of itself in UR Z10.1 in line with the amendments made to ESP Code vide Res.MSC.525(106). (PSU19057)

No TB is expected for the present revision.

**.5 Other Resolutions Changes:**

None

**.6 Any hinderance to MASS, including any other new technologies:**

None

**.7 Dates:**

Original Proposal:	19 September 2019	(PSU19047)
	19 September 2017	(PSU17030)
	17 November 2017	(PSU17039)
	24 October 2017	(PSU18056)
	18 December 2019	(PSU19057)
Panel Approval:	12 October 2021	(PSU21026_ISUf)
GPG Approval:	08 February 2023	(22198_IGd)

**• Rev.17 (May 2022)**

**.1 Origin of Change:**

- o Based on IMO Regulation (MSC.Res.483(103))
- o Suggested by IACS Member

**.2 Main Reason for Change:**

To amend the minimum requirements of Thickness Measurements at Special Survey No.1 of Double-hull Oil Tankers in line with the amendments made to ESP Code vide Res. MSC.483(103).

To make definition of ballast tanks in UR Z10s in line with other IACS Resolutions

**.3 List of non-IACS Member classification societies contributing or participating in IACS Working Group:**

None

**.4 History of Decisions Made:**

- One survey panel member raised issue regarding requirements for thickness measurements at Special Survey No.1. Some require deck plating and measurements



for general assessment of items subject to close-up surveys (tankers, chemical carriers, gas carriers) while others only require suspect areas (bulk carriers, ESDC, all Z7 vessels). With PSPC, there should be no wastage in ballast spaces at SS No. 1.

Noting that the mandatory requirement for the coating of cargo oil tanks of Regulation 3-11 of Chapter II-1 of SOLAS was adopted by Res. MSC. 291(87) and entered into force, panel members agreed to remove the requirements of thickness measurements in cargo oil tanks (items 2 and 4) of Special Survey No.1 in the Table II, and agreed to collect data from members about the results of the SS1 of enough vessels with the conditions about wastage, deficiencies in the areas relevant to the survey items 2 and 4 of SS1 in the Table II of UR Z10s.

Totally, 157 Double Hull Oil Tankers were collected and members concluded that based on the analysis to the datas collected by IACS members, it is concluded that the requirements of thickness measurements in cargo oil tanks (items 2 and 4) of Special Survey No.1 in the Table II of UR Z10.3 and Z10.4 could be removed, after a submission to IMO to amend the relevant contents of ESP Code being adopted.

It was submitted to SDC 7 and adopted as MSC.Res.483(103).

- One survey panel member pointed out that the definition of ballast tanks in UR Z10s are different from other IACS Resolution (UR Z7/Z7.1/Z7.2) and ESP Code. Survey panel reviewed and agreed to change "solely" to "primarily" in UR Z10s.

No TB is expected for the present revision.

#### **.5 Other Resolutions Changes:**

None

#### **.6 Any hinderance to MASS, including any other new technologies:**

None

#### **.7 Dates:**

Original Proposal	: 01 March 2018	(Ref: PSU18011)
	28 January 2020	(Ref: PSU20004)
Panel Approval	: 11 April 2022	(Ref: PSU21024)
GPG Approval	: 03 May 2022	(Ref: 22043_IGb)

### **• Rev. 16 (May 2019)**

#### **.1 Origin of Change:**

- o Suggestion by an IACS member

#### **.2 Main Reason for Change:**

This revision is to address the policy decision made by GPG using the common terminology 'Condition of Class'(CoC) instead of the terms 'Recommendation/ Condition of Class' based on the outcome of III 5.

**.3 List of non-IACS Member classification societies contributing through the TC Forum and/or participating in IACS Working Group:**

None

**.4 History of Decisions Made:**

During the 29th panel meeting, the panel discussed about the comments of members, and concurred with the view to retain the present definitions of CoC in the IACS resolutions with the wording 'Recommendation' to be removed. The panel also agreed to use the term 'Statutory Condition' for the 'recommendation' of the statutory certificates in IACS resolutions and RECs, and when discussing the proposal of a member to consider the harmonization of the terms of 'recommendation' and 'condition of class' in RO Code, the panel unanimously agreed to take no action on the IMO instruments, leaving the relevant actions to be decided by the relevant IMO bodies when IACS feeds back to IMO the IACS action on the harmonization of the two terms.

Panel members concurred with the view that it is not necessary to develop a new procedure requirement, and agreed to set the implementation date of these IACS resolutions (other than RECs) as 1st July 2020.

Before the implementation date of 1st July 2020 for using the common terminology 'Condition of Class' only, 'Recommendations' and 'Condition of Class' are to be read as being different terms used by Societies for the same thing, i.e. requirements to the effect that specific measures, repairs, surveys etc. are to be carried out within a specific time limit in order to retain Classification.

No TB is expected for the present revision.

**.5 Other Resolutions Changes:**

The following IACS resolutions and Recommendations (RECs) were agreed to be revised:

- Procedural Requirements: PR1A, PR1B, PR1C, PR1D, PR1 Annex, PR3, PR12, PR20, PR35 and the attachment of PR16;
- Unified Requirements: Z7, Z7.1, Z7.2, Z10.1, Z10.2, Z10.3, Z10.4, Z10.5, Z15 and Z20
- Unified Interpretations: GC13
- Recommendations: Rec.41, Rec.75, Rec.96, Rec.98

**.6 Any hinderance to MASS, including any other new technologies:**

None

**.7 Dates:**

Original Proposal: 14 January 2019 tasked by GPG (17044bIGm)

Panel Approval: 22 March 2019 (PSU19010)  
GPG Approval: 30 May 2019 (17044bIGu)

- **Rev.15 (Jan 2018)**

**.1 Origin of Change:**

- Suggestion by IACS members

**.2 Main Reasons for Change:**

In order to introduce new provisions into the ESP Code which were found among the ESP Code and relevant URZ10s, a series of items of UR Z10s shall be amended accordingly with ESP Code.

**.3 List of non-IACS Member Classification Societies contributing through the TC Forum and/or participating in IACS Working Group:**

None

**.4 History of Decisions Made:**

Panel members discussed this issue under PSU17018: updating the CSR reference for both HCSR and CSR for oil tanker; figures 5-8 in paragraph 7.3 were to be replaced with new accurate figures; "Thickness measurement company" was to be replaced with "Thickness measurement firm" throughout the UR; some paragraphs were to be revised for consistency with ESP Code; etc.

During the 26<sup>th</sup> Survey Panel Meeting, the Panel discussed the divergence and reached agreements with the revisions.

No TB is expected for the present revision.

**.5 Other Resolutions Changes**

UR Z10.1, UR Z10.2, UR Z10.3, UR Z10.5

**.6 Dates:**

Original Proposal: 22 October 2016 by a Survey Panel Member  
Panel Approval: 24 December 2017 by Survey Panel (Ref: PSU17018)  
GPG Approval: 15 January 2018 (Ref: 17189\_IGc)

- **Rev.14 (Nov 2016)**

**.1 Origin of Change:**

- Suggestion by IACS members

## **.2 Main Reasons for Change:**

To address the Observation 04, raised by the IMO Auditing Team 5 of the IACS common package 1 in respect to the functional requirements (FR) 9-15.

## **.3 List of non-IACS Member Classification Societies contributing through the TC Forum and/or participating in IACS Working Group:**

None

## **.4 History of Decisions Made:**

Based upon a GPG Member's proposal, the Panel examined, under the task PSU16017, the possible modification of the UR Z10.2 in order to include the verification of the Ship Construction File (SCF) during the class periodical surveys for those ships subjected to the requirements of SOLAS reg. II-1/3-10.

The suggested text was discussed by the Members and it was agreed that since the issue might be regarded as a proactive extension of the corrective action to OBS 04 this should be inserted under paragraph 6.4.2 of UR Z10.2.

Members reviewed the proposed text together with the relevant proposals of its modification; during the 24th Survey Panel meeting agreed to add the new paragraphs 6.4.2.1 and 6.4.2.2 dealing with the verifications of the Ship Construction File to be performed during the periodical surveys.

No technical background is expected for this revision.

## **.5 Other Resolutions Changes**

The amendment affects UR Z10.2 and UR Z 10.5.

## **.6 Dates:**

Panel Approval: 09 September 2016 - 24th Survey Panel Meeting

GPG Approval: 22 November 2016 (Ref: 16077\_IGd)

## **• Rev.13 (Feb 2015)**

### **.1 Origin of Change:**

- Suggestion by an IACS member
- Other (following EMSA query received through IACS Accredited Representative to IMO)

### **.2 Main Reasons for Change:**

- a) To consider appropriate text in IACS document regarding the applicability of the Thickness Measurements when the Close up survey is performed.
- b) To reword the note of Table I as appropriate in order to consider also the structures associated to corrugated bulkheads
- c) To specify the minimum content of the Tank Testing guideline cited at paragraph 2.5.1.bullet a)
- d) To correct a circular reference in paragraph 4.2.2.1 by modifying the table V

### **.3 List of non-IACS Member classification societies contributing through the TC Forum and/or participating in IACS Working Group:**

None

### **.4 History of Decisions Made:**

- a) Following an ACB query an IACS member proposed to add suitable text in appropriate IACS documents regarding the application of the Thickness Measurements when the close up surveys are performed as survey requirement due at the Intermediate/ Renewal Class surveys. This Member expressed the view that the requirements to execute the Thickness Measurements of the area subject to Close Up Surveys are expected into the table relevant to "MINIMUM REQUIREMENTS FOR THICKNESS MEASUREMENTS AT SPECIAL SURVEY ....." while the paragraph 1.4 of the document contains only the requirement that "Thickness Measurements of the areas subject to close up surveys shall be taken in conjunction with the close up survey".

Panel discussed the matter under item PSU13051 and considered that wordings of Para 1.4 of current UR Z7s/10s need to be revised in order to clarify this issue; finally Panel agreed to add additional wording to Para.1.4.

- b) An IACS Member proposed to modify the note 7 of table I relevant to the structure of the longitudinal bulkheads in order to consider also the case where corrugated bulkheads are fitted. Being the structural arrangement of the corrugated bulkhead quite different from that of the plain bulkheads, the wording "longitudinal bulkhead vertical girder" was applicable only to plain bulkhead being the vertical girder not existing or differently realised for the corrugated type. Panel agreed to modify the wording from the existing one to "longitudinal bulkhead structural members".

Considering items a) and b) Panel agreed

- 1) to add additional wording to Para.1.4;
- 2) to modify note 7 of table I

- c) An IACS Member following the discussion of PSU 14017 (relevant to the drafting of a Guidelines for Master tank testing) proposed to improve the content of the bullet a) of paragraph 2.5.1 of the UR by inserting the description of the minimum requirements that need to be specified inside the "Cargo Tank Testing Procedure" to be used when Master of a Tanker is allowed to perform the cargo tank testing. Panel concurred with the proposal (ref. message PSU14017 ISUc), the sentence has been modified as follow

"a tank testing procedure, specifying fill heights, tanks being filled and bulkheads being tested, has been submitted by the owner and reviewed by the Society prior to the testing being carried out";

- d) Owing to a request of clarification by part of EMSA, relevant to the paragraph 4.1.2 of Annex B Part A of 2011 ESP Code (IMO Res. A.1049(27)) received from IACS Accredited Representative to IMO, Survey Panel performed a review of the corresponding paragraph 4.2.2.1 of UR Z10.4. Panel verified that a circular reference was present due to the content of table V. Panel agreed to modify the

table by introducing a brief summary of the survey requirements based on the ship's age. The task has been dealt with under Panel business PSU14025

- e) A reference error was noted in paragraph 2.4.6: the requirements for the evaluation of the ship's strength are set in paragraph 9.1.1.1 instead of the paragraph 8.1.1.1. The error has been corrected.

#### **.5 Other Resolutions Changes**

- i) The amendment a) affects UR Z7, UR Z7.1, UR Z7.2, UR Z10.1, UR Z10.2, UR Z10.3 and UR Z 10.5.
- ii) The amendment b) affects also UR Z10.3
- iii) The amendment c) affects also UR Z10.1, UR Z10.3

#### **.6 Dates:**

Panel Approval: Amendment a) at 19th Survey Panel Meeting (6 March 2014)  
Amendment b) by correspondence under PSU13051  
Amendment c) on 29 July 2014 by correspondence under PSU14017  
Amendment d) on 29 August 2014 by correspondence under PSU14025

GPG Approval: 05 February 2015 (14193\_IGc)

### **• Rev. 12 (Jan 2014)**

#### **.1 Origin of Change:**

- Suggestion by IACS members
- Suggestion by GPG

#### **.2 Main Reason for Change:**

- a) To consider appropriate text in IACS document regarding class period for lengthy conversions.
- b) To align the difference between PR37 and URZ's regarding safe entry to confined spaces.

#### **.3 List of non-IACS Member classification societies contributing through the TC Forum and/or participating in IACS Working Group:**

None

#### **.4 History of Decisions Made:**

- a) With reference to IMO Res. A1053 (27) (5.5 Application of "special circumstances") an IACS member proposed to add suitable text in appropriate IACS document regarding class period for lengthy conversions. This Member expressed that when a renewal survey has been completed, the new 5 year class period would normally be calculated from the expiry of previous class period/class certificate and in some

cases this might result in unreasonably short time from one renewal survey completion until the next renewal would be due. (PSU13024)

Panel discussed and considered that wordings of Para 2.1.3 of current UR Z7s/10s (second sentence) could address this issue but finally agreed to add additional text to Para 2.1.3 in order to clarify this matter.

- b) Panel discussed to clarify the survey requirements in PR37 and URZ's regarding safe entry to confined spaces. Panel considered that the safety issues of surveyor should be dealt by PR37. At 18<sup>th</sup> Panel meeting, Panel concluded to delete requirements from UR Z10s which were already covered by the PR37. (PSU13032)

## **.5 Other Resolutions Changes**

- a) The identical amendment affects UR Z7, UR Z7.1, UR Z7.2, UR Z10.1, UR Z10.2, UR Z10.3 and UR Z 10.5.  
b) The identical amendment affects UR Z10.1, UR Z10.2, UR Z10.3 and UR Z 10.5.

## **.6 Dates:**

Panel Approval: 7 November 2013 by Survey Panel

GPG Approval: 14 January 2014 (Ref: 12011aIGd)

## **• Rev.11 (June 2013)**

### **.1 Origin of Change:**

- Suggestion by an IACS member
- Suggestion by GPG in response to the request of EG/SoS
- Suggestion by EG/GBS in response to GPG Chairman's request in 10060fIGg

### **.2 Main Reason for Change:**

- a) To establish a consistent practice among Members through amendments to the requirements related to pressure testing of cargo tanks with the correct level of safety for accepting Master's statement that the pressure testing has been carried out according to requirements.(Ref. PSU 9014, GPG 9640)
- b) To introduce provision in UR Z10s that Rescue and emergency response equipment must be suitable for the configuration of the space being surveyed including the size of the access points.(Ref. PSU12032 GPG 12138\_)
- c) An inquiry from a member whether the 'Other equivalent means' referred in Para 5.3.2 of IACS UR Z10.2 include the use of Cherry Pickers for survey of other structures. (PSU 12022)
- d) In order to comply with the IMO Goal Based Standard (GBS), it is required to update the Ship Construction File (SCF) throughout the ship's service life.

Therefore, procedures for updating SCF have been added in UR Z10s.

### **.3 List of non-IACS Member classification societies contributing through the TC Forum and/or participating in IACS Working Group:**

None

### **.4 History of Decisions Made:**

- a) Panel considered to revise the requirements in UR Z10.1 and Z10.4 for pressure testing of cargo tank bulkheads which are not adjacent to non-cargo tanks/space for oil tankers in order to accept Master's statement at class renewal survey.

Survey Panel reported this issue to GPG and asked further instruction, and accordingly, GPG instructed Survey Panel to consider this issue based on two major opinions from GPG members (i. e. the 1st view was that IACS should expand UR Z10.1 and UR Z10.4 item 2.5.1 with a text similar to the one accepted for Chemical Carriers in UR Z10.3 item 2.5.1 while the 2nd view was that external boundaries of all cargo tank bulkheads adjacent to non-cargo tanks/spaces (e.g. facing ballast tanks, void spaces, pipe tunnels, fuel oil tanks, pump rooms or cofferdams) shall still be required to be tested in the presence of a Surveyor.

Panel discussed and agreed to amend the requirement of para 2.5.1 of UR Z10.1 and UR Z10.4 in order to accept master's statement for cargo tank testing.

- b) GPG Chairman requested to consider the suggestion of EG/SoS to clarify the wording in UR Z 10.1 – 10.5 to make it compliance with draft PR37 submitted by EG/SoS.

The Survey Panel discussed this matter and introduced a new section 5.5 "Rescue and emergency response equipment" in line with the suggestion of EG/SOS.

- c) Discussion of this matter initiated by a Panel member regarding the use of Cherry Pickers in Cargo Holds with reference of IACS URZ10.2. In accordance with UI SC191 and Rec 91, the Cherry Picker is allowed up to 17m height for Cargo Hold structure (ships constructed after 2006 for Alternative means of access). As per the provisions of URZ10.2, Cherry pickers are allowed for survey of side shell frames only.

Panel discussed and considered that Para 5.3.2 of UR Z10.2 allows the use of Cherry Pickers as 'Other equivalent means'. Accordingly, Panel agreed to clarify this matter by including text "hydraulic arm vehicles such as conventional cherry pickers" to UR Z10s and UR Z7s for a ship not subject to the above 17m restriction.

- d) At the time of reviewing the revised UR Z23 which is followed only for new construction, PT/GBS proposed that URZ10s should have provisions for updating Ship Construction File (SCF) since it would be maintained throughout the ship's service life.

Survey Panel at its 17th meeting discussed the proposals of PT/GBS for the revision of UR Z10s in order to comply the IMO GBS requirements for existing vessels. Panel agreed to add new text in URZ10.4 for updating and monitoring the SCF.



## **.5 Other Resolutions Changes**

- a) The identical amendment affects UR Z10.1
- b) The identical amendment affects UR Z10.1, UR Z10.2, UR Z10.3, and UR Z 10.5.
- c) The identical amendment affects UR Z7, UR Z7.1, UR Z10.1, UR Z10.2, UR Z10.3, and UR Z 10.5.
- d) The identical amendment affects UR Z10.2 and UR Z10.5.

## **.6 Dates:**

Panel Approval: 7 March 2013 during Survey Panel Meeting

GPG Approval: 5 June 2013 (Ref: 9640\_IGn & 10060fIGn)

## **• Rev.10 (July 2011)**

### **.1 Origin of Change:**

- Suggestion by an IACS member

### **.2 Main Reason for Change:**

Following external audit a member was advised that a small temporary doubler on a cross-deck strip of a bulk carrier should have been promptly and thoroughly repaired at the time of survey. The member carried out an investigation and found that the actions of the surveyor were fully justifiable, the temporary repair and short term Condition of Class imposed were an appropriate method of dealing with such a situation. The member advised that the current requirements for 'Prompt and Thorough Repair' stipulated under the UR 7 and UR 10 series do not give any leeway for carrying out temporary repairs (and imposing a Recommendation/Condition of Class in accordance PR 35) where the damage in question is isolated and localised, and in which the ship's structural integrity is not impaired.

The Survey Panel discussed the matter and agreed that under carefully defined circumstances a temporary repair and short term Recommendation/Condition of Class would be an appropriate course of action.

### **.3 List of non-IACS Member classification societies contributing through the TC Forum and/or participating in IACS Working Group:**

None

### **.4 History of Decisions Made:**

The matter was discussed by correspondence within the Survey Panel and at the Autumn 2010 Panel Meeting. Following discussion at which the possibility of a Unified Interpretation being raised was considered, it was eventually decided to make direct amendment to the relevant Unified Requirements.

The wording of the new paragraph to be inserted as Para 1.3.3 in all relevant Unified Requirements was extensively discussed prior to agreement.

The proposal was unanimously agreed by Survey Panel Members.

## **.5 Other Resolutions Changes**

The identical amendment affects UR Z7, UR Z7.1, UR Z7.2, UR Z10.1, UR Z10.2, UR Z10.3, UR Z10.4 and UR Z 10.5.

## **.6 Dates:**

Original Proposal: *September 2010 Made by a Member*

Panel Approval: *March 2011*

GPG Approval: *27 July 2011 (Ref: 11118\_IGb)*

## **• Rev.9 (Mar 2011)**

### **.1 Origin for Change:**

- Suggestion by IACS member

### **.2 Main Reason for Change:**

- 1) Inconsistency of the definition of transverse section of the ship given in URZ7 and URZ10s.
- 2) Update of references in the Executive Hull Summary Table IX.
- 3) To make the survey requirements in UR Z10.4 compatible with the new requirements contained in CSRs.

### **.3 List of non-IACS Member classification societies contributing through the TC Forum and/or participating in IACS Working Group:**

None.

### **.4 History of Decisions Made:**

Item 1) was proposed by RS and item 2) was proposed by GL. Both amendments were agreed by the Panel.

Regarding item 3), The Survey Panel Members decided that the task would be carried out by a Project Team, rather than through correspondence within the Panel. The PT was composed by three Members from the Survey Panel and one Member, external to the Panel, who was expert both in surveys and in structural matters. Subsequently the PT requested the Small Group on Strategy & Steering Committee that the PT were enlarged with the joining of two additional Members of the Hull Panel, in order to increase the PT's expertise in the CSRs based on the fact that CSRs would be amended, even if limitedly to requirements related to surveys after construction. The Small Group on Strategy & Steering Committee fulfilled the PT request.

## **.5 Other Resolutions Changes**

UR Z10.1, Z10.2, Z10.3 and Z10.5.

**.6 Dates:**

Original Proposal: *January 2010, made by Survey Panel*  
Survey Panel Approval: *July/November 2010*  
GPG Approval: *24 March 2011 (Ref: 10170\_IGe)*

• **Rev. 8 (Feb 2010)**

**.1 Origin for Change:**

Suggestion by IACS member

**.2 Main Reasons for Change:**

As MARPOL I was revised, the reference to MARPOL I/13 (3) in paragraph 1.2.2bis should be changed.

**.3 History of Decisions Made:**

GL proposed the change and it was agreed by the panel.

**.4 Other Resolutions Changes**

UR Z10.1

**.5 Any dissenting views**

None

**.6 Dates:**

Original Proposal: *January 2010, made by Survey Panel*  
Panel Approval: *January 2010, made by Survey Panel*  
GPG Approval: *17 February 2010 (Ref. 10009\_IGb)*

• **Rev. 7 (Mar. 2009)**

Survey Panel Task 62 - Harmonization of UR Z10s to UR Z10.3 (Rev.10)

See TB document in Part B.

• **Rev. 6 (Nov. 2007)**

Survey Panel Task 1 – *Concurrent crediting of tanks.*

See TB document in Part B.

- **Rev. 5 (Feb. 2007)**

Survey Panel Task 3 – *Maintenance of Alignment/Compatibility of IACS URs and IMO survey requirements.*

See TB document in Part B.

- **Corr.1 (Sept. 2006)**

Correction of typos as follows:

- In the note at the bottom of Table IX(iv) “POOR” is replaced with ‘less than “GOOD” and ‘part G)’ is replaced with ‘part H)’.
- In para 1 of Annex III, Appendix 2 in the definition of “Cn” for  $130\text{ m} \leq L \leq 300\text{ m}$  ‘L – 300’ has been replaced with ‘300 – L’ in accordance with IMO Resolution MSC.105(73) ( MSC 73/21/Add.2, Annex 13).

No TB document available.

- **Rev. 4 (Jun. 2006)**

Addition of text in paragraph 1.2.9 relating to CSR.

See TB document in Part B.

- **Rev. 3 (Jan. 2006)**

Survey Panel Task 22 – *Amend applicable URZ7s and Z10s to align Close-Up Survey and Thickness measurements to be carried out at the same time and location allowing for a more structured control of the thickness measurement process – plus additional changes relating to access for rafting surveys.*

See TB document in Part B.

- **Rev. 2 (Jun. 2005)**

WP/SRC Task 102 - *Harmonization of UR Z7s and Z10s*

See TB document in Part B.

- **Rev. 1 (Oct. 2002)**

UR Z10.1, 2, 3 and 4 revisions (WP/SRC tasks 91, 93 and 95)

No TB document available.

- **New (Dec. 2001)**

WP/SRC submitted the draft Z10.4 (Task 66) to GPG for approval. GPG/Council approved Z10.4 for submission to IMO DE 45 on 14 December 2001.

See TB document in Part B.

## **Part B. Technical Background**

List of Technical Background (TB) documents for UR Z10.4:

- Annex 1. **TB for New (Dec 2001)**  
See separate TB document in Annex 1.
- Annex 2. **TB for Rev.2 (Jun 2005)**  
See separate TB document in Annex 2.
- Annex 3. **TB for Rev.3 (Jan 2006)**  
See separate TB document in Annex 3.
- Annex 4. **TB for Rev.4 (Jun 2006)**  
See separate TB document in Annex 4.
- Annex 5. **TB for Rev.5 (Feb 2007)**  
See separate TB document in Annex 5.
- Annex 6. **TB for Rev.6 (Nov 2007)**  
See separate TB document in Annex 6.
- Annex 7. **TB for Rev.7 (Mar 2009)**  
See separate TB document in Annex 7.
- Annex 8. **TB for Rev.8 (Feb 2010)**  
See separate TB document in Annex 8.
- Annex 9. **TB for Rev.9 (Mar 2011)**  
See separate TB document in Annex 9.

Annex 10. **TB for Rev.10 (July 2011)**

See separate TB document in Annex 10.

Annex 11. **TB for Rev.12 (Jan 2014)**

See separate TB document in Annex 11.

**Note:** *There are no separate Technical Background (TB) documents for the Rev.1 (Oct 2002), Corr.1 (Sept 2006), Rev.11 (June 2013), Rev.13 (Feb 2015), Rev. 14 (Nov 2016), Rev.15 (Jan 2018), Rev.16 (May 2019), Rev.17 (May 2022) and Rev.18 (Feb 2023).*

**Technical Background Document  
WP/SRC Task 66  
New UR Z10.4 for Double Hull Oil Tankers**

**Objective and Scope:**

To Develop a Unified Requirement for Enhanced Surveys of Double Hull Tankers along the lines of UR Z10.1 but tailored to the structural configuration of double hull tankers and other features which distinguish double hull tankers from single hull tankers and with a view to submitting the outcome to IMO for incorporation in future amendments of A.744(18).

**Source of Proposed Requirements:**

WP/SRC developed Z10.4 in collaboration with the Permanent Secretariat through correspondence and their meeting. IACS' Post Erika measures have been incorporated in the proposed draft. In addition, Res MSC.105(73) and 108(73) have been introduced into Z10.4 since entry into force date of the aforesaid MSC Resolutions is 1 July 2002.

**Points of Discussion:**

WP/SRC unanimously agreed to the proposed draft UR Z 10.4 except with respect to 3.2.5.2. The majority of WP/SRC agreed to the proposed text of 3.2.5.2 whereas ABS and NK preferred the corresponding text of Z10.1.

Submitted by the permanent Secretariat

On 11 December 2001



**WP/SRC Task 102**  
**HARMONIZATION OF UR Z7s AND Z10s**

**Technical Background**

**UR Z7 (Rev. 11)**

**UR Z7.1 (Rev. 2)**

**UR Z10.1 (Rev. 12)**

**UR Z10.2 (Rev. 17)**

**UR Z10.3 (Rev. 7)**

**UR Z10.4 (Rev. 2)**

**UR Z10.5 (Rev. 1)**

Contents:

TB for Harmonization

**Annex 1.** TB for UR **Z10.1(Rev.12**, C49 amendments(coating-related))

**Appendix 1:** Memo for Coating, submitted to Council  
49(June 2004).

**Appendix 2:** DNV proposal (25 May 2005) agreed by Council

**Annex 2.** TB for "Verification/Signature of TM Forms" for records.

**Annex 3.** TB for revision of UR Zs concerning "anodes".

**1. Objective**

To amend UR Z7s and Z10s in order to make the texts of the above-mentioned URs consistent eliminating all the differences both in substance and in wording (WP/SRC Task 102).

**2. Background**

In the process of approving UR Z10.4, GPG found it necessary to amend the other existing URs Z10.1, Z10.2, Z10.3, Z10.6 and Z7 in order to eliminate any inconsistencies existing among them.

**3. Methodology of work**

The WP has progressed its work through many sessions, both during the periodical meetings and dedicated meetings restricted to a Small Group of Members (BV, DNV, GL, LR, RINA) who developed the work in order to be more efficient. All the proposed amendments of the Small Group have regularly been circulated to all Members for comment and agreement.

## 4. Discussion

4.1 The WP/SRC has completed a comprehensive comparative review of UR Z7 and Z10s, and identified inconsistencies which existed among them. During this review, attention was given to the severity of the requirements applicable to the same spaces/structural areas on different types of ESP ships. As a result, the inconsistencies were eliminated making the URZs harmonized. However, there has been no change to the scope and extent of the survey requirements.

4.2 The starting point for each UR was the most updated version available at the time of commencement. Any revision to the URZs, which were introduced during this task, was taken into account. As for instance, the UR Z10.1 was initially amended based on Rev. 9, while the last amendments are based on Rev. 11 and the UR Z10.2 was initially amended based on Rev. 13, while the last amendments are based on Rev. 16. The proposed revisions of URs Z10.1 and Z10.4 have not been numbered, as there will be revisions to those URs before the revisions introduced by the Task 102 are adopted. In fact, GPG is currently developing a Revision 12 of Z10.1 with the view to introducing significant improvements in the survey regime for ballast tanks (including combined cargo/ballast tanks) of oil tankers and UR Z10s applicable to oil tankers will also have to be revised by incorporating the amendments to A.744(18) contained in Resolution MSC 144(77), which enter into force 1 January 2005 (see 4.3 below).

4.3 Also, in harmonizing UR Z10.1 and Z10.2 care has been taken to align the corresponding text with that of IMO Res. A.744(18). However, it has been noted that the amendments to A.744(18) contained in Resolution MSC 144(77), which enter into force 1 January 2005, have not been incorporated into the IACS UR Z10s applicable to oil tankers. It seems that the updating of the above-said UR Z10s will be done by the Perm Sec and reviewed by the WP/SRC Chairman and then circulated for adoption by GPG with concurrence of Council Members for uniform application from 1 January 2005. It is understood that the revisions of the UR Z10s affected by those amendments will not include the changes introduced by the Task 102, as the implementation date proposed for those changes is 1 January 2006 (see below **6. Implementation**).

4.4 In the course of the work the WP has been developing for more than two years, several additional Tasks were assigned to the WP by GPG which affected the development of Task 102. The additional tasks which have been taken into account are the following:

- 1) In the course of Council discussion on UR Z10.6 (General Cargo Ships), certain inconsistencies were identified between Z10.6 and other Z10s. WP was instructed to expedite Task 102 (1060gIAa, 12 June 2002);
- 2) WP was instructed to include "Survey Planning for Intermediate Survey" into harmonization work (2108\_IAa, 12 July 2002);
- 3) GPG instructed WP to consider whether Z10.6 should be re-assigned as Z7.1, in connection with the harmonization work. 1060gIAb, 20 Sept 2002.

- Z7.1 developed;
- 4) Partial outcome (Z7 and Z7.1) was submitted to GPG on 17 July 2003(1060g). Council decided that approval of Z7(Rev.10) and Z7.1(Rev.2) is postponed until the harmonization is completed (1060gICb, 6 April 2004);  
[Council Chairman instructed WP/SRC to Members' comments on the draft revision of UR Z7 and Z7.1 \(collected under s/n 1060g, 1060gNKi \(30/03/2004\) in particular\) on 6 April 2004.](#)
  - 5) GPG tasked WP to include the amendments to Z10.2 / Z11 (BCs with hybrid cargo hold arrangements), deleting sheets 15 and 16 for ore carriers, into the harmonized UR Z10s (2212aIGa, 19 Jan 2004);
  - 6) GPG tasked WP to consider whether the requirements relevant to examination of Fuel Oil Tanks in the cargo area at each Special Survey should be put into Z10s, and internal examination of FOT at Intermediate Survey after SS 2 is needed. (1060gIAf, 30 Jan 2004);
  - 7) GPG tasked WP to harmonize tank testing requirements in Z7s and Z10s. (3006IIAa, 5 April 2004);
  - 8) GPG tasked WP with Task 108 - Develop uniform survey requirements for air vent pipes including the welded connection to deck. Z22 developed. GPG instructed WP to incorporate Z22 into the harmonized Z10s;
  - 9) GPG tasked WP with Task 114 - Verification and signature of TM reports. REC 77(Rev.1) developed and approved on 29 July 2004. Council approved parallel amendments to Z7.1 and Z10s (TM Forms included) and instructed WP to incorporate these into the harmonized Z10s:
    - [Recommendation No.77 was revised \(Rev.1, July 2004\);](#)
    - [Z7.1 para.6.3.2 and Z10s para.7.3.2 so amended.](#)
    - ["Surveyor's signature" is deleted from all TM Forms in Z10s;](#)
    - [A note is added to Annex II\(Z10s\) declaring that Annex II is recommendatory.](#)

WP/SRC's investigation into Members' practice in dealing with verification and signature of TM reports is annexed for record keeping purpose. [See Annex 2.](#)
  - 10) GPG tasked WP to consider the BV comments on "TM may be dispensed with..." and include the findings into the harmonized Z10s ( 2219iIAa, 7 April 2004).

## **5. Agreement within the WP/SRC**

All Members have unanimously agreed the attached final versions of UR's.

## **6. Implementation**

WP/SRC is of the view that the Members need 12 months from the adoption date to implement these amendments into their class rules. Assuming Council adoption in December 2004, WP/SRC would propose January 2006 as implementation date.

- Annex 1:** TB for UR Z10.1(Rev.12, C49 amendments, see Permsec's note 1 below)  
**Annex 2:** WP/SRC Task 114, verification and signature of TM reports(see 9 above).  
**Annex 3:** TB for revision of UR Zs concerning "anodes".

### **Note by the Permanent Secretariat**

1. Annex 1 to this TB contains background for amendments to UR Z 10.1(Rev.12) relating to FAIR/POOR/GOOD (C49 amendments). Council at its 49<sup>th</sup> meeting (June 2004) agreed/decided that comparable changes should be added to Z10.3 and Z10.4.

2. Appendix 3 "TM sampling method" has been added to UR Z10.1 and Z10.4 to keep them consistent with IMO Res.MSC.144(77). The amendments to A.744 contained in MSC.144(77) entered into force on 1 January 2005. (*GPG s/n 4181*)

Under s/n 4072g, paragraph **2.4.6** of UR Z10.1 and **2.4.6** and of UR Z10.4 (paragraph numbering is now harmonized) were amended in order to provide a link between the main text of the UR Z10.1 and 10.4 and the new Annex III Appendix 3 containing the MSC Res.144(77).

Further, it was agreed that the requirements for evaluation of longitudinal strength of the hull girder (as written in MSC.144(77)) should not be required for Intermediate Survey unless deemed necessary by the attending Surveyor. This is covered in 4.2.3.1 and 4.2.4.1 of Z10.1 and Z10.4.

3. GPG agreed that the amended UR Zs should be implemented from 1 July 2006 altogether.

4. DNV's proposed amendments to UR Z10.1, Z10.3 and Z10.4 concerning annual survey of ballast tanks were agreed by Council (1060gICq, 27 June 2005). See Appendix 2 to Annex 1.

5. Annex 3 contains a TB for revision of UR Zs concerning "anodes".

Date: September 2004  
Prepared by the WP/SRC

-- --

## **Annex 1 to Technical Background**

### **UR Z 10.1 (Rev.12, C49 amendments(coating-related))**

#### **1. Objective**

To introduce significant improvements in the survey regime for ballast tanks (including combined/ballast tanks) of oil tankers as matter of strategic concern and urgency to IACS, given the aging of both the single and double hull tanker fleets and the problems encountered with corrosion of ballast tanks in several shipping casualties.

#### **2. Background**

Draft amendments to UR Z10.1 were submitted to Council 47 (June 2003) and agreed in principle.

#### **3. Discussion**

There was particular concern over accelerated corrosion with age (as the thinner the material, the more rapidly the allowable diminution margin percentage disappears) especially where coatings have broken down. There is also a disincentive for any spend on maintenance of the structure of a ship within a few years of its statutory scrapping date.

Council discussion by correspondence had evolved to the position of substantive proposals – summed as follows (3095\_ABa, 2 June 2003):

1. Enhance the Intermediate Survey in Z10.1, Z10.3 and 10.4 for Tankers after 2<sup>nd</sup> Special / Renewal Survey to the same level (scope of work) as the preceding Special / Renewal Survey). This corresponds to the latest revision to UR Z10.2.
2. At Annual Survey of ballast tanks with substantial corrosion, the overall survey is to be replaced by close-up survey with thickness measurements of the exposed area.
3. Proposed to task WP/SRC to re-consider the acceptance criteria for the rating FAIR further. For this, eliminate FAIR, leaving only GOOD and POOR redefined as appropriate.
4. Proposed to task WP/SRC to explicitly require close-up survey of Suspect Areas identified at the previous Special Survey.

Council 47 discussed the proposals(June 2003) as follows:

##### **1. Definition of FAIR**

Council 47 agreed that “FAIR” would be retained as a rating and that GPG should instruct WP/SRC to redefine FAIR, so that there would be a clear differences between FAIR, POOR and GOOD. It was also agreed that for oil tankers the Intermediate Survey following Special Survey No.2 would have the same scope as Special Survey No.2(Z10.1). WP/SRC should also clarify the definition of satisfactory repair.

Based on the strong majority, Council agreed to discuss with Industry annual surveys of ballast tanks when coating is found in LESS than GOOD condition at special survey, with the objective to encourage the owner to carry out repairs and maintenance of coating to GOOD condition.

*DNV and NK stated that they could not accept a requirement for annual surveys of ballast tanks when the coating condition is less*

*than GOOD and proposed that GOOD be changed to FAIR (3095\_IGc, 30 June 2003)*

2. ABS' proposed amendments to Z10.1(annual examination of BWTs in certain conditions) were approved.
3. C 47 agreed that the BWT coating requirements (Z10.1.2.2.3) for intermediate Survey after SS 2 should be the same extent to the previous SS.
4. Given the substance of the changes, the revised Z10.1 should be shown to Industry before adoption.
5. A guidance for coating repairs needs to be developed by WP/SRC with reference to TSCF Guidelines.

Following Council 47, the draft text of Z10.1(Rev.12) was distributed to Industry and discussed at the IACS/Industry meeting on 29 August 2003. Industry indicated that UR Z10.1(Rev.12) is acceptable, provided that appropriate IACS guidelines on coating repairs are developed.

The Small Group on Coating (SG/Coating) under WP/SRC prepared draft guidelines on coating repairs and considered the definitions of GOOD / FAIR / POOR. The SG/Coating did not change the definitions and found that the Guidelines provide useful clarifications on the definitions and criteria in achieving an industry wide uniform judgement of coating conditions as well as what is needed to restore GOOD conditions.

Further, an IACS/Industry JWG/Corrosion was established and met in February 2004. The outcome is (3095\_IGh, 4 June 2004):

- Draft Guidelines on Coating Repair (IACS REC 87)
- Draft UR Zxx (mandatory coating of cargo tanks on oil tankers)
- Draft UI SC 122 (Rev.2) – mandatory coating of ballast tanks

#### **4. Others**

1. Z10.11.2.2bis - Definition of “Combined Cargo/Ballast Tank. ...as a routine part of the vessel's operation and will be treated as a Ballast Tank. ...”. By so amending, Z10s do not need to repeat “Ballast Tanks and Combined cargo/salt water Ballast Tanks” in addressing the ballast tanks. Hence, all the references to “and Combined cargo/salt water Ballast Tanks” were deleted.
2. Z10.1.2.2.1.2: The aim of the examination is to be sufficient to discover substantial corrosion...  
Comparable changes are to be added to other UR Zs wherever the same sentence occurs.
3. “IACS Guidelines for Coating Maintenance & Repairs for Ballast Tanks and Combined/Ballast tanks on Oil Tankers” are referenced where relevant.
4. Comparable changes are to be added to UR Z10.3 and Z10.4, after adoption of Z10.1(Rev.12).

**Attached: Memo on Coating Matters (GPG Chairman)**

9 June 2004  
Prepared by the Permsec

## **Appendix 1 to Annex 1:**

## **MEMO on Coating matters**

### **1. Background and discussion within IACS on UR Z10.1 (draft Rev.12) between 29/01/03 and 14/08/03**

In view of the survey experience with oil tankers, it was proposed that all ballast tanks should be examined, routinely and uniformly, at annual surveys on ESP tankers exceeding 15 years of age. IACS should amend UR Z10.1 to require the examination of ballast tanks on such ships at each annual survey. This is simple, clear and thorough and not subject to interpretation. (2242\_ABq dated 29/1/03)

Then, ABS modified the proposal asking, for tankers subject to URs Z10.1, Z10.3 and Z10.4, exceeding 15 years of age, that the current requirement - pertaining to annual examination of Ballast Tanks adjacent to cargo tanks with any means of heating - be deleted and replaced by a simpler and more stringent requirement that all Ballast Tanks be subject to survey at each subsequent annual survey where either substantial corrosion is found within the tank or the protective coating is found to be in less than GOOD condition and the protective coating is not renewed at special survey or intermediate survey. This will ensure that all Ballast Tanks with substantial corrosion or protective coating which is not in GOOD condition at the time of special survey or intermediate survey will be examined at each subsequent annual survey on tankers exceeding 15 years of age. (2242\_ABzb dated 14/3/03)

This was later expanded to include all tanks used routinely for ballast water, both ballast-only and cargo/ballast tanks (2242\_ABzc dated 14/3/03).

ABS further reviewed the issue of the survey of salt water ballast spaces and combined cargo/salt water ballast spaces with ABS' governing bodies in light of recent casualties and survey findings on other tankers. Their review found an increasing amount of coating breakdown/failure and subsequent rapid wastage in key structures after Special Survey No. 2, i.e. after 10 years of age. These conditions are most prevalent in the under deck structure and the side shell structure in way of the deep loadline. In a number of cases the serious wastage has caused fracturing of the under deck longitudinals and in some cases fracturing has extended to the main deck structure. This led ABS to refine proposed amendments to URs Z10.1, Z10.3 and Z10.4 to require (2242\_ABzf dated 9/5/03):

#### a. For Tankers exceeding 10 years of age

Salt Water Ballast Spaces and Combined Cargo/Salt Water Ballast Spaces. For tankers exceeding 10 years of age, salt water ballast spaces and combined cargo/salt water ballast spaces are to be internally examined at each subsequent Annual Survey where substantial corrosion is found within the tank or where the protective coating is found to be less than GOOD condition and protective coating is not repaired. Internal examination to be an Overall Survey.

#### b. For Tankers exceeding 15 years of age:

Salt Water Ballast Spaces and Combined Cargo/Ballast Spaces. For tankers exceeding 15 years of age, salt water ballast spaces and combined cargo/ballast spaces are to be examined internally at each subsequent Annual Survey. Where substantial corrosion is found within the tank, or where the protective coating is found to be in less than GOOD condition and the protective coating is not repaired then in addition to an Overall Survey, under deck structure and the side shell structure in way of the deep loadline is to be subject to Close-up Survey.

NK and BV replied that the proposed amendments made by ABS need to be substantiated in a transparent manner with technical data that ABS may possess and put forward for further assessment and discussion. (2242\_NK<sub>n</sub> dated 14/5/03 and 2242\_BV<sub>z</sub> dated 16/5/03)

**DNV** (2242\_NV<sub>n</sub> dated 2/6/03), having carefully considered the practical consequences of taking the ship off-hire for gas freeing etc. and being concerned about the difficulties to have these surveys executed in a safe manner and whether the intended safety benefits in implementing the proposed extended scope of the annual survey of Ballast tanks will be met, **proposed the following alternative measures** which would be as effective and may not have such delaying effects to the ship:

- 1) Enhance the Intermediate Survey in UR Z10.1, 10.3, and 10.4 for Tankers after the 2 Special / Renewal Survey to the same level (scope of work) as the preceding Special / Renewal Survey. (This will correspond to the latest revised requirements of UR Z10.2 for Bulk Carriers.)
- 2) At Annual Survey of ballast tanks with substantial corrosion the overall survey should be replaced by close up survey with thickness measurements of the exposed area. (An overall survey of these tanks does not give sufficient information of the development of the areas with substantial corrosion.)
- 3) Further we will not fail to mention that the WP/SRC has proposed to extend the close up survey in cargo and combination tanks to 30% from the 3 Special / Renewal Surveys.
- 4) **Experience has shown that the coating condition rating category FAIR has a tendency to be stretched too far into the POOR condition. We will therefore propose that we task the WP/SRC to reconsider the acceptance criteria for the rating FAIR further.**
- 5) We do also question the need for redefining the definition of combination tanks, particularly since the category I tankers which are the ships that normally are fitted with these type of tanks are to be phased out 2 to 4 years from now. However DNV will not oppose to such a redefinition.

**DNV requested Members to consider the above as an alternative to the ABS proposal, bearing in mind that we ought to present this to the industry prior to deciding.**

ABS (3095\_Aba dated 2/6/03), having further considered its earlier proposals in light of NV<sub>n</sub>, submitted a revised proposal for consideration by Council at C47 and replied to the above 5 DNV proposals as follows:

- 1) ABS fully supports this proposal.
- 2) While ABS agrees with this proposal, it is in fact already provided for in Z7 (3.2.3) and Z10.1 (3.2.5.1)--which require that "Suspect areas (which include any area where substantial corrosion is found) identified at previous Special Survey are to be examined. Areas of substantial corrosion identified at previous special or intermediate survey are to have thickness measurements taken." To us, this implies that close-up survey of these areas is to be done at annual survey in conjunction with the thickness measurements. However, we can



agree to tasking WP/SRC to explicitly require "close-up" survey in this connection and to amend Z7, and all the Z10's, appropriately to make this explicit, if there is majority support for this.

- 3) We agree that this has been put forward to GPG by WP/SRC via 0237hNVb, 27 May. However, these additional CAS close-up survey requirements do not apply to salt water ballast tanks; only to cargo oil tanks and combined cargo/ballast tanks.
- 4) **We agree with this assessment and we propose that the only way to eliminate the subjectivity and raise the standard is to eliminate the category "FAIR" completely; leaving only "GOOD" and "POOR" redefined as follows:**  
**"GOOD -- condition with no breakdown or rusting or only minor spot rusting.**  
**POOR -- any condition which is not GOOD condition."**
- 5) ABS does not agree with this proposal. We are particularly concerned that we need a very thorough and robust survey regime for these tankers precisely because they are subject to mandatory phase out over the next several years. We are very concerned that without additional IACS requirements, these tanks will receive little or no inspection and maintenance by owners or others after their last special or intermediate survey, if no substantial corrosion is found at that time. Rapid, localized wastage in way of deteriorating coatings may pose significant hazard if the survey regime is not further tightened as we are proposing.

In conjunction with the above comments on DNV proposals, ABS further considered their previous proposal in ABzf and modified it as follows:

- **ABS simplified the proposal to require annual examination of all salt water Ballast Tanks and combined Cargo/salt water Ballast Tanks irrespective of age, when either substantial corrosion is found within the tank or the protective coating is found to be in less than GOOD condition and is not repaired.**
- the requirement for annual (close-up) examination of salt water ballast tanks and combined tanks is already required in Z10.1 (3.2.5.1). ABS proposed adding it to 2.2.3 for clarity and emphasis so that all the conditions which may lead to annual examination of such tanks are listed together in one place.
- Since the principal problem that we are trying to address is rapid, localized corrosion in way of breakdown or deterioration of the protective coating, we are proposing that the coating condition should be found and kept in "GOOD" condition to obviate the need for annual examination. **The attached proposal is made together with the proposals in items 3.1 (intermediate following Special survey 2 to have same scope as prior Special survey) and 3.4 (eliminating "FAIR" and redefining "POOR" as any condition other than "GOOD" condition.**

ABS requested to decide on a course of action at C47 for tightening the survey regime for tankers. They agreed that industry be informed of Council's decisions in this regard prior to IACS making the decision public, but IACS should maintain its independence and take decisive action in this matter. Debate with industry can only lead to delay and to a watering down and compromising of these important requirements.

NK agreed to task WP/SRC to reconsider the acceptance criteria of "FAIR" for clearly define the border between "FAIR" and "POOR" condition. However, **NK strongly opposed the elimination of "FAIR" coating condition from UR Zs** because this can not resolve to remove subjectivity of coating assessment. The three-categorization system of coating condition should be retained. (3095\_NKa dated 5/5/03)

## **Outcome of C47**

At C47, it was agreed that "Fair" would be retained as a rating and that GPG should instruct WP/SRC to redefine "Fair", so that there would be a clear differentiation between "Fair", "Poor" and "Good". It was also agreed that for oil tankers the Intermediate Survey following Special Survey No.2 would have same scope as Special Survey No.2 (Z10.1). WP/SRC should also clarify the definition of satisfactory repair.

Based on strong majority support Council agreed to discuss with Industry annual surveys of ballast tanks when coating is found in LESS than GOOD condition at special survey, with the objective to encourage the owner to carry out repairs and maintenance of coating to GOOD condition.

This matter should be discussed with Industry prior to adoption of any UR by Council.

In a final summary, the Chairman proposed that a constructive dialogue with Industry should take place on the IACS proposal as set out in WP1 plus maintaining 3.2.5.2 modified to say that ballast/combined ballast/cargo tanks will be subject to annual survey when considered necessary by surveyors.

After discussion in the JWG (Industry/IACS), GPG should propose final rules for this matter to Council, including acceptable repair definition.

**FUA 17:** *To instruct WP/SRC to develop guidance on coating repairs and more precise definition of "Fair" coating condition.*

Once approved, these requirements should be incorporated into Z10.3 and Z10.4.

### **FUA 15**

1) *To prepare a draft revision to UR Z10.1 incorporating C 47 decisions:*

- *The definition of "FAIR" remains as it is;*
- *ABS proposed amendments to Z10.1 (annual examination of BWTs in certain conditions) were approved;*
- *C47 agreed that the BWT coating requirements (Z10.1.2.2.3) for Intermediate Survey after Special Survey No.2 should be the same extent to the previous Special Survey.*
- *Given the substance of the changes, the revised UR Z10.1 should be shown to Industry (OCIMG/Intertanko first among others) before adoption for their review and comments.*
- *A guidance for coating repairs needs to be developed by WP/SRC with reference to TSCF Guidelines.*

2) *GPG Members are to confirm the draft revision to Z10.1 in consultation with their WP/SRC members by correspondence. See 3095\_IGa of 13/06/03.*

According to C47 FUA 15, GPG Chairman circulated (3095\_IGa dated 13/6/03) draft amendments to UR Z10.1 as agreed in principle at C47.

Having received a number on comments, GPG Chairman (3095\_IGb dated 27/6/03) informed that the Council Chairman confirmed that GPG is not to amend the principles agreed at C47, i.e. we are not empowered to change "GOOD" to "FAIR" as proposed by DNV and NK, nor to amend the definitions of "FAIR" and "POOR" as proposed by DNV.

DNV's intention to possibly lodge a reservation was noted, however the matter should be raised at Council and not be dealt with by GPG. An amended draft text incorporating the non-substantive changes proposed by Members was circulated.

DNV said that its understanding was that the draft should be circulated to the Industry (ICS, INTERTANKO, and BIMCO) prior to adoption by Council. (3095\_NVc dated 30/6/03)

GPG Chairman (3095\_IGc dated 30/6/03) circulated a draft amendment of UR Z10.1 for Council's agreement and use in discussions with the industry associations.

The draft was generally agreed by GPG but individual Members have requested that the following matters (which were deemed to be outside the remit of GPG in this task) be brought to Council's attention for further consideration:

- 1 DNV and NK stated that they can not accept a requirement for annual surveys of ballast tanks when the coating condition is less than GOOD and propose that GOOD be changed to FAIR.
- 2 In connection with item 1 above, DNV also propose to amend the definitions of FAIR and POOR in order to raise the standard of FAIR.

Council Chairman (3095\_ICb dated 14/8/03) concluded that Council has agreed that the draft amendments to UR Z10.1 attached to IGc reflect Councils' decision taken at C47 and that they be circulated to industry associations.

Perm Sec was therefore invited to submit the draft to OCIMF and INTERTANKO in view of discussion at the IACS/ industry meeting on 29 August.

## **2. Discussion with Industry (29/08/2003 – 11/10/2003)**

As requested by Council, the whole matter was presented to Industry during the “general matters” meeting with IACS held on 29 August 2003; comments from Industry were requested. In the following an extract from the minutes of the meeting (see message 3100aIAb dated 5 September 2003):

\_\_\_\_\_ from Meeting minutes \_\_\_\_\_

## **4. & 5. Annual surveys of ballast tanks and IACS guidelines on coating repairs**

M. Dogliani introduced the matter ([see Items 4&5 in Appendix](#)).

A. LinoCosta gave a presentation to show where concerns and decisions stand: too many cases when coating was considered fair at SS but problems occurred just after one/two years.

N. Mikelis commented on draft amendments to Z10.1 (Rev.11) stating that the extent of annual survey is not clear; it should be limited to the affected zones, e.g. coating breakdowns, only.

M. Guyader clarified that, in this draft amendments, it is expected an overall survey of the whole tank and a close up survey of the affected zones.

N. Mikelis noted that, in the draft amendments to Z10.1 (Rev.11), the intermediate survey at 12.5 years would have the same scope as the previous special survey and that needed a justification. See 7 a).

M. Dogliani said that Z10.1 (Rev.11) was adopted in August 2003 and will be introduced into IACS Societies' Rules over the next year.

### Conclusions:

4.1 Industry shared IACS concerns on coatings and, in general, agreed with the draft amendments to Z10.1 (Rev.11) suggesting also extending them to Z10.2 on bulk carriers

4.2 Industry agreed that a guideline for surveyor on coating would greatly improve uniform application of so-amended Z10.1 including issues such as how to consider load bearing elements when judging GOOD/FAIR/POOR status and how to consider bottom pitting in connection with GOOD conditions

4.3 Industry will more precisely comment, by the end of September, the draft Z10.1 so as for IACS to finalise the matter, as planned, for the Council's December meeting.

Item	Title	Industry recommendation	IACS/ M. Dogliani Introduction
4 & 5	Annual survey of ballast tanks IACS guidelines on coating repairs	NN	<p><b>1. IACS is considering the following:</b></p> <ul style="list-style-type: none"> <li>- <b>amend UR Z10.1 (draft circulated to Industry) to the effect that in case at Special Survey or Intermediate Survey the coating in a ballast tank is found less than GOOD, either GOOD conditions are restored or the tank's coating is inspected at each annual survey;</b></li> <li>- <b>develop IACS guideline to assist an uniform application of the so modified (if adopted) UR Z10.1; the guideline should address which repairs are necessary to restore GOOD conditions from FAIR and POOR respectively and which are the criteria for the restored (after repair) situation to be rated as GOOD.</b></li> </ul>

\_\_\_\_\_ End of extract from minutes \_\_\_\_\_

INTERTANKO commented (see R. Leslie email to GPG dated 25 September 2003):

- expressing their concern for the draft Z10.1 and underlining
  - a) targeting: concerns that, if not properly dealt with, Z10.1 would target all ships and not just those which need intervention; the view was expressed that guidelines would probably solve the matter;
  - b) definition: indicating that the current definitions of GOOD, FAIR and POOR is not clear enough and that the matter would be even worst with GOOD and NON GOOD; again it was indicated that guidelines could solve the matter;
  - c) expertise: expressing doubts on IACS' surveyors expertise and ability to judge coating conditions; in this respect they (hiddenly) suggest that IACS position is unclear when we say that we are not competent to judge the coating during construction but then we are competent to judge coating during operational life. Even if not explicitly stated, the impression is that also in this case guidelines would help.

Additionally, INTERTANKO suggested a (quite detailed) set of assessment criteria.

The matter was then finally addressed at the TRIPARTITE Meeting (held in Soul on 29/30 September 2003). There Industry agreed that the way forward was the (joint) development of IACS guidelines (see minutes attached to message 3100\_RIe dated 11 October 2003, an extract of which is reproduced below).

\_\_\_\_\_ Extract from the TRIPARTITE minutes \_\_\_\_\_

Industry is concerned by the definition of GOOD/NOT GOOD in relation to coating repairs and acceptance criteria. Industry agreed that new guideline on this, which IACS is already producing, was the way forward.

\_\_\_\_\_ End of the extract from the minutes \_\_\_\_\_

### **3. Further developments**

- a) from the above, it was concluded that, provided the guidelines are sound, Industry would accept the concept of Z10.1 (draft) Rev. 12, therefore an IACS team and a JWG were established in order to progress the matter of the guidelines (among other related matters).
- b) the team of IACS experts on coating developed draft guidelines and provided recommendations to GPG on the way forward (attached to message 3095bNVc dated 20 November 2003).
- c) the guidelines were discussed within the JWG with Industry (see draft minutes circulated within GPG with messages 3095cIGd and 3095cIGe both dated 13 March 2004)
- d) further suggestions and comments (as requested at the meeting) were provided by Industry (not circulated to GPG)
- e) Bulk Carrier Industry is recommending that similar guidelines are developed in due time also for bulk carriers
- f) at DE47 and MSC78, IMO is asking Industry and IACS to develop (compulsory) performance standards for coating of newbuilding (double hull spaces of DSS Bulk Carriers), a matter which is, indirectly related to the above one.

1 June 2004

M. Dogliani

IACS GPG Chairman

IACS JWG/COR Chairman

Appendix 2 to Annex 1: [DNV proposal to Z10.1, Z10.3 and z10.4](#) ▶

Sent Monday, July 4, 2005 4:45 pm

To [Gil-Yong <gilyonghan@iacs.org.uk>](mailto:Gil-Yong <gilyonghan@iacs.org.uk>)

Cc

Bcc

Subject Fw: 1060gNVs; WP/SRC - Task 102 - Harmonization of UR Z 7 and Z 7.1

Attachments [Doc1.doc](#)

25K

----- Original Message -----

From: "Debbie Fihosy" <[debbiefihosy@iacs.org.uk](mailto:debbiefihosy@iacs.org.uk)>

To: "CCS" <[iacs@ccs.org.cn](mailto:iacs@ccs.org.cn)>

Cc: "IACS Permanent Secretariat" <[permsec@iacs.org.uk](mailto:permsec@iacs.org.uk)>

Sent: Friday, June 03, 2005 2:52 PM

Subject: FW: 1060gNVs; WP/SRC - Task 102 - Harmonization of UR Z 7 and Z 7.1

Forwarding as requested

-----Original Message-----

From: Arve.Myklebust@dnv.com [[Arve.Myklebust@dnv.com](mailto:Arve.Myklebust@dnv.com)]

Sent: 25 May 2005 15:49

To: [AIACS@eagle.org](mailto:AIACS@eagle.org); [iacs@bureauveritas.com](mailto:iacs@bureauveritas.com); [iacs@ccs.org.cn](mailto:iacs@ccs.org.cn);

[johnderose@iacs.org.uk](mailto:johnderose@iacs.org.uk); [iacs@dnv.com](mailto:iacs@dnv.com); [iacs@gl-group.com](mailto:iacs@gl-group.com);

[gilyonghan@iacs.org.uk](mailto:gilyonghan@iacs.org.uk); [helenbutcher@iacs.org.uk](mailto:helenbutcher@iacs.org.uk); [efs@iacs.org.uk](mailto:efs@iacs.org.uk);

[krsiacs@krs.co.kr](mailto:krsiacs@krs.co.kr); [richardleslie@iacs.org.uk](mailto:richardleslie@iacs.org.uk); [external-rep@lr.org](mailto:external-rep@lr.org);

[clnkiacs@classnk.or.jp](mailto:clnkiacs@classnk.or.jp); [terryperkins@iacs.org.uk](mailto:terryperkins@iacs.org.uk); [iacs@rina.org](mailto:iacs@rina.org);

[iacs@rs-head.spb.ru](mailto:iacs@rs-head.spb.ru); [colinwright@iacs.org.uk](mailto:colinwright@iacs.org.uk)

Subject: FW: 1060gNVs; WP/SRC - Task 102 - Harmonization of UR Z 7 and Z 7.1

25 May 2005

To: Mr. B. Anne, Chairman of IACS Council,

cc: Council Members, IACS Perm. Sec.

Ref.: My mail NVr dated 20 May 2005

DNV have further studied the amendments to UR Z10.1, Z10.3, and Z10.4, and as a result are presenting the following as a compromise solution:

General comment:

From the comments by other Members it is obvious that there is reluctance to accept annual surveys of ballast tanks with a common plane boundary to heated cargo tanks in the case where the coating is in good condition. This is particularly unreasonable as at the same time we enhance the Intermediate survey of Tankers between 10 and 15 years to also include examination of all ballast tanks, meaning that all ballast tanks will be close up surveyed with 2-3 years intervals from the ship is 10 years old, with the possibility for the surveyor to require thickness measurements and testing of the tanks to ensure the structural integrity of the tanks if necessary.

It is also proposed for the Intermediate survey between 5 and 10 years, to increase the scope from representative to all ballast tanks, a requirement DNV find to strict, and require that we here keep the original text.

If a ballast tank is found to have coating in GOOD condition at the renewal or intermediate survey, a deterioration of the tank beyond structural reliability is very unlikely even if the tank has a common plane boundary to a heated cargo tank.

DNV finds it particularly unreasonable to have this requirement to apply to double hull tankers for the following reasons:

- these ships have double hull and the risk of pollution is here much reduced,
- the double hull is constructed with small spaces giving improved structural reliability,
- almost all double hull tankers below VLLC have heated cargo tanks, and all ballast tanks have common plane boundaries to these tanks, meaning that this requirement will apply to a major part of the tanker fleet in the future,
- the ballast tanks of double hull tankers are so designed that a general examination of these tanks will be identical to a close up survey,
- survey of ballast tanks of double hull tankers will mean either gas freeing of all cargo tanks or at least dropping the inert gas pressure of all cargo tanks in addition to proper airing of all ballast tanks.

Since the single hull tankers will be faced out in the near future, and for clear political reasons, DNV will as a compromise proposal to keep paragraph 2.2.3.1 and 4.2.2.2 in Z 10.1 as amended by Council (ref. IAo) but amend it to not include 2.2.3.1.e, 4.2.2.2.e and last paragraph of 3.2.5.1 in Z10.3 and Z10.4. In addition we request that the original text of 4.2.2.1 is kept.

If BV, ABS and other Members can accept this DNV is willing to drop our reservation presented at C49.

DNV's proposal will then be as follows:

Z10.1:

2.2.3.1: This paragraph can be accepted as is for the reasons stated above.

3.2.5.1: This paragraph is accepted as amended.

4.2.2.2: This paragraph can be accepted as is for reasons stated above.

For other comments to Z10.1 see NVo and NVp.

Z10.3:

2.2.3.1.e to be deleted.

3.2.5.1 delete last paragraph

4.2.2.1 the original text to be kept. "For tanks used for water ballast ---"

4.2.2.2.e to be deleted

Z10.4

2.2.3.1e to be deleted

3.2.5.1 delete last paragraph

4.2.2.1 the original text to be kept, "For tanks used for water ballast --"

4.2.2.2.e to be deleted.

For details see attached document where the text for the requirements in Z10.3 and Z10.4 that DNV will accept is stated.

Best Regards

Arve Myklebust  
on behalf of  
Terje Staalstrom  
DNV IACS Council Member  
<<Doc1.doc>>

\*\*\*\*\*

Neither the confidentiality nor the integrity of this message can be vouched

Annex 2 to TB (Harmonization Z10s)

**WP/SRC Task 114 “Clarify the procedure of verification and signature of the thickness measurement report”**

Item No.	Item	ABS	BV <sup>1)</sup>	CCS	CRS	DNV	GL	IRS	KR	LR	NK	RINA	RS
<b>1</b>	<b>Verification onboard</b>												
1.1	Minimum extent of measuring points for direct verification by attending surveyor specified	No	No	No	No	No	No	No	Yes	No	No	Yes	No
1.2	Preliminary TM record to be signed upon completion of the measurements onboard	Yes	Yes <sup>7)</sup>	Yes	No (copy taken)	No <sup>3)</sup>	No <sup>6)</sup>	Yes	Yes	Yes	Yes	No <sup>8)</sup>	No
<b>2</b>	<b>Final TM report</b>												
2.1	Signature of all pages in TM record required	No	No	No	Yes	No	Yes	Yes	No	No	No <sup>5)</sup>	Yes	Yes
2.2	Signature of ‘cover’ (‘general particulars’) page only	Yes	Yes	Yes	No	Yes	No	No	No <sup>4)</sup>	Yes	Yes	Yes	No
2.3	Measuring points verified by attending surveyor required identified in TM record and signature of the corresponding pages required	No	No	Yes Without signature	Yes	No	No	No	Yes	No	No	No	No

2004-04-20

<sup>1)</sup> Instructions not clear regarding signature of the thickness measurement record

<sup>2)</sup> Signature on front and last page, stamp on all other pages, or signature on each page (IACS TM forms)

<sup>3)</sup> Upon completion of measurements onboard a draft report in electronic format (DNV TM template, including operator’s notes as relevant) to be given to attending surveyor

<sup>4)</sup> Signature of cover page, pages of meeting record and pages of attended measuring points

<sup>5)</sup> Each page to be signed in case of ‘loose-leaf’ type record

<sup>6)</sup> Preliminary TM record has to be passed to the Surveyor, signed by the Operator

<sup>7)</sup> The only measures which the Surveyors can certify exact are those for which that they have seen the results on the screen of the apparatus. That means in fact few points in comparison with the numbers of recorded measures.

<sup>8)</sup> The Surveyor reviews the TM record for completeness and assessment of TM readings, but no signature required.



UR Z7s and Z10s (Corrosion Prevention System)

**1. Objective:**

To clarify whether the survey of anodes is a class matter, and if so, whether acceptance criteria for anode should be developed.

**2. Method:** GPG by correspondence (5037\_)

**3. Discussion**

3.1 BV initiated GPG discussion as follows:

Paris La Défense, 8 Mars 05

1 - We have noticed that, in the draft UR Z's ( 7.1, 10.1 to 10.5) issued further to the WP/SRC Task 102, the original sentence ".....the examination may be limited to a verification that the hard protective coating remains efficient....." has been replaced by ....that the corrosion prevention system remains efficient....". in a number of paragraphs (such as , for instance, Z 7.1, 4.2.3.1 a) ; Z 10.2 4.2.3.3 ; ), in line with IMO Res.A744(18).

2 - However, a corrosion prevention system is defined, in the same UR Z's and in IMO Res.A744(18) , as being either a full hard protective coating or a full hard protective coating supplemented by anodes.

3 - The above would mean that the survey of the anodes is a classification matter.

4 - However, whereas coating conditions are defined as good or fair or poor, there are no criteria in the IACS URs and IMO Res. A744(18) for the anodes condition.

5 - Assessing the anodes condition to confirm that they "remain efficient" looks to BV to be a quite difficult task for the ships in service Surveyor.

6 - Member's view and interpretations on the following would consequently be appreciated:

- do Members consider that the above requirements in IACS URs imply that survey of anodes is part of the classification ?
- do Members consider that the above requirements in IMO Res. A 744 (18) imply that survey of anodes is mandatory?
- if yes, what is the acceptance criteria to conclude that the anodes" remain efficient" ?

3.2 The majority of GPG Members replied that they did not include requirements for anodes in their class rules.

LR / ABS / DNV / KR / NK / RINA / RS were of the view that the condition of any anodes fitted should be recorded for information purposes as the survey of anodes is neither a classification matter nor a mandatory requirement in IMO A.744(18) and has no impact on future surveys (5037\_LRa). [Note; LR further clarified that "Whilst I agree that the performance of anodes is not normally a class matter LR does require that as part of Special Survey on oil tankers : "The attachment to the structure and condition of anodes in tanks are to be examined ." Therefore we cannot say that 'the survey of anodes is not a classification matter'. 5037\_LRb]

However, GL said that “for GL, anodes are a matter of class and as such are subject to plan approval as well as surveys. In case of missing or worn-out anodes we issue a condition of class”(5037\_GLa&b).

CCS advised that its rules have a general requirement relating to anode survey, which is only conducted, through sampling, during construction, docking survey or where there is a definite requirement for the survey of ballast tanks.

NK proposed that the following footnote be added to Z7s and Z10s:  
“The survey of anodes is not a classification matter.” No majority support was achieved.

#### **4. Conclusion**

RINA suggested to simply amend the definition of "Corrosion Prevention System" in paragraph 1.2.9 of UR Z7 (and, of course, the paragraphs in all the other UR Zs containing the definition of "Corrosion Prevention System") in order to eliminate any reference to anodes. This proposal would leave room for Societies willing to include additional class requirements for anodes to do so in their Rules.

GPG agreed.

### **RINA proposed amendments to paragraph 1.2.9 of UR Z7 and corresponding paragraphs in all other UR Zs (5037\_RIb, 6 April 2005)**

#### 1.2.9 Corrosion Prevention System

A corrosion prevention system is normally considered ~~either: a full hard protective coating, or~~  
~~1 a full hard protective coating, or~~  
~~2 a full hard protective coating supplemented by anodes.~~

Hard protective coating is usually to be epoxy coating or equivalent. Other coating systems may be considered acceptable as alternatives provided that they are applied and maintained in compliance with the manufacturer's specifications.

Where soft coatings have been applied, safe access is to be provided for the surveyor to verify the effectiveness of the coating and to carry out an assessment of the conditions of internal structures which may include spot removal of the coating. When safe access cannot be provided, the soft coating is to be removed.

[Annex: Council Chair's conclusive message.](#)

6 May 2005  
Permsec

## **Annex. (5037\_ICb, 15 May 2005)**

To : All IACS Council Members  
c.c : Mr. R. Leslie, IACS Permanent Secretariat

Ref. Mr G-Y. Han's message IAa dated 6 May 05  
Message ICa dated 6 May 05  
Admiral R.E. Kramek's message ABb dated 13 May 05

Paris La Défense, 15 May 05

- 1 - All Members have agreed with the texts attached to Mr Han's message.
- 2 - Further to ABS comments the reference to anodes is to be deleted in Annex I and in tables IX (IV) and IX(II).
- 3 - further to ABS questions regarding what IACS plan to do regarding IMO and A.744(18) further to IACS deletion of reference to anodes from the UR Z7's and UR Z10's it is to be noted that:

The Item 1.2.9 in UR Z10.1 and relative items in these URs states  
*1.2.9 10 Corrosion Prevention System: A corrosion prevention system is normally considered either:*

- .1 a full hard protective coating, or*
- .2 a full hard protective coating supplemented by anodes.*

*Hard Pprotective Ccoating is to usually to be epoxy coating or equivalent. Other coating systems may be considered acceptable as alternatives provided that they are applied and maintained in compliance with the manufacturer's specification.*

*Where Soft Coatings have been applied, safe access is to be provided for the surveyor to verify the effectiveness of the coating and to carry out an assessment of the conditions of internal structures which may include spot removal of the coating. When safe access cannot be provided, the soft coating is to be removed.*

- therefore the anodes are not considered as the main means of protection against the corrosion It is only a supplement;
- there is no provision in UR Z7's and Z10's to evaluate the level efficiency of the anodes;
- there is no specific requirements in case of lack of efficiency of the anodes.

The experience has shown that ballast tanks only protected by anodes are subject to corrosion when the anodes are becoming less efficient.

The anodes are active only when immersed by sea water. Therefore the upper part of the ballast tanks are not protected when the ballast is full of water and the ballast is not protected when it is empty..

The ships operators are reluctant to replace the anodes especially in upper part which request fitting of scaffolding fo welding the anode supports to the structure.

[The above arguments justify the reasons why IACS consider that the anodes are not class item.](#)

[4 - These arguments can be used by IACS Members](#) attending the WG bulk carriers at MSC 80 to try to obtain deletion of the reference to anodes in A. 744(18).

Best regards,

Bernard Anne  
IACS Council Chairman.

## **Technical Background**

**UR Z10.1(Rev.13, Jan 2006)**

**UR Z10.2(Rev.18, Jan 2006)-separate TB**

**UR Z10.3(Rev.8, Jan 2006)**

**UR Z10.4(Rev.3, Jan 2006)**

**UR Z10.5(Rev.2, Jan 2006)**

**Part 1. Z10s – para. 1.4 and 7.1.3**

**Part 2. Z10s – para. 5.5.4 and 5.5.6**

**Survey Panel Task 22 – Amend applicable URZ7s and Z10s to align Close-Up Survey and Thickness measurements to be carried out at the same time and location allowing for a more structured control of the thickness measurement process.**

**Technical Background**

**Z7(Rev.12)**

**Z7.1(Rev.3)**

**Z10.1(Rev.13, para.1.4 & 7.1.3)**

**Z10.2(Rev.18, para. 1.4 & 7.1.3)**

**Z10.3(Rev.8, para. 1.4 & 7.1.3)**

**Z10.4(Rev.3, para. 1.4 & 7.1.3)**

**Z10.5(Rev.2, para. 1.4 & 7.1.3)**

**1. Objective**

To amend the applicable URZ7s and Z10s to align Close-Up Survey and Thickness measurements to be carried out at the same time and location allowing for a more structured control of the thickness measurement process.

**2. Background**

IACS QC findings, through audits of numerous Societies, which indicated concerns over Surveyor attendance and control of thickness measurement processes.

**3. Methodology of Work**

Survey Panel members through correspondence.

**4. Discussion**

To align Close-up survey requirements and thickness measurements in the applicable URZ7s and URZ10s, in accordance with PR19, all Panel members agreed through correspondence and a final vote at the fall Survey Panel meeting, that URZ7, Z7.1, Z10.1, Z10.2, Z10.3, Z10.4 and Z10.5 should include in the applicable sections of the noted URs as proposed by the Survey Panel the wording “ In any kind of survey, i.e. special, intermediate, annual, or other surveys having the scope of the foregoing ones, thickness measurements of structures in areas where close-up surveys are required, shall be carried out simultaneously with close-ups surveys.”

**5. Implementation**

The Survey Panel is of the view that the Members need 12 months from the adoption date to implement these amendments into their class rules. Assuming that GPG and Council approve to the amendments, the Survey Panel would propose January 2007 as an implementation date.

## **Technical Background**

**UI SC 191 (Rev.2, Oct 2005)**

**&**

**UR Z10.1 (Rev.13, para.5.5.4 and 5.5.6, Jan 2006)**

**UR Z10.2 (Rev.18, para. 5.5.4 and 5.5.6, Jan 2006)**

**UR Z10.3 (Rev.8, para.5.5.4 and 5.5.6, Jan 2006)**

**UR Z10.4 (Rev.3, para.5.5.4 and 5.5.6, Jan 2006)**

**UR Z10.5 (Rev.2, para.5.5.4 and 5.5.6, Jan 2006)**

### **1. Objective**

- to confirm whether the guidelines for approval/acceptance of alternative means of access (now REC91, ex Annex to UI SC191) is mandatory or non-mandatory.
- to consider other safety related proposals.

### **2. Background**

The DNV proposal to submit the UI SC191(Rev.1, May 2005, Annex 1) to IMO DE49 triggered a number of discussion points that led to amendments to the following resolutions:

UI SC191(Rev.2)  
New REC 91  
REC 39(Rev.2)  
UR Z10s

### **Points of Discussion**

3. Is the Annex to UI SC191(Rev.1, May '05, guidelines for approval / acceptance of alternative means of access) mandatory or non-mandatory ?

Answer: Non-mandatory. Hence, re-categorized as new REC 91.

4. Limitation of use of rafts in bulk carrier holds

DNV proposed that conditions for rafting should be limited to areas, such as anchorage or harbour, where swell conditions are limited to 0.5m. After discussion, GPG approved the ABS' alternative proposal to use the swell condition as a basis to determine the appropriateness of rafting, instead of geographic areas(harbours or anchorage). 5.5.4 of Z10.2 refers.

RINA proposed that para 5.5.4 should be included in all the Z10s. NK's objection is recorded as follows (3037hNKq, 29/08/2005):

1. With regard to RIm of 26 August 2005, NK considers that the proposed amendment to 5.5.4 should be limited to UR Z10.2.
2. Rafting survey for tankers are actually carried out on the open sea from a discharge port to a loading port and in such situation the rise of water within the tanks would always exceed 0.25m. It is different situation from rafting survey for hold frames of bulk carriers normally conducted in a harbour or at an anchorage.
3. If the same requirement applies to tankers, any rafting survey for cargo oil tanks and ballast tanks of tankers would be prohibited. This is not practicable under present survey procedure for tankers.
4. Therefore, NK can not support Laura's proposal that the proposed amendment to 5.5.4 of UR Z10.2 is introduced into the other URs and new Recommendation.

For compatibility with the IMO's mandatory requirements\*, GPG decided to add the same amendment to all the UR Z10s.

\*

- Appendix 4 to MEPC.99(48) 'Mandatory requirements for the Safe Conduct of CAS Surveys'
- MSC.197(80) – amendments to A.744918), Annex A for DSS and SSS bulk carriers and Annex B for single and double hull oil tankers.

As a consequence, 5.5.1 of REC 91(ex Annex to UI SC191) was also amended:

- to remove the reference to dynamic /sloshing (as the 0.25m rise was considered negligible);
- to refer to the rafting conditions contained for cargo holds in Z10.2 and Z10.5 and for oil cargo tanks in Z10.1 and Z10.4.

5. Means of access from longitudinal permanent means of access within each bay to rafts

GPG reviewed the proposal that the following text be added to Z10s:

[A means of access to the longitudinal permanent platform from rafts or boats is to be fitted in each bay.](#)

(Technical Background: for the safety of surveyors)

There may be ships which are arranged in accordance with para b, page 8 of the Annex to the current SC 191 (i.e., no means of access from the LPMA in each bay to a raft is required) and therefore could not be rafted if the sentence proposed by RINA ("[A means of access to the longitudinal permanent platform from rafts or boats is to be fitted in each bay](#)") is included in the Z10's.

GPG therefore agreed not to include this sentence in Z10s.

For the same reason, the same sentence was not added to Rec.39.

Finally, GPG added the following sentence to UI SC191(interpretation for II-1/3-6):

*A permanent means of access from the longitudinal platform to the water level indicated above is to be fitted in each bay (e.g permanent rungs on one of the deck webs inboard of the longitudinal permanent platform).*

## **6. Implementation**

It was agreed that the revised UI SC191 be implemented to ships contracted for construction 6 months after adoption by Council.

UI SC191 was also edited in line with IMO MSC/Circular. 1176, leaving its mandatory language (is/are to, shall) unchanged.

(Note: UI SC191(Rev.2) makes references to the following new Recommendations:

- REC 90: Ship Structure Access Manual
- REC 91: Guidelines for approval/acceptance of Alternative Means of Access)

23 September 2005  
Permanent Secretariat  
Updated on 13 Oct 2005.



**Survey Panel Task 43 – Amend the applicable sections of the URs to address the requirements for substantial corrosion in the Common structural rules.**

**Technical Background**

**(UR Z10.2, Rev.22, June 2006)**

**(UR Z10.4, Rev.4, June 2006)**

**(UR Z10.5, Rev.4, June 2006)**

**1. Objective**

Amend applicable sections of the URs to address the requirements for substantial corrosion in the Common structural rules.

**2. Background**

Due to the different application of substantial corrosion in the CSR from the current Unified Requirements.

**3. Methodology of Work**

Panel members discussed the proposed revisions through correspondence up to the Spring Panel meeting where final amendments were agreed upon for submittal to the IACS Hull Panel for review.

**4. Discussion**

After much discussion between all Panel members at the March 2006 Survey Panel members, a unanimous decision was reached as to the wording of CSR Substantial corrosion in UR Z10.2, 10.4, and 10.5 in section 1.2.9 and was then submitted to the Hull Panel for review and approval. The hull panel concluded that the Survey Panel definition for CSR substantial corrosion was not entirely accurate and recommended further amendments to clarify the actual requirements. The new definition was then circulated to the Survey Panel for a final review and was unanimously agreed upon.

**5. Implementation**

The Survey Panel is of the view that the Members need 12 months from the adoption date to implement these amendments into their class rules/procedures. Assuming that GPG and Council approve the amendments, the Survey Panel would propose **July 2007** as an implementation date.

Submitted by Survey Panel Chairman

## **Technical Background**

### **UR Z10.1 (Rev.14), UR Z10.2 (Rev.23), UR Z10.4 (Rev.5) & UR Z10.5 (Rev.5)**

#### **Survey Panel Task 3 – Maintenance of Alignment/ Compatibility of IACS URs and IMO survey requirements**

##### **1. Objective**

Maintenance of alignment/compatibility of IACS URs and IMO survey requirements regarding resolution MSC 197(80) – amendments to A744(18)

##### **2. Background**

IMO survey requirements to ESP vessels as amended in A744(18) as noted in MSC 197(80), with an implementation date of 1 January 2007.

##### **3. Methodology of Work**

Survey Panel members through correspondence.

##### **4. Discussion**

Survey Panel members, at the fall 2006 Survey Panel meeting, finalized the amendments to the applicable URs due to changes adopted at MSC(80).

Additionally, Members noted that URZ10.4 paragraphs 2.2.3.1 and 4.2.2.2 does not require examination of ballast tanks adjacent to heated fuel tanks, as required by MSC197(80). The survey panel agreed that if this is the position that IACS would like to take regarding double hull tankers, then it should be brought to the attention of IMO at the next IMO meeting, DE50 in March 2007.

##### **5. Implementation**

The Survey Panel is of the view that the Members need 12 months from the adoption date to implement these amendments into their class rules. Assuming that GPG and Council approve the amendments, the Survey Panel would propose January 2008 as an implementation date, although the IMO implementation date is January 2007.

Submitted by Survey Panel Chairman  
9 January 2007

##### **GPG discussion**

All members agreed to omit the requirement of examination of ballast tanks adjacent to heated fuel tanks, as required by MSC197(80), from URZ10.4 for double hull tankers and

that it should be brought to the attention of IMO at DE50. In addition ABS proposed that paragraphs relating to similar requirements in URZ10.1 should also be deleted for consistency and this was agreed by members.

Members also made a number of minor/editorial corrections to the text prior to their approval of the revised documents.

Added by Permanent Secretariat  
23 April 2007

## **Technical Background**

**URs Z7(Rev.15), Z7.1(Rev.5), Z7.2(Rev.1), Z10.1(Rev.15),  
Z10.2(Rev.26), Z10.3(Rev. 9), Z10.4(Rev.6), Z10.5(Rev.8) – November  
2007**

### ***Survey Panel Task 1 – Annual Review of Implementation of IACS Resolutions***

#### **1. Objective**

To review IACS Resolutions annually and discuss or propose amendments as deemed necessary.

#### **2. Background**

This proposed amendment to all URZ7s and URZ 10s was raised by the Panel member from DNV due to Owners crediting tanks concurrently under intermediate and special survey.

#### **3. Methodology of Work**

Survey Panel members through correspondence.

#### **4. Discussion**

The Panel member from DNV raised the issue of Owners having the ability of crediting spaces and thickness measurements only once in a 54 month interval, due to the availability of concurrent crediting of spaces and thickness measurements due to the flexible time window that is currently allowed between the intermediate survey and the special survey.

After a presentation and discussion lead by the DNV Panel member, all Survey Panel members agreed to the argument given by DNV, and further agreed to make the necessary changes in all URZ7s and URZ10s where Owners are not allowed to concurrently credit surveys and thickness measurements of spaces.

#### **5. Implementation**

The Survey Panel is of the view that the Members need 12 months from the adoption date to implement these amendments into their class rules. Assuming that GPG approve to the amendments, the Survey Panel would propose January 2009 as an implementation date.

Submitted by Survey Panel Chairman  
22 October 2007

**Permanent Secretariat note (December 2007):**

During GPG discussion DNV proposed that *“since this matter will be discussed between Owner and Class mainly in connection with the forthcoming Special Survey, DNV would prefer to locate this text, not only as part of Intermediate Survey, but also as a new text for the Special Survey.”* This was supported by BV, ABS, RINA and KR.

The revised documents were approved, with DNV’s proposal and an implementation date of 1 January 2009, on 15 November 2007 (ref. 7690\_IGb).

## Technical Background

### URs Z7(Rev.16), Z7.1(Rev.6), Z7.2(Rev.2), Z10.1(Rev.16), Z10.2(Rev.27), Z10.3(Rev.11), Z10.4(Rev.7) and Z10.5(Rev.9) - March 2009

#### Survey Panel Task 62:

- A) *Harmonization of UR Z10.1, Z10.2, Z10.4 and Z10.5 with UR Z10.3 with respect to items 5.5.4.4 and 5.6.2.*
- B) *Harmonization of UR Z7, Z7.1, Z10.1, Z10.2, Z10.3, Z10.4 and Z10.5 with UR Z7.2 with respect to the definition of the corrosion prevention system and with respect to the footnote 1 related to semi-hard coatings.*
- C) *Harmonization of the definition of Ballast Tank in UR Z7(Rev.14)*

#### 1. Objective

- A) Amend the texts of items 5.5.4.4 and 5.6.2 in Unified Requirements Z10.1, Z10.2, Z10.4 and Z10.5 in order to align them with those in UR Z10.3, in which they were changed while performing Task 55, whereas in the other UR Z10s they were kept unchanged on the grounds that this change was out of the scope of Task 55.
- B) Amend the definition of “Corrosion Prevention System” and include a Footnote 1 related to semi-hard coatings in Unified Requirements Z7, Z7.1, Z10.1, Z10.2, Z10.3, Z10.4 and Z10.5 in order to align them with those adopted in UR Z7.2, when this new UR was issued.
- C) Amend UR Z7 (Rev. 14) in all items where the term “Ballast Tank” is used in order to get them harmonized with the definition itself.

#### 2. Background

The task, as regards item A), was triggered by a Member Society, while performing Task 55, on the grounds that this part was out of the scope of the task and then should have been dealt with in a separate task.

The task, as regards item B), was triggered as a consequence of the “New Business action item 2” of the Minutes of the September 2008 Survey Panel meeting, for sake of harmonization of the various URZs.

The task, as regards item C), was triggered as a consequence of the “Task 54-Examination of Double Bottom Ballast Tanks at annual surveys” of the Minutes of March 2008 Survey Panel meeting, for sake of harmonization of the definition of Ballast Tank in UR Z7(Rev.14).

#### 3. Discussion

The task was carried out by correspondence. All the amended texts for the affected URs were prepared by the Survey Panel Member who had chaired the PT on Task 55, in accordance with the Form A approved by GPG. In addition to the objectives outlined in the Form A, an amendment was added to item 1.3.1 of UR Z10.2 and UR Z10.5 in which the reference 3.2.3.6 in the last item of the list was replaced by 3.2.3.10 as can be correctly verified in the text.

The amended URs were circulated to all Survey Panel Members for review, comments and agreement. The texts of the URs were unanimously agreed by all Members.

#### **4. Implementation**

The Survey Panel is of the view that the Member Societies need at least 12 months from the adoption date to implement these amendments into their class rules/procedures. Therefore, in the first version of all amended URs the following implementation sentence should be proposed:

*Changes introduced in Rev .xx are to be uniformly applied by Member Societies and Associates for surveys commenced on or after [not less than 12 months after the adoption by GPG/Council].*

Since it is common practice and convenience to have implementation dates either on 1<sup>st</sup> January or on 1<sup>st</sup> July of the year, the Survey Panel proposes the 1<sup>st</sup> July 2010 as implementation date, if GPG/Council approve the URs not later than 30 June 2009.

**Submitted by Survey Panel Chairman  
28 February 2009**

#### **Permanent Secretariat notes (April 2009):**

1. The amended URs were approved by GPG on 18 March 2009 (ref. 7718bIGd).
2. During the typesetting process it was noted that para 5.1.5 of UR 7.2 was inconsistent with the amended URs and so following consultation with the Survey Panel this was also amended at this time.
3. Regarding the implementation date, GPG agreed to use 1<sup>st</sup> July 2010 provided that it was consistently used for the amended URs.

## **Technical Background for UR Z10.4 Rev.8, Feb 2010**

### **1. Scope and objectives**

To amend UR Z10.4 (Rev.7) for the harmonization with currently revised MARPOL Annex I.

### **2. Engineering background for technical basis and rationale**

None

### **3. Source/derivation of the proposed IACS Resolution**

MARPOL 73/78  
IACS UR Z10.4 (Rev.7)

### **4. Summary of Changes intended for the revised Resolution:**

As MARPOL I was revised, the reference to MARPOL I/13 (3) in paragraph 1.2.2bis should read MARPOL I/18(3).

### **5. Points of discussions or possible discussions**

None

### **6. Attachments if any**

None



## Technical Background for UR Z10.4 Rev.9 (Mar 2011)

### 1. Scope and objectives

- 1) To amend UR Z10.4 to harmonize the definition of transverse section.
- 2) Update of references in the Executive Hull Summary Table IX.
- 3) Review IACS URZ10.4 to determine if there are issues which need to be addressed to ensure that the IACS survey regime and the CSRs are compatible.

### 2. Engineering background for technical basis and rationale

- 1) Based on that fact that bulk carriers and oil tankers have a transverse framing system applied for example on ship's sides etc. and that UR Z7 is applied to all types of ships and includes an extended definition of transverse section it is necessary to unify this definition in UR Z10s.
- 2) Update of references in the Executive Hull Summary Table IX such that the introduction of extended annual surveys is noted in the 'Memoranda' section rather than under 'Conditions of Class'.
- 3) Some requirements in CSRs for Oil Tankers were relevant to ships in operation and it was decided to move them from CSRs to UR 10.4 in more consistent way.

### 3. Source/derivation of the proposed IACS Resolution

CSRs, IACS UR Z7.

Proposed amendments to UR Z10.4 is based on internal discussion of IACS which is always striving to produce consistent and compatible rule requirements.

### 4. Summary of Changes intended for the revised Resolution:

- 1) The following additional text is added to the definition of transverse section in para 1.2.5:

*"For transversely framed vessels, a transverse section includes adjacent frames and their end connections in way of transverse sections."*

- 2) In the Executive Hull Summary Table IX (iv) the reference to part H) is updated to part I) as per Table IX (ii).
- 3) The main amendment has consisted in removing the requirements found in the CSRs related to surveys after construction and locating them in the applicable sections of UR Z10.4. The rationale of that is to have only one place where survey requirements are given and avoid any duplication of requirements in different documents, which would give rise to problems of maintenance and alignment.

Other important amendments have been made moving the following items from the CSRs to UR Z10.4 as applicable:

## Part B

- a) the paragraphs regarding the different corrosion patterns, such as pitting corrosion, edge corrosion and grooving corrosion, and their different acceptance criteria,
- b) the items regarding the number and locations of thickness measurements, together with the associated table and referenced figures.

Another notable change has been introduced in the "ANNEX II - Recommended Procedures for Thickness Measurements" of UR Z10.4, which, however, are only recommendatory and not mandatory, where thickness measurements forms specific to CSRs double hull oil tankers have been produced in addition to the existing ones, which only apply to non-CSRs ships.

### **5. Points of discussions or possible discussions**

None.

### **6. Attachments if any**

None.

## **Technical Background for UR Z10.4 Rev.10, July 2011**

### **1. Scope and objectives**

Review the requirement for repairs within IACS UR 7 and UR 10 series, in particular the requirement for Prompt and Thorough Repair, with a view to developing wording that would permit a temporary repair and the imposition of a Recommendation/ Condition of Class under specific and controlled circumstances, and in accordance with PR35.

### **2. Engineering background for technical basis and rationale**

There are instances, for example a localised, isolated and very minor hole in a cross-deck strip, at which a suitable temporary repair, for example by welding or doubling, and the imposition of a suitable short term Recommendation/ Condition of Class for permanent repair at a later date, are considered very adequate methodology for dealing with the defect.

Current IACS Requirements in the UR Z7 and Z10 series, for Prompt and Thorough repair, would not permit this to be an option, the defect would have to be permanently Promptly and Thoroughly repaired, which might require removing cargo, moving to a repair berth and staging inner spaces.

Under the Requirements of IACS Procedural Requirement PR 35 the methodology of Temporary Repair and imposition of a suitable short term Recommendation/ Condition of Class for permanent repair at a later date is fully permissible.

### **3. Source/derivation of the proposed IACS Resolution**

Based upon discussion within the IACS Survey Panel.

### **4. Summary of Changes intended for the revised Resolution:**

Following the definition of Prompt and Thorough Repair in the Unified Requirement, a new paragraph is proposed to be added:-

"1.3.3 Where the damage found on structure mentioned in Para. 1.3.1 is isolated and of a localised nature which does not affect the ship's structural integrity, consideration may be given by the surveyor to allow an appropriate temporary repair to restore watertight or weather tight integrity and impose a Recommendation/Condition of Class in accordance with IACS PR 35, with a specific time limit."

Also, Table I was split to into 2 tables for enhanced clarity, Table I.1 for Single Skin and Table I.2 for Double skin ships and miscellaneous editorial errors in the Table I.1 and I.2 are corrected.

### **5. Points of discussions or possible discussions**

a) The points of discussion are as indicated in Sections 2 and 4 above.

b) Discussion took place on whether to prepare this amendment as a Unified Interpretation of IMO Resolution A.744(18)/UR Z7 and Z10 series, finally it was agreed to make direct amendment to the relevant URs.

c) It is proposed that this amendment be submitted directly to the IMO DE/MSC Committees for consideration of amending directly IMO Res. A744(18)

**6. Attachments if any**

None

## **Technical Background for UR Z10.4 Rev.12, Jan 2014**

### **1. Scope and objectives**

- a) To consider appropriate text in IACS document regarding class period for lengthy conversions.
- b) To align the requirements in PR37 and UR Z10s regarding safe entry to confined spaces.

### **2. Engineering background for technical basis and rationale**

- a) As per the IMO Res. A1053 (27), lengthy conversions (not necessarily of major character) or other major repair work can be assigned for a 5 year period from the date of completion of conversion/repairs/surveys.
- b) Safety requirements in IACS PR37 can be applied to carry out survey in safe way for all kind of ships. When there are no indications about the safety of surveyor in UR Z10s then the requirements in PR37 shall be applied.

### **3. Source/derivation of the proposed IACS Resolution**

None

### **4. Summary of Changes intended for the revised Resolution**

- a) Following additional text was included to section 2.1.3 to clarify the class period for lengthy conversions

"In cases where the vessel has been laid up or has been out of service for a considerable period because of a major repair or modification and the owner elects to only carry out the overdue surveys, the next period of class will start from the expiry date of the special survey. If the owner elects to carry out the next due special survey, the period of class will start from the survey completion date."

- b) Existing Section 5.2.6 and 5.2.7 were deleted from UR Z10s since provisions of these sections were covered by PR37. Reference of PR37 was included in Section 5.2.1.1.

### **5. Points of discussions or possible discussions**

- i) Additional text to Para.2.1.3 was discussed in order to clarify class period.
- ii) Panel considered that safety of surveyors should be dealt by PR37.

### **6. Attachments if any**

None

**Technical Background Document  
WP/SRC Task 66  
New UR Z10.4 for Double Hull Oil Tankers**

**Objective and Scope:**

To Develop a Unified Requirement for Enhanced Surveys of Double Hull Tankers along the lines of UR Z10.1 but tailored to the structural configuration of double hull tankers and other features which distinguish double hull tankers from single hull tankers and with a view to submitting the outcome to IMO for incorporation in future amendments of A.744(18).

**Source of Proposed Requirements:**

WP/SRC developed Z10.4 in collaboration with the Permanent Secretariat through correspondence and their meeting. IACS' Post Erika measures have been incorporated in the proposed draft. In addition, Res MSC.105(73) and 108(73) have been introduced into Z10.4 since entry into force date of the aforesaid MSC Resolutions is 1 July 2002.

**Points of Discussion:**

WP/SRC unanimously agreed to the proposed draft UR Z 10.4 except with respect to 3.2.5.2. The majority of WP/SRC agreed to the proposed text of 3.2.5.2 whereas ABS and NK preferred the corresponding text of Z10.1.

Submitted by the permanent Secretariat

On 11 December 2001

**WP/SRC Task 102**  
**HARMONIZATION OF UR Z7s AND Z10s**

**Technical Background**

**UR Z7 (Rev. 11)**

**UR Z7.1 (Rev. 2)**

**UR Z10.1 (Rev. 12)**

**UR Z10.2 (Rev. 17)**

**UR Z10.3 (Rev. 7)**

**UR Z10.4 (Rev. 2)**

**UR Z10.5 (Rev. 1)**

Contents:

TB for Harmonization

**Annex 1.** TB for UR **Z10.1(Rev.12**, C49 amendments(coating-related))

**Appendix 1:** Memo for Coating, submitted to Council  
49(June 2004).

**Appendix 2:** DNV proposal (25 May 2005) agreed by Council

**Annex 2.** TB for "Verification/Signature of TM Forms" for records.

**Annex 3.** TB for revision of UR Zs concerning "anodes".

### 1. Objective

To amend UR Z7s and Z10s in order to make the texts of the above-mentioned URs consistent eliminating all the differences both in substance and in wording (WP/SRC Task 102).

### 2. Background

In the process of approving UR Z10.4, GPG found it necessary to amend the other existing URs Z10.1, Z10.2, Z10.3, Z10.6 and Z7 in order to eliminate any inconsistencies existing among them.

### 3. Methodology of work

The WP has progressed its work through many sessions, both during the periodical meetings and dedicated meetings restricted to a Small Group of Members (BV, DNV, GL, LR, RINA) who developed the work in order to be more efficient. All the proposed amendments of the Small Group have regularly been circulated to all Members for comment and agreement.

## 4. Discussion

4.1 The WP/SRC has completed a comprehensive comparative review of UR Z7 and Z10s, and identified inconsistencies which existed among them. During this review, attention was given to the severity of the requirements applicable to the same spaces/structural areas on different types of ESP ships. As a result, the inconsistencies were eliminated making the URZs harmonized. However, there has been no change to the scope and extent of the survey requirements.

4.2 The starting point for each UR was the most updated version available at the time of commencement. Any revision to the URZs, which were introduced during this task, was taken into account. As for instance, the UR Z10.1 was initially amended based on Rev. 9, while the last amendments are based on Rev. 11 and the UR Z10.2 was initially amended based on Rev. 13, while the last amendments are based on Rev. 16. The proposed revisions of URs Z10.1 and Z10.4 have not been numbered, as there will be revisions to those URs before the revisions introduced by the Task 102 are adopted. In fact, GPG is currently developing a Revision 12 of Z10.1 with the view to introducing significant improvements in the survey regime for ballast tanks (including combined cargo/ballast tanks) of oil tankers and UR Z10s applicable to oil tankers will also have to be revised by incorporating the amendments to A.744(18) contained in Resolution MSC 144(77), which enter into force 1 January 2005 (see 4.3 below).

4.3 Also, in harmonizing UR Z10.1 and Z10.2 care has been taken to align the corresponding text with that of IMO Res. A.744(18). However, it has been noted that the amendments to A.744(18) contained in Resolution MSC 144(77), which enter into force 1 January 2005, have not been incorporated into the IACS UR Z10s applicable to oil tankers. It seems that the updating of the above-said UR Z10s will be done by the Perm Sec and reviewed by the WP/SRC Chairman and then circulated for adoption by GPG with concurrence of Council Members for uniform application from 1 January 2005. It is understood that the revisions of the UR Z10s affected by those amendments will not include the changes introduced by the Task 102, as the implementation date proposed for those changes is 1 January 2006 (see below **6. Implementation**).

4.4 In the course of the work the WP has been developing for more than two years, several additional Tasks were assigned to the WP by GPG which affected the development of Task 102. The additional tasks which have been taken into account are the following:

- 1) In the course of Council discussion on UR Z10.6 (General Cargo Ships), certain inconsistencies were identified between Z10.6 and other Z10s. WP was instructed to expedite Task 102 (1060gIAa, 12 June 2002);
- 2) WP was instructed to include "Survey Planning for Intermediate Survey" into harmonization work (2108\_IAa, 12 July 2002);
- 3) GPG instructed WP to consider whether Z10.6 should be re-assigned as Z7.1, in connection with the harmonization work. 1060gIAb, 20 Sept 2002.



- Z7.1 developed;
- 4) Partial outcome (Z7 and Z7.1) was submitted to GPG on 17 July 2003(1060g). Council decided that approval of Z7(Rev.10) and Z7.1(Rev.2) is postponed until the harmonization is completed (1060gICb, 6 April 2004);  
[Council Chairman instructed WP/SRC to Members' comments on the draft revision of UR Z7 and Z7.1 \(collected under s/n 1060g, 1060gNKi \(30/03/2004\) in particular\) on 6 April 2004.](#)
  - 5) GPG tasked WP to include the amendments to Z10.2 / Z11 (BCs with hybrid cargo hold arrangements), deleting sheets 15 and 16 for ore carriers, into the harmonized UR Z10s (2212aIGa, 19 Jan 2004);
  - 6) GPG tasked WP to consider whether the requirements relevant to examination of Fuel Oil Tanks in the cargo area at each Special Survey should be put into Z10s, and internal examination of FOT at Intermediate Survey after SS 2 is needed. (1060gIAf, 30 Jan 2004);
  - 7) GPG tasked WP to harmonize tank testing requirements in Z7s and Z10s. (3006IIAa, 5 April 2004);
  - 8) GPG tasked WP with Task 108 - Develop uniform survey requirements for air vent pipes including the welded connection to deck. Z22 developed. GPG instructed WP to incorporate Z22 into the harmonized Z10s;
  - 9) GPG tasked WP with Task 114 - Verification and signature of TM reports. REC 77(Rev.1) developed and approved on 29 July 2004. Council approved parallel amendments to Z7.1 and Z10s (TM Forms included) and instructed WP to incorporate these into the harmonized Z10s:
    - [Recommendation No.77 was revised \(Rev.1, July 2004\);](#)
    - [Z7.1 para.6.3.2 and Z10s para.7.3.2 so amended.](#)
    - ["Surveyor's signature" is deleted from all TM Forms in Z10s;](#)
    - [A note is added to Annex II\(Z10s\) declaring that Annex II is recommendatory.](#)

WP/SRC's investigation into Members' practice in dealing with verification and signature of TM reports is annexed for record keeping purpose. [See Annex 2.](#)
  - 10) GPG tasked WP to consider the BV comments on "TM may be dispensed with..." and include the findings into the harmonized Z10s ( 2219iIAa, 7 April 2004).

## **5. Agreement within the WP/SRC**

All Members have unanimously agreed the attached final versions of UR's.

## **6. Implementation**

WP/SRC is of the view that the Members need 12 months from the adoption date to implement these amendments into their class rules. Assuming Council adoption in December 2004, WP/SRC would propose January 2006 as implementation date.

- Annex 1:** TB for UR Z10.1(Rev.12, C49 amendments, see Permsec's note 1 below)  
**Annex 2:** WP/SRC Task 114, verification and signature of TM reports(see 9 above).  
**Annex 3:** TB for revision of UR Zs concerning "anodes".

### **Note by the Permanent Secretariat**

1. Annex 1 to this TB contains background for amendments to UR Z 10.1(Rev.12) relating to FAIR/POOR/GOOD (C49 amendments). Council at its 49<sup>th</sup> meeting (June 2004) agreed/decided that comparable changes should be added to Z10.3 and Z10.4.
  
2. Appendix 3 "TM sampling method" has been added to UR Z10.1 and Z10.4 to keep them consistent with IMO Res.MSC.144(77). The amendments to A.744 contained in MSC.144(77) entered into force on 1 January 2005. (*GPG s/n 4181*)  
  
Under s/n 4072g, paragraph **2.4.6** of UR Z10.1 and **2.4.6** and of UR Z10.4 (paragraph numbering is now harmonized) were amended in order to provide a link between the main text of the UR Z10.1 and 10.4 and the new Annex III Appendix 3 containing the MSC Res.144(77).  
Further, it was agreed that the requirements for evaluation of longitudinal strength of the hull girder (as written in MSC.144(77)) should not be required for Intermediate Survey unless deemed necessary by the attending Surveyor. This is covered in 4.2.3.1 and 4.2.4.1 of Z10.1 and Z10.4.
  
3. GPG agreed that the amended UR Zs should be implemented from 1 July 2006 altogether.
  
4. DNV's proposed amendments to UR Z10.1, Z10.3 and Z10.4 concerning annual survey of ballast tanks were agreed by Council (1060gICq, 27 June 2005). See Appendix 2 to Annex 1.
  
5. Annex 3 contains a TB for revision of UR Zs concerning "anodes".

Date: September 2004  
Prepared by the WP/SRC

---

## **Annex 1 to Technical Background**

### **UR Z 10.1 (Rev.12, C49 amendments(coating-related))**

#### **1. Objective**

To introduce significant improvements in the survey regime for ballast tanks (including combined/ballast tanks) of oil tankers as matter of strategic concern and urgency to IACS, given the aging of both the single and double hull tanker fleets and the problems encountered with corrosion of ballast tanks in several shipping casualties.

#### **2. Background**

Draft amendments to UR Z10.1 were submitted to Council 47 (June 2003) and agreed in principle.

#### **3. Discussion**

There was particular concern over accelerated corrosion with age (as the thinner the material, the more rapidly the allowable diminution margin percentage disappears) especially where coatings have broken down. There is also a disincentive for any spend on maintenance of the structure of a ship within a few years of its statutory scrapping date.

Council discussion by correspondence had evolved to the position of substantive proposals – summed as follows (3095\_ABa, 2 June 2003):

1. Enhance the Intermediate Survey in Z10.1, Z10.3 and 10.4 for Tankers after 2<sup>nd</sup> Special / Renewal Survey to the same level (scope of work) as the preceding Special / Renewal Survey). This corresponds to the latest revision to UR Z10.2.
2. At Annual Survey of ballast tanks with substantial corrosion, the overall survey is to be replaced by close-up survey with thickness measurements of the exposed area.
3. Proposed to task WP/SRC to re-consider the acceptance criteria for the rating FAIR further. For this, eliminate FAIR, leaving only GOOD and POOR redefined as appropriate.
4. Proposed to task WP/SRC to explicitly require close-up survey of Suspect Areas identified at the previous Special Survey.

Council 47 discussed the proposals(June 2003) as follows:

##### **1. Definition of FAIR**

Council 47 agreed that “FAIR” would be retained as a rating and that GPG should instruct WP/SRC to redefine FAIR, so that there would be a clear differences between FAIR, POOR and GOOD. It was also agreed that for oil tankers the Intermediate Survey following Special Survey No.2 would have the same scope as Special Survey No.2(Z10.1). WP/SRC should also clarify the definition of satisfactory repair.

Based on the strong majority, Council agreed to discuss with Industry annual surveys of ballast tanks when coating is found in LESS than GOOD condition at special survey, with the objective to encourage the owner to carry out repairs and maintenance of coating to GOOD condition.

*DNV and NK stated that they could not accept a requirement for annual surveys of ballast tanks when the coating condition is less*

*than GOOD and proposed that GOOD be changed to FAIR (3095\_IGc, 30 June 2003)*

2. ABS' proposed amendments to Z10.1(annual examination of BWTs in certain conditions) were approved.
3. C 47 agreed that the BWT coating requirements (Z10.1.2.2.3) for intermediate Survey after SS 2 should be the same extent to the previous SS.
4. Given the substance of the changes, the revised Z10.1 should be shown to Industry before adoption.
5. A guidance for coating repairs needs to be developed by WP/SRC with reference to TSCF Guidelines.

Following Council 47, the draft text of Z10.1(Rev.12) was distributed to Industry and discussed at the IACS/Industry meeting on 29 August 2003. Industry indicated that UR Z10.1(Rev.12) is acceptable, provided that appropriate IACS guidelines on coating repairs are developed.

The Small Group on Coating (SG/Coating) under WP/SRC prepared draft guidelines on coating repairs and considered the definitions of GOOD / FAIR / POOR. The SG/Coating did not change the definitions and found that the Guidelines provide useful clarifications on the definitions and criteria in achieving an industry wide uniform judgement of coating conditions as well as what is needed to restore GOOD conditions.

Further, an IACS/Industry JWG/Corrosion was established and met in February 2004. The outcome is (3095\_IGh, 4 June 2004):

- Draft Guidelines on Coating Repair (IACS REC 87)
- Draft UR Zxx (mandatory coating of cargo tanks on oil tankers)
- Draft UI SC 122 (Rev.2) – mandatory coating of ballast tanks

#### **4. Others**

1. Z10.11.2.2bis - Definition of “Combined Cargo/Ballast Tank. ...as a routine part of the vessel's operation and will be treated as a Ballast Tank. ...”. By so amending, Z10s do not need to repeat “Ballast Tanks and Combined cargo/salt water Ballast Tanks” in addressing the ballast tanks. Hence, all the references to “and Combined cargo/salt water Ballast Tanks” were deleted.
2. Z10.1.2.2.1.2: The aim of the examination is to be sufficient to discover substantial corrosion...  
Comparable changes are to be added to other UR Zs wherever the same sentence occurs.
3. “IACS Guidelines for Coating Maintenance & Repairs for Ballast Tanks and Combined/Ballast tanks on Oil Tankers” are referenced where relevant.
4. Comparable changes are to be added to UR Z10.3 and Z10.4, after adoption of Z10.1(Rev.12).

**Attached: Memo on Coating Matters (GPG Chairman)**

9 June 2004  
Prepared by the Permsec

## **Appendix 1 to Annex 1:**

## **MEMO on Coating matters**

### **1. Background and discussion within IACS on UR Z10.1 (draft Rev.12) between 29/01/03 and 14/08/03**

In view of the survey experience with oil tankers, it was proposed that all ballast tanks should be examined, routinely and uniformly, at annual surveys on ESP tankers exceeding 15 years of age. IACS should amend UR Z10.1 to require the examination of ballast tanks on such ships at each annual survey. This is simple, clear and thorough and not subject to interpretation. (2242\_ABq dated 29/1/03)

Then, ABS modified the proposal asking, for tankers subject to URs Z10.1, Z10.3 and Z10.4, exceeding 15 years of age, that the current requirement - pertaining to annual examination of Ballast Tanks adjacent to cargo tanks with any means of heating - be deleted and replaced by a simpler and more stringent requirement that all Ballast Tanks be subject to survey at each subsequent annual survey where either substantial corrosion is found within the tank or the protective coating is found to be in less than GOOD condition and the protective coating is not renewed at special survey or intermediate survey. This will ensure that all Ballast Tanks with substantial corrosion or protective coating which is not in GOOD condition at the time of special survey or intermediate survey will be examined at each subsequent annual survey on tankers exceeding 15 years of age. (2242\_ABzb dated 14/3/03)

This was later expanded to include all tanks used routinely for ballast water, both ballast-only and cargo/ballast tanks (2242\_ABzc dated 14/3/03).

ABS further reviewed the issue of the survey of salt water ballast spaces and combined cargo/salt water ballast spaces with ABS' governing bodies in light of recent casualties and survey findings on other tankers. Their review found an increasing amount of coating breakdown/failure and subsequent rapid wastage in key structures after Special Survey No. 2, i.e. after 10 years of age. These conditions are most prevalent in the under deck structure and the side shell structure in way of the deep loadline. In a number of cases the serious wastage has caused fracturing of the under deck longitudinals and in some cases fracturing has extended to the main deck structure. This led ABS to refine proposed amendments to URs Z10.1, Z10.3 and Z10.4 to require (2242\_ABzf dated 9/5/03):

#### **a. For Tankers exceeding 10 years of age**

Salt Water Ballast Spaces and Combined Cargo/Salt Water Ballast Spaces. For tankers exceeding 10 years of age, salt water ballast spaces and combined cargo/salt water ballast spaces are to be internally examined at each subsequent Annual Survey where substantial corrosion is found within the tank or where the protective coating is found to be less than GOOD condition and protective coating is not repaired. Internal examination to be an Overall Survey.

#### **b. For Tankers exceeding 15 years of age:**

Salt Water Ballast Spaces and Combined Cargo/Ballast Spaces. For tankers exceeding 15 years of age, salt water ballast spaces and combined cargo/ballast spaces are to be examined internally at each subsequent Annual Survey. Where substantial corrosion is found within the tank, or where the protective coating is found to be in less than GOOD condition and the protective coating is not repaired then in addition to an Overall Survey, under deck structure and the side shell structure in way of the deep loadline is to be subject to Close-up Survey.

NK and BV replied that the proposed amendments made by ABS need to be substantiated in a transparent manner with technical data that ABS may possess and put forward for further assessment and discussion. (2242\_NK<sub>n</sub> dated 14/5/03 and 2242\_BV<sub>z</sub> dated 16/5/03)

**DNV** (2242\_NV<sub>n</sub> dated 2/6/03), having carefully considered the practical consequences of taking the ship off-hire for gas freeing etc. and being concerned about the difficulties to have these surveys executed in a safe manner and whether the intended safety benefits in implementing the proposed extended scope of the annual survey of Ballast tanks will be met, **proposed the following alternative measures** which would be as effective and may not have such delaying effects to the ship:

- 1) Enhance the Intermediate Survey in UR Z10.1, 10.3, and 10.4 for Tankers after the 2 Special / Renewal Survey to the same level (scope of work) as the preceding Special / Renewal Survey. (This will correspond to the latest revised requirements of UR Z10.2 for Bulk Carriers.)
- 2) At Annual Survey of ballast tanks with substantial corrosion the overall survey should be replaced by close up survey with thickness measurements of the exposed area. (An overall survey of these tanks does not give sufficient information of the development of the areas with substantial corrosion.)
- 3) Further we will not fail to mention that the WP/SRC has proposed to extend the close up survey in cargo and combination tanks to 30% from the 3 Special / Renewal Surveys.
- 4) **Experience has shown that the coating condition rating category FAIR has a tendency to be stretched too far into the POOR condition. We will therefore propose that we task the WP/SRC to reconsider the acceptance criteria for the rating FAIR further.**
- 5) We do also question the need for redefining the definition of combination tanks, particularly since the category I tankers which are the ships that normally are fitted with these type of tanks are to be phased out 2 to 4 years from now. However DNV will not oppose to such a redefinition.

**DNV requested Members to consider the above as an alternative to the ABS proposal, bearing in mind that we ought to present this to the industry prior to deciding.**

ABS (3095\_Aba dated 2/6/03), having further considered its earlier proposals in light of NV<sub>n</sub>, submitted a revised proposal for consideration by Council at C47 and replied to the above 5 DNV proposals as follows:

- 1) ABS fully supports this proposal.
- 2) While ABS agrees with this proposal, it is in fact already provided for in Z7 (3.2.3) and Z10.1 (3.2.5.1)--which require that "Suspect areas (which include any area where substantial corrosion is found) identified at previous Special Survey are to be examined. Areas of substantial corrosion identified at previous special or intermediate survey are to have thickness measurements taken." To us, this implies that close-up survey of these areas is to be done at annual survey in conjunction with the thickness measurements. However, we can

agree to tasking WP/SRC to explicitly require "close-up" survey in this connection and to amend Z7, and all the Z10's, appropriately to make this explicit, if there is majority support for this.

- 3) We agree that this has been put forward to GPG by WP/SRC via 0237hNVb, 27 May. However, these additional CAS close-up survey requirements do not apply to salt water ballast tanks; only to cargo oil tanks and combined cargo/ballast tanks.
- 4) **We agree with this assessment and we propose that the only way to eliminate the subjectivity and raise the standard is to eliminate the category "FAIR" completely; leaving only "GOOD" and "POOR" redefined as follows:**  
**"GOOD -- condition with no breakdown or rusting or only minor spot rusting.**  
**POOR -- any condition which is not GOOD condition."**
- 5) ABS does not agree with this proposal. We are particularly concerned that we need a very thorough and robust survey regime for these tankers precisely because they are subject to mandatory phase out over the next several years. We are very concerned that without additional IACS requirements, these tanks will receive little or no inspection and maintenance by owners or others after their last special or intermediate survey, if no substantial corrosion is found at that time. Rapid, localized wastage in way of deteriorating coatings may pose significant hazard if the survey regime is not further tightened as we are proposing.

In conjunction with the above comments on DNV proposals, ABS further considered their previous proposal in ABzf and modified it as follows:

- **ABS simplified the proposal to require annual examination of all salt water Ballast Tanks and combined Cargo/salt water Ballast Tanks irrespective of age, when either substantial corrosion is found within the tank or the protective coating is found to be in less than GOOD condition and is not repaired.**
- the requirement for annual (close-up) examination of salt water ballast tanks and combined tanks is already required in Z10.1 (3.2.5.1). ABS proposed adding it to 2.2.3 for clarity and emphasis so that all the conditions which may lead to annual examination of such tanks are listed together in one place.
- Since the principal problem that we are trying to address is rapid, localized corrosion in way of breakdown or deterioration of the protective coating, we are proposing that the coating condition should be found and kept in "GOOD" condition to obviate the need for annual examination. **The attached proposal is made together with the proposals in items 3.1 (intermediate following Special survey 2 to have same scope as prior Special survey) and 3.4 (eliminating "FAIR" and redefining "POOR" as any condition other than "GOOD" condition.**

ABS requested to decide on a course of action at C47 for tightening the survey regime for tankers. They agreed that industry be informed of Council's decisions in this regard prior to IACS making the decision public, but IACS should maintain its independence and take decisive action in this matter. Debate with industry can only lead to delay and to a watering down and compromising of these important requirements.

NK agreed to task WP/SRC to reconsider the acceptance criteria of "FAIR" for clearly define the border between "FAIR" and "POOR" condition. However, **NK strongly opposed the elimination of "FAIR" coating condition from UR Zs** because this can not resolve to remove subjectivity of coating assessment. The three-categorization system of coating condition should be retained. (3095\_NKa dated 5/5/03)

## **Outcome of C47**

At C47, it was agreed that "Fair" would be retained as a rating and that GPG should instruct WP/SRC to redefine "Fair", so that there would be a clear differentiation between "Fair", "Poor" and "Good". It was also agreed that for oil tankers the Intermediate Survey following Special Survey No.2 would have same scope as Special Survey No.2 (Z10.1). WP/SRC should also clarify the definition of satisfactory repair.

Based on strong majority support Council agreed to discuss with Industry annual surveys of ballast tanks when coating is found in LESS than GOOD condition at special survey, with the objective to encourage the owner to carry out repairs and maintenance of coating to GOOD condition.

This matter should be discussed with Industry prior to adoption of any UR by Council.

In a final summary, the Chairman proposed that a constructive dialogue with Industry should take place on the IACS proposal as set out in WP1 plus maintaining 3.2.5.2 modified to say that ballast/combined ballast/cargo tanks will be subject to annual survey when considered necessary by surveyors.

After discussion in the JWG (Industry/IACS), GPG should propose final rules for this matter to Council, including acceptable repair definition.

**FUA 17:** *To instruct WP/SRC to develop guidance on coating repairs and more precise definition of "Fair" coating condition.*

Once approved, these requirements should be incorporated into Z10.3 and Z10.4.

### **FUA 15**

1) *To prepare a draft revision to UR Z10.1 incorporating C 47 decisions:*

- *The definition of "FAIR" remains as it is;*
- *ABS proposed amendments to Z10.1 (annual examination of BWTs in certain conditions) were approved;*
- *C47 agreed that the BWT coating requirements (Z10.1.2.2.3) for Intermediate Survey after Special Survey No.2 should be the same extent to the previous Special Survey.*
- *Given the substance of the changes, the revised UR Z10.1 should be shown to Industry (OCIMG/Intertanko first among others) before adoption for their review and comments.*
- *A guidance for coating repairs needs to be developed by WP/SRC with reference to TSCF Guidelines.*

2) *GPG Members are to confirm the draft revision to Z10.1 in consultation with their WP/SRC members by correspondence. See 3095\_IGa of 13/06/03.*

According to C47 FUA 15, GPG Chairman circulated (3095\_IGa dated 13/6/03) draft amendments to UR Z10.1 as agreed in principle at C47.

Having received a number on comments, GPG Chairman (3095\_IGb dated 27/6/03) informed that the Council Chairman confirmed that GPG is not to amend the principles agreed at C47, i.e. we are not empowered to change "GOOD" to "FAIR" as proposed by DNV and NK, nor to amend the definitions of "FAIR" and "POOR" as proposed by DNV.



DNV's intention to possibly lodge a reservation was noted, however the matter should be raised at Council and not be dealt with by GPG. An amended draft text incorporating the non-substantive changes proposed by Members was circulated.

DNV said that its understanding was that the draft should be circulated to the Industry (ICS, INTERTANKO, and BIMCO) prior to adoption by Council. (3095\_NVc dated 30/6/03)

GPG Chairman (3095\_IGc dated 30/6/03) circulated a draft amendment of UR Z10.1 for Council's agreement and use in discussions with the industry associations.

The draft was generally agreed by GPG but individual Members have requested that the following matters (which were deemed to be outside the remit of GPG in this task) be brought to Council's attention for further consideration:

- 1 DNV and NK stated that they can not accept a requirement for annual surveys of ballast tanks when the coating condition is less than GOOD and propose that GOOD be changed to FAIR.
- 2 In connection with item 1 above, DNV also propose to amend the definitions of FAIR and POOR in order to raise the standard of FAIR.

Council Chairman (3095\_ICb dated 14/8/03) concluded that Council has agreed that the draft amendments to UR Z10.1 attached to IGc reflect Councils' decision taken at C47 and that they be circulated to industry associations.

Perm Sec was therefore invited to submit the draft to OCIMF and INTERTANKO in view of discussion at the IACS/ industry meeting on 29 August.

## **2. Discussion with Industry (29/08/2003 – 11/10/2003)**

As requested by Council, the whole matter was presented to Industry during the “general matters” meeting with IACS held on 29 August 2003; comments from Industry were requested. In the following an extract from the minutes of the meeting (see message 3100aIAb dated 5 September 2003):

\_\_\_\_\_ from Meeting minutes \_\_\_\_\_

## **4. & 5. Annual surveys of ballast tanks and IACS guidelines on coating repairs**

M. Dogliani introduced the matter ([see Items 4&5 in Appendix](#)).

A. LinoCosta gave a presentation to show where concerns and decisions stand: too many cases when coating was considered fair at SS but problems occurred just after one/two years.

N. Mikelis commented on draft amendments to Z10.1 (Rev.11) stating that the extent of annual survey is not clear; it should be limited to the affected zones, e.g. coating breakdowns, only.

M. Guyader clarified that, in this draft amendments, it is expected an overall survey of the whole tank and a close up survey of the affected zones.

N. Mikelis noted that, in the draft amendments to Z10.1 (Rev.11), the intermediate survey at 12.5 years would have the same scope as the previous special survey and that needed a justification. See 7 a).

M. Dogliani said that Z10.1 (Rev.11) was adopted in August 2003 and will be introduced into IACS Societies' Rules over the next year.

### Conclusions:

4.1 Industry shared IACS concerns on coatings and, in general, agreed with the draft amendments to Z10.1 (Rev.11) suggesting also extending them to Z10.2 on bulk carriers

4.2 Industry agreed that a guideline for surveyor on coating would greatly improve uniform application of so-amended Z10.1 including issues such as how to consider load bearing elements when judging GOOD/FAIR/POOR status and how to consider bottom pitting in connection with GOOD conditions

4.3 Industry will more precisely comment, by the end of September, the draft Z10.1 so as for IACS to finalise the matter, as planned, for the Council's December meeting.

Item	Title	Industry recommendation	IACS/ M. Dogliani Introduction
4 & 5	Annual survey of ballast tanks IACS guidelines on coating repairs	NN	<p><b>1. IACS is considering the following:</b></p> <ul style="list-style-type: none"> <li>- <b>amend UR Z10.1 (draft circulated to Industry) to the effect that in case at Special Survey or Intermediate Survey the coating in a ballast tank is found less than GOOD, either GOOD conditions are restored or the tank's coating is inspected at each annual survey;</b></li> <li>- <b>develop IACS guideline to assist an uniform application of the so modified (if adopted) UR Z10.1; the guideline should address which repairs are necessary to restore GOOD conditions from FAIR and POOR respectively and which are the criteria for the restored (after repair) situation to be rated as GOOD.</b></li> </ul>

\_\_\_\_\_ End of extract from minutes \_\_\_\_\_

INTERTANKO commented (see R. Leslie email to GPG dated 25 September 2003):

- expressing their concern for the draft Z10.1 and underlining
  - a) targeting: concerns that, if not properly dealt with, Z10.1 would target all ships and not just those which need intervention; the view was expressed that guidelines would probably solve the matter;
  - b) definition: indicating that the current definitions of GOOD, FAIR and POOR is not clear enough and that the matter would be even worst with GOOD and NON GOOD; again it was indicated that guidelines could solve the matter;
  - c) expertise: expressing doubts on IACS' surveyors expertise and ability to judge coating conditions; in this respect they (hiddenly) suggest that IACS position is unclear when we say that we are not competent to judge the coating during construction but then we are competent to judge coating during operational life. Even if not explicitly stated, the impression is that also in this case guidelines would help.

Additionally, INTERTANKO suggested a (quite detailed) set of assessment criteria.

The matter was then finally addressed at the TRIPARTITE Meeting (held in Soul on 29/30 September 2003). There Industry agreed that the way forward was the (joint) development of IACS guidelines (see minutes attached to message 3100\_RIe dated 11 October 2003, an extract of which is reproduced below).

\_\_\_\_\_ Extract from the TRIPARTITE minutes \_\_\_\_\_

Industry is concerned by the definition of GOOD/NOT GOOD in relation to coating repairs and acceptance criteria. Industry agreed that new guideline on this, which IACS is already producing, was the way forward.

\_\_\_\_\_ End of the extract from the minutes \_\_\_\_\_

### **3. Further developments**

- a) from the above, it was concluded that, provided the guidelines are sound, Industry would accept the concept of Z10.1 (draft) Rev. 12, therefore an IACS team and a JWG were established in order to progress the matter of the guidelines (among other related matters).
- b) the team of IACS experts on coating developed draft guidelines and provided recommendations to GPG on the way forward (attached to message 3095bNVc dated 20 November 2003).
- c) the guidelines were discussed within the JWG with Industry (see draft minutes circulated within GPG with messages 3095cIGd and 3095cIGe both dated 13 March 2004)
- d) further suggestions and comments (as requested at the meeting) were provided by Industry (not circulated to GPG)
- e) Bulk Carrier Industry is recommending that similar guidelines are developed in due time also for bulk carriers
- f) at DE47 and MSC78, IMO is asking Industry and IACS to develop (compulsory) performance standards for coating of newbuilding (double hull spaces of DSS Bulk Carriers), a matter which is, indirectly related to the above one.

1 June 2004

M. Dogliani

IACS GPG Chairman

IACS JWG/COR Chairman

Appendix 2 to Annex 1: [DNV proposal to Z10.1, Z10.3 and z10.4](#) ▶

Sent Monday, July 4, 2005 4:45 pm

To [Gil-Yong <gilyonghan@iacs.org.uk>](mailto:Gil-Yong <gilyonghan@iacs.org.uk>)

Cc

Bcc

Subject Fw: 1060gNVs; WP/SRC - Task 102 - Harmonization of UR Z 7 and Z 7.1

Attachments [Doc1.doc](#)

25K

----- Original Message -----

From: "Debbie Fihosy" <[debbiefihosy@iacs.org.uk](mailto:debbiefihosy@iacs.org.uk)>

To: "CCS" <[iacs@ccs.org.cn](mailto:iacs@ccs.org.cn)>

Cc: "IACS Permanent Secretariat" <[permsec@iacs.org.uk](mailto:permsec@iacs.org.uk)>

Sent: Friday, June 03, 2005 2:52 PM

Subject: FW: 1060gNVs; WP/SRC - Task 102 - Harmonization of UR Z 7 and Z 7.1

Forwarding as requested

-----Original Message-----

From: Arve.Myklebust@dnv.com [[Arve.Myklebust@dnv.com](mailto:Arve.Myklebust@dnv.com)]

Sent: 25 May 2005 15:49

To: [AIACS@eagle.org](mailto:AIACS@eagle.org); [iacs@bureauveritas.com](mailto:iacs@bureauveritas.com); [iacs@ccs.org.cn](mailto:iacs@ccs.org.cn);

[johnderose@iacs.org.uk](mailto:johnderose@iacs.org.uk); [iacs@dnv.com](mailto:iacs@dnv.com); [iacs@gl-group.com](mailto:iacs@gl-group.com);

[gilyonghan@iacs.org.uk](mailto:gilyonghan@iacs.org.uk); [helenbutcher@iacs.org.uk](mailto:helenbutcher@iacs.org.uk); [efs@iacs.org.uk](mailto:efs@iacs.org.uk);

[krsiacs@krs.co.kr](mailto:krsiacs@krs.co.kr); [richardleslie@iacs.org.uk](mailto:richardleslie@iacs.org.uk); [external-rep@lr.org](mailto:external-rep@lr.org);

[clnkiacs@classnk.or.jp](mailto:clnkiacs@classnk.or.jp); [terryperkins@iacs.org.uk](mailto:terryperkins@iacs.org.uk); [iacs@rina.org](mailto:iacs@rina.org);

[iacs@rs-head.spb.ru](mailto:iacs@rs-head.spb.ru); [colinwright@iacs.org.uk](mailto:colinwright@iacs.org.uk)

Subject: FW: 1060gNVs; WP/SRC - Task 102 - Harmonization of UR Z 7 and Z 7.1

25 May 2005

To: Mr. B. Anne, Chairman of IACS Council,

cc: Council Members, IACS Perm. Sec.

Ref.: My mail NVr dated 20 May 2005

DNV have further studied the amendments to UR Z10.1, Z10.3, and Z10.4, and as a result are presenting the following as a compromise solution:

General comment:

From the comments by other Members it is obvious that there is reluctance to accept annual surveys of ballast tanks with a common plane boundary to heated cargo tanks in the case where the coating is in good condition. This is particularly unreasonable as at the same time we enhance the Intermediate survey of Tankers between 10 and 15 years to also include examination of all ballast tanks, meaning that all ballast tanks will be close up surveyed with 2-3 years intervals from the ship is 10 years old, with the possibility for the surveyor to require thickness measurements and testing of the tanks to ensure the structural integrity of the tanks if necessary.

It is also proposed for the Intermediate survey between 5 and 10 years, to increase the scope from representative to all ballast tanks, a requirement DNV find to strict, and require that we here keep the original text.

If a ballast tank is found to have coating in GOOD condition at the renewal or intermediate survey, a deterioration of the tank beyond structural reliability is very unlikely even if the tank has a common plane boundary to a heated cargo tank.

DNV finds it particularly unreasonable to have this requirement to apply to double hull tankers for the following reasons:

- these ships have double hull and the risk of pollution is here much reduced,
- the double hull is constructed with small spaces giving improved structural reliability,
- almost all double hull tankers below VLLC have heated cargo tanks, and all ballast tanks have common plane boundaries to these tanks, meaning that this requirement will apply to a major part of the tanker fleet in the future,
- the ballast tanks of double hull tankers are so designed that a general examination of these tanks will be identical to a close up survey,
- survey of ballast tanks of double hull tankers will mean either gas freeing of all cargo tanks or at least dropping the inert gas pressure of all cargo tanks in addition to proper airing of all ballast tanks.

Since the single hull tankers will be faced out in the near future, and for clear political reasons, DNV will as a compromise proposal to keep paragraph 2.2.3.1 and 4.2.2.2 in Z 10.1 as amended by Council (ref. IAo) but amend it to not include 2.2.3.1.e, 4.2.2.2.e and last paragraph of 3.2.5.1 in Z10.3 and Z10.4. In addition we request that the original text of 4.2.2.1 is kept.

If BV, ABS and other Members can accept this DNV is willing to drop our reservation presented at C49.

DNV's proposal will then be as follows:

Z10.1:

2.2.3.1: This paragraph can be accepted as is for the reasons stated above.

3.2.5.1: This paragraph is accepted as amended.

4.2.2.2: This paragraph can be accepted as is for reasons stated above.

For other comments to Z10.1 see NVo and NVp.

Z10.3:

2.2.3.1.e to be deleted.

3.2.5.1 delete last paragraph

4.2.2.1 the original text to be kept. "For tanks used for water ballast ---"

4.2.2.2.e to be deleted

Z10.4

2.2.3.1e to be deleted

3.2.5.1 delete last paragraph

4.2.2.1 the original text to be kept, "For tanks used for water ballast --"

4.2.2.2.e to be deleted.

For details see attached document where the text for the requirements in Z10.3 and Z10.4 that DNV will accept is stated.

Best Regards

Arve Myklebust  
on behalf of  
Terje Staalstrom  
DNV IACS Council Member  
<<Doc1.doc>>

\*\*\*\*\*

Neither the confidentiality nor the integrity of this message can be vouched

Annex 2 to TB (Harmonization Z10s)

**WP/SRC Task 114 “Clarify the procedure of verification and signature of the thickness measurement report”**

Item No.	Item	ABS	BV <sup>1)</sup>	CCS	CRS	DNV	GL	IRS	KR	LR	NK	RINA	RS
<b>1</b>	<b>Verification onboard</b>												
1.1	Minimum extent of measuring points for direct verification by attending surveyor specified	No	No	No	No	No	No	No	Yes	No	No	Yes	No
1.2	Preliminary TM record to be signed upon completion of the measurements onboard	Yes	Yes <sup>7)</sup>	Yes	No (copy taken)	No <sup>3)</sup>	No <sup>6)</sup>	Yes	Yes	Yes	Yes	No <sup>8)</sup>	No
<b>2</b>	<b>Final TM report</b>												
2.1	Signature of all pages in TM record required	No	No	No	Yes	No	Yes	Yes	No	No	No <sup>5)</sup>	Yes	Yes
2.2	Signature of ‘cover’ (‘general particulars’) page only	Yes	Yes	Yes	No	Yes	No	No	No <sup>4)</sup>	Yes	Yes	Yes	No
2.3	Measuring points verified by attending surveyor required identified in TM record and signature of the corresponding pages required	No	No	Yes Without signature	Yes	No	No	No	Yes	No	No	No	No

2004-04-20

<sup>1)</sup> Instructions not clear regarding signature of the thickness measurement record

<sup>2)</sup> Signature on front and last page, stamp on all other pages, or signature on each page (IACS TM forms)

<sup>3)</sup> Upon completion of measurements onboard a draft report in electronic format (DNV TM template, including operator’s notes as relevant) to be given to attending surveyor

<sup>4)</sup> Signature of cover page, pages of meeting record and pages of attended measuring points

<sup>5)</sup> Each page to be signed in case of ‘loose-leaf’ type record

<sup>6)</sup> Preliminary TM record has to be passed to the Surveyor, signed by the Operator

<sup>7)</sup> The only measures which the Surveyors can certify exact are those for which that they have seen the results on the screen of the apparatus. That means in fact few points in comparison with the numbers of recorded measures.

<sup>8)</sup> The Surveyor reviews the TM record for completeness and assessment of TM readings, but no signature required.

UR Z7s and Z10s (Corrosion Prevention System)

**1. Objective:**

To clarify whether the survey of anodes is a class matter, and if so, whether acceptance criteria for anode should be developed.

**2. Method:** GPG by correspondence (5037\_)

**3. Discussion**

3.1 BV initiated GPG discussion as follows:

Paris La Défense, 8 Mars 05

1 - We have noticed that, in the draft UR Z's ( 7.1, 10.1 to 10.5) issued further to the WP/SRC Task 102, the original sentence ".....the examination may be limited to a verification that the hard protective coating remains efficient....." has been replaced by ....that the corrosion prevention system remains efficient....". in a number of paragraphs (such as , for instance, Z 7.1, 4.2.3.1 a) ; Z 10.2 4.2.3.3 ; ), in line with IMO Res.A744(18).

2 - However, a corrosion prevention system is defined, in the same UR Z's and in IMO Res.A744(18) , as being either a full hard protective coating or a full hard protective coating supplemented by anodes.

3 - The above would mean that the survey of the anodes is a classification matter.

4 - However, whereas coating conditions are defined as good or fair or poor, there are no criteria in the IACS URs and IMO Res. A744(18) for the anodes condition.

5 - Assessing the anodes condition to confirm that they "remain efficient" looks to BV to be a quite difficult task for the ships in service Surveyor.

6 - Member's view and interpretations on the following would consequently be appreciated:

- do Members consider that the above requirements in IACS URs imply that survey of anodes is part of the classification ?
- do Members consider that the above requirements in IMO Res. A 744 (18) imply that survey of anodes is mandatory?
- if yes, what is the acceptance criteria to conclude that the anodes" remain efficient" ?

3.2 The majority of GPG Members replied that they did not include requirements for anodes in their class rules.

LR / ABS / DNV / KR / NK / RINA / RS were of the view that the condition of any anodes fitted should be recorded for information purposes as the survey of anodes is neither a classification matter nor a mandatory requirement in IMO A.744(18) and has no impact on future surveys (5037\_LRa). [Note; LR further clarified that "Whilst I agree that the performance of anodes is not normally a class matter LR does require that as part of Special Survey on oil tankers : "The attachment to the structure and condition of anodes in tanks are to be examined ." Therefore we cannot say that 'the survey of anodes is not a classification matter'. 5037\_LRb]

However, GL said that “for GL, anodes are a matter of class and as such are subject to plan approval as well as surveys. In case of missing or worn-out anodes we issue a condition of class”(5037\_GLa&b).

CCS advised that its rules have a general requirement relating to anode survey, which is only conducted, through sampling, during construction, docking survey or where there is a definite requirement for the survey of ballast tanks.

NK proposed that the following footnote be added to Z7s and Z10s:  
“The survey of anodes is not a classification matter.” No majority support was achieved.

#### **4. Conclusion**

RINA suggested to simply amend the definition of "Corrosion Prevention System" in paragraph 1.2.9 of UR Z7 (and, of course, the paragraphs in all the other UR Zs containing the definition of "Corrosion Prevention System") in order to eliminate any reference to anodes. This proposal would leave room for Societies willing to include additional class requirements for anodes to do so in their Rules.

GPG agreed.

### **RINA proposed amendments to paragraph 1.2.9 of UR Z7 and corresponding paragraphs in all other UR Zs (5037\_R1b, 6 April 2005)**

#### 1.2.9 Corrosion Prevention System

A corrosion prevention system is normally considered ~~either: a full hard protective coating, or~~  
~~1 a full hard protective coating, or~~  
~~2 a full hard protective coating supplemented by anodes.~~

Hard protective coating is usually to be epoxy coating or equivalent. Other coating systems may be considered acceptable as alternatives provided that they are applied and maintained in compliance with the manufacturer's specifications.

Where soft coatings have been applied, safe access is to be provided for the surveyor to verify the effectiveness of the coating and to carry out an assessment of the conditions of internal structures which may include spot removal of the coating. When safe access cannot be provided, the soft coating is to be removed.

[Annex: Council Chair's conclusive message.](#)

6 May 2005  
Permsec



## **Annex. (5037\_ICb, 15 May 2005)**

To : All IACS Council Members  
c.c : Mr. R. Leslie, IACS Permanent Secretariat

Ref. Mr G-Y. Han's message IAa dated 6 May 05  
Message ICa dated 6 May 05  
Admiral R.E. Kramek's message ABb dated 13 May 05

Paris La Défense, 15 May 05

- 1 - All Members have agreed with the texts attached to Mr Han's message.
- 2 - Further to ABS comments the reference to anodes is to be deleted in Annex I and in tables IX (IV) and IX(II).
- 3 - further to ABS questions regarding what IACS plan to do regarding IMO and A.744(18) further to IACS deletion of reference to anodes from the UR Z7's and UR Z10's it is to be noted that:

The Item 1.2.9 in UR Z10.1 and relative items in these URs states  
*1.2.9 10 Corrosion Prevention System: A corrosion prevention system is normally considered either:*

- .1 a full hard protective coating, or*
- .2 a full hard protective coating supplemented by anodes.*

*Hard Pprotective Ccoating is to usually to be epoxy coating or equivalent. Other coating systems may be considered acceptable as alternatives provided that they are applied and maintained in compliance with the manufacturer's specification.*

*Where Soft Coatings have been applied, safe access is to be provided for the surveyor to verify the effectiveness of the coating and to carry out an assessment of the conditions of internal structures which may include spot removal of the coating. When safe access cannot be provided, the soft coating is to be removed.*

- therefore the anodes are not considered as the main means of protection against the corrosion It is only a supplement;
- there is no provision in UR Z7's and Z10's to evaluate the level efficiency of the anodes;
- there is no specific requirements in case of lack of efficiency of the anodes.

The experience has shown that ballast tanks only protected by anodes are subject to corrosion when the anodes are becoming less efficient.

The anodes are active only when immersed by sea water. Therefore the upper part of the ballast tanks are not protected when the ballast is full of water and the ballast is not protected when it is empty..

The ships operators are reluctant to replace the anodes especially in upper part which request fitting of scaffolding fo welding the anode supports to the structure.

[The above arguments justify the reasons why IACS consider that the anodes are not class item.](#)

[4 - These arguments can be used by IACS Members](#) attending the WG bulk carriers at MSC 80 to try to obtain deletion of the reference to anodes in A. 744(18).

Best regards,

Bernard Anne  
IACS Council Chairman.

## **Technical Background**

**UR Z10.1(Rev.13, Jan 2006)**

**UR Z10.2(Rev.18, Jan 2006)-separate TB**

**UR Z10.3(Rev.8, Jan 2006)**

**UR Z10.4(Rev.3, Jan 2006)**

**UR Z10.5(Rev.2, Jan 2006)**

**Part 1. Z10s – para. 1.4 and 7.1.3**

**Part 2. Z10s – para. 5.5.4 and 5.5.6**

**Survey Panel Task 22 – Amend applicable URZ7s and Z10s to align Close-Up Survey and Thickness measurements to be carried out at the same time and location allowing for a more structured control of the thickness measurement process.**

**Technical Background**

**Z7(Rev.12)**

**Z7.1(Rev.3)**

**Z10.1(Rev.13, para.1.4 & 7.1.3)**

**Z10.2(Rev.18, para. 1.4 & 7.1.3)**

**Z10.3(Rev.8, para. 1.4 & 7.1.3)**

**Z10.4(Rev.3, para. 1.4 & 7.1.3)**

**Z10.5(Rev.2, para. 1.4 & 7.1.3)**

**1. Objective**

To amend the applicable URZ7s and Z10s to align Close-Up Survey and Thickness measurements to be carried out at the same time and location allowing for a more structured control of the thickness measurement process.

**2. Background**

IACS QC findings, through audits of numerous Societies, which indicated concerns over Surveyor attendance and control of thickness measurement processes.

**3. Methodology of Work**

Survey Panel members through correspondence.

**4. Discussion**

To align Close-up survey requirements and thickness measurements in the applicable URZ7s and URZ10s, in accordance with PR19, all Panel members agreed through correspondence and a final vote at the fall Survey Panel meeting, that URZ7, Z7.1, Z10.1, Z10.2, Z10.3, Z10.4 and Z10.5 should include in the applicable sections of the noted URs as proposed by the Survey Panel the wording “ In any kind of survey, i.e. special, intermediate, annual, or other surveys having the scope of the foregoing ones, thickness measurements of structures in areas where close-up surveys are required, shall be carried out simultaneously with close-ups surveys.”

**5. Implementation**

The Survey Panel is of the view that the Members need 12 months from the adoption date to implement these amendments into their class rules. Assuming that GPG and Council approve to the amendments, the Survey Panel would propose January 2007 as an implementation date.

## **Technical Background**

**UI SC 191 (Rev.2, Oct 2005)**

**&**

**UR Z10.1 (Rev.13, para.5.5.4 and 5.5.6, Jan 2006)**

**UR Z10.2 (Rev.18, para. 5.5.4 and 5.5.6, Jan 2006)**

**UR Z10.3 (Rev.8, para.5.5.4 and 5.5.6, Jan 2006)**

**UR Z10.4 (Rev.3, para.5.5.4 and 5.5.6, Jan 2006)**

**UR Z10.5 (Rev.2, para.5.5.4 and 5.5.6, Jan 2006)**

### **1. Objective**

- to confirm whether the guidelines for approval/acceptance of alternative means of access (now REC91, ex Annex to UI SC191) is mandatory or non-mandatory.
- to consider other safety related proposals.

### **2. Background**

The DNV proposal to submit the UI SC191(Rev.1, May 2005, Annex 1) to IMO DE49 triggered a number of discussion points that led to amendments to the following resolutions:

UI SC191(Rev.2)  
New REC 91  
REC 39(Rev.2)  
UR Z10s

### **Points of Discussion**

3. Is the Annex to UI SC191(Rev.1, May '05, guidelines for approval / acceptance of alternative means of access) mandatory or non-mandatory ?

Answer: Non-mandatory. Hence, re-categorized as new REC 91.

4. Limitation of use of rafts in bulk carrier holds

DNV proposed that conditions for rafting should be limited to areas, such as anchorage or harbour, where swell conditions are limited to 0.5m. After discussion, GPG approved the ABS' alternative proposal to use the swell condition as a basis to determine the appropriateness of rafting, instead of geographic areas(harbours or anchorage). 5.5.4 of Z10.2 refers.

RINA proposed that para 5.5.4 should be included in all the Z10s. NK's objection is recorded as follows (3037hNKq, 29/08/2005):

1. With regard to RIm of 26 August 2005, NK considers that the proposed amendment to 5.5.4 should be limited to UR Z10.2.
2. Rafting survey for tankers are actually carried out on the open sea from a discharge port to a loading port and in such situation the rise of water within the tanks would always exceed 0.25m. It is different situation from rafting survey for hold frames of bulk carriers normally conducted in a harbour or at an anchorage.
3. If the same requirement applies to tankers, any rafting survey for cargo oil tanks and ballast tanks of tankers would be prohibited. This is not practicable under present survey procedure for tankers.
4. Therefore, NK can not support Laura's proposal that the proposed amendment to 5.5.4 of UR Z10.2 is introduced into the other URs and new Recommendation.

For compatibility with the IMO's mandatory requirements\*, GPG decided to add the same amendment to all the UR Z10s.

\*

- Appendix 4 to MEPC.99(48) 'Mandatory requirements for the Safe Conduct of CAS Surveys'
- MSC.197(80) – amendments to A.744918), Annex A for DSS and SSS bulk carriers and Annex B for single and double hull oil tankers.

As a consequence, 5.5.1 of REC 91(ex Annex to UI SC191) was also amended:

- to remove the reference to dynamic /sloshing (as the 0.25m rise was considered negligible);
- to refer to the rafting conditions contained for cargo holds in Z10.2 and Z10.5 and for oil cargo tanks in Z10.1 and Z10.4.

5. Means of access from longitudinal permanent means of access within each bay to rafts

GPG reviewed the proposal that the following text be added to Z10s:

[A means of access to the longitudinal permanent platform from rafts or boats is to be fitted in each bay.](#)

(Technical Background: for the safety of surveyors)

There may be ships which are arranged in accordance with para b, page 8 of the Annex to the current SC 191 (i.e., no means of access from the LPMA in each bay to a raft is required) and therefore could not be rafted if the sentence proposed by RINA ("[A means of access to the longitudinal permanent platform from rafts or boats is to be fitted in each bay](#)") is included in the Z10's.

GPG therefore agreed not to include this sentence in Z10s.

For the same reason, the same sentence was not added to Rec.39.

Finally, GPG added the following sentence to UI SC191(interpretation for II-1/3-6):

*A permanent means of access from the longitudinal platform to the water level indicated above is to be fitted in each bay (e.g permanent rungs on one of the deck webs inboard of the longitudinal permanent platform).*

## **6. Implementation**

It was agreed that the revised UI SC191 be implemented to ships contracted for construction 6 months after adoption by Council.

UI SC191 was also edited in line with IMO MSC/Circular. 1176, leaving its mandatory language (is/are to, shall) unchanged.

(Note: UI SC191(Rev.2) makes references to the following new Recommendations:

- REC 90: Ship Structure Access Manual
- REC 91: Guidelines for approval/acceptance of Alternative Means of Access)

23 September 2005  
Permanent Secretariat  
Updated on 13 Oct 2005.

**Survey Panel Task 43 – Amend the applicable sections of the URs to address the requirements for substantial corrosion in the Common structural rules.**

**Technical Background**

**(UR Z10.2, Rev.22, June 2006)**

**(UR Z10.4, Rev.4, June 2006)**

**(UR Z10.5, Rev.4, June 2006)**

**1. Objective**

Amend applicable sections of the URs to address the requirements for substantial corrosion in the Common structural rules.

**2. Background**

Due to the different application of substantial corrosion in the CSR from the current Unified Requirements.

**3. Methodology of Work**

Panel members discussed the proposed revisions through correspondence up to the Spring Panel meeting where final amendments were agreed upon for submittal to the IACS Hull Panel for review.

**4. Discussion**

After much discussion between all Panel members at the March 2006 Survey Panel members, a unanimous decision was reached as to the wording of CSR Substantial corrosion in UR Z10.2, 10.4, and 10.5 in section 1.2.9 and was then submitted to the Hull Panel for review and approval. The hull panel concluded that the Survey Panel definition for CSR substantial corrosion was not entirely accurate and recommended further amendments to clarify the actual requirements. The new definition was then circulated to the Survey Panel for a final review and was unanimously agreed upon.

**5. Implementation**

The Survey Panel is of the view that the Members need 12 months from the adoption date to implement these amendments into their class rules/procedures. Assuming that GPG and Council approve the amendments, the Survey Panel would propose **July 2007** as an implementation date.

Submitted by Survey Panel Chairman

## **Technical Background**

### **UR Z10.1 (Rev.14), UR Z10.2 (Rev.23), UR Z10.4 (Rev.5) & UR Z10.5 (Rev.5)**

#### **Survey Panel Task 3 – Maintenance of Alignment/ Compatibility of IACS URs and IMO survey requirements**

##### **1. Objective**

Maintenance of alignment/compatibility of IACS URs and IMO survey requirements regarding resolution MSC 197(80) – amendments to A744(18)

##### **2. Background**

IMO survey requirements to ESP vessels as amended in A744(18) as noted in MSC 197(80), with an implementation date of 1 January 2007.

##### **3. Methodology of Work**

Survey Panel members through correspondence.

##### **4. Discussion**

Survey Panel members, at the fall 2006 Survey Panel meeting, finalized the amendments to the applicable URs due to changes adopted at MSC(80).

Additionally, Members noted that URZ10.4 paragraphs 2.2.3.1 and 4.2.2.2 does not require examination of ballast tanks adjacent to heated fuel tanks, as required by MSC197(80). The survey panel agreed that if this is the position that IACS would like to take regarding double hull tankers, then it should be brought to the attention of IMO at the next IMO meeting, DE50 in March 2007.

##### **5. Implementation**

The Survey Panel is of the view that the Members need 12 months from the adoption date to implement these amendments into their class rules. Assuming that GPG and Council approve the amendments, the Survey Panel would propose January 2008 as an implementation date, although the IMO implementation date is January 2007.

Submitted by Survey Panel Chairman  
9 January 2007

##### **GPG discussion**

All members agreed to omit the requirement of examination of ballast tanks adjacent to heated fuel tanks, as required by MSC197(80), from URZ10.4 for double hull tankers and



that it should be brought to the attention of IMO at DE50. In addition ABS proposed that paragraphs relating to similar requirements in URZ10.1 should also be deleted for consistency and this was agreed by members.

Members also made a number of minor/editorial corrections to the text prior to their approval of the revised documents.

Added by Permanent Secretariat  
23 April 2007

## **Technical Background**

**URs Z7(Rev.15), Z7.1(Rev.5), Z7.2(Rev.1), Z10.1(Rev.15),  
Z10.2(Rev.26), Z10.3(Rev. 9), Z10.4(Rev.6), Z10.5(Rev.8) – November  
2007**

### ***Survey Panel Task 1 – Annual Review of Implementation of IACS Resolutions***

#### **1. Objective**

To review IACS Resolutions annually and discuss or propose amendments as deemed necessary.

#### **2. Background**

This proposed amendment to all URZ7s and URZ 10s was raised by the Panel member from DNV due to Owners crediting tanks concurrently under intermediate and special survey.

#### **3. Methodology of Work**

Survey Panel members through correspondence.

#### **4. Discussion**

The Panel member from DNV raised the issue of Owners having the ability of crediting spaces and thickness measurements only once in a 54 month interval, due to the availability of concurrent crediting of spaces and thickness measurements due to the flexible time window that is currently allowed between the intermediate survey and the special survey.

After a presentation and discussion lead by the DNV Panel member, all Survey Panel members agreed to the argument given by DNV, and further agreed to make the necessary changes in all URZ7s and URZ10s where Owners are not allowed to concurrently credit surveys and thickness measurements of spaces.

#### **5. Implementation**

The Survey Panel is of the view that the Members need 12 months from the adoption date to implement these amendments into their class rules. Assuming that GPG approve to the amendments, the Survey Panel would propose January 2009 as an implementation date.

Submitted by Survey Panel Chairman  
22 October 2007

**Permanent Secretariat note (December 2007):**

During GPG discussion DNV proposed that *“since this matter will be discussed between Owner and Class mainly in connection with the forthcoming Special Survey, DNV would prefer to locate this text, not only as part of Intermediate Survey, but also as a new text for the Special Survey.”* This was supported by BV, ABS, RINA and KR.

The revised documents were approved, with DNV’s proposal and an implementation date of 1 January 2009, on 15 November 2007 (ref. 7690\_IGb).

## Technical Background

### URs Z7(Rev.16), Z7.1(Rev.6), Z7.2(Rev.2), Z10.1(Rev.16), Z10.2(Rev.27), Z10.3(Rev.11), Z10.4(Rev.7) and Z10.5(Rev.9) - March 2009

#### Survey Panel Task 62:

- A) *Harmonization of UR Z10.1, Z10.2, Z10.4 and Z10.5 with UR Z10.3 with respect to items 5.5.4.4 and 5.6.2.*
- B) *Harmonization of UR Z7, Z7.1, Z10.1, Z10.2, Z10.3, Z10.4 and Z10.5 with UR Z7.2 with respect to the definition of the corrosion prevention system and with respect to the footnote 1 related to semi-hard coatings.*
- C) *Harmonization of the definition of Ballast Tank in UR Z7(Rev.14)*

#### 1. Objective

- A) Amend the texts of items 5.5.4.4 and 5.6.2 in Unified Requirements Z10.1, Z10.2, Z10.4 and Z10.5 in order to align them with those in UR Z10.3, in which they were changed while performing Task 55, whereas in the other UR Z10s they were kept unchanged on the grounds that this change was out of the scope of Task 55.
- B) Amend the definition of “Corrosion Prevention System” and include a Footnote 1 related to semi-hard coatings in Unified Requirements Z7, Z7.1, Z10.1, Z10.2, Z10.3, Z10.4 and Z10.5 in order to align them with those adopted in UR Z7.2, when this new UR was issued.
- C) Amend UR Z7 (Rev. 14) in all items where the term “Ballast Tank” is used in order to get them harmonized with the definition itself.

#### 2. Background

The task, as regards item A), was triggered by a Member Society, while performing Task 55, on the grounds that this part was out of the scope of the task and then should have been dealt with in a separate task.

The task, as regards item B), was triggered as a consequence of the “New Business action item 2” of the Minutes of the September 2008 Survey Panel meeting, for sake of harmonization of the various URZs.

The task, as regards item C), was triggered as a consequence of the “Task 54-Examination of Double Bottom Ballast Tanks at annual surveys” of the Minutes of March 2008 Survey Panel meeting, for sake of harmonization of the definition of Ballast Tank in UR Z7(Rev.14).

#### 3. Discussion

The task was carried out by correspondence. All the amended texts for the affected URs were prepared by the Survey Panel Member who had chaired the PT on Task 55, in accordance with the Form A approved by GPG. In addition to the objectives outlined in the Form A, an amendment was added to item 1.3.1 of UR Z10.2 and UR Z10.5 in which the reference 3.2.3.6 in the last item of the list was replaced by 3.2.3.10 as can be correctly verified in the text.

The amended URs were circulated to all Survey Panel Members for review, comments and agreement. The texts of the URs were unanimously agreed by all Members.

#### **4. Implementation**

The Survey Panel is of the view that the Member Societies need at least 12 months from the adoption date to implement these amendments into their class rules/procedures. Therefore, in the first version of all amended URs the following implementation sentence should be proposed:

*Changes introduced in Rev .xx are to be uniformly applied by Member Societies and Associates for surveys commenced on or after [not less than 12 months after the adoption by GPG/Council].*

Since it is common practice and convenience to have implementation dates either on 1<sup>st</sup> January or on 1<sup>st</sup> July of the year, the Survey Panel proposes the 1<sup>st</sup> July 2010 as implementation date, if GPG/Council approve the URs not later than 30 June 2009.

**Submitted by Survey Panel Chairman  
28 February 2009**

#### **Permanent Secretariat notes (April 2009):**

1. The amended URs were approved by GPG on 18 March 2009 (ref. 7718bIGd).
2. During the typesetting process it was noted that para 5.1.5 of UR 7.2 was inconsistent with the amended URs and so following consultation with the Survey Panel this was also amended at this time.
3. Regarding the implementation date, GPG agreed to use 1<sup>st</sup> July 2010 provided that it was consistently used for the amended URs.

## **Technical Background for UR Z10.4 Rev.8, Feb 2010**

### **1. Scope and objectives**

To amend UR Z10.4 (Rev.7) for the harmonization with currently revised MARPOL Annex I.

### **2. Engineering background for technical basis and rationale**

None

### **3. Source/derivation of the proposed IACS Resolution**

MARPOL 73/78  
IACS UR Z10.4 (Rev.7)

### **4. Summary of Changes intended for the revised Resolution:**

As MARPOL I was revised, the reference to MARPOL I/13 (3) in paragraph 1.2.2bis should read MARPOL I/18(3).

### **5. Points of discussions or possible discussions**

None

### **6. Attachments if any**

None

## Technical Background for UR Z10.4 Rev.9 (Mar 2011)

### 1. Scope and objectives

- 1) To amend UR Z10.4 to harmonize the definition of transverse section.
- 2) Update of references in the Executive Hull Summary Table IX.
- 3) Review IACS URZ10.4 to determine if there are issues which need to be addressed to ensure that the IACS survey regime and the CSRs are compatible.

### 2. Engineering background for technical basis and rationale

- 1) Based on that fact that bulk carriers and oil tankers have a transverse framing system applied for example on ship's sides etc. and that UR Z7 is applied to all types of ships and includes an extended definition of transverse section it is necessary to unify this definition in UR Z10s.
- 2) Update of references in the Executive Hull Summary Table IX such that the introduction of extended annual surveys is noted in the 'Memoranda' section rather than under 'Conditions of Class'.
- 3) Some requirements in CSRs for Oil Tankers were relevant to ships in operation and it was decided to move them from CSRs to UR 10.4 in more consistent way.

### 3. Source/derivation of the proposed IACS Resolution

CSRs, IACS UR Z7.

Proposed amendments to UR Z10.4 is based on internal discussion of IACS which is always striving to produce consistent and compatible rule requirements.

### 4. Summary of Changes intended for the revised Resolution:

- 1) The following additional text is added to the definition of transverse section in para 1.2.5:

*"For transversely framed vessels, a transverse section includes adjacent frames and their end connections in way of transverse sections."*

- 2) In the Executive Hull Summary Table IX (iv) the reference to part H) is updated to part I) as per Table IX (ii).
- 3) The main amendment has consisted in removing the requirements found in the CSRs related to surveys after construction and locating them in the applicable sections of UR Z10.4. The rationale of that is to have only one place where survey requirements are given and avoid any duplication of requirements in different documents, which would give rise to problems of maintenance and alignment.

Other important amendments have been made moving the following items from the CSRs to UR Z10.4 as applicable:

## Part B

- a) the paragraphs regarding the different corrosion patterns, such as pitting corrosion, edge corrosion and grooving corrosion, and their different acceptance criteria,
- b) the items regarding the number and locations of thickness measurements, together with the associated table and referenced figures.

Another notable change has been introduced in the "ANNEX II - Recommended Procedures for Thickness Measurements" of UR Z10.4, which, however, are only recommendatory and not mandatory, where thickness measurements forms specific to CSRs double hull oil tankers have been produced in addition to the existing ones, which only apply to non-CSRs ships.

### **5. Points of discussions or possible discussions**

None.

### **6. Attachments if any**

None.



## **Technical Background for UR Z10.4 Rev.10, July 2011**

### **1. Scope and objectives**

Review the requirement for repairs within IACS UR 7 and UR 10 series, in particular the requirement for Prompt and Thorough Repair, with a view to developing wording that would permit a temporary repair and the imposition of a Recommendation/ Condition of Class under specific and controlled circumstances, and in accordance with PR35.

### **2. Engineering background for technical basis and rationale**

There are instances, for example a localised, isolated and very minor hole in a cross-deck strip, at which a suitable temporary repair, for example by welding or doubling, and the imposition of a suitable short term Recommendation/ Condition of Class for permanent repair at a later date, are considered very adequate methodology for dealing with the defect.

Current IACS Requirements in the UR Z7 and Z10 series, for Prompt and Thorough repair, would not permit this to be an option, the defect would have to be permanently Promptly and Thoroughly repaired, which might require removing cargo, moving to a repair berth and staging inner spaces.

Under the Requirements of IACS Procedural Requirement PR 35 the methodology of Temporary Repair and imposition of a suitable short term Recommendation/ Condition of Class for permanent repair at a later date is fully permissible.

### **3. Source/derivation of the proposed IACS Resolution**

Based upon discussion within the IACS Survey Panel.

### **4. Summary of Changes intended for the revised Resolution:**

Following the definition of Prompt and Thorough Repair in the Unified Requirement, a new paragraph is proposed to be added:-

"1.3.3 Where the damage found on structure mentioned in Para. 1.3.1 is isolated and of a localised nature which does not affect the ship's structural integrity, consideration may be given by the surveyor to allow an appropriate temporary repair to restore watertight or weather tight integrity and impose a Recommendation/Condition of Class in accordance with IACS PR 35, with a specific time limit."

Also, Table I was split to into 2 tables for enhanced clarity, Table I.1 for Single Skin and Table I.2 for Double skin ships and miscellaneous editorial errors in the Table I.1 and I.2 are corrected.

### **5. Points of discussions or possible discussions**

a) The points of discussion are as indicated in Sections 2 and 4 above.

b) Discussion took place on whether to prepare this amendment as a Unified Interpretation of IMO Resolution A.744(18)/UR Z7 and Z10 series, finally it was agreed to make direct amendment to the relevant URs.

c) It is proposed that this amendment be submitted directly to the IMO DE/MSC Committees for consideration of amending directly IMO Res. A744(18)

**6. Attachments if any**

None

## **Technical Background for UR Z10.4 Rev.12, Jan 2014**

### **1. Scope and objectives**

- a) To consider appropriate text in IACS document regarding class period for lengthy conversions.
- b) To align the requirements in PR37 and UR Z10s regarding safe entry to confined spaces.

### **2. Engineering background for technical basis and rationale**

- a) As per the IMO Res. A1053 (27), lengthy conversions (not necessarily of major character) or other major repair work can be assigned for a 5 year period from the date of completion of conversion/repairs/surveys.
- b) Safety requirements in IACS PR37 can be applied to carry out survey in safe way for all kind of ships. When there are no indications about the safety of surveyor in UR Z10s then the requirements in PR37 shall be applied.

### **3. Source/derivation of the proposed IACS Resolution**

None

### **4. Summary of Changes intended for the revised Resolution**

- a) Following additional text was included to section 2.1.3 to clarify the class period for lengthy conversions

"In cases where the vessel has been laid up or has been out of service for a considerable period because of a major repair or modification and the owner elects to only carry out the overdue surveys, the next period of class will start from the expiry date of the special survey. If the owner elects to carry out the next due special survey, the period of class will start from the survey completion date."

- b) Existing Section 5.2.6 and 5.2.7 were deleted from UR Z10s since provisions of these sections were covered by PR37. Reference of PR37 was included in Section 5.2.1.1.

### **5. Points of discussions or possible discussions**

- i) Additional text to Para.2.1.3 was discussed in order to clarify class period.
- ii) Panel considered that safety of surveyors should be dealt by PR37.

### **6. Attachments if any**

None

**UR Z10.5 “Hull Surveys of Double Skin Bulk Carriers”****Summary**

This revision is to harmonize the revised requirements in line with the amendments made to ESP Code vide Res.MSC.525(106)

**Part A. Revision History**

<b>Version no.</b>	<b>Approval date</b>	<b>Implementation date when applicable</b>
Rev.20 (Feb 2023)	08 February 2023	1 July 2024
Rev.19 (May 2018)	30 May 2019	1 July 2020
Rev.18 (Jan 2018)	15 January 2018	1 January 2019
Rev.17 (Sep 2017)	26 September 2017	1 January 2019
Rev.16 (Nov 2016)	22 November 2016	1 January 2018
Rev.15 (Feb 2015)	05 February 2015	1 July 2016
Rev.14 (Jan 2014)	14 January 2014	1 January 2015
Rev.13 (June 2013)	05 June 2013	1 July 2014/1 July 2016 * <sup>2</sup>
Rev.12 (May 2012)	12 May 2012	1 January 2013
Rev.11 (Jul 2011)	27 July 2011	1 July 2012
Rev.10 (Mar 2011)	24 March 2011	1 July 2012
Rev.9 (Mar 2009)	18 March 2009	1 July 2010
Rev.8 (Nov 2007)	15 November 2007	1 January 2009
Rev.7 (Jul 2007)	14 July 2007	1 July 2008
Rev.6 (Apr 2007)	12 April 2007	1 July 2008
Rev.5 (Feb 2007)	10 February 2007	1 January 2007 / 1 January 2008 * <sup>1</sup>
Rev.4 (Jun 2006)	23 June 2006	1 July 2007
Rev.3 (Jan 2006)	31 January 2006	1 January 2007
Rev.2 (Jan 2006)	4 January 2006	1 January 2007
Rev.1 (Jun 2005)	27 June 2005	1 July 2006
Corr.1 (Jan 2004)	26 January 2004	
NEW (Dec 2003)	10 December 2003	1 January 2005

**\* Notes:**

- Changes introduced in Rev.5 are to be uniformly implemented for surveys commenced on or after 1 January 2008, whereas statutory requirements of IMO Res. MSC 197(80) apply on 1 January 2007.
- The changes to section 6 introduced in Rev.11 are to be uniformly applied by IACS Societies for surveys commenced on or after 1 July 2016.  
The other changes introduced in Rev.11 are to be uniformly applied by IACS Societies for surveys commenced on or after 1 July 2014.

- **Rev. 20 (Feb 2023)**

**.1 Origin of Change:**

- o Suggestion by an IACS member
- o Based on IMO Regulation

**.2 Main Reason for Change:**

To revise the definition of Ballast tank from use of 'solely' carriage of salt water to 'primarily' use in line with other IACS URs and ESP Code.

To revise the criteria for annual examination of ballast tanks from POOR condition to condition less than GOOD in line with the amendments made to ESP Code vide Res.MSC.525(106).

To insert a new requirement for annual examination of double-side skin void spaces, for bulk carriers exceeding 20 years of age and of 150 m in length and upwards, as a consequence of the results of the renewal survey and intermediate survey in line with the amendments made to ESP Code vide Res.MSC.525(106).

To refine the wording of ballast tanks examination requirements at annual surveys in line with the amendments made to ESP Code vide Res.MSC.525(106).

To insert the Owners Inspection Report to make in line with other IACS URs.

To revise a reference changed to IACS Recommendation in line with other IACS URs and the amendments made to ESP Code vide Res.MSC.525(106).

**.3 List of non-IACS Member classification societies contributing and/or participating in IACS Working Group:**

None

**.4 History of Decisions Made:**

- One survey panel member pointed out the definition of ballast tank in UR 10s are different from other URs like UR7/7.1/7.2 and the ESP Code, so panel decided to modify the wording 'solely' to 'primary'. (PSU20004)

- Enhancement of ballast tank examination for bulk carriers, that increase the criteria of annual examination from 'POOR' condition to the condition less than 'GOOD', was submitted to SDC8. Although IACS has objected to the view and submitted commenting papers continuously, the proposal was agreed at SDC8 and published as Res.MSC.525(106).

- One another new requirement, examination of double-side skin void spaces, for bulk carriers exceeding 20 years of age and of 150 m in length and upwards, at annual survey when required as a consequence of the results of the renewal survey and

intermediate survey was proposed to SDC8. Although IACS continuously objected the proposal, it was agreed at SDC8 and published as Res.MSC.525(106).

- One survey panel member suggested to refine the wording 'extended annual/intermediate survey' to 'examination of ballast tanks at annual surveys' in Executive Hull Summary and panel decided to modify it in the ESP Code first. It was submitted to SDC8 and included in Res.MSC.525(106). (PSU18056)

- One survey panel member pointed out that the Owners Inspection Report, that is included in UR Z10.1, 10.2, and 10.4, is not included in UR Z10.5, and all members agreed to insert it as a table III. (PSU20013)

- One survey panel member pointed out that the references in UR Z10s need to updated (referred documents have been changed to IACS Recommendations) and deleted to be in line with other UR Z10s. And panel decided to delete the reference of itself in UR Z10.2 in line with the amendments made to ESP Code vide Res.MSC.525(106). (PSU19057)

No TB is expected for the present revision.

#### **.5 Other Resolutions Changes:**

Unified Requirements: Z10.2, Z10.4 and Z10.5

#### **.6 Any hinderance to MASS, including any other new technologies:**

None

#### **.7 Dates:**

Original Proposal:	28 January 2020	(PSU20004)
	24 October 2017	(PSU18056)
	18 December 2019	(PSU19057)
	16 March 2020	(PSU20013)
Panel Approval:	12 October 2021	(PSU21026_ISUf)
GPG Approval:	08 February 2023	(22198_IGd)

### **• Rev. 19 (May 2019)**

#### **.1 Origin of Change:**

- o Suggestion by an IACS member

#### **.2 Main Reason for Change:**

This revision is to address the policy decision made by GPG using the common terminology 'Condition of Class'(CoC) instead of the terms 'Recommendation/ Condition of Class' based on the outcome of III 5.

**.3 List of non-IACS Member classification societies contributing through the TC Forum and/or participating in IACS Working Group:**

None

**.4 History of Decisions Made:**

During the 29th panel meeting, the panel discussed about the comments of members, and concurred with the view to retain the present definitions of CoC in the IACS resolutions with the wording 'Recommendation' to be removed. The panel also agreed to use the term 'Statutory Condition' for the 'recommendation' of the statutory certificates in IACS resolutions and RECs, and when discussing the proposal of a member to consider the harmonization of the terms of 'recommendation' and 'condition of class' in RO Code, the panel unanimously agreed to take no action on the IMO instruments, leaving the relevant actions to be decided by the relevant IMO bodies when IACS feeds back to IMO the IACS action on the harmonization of the two terms.

Panel members concurred with the view that it is not necessary to develop a new procedure requirement, and agreed to set the implementation date of these IACS resolutions (other than RECs) as 1st July 2020.

Before the implementation date of 1st July 2020 for using the common terminology 'Condition of Class' only, 'Recommendations' and 'Condition of Class' are to be read as being different terms used by Societies for the same thing, i.e. requirements to the effect that specific measures, repairs, surveys etc. are to be carried out within a specific time limit in order to retain Classification.

No TB is expected for the present revision.

**.5 Other Resolutions Changes:**

The following IACS resolutions and Recommendations (RECs) were agreed to be revised:

- Procedural Requirements: PR1A, PR1B, PR1C, PR1D, PR1 Annex, PR3, PR12, PR20, PR35 and the attachment of PR16;
- Unified Requirements: Z7, Z7.1, Z7.2, Z10.1, Z10.2, Z10.3, Z10.4, Z10.5, Z15 and Z20
- Unified Interpretations: GC13
- Recommendations: Rec.41, Rec.75, Rec.96, Rec.98

**.6 Any hinderance to MASS, including any other new technologies:**

None

## **.7 Dates:**

Original Proposal: 14 January 2019 tasked by GPG (17044bIGm)

Panel Approval: 22 March 2019 (PSU19010)

GPG Approval: 30 May 2019 (17044bIGu)

## **• Rev.18 (Jan 2018)**

### **.1 Origin of Change:**

- Suggestion by an IACS member

### **.2 Main Reasons for Change:**

In order to introduce new provisions into the ESP Code which were found among the ESP Code and relevant URZ10s, a series of items of UR Z10s shall be amended accordingly with ESP Code.

### **.3 List of non-IACS Member Classification Societies contributing through the TC Forum and/or participating in IACS Working Group:**

None

### **.4 History of Decisions Made:**

Panel members discussed this issue under PSU17018: updating the CSR reference for both HCSR and CSR for Bulk Carriers; "Thickness measurement company" was to be replaced with "Thickness measurement firm" throughout the UR; some paragraphs were to be revised for consisting with ESP Code; etc.

During the 26<sup>th</sup> Survey Panel Meeting, the Panel discussed the divergence and reached agreements with the revisions.

No TB is expected for the present revision.

### **.5 Other Resolutions Changes**

UR Z10.1, UR Z10.2, UR Z10.3, UR Z10.4

### **.6 Dates:**

Original Proposal: 22 October 2016 by a Survey Panel Member

Panel Approval: 24 December 2017 by Survey Panel (Ref: PSU17018)

GPG Approval: 15 January 2018 (Ref:17189\_IGc)



- **Rev.17 (Sep 2017)**

**.1 Origin of Change:**

- Suggestion by an IACS member

**.2 Main Reasons for Change:**

To introduce the criteria for the steel renewal which belongs under the unified requirements of series S and are related to the net scantling approach

**.3 List of non-IACS Member Classification Societies contributing through the TC Forum and/or participating in IACS Working Group:**

None

**.4 History of Decisions Made:**

A member noted that some Unified Requirements of series S (Strength of Ships), such as UR S18, contain criteria addressing the steel renewal for dedicated structures such as transverse bulkheads, cargo hatch coamings and plating. These criteria (based on the net scantling approach) are applicable also to units designed with the gross scantling approach because they refers to particular structures for which it is foresaw the dimensioning (or the design verification) according to the net scantling approach.

During the 24<sup>th</sup> Survey Panel Meeting the members agreed to review all UR of the S series in order to identify those containing any steel renewal criteria with the scope to review them.

Having found that UR S18, UR S19 and UR S21 contain steel renewal criteria that need to be taken in to account during the thickness measurements review process, the members agreed that a new paragraph dealing with this issue needed to be added under section 8 of UR Z10.5.

The paragraph 8.1.2 "Thickness measurements Acceptance Criteria", has been agreed and inserted in the present revision of UR Z10.5.

No TB is expected for the present revision.

**.5 Other Resolutions Changes**

UR Z7, UR Z7.1, UR Z10.2

**.6 Dates:**

Original Proposal: 09 September 2016 (24<sup>th</sup> Survey Panel meeting)  
Made by a Survey Panel Member  
Panel Approval: 25 August 2017 (Ref: PSU16044)  
GPG Approval: 26 September 2017 (Ref: 17107aIGb)

- **Rev.16 (Nov 2016)**

**.1 Origin of Change:**

- Suggestion by IACS members

**.2 Main Reasons for Change:**

To address the Observation 04, raised by the IMO Auditing Team 5 of the IACS common package 1 in respect to the functional requirements (FR) 9-15.

**.3 List of non-IACS Member Classification Societies contributing through the TC Forum and/or participating in IACS Working Group:**

None

**.4 History of Decisions Made:**

Based upon a GPG Member's proposal, the Panel examined, under the task PSU16017, the possible modification of the UR Z10.2 in order to include the verification of the Ship Construction File (SCF) during the class periodical surveys for those ships subjected to the requirements of SOLAS reg. II-1/3-10.

The suggested text was discussed by the Members and it was agreed that since the issue might be regarded as a proactive extension of the corrective action to OBS 04 this should be inserted under paragraph 6.4.2 of UR Z10.2.

Members reviewed the proposed text together with the relevant proposals of its modification; during the 24th Survey Panel meeting agreed to add the new paragraphs 6.4.2.1 and 6.4.2.2 dealing with the verifications of the Ship Construction File to be performed during the periodical surveys.

No technical background is expected for this revision.

**.5 Other Resolutions Changes**

The amendment affects UR Z10.2 and UR Z 10.4.

**.6 Dates:**

Panel Approval: 09 September 2016 - 24th Survey Panel Meeting

GPG Approval: 22 November 2016 (Ref: 16077\_IGd)

- **Rev.15 (Feb 2015)**

**.1 Origin of Change:**

- Suggestions by IACS members

## **.2 Main Reasons for Change:**

- a) Consider appropriate text in IACS document regarding the applicability of the Thickness Measurements when the Close up survey is performed.
- b) Modification of Table II MINIMUM REQUIREMENTS FOR THICKNESS MEASUREMENTS AT SPECIAL SURVEY FOR DOUBLE SKIN BULK CARRIERS
- c) To consider the impracticability of the internal structure close up inspection of cargo hold hatch covers which have no access structurally (from the approved design) and it is possible to survey and gauge plating only.
- d) To consider that some double skin bulk carriers are of longitudinal construction instead that of transversal construction.

## **.3 List of non-IACS Member classification societies contributing through the TC Forum and/or participating in IACS Working Group:**

None

## **.4 History of Decisions Made:**

- a) Following an ACB query an IACS member proposed to add suitable text in appropriate IACS documents regarding the application of the Thickness Measurements when the close up surveys are performed as survey requirement due at the Intermediate/ Renewal Class surveys. This Member expressed the view that the requirements to execute the Thickness Measurements of the area subject to Close Up Surveys are expected into the table relevant to "MINIMUM REQUIREMENTS FOR THICKNESS MEASUREMENTS AT SPECIAL SURVEY ....." while the paragraph 1.4 of the document contains only the requirement that "Thickness Measurements of the areas subject to close up surveys shall be taken in conjunction with the close up survey".

Panel discussed the matter under item PSU13051 and considered that wordings of Para 1.4 of current UR Z7s/10s need to be revised in order to clarify the issue. Considering also item b) finally Panel agreed

- b) An IACS member noted that table II relevant to "MINIMUM REQUIREMENTS FOR THICKNESS MEASUREMENTS AT SPECIAL SURVEY FOR DOUBLE SKIN BULK CARRIERS" did not recalled correctly the tables of the close up surveys. In fact the table II was recalling generically table I while it should be necessary specify table I/Sheet 1 table I/Sheet 2 as applicable, being two separate tables for Double Skin Bulk Carriers and Ore Carriers in the UR Z10.5. According to the highlight, Member proposed the modification of table II of UR Z10.5
- c) Panel, following the proposal submitted by a Member, concurred and agreed that in case the cargo hold hatch covers have a configuration that does not permit the ingress of the surveyor for the internal inspection (e.g. box type panel), the close up survey should be limited to external parts as well as the Thickness Measurements that should be performed only on the external plating. The technical background, on which is based the modification of the requirement, is that the internal structure of a hatch cover of box type construction are reasonably not subject to any corrosion phenomenon. Hence, unless the external plating of the box is damaged, no depletion of the internal structures is expectable.

Panel discussed the matter under item PSU13051 and considered that an explanation note to Para 2.2.4.1 and to Table 1 of current UR Z10.2 and UR Z10.5 need to be added to clarify this issue.

- 1) to add additional wording to Para.1.4;
  - 2) to modify table II of UR Z10.5
  - 3) to add a note, relevant to the inspection of the cargo hold hatch covers, to para 2.2.4.1 and to table I (Sheet 1 and Sheet 2).
- d) Panel, under task PSU14004) considered the issue relevant the possibility that the ordinary framing of a double skin bulk carrier may be also of longitudinal construction. Panel agreed to modify in consistency the close up survey requirements for double skin spaces in Table I/Sheet I: Moreover, in relation to this modification Panel agreed to remove the wording "web" so that instead to read "transverse web frames" it will read "transverse frames". According to the outcomes of the discussions Members noted inconsistencies in the following figures, showing the places where measurements have to be taken (figures no. 4, 6, 7 and 8) because they showed only the cases of a transversally framed double skin. Modified figures have been inserted (figures no 4, 6, 7 and 8) and the new figure 11(b), relevant to the close up area of a longitudinally framed double skin, has been inserted.

## **.5 Other Resolutions Changes**

1. The identical amendment a) affects UR Z7, UR Z7.1, UR Z7.2, UR Z10.1, UR Z10.2, UR Z10.3 and UR Z10.4.
2. The amendment c) affects also Ur Z7.1 and UR Z 10.2.

## **.6 Dates:**

Panel Approval: Amendment a) at 19th Survey Panel Meeting (6 March 2014)  
Amendment b) and c) by correspondence under PSU 13051  
Amendment d) by correspondence under PSU 14004

GPG Approval: 05 February 2015 (Ref: 14193\_IGc)

## **• Rev. 14 (Jan 2014)**

### **.1 Origin of Change:**

- Suggestion by IACS members
- Suggestion by GPG

### **.2 Main Reasons for Change:**

- a) To consider appropriate text in IACS document regarding class period for lengthy conversions.
- b) To align the difference between PR37 and URZ's regarding safe entry to confined spaces.

### **.3 List of non-IACS Member classification societies contributing through the TC Forum and/or participating in IACS Working Group:**

None

### **.4 History of Decisions Made:**

- a) With reference to IMO Res. A1053 (27) (5.5 Application of "special circumstances") an IACS member proposed to add suitable text in appropriate IACS document regarding class period for lengthy conversions. This Member expressed that when a renewal survey has been completed, the new 5 year class period would normally be calculated from the expiry of previous class period/class certificate and in some cases this might result in unreasonably short time from one renewal survey completion until the next renewal would be due.

Panel discussed and considered that wordings of Para 2.1.3 of current UR Z7s/10s (second sentence) could address this issue but finally agreed to add additional text to Para 2.1.3 in order to clarify this matter.(PSU 13024)

- b) Panel discussed to clarify the survey requirements in PR37 and URZ's regarding safe entry to confined spaces. Panel considered that the safety issues of surveyor should be dealt by PR37. At 18<sup>th</sup> Panel meeting, Panel concluded to delete requirements from UR Z10s which were already covered by the PR37.

### **.5 Other Resolutions Changes**

- a) The identical amendment affects UR Z7, UR Z7.1, UR Z7.2, UR Z10.1, UR Z10.2, UR Z10.3 and UR Z 10.4.  
b) The identical amendment affects UR Z10.1, UR Z10.2, UR Z10.3 and UR Z 10.4.

### **.6 Dates:**

Panel Approval: 7 November 2013 by Survey Panel

GPG Approval: 14 January 2014 (Ref: 12011aIGd)

## **• Rev.13 (June 2013)**

### **.1 Origin of Change:**

- Suggestion by an IACS Member
- Suggestion by GPG in response to the request of EG/SoS
- Suggestion by EG/GBS in response to GPG Chairman's request in 10060fIGg

### **.2 Main Reason for Change:**

- a) An inquiry from a member whether the 'Other equivalent means' referred in Para 5.3.2 of IACS UR Z10.2 include the use of Cherry Pickers for survey of other structures. (PSU 12022)
- b) To introduce provision in UR Z10s that Rescue and emergency response equipment must be suitable for the configuration of the space being surveyed including the

size of the access points.(PSU 12032, GPG 12138\_)

- c) In order to comply with the IMO Goal Based Standard (GBS), it is required to update the Ship Construction File (SCF) throughout the ship's service life. Therefore, procedures for updating SCF have been added in UR Z10s.

### **.3 List of non-IACS Member classification societies contributing through the TC Forum and/or participating in IACS Working Group:**

None

### **.4 History of Decisions Made:**

- a) Discussion of this matter initiated by a Panel member regarding the use of Cherry Pickers in Cargo Holds with reference of IACS URZ10.2. In accordance with UI SC191 and Rec 91, the Cherry Picker is allowed up to 17m height for Cargo Hold structure (ships constructed after 2006 for Alternative means of access). As per the provisions of URZ10.2, Cherry pickers are allowed for survey of side shell frames only.

Panel discussed and considered that Para 5.3.2 of UR Z10.2 allows the use of Cherry Pickers as 'Other equivalent means'. Accordingly, Panel agreed to clarify this matter by including text "hydraulic arm vehicles such as conventional cherry pickers" to UR Z10s and UR Z7s for a ship not subjected to the above 17m restriction.

- b) GPG Chairman requested to consider the suggestion of EG/SoS to clarify the wording in UR Z 10.1 – 10.5 to make it compliance with draft PR37 submitted by EG/SoS.

The Survey Panel discussed this matter and introduced a new (sub-)section 5.5 "Rescue and emergency response equipment" in line with the suggestion of EG/SOS.

- c) At the time of reviewing the revised UR Z23 which is followed only for new construction, PT/GBS proposed that URZ10s should have provisions for updating Ship Construction File (SCF) since it would be maintained throughout the ship's service life.

Survey Panel at its 17th meeting discussed the proposals of PT/GBS for the revision of UR Z10s in order to comply the IMO GBS requirements for existing vessels. Panel agreed to add new text in URZ10.5 for updating and monitoring the SCF.

### **.5 Other Resolutions Changes**

- a) The identical amendment affects UR Z7, UR Z7.1, UR Z10.1, UR Z10.2, UR Z10.3, and UR Z 10.4.
- b) The identical amendment affects UR Z10.1, UR Z10.2, UR Z10.3 and UR Z 10.4
- c) The identical amendment affects UR Z10.2 and UR Z10.4.

**.6 Dates:**

Panel Approval: 7 March 2013 during Survey Panel Meeting  
GPG Approval: 5 June 2013 (Ref: 9640\_IGn & 10060fIGn)

• **Rev.12 (May 2012)**

**.1 Origin of Change:**

Suggestion by an IACS member

**.2 Main Reason for Change:**

Based upon queries by both owners and surveyors, clarification was required for the SSH No. 2 requirements in Table I.

**.3 List of non-IACS Member classification societies contributing through the TC Forum and/or participating in IACS Working Group:**

None

**.4 History of Decisions Made:**

Completed through correspondence.

**.5 Other Resolutions Changes**

None

**.6 Dates:**

Original Proposal: 21 October 2011 2010 Made by Survey Panel  
Panel Approval: March 2012  
GPG Approval: 12 May 2012 (Ref: 12067\_IGb)

• **Rev.11 (July 2011)**

**.1 Origin of Change:**

Suggestion by an IACS member

**.2 Main Reason for Change:**

Following external audit a member was advised that a small temporary doubler on a cross-deck strip of a bulk carrier should have been promptly and thoroughly repaired at the time of survey. The member carried out an investigation and found that the actions of the surveyor were fully justifiable, the temporary repair and short term Condition of Class imposed were an appropriate method of dealing with such a situation. The member advised that the current requirements for 'Prompt and Thorough Repair' stipulated under the UR 7 and UR 10 series do not give any leeway

for carrying out temporary repairs (and imposing a Recommendation/Condition of Class in accordance PR 35) where the damage in question is isolated and localised, and in which the ship's structural integrity is not impaired.

The Survey Panel discussed the matter and agreed that under carefully defined circumstances a temporary repair and short term Recommendation/Condition of Class would be an appropriate course of action.

### **.3 List of non-IACS Member classification societies contributing through the TC Forum and/or participating in IACS Working Group:**

None

### **.4 History of Decisions Made:**

The matter was discussed by correspondence within the Survey Panel and at the Autumn 2010 Panel Meeting. Following discussion at which the possibility of a Unified Interpretation being raised was considered, it was eventually decided to make direct amendment to the relevant Unified Requirements.

The wording of the new paragraph to be inserted as Para 1.3.3 in all relevant Unified Requirements was extensively discussed prior to agreement.

The proposal was unanimously agreed by Survey Panel Members.

### **.5 Other Resolutions Changes**

The identical amendment affects UR Z7, UR Z7.1, UR Z7.2, UR Z10.1, UR Z10.2, UR Z10.3, UR Z10.4 and UR Z 10.5.

### **.6 Dates:**

Original Proposal: *September 2010 Made by a Member*

Panel Approval: *March 2011*

GPG Approval: *27 July 2011 (Ref: 11118\_IGb)*

## **• Rev.10 (Mar 2011)**

### **.1 Origin for Change:**

Suggestion by IACS member

### **.2 Main Reason for Change:**

- 1) Inconsistency of the definition of transverse section of the ship given in URZ7 and URZ10s.
- 2) Update of references in the Executive Hull Summary Table VII.
- 3) To make the survey requirements in UR Z10.5 compatible with the new requirements contained in CSRs.



### **.3 List of non-IACS Member classification societies contributing through the TC Forum and/or participating in IACS Working Group:**

None.

### **.4 History of Decisions Made:**

Item 1) was proposed by RS and item 2) was proposed by GL. Both amendments were agreed by the Panel.

Regarding item 3), The Survey Panel Members decided that the task would be carried out by a Project Team, rather than through correspondence within the Panel. The PT was composed by three Members from the Survey Panel and one Member, external to the Panel, who was expert both in surveys and in structural matters. Subsequently the PT requested the Small Group on Strategy & Steering Committee that the PT were enlarged with the joining of two additional Members of the Hull Panel, in order to increase the PT's expertise in the CSRs based on the fact that CSRs would be amended, even if limitedly to requirements related to surveys after construction. The Small Group on Strategy & Steering Committee fulfilled the PT request.

### **.5 Other Resolutions Changes**

UR Z10.1, Z10.2, Z10.3 and Z10.4.

### **.6 Dates:**

Original Proposal: *January 2010, made by Survey Panel*  
Survey Panel Approval: *July/November 2010*  
GPG Approval: *24 March 2011 (Ref: 10170\_IGe)*

#### **• Rev.9 (Mar 2009)**

Survey Panel Task 62 - *Harmonization of UR Z10s to UR Z10.3(Rev.10).*

See TB document in Part B.

#### **• Rev.8 (Nov 2007)**

Survey Panel Task 1 – *Concurrent crediting of tanks.*

See TB document in Part B.

#### **• Rev.7 (Jul 2007)**

Alignment of TM requirements in UR Z10.5 with other UR Z10s (Survey Panel Task 1).

See TB document in Part B.

- **Rev.6 (Apr 2007)**

Survey Panel Task 10 – *Develop survey requirements for void spaces of ore carriers.*

See TB document in Part B.

- **Rev.5 (Feb 2007)**

Survey Panel Task 3 – *Maintenance of Alignment/Compatibility of IACS URs and IMO survey requirements.*

See TB document in Part B.

- **Rev.4 (Jun 2006)**

Survey Panel Task 43 – *Amend the applicable sections of the URs to address the requirements for substantial corrosion in the Common structural rules.*

See TB document in Part B.

- **Rev.3 (Jan 2006)**

Survey Panel Task 11 – *Unified Periodic Survey Requirements related to SOLAS Reg. XII/12 & Reg. XII/13.*

See TB document in Part B.

- **Rev.2 (Jan 2006)**

Survey Panel Task 22 – *Amend applicable URZ7s and Z10s to align Close-Up Survey and Thickness measurements to be carried out at the same time and location allowing for a more structured control of the thickness measurement process – plus additional changes relating to access for rafting surveys.*

See TB document in Part B.

- **Rev.1 (Jun 2005)**

WP/SRC Task 102 - *Harmonization of UR Z7s and Z10s*

See TB document in Part B.

- **Corr.1(Jan 2004)**

To keep consistency between Z10.2 and Z10.5 for ships of 10-15 years, paras 4.2.3.1 - 4.2.3.3 were corrected to read:

*"the extent of intermediate survey is to be equivalent to the previous special survey".*

See TB document in Part B.

- **NEW (Dec 2003)**

WP/SRC Task 69 to amend URZ10.2 or develop a new UR for Hull Surveys of Double Side Skin Bulk Carriers.

See TB document in Part B.

## **Part B. Technical Background**

List of Technical Background (TB) documents for UR Z10.5:

Annex 1. **TB for NEW (Dec 2003) and Corr.1 (Jan 2004)**

See separate TB document in Annex 1.

Annex 2. **TB for Rev.1 (Jun 2005)**

See separate TB document in Annex 2.

Annex 3. **TB for Rev.2 (Jan 2006)**

See separate TB document in Annex 3.

Annex 4. **TB for Rev.3 (Jan 2006)**

See separate TB document in Annex 4.

Annex 5. **TB for Rev.4 (Jun 2006)**

See separate TB document in Annex 5.

Annex 6. **TB for Rev.5 (Feb 2007)**

See separate TB document in Annex 6.

Annex 7. **TB for Rev.6 (Apr 2007)**

See separate TB document in Annex 7.

Annex 8. **TB for Rev.7 (Jul 2007)**

See separate TB document in Annex 8.

Annex 9. **TB for Rev.8 (Nov 2007)**

See separate TB document in Annex 9.

Annex 10. **TB for Rev.9 (Mar 2009)**

See separate TB document in Annex 10.

Annex 11. **TB for Rev.10 (Mar 2011)**

See separate TB document in Annex 11.

Annex 12. **TB for Rev.11 (Jul 2011)**

See separate TB document in Annex 12.

Annex 13. **TB for Rev.12 (May 2012)**

See separate TB document in Annex 13.

Annex 14. **TB for Rev.14 (Jan 2014)**

See separate TB document in Annex 14.

*Note: There is no separate Technical Background (TB) document available for Rev.13 (June 2013), Rev.15 (Feb 2015), Rev.16 (Nov 2016), Rev.17 (Sep 2017), Rev.18 (Jan 2018), Rev.19 (May 2019) and Rev.20 (Feb 2023).*

## **UR Z10.5 (New, November 2003, Correction Jan 2004)**

### **Technical background**

#### **1. Objective**

WP/SRC to develop a new UR for Hull Surveys of Double Side Skin Bulk Carriers

#### **2. Points of discussion**

- 2.1 In 1999, GPG identified a need to develop a UR (or amend Z10.2) applicable to double side skin bulk carriers.

WP/SRC was so tasked to develop a UR tailored to the structural configuration of double hull bulk carriers and other features which distinguish double hull bulk carriers from single skin bulk carriers. The UR, when developed, would be submitted to IMO for incorporation in future amendments to A.744(18).

- 2.2 GPG, after the first round of the draft UR in 2003, then tasked WP/SRC to further consider the definition of bulk carriers, how to treat bulk carriers with hybrid cargo hold arrangements, survey requirements for wing ballast tanks of ore carriers (WP/SRC Task 113).

- 2.3 Taking into account the draft definitions of bulk carrier, single side skin bulk carrier, double side skin bulk carrier as developed at IMO MSC 77 (MSC 77/WP.13/Annex 2), GPG agreed to the definition as proposed by WP/SRC (Z10.5.1.2.1). Ore carriers are included.

- 2.4 GPG agreed that for bulk carriers with hybrid cargo hold arrangements, Z10.2 apply to cargo holds of single side skin (Z10.5.1.1.2).

- 2.5 For close-up surveys of wing ballast tanks of ore carriers, Z10.1 Table 1 (for oil tankers) shall apply (Z10.5.2.3.3).

- 2.6 Rafting requirements in 5.5.5 -5.5.7 are aligned with other UR Z10s.

\*\*\*

#### Correction (2212 IGi, 26 January 2004)

- 2.7 WP/SRC Small Group identified inconsistency between UR Z10.2 and UR Z10.5 and proposed modifications. In Z10.2, the extent of the intermediate survey of ships between 10-15 years is to be equivalent to the previous special survey. Accordingly, the 2<sup>nd</sup> column of Table IV for

intermediate survey requirements also needs to be replaced by “the requirements of the previous special survey”.

- 1) UR Z10.2(Rev.15, Dec 2003) 4.2.3 reads that *for BCs 10-15 years of age, IS shall be the same extent of the previous SS.*
- 2) The current version of Z10.5 for double skin bulk carriers does not have this requirement.
- 3) Also, the draft UR Z10.1 (definition of POOR , draft Rev.12 – 3095\_IGc of 08/08/2003) contains the same requirement for IS of oil tankers 10-15 years.
- 4) Z10.5.2.3.3 clearly defines the extent of overall and close-up surveys at the time of Special Surveys.
- 5) To keep consistency between Z10.2 and Z10.5, paras 4.2.3.1-4.2.3.3 are corrected.

\*\*\*\*\*

**WP/SRC Task 102**  
**HARMONIZATION OF UR Z7s AND Z10s**

**Technical Background**

**UR Z7 (Rev. 11)**

**UR Z7.1 (Rev. 2)**

**UR Z10.1 (Rev. 12)**

**UR Z10.2 (Rev. 17)**

**UR Z10.3 (Rev. 7)**

**UR Z10.4 (Rev. 2)**

**UR Z10.5 (Rev. 1)**

Contents:

TB for Harmonization

**Annex 1.** TB for UR **Z10.1(Rev.12**, C49 amendments(coating-related))

**Appendix 1:** Memo for Coating, submitted to Council  
49(June 2004).

**Appendix 2:** DNV proposal (25 May 2005) agreed by Council

**Annex 2.** TB for "Verification/Signature of TM Forms" for records.

**Annex 3.** TB for revision of UR Zs concerning "anodes".

**1. Objective**

To amend UR Z7s and Z10s in order to make the texts of the above-mentioned URs consistent eliminating all the differences both in substance and in wording (WP/SRC Task 102).

**2. Background**

In the process of approving UR Z10.4, GPG found it necessary to amend the other existing URs Z10.1, Z10.2, Z10.3, Z10.6 and Z7 in order to eliminate any inconsistencies existing among them.

**3. Methodology of work**

The WP has progressed its work through many sessions, both during the periodical meetings and dedicated meetings restricted to a Small Group of Members (BV, DNV, GL, LR, RINA) who developed the work in order to be more efficient. All the proposed amendments of the Small Group have regularly been circulated to all Members for comment and agreement.



## 4. Discussion

4.1 The WP/SRC has completed a comprehensive comparative review of UR Z7 and Z10s, and identified inconsistencies which existed among them. During this review, attention was given to the severity of the requirements applicable to the same spaces/structural areas on different types of ESP ships. As a result, the inconsistencies were eliminated making the URZs harmonized. However, there has been no change to the scope and extent of the survey requirements.

4.2 The starting point for each UR was the most updated version available at the time of commencement. Any revision to the URZs, which were introduced during this task, was taken into account. As for instance, the UR Z10.1 was initially amended based on Rev. 9, while the last amendments are based on Rev. 11 and the UR Z10.2 was initially amended based on Rev. 13, while the last amendments are based on Rev. 16. The proposed revisions of URs Z10.1 and Z10.4 have not been numbered, as there will be revisions to those URs before the revisions introduced by the Task 102 are adopted. In fact, GPG is currently developing a Revision 12 of Z10.1 with the view to introducing significant improvements in the survey regime for ballast tanks (including combined cargo/ballast tanks) of oil tankers and UR Z10s applicable to oil tankers will also have to be revised by incorporating the amendments to A.744(18) contained in Resolution MSC 144(77), which enter into force 1 January 2005 (see 4.3 below).

4.3 Also, in harmonizing UR Z10.1 and Z10.2 care has been taken to align the corresponding text with that of IMO Res. A.744(18). However, it has been noted that the amendments to A.744(18) contained in Resolution MSC 144(77), which enter into force 1 January 2005, have not been incorporated into the IACS UR Z10s applicable to oil tankers. It seems that the updating of the above-said UR Z10s will be done by the Perm Sec and reviewed by the WP/SRC Chairman and then circulated for adoption by GPG with concurrence of Council Members for uniform application from 1 January 2005. It is understood that the revisions of the UR Z10s affected by those amendments will not include the changes introduced by the Task 102, as the implementation date proposed for those changes is 1 January 2006 (see below **6. Implementation**).

4.4 In the course of the work the WP has been developing for more than two years, several additional Tasks were assigned to the WP by GPG which affected the development of Task 102. The additional tasks which have been taken into account are the following:

- 1) In the course of Council discussion on UR Z10.6 (General Cargo Ships), certain inconsistencies were identified between Z10.6 and other Z10s. WP was instructed to expedite Task 102 (1060gIAa, 12 June 2002);
- 2) WP was instructed to include "Survey Planning for Intermediate Survey" into harmonization work (2108\_IAa, 12 July 2002);
- 3) GPG instructed WP to consider whether Z10.6 should be re-assigned as Z7.1, in connection with the harmonization work. 1060gIAb, 20 Sept 2002.

- Z7.1 developed;
- 4) Partial outcome (Z7 and Z7.1) was submitted to GPG on 17 July 2003(1060g). Council decided that approval of Z7(Rev.10) and Z7.1(Rev.2) is postponed until the harmonization is completed (1060gICb, 6 April 2004);  
[Council Chairman instructed WP/SRC to Members' comments on the draft revision of UR Z7 and Z7.1 \(collected under s/n 1060g, 1060gNKi \(30/03/2004\) in particular\) on 6 April 2004.](#)
  - 5) GPG tasked WP to include the amendments to Z10.2 / Z11 (BCs with hybrid cargo hold arrangements), deleting sheets 15 and 16 for ore carriers, into the harmonized UR Z10s (2212aIGa, 19 Jan 2004);
  - 6) GPG tasked WP to consider whether the requirements relevant to examination of Fuel Oil Tanks in the cargo area at each Special Survey should be put into Z10s, and internal examination of FOT at Intermediate Survey after SS 2 is needed. (1060gIAf, 30 Jan 2004);
  - 7) GPG tasked WP to harmonize tank testing requirements in Z7s and Z10s. (3006IIAa, 5 April 2004);
  - 8) GPG tasked WP with Task 108 - Develop uniform survey requirements for air vent pipes including the welded connection to deck. Z22 developed. GPG instructed WP to incorporate Z22 into the harmonized Z10s;
  - 9) GPG tasked WP with Task 114 - Verification and signature of TM reports. REC 77(Rev.1) developed and approved on 29 July 2004. Council approved parallel amendments to Z7.1 and Z10s (TM Forms included) and instructed WP to incorporate these into the harmonized Z10s:
    - [Recommendation No.77 was revised \(Rev.1, July 2004\);](#)
    - [Z7.1 para.6.3.2 and Z10s para.7.3.2 so amended.](#)
    - ["Surveyor's signature" is deleted from all TM Forms in Z10s;](#)
    - [A note is added to Annex II\(Z10s\) declaring that Annex II is recommendatory.](#)

WP/SRC's investigation into Members' practice in dealing with verification and signature of TM reports is annexed for record keeping purpose. [See Annex 2.](#)
  - 10) GPG tasked WP to consider the BV comments on "TM may be dispensed with..." and include the findings into the harmonized Z10s ( 2219iIAa, 7 April 2004).

## **5. Agreement within the WP/SRC**

All Members have unanimously agreed the attached final versions of UR's.

## **6. Implementation**

WP/SRC is of the view that the Members need 12 months from the adoption date to implement these amendments into their class rules. Assuming Council adoption in December 2004, WP/SRC would propose January 2006 as implementation date.

- Annex 1:** TB for UR Z10.1(Rev.12, C49 amendments, see Permsec's note 1 below)  
**Annex 2:** WP/SRC Task 114, verification and signature of TM reports(see 9 above).  
**Annex 3:** TB for revision of UR Zs concerning "anodes".

### **Note by the Permanent Secretariat**

1. Annex 1 to this TB contains background for amendments to UR Z 10.1(Rev.12) relating to FAIR/POOR/GOOD (C49 amendments). Council at its 49<sup>th</sup> meeting (June 2004) agreed/decided that comparable changes should be added to Z10.3 and Z10.4.

2. Appendix 3 "TM sampling method" has been added to UR Z10.1 and Z10.4 to keep them consistent with IMO Res.MSC.144(77). The amendments to A.744 contained in MSC.144(77) entered into force on 1 January 2005. (*GPG s/n 4181*)

Under s/n 4072g, paragraph **2.4.6** of UR Z10.1 and **2.4.6** and of UR Z10.4 (paragraph numbering is now harmonized) were amended in order to provide a link between the main text of the UR Z10.1 and 10.4 and the new Annex III Appendix 3 containing the MSC Res.144(77).

Further, it was agreed that the requirements for evaluation of longitudinal strength of the hull girder (as written in MSC.144(77)) should not be required for Intermediate Survey unless deemed necessary by the attending Surveyor. This is covered in 4.2.3.1 and 4.2.4.1 of Z10.1 and Z10.4.

3. GPG agreed that the amended UR Zs should be implemented from 1 July 2006 altogether.

4. DNV's proposed amendments to UR Z10.1, Z10.3 and Z10.4 concerning annual survey of ballast tanks were agreed by Council (1060gICq, 27 June 2005). See Appendix 2 to Annex 1.

5. Annex 3 contains a TB for revision of UR Zs concerning "anodes".

Date: September 2004  
Prepared by the WP/SRC

-- --

## **Annex 1 to Technical Background**

### **UR Z 10.1 (Rev.12, C49 amendments(coating-related))**

#### **1. Objective**

To introduce significant improvements in the survey regime for ballast tanks (including combined/ballast tanks) of oil tankers as matter of strategic concern and urgency to IACS, given the aging of both the single and double hull tanker fleets and the problems encountered with corrosion of ballast tanks in several shipping casualties.

#### **2. Background**

Draft amendments to UR Z10.1 were submitted to Council 47 (June 2003) and agreed in principle.

#### **3. Discussion**

There was particular concern over accelerated corrosion with age (as the thinner the material, the more rapidly the allowable diminution margin percentage disappears) especially where coatings have broken down. There is also a disincentive for any spend on maintenance of the structure of a ship within a few years of its statutory scrapping date.

Council discussion by correspondence had evolved to the position of substantive proposals – summed as follows (3095\_ABa, 2 June 2003):

1. Enhance the Intermediate Survey in Z10.1, Z10.3 and 10.4 for Tankers after 2<sup>nd</sup> Special / Renewal Survey to the same level (scope of work) as the preceding Special / Renewal Survey). This corresponds to the latest revision to UR Z10.2.
2. At Annual Survey of ballast tanks with substantial corrosion, the overall survey is to be replaced by close-up survey with thickness measurements of the exposed area.
3. Proposed to task WP/SRC to re-consider the acceptance criteria for the rating FAIR further. For this, eliminate FAIR, leaving only GOOD and POOR redefined as appropriate.
4. Proposed to task WP/SRC to explicitly require close-up survey of Suspect Areas identified at the previous Special Survey.

Council 47 discussed the proposals(June 2003) as follows:

##### **1. Definition of FAIR**

Council 47 agreed that “FAIR” would be retained as a rating and that GPG should instruct WP/SRC to redefine FAIR, so that there would be a clear differences between FAIR, POOR and GOOD. It was also agreed that for oil tankers the Intermediate Survey following Special Survey No.2 would have the same scope as Special Survey No.2(Z10.1). WP/SRC should also clarify the definition of satisfactory repair.

Based on the strong majority, Council agreed to discuss with Industry annual surveys of ballast tanks when coating is found in LESS than GOOD condition at special survey, with the objective to encourage the owner to carry out repairs and maintenance of coating to GOOD condition.

*DNV and NK stated that they could not accept a requirement for annual surveys of ballast tanks when the coating condition is less*

*than GOOD and proposed that GOOD be changed to FAIR (3095\_IGc, 30 June 2003)*

2. ABS' proposed amendments to Z10.1(annual examination of BWTs in certain conditions) were approved.
3. C 47 agreed that the BWT coating requirements (Z10.1.2.2.3) for intermediate Survey after SS 2 should be the same extent to the previous SS.
4. Given the substance of the changes, the revised Z10.1 should be shown to Industry before adoption.
5. A guidance for coating repairs needs to be developed by WP/SRC with reference to TSCF Guidelines.

Following Council 47, the draft text of Z10.1(Rev.12) was distributed to Industry and discussed at the IACS/Industry meeting on 29 August 2003. Industry indicated that UR Z10.1(Rev.12) is acceptable, provided that appropriate IACS guidelines on coating repairs are developed.

The Small Group on Coating (SG/Coating) under WP/SRC prepared draft guidelines on coating repairs and considered the definitions of GOOD / FAIR / POOR. The SG/Coating did not change the definitions and found that the Guidelines provide useful clarifications on the definitions and criteria in achieving an industry wide uniform judgement of coating conditions as well as what is needed to restore GOOD conditions.

Further, an IACS/Industry JWG/Corrosion was established and met in February 2004. The outcome is (3095\_IGh, 4 June 2004):

- Draft Guidelines on Coating Repair (IACS REC 87)
- Draft UR Zxx (mandatory coating of cargo tanks on oil tankers)
- Draft UI SC 122 (Rev.2) – mandatory coating of ballast tanks

#### **4. Others**

1. Z10.11.2.2bis - Definition of “Combined Cargo/Ballast Tank. ...as a routine part of the vessel's operation and will be treated as a Ballast Tank. ...”. By so amending, Z10s do not need to repeat “Ballast Tanks and Combined cargo/salt water Ballast Tanks” in addressing the ballast tanks. Hence, all the references to “and Combined cargo/salt water Ballast Tanks” were deleted.
2. Z10.1.2.2.1.2: The aim of the examination is to be sufficient to discover substantial corrosion...  
Comparable changes are to be added to other UR Zs wherever the same sentence occurs.
3. “IACS Guidelines for Coating Maintenance & Repairs for Ballast Tanks and Combined/Ballast tanks on Oil Tankers” are referenced where relevant.
4. Comparable changes are to be added to UR Z10.3 and Z10.4, after adoption of Z10.1(Rev.12).

**Attached: Memo on Coating Matters (GPG Chairman)**

9 June 2004  
Prepared by the Permsec

## **Appendix 1 to Annex 1:**

## **MEMO on Coating matters**

### **1. Background and discussion within IACS on UR Z10.1 (draft Rev.12) between 29/01/03 and 14/08/03**

In view of the survey experience with oil tankers, it was proposed that all ballast tanks should be examined, routinely and uniformly, at annual surveys on ESP tankers exceeding 15 years of age. IACS should amend UR Z10.1 to require the examination of ballast tanks on such ships at each annual survey. This is simple, clear and thorough and not subject to interpretation. (2242\_ABq dated 29/1/03)

Then, ABS modified the proposal asking, for tankers subject to URs Z10.1, Z10.3 and Z10.4, exceeding 15 years of age, that the current requirement - pertaining to annual examination of Ballast Tanks adjacent to cargo tanks with any means of heating - be deleted and replaced by a simpler and more stringent requirement that all Ballast Tanks be subject to survey at each subsequent annual survey where either substantial corrosion is found within the tank or the protective coating is found to be in less than GOOD condition and the protective coating is not renewed at special survey or intermediate survey. This will ensure that all Ballast Tanks with substantial corrosion or protective coating which is not in GOOD condition at the time of special survey or intermediate survey will be examined at each subsequent annual survey on tankers exceeding 15 years of age. (2242\_ABzb dated 14/3/03)

This was later expanded to include all tanks used routinely for ballast water, both ballast-only and cargo/ballast tanks (2242\_ABzc dated 14/3/03).

ABS further reviewed the issue of the survey of salt water ballast spaces and combined cargo/salt water ballast spaces with ABS' governing bodies in light of recent casualties and survey findings on other tankers. Their review found an increasing amount of coating breakdown/failure and subsequent rapid wastage in key structures after Special Survey No. 2, i.e. after 10 years of age. These conditions are most prevalent in the under deck structure and the side shell structure in way of the deep loadline. In a number of cases the serious wastage has caused fracturing of the under deck longitudinals and in some cases fracturing has extended to the main deck structure. This led ABS to refine proposed amendments to URs Z10.1, Z10.3 and Z10.4 to require (2242\_ABzf dated 9/5/03):

#### a. For Tankers exceeding 10 years of age

Salt Water Ballast Spaces and Combined Cargo/Salt Water Ballast Spaces. For tankers exceeding 10 years of age, salt water ballast spaces and combined cargo/salt water ballast spaces are to be internally examined at each subsequent Annual Survey where substantial corrosion is found within the tank or where the protective coating is found to be less than GOOD condition and protective coating is not repaired. Internal examination to be an Overall Survey.

#### b. For Tankers exceeding 15 years of age:

Salt Water Ballast Spaces and Combined Cargo/Ballast Spaces. For tankers exceeding 15 years of age, salt water ballast spaces and combined cargo/ballast spaces are to be examined internally at each subsequent Annual Survey. Where substantial corrosion is found within the tank, or where the protective coating is found to be in less than GOOD condition and the protective coating is not repaired then in addition to an Overall Survey, under deck structure and the side shell structure in way of the deep loadline is to be subject to Close-up Survey.

NK and BV replied that the proposed amendments made by ABS need to be substantiated in a transparent manner with technical data that ABS may possess and put forward for further assessment and discussion. (2242\_NK<sub>n</sub> dated 14/5/03 and 2242\_BV<sub>z</sub> dated 16/5/03)

**DNV** (2242\_NV<sub>n</sub> dated 2/6/03), having carefully considered the practical consequences of taking the ship off-hire for gas freeing etc. and being concerned about the difficulties to have these surveys executed in a safe manner and whether the intended safety benefits in implementing the proposed extended scope of the annual survey of Ballast tanks will be met, **proposed the following alternative measures** which would be as effective and may not have such delaying effects to the ship:

- 1) Enhance the Intermediate Survey in UR Z10.1, 10.3, and 10.4 for Tankers after the 2 Special / Renewal Survey to the same level (scope of work) as the preceding Special / Renewal Survey. (This will correspond to the latest revised requirements of UR Z10.2 for Bulk Carriers.)
- 2) At Annual Survey of ballast tanks with substantial corrosion the overall survey should be replaced by close up survey with thickness measurements of the exposed area. (An overall survey of these tanks does not give sufficient information of the development of the areas with substantial corrosion.)
- 3) Further we will not fail to mention that the WP/SRC has proposed to extend the close up survey in cargo and combination tanks to 30% from the 3 Special / Renewal Surveys.
- 4) **Experience has shown that the coating condition rating category FAIR has a tendency to be stretched too far into the POOR condition. We will therefore propose that we task the WP/SRC to reconsider the acceptance criteria for the rating FAIR further.**
- 5) We do also question the need for redefining the definition of combination tanks, particularly since the category I tankers which are the ships that normally are fitted with these type of tanks are to be phased out 2 to 4 years from now. However DNV will not oppose to such a redefinition.

**DNV requested Members to consider the above as an alternative to the ABS proposal, bearing in mind that we ought to present this to the industry prior to deciding.**

ABS (3095\_Aba dated 2/6/03), having further considered its earlier proposals in light of NV<sub>n</sub>, submitted a revised proposal for consideration by Council at C47 and replied to the above 5 DNV proposals as follows:

- 1) ABS fully supports this proposal.
- 2) While ABS agrees with this proposal, it is in fact already provided for in Z7 (3.2.3) and Z10.1 (3.2.5.1)--which require that "Suspect areas (which include any area where substantial corrosion is found) identified at previous Special Survey are to be examined. Areas of substantial corrosion identified at previous special or intermediate survey are to have thickness measurements taken." To us, this implies that close-up survey of these areas is to be done at annual survey in conjunction with the thickness measurements. However, we can

agree to tasking WP/SRC to explicitly require "close-up" survey in this connection and to amend Z7, and all the Z10's, appropriately to make this explicit, if there is majority support for this.

3) We agree that this has been put forward to GPG by WP/SRC via 0237hNVb, 27 May. However, these additional CAS close-up survey requirements do not apply to salt water ballast tanks; only to cargo oil tanks and combined cargo/ballast tanks.

4) **We agree with this assessment and we propose that the only way to eliminate the subjectivity and raise the standard is to eliminate the category "FAIR" completely; leaving only "GOOD" and "POOR" redefined as follows:**

**"GOOD -- condition with no breakdown or rusting or only minor spot rusting.**

**POOR -- any condition which is not GOOD condition."**

5) ABS does not agree with this proposal. We are particularly concerned that we need a very thorough and robust survey regime for these tankers precisely because they are subject to mandatory phase out over the next several years. We are very concerned that without additional IACS requirements, these tanks will receive little or no inspection and maintenance by owners or others after their last special or intermediate survey, if no substantial corrosion is found at that time. Rapid, localized wastage in way of deteriorating coatings may pose significant hazard if the survey regime is not further tightened as we are proposing.

In conjunction with the above comments on DNV proposals, ABS further considered their previous proposal in ABzf and modified it as follows:

- **ABS simplified the proposal to require annual examination of all salt water Ballast Tanks and combined Cargo/salt water Ballast Tanks irrespective of age, when either substantial corrosion is found within the tank or the protective coating is found to be in less than GOOD condition and is not repaired.**
- the requirement for annual (close-up) examination of salt water ballast tanks and combined tanks is already required in Z10.1 (3.2.5.1). ABS proposed adding it to 2.2.3 for clarity and emphasis so that all the conditions which may lead to annual examination of such tanks are listed together in one place.
- Since the principal problem that we are trying to address is rapid, localized corrosion in way of breakdown or deterioration of the protective coating, we are proposing that the coating condition should be found and kept in "GOOD" condition to obviate the need for annual examination. **The attached proposal is made together with the proposals in items 3.1 (intermediate following Special survey 2 to have same scope as prior Special survey) and 3.4 (eliminating "FAIR" and redefining "POOR" as any condition other than "GOOD" condition.**

ABS requested to decide on a course of action at C47 for tightening the survey regime for tankers. They agreed that industry be informed of Council's decisions in this regard prior to IACS making the decision public, but IACS should maintain its independence and take decisive action in this matter. Debate with industry can only lead to delay and to a watering down and compromising of these important requirements.

NK agreed to task WP/SRC to reconsider the acceptance criteria of "FAIR" for clearly define the border between "FAIR" and "POOR" condition. However, **NK strongly opposed the elimination of "FAIR" coating condition from UR Zs** because this can not resolve to remove subjectivity of coating assessment. The three-categorization system of coating condition should be retained. (3095\_NKa dated 5/5/03)



## **Outcome of C47**

At C47, it was agreed that "Fair" would be retained as a rating and that GPG should instruct WP/SRC to redefine "Fair", so that there would be a clear differentiation between "Fair", "Poor" and "Good". It was also agreed that for oil tankers the Intermediate Survey following Special Survey No.2 would have same scope as Special Survey No.2 (Z10.1). WP/SRC should also clarify the definition of satisfactory repair.

Based on strong majority support Council agreed to discuss with Industry annual surveys of ballast tanks when coating is found in LESS than GOOD condition at special survey, with the objective to encourage the owner to carry out repairs and maintenance of coating to GOOD condition.

This matter should be discussed with Industry prior to adoption of any UR by Council.

In a final summary, the Chairman proposed that a constructive dialogue with Industry should take place on the IACS proposal as set out in WP1 plus maintaining 3.2.5.2 modified to say that ballast/combined ballast/cargo tanks will be subject to annual survey when considered necessary by surveyors.

After discussion in the JWG (Industry/IACS), GPG should propose final rules for this matter to Council, including acceptable repair definition.

**FUA 17:** *To instruct WP/SRC to develop guidance on coating repairs and more precise definition of "Fair" coating condition.*

Once approved, these requirements should be incorporated into Z10.3 and Z10.4.

### **FUA 15**

1) *To prepare a draft revision to UR Z10.1 incorporating C 47 decisions:*

- *The definition of "FAIR" remains as it is;*
- *ABS proposed amendments to Z10.1 (annual examination of BWTs in certain conditions) were approved;*
- *C47 agreed that the BWT coating requirements (Z10.1.2.2.3) for Intermediate Survey after Special Survey No.2 should be the same extent to the previous Special Survey.*
- *Given the substance of the changes, the revised UR Z10.1 should be shown to Industry (OCIMG/Intertanko first among others) before adoption for their review and comments.*
- *A guidance for coating repairs needs to be developed by WP/SRC with reference to TSCF Guidelines.*

2) *GPG Members are to confirm the draft revision to Z10.1 in consultation with their WP/SRC members by correspondence. See 3095\_IGa of 13/06/03.*

According to C47 FUA 15, GPG Chairman circulated (3095\_IGa dated 13/6/03) draft amendments to UR Z10.1 as agreed in principle at C47.

Having received a number on comments, GPG Chairman (3095\_IGb dated 27/6/03) informed that the Council Chairman confirmed that GPG is not to amend the principles agreed at C47, i.e. we are not empowered to change "GOOD" to "FAIR" as proposed by DNV and NK, nor to amend the definitions of "FAIR" and "POOR" as proposed by DNV.

DNV's intention to possibly lodge a reservation was noted, however the matter should be raised at Council and not be dealt with by GPG. An amended draft text incorporating the non-substantive changes proposed by Members was circulated.

DNV said that its understanding was that the draft should be circulated to the Industry (ICS, INTERTANKO, and BIMCO) prior to adoption by Council. (3095\_NVc dated 30/6/03)

GPG Chairman (3095\_IGc dated 30/6/03) circulated a draft amendment of UR Z10.1 for Council's agreement and use in discussions with the industry associations.

The draft was generally agreed by GPG but individual Members have requested that the following matters (which were deemed to be outside the remit of GPG in this task) be brought to Council's attention for further consideration:

- 1 DNV and NK stated that they can not accept a requirement for annual surveys of ballast tanks when the coating condition is less than GOOD and propose that GOOD be changed to FAIR.
- 2 In connection with item 1 above, DNV also propose to amend the definitions of FAIR and POOR in order to raise the standard of FAIR.

Council Chairman (3095\_ICb dated 14/8/03) concluded that Council has agreed that the draft amendments to UR Z10.1 attached to IGc reflect Councils' decision taken at C47 and that they be circulated to industry associations.

Perm Sec was therefore invited to submit the draft to OCIMF and INTERTANKO in view of discussion at the IACS/ industry meeting on 29 August.

## **2. Discussion with Industry (29/08/2003 – 11/10/2003)**

As requested by Council, the whole matter was presented to Industry during the “general matters” meeting with IACS held on 29 August 2003; comments from Industry were requested. In the following an extract from the minutes of the meeting (see message 3100aIAb dated 5 September 2003):

\_\_\_\_\_ from Meeting minutes \_\_\_\_\_

## **4. & 5. Annual surveys of ballast tanks and IACS guidelines on coating repairs**

M. Dogliani introduced the matter ([see Items 4&5 in Appendix](#)).

A. LinoCosta gave a presentation to show where concerns and decisions stand: too many cases when coating was considered fair at SS but problems occurred just after one/two years.

N. Mikelis commented on draft amendments to Z10.1 (Rev.11) stating that the extent of annual survey is not clear; it should be limited to the affected zones, e.g. coating breakdowns, only.

M. Guyader clarified that, in this draft amendments, it is expected an overall survey of the whole tank and a close up survey of the affected zones.

N. Mikelis noted that, in the draft amendments to Z10.1 (Rev.11), the intermediate survey at 12.5 years would have the same scope as the previous special survey and that needed a justification. See 7 a).

M. Dogliani said that Z10.1 (Rev.11) was adopted in August 2003 and will be introduced into IACS Societies' Rules over the next year.

### Conclusions:

4.1 Industry shared IACS concerns on coatings and, in general, agreed with the draft amendments to Z10.1 (Rev.11) suggesting also extending them to Z10.2 on bulk carriers

4.2 Industry agreed that a guideline for surveyor on coating would greatly improve uniform application of so-amended Z10.1 including issues such as how to consider load bearing elements when judging GOOD/FAIR/POOR status and how to consider bottom pitting in connection with GOOD conditions

4.3 Industry will more precisely comment, by the end of September, the draft Z10.1 so as for IACS to finalise the matter, as planned, for the Council's December meeting.

Item	Title	Industry recommendation	IACS/ M. Dogliani Introduction
4 & 5	Annual survey of ballast tanks IACS guidelines on coating repairs	NN	<p><b>1. IACS is considering the following:</b></p> <ul style="list-style-type: none"> <li>- <b>amend UR Z10.1 (draft circulated to Industry) to the effect that in case at Special Survey or Intermediate Survey the coating in a ballast tank is found less than GOOD, either GOOD conditions are restored or the tank's coating is inspected at each annual survey;</b></li> <li>- <b>develop IACS guideline to assist an uniform application of the so modified (if adopted) UR Z10.1; the guideline should address which repairs are necessary to restore GOOD conditions from FAIR and POOR respectively and which are the criteria for the restored (after repair) situation to be rated as GOOD.</b></li> </ul>

\_\_\_\_\_ End of extract from minutes \_\_\_\_\_

INTERTANKO commented (see R. Leslie email to GPG dated 25 September 2003):

- expressing their concern for the draft Z10.1 and underlining
  - a) targeting: concerns that, if not properly dealt with, Z10.1 would target all ships and not just those which need intervention; the view was expressed that guidelines would probably solve the matter;
  - b) definition: indicating that the current definitions of GOOD, FAIR and POOR is not clear enough and that the matter would be even worst with GOOD and NON GOOD; again it was indicated that guidelines could solve the matter;
  - c) expertise: expressing doubts on IACS' surveyors expertise and ability to judge coating conditions; in this respect they (hiddenly) suggest that IACS position is unclear when we say that we are not competent to judge the coating during construction but then we are competent to judge coating during operational life. Even if not explicitly stated, the impression is that also in this case guidelines would help.

Additionally, INTERTANKO suggested a (quite detailed) set of assessment criteria.

The matter was then finally addressed at the TRIPARTITE Meeting (held in Soul on 29/30 September 2003). There Industry agreed that the way forward was the (joint) development of IACS guidelines (see minutes attached to message 3100\_RIe dated 11 October 2003, an extract of which is reproduced below).

\_\_\_\_\_ Extract from the TRIPARTITE minutes \_\_\_\_\_

Industry is concerned by the definition of GOOD/NOT GOOD in relation to coating repairs and acceptance criteria. Industry agreed that new guideline on this, which IACS is already producing, was the way forward.

\_\_\_\_\_ End of the extract from the minutes \_\_\_\_\_

### **3. Further developments**

- a) from the above, it was concluded that, provided the guidelines are sound, Industry would accept the concept of Z10.1 (draft) Rev. 12, therefore an IACS team and a JWG were established in order to progress the matter of the guidelines (among other related matters).
- b) the team of IACS experts on coating developed draft guidelines and provided recommendations to GPG on the way forward (attached to message 3095bNVc dated 20 November 2003).
- c) the guidelines were discussed within the JWG with Industry (see draft minutes circulated within GPG with messages 3095cIGd and 3095cIGe both dated 13 March 2004)
- d) further suggestions and comments (as requested at the meeting) were provided by Industry (not circulated to GPG)
- e) Bulk Carrier Industry is recommending that similar guidelines are developed in due time also for bulk carriers
- f) at DE47 and MSC78, IMO is asking Industry and IACS to develop (compulsory) performance standards for coating of newbuilding (double hull spaces of DSS Bulk Carriers), a matter which is, indirectly related to the above one.

1 June 2004

M. Dogliani

IACS GPG Chairman

IACS JWG/COR Chairman

Appendix 2 to Annex 1: [DNV proposal to Z10.1, Z10.3 and z10.4](#) ▶

Sent Monday, July 4, 2005 4:45 pm

To [Gil-Yong <gilyonghan@iacs.org.uk>](mailto:Gil-Yong <gilyonghan@iacs.org.uk>)

Cc

Bcc

Subject Fw: 1060gNVs; WP/SRC - Task 102 - Harmonization of UR Z 7 and Z 7.1

Attachments [Doc1.doc](#)

25K

----- Original Message -----

From: "Debbie Fihosy" <[debbiefihosy@iacs.org.uk](mailto:debbiefihosy@iacs.org.uk)>

To: "CCS" <[iacs@ccs.org.cn](mailto:iacs@ccs.org.cn)>

Cc: "IACS Permanent Secretariat" <[permsec@iacs.org.uk](mailto:permsec@iacs.org.uk)>

Sent: Friday, June 03, 2005 2:52 PM

Subject: FW: 1060gNVs; WP/SRC - Task 102 - Harmonization of UR Z 7 and Z 7.1

Forwarding as requested

-----Original Message-----

From: Arve.Myklebust@dnv.com [[Arve.Myklebust@dnv.com](mailto:Arve.Myklebust@dnv.com)]

Sent: 25 May 2005 15:49

To: [AIACS@eagle.org](mailto:AIACS@eagle.org); [iacs@bureauveritas.com](mailto:iacs@bureauveritas.com); [iacs@ccs.org.cn](mailto:iacs@ccs.org.cn);

[johnderose@iacs.org.uk](mailto:johnderose@iacs.org.uk); [iacs@dnv.com](mailto:iacs@dnv.com); [iacs@gl-group.com](mailto:iacs@gl-group.com);

[gilyonghan@iacs.org.uk](mailto:gilyonghan@iacs.org.uk); [helenbutcher@iacs.org.uk](mailto:helenbutcher@iacs.org.uk); [efs@iacs.org.uk](mailto:efs@iacs.org.uk);

[krsiacs@krs.co.kr](mailto:krsiacs@krs.co.kr); [richardleslie@iacs.org.uk](mailto:richardleslie@iacs.org.uk); [external-rep@lr.org](mailto:external-rep@lr.org);

[clnkiacs@classnk.or.jp](mailto:clnkiacs@classnk.or.jp); [terryperkins@iacs.org.uk](mailto:terryperkins@iacs.org.uk); [iacs@rina.org](mailto:iacs@rina.org);

[iacs@rs-head.spb.ru](mailto:iacs@rs-head.spb.ru); [colinwright@iacs.org.uk](mailto:colinwright@iacs.org.uk)

Subject: FW: 1060gNVs; WP/SRC - Task 102 - Harmonization of UR Z 7 and Z 7.1

25 May 2005

To: Mr. B. Anne, Chairman of IACS Council,

cc: Council Members, IACS Perm. Sec.

Ref.: My mail NVr dated 20 May 2005

DNV have further studied the amendments to UR Z10.1, Z10.3, and Z10.4, and as a result are presenting the following as a compromise solution:

General comment:

From the comments by other Members it is obvious that there is reluctance to accept annual surveys of ballast tanks with a common plane boundary to heated cargo tanks in the case where the coating is in good condition. This is particularly unreasonable as at the same time we enhance the Intermediate survey of Tankers between 10 and 15 years to also include examination of all ballast tanks, meaning that all ballast tanks will be close up surveyed with 2-3 years intervals from the ship is 10 years old, with the possibility for the surveyor to require thickness measurements and testing of the tanks to ensure the structural integrity of the tanks if necessary.

It is also proposed for the Intermediate survey between 5 and 10 years, to increase the scope from representative to all ballast tanks, a requirement DNV find to strict, and require that we here keep the original text.

If a ballast tank is found to have coating in GOOD condition at the renewal or intermediate survey, a deterioration of the tank beyond structural reliability is very unlikely even if the tank has a common plane boundary to a heated cargo tank.

DNV finds it particularly unreasonable to have this requirement to apply to double hull tankers for the following reasons:

- these ships have double hull and the risk of pollution is here much reduced,
- the double hull is constructed with small spaces giving improved structural reliability,
- almost all double hull tankers below VLLC have heated cargo tanks, and all ballast tanks have common plane boundaries to these tanks, meaning that this requirement will apply to a major part of the tanker fleet in the future,
- the ballast tanks of double hull tankers are so designed that a general examination of these tanks will be identical to a close up survey,
- survey of ballast tanks of double hull tankers will mean either gas freeing of all cargo tanks or at least dropping the inert gas pressure of all cargo tanks in addition to proper airing of all ballast tanks.

Since the single hull tankers will be faced out in the near future, and for clear political reasons, DNV will as a compromise proposal to keep paragraph 2.2.3.1 and 4.2.2.2 in Z 10.1 as amended by Council (ref. IAo) but amend it to not include 2.2.3.1.e, 4.2.2.2.e and last paragraph of 3.2.5.1 in Z10.3 and Z10.4. In addition we request that the original text of 4.2.2.1 is kept.

If BV, ABS and other Members can accept this DNV is willing to drop our reservation presented at C49.

DNV's proposal will then be as follows:

Z10.1:

2.2.3.1: This paragraph can be accepted as is for the reasons stated above.

3.2.5.1: This paragraph is accepted as amended.

4.2.2.2: This paragraph can be accepted as is for reasons stated above.

For other comments to Z10.1 see NVo and NVp.

Z10.3:

2.2.3.1.e to be deleted.

3.2.5.1 delete last paragraph

4.2.2.1 the original text to be kept. "For tanks used for water ballast ---"

4.2.2.2.e to be deleted

Z10.4

2.2.3.1e to be deleted

3.2.5.1 delete last paragraph

4.2.2.1 the original text to be kept, "For tanks used for water ballast --"

4.2.2.2.e to be deleted.

For details see attached document where the text for the requirements in Z10.3 and Z10.4 that DNV will accept is stated.

Best Regards

Arve Myklebust  
on behalf of  
Terje Staalstrom  
DNV IACS Council Member  
<<Doc1.doc>>

\*\*\*\*\*

Neither the confidentiality nor the integrity of this message can be vouched

Annex 2 to TB (Harmonization Z10s)

**WP/SRC Task 114 “Clarify the procedure of verification and signature of the thickness measurement report”**

Item No.	Item	ABS	BV <sup>1)</sup>	CCS	CRS	DNV	GL	IRS	KR	LR	NK	RINA	RS
<b>1</b>	<b>Verification onboard</b>												
1.1	Minimum extent of measuring points for direct verification by attending surveyor specified	No	No	No	No	No	No	No	Yes	No	No	Yes	No
1.2	Preliminary TM record to be signed upon completion of the measurements onboard	Yes	Yes <sup>7)</sup>	Yes	No (copy taken)	No <sup>3)</sup>	No <sup>6)</sup>	Yes	Yes	Yes	Yes	No <sup>8)</sup>	No
<b>2</b>	<b>Final TM report</b>												
2.1	Signature of all pages in TM record required	No	No	No	Yes	No	Yes	Yes	No	No	No <sup>5)</sup>	Yes	Yes
2.2	Signature of ‘cover’ (‘general particulars’) page only	Yes	Yes	Yes	No	Yes	No	No	No <sup>4)</sup>	Yes	Yes	Yes	No
2.3	Measuring points verified by attending surveyor required identified in TM record and signature of the corresponding pages required	No	No	Yes Without signature	Yes	No	No	No	Yes	No	No	No	No

2004-04-20

<sup>1)</sup> Instructions not clear regarding signature of the thickness measurement record

<sup>2)</sup> Signature on front and last page, stamp on all other pages, or signature on each page (IACS TM forms)

<sup>3)</sup> Upon completion of measurements onboard a draft report in electronic format (DNV TM template, including operator’s notes as relevant) to be given to attending surveyor

<sup>4)</sup> Signature of cover page, pages of meeting record and pages of attended measuring points

<sup>5)</sup> Each page to be signed in case of ‘loose-leaf’ type record

<sup>6)</sup> Preliminary TM record has to be passed to the Surveyor, signed by the Operator

<sup>7)</sup> The only measures which the Surveyors can certify exact are those for which that they have seen the results on the screen of the apparatus. That means in fact few points in comparison with the numbers of recorded measures.

<sup>8)</sup> The Surveyor reviews the TM record for completeness and assessment of TM readings, but no signature required.

UR Z7s and Z10s (Corrosion Prevention System)

1. Objective:

To clarify whether the survey of anodes is a class matter, and if so, whether acceptance criteria for anode should be developed.

2. Method: GPG by correspondence (5037\_)

3. Discussion

3.1 BV initiated GPG discussion as follows:

Paris La Défense, 8 Mars 05

1 - We have noticed that, in the draft UR Z's ( 7.1, 10.1 to 10.5) issued further to the WP/SRC Task 102, the original sentence ".....the examination may be limited to a verification that the hard protective coating remains efficient....." has been replaced by ....that the corrosion prevention system remains efficient....". in a number of paragraphs (such as , for instance, Z 7.1, 4.2.3.1 a) ; Z 10.2 4.2.3.3 ; ), in line with IMO Res.A744(18).

2 - However, a corrosion prevention system is defined, in the same UR Z's and in IMO Res.A744(18) , as being either a full hard protective coating or a full hard protective coating supplemented by anodes.

3 - The above would mean that the survey of the anodes is a classification matter.

4 - However, whereas coating conditions are defined as good or fair or poor, there are no criteria in the IACS URs and IMO Res. A744(18) for the anodes condition.

5 - Assessing the anodes condition to confirm that they "remain efficient" looks to BV to be a quite difficult task for the ships in service Surveyor.

6 - Member's view and interpretations on the following would consequently be appreciated:

- do Members consider that the above requirements in IACS URs imply that survey of anodes is part of the classification ?
- do Members consider that the above requirements in IMO Res. A 744 (18) imply that survey of anodes is mandatory?
- if yes, what is the acceptance criteria to conclude that the anodes" remain efficient" ?

3.2 The majority of GPG Members replied that they did not include requirements for anodes in their class rules.

LR / ABS / DNV / KR / NK / RINA / RS were of the view that the condition of any anodes fitted should be recorded for information purposes as the survey of anodes is neither a classification matter nor a mandatory requirement in IMO A.744(18) and has no impact on future surveys (5037\_LRa). [Note; LR further clarified that "Whilst I agree that the performance of anodes is not normally a class matter LR does require that as part of Special Survey on oil tankers : "The attachment to the structure and condition of anodes in tanks are to be examined ." Therefore we cannot say that 'the survey of anodes is not a classification matter'. 5037\_LRb]



However, GL said that “for GL, anodes are a matter of class and as such are subject to plan approval as well as surveys. In case of missing or worn-out anodes we issue a condition of class”(5037\_GLa&b).

CCS advised that its rules have a general requirement relating to anode survey, which is only conducted, through sampling, during construction, docking survey or where there is a definite requirement for the survey of ballast tanks.

NK proposed that the following footnote be added to Z7s and Z10s:  
“The survey of anodes is not a classification matter.” No majority support was achieved.

#### **4. Conclusion**

RINA suggested to simply amend the definition of "Corrosion Prevention System" in paragraph 1.2.9 of UR Z7 (and, of course, the paragraphs in all the other UR Zs containing the definition of "Corrosion Prevention System") in order to eliminate any reference to anodes. This proposal would leave room for Societies willing to include additional class requirements for anodes to do so in their Rules.

GPG agreed.

### **RINA proposed amendments to paragraph 1.2.9 of UR Z7 and corresponding paragraphs in all other UR Zs (5037\_RIb, 6 April 2005)**

#### 1.2.9 Corrosion Prevention System

A corrosion prevention system is normally considered ~~either: a full hard protective coating, or~~  
~~1 a full hard protective coating, or~~  
~~2 a full hard protective coating supplemented by anodes.~~

Hard protective coating is usually to be epoxy coating or equivalent. Other coating systems may be considered acceptable as alternatives provided that they are applied and maintained in compliance with the manufacturer's specifications.

Where soft coatings have been applied, safe access is to be provided for the surveyor to verify the effectiveness of the coating and to carry out an assessment of the conditions of internal structures which may include spot removal of the coating. When safe access cannot be provided, the soft coating is to be removed.

[Annex: Council Chair's conclusive message.](#)

6 May 2005  
Permsec

## **Annex. (5037\_ICb, 15 May 2005)**

To : All IACS Council Members  
c.c : Mr. R. Leslie, IACS Permanent Secretariat

Ref. Mr G-Y. Han's message IAa dated 6 May 05  
Message ICa dated 6 May 05  
Admiral R.E. Kramek's message ABb dated 13 May 05

Paris La Défense, 15 May 05

- 1 - All Members have agreed with the texts attached to Mr Han's message.
- 2 - Further to ABS comments the reference to anodes is to be deleted in Annex I and in tables IX (IV) and IX(II).
- 3 - further to ABS questions regarding what IACS plan to do regarding IMO and A.744(18) further to IACS deletion of reference to anodes from the UR Z7's and UR Z10's it is to be noted that:

The Item 1.2.9 in UR Z10.1 and relative items in these URs states  
*1.2.9 10 Corrosion Prevention System: A corrosion prevention system is normally considered either:*

- .1 a full hard protective coating, or*
- .2 a full hard protective coating supplemented by anodes.*

*Hard Pprotective Ccoating is to usually to be epoxy coating or equivalent. Other coating systems may be considered acceptable as alternatives provided that they are applied and maintained in compliance with the manufacturer's specification.*

*Where Soft Coatings have been applied, safe access is to be provided for the surveyor to verify the effectiveness of the coating and to carry out an assessment of the conditions of internal structures which may include spot removal of the coating. When safe access cannot be provided, the soft coating is to be removed.*

- therefore the anodes are not considered as the main means of protection against the corrosion It is only a supplement;
- there is no provision in UR Z7's and Z10's to evaluate the level efficiency of the anodes;
- there is no specific requirements in case of lack of efficiency of the anodes.

The experience has shown that ballast tanks only protected by anodes are subject to corrosion when the anodes are becoming less efficient.

The anodes are active only when immersed by sea water. Therefore the upper part of the ballast tanks are not protected when the ballast is full of water and the ballast is not protected when it is empty..

The ships operators are reluctant to replace the anodes especially in upper part which request fitting of scaffolding fo welding the anode supports to the structure.

[The above arguments justify the reasons why IACS consider that the anodes are not class item.](#)

[4 - These arguments can be used by IACS Members](#) attending the WG bulk carriers at MSC 80 to try to obtain deletion of the reference to anodes in A. 744(18).

Best regards,

Bernard Anne  
IACS Council Chairman.

## **Technical Background**

**UR Z10.1(Rev.13, Jan 2006)**

**UR Z10.2(Rev.18, Jan 2006)-separate TB**

**UR Z10.3(Rev.8, Jan 2006)**

**UR Z10.4(Rev.3, Jan 2006)**

**UR Z10.5(Rev.2, Jan 2006)**

**Part 1. Z10s – para. 1.4 and 7.1.3**

**Part 2. Z10s – para. 5.5.4 and 5.5.6**

**Survey Panel Task 22 – Amend applicable URZ7s and Z10s to align Close-Up Survey and Thickness measurements to be carried out at the same time and location allowing for a more structured control of the thickness measurement process.**

**Technical Background**

**Z7(Rev.12)**

**Z7.1(Rev.3)**

**Z10.1(Rev.13, para.1.4 & 7.1.3)**

**Z10.2(Rev.18, para. 1.4 & 7.1.3)**

**Z10.3(Rev.8, para. 1.4 & 7.1.3)**

**Z10.4(Rev.3, para. 1.4 & 7.1.3)**

**Z10.5(Rev.2, para. 1.4 & 7.1.3)**

**1. Objective**

To amend the applicable URZ7s and Z10s to align Close-Up Survey and Thickness measurements to be carried out at the same time and location allowing for a more structured control of the thickness measurement process.

**2. Background**

IACS QC findings, through audits of numerous Societies, which indicated concerns over Surveyor attendance and control of thickness measurement processes.

**3. Methodology of Work**

Survey Panel members through correspondence.

**4. Discussion**

To align Close-up survey requirements and thickness measurements in the applicable URZ7s and URZ10s, in accordance with PR19, all Panel members agreed through correspondence and a final vote at the fall Survey Panel meeting, that URZ7, Z7.1, Z10.1, Z10.2, Z10.3, Z10.4 and Z10.5 should include in the applicable sections of the noted URs as proposed by the Survey Panel the wording “ In any kind of survey, i.e. special, intermediate, annual, or other surveys having the scope of the foregoing ones, thickness measurements of structures in areas where close-up surveys are required, shall be carried out simultaneously with close-ups surveys.”

**5. Implementation**

The Survey Panel is of the view that the Members need 12 months from the adoption date to implement these amendments into their class rules. Assuming that GPG and Council approve to the amendments, the Survey Panel would propose January 2007 as an implementation date.

## **Technical Background**

**UI SC 191 (Rev.2, Oct 2005)**

**&**

**UR Z10.1 (Rev.13, para.5.5.4 and 5.5.6, Jan 2006)**

**UR Z10.2 (Rev.18, para. 5.5.4 and 5.5.6, Jan 2006)**

**UR Z10.3 (Rev.8, para.5.5.4 and 5.5.6, Jan 2006)**

**UR Z10.4 (Rev.3, para.5.5.4 and 5.5.6, Jan 2006)**

**UR Z10.5 (Rev.2, para.5.5.4 and 5.5.6, Jan 2006)**

### **1. Objective**

- to confirm whether the guidelines for approval/acceptance of alternative means of access (now REC91, ex Annex to UI SC191) is mandatory or non-mandatory.
- to consider other safety related proposals.

### **2. Background**

The DNV proposal to submit the UI SC191(Rev.1, May 2005, Annex 1) to IMO DE49 triggered a number of discussion points that led to amendments to the following resolutions:

UI SC191(Rev.2)  
New REC 91  
REC 39(Rev.2)  
UR Z10s

### **Points of Discussion**

3. Is the Annex to UI SC191(Rev.1, May '05, guidelines for approval / acceptance of alternative means of access) mandatory or non-mandatory ?

Answer: Non-mandatory. Hence, re-categorized as new REC 91.

4. Limitation of use of rafts in bulk carrier holds

DNV proposed that conditions for rafting should be limited to areas, such as anchorage or harbour, where swell conditions are limited to 0.5m. After discussion, GPG approved the ABS' alternative proposal to use the swell condition as a basis to determine the appropriateness of rafting, instead of geographic areas(harbours or anchorage). 5.5.4 of Z10.2 refers.

RINA proposed that para 5.5.4 should be included in all the Z10s. NK's objection is recorded as follows (3037hNKq, 29/08/2005):

1. With regard to RIm of 26 August 2005, NK considers that the proposed amendment to 5.5.4 should be limited to UR Z10.2.
2. Rafting survey for tankers are actually carried out on the open sea from a discharge port to a loading port and in such situation the rise of water within the tanks would always exceed 0.25m. It is different situation from rafting survey for hold frames of bulk carriers normally conducted in a harbour or at an anchorage.
3. If the same requirement applies to tankers, any rafting survey for cargo oil tanks and ballast tanks of tankers would be prohibited. This is not practicable under present survey procedure for tankers.
4. Therefore, NK can not support Laura's proposal that the proposed amendment to 5.5.4 of UR Z10.2 is introduced into the other URs and new Recommendation.

For compatibility with the IMO's mandatory requirements\*, GPG decided to add the same amendment to all the UR Z10s.

\*

- Appendix 4 to MEPC.99(48) 'Mandatory requirements for the Safe Conduct of CAS Surveys'
- MSC.197(80) – amendments to A.744918), Annex A for DSS and SSS bulk carriers and Annex B for single and double hull oil tankers.

As a consequence, 5.5.1 of REC 91(ex Annex to UI SC191) was also amended:

- to remove the reference to dynamic /sloshing (as the 0.25m rise was considered negligible);
- to refer to the rafting conditions contained for cargo holds in Z10.2 and Z10.5 and for oil cargo tanks in Z10.1 and Z10.4.

5. Means of access from longitudinal permanent means of access within each bay to rafts

GPG reviewed the proposal that the following text be added to Z10s:

[A means of access to the longitudinal permanent platform from rafts or boats is to be fitted in each bay.](#)

(Technical Background: for the safety of surveyors)

There may be ships which are arranged in accordance with para b, page 8 of the Annex to the current SC 191 (i.e., no means of access from the LPMA in each bay to a raft is required) and therefore could not be rafted if the sentence proposed by RINA ("[A means of access to the longitudinal permanent platform from rafts or boats is to be fitted in each bay](#)") is included in the Z10's.

GPG therefore agreed not to include this sentence in Z10s.

For the same reason, the same sentence was not added to Rec.39.

Finally, GPG added the following sentence to UI SC191(interpretation for II-1/3-6):

*A permanent means of access from the longitudinal platform to the water level indicated above is to be fitted in each bay (e.g permanent rungs on one of the deck webs inboard of the longitudinal permanent platform).*

## **6. Implementation**

It was agreed that the revised UI SC191 be implemented to ships contracted for construction 6 months after adoption by Council.

UI SC191 was also edited in line with IMO MSC/Circular. 1176, leaving its mandatory language (is/are to, shall) unchanged.

(Note: UI SC191(Rev.2) makes references to the following new Recommendations:

- REC 90: Ship Structure Access Manual
- REC 91: Guidelines for approval/acceptance of Alternative Means of Access)

23 September 2005  
Permanent Secretariat  
Updated on 13 Oct 2005.

**Survey Panel Task 11 – Unified Periodic Survey Requirements related to SOLAS  
Reg. XII/12 & Reg. XII/13.**

**Technical Background**  
**Amendments to UR Z10.2(Rev.19, Jan 2006) and UR Z10.5 (Rev.3, Jan 2006)**

### 1. Objective

To amend UR 10.2 Section 2.6 and 3.4 and UR Z10.5 Section 2.6 and 3.3 to include survey requirements related to SOLAS reg. XII/12 and XII/13.

### 2. Background

This task was originally discussed during the WP/SRC annual meeting which took place at DNV Headquarters on the 26<sup>th</sup> to 28<sup>th</sup> October 2004; it was subsequently recorded under paragraph 9 “any other business” of the minutes of this meeting.

While the SOLAS Reg.XII/12 (hold, ballast and dry spaces water level detectors) and XII/13 (availability of pumping systems) retroactive requirements for existing bulk carriers have entered into force on 1<sup>st</sup> July 2004, as required by IMO Res.MSC.134(76), the IACS UR S 24 has been deleted on 1<sup>st</sup> January 2004. In addition, SOLAS does not include any periodical survey requirements for such detection systems and pumping systems.

### 3. Methodology of Work

Survey Panel members through correspondence.

### 4. Discussion

Survey Panel member from BV raised this issue at the February 2005 Survey Panel meeting and volunteered to propose amendments to the applicable URs for Panel members to review and comment on through correspondence. At the Fall meeting of the Survey Panel, it was agreed upon by all Panel members that the proposed amendments for UR Z10.2 and Z10.5 as applicable, which were proposed by BV were acceptable.

### 5. Implementation

The Survey Panel is of the view that the Members need 12 months from the adoption date to implement these amendments into their class rules. Assuming that GPG and Council approve to the amendments, the Survey Panel would propose January 2007 as an implementation date.

Submitted by Survey Panel Chairman  
4 Nov 2005  
approved on 31 Jan 2006 (5031fICa)



**Survey Panel Task 43 – Amend the applicable sections of the URs to address the requirements for substantial corrosion in the Common structural rules.**

**Technical Background**

**(UR Z10.2, Rev.22, June 2006)**

**(UR Z10.4, Rev.4, June 2006)**

**(UR Z10.5, Rev.4, June 2006)**

**1. Objective**

Amend applicable sections of the URs to address the requirements for substantial corrosion in the Common structural rules.

**2. Background**

Due to the different application of substantial corrosion in the CSR from the current Unified Requirements.

**3. Methodology of Work**

Panel members discussed the proposed revisions through correspondence up to the Spring Panel meeting where final amendments were agreed upon for submittal to the IACS Hull Panel for review.

**4. Discussion**

After much discussion between all Panel members at the March 2006 Survey Panel members, a unanimous decision was reached as to the wording of CSR Substantial corrosion in UR Z10.2, 10.4, and 10.5 in section 1.2.9 and was then submitted to the Hull Panel for review and approval. The hull panel concluded that the Survey Panel definition for CSR substantial corrosion was not entirely accurate and recommended further amendments to clarify the actual requirements. The new definition was then circulated to the Survey Panel for a final review and was unanimously agreed upon.

**5. Implementation**

The Survey Panel is of the view that the Members need 12 months from the adoption date to implement these amendments into their class rules/procedures. Assuming that GPG and Council approve the amendments, the Survey Panel would propose **July 2007** as an implementation date.

Submitted by Survey Panel Chairman

## **Technical Background**

### **UR Z10.1 (Rev.14), UR Z10.2 (Rev.23), UR Z10.4 (Rev.5) & UR Z10.5 (Rev.5)**

#### **Survey Panel Task 3 – Maintenance of Alignment/ Compatibility of IACS URs and IMO survey requirements**

##### **1. Objective**

Maintenance of alignment/compatibility of IACS URs and IMO survey requirements regarding resolution MSC 197(80) – amendments to A744(18)

##### **2. Background**

IMO survey requirements to ESP vessels as amended in A744(18) as noted in MSC 197(80), with an implementation date of 1 January 2007.

##### **3. Methodology of Work**

Survey Panel members through correspondence.

##### **4. Discussion**

Survey Panel members, at the fall 2006 Survey Panel meeting, finalized the amendments to the applicable URs due to changes adopted at MSC(80).

Additionally, Members noted that URZ10.4 paragraphs 2.2.3.1 and 4.2.2.2 does not require examination of ballast tanks adjacent to heated fuel tanks, as required by MSC197(80). The survey panel agreed that if this is the position that IACS would like to take regarding double hull tankers, then it should be brought to the attention of IMO at the next IMO meeting, DE50 in March 2007.

##### **5. Implementation**

The Survey Panel is of the view that the Members need 12 months from the adoption date to implement these amendments into their class rules. Assuming that GPG and Council approve the amendments, the Survey Panel would propose January 2008 as an implementation date, although the IMO implementation date is January 2007.

Submitted by Survey Panel Chairman  
9 January 2007

##### **GPG discussion**

All members agreed to omit the requirement of examination of ballast tanks adjacent to heated fuel tanks, as required by MSC197(80), from URZ10.4 for double hull tankers and

that it should be brought to the attention of IMO at DE50. In addition ABS proposed that paragraphs relating to similar requirements in URZ10.1 should also be deleted for consistency and this was agreed by members.

Members also made a number of minor/editorial corrections to the text prior to their approval of the revised documents.

Added by Permanent Secretariat  
23 April 2007

## Technical Background Document

### UR Z10.5 (Rev.6 April 2007) & UR Z10.2 (Rev.24 April 2007)

*(Survey Panel Task 10 – Develop survey requirements for void spaces of ore carriers)*

#### **1. Objective:**

Develop survey requirements for void spaces of ore carriers

#### **2. Background**

DNV requested at WP/SRC Annual meeting October 2004 to develop survey requirements void spaces of ore carriers. See the attached document « Ore Carriers, Hull Survey Requirements » for easy reference. NK submitted a « A case study on a certain Ore Carrier » dated 22 October 2004 for this purpose.

#### **3. Discussion**

The task has been carried out by a Project Team chaired by DNV Survey Panel member and with Survey Panel members from BV, LR, NK and RINA.

The Project Team drafted new amendments to Unified Requirement UR Z 10.5 « Hull Surveys of Double Skin Bulk Carriers » using the same principles contained in the survey requirements of UR Z10.1 for ballast spaces of single hull oil tankers with appropriate adjustments recognizing that void spaces do not carry ballast water.

In that respect, a new TABLE I/Sheet 2 was developed to cover the minimum requirements for close-up surveys at special hull surveys of ore carriers. The existing TABLE I, renamed TABLE I/Sheet 1, was made applicable to double skin bulk carriers excluding ore carriers.

Accordingly, TABLE III/Sheet 3 (REQUIREMENTS FOR EXTENT OF THICKNESS MEASUREMENTS AT THOSE AREAS OF SUBSTANTIAL CORROSION OF DOUBLE SKIN BULK CARRIERS WITHIN THE CARGO LENGTH AREA) was renamed STRUCTURE IN DOUBLE SIDE SPACES OF DOUBLE SKIN BULK CARRIERS INCLUDING WING VOID SPACES OF ORE CARRIERS.

In addition, Sheets 15 and 16 of URZ10.2 Annex II are to be removed.

The draft amendments to UR Z10.5 were presented to the Survey Panel members on the 13th-15th September 2006 meeting at ABS Headquarters in Houston and were finally agreed by all members on the 22nd September 2006.

#### **4. Implementation**

The Survey Panel is of the view that the Members need 12 months from the adoption date to implement these amendments into their class Rules/procedures. Assuming that GPG and Council approve the amendments by the end of 2006, the Survey Panel would propose as an implementation date for surveys commenced on or after the **1 July 2008**

**Submitted by Survey Panel Chairman  
22nd March 2007**

#### **Permsec note (May 2007):**

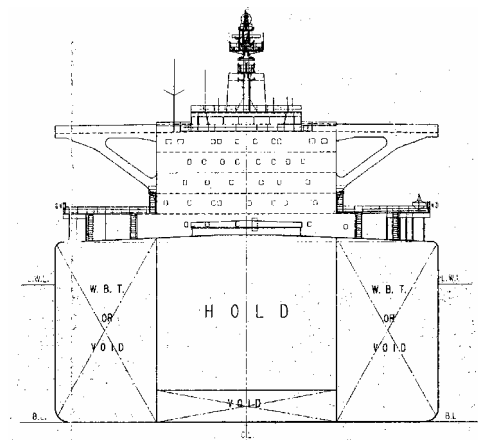
Revisions adopted by GPG 12 April 2007 (5031hIGg).

**Attachment:**

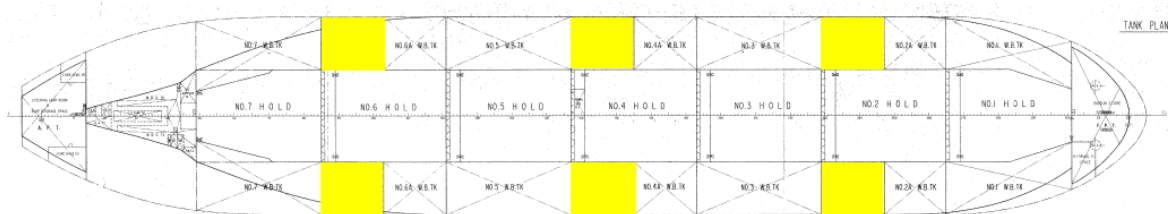
**Ore Carriers, Hull Survey Requirements**

"Ore carrier" means a single deck ship having two longitudinal bulkheads and a double bottom throughout the cargo region and intended for the carriage of ore cargoes in the centre holds only. Side tanks are generally arranged for the carriage of water ballast.

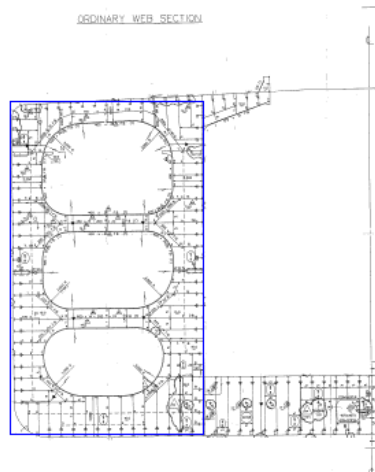
In accordance with UR Z10.5, for close-up surveys of side ballast tanks of ore carriers, the survey requirements of side ballast tanks for oil tankers as given in UR Z10.1 apply.



However, the amount of ballast water required to meet draught requirements for navigation / harbour operations, are generally less than the total capacity of the side tanks. Hence ore carriers are often designed with several side tanks as void spaces.



The internal structures are generally as for side ballast tanks with transverse web frame rings. The protective coating, if any, may be less durable than coating applied for ballast tanks and the void spaces are exposed to corrosion.



Ore carriers are generally large sized vessels and the overall survey of side void spaces may not be sufficient in order to carry out a meaningful survey for detection of corrosion and other structural defects.

**It is proposed to consider minimum requirements for close-up surveys for side void spaces. Requirements given in UR Z10.1 applicable to side cargo tanks may be used as basis.**

DNV 2004-10-19

## **Technical Background**

### **UR Z10.5, Rev. 7 (July 2007) - Amendment to Table II**

#### **Survey Panel Task 1 – Annual Review of Implementation of IACS Resolutions**

##### **1. Objective**

Maintenance of alignment/compatibility of IACS URs and IMO survey requirements.

##### **2. Background**

This proposed change was raised by the DNV Survey Panel member due to inconsistencies found in the UR Z10s.

##### **3. Methodology of Work**

Survey Panel members through correspondence.

##### **4. Discussion**

The DNV Survey Panel members raised the issue of alignment of TM requirements for vessels falling under the Z10s, where at Renewal Survey#2, TM was required for selected wind and water strakes outside the cargo area, except for vessels under UR Z10.5. All Survey Panel members agreed to the inconsistency and further agreed to the proposed changes.

##### **5. Implementation**

The Survey Panel is of the view that the Members need 12 months from the adoption date to implement these amendments into their class rules. Assuming that GPG and Council approve to the amendments, the Survey Panel would propose July 2008 as an implementation date.

Submitted by Survey Panel Chairman,  
25 June 2007

#### **Permanent Secretariat note (July 2007):**

Adopted by GPG with an implementation date of 1 July 2008 on 14 July 2007 (ref. 7596\_IGb).

## **Technical Background**

**URs Z7(Rev.15), Z7.1(Rev.5), Z7.2(Rev.1), Z10.1(Rev.15),  
Z10.2(Rev.26), Z10.3(Rev. 9), Z10.4(Rev.6), Z10.5(Rev.8) – November  
2007**

### ***Survey Panel Task 1 – Annual Review of Implementation of IACS Resolutions***

#### **1. Objective**

To review IACS Resolutions annually and discuss or propose amendments as deemed necessary.

#### **2. Background**

This proposed amendment to all URZ7s and URZ 10s was raised by the Panel member from DNV due to Owners crediting tanks concurrently under intermediate and special survey.

#### **3. Methodology of Work**

Survey Panel members through correspondence.

#### **4. Discussion**

The Panel member from DNV raised the issue of Owners having the ability of crediting spaces and thickness measurements only once in a 54 month interval, due to the availability of concurrent crediting of spaces and thickness measurements due to the flexible time window that is currently allowed between the intermediate survey and the special survey.

After a presentation and discussion lead by the DNV Panel member, all Survey Panel members agreed to the argument given by DNV, and further agreed to make the necessary changes in all URZ7s and URZ10s where Owners are not allowed to concurrently credit surveys and thickness measurements of spaces.

#### **5. Implementation**

The Survey Panel is of the view that the Members need 12 months from the adoption date to implement these amendments into their class rules. Assuming that GPG approve to the amendments, the Survey Panel would propose January 2009 as an implementation date.

Submitted by Survey Panel Chairman  
22 October 2007



**Permanent Secretariat note (December 2007):**

During GPG discussion DNV proposed that *“since this matter will be discussed between Owner and Class mainly in connection with the forthcoming Special Survey, DNV would prefer to locate this text, not only as part of Intermediate Survey, but also as a new text for the Special Survey.”* This was supported by BV, ABS, RINA and KR.

The revised documents were approved, with DNV’s proposal and an implementation date of 1 January 2009, on 15 November 2007 (ref. 7690\_IGb).

## Technical Background

### URs Z7(Rev.16), Z7.1(Rev.6), Z7.2(Rev.2), Z10.1(Rev.16), Z10.2(Rev.27), Z10.3(Rev.11), Z10.4(Rev.7) and Z10.5(Rev.9) - March 2009

#### Survey Panel Task 62:

- A) *Harmonization of UR Z10.1, Z10.2, Z10.4 and Z10.5 with UR Z10.3 with respect to items 5.5.4.4 and 5.6.2.*
- B) *Harmonization of UR Z7, Z7.1, Z10.1, Z10.2, Z10.3, Z10.4 and Z10.5 with UR Z7.2 with respect to the definition of the corrosion prevention system and with respect to the footnote 1 related to semi-hard coatings.*
- C) *Harmonization of the definition of Ballast Tank in UR Z7(Rev.14)*

### 1. Objective

- A) Amend the texts of items 5.5.4.4 and 5.6.2 in Unified Requirements Z10.1, Z10.2, Z10.4 and Z10.5 in order to align them with those in UR Z10.3, in which they were changed while performing Task 55, whereas in the other UR Z10s they were kept unchanged on the grounds that this change was out of the scope of Task 55.
- B) Amend the definition of “Corrosion Prevention System” and include a Footnote 1 related to semi-hard coatings in Unified Requirements Z7, Z7.1, Z10.1, Z10.2, Z10.3, Z10.4 and Z10.5 in order to align them with those adopted in UR Z7.2, when this new UR was issued.
- C) Amend UR Z7 (Rev. 14) in all items where the term “Ballast Tank” is used in order to get them harmonized with the definition itself.

### 2. Background

The task, as regards item A), was triggered by a Member Society, while performing Task 55, on the grounds that this part was out of the scope of the task and then should have been dealt with in a separate task.

The task, as regards item B), was triggered as a consequence of the “New Business action item 2” of the Minutes of the September 2008 Survey Panel meeting, for sake of harmonization of the various URZs.

The task, as regards item C), was triggered as a consequence of the “Task 54-Examination of Double Bottom Ballast Tanks at annual surveys” of the Minutes of March 2008 Survey Panel meeting, for sake of harmonization of the definition of Ballast Tank in UR Z7(Rev.14).

### 3. Discussion

The task was carried out by correspondence. All the amended texts for the affected URs were prepared by the Survey Panel Member who had chaired the PT on Task 55, in accordance with the Form A approved by GPG. In addition to the objectives outlined in the Form A, an amendment was added to item 1.3.1 of UR Z10.2 and UR Z10.5 in which the reference 3.2.3.6 in the last item of the list was replaced by 3.2.3.10 as can be correctly verified in the text.

The amended URs were circulated to all Survey Panel Members for review, comments and agreement. The texts of the URs were unanimously agreed by all Members.

#### **4. Implementation**

The Survey Panel is of the view that the Member Societies need at least 12 months from the adoption date to implement these amendments into their class rules/procedures. Therefore, in the first version of all amended URs the following implementation sentence should be proposed:

*Changes introduced in Rev .xx are to be uniformly applied by Member Societies and Associates for surveys commenced on or after [not less than 12 months after the adoption by GPG/Council].*

Since it is common practice and convenience to have implementation dates either on 1<sup>st</sup> January or on 1<sup>st</sup> July of the year, the Survey Panel proposes the 1<sup>st</sup> July 2010 as implementation date, if GPG/Council approve the URs not later than 30 June 2009.

**Submitted by Survey Panel Chairman  
28 February 2009**

#### **Permanent Secretariat notes (April 2009):**

1. The amended URs were approved by GPG on 18 March 2009 (ref. 7718bIGd).
2. During the typesetting process it was noted that para 5.1.5 of UR 7.2 was inconsistent with the amended URs and so following consultation with the Survey Panel this was also amended at this time.
3. Regarding the implementation date, GPG agreed to use 1<sup>st</sup> July 2010 provided that it was consistently used for the amended URs.

## Technical Background for UR Z10.5 Rev.10 (Mar 2011)

### 1. Scope and objectives

- 1) To amend UR Z10.4 to harmonize the definition of transverse section.
- 2) Update of references in the Executive Hull Summary Table IX.
- 3) Review IACS URZ10.5 to determine if there are issues which need to be addressed to ensure that the IACS survey regime and the CSRs are compatible.

### 2. Engineering background for technical basis and rationale

- 1) Based on that fact that bulk carriers and oil tankers have a transverse framing system applied for example on ship's sides etc. and that UR Z7 is applied to all types of ships and includes an extended definition of transverse section it is necessary to unify this definition in UR Z10s.
- 2) Update of references in the Executive Hull Summary Table VII such that the introduction of extended annual surveys is noted in the 'Memoranda' section rather than under 'Conditions of Class'.
- 3) Some requirements in CSRs for Bulk Carriers were relevant to ships in operation and it was decided to move them from CSRs to UR 10.5 in more consistent way.

### 3. Source/derivation of the proposed IACS Resolution

CSR, IACS UR Z7.

Proposed amendments to UR Z10.5 are based on internal discussion of IACS which is always striving to produce consistent and compatible rule requirements.

### 4. Summary of Changes intended for the revised Resolution:

- 1) The following additional text is added to the definition of transverse section in para 1.2.6:

*"For transversely framed vessels, a transverse section includes adjacent frames and their end connections in way of transverse sections."*

- 2) In the Executive Hull Summary Table VII (iv) the reference to part G) is updated to part H) as per Table VII (ii).
- 3) The main amendment has consisted in removing the requirements found in the CSRs related to surveys after construction and locating them in the applicable sections of UR Z10.5. The rationale of that is to have only one place where survey requirements are given and avoid any duplication of requirements in different documents, which would give rise to problems of maintenance and alignment.

Another important amendment has been the requirement for annual examination of the identified substantial corrosion areas for bulk carriers. One Member Society was

## Part B

of the opinion that there should be no difference between the CSRs and non-CSRs bulk carriers. The other Member Societies were of the opinion to consider an alternative examination, which was the original requirement in CSRs, and thus the following text was adopted in UR Z10.5:

"For vessel built under IACS Common Structural Rules, the identified substantial corrosion areas may be:

- a) protected by coating applied in accordance with the coating manufacturer's requirements and examined at annual intervals to confirm the coating in way is still in good condition, or alternatively
- b) required to be gauged at annual intervals."

Other important amendments have been made moving the following items from the CSRs to Z10.5 as applicable:

- a) the paragraphs regarding the different corrosion patterns, such as pitting corrosion, edge corrosion and grooving corrosion, and their different acceptance criteria,
- b) the items regarding the number and locations of thickness measurements, together with the associated table and referenced figures.

Another notable change has been introduced in the "ANNEX II - Recommended Procedures for Thickness Measurements" of UR Z10.5, which, however, are only recommendatory and not mandatory, where thickness measurements forms specific to CSRs double skin bulk carriers have been produced in addition to the existing ones, which only apply to non-CSRs ships.

Finally, for CSRs bulk carriers the requirement has been introduced which stipulates that "the ship's longitudinal strength is to be evaluated by using the thickness of structural members measured, renewed and reinforced, as appropriate, during the special surveys carried out after the ship reached 15 years of age (or during the special survey no. 3, if this is carried out before the ship reaches 15 years) in accordance with the criteria for longitudinal strength of the ship's hull girder for CSRs bulk carriers specified in Ch 13 of CSRs".

### **5. Points of discussions or possible discussions**

See item 4 above.

### **6. Attachments if any**

None.

## **Technical Background for UR Z10.5 Rev.11, July 2011**

### **1. Scope and objectives**

Review the requirement for repairs within IACS UR 7 and UR 10 series, in particular the requirement for Prompt and Thorough Repair, with a view to developing wording that would permit a temporary repair and the imposition of a Recommendation/ Condition of Class under specific and controlled circumstances, and in accordance with PR35.

### **2. Engineering background for technical basis and rationale**

There are instances, for example a localised, isolated and very minor hole in a cross-deck strip, at which a suitable temporary repair, for example by welding or doubling, and the imposition of a suitable short term Recommendation/ Condition of Class for permanent repair at a later date, are considered very adequate methodology for dealing with the defect.

Current IACS Requirements in the UR Z7 and Z10 series, for Prompt and Thorough repair, would not permit this to be an option, the defect would have to be permanently Promptly and Thoroughly repaired, which might require removing cargo, moving to a repair berth and staging inner spaces.

Under the Requirements of IACS Procedural Requirement PR 35 the methodology of Temporary Repair and imposition of a suitable short term Recommendation/ Condition of Class for permanent repair at a later date is fully permissible.

### **3. Source/derivation of the proposed IACS Resolution**

Based upon discussion within the IACS Survey Panel.

### **4. Summary of Changes intended for the revised Resolution:**

Following the definition of Prompt and Thorough Repair in the Unified Requirement, a new paragraph is proposed to be added:-

"1.3.3 Where the damage found on structure mentioned in Para. 1.3.1 is isolated and of a localised nature which does not affect the ship's structural integrity, consideration may be given by the surveyor to allow an appropriate temporary repair to restore watertight or weather tight integrity and impose a Recommendation/Condition of Class in accordance with IACS PR 35, with a specific time limit."

Also, Table I was split to into 2 tables for enhanced clarity, Table I.1 for Single Skin and Table I.2 for Double skin ships and miscellaneous editorial errors in the Table I.1 and I.2 are corrected.

### **5. Points of discussions or possible discussions**

a) The points of discussion are as indicated in Sections 2 and 4 above.

b) Discussion took place on whether to prepare this amendment as a Unified Interpretation of IMO Resolution A.744(18)/UR Z7 and Z10 series, finally it was agreed to make direct amendment to the relevant URs.

c) It is proposed that this amendment be submitted directly to the IMO DE/MSC Committees for consideration of amending directly IMO Res. A744(18)

**6. Attachments if any**

None

## **Technical Background for UR Z10.5 Rev.12 May 2012**

### **1. Scope and objectives**

To clarify the SSH No. 2 requirement of Table I regarding close-up surveys.

### **2. Engineering background for technical basis and rationale**

N/A

### **3. Source/derivation of the proposed IACS Resolution**

N/A

### **4. Summary of Changes intended for the revised Resolution:**

The requirement for close-up surveys at SSH No.2 as contained in Table I was clarified to indicate that close-up survey of the "forward and aft transverse bulkheads including stiffening system in a transverse section including topside, hopper side and double side ballast tanks" only applied to the tanks on one side of the ship. This clarification is consistent with the requirements of IACS Z10.2 for single skin bulk carriers.

### **5. Points of discussions or possible discussions**

None

### **6. Attachments if any**

None



## **Technical Background for UR Z10.5 Rev.14, Jan 2014**

### **1. Scope and objectives**

- a) To consider appropriate text in IACS document regarding class period for lengthy conversions.
- b) To align the requirements in PR37 and UR Z10s regarding safe entry to confined spaces.

### **2. Engineering background for technical basis and rationale**

- a) As per the IMO Res. A1053 (27), lengthy conversions (not necessarily of major character) or other major repair work can be assigned for a 5 year period from the date of completion of conversion/repairs/surveys.
- b) Safety requirements in IACS PR37 can be applied to carry out survey in safe way for all kind of ships. When there are no indications about the safety of surveyor in UR Z10s then the requirements in PR37 shall be applied.

### **3. Source/derivation of the proposed IACS Resolution**

None

### **4. Summary of Changes intended for the revised Resolution**

- a) Following additional text was included to section 2.1.3 to clarify the class period for lengthy conversions

"In cases where the vessel has been laid up or has been out of service for a considerable period because of a major repair or modification and the owner elects to only carry out the overdue surveys, the next period of class will start from the expiry date of the special survey. If the owner elects to carry out the next due special survey, the period of class will start from the survey completion date."

- b) Existing Section 5.2.6 and 5.2.7 were deleted from UR Z10s since provisions of these sections were covered by PR37. Reference of PR37 was included in Section 5.2.1.1.

### **5. Points of discussions or possible discussions**

- i) Additional text to Para.2.1.3 was discussed in order to clarify class period.
- ii) Panel considered that safety of surveyors should be dealt by PR37.

### **6. Attachments if any**

None

## **UR Z10.5 (New, November 2003, Correction Jan 2004)**

### **Technical background**

#### **1. Objective**

WP/SRC to develop a new UR for Hull Surveys of Double Side Skin Bulk Carriers

#### **2. Points of discussion**

2.1 In 1999, GPG identified a need to develop a UR (or amend Z10.2) applicable to double side skin bulk carriers.

WP/SRC was so tasked to develop a UR tailored to the structural configuration of double hull bulk carriers and other features which distinguish double hull bulk carriers from single skin bulk carriers. The UR, when developed, would be submitted to IMO for incorporation in future amendments to A.744(18).

2.2 GPG, after the first round of the draft UR in 2003, then tasked WP/SRC to further consider the definition of bulk carriers, how to treat bulk carriers with hybrid cargo hold arrangements, survey requirements for wing ballast tanks of ore carriers (WP/SRC Task 113).

2.3 Taking into account the draft definitions of bulk carrier, single side skin bulk carrier, double side skin bulk carrier as developed at IMO MSC 77 (MSC 77/WP.13/Annex 2), GPG agreed to the definition as proposed by WP/SRC (Z10.5.1.2.1). Ore carriers are included.

2.4 GPG agreed that for bulk carriers with hybrid cargo hold arrangements, Z10.2 apply to cargo holds of single side skin(Z10.5.1.1.2).

2.5 For close-up surveys of wing ballast tanks of ore carriers, Z10.1 Table 1 (for oil tankers) shall apply (Z10.5.2.3.3).

2.6 Rafting requirements in 5.5.5 -5.5.7 are aligned with other UR Z10s.

\*\*\*

#### Correction (2212 IGi, 26 January 2004)

2.7 WP/SRC Small Group identified inconsistency between UR Z10.2 and UR Z10.5 and proposed modifications. In Z10.2, the extent of the intermediate survey of ships between 10-15 years is to be equivalent to the previous special survey. Accordingly, the 2<sup>nd</sup> column of Table IV for

intermediate survey requirements also needs to be replaced by “the requirements of the previous special survey”.

- 1) UR Z10.2(Rev.15, Dec 2003) 4.2.3 reads that *for BCs 10-15 years of age, IS shall be the same extent of the previous SS.*
- 2) The current version of Z10.5 for double skin bulk carriers does not have this requirement.
- 3) Also, the draft UR Z10.1 (definition of POOR , draft Rev.12 – 3095\_IGc of 08/08/2003) contains the same requirement for IS of oil tankers 10-15 years.
- 4) Z10.5.2.3.3 clearly defines the extent of overall and close-up surveys at the time of Special Surveys.
- 5) To keep consistency between Z10.2 and Z10.5, paras 4.2.3.1-4.2.3.3 are corrected.

\*\*\*\*\*

**WP/SRC Task 102**  
**HARMONIZATION OF UR Z7s AND Z10s**

**Technical Background**

**UR Z7 (Rev. 11)**

**UR Z7.1 (Rev. 2)**

**UR Z10.1 (Rev. 12)**

**UR Z10.2 (Rev. 17)**

**UR Z10.3 (Rev. 7)**

**UR Z10.4 (Rev. 2)**

**UR Z10.5 (Rev. 1)**

Contents:

TB for Harmonization

**Annex 1.** TB for UR **Z10.1(Rev.12**, C49 amendments(coating-related))

**Appendix 1:** Memo for Coating, submitted to Council  
49(June 2004).

**Appendix 2:** DNV proposal (25 May 2005) agreed by Council

**Annex 2.** TB for "Verification/Signature of TM Forms" for records.

**Annex 3.** TB for revision of UR Zs concerning "anodes".

**1. Objective**

To amend UR Z7s and Z10s in order to make the texts of the above-mentioned URs consistent eliminating all the differences both in substance and in wording (WP/SRC Task 102).

**2. Background**

In the process of approving UR Z10.4, GPG found it necessary to amend the other existing URs Z10.1, Z10.2, Z10.3, Z10.6 and Z7 in order to eliminate any inconsistencies existing among them.

**3. Methodology of work**

The WP has progressed its work through many sessions, both during the periodical meetings and dedicated meetings restricted to a Small Group of Members (BV, DNV, GL, LR, RINA) who developed the work in order to be more efficient. All the proposed amendments of the Small Group have regularly been circulated to all Members for comment and agreement.

## 4. Discussion

4.1 The WP/SRC has completed a comprehensive comparative review of UR Z7 and Z10s, and identified inconsistencies which existed among them. During this review, attention was given to the severity of the requirements applicable to the same spaces/structural areas on different types of ESP ships. As a result, the inconsistencies were eliminated making the URZs harmonized. However, there has been no change to the scope and extent of the survey requirements.

4.2 The starting point for each UR was the most updated version available at the time of commencement. Any revision to the URZs, which were introduced during this task, was taken into account. As for instance, the UR Z10.1 was initially amended based on Rev. 9, while the last amendments are based on Rev. 11 and the UR Z10.2 was initially amended based on Rev. 13, while the last amendments are based on Rev. 16. The proposed revisions of URs Z10.1 and Z10.4 have not been numbered, as there will be revisions to those URs before the revisions introduced by the Task 102 are adopted. In fact, GPG is currently developing a Revision 12 of Z10.1 with the view to introducing significant improvements in the survey regime for ballast tanks (including combined cargo/ballast tanks) of oil tankers and UR Z10s applicable to oil tankers will also have to be revised by incorporating the amendments to A.744(18) contained in Resolution MSC 144(77), which enter into force 1 January 2005 (see 4.3 below).

4.3 Also, in harmonizing UR Z10.1 and Z10.2 care has been taken to align the corresponding text with that of IMO Res. A.744(18). However, it has been noted that the amendments to A.744(18) contained in Resolution MSC 144(77), which enter into force 1 January 2005, have not been incorporated into the IACS UR Z10s applicable to oil tankers. It seems that the updating of the above-said UR Z10s will be done by the Perm Sec and reviewed by the WP/SRC Chairman and then circulated for adoption by GPG with concurrence of Council Members for uniform application from 1 January 2005. It is understood that the revisions of the UR Z10s affected by those amendments will not include the changes introduced by the Task 102, as the implementation date proposed for those changes is 1 January 2006 (see below **6. Implementation**).

4.4 In the course of the work the WP has been developing for more than two years, several additional Tasks were assigned to the WP by GPG which affected the development of Task 102. The additional tasks which have been taken into account are the following:

- 1) In the course of Council discussion on UR Z10.6 (General Cargo Ships), certain inconsistencies were identified between Z10.6 and other Z10s. WP was instructed to expedite Task 102 (1060gIAa, 12 June 2002);
- 2) WP was instructed to include "Survey Planning for Intermediate Survey" into harmonization work (2108\_IAa, 12 July 2002);
- 3) GPG instructed WP to consider whether Z10.6 should be re-assigned as Z7.1, in connection with the harmonization work. 1060gIAb, 20 Sept 2002.

- Z7.1 developed;
- 4) Partial outcome (Z7 and Z7.1) was submitted to GPG on 17 July 2003(1060g). Council decided that approval of Z7(Rev.10) and Z7.1(Rev.2) is postponed until the harmonization is completed (1060gICb, 6 April 2004);  
[Council Chairman instructed WP/SRC to Members' comments on the draft revision of UR Z7 and Z7.1 \(collected under s/n 1060g, 1060gNKi \(30/03/2004\) in particular\) on 6 April 2004.](#)
  - 5) GPG tasked WP to include the amendments to Z10.2 / Z11 (BCs with hybrid cargo hold arrangements), deleting sheets 15 and 16 for ore carriers, into the harmonized UR Z10s (2212aIGa, 19 Jan 2004);
  - 6) GPG tasked WP to consider whether the requirements relevant to examination of Fuel Oil Tanks in the cargo area at each Special Survey should be put into Z10s, and internal examination of FOT at Intermediate Survey after SS 2 is needed. (1060gIAf, 30 Jan 2004);
  - 7) GPG tasked WP to harmonize tank testing requirements in Z7s and Z10s. (3006IIAa, 5 April 2004);
  - 8) GPG tasked WP with Task 108 - Develop uniform survey requirements for air vent pipes including the welded connection to deck. Z22 developed. GPG instructed WP to incorporate Z22 into the harmonized Z10s;
  - 9) GPG tasked WP with Task 114 - Verification and signature of TM reports. REC 77(Rev.1) developed and approved on 29 July 2004. Council approved parallel amendments to Z7.1 and Z10s (TM Forms included) and instructed WP to incorporate these into the harmonized Z10s:
    - [Recommendation No.77 was revised \(Rev.1, July 2004\);](#)
    - [Z7.1 para.6.3.2 and Z10s para.7.3.2 so amended.](#)
    - ["Surveyor's signature" is deleted from all TM Forms in Z10s;](#)
    - [A note is added to Annex II\(Z10s\) declaring that Annex II is recommendatory.](#)

WP/SRC's investigation into Members' practice in dealing with verification and signature of TM reports is annexed for record keeping purpose. [See Annex 2.](#)
  - 10) GPG tasked WP to consider the BV comments on "TM may be dispensed with..." and include the findings into the harmonized Z10s ( 2219iIAa, 7 April 2004).

## **5. Agreement within the WP/SRC**

All Members have unanimously agreed the attached final versions of UR's.

## **6. Implementation**

WP/SRC is of the view that the Members need 12 months from the adoption date to implement these amendments into their class rules. Assuming Council adoption in December 2004, WP/SRC would propose January 2006 as implementation date.

- Annex 1:** TB for UR Z10.1(Rev.12, C49 amendments, see Permsec's note 1 below)  
**Annex 2:** WP/SRC Task 114, verification and signature of TM reports(see 9 above).  
**Annex 3:** TB for revision of UR Zs concerning "anodes".

### **Note by the Permanent Secretariat**

1. Annex 1 to this TB contains background for amendments to UR Z 10.1(Rev.12) relating to FAIR/POOR/GOOD (C49 amendments). Council at its 49<sup>th</sup> meeting (June 2004) agreed/decided that comparable changes should be added to Z10.3 and Z10.4.

2. Appendix 3 "TM sampling method" has been added to UR Z10.1 and Z10.4 to keep them consistent with IMO Res.MSC.144(77). The amendments to A.744 contained in MSC.144(77) entered into force on 1 January 2005. (*GPG s/n 4181*)

Under s/n 4072g, paragraph **2.4.6** of UR Z10.1 and **2.4.6** and of UR Z10.4 (paragraph numbering is now harmonized) were amended in order to provide a link between the main text of the UR Z10.1 and 10.4 and the new Annex III Appendix 3 containing the MSC Res.144(77).

Further, it was agreed that the requirements for evaluation of longitudinal strength of the hull girder (as written in MSC.144(77)) should not be required for Intermediate Survey unless deemed necessary by the attending Surveyor. This is covered in 4.2.3.1 and 4.2.4.1 of Z10.1 and Z10.4.

3. GPG agreed that the amended UR Zs should be implemented from 1 July 2006 altogether.

4. DNV's proposed amendments to UR Z10.1, Z10.3 and Z10.4 concerning annual survey of ballast tanks were agreed by Council (1060gICq, 27 June 2005). See Appendix 2 to Annex 1.

5. Annex 3 contains a TB for revision of UR Zs concerning "anodes".

Date: September 2004  
Prepared by the WP/SRC

-- --

## **Annex 1 to Technical Background**

### **UR Z 10.1 (Rev.12, C49 amendments(coating-related))**

#### **1. Objective**

To introduce significant improvements in the survey regime for ballast tanks (including combined/ballast tanks) of oil tankers as matter of strategic concern and urgency to IACS, given the aging of both the single and double hull tanker fleets and the problems encountered with corrosion of ballast tanks in several shipping casualties.

#### **2. Background**

Draft amendments to UR Z10.1 were submitted to Council 47 (June 2003) and agreed in principle.

#### **3. Discussion**

There was particular concern over accelerated corrosion with age (as the thinner the material, the more rapidly the allowable diminution margin percentage disappears) especially where coatings have broken down. There is also a disincentive for any spend on maintenance of the structure of a ship within a few years of its statutory scrapping date.

Council discussion by correspondence had evolved to the position of substantive proposals – summed as follows (3095\_ABa, 2 June 2003):

1. Enhance the Intermediate Survey in Z10.1, Z10.3 and 10.4 for Tankers after 2<sup>nd</sup> Special / Renewal Survey to the same level (scope of work) as the preceding Special / Renewal Survey). This corresponds to the latest revision to UR Z10.2.
2. At Annual Survey of ballast tanks with substantial corrosion, the overall survey is to be replaced by close-up survey with thickness measurements of the exposed area.
3. Proposed to task WP/SRC to re-consider the acceptance criteria for the rating FAIR further. For this, eliminate FAIR, leaving only GOOD and POOR redefined as appropriate.
4. Proposed to task WP/SRC to explicitly require close-up survey of Suspect Areas identified at the previous Special Survey.

Council 47 discussed the proposals(June 2003) as follows:

##### **1. Definition of FAIR**

Council 47 agreed that “FAIR” would be retained as a rating and that GPG should instruct WP/SRC to redefine FAIR, so that there would be a clear differences between FAIR, POOR and GOOD. It was also agreed that for oil tankers the Intermediate Survey following Special Survey No.2 would have the same scope as Special Survey No.2(Z10.1). WP/SRC should also clarify the definition of satisfactory repair.

Based on the strong majority, Council agreed to discuss with Industry annual surveys of ballast tanks when coating is found in LESS than GOOD condition at special survey, with the objective to encourage the owner to carry out repairs and maintenance of coating to GOOD condition.

*DNV and NK stated that they could not accept a requirement for annual surveys of ballast tanks when the coating condition is less*



*than GOOD and proposed that GOOD be changed to FAIR (3095\_IGc, 30 June 2003)*

2. ABS' proposed amendments to Z10.1(annual examination of BWTs in certain conditions) were approved.
3. C 47 agreed that the BWT coating requirements (Z10.1.2.2.3) for intermediate Survey after SS 2 should be the same extent to the previous SS.
4. Given the substance of the changes, the revised Z10.1 should be shown to Industry before adoption.
5. A guidance for coating repairs needs to be developed by WP/SRC with reference to TSCF Guidelines.

Following Council 47, the draft text of Z10.1(Rev.12) was distributed to Industry and discussed at the IACS/Industry meeting on 29 August 2003. Industry indicated that UR Z10.1(Rev.12) is acceptable, provided that appropriate IACS guidelines on coating repairs are developed.

The Small Group on Coating (SG/Coating) under WP/SRC prepared draft guidelines on coating repairs and considered the definitions of GOOD / FAIR / POOR. The SG/Coating did not change the definitions and found that the Guidelines provide useful clarifications on the definitions and criteria in achieving an industry wide uniform judgement of coating conditions as well as what is needed to restore GOOD conditions.

Further, an IACS/Industry JWG/Corrosion was established and met in February 2004. The outcome is (3095\_IGh, 4 June 2004):

- Draft Guidelines on Coating Repair (IACS REC 87)
- Draft UR Zxx (mandatory coating of cargo tanks on oil tankers)
- Draft UI SC 122 (Rev.2) – mandatory coating of ballast tanks

#### **4. Others**

1. Z10.11.2.2bis - Definition of “Combined Cargo/Ballast Tank. ...as a routine part of the vessel's operation and will be treated as a Ballast Tank. ...”. By so amending, Z10s do not need to repeat “Ballast Tanks and Combined cargo/salt water Ballast Tanks” in addressing the ballast tanks. Hence, all the references to “and Combined cargo/salt water Ballast Tanks” were deleted.
2. Z10.1.2.2.1.2: The aim of the examination is to be sufficient to discover substantial corrosion...  
Comparable changes are to be added to other UR Zs wherever the same sentence occurs.
3. “IACS Guidelines for Coating Maintenance & Repairs for Ballast Tanks and Combined/Ballast tanks on Oil Tankers” are referenced where relevant.
4. Comparable changes are to be added to UR Z10.3 and Z10.4, after adoption of Z10.1(Rev.12).

**Attached: Memo on Coating Matters (GPG Chairman)**

9 June 2004  
Prepared by the Permsec

## **Appendix 1 to Annex 1:**

## **MEMO on Coating matters**

### **1. Background and discussion within IACS on UR Z10.1 (draft Rev.12) between 29/01/03 and 14/08/03**

In view of the survey experience with oil tankers, it was proposed that all ballast tanks should be examined, routinely and uniformly, at annual surveys on ESP tankers exceeding 15 years of age. IACS should amend UR Z10.1 to require the examination of ballast tanks on such ships at each annual survey. This is simple, clear and thorough and not subject to interpretation. (2242\_ABq dated 29/1/03)

Then, ABS modified the proposal asking, for tankers subject to URs Z10.1, Z10.3 and Z10.4, exceeding 15 years of age, that the current requirement - pertaining to annual examination of Ballast Tanks adjacent to cargo tanks with any means of heating - be deleted and replaced by a simpler and more stringent requirement that all Ballast Tanks be subject to survey at each subsequent annual survey where either substantial corrosion is found within the tank or the protective coating is found to be in less than GOOD condition and the protective coating is not renewed at special survey or intermediate survey. This will ensure that all Ballast Tanks with substantial corrosion or protective coating which is not in GOOD condition at the time of special survey or intermediate survey will be examined at each subsequent annual survey on tankers exceeding 15 years of age. (2242\_ABzb dated 14/3/03)

This was later expanded to include all tanks used routinely for ballast water, both ballast-only and cargo/ballast tanks (2242\_ABzc dated 14/3/03).

ABS further reviewed the issue of the survey of salt water ballast spaces and combined cargo/salt water ballast spaces with ABS' governing bodies in light of recent casualties and survey findings on other tankers. Their review found an increasing amount of coating breakdown/failure and subsequent rapid wastage in key structures after Special Survey No. 2, i.e. after 10 years of age. These conditions are most prevalent in the under deck structure and the side shell structure in way of the deep loadline. In a number of cases the serious wastage has caused fracturing of the under deck longitudinals and in some cases fracturing has extended to the main deck structure. This led ABS to refine proposed amendments to URs Z10.1, Z10.3 and Z10.4 to require (2242\_ABzf dated 9/5/03):

#### **a. For Tankers exceeding 10 years of age**

Salt Water Ballast Spaces and Combined Cargo/Salt Water Ballast Spaces. For tankers exceeding 10 years of age, salt water ballast spaces and combined cargo/salt water ballast spaces are to be internally examined at each subsequent Annual Survey where substantial corrosion is found within the tank or where the protective coating is found to be less than GOOD condition and protective coating is not repaired. Internal examination to be an Overall Survey.

#### **b. For Tankers exceeding 15 years of age:**

Salt Water Ballast Spaces and Combined Cargo/Ballast Spaces. For tankers exceeding 15 years of age, salt water ballast spaces and combined cargo/ballast spaces are to be examined internally at each subsequent Annual Survey. Where substantial corrosion is found within the tank, or where the protective coating is found to be in less than GOOD condition and the protective coating is not repaired then in addition to an Overall Survey, under deck structure and the side shell structure in way of the deep loadline is to be subject to Close-up Survey.

NK and BV replied that the proposed amendments made by ABS need to be substantiated in a transparent manner with technical data that ABS may possess and put forward for further assessment and discussion. (2242\_NK<sub>n</sub> dated 14/5/03 and 2242\_BV<sub>z</sub> dated 16/5/03)

**DNV** (2242\_NV<sub>n</sub> dated 2/6/03), having carefully considered the practical consequences of taking the ship off-hire for gas freeing etc. and being concerned about the difficulties to have these surveys executed in a safe manner and whether the intended safety benefits in implementing the proposed extended scope of the annual survey of Ballast tanks will be met, **proposed the following alternative measures** which would be as effective and may not have such delaying effects to the ship:

- 1) Enhance the Intermediate Survey in UR Z10.1, 10.3, and 10.4 for Tankers after the 2 Special / Renewal Survey to the same level (scope of work) as the preceding Special / Renewal Survey. (This will correspond to the latest revised requirements of UR Z10.2 for Bulk Carriers.)
- 2) At Annual Survey of ballast tanks with substantial corrosion the overall survey should be replaced by close up survey with thickness measurements of the exposed area. (An overall survey of these tanks does not give sufficient information of the development of the areas with substantial corrosion.)
- 3) Further we will not fail to mention that the WP/SRC has proposed to extend the close up survey in cargo and combination tanks to 30% from the 3 Special / Renewal Surveys.
- 4) **Experience has shown that the coating condition rating category FAIR has a tendency to be stretched too far into the POOR condition. We will therefore propose that we task the WP/SRC to reconsider the acceptance criteria for the rating FAIR further.**
- 5) We do also question the need for redefining the definition of combination tanks, particularly since the category I tankers which are the ships that normally are fitted with these type of tanks are to be phased out 2 to 4 years from now. However DNV will not oppose to such a redefinition.

**DNV requested Members to consider the above as an alternative to the ABS proposal, bearing in mind that we ought to present this to the industry prior to deciding.**

ABS (3095\_Aba dated 2/6/03), having further considered its earlier proposals in light of NV<sub>n</sub>, submitted a revised proposal for consideration by Council at C47 and replied to the above 5 DNV proposals as follows:

- 1) ABS fully supports this proposal.
- 2) While ABS agrees with this proposal, it is in fact already provided for in Z7 (3.2.3) and Z10.1 (3.2.5.1)--which require that "Suspect areas (which include any area where substantial corrosion is found) identified at previous Special Survey are to be examined. Areas of substantial corrosion identified at previous special or intermediate survey are to have thickness measurements taken." To us, this implies that close-up survey of these areas is to be done at annual survey in conjunction with the thickness measurements. However, we can

agree to tasking WP/SRC to explicitly require "close-up" survey in this connection and to amend Z7, and all the Z10's, appropriately to make this explicit, if there is majority support for this.

3) We agree that this has been put forward to GPG by WP/SRC via 0237hNVb, 27 May. However, these additional CAS close-up survey requirements do not apply to salt water ballast tanks; only to cargo oil tanks and combined cargo/ballast tanks.

4) **We agree with this assessment and we propose that the only way to eliminate the subjectivity and raise the standard is to eliminate the category "FAIR" completely; leaving only "GOOD" and "POOR" redefined as follows:**

**"GOOD -- condition with no breakdown or rusting or only minor spot rusting.**

**POOR -- any condition which is not GOOD condition."**

5) ABS does not agree with this proposal. We are particularly concerned that we need a very thorough and robust survey regime for these tankers precisely because they are subject to mandatory phase out over the next several years. We are very concerned that without additional IACS requirements, these tanks will receive little or no inspection and maintenance by owners or others after their last special or intermediate survey, if no substantial corrosion is found at that time. Rapid, localized wastage in way of deteriorating coatings may pose significant hazard if the survey regime is not further tightened as we are proposing.

In conjunction with the above comments on DNV proposals, ABS further considered their previous proposal in ABzf and modified it as follows:

- **ABS simplified the proposal to require annual examination of all salt water Ballast Tanks and combined Cargo/salt water Ballast Tanks irrespective of age, when either substantial corrosion is found within the tank or the protective coating is found to be in less than GOOD condition and is not repaired.**
- the requirement for annual (close-up) examination of salt water ballast tanks and combined tanks is already required in Z10.1 (3.2.5.1). ABS proposed adding it to 2.2.3 for clarity and emphasis so that all the conditions which may lead to annual examination of such tanks are listed together in one place.
- Since the principal problem that we are trying to address is rapid, localized corrosion in way of breakdown or deterioration of the protective coating, we are proposing that the coating condition should be found and kept in "GOOD" condition to obviate the need for annual examination. **The attached proposal is made together with the proposals in items 3.1 (intermediate following Special survey 2 to have same scope as prior Special survey) and 3.4 (eliminating "FAIR" and redefining "POOR" as any condition other than "GOOD" condition.**

ABS requested to decide on a course of action at C47 for tightening the survey regime for tankers. They agreed that industry be informed of Council's decisions in this regard prior to IACS making the decision public, but IACS should maintain its independence and take decisive action in this matter. Debate with industry can only lead to delay and to a watering down and compromising of these important requirements.

NK agreed to task WP/SRC to reconsider the acceptance criteria of "FAIR" for clearly define the border between "FAIR" and "POOR" condition. However, **NK strongly opposed the elimination of "FAIR" coating condition from UR Zs** because this can not resolve to remove subjectivity of coating assessment. The three-categorization system of coating condition should be retained. (3095\_NKa dated 5/5/03)

## **Outcome of C47**

At C47, it was agreed that "Fair" would be retained as a rating and that GPG should instruct WP/SRC to redefine "Fair", so that there would be a clear differentiation between "Fair", "Poor" and "Good". It was also agreed that for oil tankers the Intermediate Survey following Special Survey No.2 would have same scope as Special Survey No.2 (Z10.1). WP/SRC should also clarify the definition of satisfactory repair.

Based on strong majority support Council agreed to discuss with Industry annual surveys of ballast tanks when coating is found in LESS than GOOD condition at special survey, with the objective to encourage the owner to carry out repairs and maintenance of coating to GOOD condition.

This matter should be discussed with Industry prior to adoption of any UR by Council.

In a final summary, the Chairman proposed that a constructive dialogue with Industry should take place on the IACS proposal as set out in WP1 plus maintaining 3.2.5.2 modified to say that ballast/combined ballast/cargo tanks will be subject to annual survey when considered necessary by surveyors.

After discussion in the JWG (Industry/IACS), GPG should propose final rules for this matter to Council, including acceptable repair definition.

**FUA 17:** *To instruct WP/SRC to develop guidance on coating repairs and more precise definition of "Fair" coating condition.*

Once approved, these requirements should be incorporated into Z10.3 and Z10.4.

### **FUA 15**

1) *To prepare a draft revision to UR Z10.1 incorporating C 47 decisions:*

- *The definition of "FAIR" remains as it is;*
- *ABS proposed amendments to Z10.1 (annual examination of BWTs in certain conditions) were approved;*
- *C47 agreed that the BWT coating requirements (Z10.1.2.2.3) for Intermediate Survey after Special Survey No.2 should be the same extent to the previous Special Survey.*
- *Given the substance of the changes, the revised UR Z10.1 should be shown to Industry (OCIMG/Intertanko first among others) before adoption for their review and comments.*
- *A guidance for coating repairs needs to be developed by WP/SRC with reference to TSCF Guidelines.*

2) *GPG Members are to confirm the draft revision to Z10.1 in consultation with their WP/SRC members by correspondence. See 3095\_IGa of 13/06/03.*

According to C47 FUA 15, GPG Chairman circulated (3095\_IGa dated 13/6/03) draft amendments to UR Z10.1 as agreed in principle at C47.

Having received a number on comments, GPG Chairman (3095\_IGb dated 27/6/03) informed that the Council Chairman confirmed that GPG is not to amend the principles agreed at C47, i.e. we are not empowered to change "GOOD" to "FAIR" as proposed by DNV and NK, nor to amend the definitions of "FAIR" and "POOR" as proposed by DNV.

DNV's intention to possibly lodge a reservation was noted, however the matter should be raised at Council and not be dealt with by GPG. An amended draft text incorporating the non-substantive changes proposed by Members was circulated.

DNV said that its understanding was that the draft should be circulated to the Industry (ICS, INTERTANKO, and BIMCO) prior to adoption by Council. (3095\_NVc dated 30/6/03)

GPG Chairman (3095\_IGc dated 30/6/03) circulated a draft amendment of UR Z10.1 for Council's agreement and use in discussions with the industry associations.

The draft was generally agreed by GPG but individual Members have requested that the following matters (which were deemed to be outside the remit of GPG in this task) be brought to Council's attention for further consideration:

- 1 DNV and NK stated that they can not accept a requirement for annual surveys of ballast tanks when the coating condition is less than GOOD and propose that GOOD be changed to FAIR.
- 2 In connection with item 1 above, DNV also propose to amend the definitions of FAIR and POOR in order to raise the standard of FAIR.

Council Chairman (3095\_ICb dated 14/8/03) concluded that Council has agreed that the draft amendments to UR Z10.1 attached to IGc reflect Councils' decision taken at C47 and that they be circulated to industry associations.

Perm Sec was therefore invited to submit the draft to OCIMF and INTERTANKO in view of discussion at the IACS/ industry meeting on 29 August.

## **2. Discussion with Industry (29/08/2003 – 11/10/2003)**

As requested by Council, the whole matter was presented to Industry during the “general matters” meeting with IACS held on 29 August 2003; comments from Industry were requested. In the following an extract from the minutes of the meeting (see message 3100aIAb dated 5 September 2003):

\_\_\_\_\_ from Meeting minutes \_\_\_\_\_

## **4. & 5. Annual surveys of ballast tanks and IACS guidelines on coating repairs**

M. Dogliani introduced the matter ([see Items 4&5 in Appendix](#)).

A. LinoCosta gave a presentation to show where concerns and decisions stand: too many cases when coating was considered fair at SS but problems occurred just after one/two years.

N. Mikelis commented on draft amendments to Z10.1 (Rev.11) stating that the extent of annual survey is not clear; it should be limited to the affected zones, e.g. coating breakdowns, only.

M. Guyader clarified that, in this draft amendments, it is expected an overall survey of the whole tank and a close up survey of the affected zones.

N. Mikelis noted that, in the draft amendments to Z10.1 (Rev.11), the intermediate survey at 12.5 years would have the same scope as the previous special survey and that needed a justification. See 7 a).

M. Dogliani said that Z10.1 (Rev.11) was adopted in August 2003 and will be introduced into IACS Societies' Rules over the next year.

### Conclusions:

4.1 Industry shared IACS concerns on coatings and, in general, agreed with the draft amendments to Z10.1 (Rev.11) suggesting also extending them to Z10.2 on bulk carriers

4.2 Industry agreed that a guideline for surveyor on coating would greatly improve uniform application of so-amended Z10.1 including issues such as how to consider load bearing elements when judging GOOD/FAIR/POOR status and how to consider bottom pitting in connection with GOOD conditions

4.3 Industry will more precisely comment, by the end of September, the draft Z10.1 so as for IACS to finalise the matter, as planned, for the Council's December meeting.

Item	Title	Industry recommendation	IACS/ M. Dogliani Introduction
4 & 5	Annual survey of ballast tanks IACS guidelines on coating repairs	NN	<p><b>1. IACS is considering the following:</b></p> <ul style="list-style-type: none"> <li>- <b>amend UR Z10.1 (draft circulated to Industry) to the effect that in case at Special Survey or Intermediate Survey the coating in a ballast tank is found less than GOOD, either GOOD conditions are restored or the tank's coating is inspected at each annual survey;</b></li> <li>- <b>develop IACS guideline to assist an uniform application of the so modified (if adopted) UR Z10.1; the guideline should address which repairs are necessary to restore GOOD conditions from FAIR and POOR respectively and which are the criteria for the restored (after repair) situation to be rated as GOOD.</b></li> </ul>

\_\_\_\_\_ End of extract from minutes \_\_\_\_\_

INTERTANKO commented (see R. Leslie email to GPG dated 25 September 2003):

- expressing their concern for the draft Z10.1 and underlining
  - a) targeting: concerns that, if not properly dealt with, Z10.1 would target all ships and not just those which need intervention; the view was expressed that guidelines would probably solve the matter;
  - b) definition: indicating that the current definitions of GOOD, FAIR and POOR is not clear enough and that the matter would be even worst with GOOD and NON GOOD; again it was indicated that guidelines could solve the matter;
  - c) expertise: expressing doubts on IACS' surveyors expertise and ability to judge coating conditions; in this respect they (hiddenly) suggest that IACS position is unclear when we say that we are not competent to judge the coating during construction but then we are competent to judge coating during operational life. Even if not explicitly stated, the impression is that also in this case guidelines would help.

Additionally, INTERTANKO suggested a (quite detailed) set of assessment criteria.

The matter was then finally addressed at the TRIPARTITE Meeting (held in Soul on 29/30 September 2003). There Industry agreed that the way forward was the (joint) development of IACS guidelines (see minutes attached to message 3100\_RIe dated 11 October 2003, an extract of which is reproduced below).

\_\_\_\_\_ Extract from the TRIPARTITE minutes \_\_\_\_\_

Industry is concerned by the definition of GOOD/NOT GOOD in relation to coating repairs and acceptance criteria. Industry agreed that new guideline on this, which IACS is already producing, was the way forward.

\_\_\_\_\_ End of the extract from the minutes \_\_\_\_\_

### **3. Further developments**

- a) from the above, it was concluded that, provided the guidelines are sound, Industry would accept the concept of Z10.1 (draft) Rev. 12, therefore an IACS team and a JWG were established in order to progress the matter of the guidelines (among other related matters).
- b) the team of IACS experts on coating developed draft guidelines and provided recommendations to GPG on the way forward (attached to message 3095bNVc dated 20 November 2003).
- c) the guidelines were discussed within the JWG with Industry (see draft minutes circulated within GPG with messages 3095cIGd and 3095cIGe both dated 13 March 2004)
- d) further suggestions and comments (as requested at the meeting) were provided by Industry (not circulated to GPG)
- e) Bulk Carrier Industry is recommending that similar guidelines are developed in due time also for bulk carriers
- f) at DE47 and MSC78, IMO is asking Industry and IACS to develop (compulsory) performance standards for coating of newbuilding (double hull spaces of DSS Bulk Carriers), a matter which is, indirectly related to the above one.

1 June 2004

M. Dogliani

IACS GPG Chairman

IACS JWG/COR Chairman



Appendix 2 to Annex 1: [DNV proposal to Z10.1, Z10.3 and z10.4](#) ▶

Sent Monday, July 4, 2005 4:45 pm

To [Gil-Yong <gilyonghan@iacs.org.uk>](mailto:Gil-Yong <gilyonghan@iacs.org.uk>)

Cc

Bcc

Subject Fw: 1060gNVs; WP/SRC - Task 102 - Harmonization of UR Z 7 and Z 7.1

Attachments [Doc1.doc](#)

25K

----- Original Message -----

From: "Debbie Fihosy" <[debbiefihosy@iacs.org.uk](mailto:debbiefihosy@iacs.org.uk)>

To: "CCS" <[iacs@ccs.org.cn](mailto:iacs@ccs.org.cn)>

Cc: "IACS Permanent Secretariat" <[permsec@iacs.org.uk](mailto:permsec@iacs.org.uk)>

Sent: Friday, June 03, 2005 2:52 PM

Subject: FW: 1060gNVs; WP/SRC - Task 102 - Harmonization of UR Z 7 and Z 7.1

Forwarding as requested

-----Original Message-----

From: Arve.Myklebust@dnv.com [[Arve.Myklebust@dnv.com](mailto:Arve.Myklebust@dnv.com)]

Sent: 25 May 2005 15:49

To: [AIACS@eagle.org](mailto:AIACS@eagle.org); [iacs@bureauveritas.com](mailto:iacs@bureauveritas.com); [iacs@ccs.org.cn](mailto:iacs@ccs.org.cn);

[johnderose@iacs.org.uk](mailto:johnderose@iacs.org.uk); [iacs@dnv.com](mailto:iacs@dnv.com); [iacs@gl-group.com](mailto:iacs@gl-group.com);

[gilyonghan@iacs.org.uk](mailto:gilyonghan@iacs.org.uk); [helenbutcher@iacs.org.uk](mailto:helenbutcher@iacs.org.uk); [efs@iacs.org.uk](mailto:efs@iacs.org.uk);

[krsiacs@krs.co.kr](mailto:krsiacs@krs.co.kr); [richardleslie@iacs.org.uk](mailto:richardleslie@iacs.org.uk); [external-rep@lr.org](mailto:external-rep@lr.org);

[clnkiacs@classnk.or.jp](mailto:clnkiacs@classnk.or.jp); [terryperkins@iacs.org.uk](mailto:terryperkins@iacs.org.uk); [iacs@rina.org](mailto:iacs@rina.org);

[iacs@rs-head.spb.ru](mailto:iacs@rs-head.spb.ru); [colinwright@iacs.org.uk](mailto:colinwright@iacs.org.uk)

Subject: FW: 1060gNVs; WP/SRC - Task 102 - Harmonization of UR Z 7 and Z 7.1

25 May 2005

To: Mr. B. Anne, Chairman of IACS Council,

cc: Council Members, IACS Perm. Sec.

Ref.: My mail NVr dated 20 May 2005

DNV have further studied the amendments to UR Z10.1, Z10.3, and Z10.4, and as a result are presenting the following as a compromise solution:

General comment:

From the comments by other Members it is obvious that there is reluctance to accept annual surveys of ballast tanks with a common plane boundary to heated cargo tanks in the case where the coating is in good condition. This is particularly unreasonable as at the same time we enhance the Intermediate survey of Tankers between 10 and 15 years to also include examination of all ballast tanks, meaning that all ballast tanks will be close up surveyed with 2-3 years intervals from the ship is 10 years old, with the possibility for the surveyor to require thickness measurements and testing of the tanks to ensure the structural integrity of the tanks if necessary.

It is also proposed for the Intermediate survey between 5 and 10 years, to increase the scope from representative to all ballast tanks, a requirement DNV find to strict, and require that we here keep the original text.

If a ballast tank is found to have coating in GOOD condition at the renewal or intermediate survey, a deterioration of the tank beyond structural reliability is very unlikely even if the tank has a common plane boundary to a heated cargo tank.

DNV finds it particularly unreasonable to have this requirement to apply to double hull tankers for the following reasons:

- these ships have double hull and the risk of pollution is here much reduced,
- the double hull is constructed with small spaces giving improved structural reliability,
- almost all double hull tankers below VLLC have heated cargo tanks, and all ballast tanks have common plane boundaries to these tanks, meaning that this requirement will apply to a major part of the tanker fleet in the future,
- the ballast tanks of double hull tankers are so designed that a general examination of these tanks will be identical to a close up survey,
- survey of ballast tanks of double hull tankers will mean either gas freeing of all cargo tanks or at least dropping the inert gas pressure of all cargo tanks in addition to proper airing of all ballast tanks.

Since the single hull tankers will be faced out in the near future, and for clear political reasons, DNV will as a compromise proposal to keep paragraph 2.2.3.1 and 4.2.2.2 in Z 10.1 as amended by Council (ref. IAo) but amend it to not include 2.2.3.1.e, 4.2.2.2.e and last paragraph of 3.2.5.1 in Z10.3 and Z10.4. In addition we request that the original text of 4.2.2.1 is kept.

If BV, ABS and other Members can accept this DNV is willing to drop our reservation presented at C49.

DNV's proposal will then be as follows:

Z10.1:

2.2.3.1: This paragraph can be accepted as is for the reasons stated above.

3.2.5.1: This paragraph is accepted as amended.

4.2.2.2: This paragraph can be accepted as is for reasons stated above.

For other comments to Z10.1 see NVo and NVp.

Z10.3:

2.2.3.1.e to be deleted.

3.2.5.1 delete last paragraph

4.2.2.1 the original text to be kept. "For tanks used for water ballast ---"

4.2.2.2.e to be deleted

Z10.4

2.2.3.1e to be deleted

3.2.5.1 delete last paragraph

4.2.2.1 the original text to be kept, "For tanks used for water ballast --"

4.2.2.2.e to be deleted.

For details see attached document where the text for the requirements in Z10.3 and Z10.4 that DNV will accept is stated.

Best Regards

Arve Myklebust  
on behalf of  
Terje Staalstrom  
DNV IACS Council Member  
<<Doc1.doc>>

\*\*\*\*\*

Neither the confidentiality nor the integrity of this message can be vouched

Annex 2 to TB (Harmonization Z10s)

**WP/SRC Task 114 “Clarify the procedure of verification and signature of the thickness measurement report”**

Item No.	Item	ABS	BV <sup>1)</sup>	CCS	CRS	DNV	GL	IRS	KR	LR	NK	RINA	RS
<b>1</b>	<b>Verification onboard</b>												
1.1	Minimum extent of measuring points for direct verification by attending surveyor specified	No	No	No	No	No	No	No	Yes	No	No	Yes	No
1.2	Preliminary TM record to be signed upon completion of the measurements onboard	Yes	Yes <sup>7)</sup>	Yes	No (copy taken)	No <sup>3)</sup>	No <sup>6)</sup>	Yes	Yes	Yes	Yes	No <sup>8)</sup>	No
<b>2</b>	<b>Final TM report</b>												
2.1	Signature of all pages in TM record required	No	No	No	Yes	No	Yes	Yes	No	No	No <sup>5)</sup>	Yes	Yes
2.2	Signature of ‘cover’ (‘general particulars’) page only	Yes	Yes	Yes	No	Yes	No	No	No <sup>4)</sup>	Yes	Yes	Yes	No
2.3	Measuring points verified by attending surveyor required identified in TM record and signature of the corresponding pages required	No	No	Yes Without signature	Yes	No	No	No	Yes	No	No	No	No

2004-04-20

<sup>1)</sup> Instructions not clear regarding signature of the thickness measurement record

<sup>2)</sup> Signature on front and last page, stamp on all other pages, or signature on each page (IACS TM forms)

<sup>3)</sup> Upon completion of measurements onboard a draft report in electronic format (DNV TM template, including operator’s notes as relevant) to be given to attending surveyor

<sup>4)</sup> Signature of cover page, pages of meeting record and pages of attended measuring points

<sup>5)</sup> Each page to be signed in case of ‘loose-leaf’ type record

<sup>6)</sup> Preliminary TM record has to be passed to the Surveyor, signed by the Operator

<sup>7)</sup> The only measures which the Surveyors can certify exact are those for which that they have seen the results on the screen of the apparatus. That means in fact few points in comparison with the numbers of recorded measures.

<sup>8)</sup> The Surveyor reviews the TM record for completeness and assessment of TM readings, but no signature required.

UR Z7s and Z10s (Corrosion Prevention System)

1. Objective:

To clarify whether the survey of anodes is a class matter, and if so, whether acceptance criteria for anode should be developed.

2. Method: GPG by correspondence (5037\_)

3. Discussion

3.1 BV initiated GPG discussion as follows:

Paris La Défense, 8 Mars 05

1 - We have noticed that, in the draft UR Z's ( 7.1, 10.1 to 10.5) issued further to the WP/SRC Task 102, the original sentence ".....the examination may be limited to a verification that the hard protective coating remains efficient....." has been replaced by ....that the corrosion prevention system remains efficient....". in a number of paragraphs (such as , for instance, Z 7.1, 4.2.3.1 a) ; Z 10.2 4.2.3.3 ; ), in line with IMO Res.A744(18).

2 - However, a corrosion prevention system is defined, in the same UR Z's and in IMO Res.A744(18) , as being either a full hard protective coating or a full hard protective coating supplemented by anodes.

3 - The above would mean that the survey of the anodes is a classification matter.

4 - However, whereas coating conditions are defined as good or fair or poor, there are no criteria in the IACS URs and IMO Res. A744(18) for the anodes condition.

5 - Assessing the anodes condition to confirm that they "remain efficient" looks to BV to be a quite difficult task for the ships in service Surveyor.

6 - Member's view and interpretations on the following would consequently be appreciated:

- do Members consider that the above requirements in IACS URs imply that survey of anodes is part of the classification ?
- do Members consider that the above requirements in IMO Res. A 744 (18) imply that survey of anodes is mandatory?
- if yes, what is the acceptance criteria to conclude that the anodes" remain efficient" ?

3.2 The majority of GPG Members replied that they did not include requirements for anodes in their class rules.

LR / ABS / DNV / KR / NK / RINA / RS were of the view that the condition of any anodes fitted should be recorded for information purposes as the survey of anodes is neither a classification matter nor a mandatory requirement in IMO A.744(18) and has no impact on future surveys (5037\_LRa). [Note; LR further clarified that "Whilst I agree that the performance of anodes is not normally a class matter LR does require that as part of Special Survey on oil tankers : "The attachment to the structure and condition of anodes in tanks are to be examined ." Therefore we cannot say that 'the survey of anodes is not a classification matter'. 5037\_LRb]

However, GL said that “for GL, anodes are a matter of class and as such are subject to plan approval as well as surveys. In case of missing or worn-out anodes we issue a condition of class”(5037\_GLa&b).

CCS advised that its rules have a general requirement relating to anode survey, which is only conducted, through sampling, during construction, docking survey or where there is a definite requirement for the survey of ballast tanks.

NK proposed that the following footnote be added to Z7s and Z10s:  
“The survey of anodes is not a classification matter.” No majority support was achieved.

#### **4. Conclusion**

RINA suggested to simply amend the definition of "Corrosion Prevention System" in paragraph 1.2.9 of UR Z7 (and, of course, the paragraphs in all the other UR Zs containing the definition of "Corrosion Prevention System") in order to eliminate any reference to anodes. This proposal would leave room for Societies willing to include additional class requirements for anodes to do so in their Rules.

GPG agreed.

### **RINA proposed amendments to paragraph 1.2.9 of UR Z7 and corresponding paragraphs in all other UR Zs (5037\_RIb, 6 April 2005)**

#### 1.2.9 Corrosion Prevention System

A corrosion prevention system is normally considered ~~either: a full hard protective coating, or~~  
~~1 a full hard protective coating, or~~  
~~2 a full hard protective coating supplemented by anodes.~~

Hard protective coating is usually to be epoxy coating or equivalent. Other coating systems may be considered acceptable as alternatives provided that they are applied and maintained in compliance with the manufacturer's specifications.

Where soft coatings have been applied, safe access is to be provided for the surveyor to verify the effectiveness of the coating and to carry out an assessment of the conditions of internal structures which may include spot removal of the coating. When safe access cannot be provided, the soft coating is to be removed.

[Annex: Council Chair's conclusive message.](#)

6 May 2005  
Permsec

## **Annex. (5037\_ICb, 15 May 2005)**

To : All IACS Council Members  
c.c : Mr. R. Leslie, IACS Permanent Secretariat

Ref. Mr G-Y. Han's message IAa dated 6 May 05  
Message ICa dated 6 May 05  
Admiral R.E. Kramek's message ABb dated 13 May 05

Paris La Défense, 15 May 05

- 1 - All Members have agreed with the texts attached to Mr Han's message.
- 2 - Further to ABS comments the reference to anodes is to be deleted in Annex I and in tables IX (IV) and IX(II).
- 3 - further to ABS questions regarding what IACS plan to do regarding IMO and A.744(18) further to IACS deletion of reference to anodes from the UR Z7's and UR Z10's it is to be noted that:

The Item 1.2.9 in UR Z10.1 and relative items in these URs states  
*1.2.9 10 Corrosion Prevention System: A corrosion prevention system is normally considered either:*

- .1 a full hard protective coating, or*
- .2 a full hard protective coating supplemented by anodes.*

*Hard Pprotective Ccoating is to usually to be epoxy coating or equivalent. Other coating systems may be considered acceptable as alternatives provided that they are applied and maintained in compliance with the manufacturer's specification.*

*Where Soft Coatings have been applied, safe access is to be provided for the surveyor to verify the effectiveness of the coating and to carry out an assessment of the conditions of internal structures which may include spot removal of the coating. When safe access cannot be provided, the soft coating is to be removed.*

- therefore the anodes are not considered as the main means of protection against the corrosion It is only a supplement;
- there is no provision in UR Z7's and Z10's to evaluate the level efficiency of the anodes;
- there is no specific requirements in case of lack of efficiency of the anodes.

The experience has shown that ballast tanks only protected by anodes are subject to corrosion when the anodes are becoming less efficient.

The anodes are active only when immersed by sea water. Therefore the upper part of the ballast tanks are not protected when the ballast is full of water and the ballast is not protected when it is empty..

The ships operators are reluctant to replace the anodes especially in upper part which request fitting of scaffolding fo welding the anode supports to the structure.

[The above arguments justify the reasons why IACS consider that the anodes are not class item.](#)

[4 - These arguments can be used by IACS Members](#) attending the WG bulk carriers at MSC 80 to try to obtain deletion of the reference to anodes in A. 744(18).

Best regards,

Bernard Anne  
IACS Council Chairman.

## **Technical Background**

**UR Z10.1(Rev.13, Jan 2006)**

**UR Z10.2(Rev.18, Jan 2006)-separate TB**

**UR Z10.3(Rev.8, Jan 2006)**

**UR Z10.4(Rev.3, Jan 2006)**

**UR Z10.5(Rev.2, Jan 2006)**

**Part 1. Z10s – para. 1.4 and 7.1.3**

**Part 2. Z10s – para. 5.5.4 and 5.5.6**

**Survey Panel Task 22 – Amend applicable URZ7s and Z10s to align Close-Up Survey and Thickness measurements to be carried out at the same time and location allowing for a more structured control of the thickness measurement process.**

**Technical Background**

**Z7(Rev.12)**

**Z7.1(Rev.3)**

**Z10.1(Rev.13, para.1.4 & 7.1.3)**

**Z10.2(Rev.18, para. 1.4 & 7.1.3)**

**Z10.3(Rev.8, para. 1.4 & 7.1.3)**

**Z10.4(Rev.3, para. 1.4 & 7.1.3)**

**Z10.5(Rev.2, para. 1.4 & 7.1.3)**

**1. Objective**

To amend the applicable URZ7s and Z10s to align Close-Up Survey and Thickness measurements to be carried out at the same time and location allowing for a more structured control of the thickness measurement process.

**2. Background**

IACS QC findings, through audits of numerous Societies, which indicated concerns over Surveyor attendance and control of thickness measurement processes.

**3. Methodology of Work**

Survey Panel members through correspondence.

**4. Discussion**

To align Close-up survey requirements and thickness measurements in the applicable URZ7s and URZ10s, in accordance with PR19, all Panel members agreed through correspondence and a final vote at the fall Survey Panel meeting, that URZ7, Z7.1, Z10.1, Z10.2, Z10.3, Z10.4 and Z10.5 should include in the applicable sections of the noted URs as proposed by the Survey Panel the wording “ In any kind of survey, i.e. special, intermediate, annual, or other surveys having the scope of the foregoing ones, thickness measurements of structures in areas where close-up surveys are required, shall be carried out simultaneously with close-ups surveys.”

**5. Implementation**

The Survey Panel is of the view that the Members need 12 months from the adoption date to implement these amendments into their class rules. Assuming that GPG and Council approve to the amendments, the Survey Panel would propose January 2007 as an implementation date.



## **Technical Background**

**UI SC 191 (Rev.2, Oct 2005)**

**&**

**UR Z10.1 (Rev.13, para.5.5.4 and 5.5.6, Jan 2006)**

**UR Z10.2 (Rev.18, para. 5.5.4 and 5.5.6, Jan 2006)**

**UR Z10.3 (Rev.8, para.5.5.4 and 5.5.6, Jan 2006)**

**UR Z10.4 (Rev.3, para.5.5.4 and 5.5.6, Jan 2006)**

**UR Z10.5 (Rev.2, para.5.5.4 and 5.5.6, Jan 2006)**

### **1. Objective**

- to confirm whether the guidelines for approval/acceptance of alternative means of access (now REC91, ex Annex to UI SC191) is mandatory or non-mandatory.
- to consider other safety related proposals.

### **2. Background**

The DNV proposal to submit the UI SC191(Rev.1, May 2005, Annex 1) to IMO DE49 triggered a number of discussion points that led to amendments to the following resolutions:

UI SC191(Rev.2)  
New REC 91  
REC 39(Rev.2)  
UR Z10s

### **Points of Discussion**

3. Is the Annex to UI SC191(Rev.1, May '05, guidelines for approval / acceptance of alternative means of access) mandatory or non-mandatory ?

Answer: Non-mandatory. Hence, re-categorized as new REC 91.

4. Limitation of use of rafts in bulk carrier holds

DNV proposed that conditions for rafting should be limited to areas, such as anchorage or harbour, where swell conditions are limited to 0.5m. After discussion, GPG approved the ABS' alternative proposal to use the swell condition as a basis to determine the appropriateness of rafting, instead of geographic areas(harbours or anchorage). 5.5.4 of Z10.2 refers.

RINA proposed that para 5.5.4 should be included in all the Z10s. NK's objection is recorded as follows (3037hNKq, 29/08/2005):

1. With regard to RIm of 26 August 2005, NK considers that the proposed amendment to 5.5.4 should be limited to UR Z10.2.
2. Rafting survey for tankers are actually carried out on the open sea from a discharge port to a loading port and in such situation the rise of water within the tanks would always exceed 0.25m. It is different situation from rafting survey for hold frames of bulk carriers normally conducted in a harbour or at an anchorage.
3. If the same requirement applies to tankers, any rafting survey for cargo oil tanks and ballast tanks of tankers would be prohibited. This is not practicable under present survey procedure for tankers.
4. Therefore, NK can not support Laura's proposal that the proposed amendment to 5.5.4 of UR Z10.2 is introduced into the other URs and new Recommendation.

For compatibility with the IMO's mandatory requirements\*, GPG decided to add the same amendment to all the UR Z10s.

\*

- Appendix 4 to MEPC.99(48) 'Mandatory requirements for the Safe Conduct of CAS Surveys'
- MSC.197(80) – amendments to A.744918), Annex A for DSS and SSS bulk carriers and Annex B for single and double hull oil tankers.

As a consequence, 5.5.1 of REC 91(ex Annex to UI SC191) was also amended:

- to remove the reference to dynamic /sloshing (as the 0.25m rise was considered negligible);
- to refer to the rafting conditions contained for cargo holds in Z10.2 and Z10.5 and for oil cargo tanks in Z10.1 and Z10.4.

5. Means of access from longitudinal permanent means of access within each bay to rafts

GPG reviewed the proposal that the following text be added to Z10s:

[A means of access to the longitudinal permanent platform from rafts or boats is to be fitted in each bay.](#)

(Technical Background: for the safety of surveyors)

There may be ships which are arranged in accordance with para b, page 8 of the Annex to the current SC 191 (i.e., no means of access from the LPMA in each bay to a raft is required) and therefore could not be rafted if the sentence proposed by RINA ("[A means of access to the longitudinal permanent platform from rafts or boats is to be fitted in each bay](#)") is included in the Z10's.

GPG therefore agreed not to include this sentence in Z10s.

For the same reason, the same sentence was not added to Rec.39.

Finally, GPG added the following sentence to UI SC191(interpretation for II-1/3-6):

*A permanent means of access from the longitudinal platform to the water level indicated above is to be fitted in each bay (e.g permanent rungs on one of the deck webs inboard of the longitudinal permanent platform).*

## **6. Implementation**

It was agreed that the revised UI SC191 be implemented to ships contracted for construction 6 months after adoption by Council.

UI SC191 was also edited in line with IMO MSC/Circular. 1176, leaving its mandatory language (is/are to, shall) unchanged.

(Note: UI SC191(Rev.2) makes references to the following new Recommendations:

- REC 90: Ship Structure Access Manual
- REC 91: Guidelines for approval/acceptance of Alternative Means of Access)

23 September 2005  
Permanent Secretariat  
Updated on 13 Oct 2005.

**Survey Panel Task 11 – Unified Periodic Survey Requirements related to SOLAS  
Reg. XII/12 & Reg. XII/13.**

**Technical Background**  
**Amendments to UR Z10.2(Rev.19, Jan 2006) and UR Z10.5 (Rev.3, Jan 2006)**

### 1. Objective

To amend UR 10.2 Section 2.6 and 3.4 and UR Z10.5 Section 2.6 and 3.3 to include survey requirements related to SOLAS reg. XII/12 and XII/13.

### 2. Background

This task was originally discussed during the WP/SRC annual meeting which took place at DNV Headquarters on the 26<sup>th</sup> to 28<sup>th</sup> October 2004; it was subsequently recorded under paragraph 9 “any other business” of the minutes of this meeting.

While the SOLAS Reg.XII/12 (hold, ballast and dry spaces water level detectors) and XII/13 (availability of pumping systems) retroactive requirements for existing bulk carriers have entered into force on 1<sup>st</sup> July 2004, as required by IMO Res.MSC.134(76), the IACS UR S 24 has been deleted on 1<sup>st</sup> January 2004. In addition, SOLAS does not include any periodical survey requirements for such detection systems and pumping systems.

### 3. Methodology of Work

Survey Panel members through correspondence.

### 4. Discussion

Survey Panel member from BV raised this issue at the February 2005 Survey Panel meeting and volunteered to propose amendments to the applicable URs for Panel members to review and comment on through correspondence. At the Fall meeting of the Survey Panel, it was agreed upon by all Panel members that the proposed amendments for UR Z10.2 and Z10.5 as applicable, which were proposed by BV were acceptable.

### 5. Implementation

The Survey Panel is of the view that the Members need 12 months from the adoption date to implement these amendments into their class rules. Assuming that GPG and Council approve to the amendments, the Survey Panel would propose January 2007 as an implementation date.

Submitted by Survey Panel Chairman  
4 Nov 2005  
approved on 31 Jan 2006 (5031fICa)

**Survey Panel Task 43 – Amend the applicable sections of the URs to address the requirements for substantial corrosion in the Common structural rules.**

**Technical Background**

**(UR Z10.2, Rev.22, June 2006)**

**(UR Z10.4, Rev.4, June 2006)**

**(UR Z10.5, Rev.4, June 2006)**

**1. Objective**

Amend applicable sections of the URs to address the requirements for substantial corrosion in the Common structural rules.

**2. Background**

Due to the different application of substantial corrosion in the CSR from the current Unified Requirements.

**3. Methodology of Work**

Panel members discussed the proposed revisions through correspondence up to the Spring Panel meeting where final amendments were agreed upon for submittal to the IACS Hull Panel for review.

**4. Discussion**

After much discussion between all Panel members at the March 2006 Survey Panel members, a unanimous decision was reached as to the wording of CSR Substantial corrosion in UR Z10.2, 10.4, and 10.5 in section 1.2.9 and was then submitted to the Hull Panel for review and approval. The hull panel concluded that the Survey Panel definition for CSR substantial corrosion was not entirely accurate and recommended further amendments to clarify the actual requirements. The new definition was then circulated to the Survey Panel for a final review and was unanimously agreed upon.

**5. Implementation**

The Survey Panel is of the view that the Members need 12 months from the adoption date to implement these amendments into their class rules/procedures. Assuming that GPG and Council approve the amendments, the Survey Panel would propose **July 2007** as an implementation date.

Submitted by Survey Panel Chairman

## **Technical Background**

### **UR Z10.1 (Rev.14), UR Z10.2 (Rev.23), UR Z10.4 (Rev.5) & UR Z10.5 (Rev.5)**

#### **Survey Panel Task 3 – Maintenance of Alignment/ Compatibility of IACS URs and IMO survey requirements**

##### **1. Objective**

Maintenance of alignment/compatibility of IACS URs and IMO survey requirements regarding resolution MSC 197(80) – amendments to A744(18)

##### **2. Background**

IMO survey requirements to ESP vessels as amended in A744(18) as noted in MSC 197(80), with an implementation date of 1 January 2007.

##### **3. Methodology of Work**

Survey Panel members through correspondence.

##### **4. Discussion**

Survey Panel members, at the fall 2006 Survey Panel meeting, finalized the amendments to the applicable URs due to changes adopted at MSC(80).

Additionally, Members noted that URZ10.4 paragraphs 2.2.3.1 and 4.2.2.2 does not require examination of ballast tanks adjacent to heated fuel tanks, as required by MSC197(80). The survey panel agreed that if this is the position that IACS would like to take regarding double hull tankers, then it should be brought to the attention of IMO at the next IMO meeting, DE50 in March 2007.

##### **5. Implementation**

The Survey Panel is of the view that the Members need 12 months from the adoption date to implement these amendments into their class rules. Assuming that GPG and Council approve the amendments, the Survey Panel would propose January 2008 as an implementation date, although the IMO implementation date is January 2007.

Submitted by Survey Panel Chairman  
9 January 2007

##### **GPG discussion**

All members agreed to omit the requirement of examination of ballast tanks adjacent to heated fuel tanks, as required by MSC197(80), from URZ10.4 for double hull tankers and

that it should be brought to the attention of IMO at DE50. In addition ABS proposed that paragraphs relating to similar requirements in URZ10.1 should also be deleted for consistency and this was agreed by members.

Members also made a number of minor/editorial corrections to the text prior to their approval of the revised documents.

Added by Permanent Secretariat  
23 April 2007

## Technical Background Document

### UR Z10.5 (Rev.6 April 2007) & UR Z10.2 (Rev.24 April 2007)

*(Survey Panel Task 10 – Develop survey requirements for void spaces of ore carriers)*

#### **1. Objective:**

Develop survey requirements for void spaces of ore carriers

#### **2. Background**

DNV requested at WP/SRC Annual meeting October 2004 to develop survey requirements void spaces of ore carriers. See the attached document « Ore Carriers, Hull Survey Requirements » for easy reference. NK submitted a « A case study on a certain Ore Carrier » dated 22 October 2004 for this purpose.

#### **3. Discussion**

The task has been carried out by a Project Team chaired by DNV Survey Panel member and with Survey Panel members from BV, LR, NK and RINA.

The Project Team drafted new amendments to Unified Requirement UR Z 10.5 « Hull Surveys of Double Skin Bulk Carriers » using the same principles contained in the survey requirements of UR Z10.1 for ballast spaces of single hull oil tankers with appropriate adjustments recognizing that void spaces do not carry ballast water.

In that respect, a new TABLE I/Sheet 2 was developed to cover the minimum requirements for close-up surveys at special hull surveys of ore carriers. The existing TABLE I, renamed TABLE I/Sheet 1, was made applicable to double skin bulk carriers excluding ore carriers.

Accordingly, TABLE III/Sheet 3 (REQUIREMENTS FOR EXTENT OF THICKNESS MEASUREMENTS AT THOSE AREAS OF SUBSTANTIAL CORROSION OF DOUBLE SKIN BULK CARRIERS WITHIN THE CARGO LENGTH AREA) was renamed STRUCTURE IN DOUBLE SIDE SPACES OF DOUBLE SKIN BULK CARRIERS INCLUDING WING VOID SPACES OF ORE CARRIERS.

In addition, Sheets 15 and 16 of URZ10.2 Annex II are to be removed.

The draft amendments to UR Z10.5 were presented to the Survey Panel members on the 13th-15th September 2006 meeting at ABS Headquarters in Houston and were finally agreed by all members on the 22nd September 2006.

#### **4. Implementation**

The Survey Panel is of the view that the Members need 12 months from the adoption date to implement these amendments into their class Rules/procedures. Assuming that GPG and Council approve the amendments by the end of 2006, the Survey Panel would propose as an implementation date for surveys commenced on or after the **1 July 2008**

**Submitted by Survey Panel Chairman  
22nd March 2007**

#### **Permsec note (May 2007):**

Revisions adopted by GPG 12 April 2007 (5031hIGg).

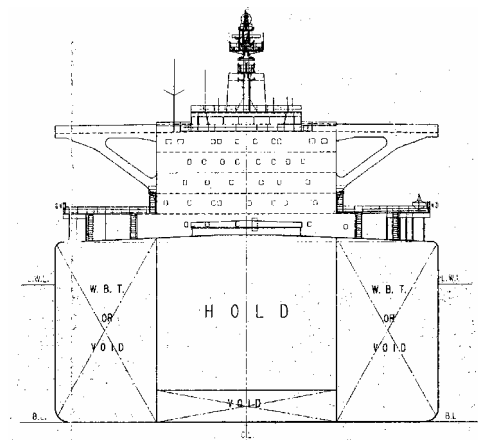


**Attachment:**

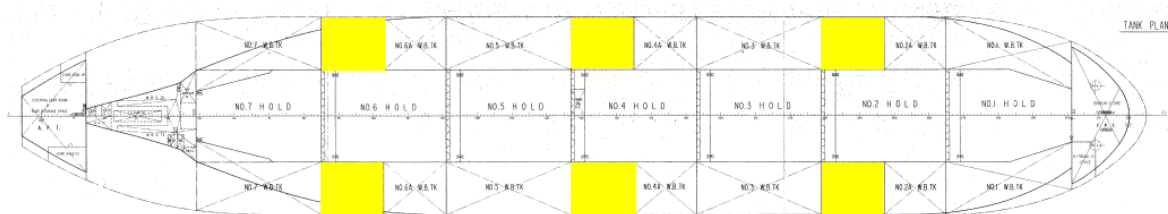
**Ore Carriers, Hull Survey Requirements**

"Ore carrier" means a single deck ship having two longitudinal bulkheads and a double bottom throughout the cargo region and intended for the carriage of ore cargoes in the centre holds only. Side tanks are generally arranged for the carriage of water ballast.

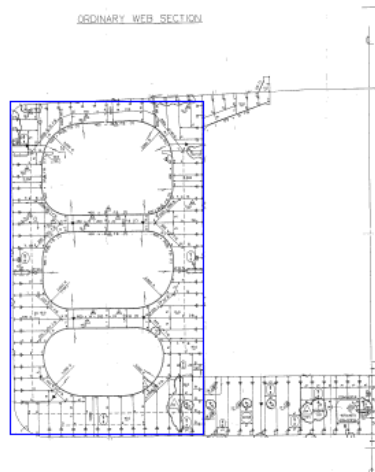
In accordance with UR Z10.5, for close-up surveys of side ballast tanks of ore carriers, the survey requirements of side ballast tanks for oil tankers as given in UR Z10.1 apply.



However, the amount of ballast water required to meet draught requirements for navigation / harbour operations, are generally less than the total capacity of the side tanks. Hence ore carriers are often designed with several side tanks as void spaces.



The internal structures are generally as for side ballast tanks with transverse web frame rings. The protective coating, if any, may be less durable than coating applied for ballast tanks and the void spaces are exposed to corrosion.



Ore carriers are generally large sized vessels and the overall survey of side void spaces may not be sufficient in order to carry out a meaningful survey for detection of corrosion and other structural defects.

**It is proposed to consider minimum requirements for close-up surveys for side void spaces. Requirements given in UR Z10.1 applicable to side cargo tanks may be used as basis.**

DNV 2004-10-19

## **Technical Background**

### **UR Z10.5, Rev. 7 (July 2007) - Amendment to Table II**

#### **Survey Panel Task 1 – Annual Review of Implementation of IACS Resolutions**

##### **1. Objective**

Maintenance of alignment/compatibility of IACS URs and IMO survey requirements.

##### **2. Background**

This proposed change was raised by the DNV Survey Panel member due to inconsistencies found in the UR Z10s.

##### **3. Methodology of Work**

Survey Panel members through correspondence.

##### **4. Discussion**

The DNV Survey Panel members raised the issue of alignment of TM requirements for vessels falling under the Z10s, where at Renewal Survey#2, TM was required for selected wind and water strakes outside the cargo area, except for vessels under UR Z10.5. All Survey Panel members agreed to the inconsistency and further agreed to the proposed changes.

##### **5. Implementation**

The Survey Panel is of the view that the Members need 12 months from the adoption date to implement these amendments into their class rules. Assuming that GPG and Council approve to the amendments, the Survey Panel would propose July 2008 as an implementation date.

Submitted by Survey Panel Chairman,  
25 June 2007

#### **Permanent Secretariat note (July 2007):**

Adopted by GPG with an implementation date of 1 July 2008 on 14 July 2007 (ref. 7596\_IGb).

## **Technical Background**

**URs Z7(Rev.15), Z7.1(Rev.5), Z7.2(Rev.1), Z10.1(Rev.15),  
Z10.2(Rev.26), Z10.3(Rev. 9), Z10.4(Rev.6), Z10.5(Rev.8) – November  
2007**

### ***Survey Panel Task 1 – Annual Review of Implementation of IACS Resolutions***

#### **1. Objective**

To review IACS Resolutions annually and discuss or propose amendments as deemed necessary.

#### **2. Background**

This proposed amendment to all URZ7s and URZ 10s was raised by the Panel member from DNV due to Owners crediting tanks concurrently under intermediate and special survey.

#### **3. Methodology of Work**

Survey Panel members through correspondence.

#### **4. Discussion**

The Panel member from DNV raised the issue of Owners having the ability of crediting spaces and thickness measurements only once in a 54 month interval, due to the availability of concurrent crediting of spaces and thickness measurements due to the flexible time window that is currently allowed between the intermediate survey and the special survey.

After a presentation and discussion lead by the DNV Panel member, all Survey Panel members agreed to the argument given by DNV, and further agreed to make the necessary changes in all URZ7s and URZ10s where Owners are not allowed to concurrently credit surveys and thickness measurements of spaces.

#### **5. Implementation**

The Survey Panel is of the view that the Members need 12 months from the adoption date to implement these amendments into their class rules. Assuming that GPG approve to the amendments, the Survey Panel would propose January 2009 as an implementation date.

Submitted by Survey Panel Chairman  
22 October 2007

**Permanent Secretariat note (December 2007):**

During GPG discussion DNV proposed that *“since this matter will be discussed between Owner and Class mainly in connection with the forthcoming Special Survey, DNV would prefer to locate this text, not only as part of Intermediate Survey, but also as a new text for the Special Survey.”* This was supported by BV, ABS, RINA and KR.

The revised documents were approved, with DNV’s proposal and an implementation date of 1 January 2009, on 15 November 2007 (ref. 7690\_IGb).

## Technical Background

### URs Z7(Rev.16), Z7.1(Rev.6), Z7.2(Rev.2), Z10.1(Rev.16), Z10.2(Rev.27), Z10.3(Rev.11), Z10.4(Rev.7) and Z10.5(Rev.9) - March 2009

#### Survey Panel Task 62:

- A) *Harmonization of UR Z10.1, Z10.2, Z10.4 and Z10.5 with UR Z10.3 with respect to items 5.5.4.4 and 5.6.2.*
- B) *Harmonization of UR Z7, Z7.1, Z10.1, Z10.2, Z10.3, Z10.4 and Z10.5 with UR Z7.2 with respect to the definition of the corrosion prevention system and with respect to the footnote 1 related to semi-hard coatings.*
- C) *Harmonization of the definition of Ballast Tank in UR Z7(Rev.14)*

### 1. Objective

- A) Amend the texts of items 5.5.4.4 and 5.6.2 in Unified Requirements Z10.1, Z10.2, Z10.4 and Z10.5 in order to align them with those in UR Z10.3, in which they were changed while performing Task 55, whereas in the other UR Z10s they were kept unchanged on the grounds that this change was out of the scope of Task 55.
- B) Amend the definition of “Corrosion Prevention System” and include a Footnote 1 related to semi-hard coatings in Unified Requirements Z7, Z7.1, Z10.1, Z10.2, Z10.3, Z10.4 and Z10.5 in order to align them with those adopted in UR Z7.2, when this new UR was issued.
- C) Amend UR Z7 (Rev. 14) in all items where the term “Ballast Tank” is used in order to get them harmonized with the definition itself.

### 2. Background

The task, as regards item A), was triggered by a Member Society, while performing Task 55, on the grounds that this part was out of the scope of the task and then should have been dealt with in a separate task.

The task, as regards item B), was triggered as a consequence of the “New Business action item 2” of the Minutes of the September 2008 Survey Panel meeting, for sake of harmonization of the various URZs.

The task, as regards item C), was triggered as a consequence of the “Task 54-Examination of Double Bottom Ballast Tanks at annual surveys” of the Minutes of March 2008 Survey Panel meeting, for sake of harmonization of the definition of Ballast Tank in UR Z7(Rev.14).

### 3. Discussion

The task was carried out by correspondence. All the amended texts for the affected URs were prepared by the Survey Panel Member who had chaired the PT on Task 55, in accordance with the Form A approved by GPG. In addition to the objectives outlined in the Form A, an amendment was added to item 1.3.1 of UR Z10.2 and UR Z10.5 in which the reference 3.2.3.6 in the last item of the list was replaced by 3.2.3.10 as can be correctly verified in the text.

The amended URs were circulated to all Survey Panel Members for review, comments and agreement. The texts of the URs were unanimously agreed by all Members.

#### **4. Implementation**

The Survey Panel is of the view that the Member Societies need at least 12 months from the adoption date to implement these amendments into their class rules/procedures. Therefore, in the first version of all amended URs the following implementation sentence should be proposed:

*Changes introduced in Rev .xx are to be uniformly applied by Member Societies and Associates for surveys commenced on or after [not less than 12 months after the adoption by GPG/Council].*

Since it is common practice and convenience to have implementation dates either on 1<sup>st</sup> January or on 1<sup>st</sup> July of the year, the Survey Panel proposes the 1<sup>st</sup> July 2010 as implementation date, if GPG/Council approve the URs not later than 30 June 2009.

**Submitted by Survey Panel Chairman  
28 February 2009**

#### **Permanent Secretariat notes (April 2009):**

1. The amended URs were approved by GPG on 18 March 2009 (ref. 7718bIGd).
2. During the typesetting process it was noted that para 5.1.5 of UR 7.2 was inconsistent with the amended URs and so following consultation with the Survey Panel this was also amended at this time.
3. Regarding the implementation date, GPG agreed to use 1<sup>st</sup> July 2010 provided that it was consistently used for the amended URs.

## Technical Background for UR Z10.5 Rev.10 (Mar 2011)

### 1. Scope and objectives

- 1) To amend UR Z10.4 to harmonize the definition of transverse section.
- 2) Update of references in the Executive Hull Summary Table IX.
- 3) Review IACS URZ10.5 to determine if there are issues which need to be addressed to ensure that the IACS survey regime and the CSRs are compatible.

### 2. Engineering background for technical basis and rationale

- 1) Based on that fact that bulk carriers and oil tankers have a transverse framing system applied for example on ship's sides etc. and that UR Z7 is applied to all types of ships and includes an extended definition of transverse section it is necessary to unify this definition in UR Z10s.
- 2) Update of references in the Executive Hull Summary Table VII such that the introduction of extended annual surveys is noted in the 'Memoranda' section rather than under 'Conditions of Class'.
- 3) Some requirements in CSRs for Bulk Carriers were relevant to ships in operation and it was decided to move them from CSRs to UR 10.5 in more consistent way.

### 3. Source/derivation of the proposed IACS Resolution

CSR, IACS UR Z7.

Proposed amendments to UR Z10.5 are based on internal discussion of IACS which is always striving to produce consistent and compatible rule requirements.

### 4. Summary of Changes intended for the revised Resolution:

- 1) The following additional text is added to the definition of transverse section in para 1.2.6:

*"For transversely framed vessels, a transverse section includes adjacent frames and their end connections in way of transverse sections."*

- 2) In the Executive Hull Summary Table VII (iv) the reference to part G) is updated to part H) as per Table VII (ii).
- 3) The main amendment has consisted in removing the requirements found in the CSRs related to surveys after construction and locating them in the applicable sections of UR Z10.5. The rationale of that is to have only one place where survey requirements are given and avoid any duplication of requirements in different documents, which would give rise to problems of maintenance and alignment.

Another important amendment has been the requirement for annual examination of the identified substantial corrosion areas for bulk carriers. One Member Society was



## Part B

of the opinion that there should be no difference between the CSRs and non-CSRs bulk carriers. The other Member Societies were of the opinion to consider an alternative examination, which was the original requirement in CSRs, and thus the following text was adopted in UR Z10.5:

"For vessel built under IACS Common Structural Rules, the identified substantial corrosion areas may be:

- a) protected by coating applied in accordance with the coating manufacturer's requirements and examined at annual intervals to confirm the coating in way is still in good condition, or alternatively
- b) required to be gauged at annual intervals."

Other important amendments have been made moving the following items from the CSRs to Z10.5 as applicable:

- a) the paragraphs regarding the different corrosion patterns, such as pitting corrosion, edge corrosion and grooving corrosion, and their different acceptance criteria,
- b) the items regarding the number and locations of thickness measurements, together with the associated table and referenced figures.

Another notable change has been introduced in the "ANNEX II - Recommended Procedures for Thickness Measurements" of UR Z10.5, which, however, are only recommendatory and not mandatory, where thickness measurements forms specific to CSRs double skin bulk carriers have been produced in addition to the existing ones, which only apply to non-CSRs ships.

Finally, for CSRs bulk carriers the requirement has been introduced which stipulates that "the ship's longitudinal strength is to be evaluated by using the thickness of structural members measured, renewed and reinforced, as appropriate, during the special surveys carried out after the ship reached 15 years of age (or during the special survey no. 3, if this is carried out before the ship reaches 15 years) in accordance with the criteria for longitudinal strength of the ship's hull girder for CSRs bulk carriers specified in Ch 13 of CSRs".

### **5. Points of discussions or possible discussions**

See item 4 above.

### **6. Attachments if any**

None.

## **Technical Background for UR Z10.5 Rev.11, July 2011**

### **1. Scope and objectives**

Review the requirement for repairs within IACS UR 7 and UR 10 series, in particular the requirement for Prompt and Thorough Repair, with a view to developing wording that would permit a temporary repair and the imposition of a Recommendation/ Condition of Class under specific and controlled circumstances, and in accordance with PR35.

### **2. Engineering background for technical basis and rationale**

There are instances, for example a localised, isolated and very minor hole in a cross-deck strip, at which a suitable temporary repair, for example by welding or doubling, and the imposition of a suitable short term Recommendation/ Condition of Class for permanent repair at a later date, are considered very adequate methodology for dealing with the defect.

Current IACS Requirements in the UR Z7 and Z10 series, for Prompt and Thorough repair, would not permit this to be an option, the defect would have to be permanently Promptly and Thoroughly repaired, which might require removing cargo, moving to a repair berth and staging inner spaces.

Under the Requirements of IACS Procedural Requirement PR 35 the methodology of Temporary Repair and imposition of a suitable short term Recommendation/ Condition of Class for permanent repair at a later date is fully permissible.

### **3. Source/derivation of the proposed IACS Resolution**

Based upon discussion within the IACS Survey Panel.

### **4. Summary of Changes intended for the revised Resolution:**

Following the definition of Prompt and Thorough Repair in the Unified Requirement, a new paragraph is proposed to be added:-

"1.3.3 Where the damage found on structure mentioned in Para. 1.3.1 is isolated and of a localised nature which does not affect the ship's structural integrity, consideration may be given by the surveyor to allow an appropriate temporary repair to restore watertight or weather tight integrity and impose a Recommendation/Condition of Class in accordance with IACS PR 35, with a specific time limit."

Also, Table I was split to into 2 tables for enhanced clarity, Table I.1 for Single Skin and Table I.2 for Double skin ships and miscellaneous editorial errors in the Table I.1 and I.2 are corrected.

### **5. Points of discussions or possible discussions**

a) The points of discussion are as indicated in Sections 2 and 4 above.

b) Discussion took place on whether to prepare this amendment as a Unified Interpretation of IMO Resolution A.744(18)/UR Z7 and Z10 series, finally it was agreed to make direct amendment to the relevant URs.

c) It is proposed that this amendment be submitted directly to the IMO DE/MSC Committees for consideration of amending directly IMO Res. A744(18)

**6. Attachments if any**

None

## **Technical Background for UR Z10.5 Rev.12 May 2012**

### **1. Scope and objectives**

To clarify the SSH No. 2 requirement of Table I regarding close-up surveys.

### **2. Engineering background for technical basis and rationale**

N/A

### **3. Source/derivation of the proposed IACS Resolution**

N/A

### **4. Summary of Changes intended for the revised Resolution:**

The requirement for close-up surveys at SSH No.2 as contained in Table I was clarified to indicate that close-up survey of the "forward and aft transverse bulkheads including stiffening system in a transverse section including topside, hopper side and double side ballast tanks" only applied to the tanks on one side of the ship. This clarification is consistent with the requirements of IACS Z10.2 for single skin bulk carriers.

### **5. Points of discussions or possible discussions**

None

### **6. Attachments if any**

None

## **Technical Background for UR Z10.5 Rev.14, Jan 2014**

### **1. Scope and objectives**

- a) To consider appropriate text in IACS document regarding class period for lengthy conversions.
- b) To align the requirements in PR37 and UR Z10s regarding safe entry to confined spaces.

### **2. Engineering background for technical basis and rationale**

- a) As per the IMO Res. A1053 (27), lengthy conversions (not necessarily of major character) or other major repair work can be assigned for a 5 year period from the date of completion of conversion/repairs/surveys.
- b) Safety requirements in IACS PR37 can be applied to carry out survey in safe way for all kind of ships. When there are no indications about the safety of surveyor in UR Z10s then the requirements in PR37 shall be applied.

### **3. Source/derivation of the proposed IACS Resolution**

None

### **4. Summary of Changes intended for the revised Resolution**

- a) Following additional text was included to section 2.1.3 to clarify the class period for lengthy conversions

"In cases where the vessel has been laid up or has been out of service for a considerable period because of a major repair or modification and the owner elects to only carry out the overdue surveys, the next period of class will start from the expiry date of the special survey. If the owner elects to carry out the next due special survey, the period of class will start from the survey completion date."

- b) Existing Section 5.2.6 and 5.2.7 were deleted from UR Z10s since provisions of these sections were covered by PR37. Reference of PR37 was included in Section 5.2.1.1.

### **5. Points of discussions or possible discussions**

- i) Additional text to Para.2.1.3 was discussed in order to clarify class period.
- ii) Panel considered that safety of surveyors should be dealt by PR37.

### **6. Attachments if any**

None

**Technical Background Document**  
**UR Z 10.6 – New (June 2002), WP/SRC Task 82**

**Objective and Scope:**

- To develop enhanced survey requirements for Special Survey No.3 and subsequent surveys as a UR for general dry cargo ships carrying solid cargoes and having SOLAS Safety Construction Certificate other than:
  - .1 vessels subject to UR Z10.2;
  - .2 dedicated container carriers;
  - .3 ro-ro cargo ships;
  - .4 pure car carriers;
  - .5 refrigerated cargo ships;
  - .6 dedicated wood chip carriers;
  - .7 dedicated cement carriers.

**Source of Proposed Requirements:**

- WP/SRC developed UR Z10.6 through correspondence and two meetings during 2001. The first draft was prepared by LR using UR Z7 as the base document, but also taking into account consideration some of the requirements included in UR Z10.2
- The draft also took into account data held on dry cargo ships within the LR casualty database.

**Points of Discussion:**

1. WP/SRC has decided not to limit the development of enhanced survey requirements for these ship types to Special Survey No.3 and subsequent surveys, as it was considered technically sound to have a similar format of the survey requirements for these exposed ship types as for the other UR Zs.
2. WP/SRC discussed the need for a Survey Programme/Survey Planning Document and concluded not to include such a requirement.
3. WP/SRC further decided that a survey in dry dock is to be part of the Special Survey.
4. The proposed draft UR Z10.6 was unanimously agreed by WP/SRC.
5. TM Requirements for Special Survey No.3 & No.4 in Table II:
  - Item 4 of SS 3: “Within the cargo length, each deck plate outside line of cargo hatch openings”
  - Item 2(b) of SS 4: “Within the cargo length, each deck plate outside line of cargo hatch openings”

Council agreed to change Table II as shown above (1060dICb, 17 June 2002).

**Attached:** GPG Report to Council on Safety of General Cargo Ships (extracts)

Date of submission: 20 May 2002  
WP/SRC Chairman

## **GPG Report on Safety of General Cargo Ships**

### **Contents**

1. Introduction
2. Actions undertaken by GPG
3. GPG 49 decisions
4. Casualty Statistics

Annex 1. WP/SRC Task 82 Form A.  
Annex 2. WP/SRC Task 83 Form A.

### **1. Introduction.**

Following from the proactive initiative taken with respect to Bulk Carrier Safety, IACS Council focused attention on the safety of General Cargo Ships and published “General Cargo Ships Guidelines for Surveys, Assessment and Repair of Hull Structure” in May 1999. In association with this, an analysis of LR’s casualty Database was initiated by Council at the C39 Meeting and GPG were given the following terms of reference:

- if the analysis identifies the need for enhanced surveys this could be difficult to implement in view of the nature of this segment of the industry. Owners of bulk carriers and tankers were, to a degree, driven to accept the Enhanced Survey Program by external pressures. General cargo ship owners are different and will be much more difficult to persuade to expend additional fees on additional surveys.
- Council considered that a strategic approach was needed to the question of general cargo ship casualties and that IACS should learn from previous mistakes, talk to the industry (sector involved) and differentiate between the different types of general cargo ships. For example, container ships may not be a cause of concern. It was also reiterated that daily maintenance on board is the most important factor in mitigating general cargo ship maintenance and that members should be urging this upon owners.
- Council decided that a GPG Small Group undertake a preliminary assessment as already agreed at GPG 46, initialize the work in line with the established plan on the evaluation and analysis of the casualty data, and report its outcome in good time to C40.

## **2. Actions undertaken by GPG**

In pursuance of the C39 decision, a GPG Small Group was established and comprised representatives from ABS, BV, DNV, KR, LR, NK and IACS Secretariat. The Small Group has met twice, on 19 August 1999 in London and 12 October 1999 in Berlin, and the subject has been further discussed at GPG 47 and 48. The findings and recommendations of the Small Group, as endorsed by GPG, are given in this report.

Following GPG 47 and C 40 (December 1999), WP/SRC was tasked to, first, study means to identify ships carrying logs which are prone to extensive damage and rapid deterioration due to normal loading procedures and, second, to develop additional survey requirements for application at the periodical survey.

In addition, GPG submitted to Council 40<sup>th</sup> meeting a White Paper for WP/S describing the current status of general cargo ship safety issue, the need to develop a new UR for new log carriers with emphasis upon its political implications. As a consequence, Council tasked GPG to investigate steps regarding the construction of new ships carrying logs, based on the last paragraph of the White Paper which reads:

“To create classification rules for construction of new ships carrying logs as a special type would be a major commitment by IACS Members and Council’s views whether this is justifiable or not are requested by GPG.”

In the course of deliberations on this topic, GPG has gone through the following three steps for LR’s casualty data analysis:

- 1<sup>st</sup> tier analysis: high level analysis in long term trend for 18 years from 1980 – 1998 on all ship types of not less than 1,000 GT versus general cargo ships, tankers, bulk carriers and all ships other than general cargo ships to show both “first event non contact incidents” and “all incidents irrespective of causes” ;
- 2<sup>nd</sup> tier analysis: break down of casualty analysis of ships not less than 1,000 GT for ten years from 1998-1999 in three categories, i.e. hull failure, machinery/equipment failure, fire/explosion,
- third tier analysis: break down of casualty of all incidents from 1987-1998 for ships not less than 1,000 GT. This included analysis of narrative casualty data of the incidents of general cargo ships.

## **3. GPG 49 decisions (11-13, October 2000, Tokyo)**

The most recent benchmark for IACS actions taken was conclusions drawn at GPG 49 meeting which was held on 13-15 October 2000 in Tokyo, which are summarized hereunder:

The principles applied in the course of decisions made before and during GPG 49 was:

- strengthening survey requirements for general cargo ships



- grouping ships not only by age but by size, if new survey requirements are to be developed.

GPG discussed a scope of task to be given to WP/SRC, based on LR's statistical data embracing the first and second tier analysis and narrative of casualty data for the third tier analysis. LR's own conclusions are summarized underneath Fig. 9 of section 4 of this report (9/18 page). Against LR's view that there was no distinction between ship sizes and types for which new survey requirements might be developed, a general consensus was that certain type of ships are not prone to lack of maintenance problems as others, therefore, can be easily excluded. Consequently, it was decided to task WP/SRC to develop ESP requirements for Special Survey No.3 and subsequent surveys as a UR Z10.5 for cargo ships carrying solid cargoes and having SOLAS SC Certificate other than:

- vessels subject to Z 10.2;
- dedicated container carriers;
- ro-ro cargo ships;
- pure car carriers;
- refrigerated cargo ships;
- dedicated wood chip carriers;
- dedicated cement carriers,
- barges.

It should be noted that the target of this task has been specified to ships holding SOLAS Safety Construction (SC) certificate. GPG's desire was expressed for WP/SRC to have a fresh look at the target ship types and not extrapolate the ESP applicable to large ships.

The relevant WP/SRC Task 82 Form A is attached to this report as Annex 1, which will replace the previous WP/SRC Task 73 to identify *ships carrying logs* for additional survey requirements.

As a byproduct of this study, GPG also paid its attention to machinery failure including flooding incidents and decided that WP/SRC should be tasked to investigate whether additional survey requirements are necessary to address machinery failures and engine room flooding problems of *all types of ships*, with a view to an amendment to UR Z 7. The relevant WP/SRC Task 83 Form A is attached as Annex 2.

#### **4. Casualty Statistics (provided by LR for GPG 49 discussion)**

Lloyd's Register's Maritime Information Publishing Group (MIPG) maintains a casualty database which is comprised of information collected from multiple sources worldwide. However, this database is dependent on casualties being "reported". Experience over many years has shown that, in some parts of the world, there is a lack of reporting on casualties of small ships. It has been established that poor reporting on general cargo ships of less than 1000 GT would bias the "rate of risk" statistics and these have not been included in the analysis. There are about 7000 general cargo ships of less than 1000 GT. Thus, this leaves about 10,000 general cargo ships to be considered in the statistical analysis.

In order to establish the primary focus of the work it was decided to examine Actual Total Losses (ATLs) based on first event, non-contact (thus possible class related) ship casualty incidents for ships above 1000 GT. The results are shown in Figures 1, 2 and 3.

Figure 1 shows the average yearly ATL rate per 1000 ships at risk for each 5-year period from 1980 to 1994 for all ship types and general cargo ships. It shows a decreasing tendency from the first five years to the second five years and an almost imperceptible decreasing tendency for the next five-year period.

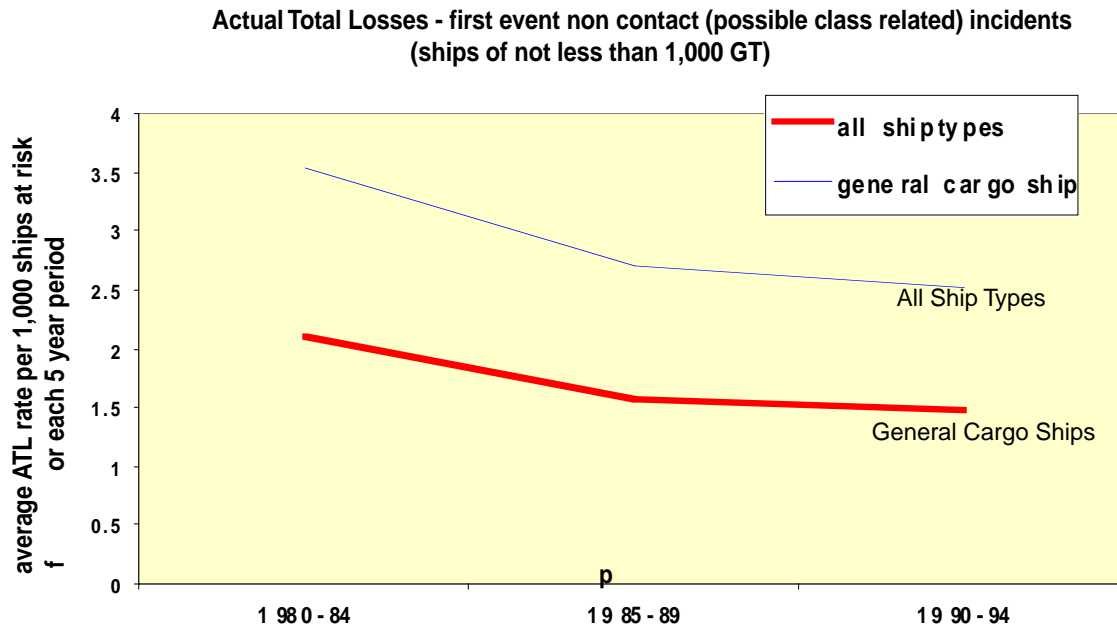


Figure 1

Figure 2 gives bar charts of an average yearly ATL rate per 1000 ships at risk for the entire 15-year period of the world fleet and the IACS fleet for all types and general cargo ships. There is no significant difference between the world fleet and the IACS fleet. Since the possible bias from non-reporting has been eliminated by exclusion of ships less than 1000 GT, the chart only indicates that IACS Members class the majority of the world fleet and that Members have an annual loss rate of about 26 general cargo ships.

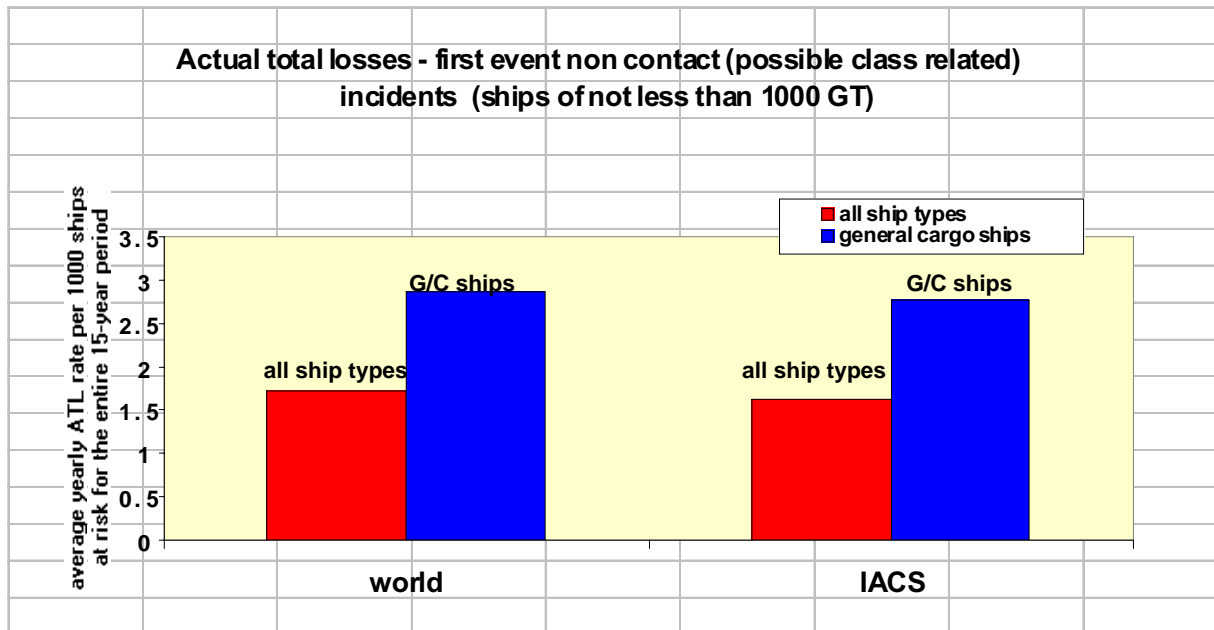


Figure 2

Figure 3 shows the average yearly ATL rate per 1000 ships at risk for the entire 15-year period in five yearly age blocks. There is a sharp increase of the ATL rate on the second age group (5-9 years) with a steady sharp increase to the age group of 15-19 years. A steady ATL rate of 4.5 ships per 1000 ships is shown for the age group of 15-19 years and above for general cargo ships. This chart establishes a direct relationship of increasing risk with a vessel's age and that general cargo ships are more at risk than other ship types.

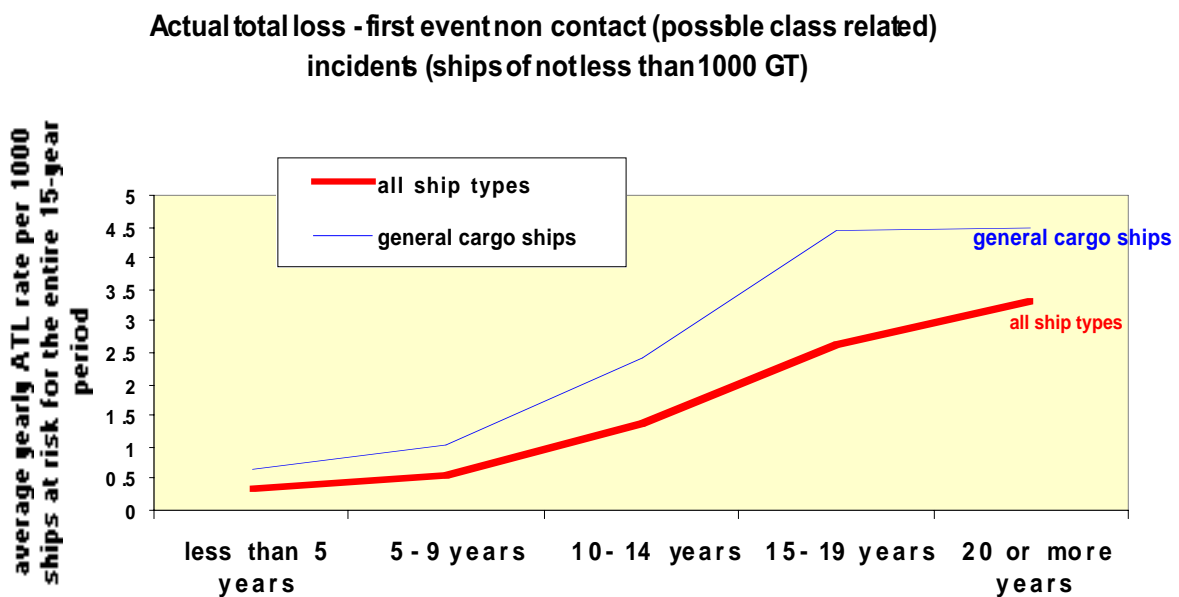
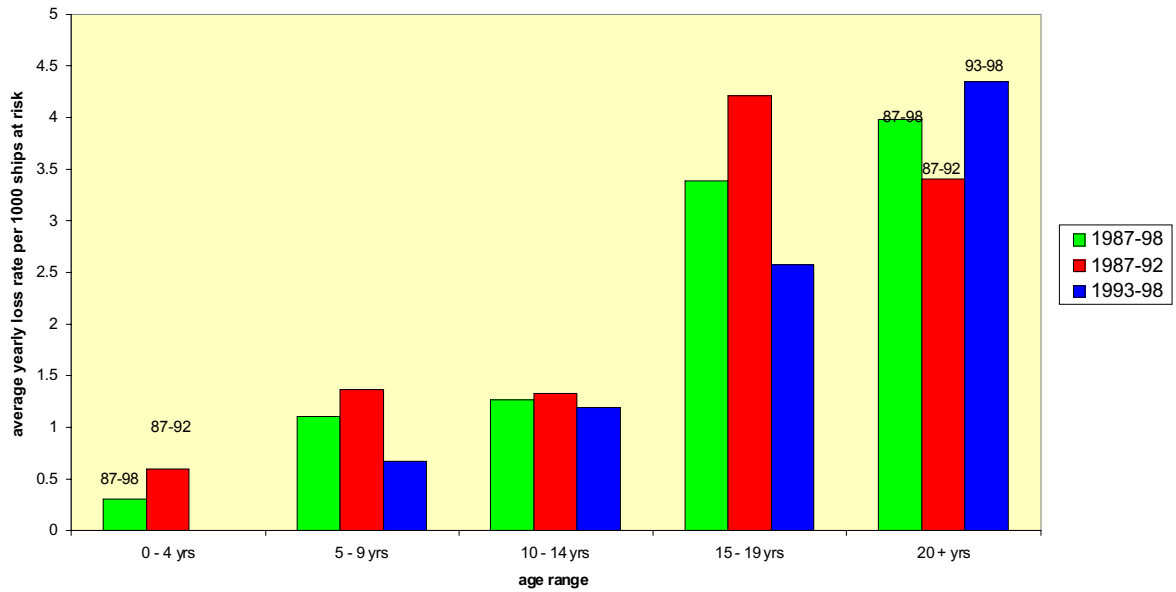


Figure 3

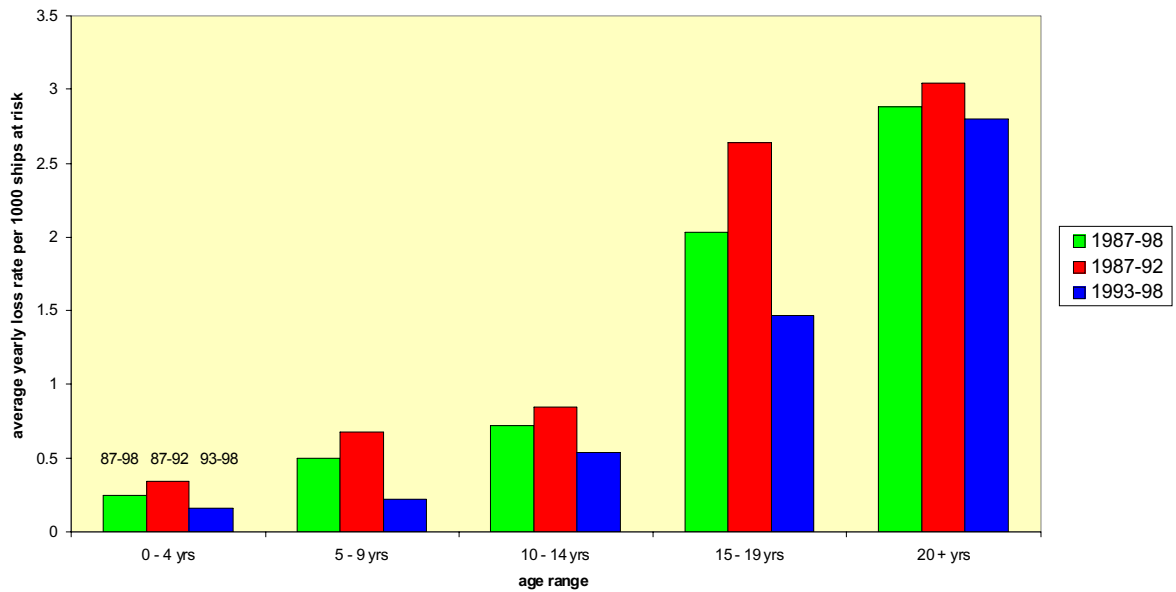
For comparative purposes the average yearly loss rates for various ship types are shown in the following figures, numbers 4 to 9:-

**General Cargo Ships - actual total losses (possible class related incidents)  
(ships of not less than 1000 GT)**



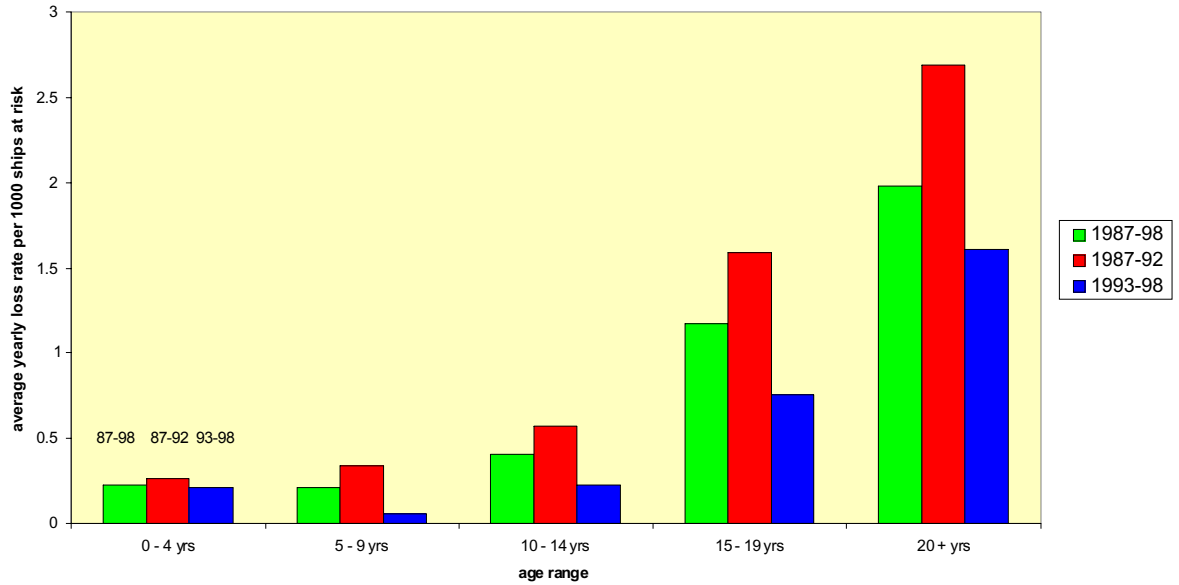
**Figure 4 - General Cargo Ships (greater than 1000 GT)**

**All cargo carrying ships - actual total losses (possible class related incidents)  
(ships of not less than 1000 GT)**



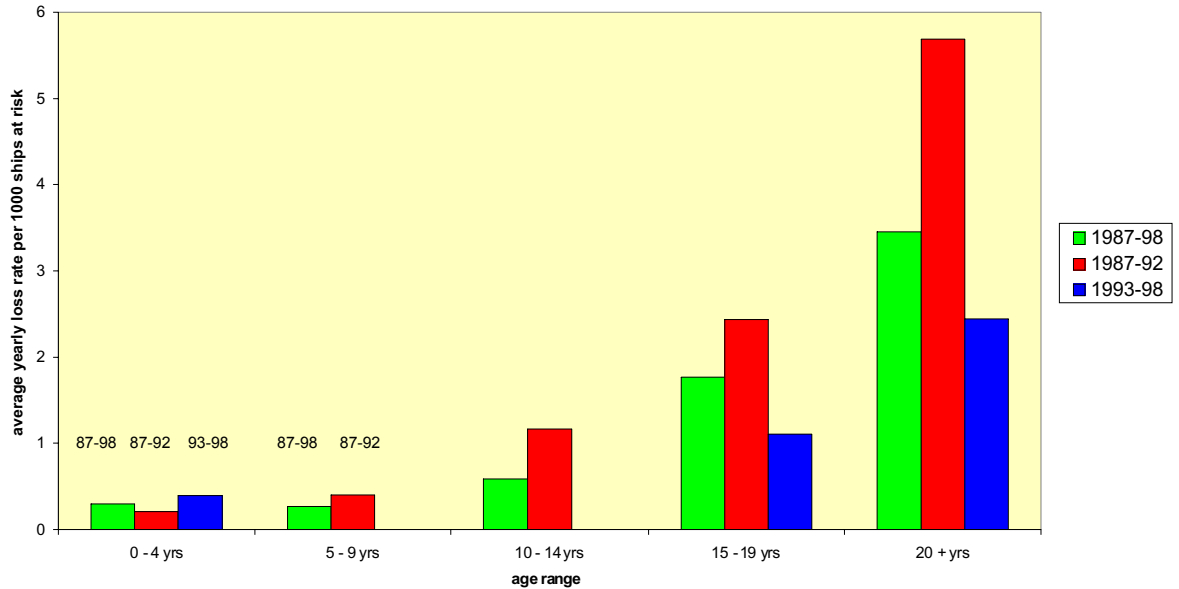
**Figure 5 - All cargo carrying ships**

**All cargo carrying ships (except General Cargo Ships) - actual total losses  
(possible class related incidents)  
(ships of not less than 1000 GT)**



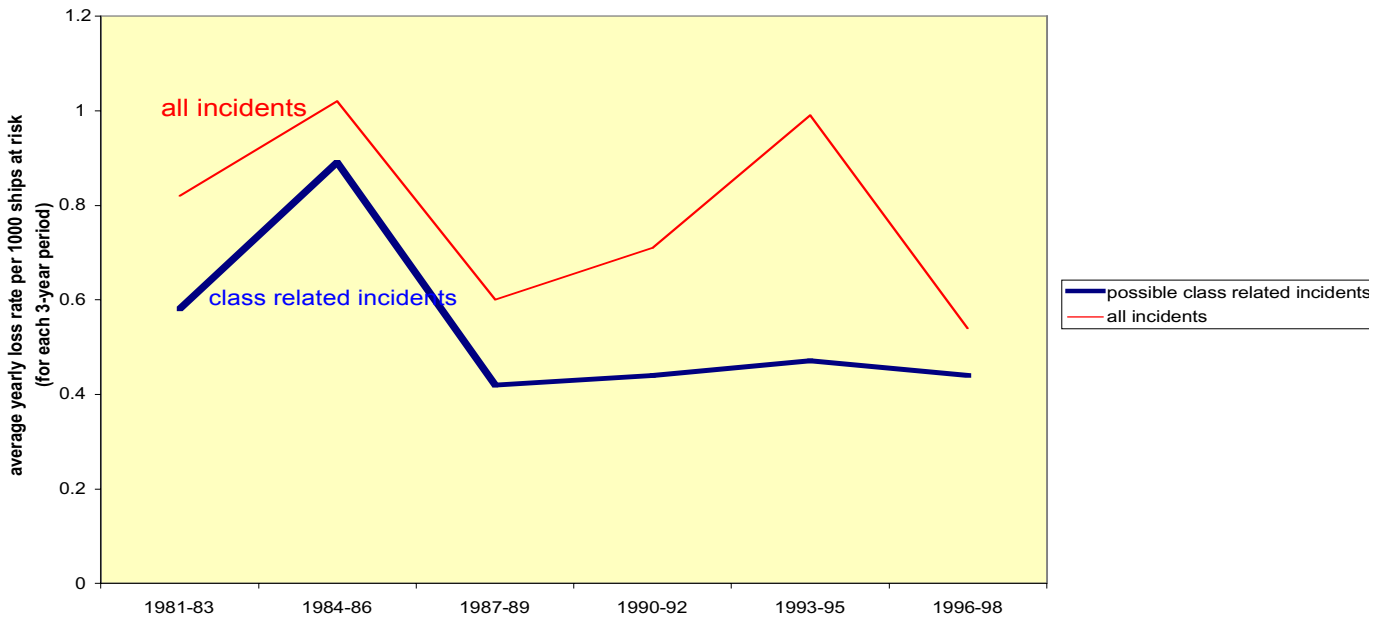
**Figure 6 - All cargo carrying ships (except general cargo ships greater than 1000 GT)**

**Carriers of bulk dry cargo (bulk carriers, etc.) - actual total losses  
(possible class related incidents)  
(ships of not less than 1000 GT)**



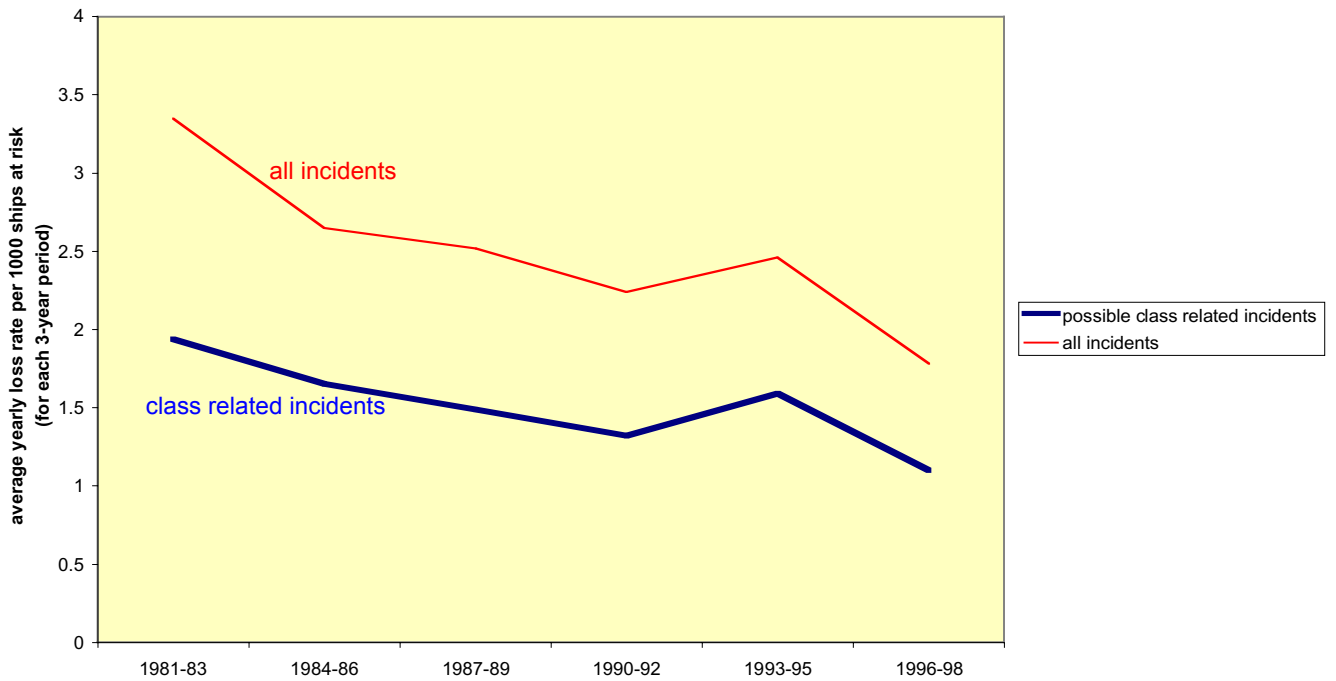
**Figure 7 - Bulk Carriers**

**Carriers of bulk liquid cargo (oil tankers etc.) - actual total losses  
(ships of not less than 1000 GT)**



**Figure 8 - Bulk liquid cargo carriers (tankers)**

**All ships - actual total losses  
(ships of not less than 1000 GT)**



**Figure 9 - All ships ATL**

In general, the foregoing figures indicate that general cargo ships have a loss rate of up to four times that of other cargo-carrying ships and nearly three times that of dry bulk carriers, the next most at risk group. In addition, although the loss rates for general cargo ships decreased steadily in the 1980's and early 1990's, there has been no corresponding decrease in the mid to late 1990's.

**This statistical evidence confirms the need for IACS action in respect of enhancing the existing hull survey regime for general cargo ships once they reach [10 or 15] years of age.**

However, in proposing an enhanced survey regime, it was also clear that a more detailed study of all the available casualty narrative texts could assist the determination of more precise survey requirements if these could be focused, where possible, on the root cause the reported incidents. A further objective of this third tier analysis was to identify, in as much detail as possible, any trends and/or key areas that could be addressed in the short and medium term to enhance the safety of general cargo vessels.

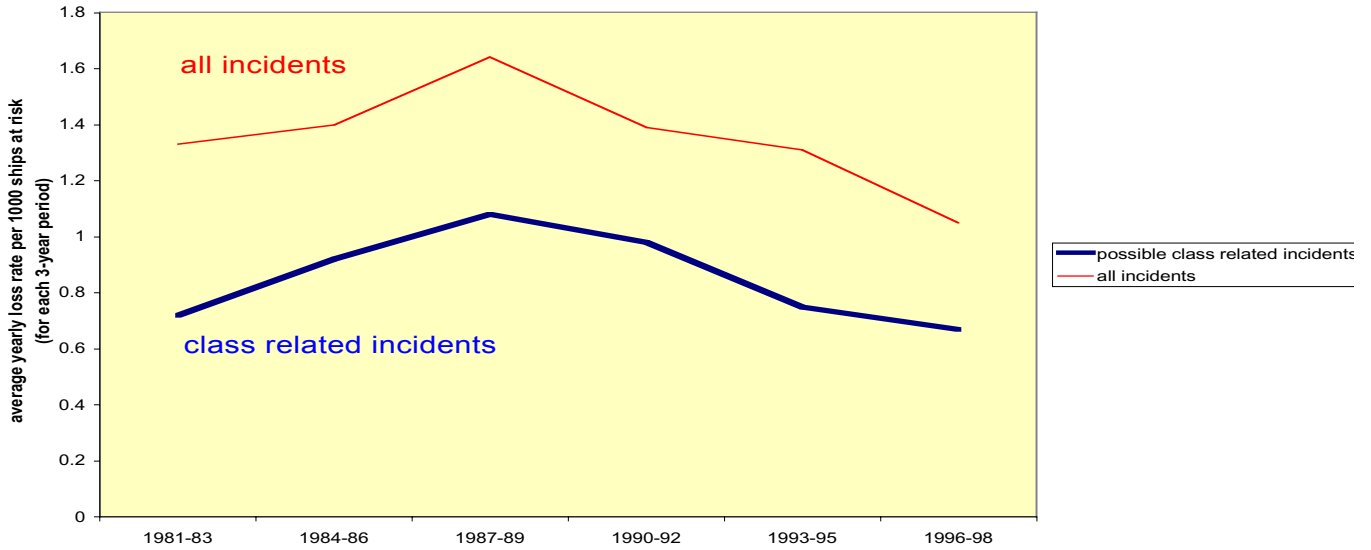
The available statistical data on general cargo ship incidents addresses 1942 incidents during the period between 1987 to 1998 during which the number of people killed or missing was reported as 1344. Further analysis of the data has indicated the following :

- (1) the age of a vessel is not the only factor when investigating the potential for serious vessel incidents to occur.
- (2) the nature of the key trends/areas identified are common to most vessel types.
- (3) three key areas need to be simultaneously addressed:
  - machinery/equipment failure
  - hull related incidents
  - fire/explosion incidents.
- (4) the integrity of main engines and their associated systems, the integrity of machinery spaces with respect to flooding and fire/explosion damage and the integrity of hull structures in the forepart of general cargo vessels all need to be urgently addressed.
- (5) increased survey requirements in the areas identified in (3) above need to be supported by both improved design criteria and an improved maintenance monitoring programme to be effective.

LR suggests that IACS should focus its attention in the three core areas identified and considers that an overall enhanced survey program for general cargo ships focused in this way is likely to be more effective in the short to medium term:-

The first tier analysis concentrated on ATLS and, as Figure 10 shows, the cause of the majority of ATL incidents may be associated with Class Related issues. Hull failure was also identified as a major area for further investigation with respect to ATLS.

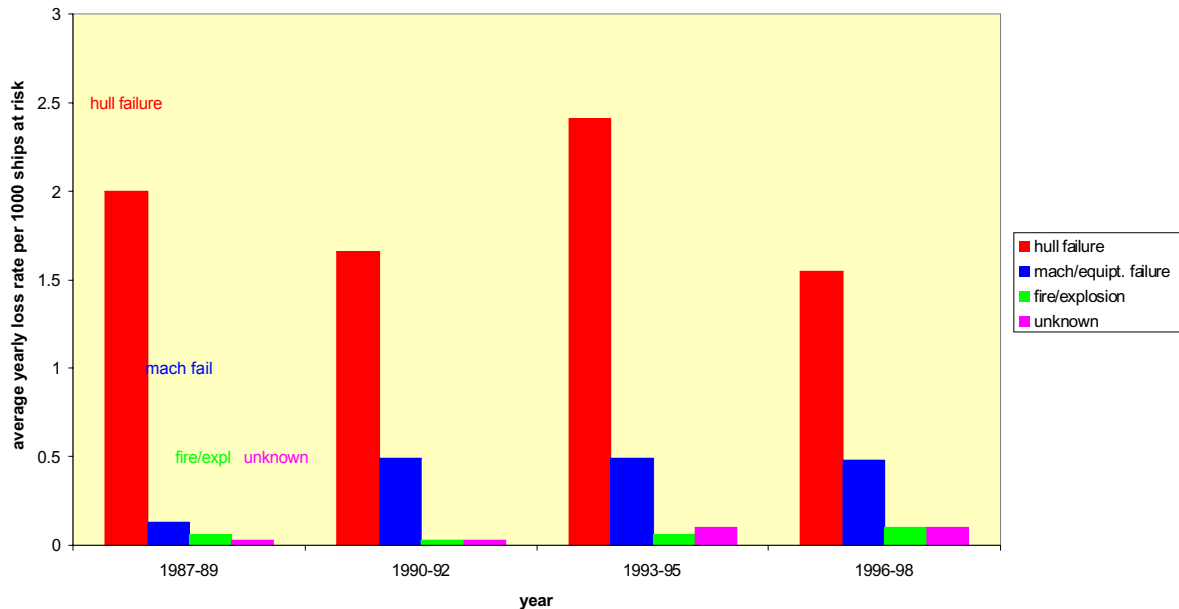
**All cargo carrying ships (except General Cargo Ships) - actual total losses  
(ships of not less than 1000 GT)**



**Figure 10**

The results of the second tier analysis also concentrated on ATIs and identified three primary areas to be addressed: hull failures, machinery/equipment failures and fire/explosion incidents. Figure 11 shows the relative proportion of such incidents in the data examined.

**General Cargo Ships - actual total losses (possible class related incidents)  
(ships of not less than 1000 GT)**



**Figure 11**

Unlike the previous studies the third tier study considered all the incident data that was reported. For those incidents where all the relevant facts have not been reported no assumptions have intentionally been made to identify the cause of the incident. Only the facts as report have been used. Unfortunately, the level of detail provided with the many of the



incident reports is such that any further analysis beyond that contained in this Report would be inconclusive.

In addition to further supporting the results of the ATL study, and despite the limitations of the data used, specific areas which need attention to enhance the safety of general cargo vessels were clearly identified.

Previous work on this subject suggested a direct link between incident rate and the age of a vessel. Figures (12) and (13) show the number of incidents for each vessel age group and the percentage of those incidents which resulted in an ATL. Total Losses have occurred across the full age profile, however, the percentage of CTLs and ATLs in each age group does increase as the vessel age increases and this confirms that vessel age is a contributing factor.

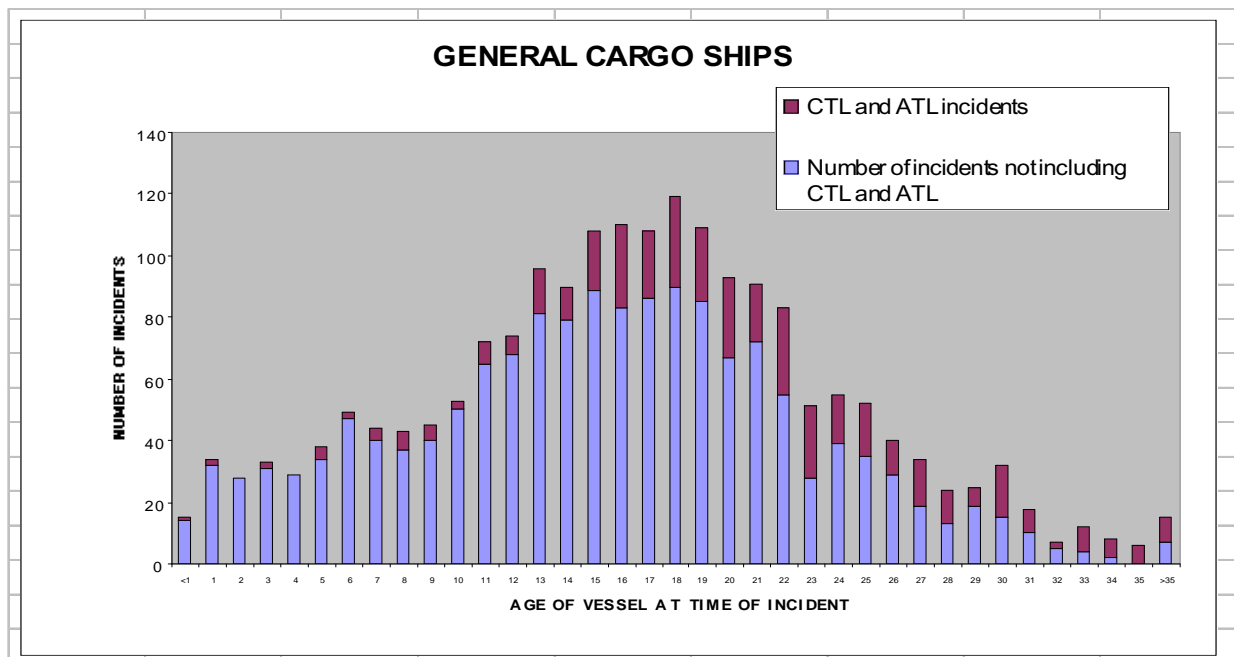
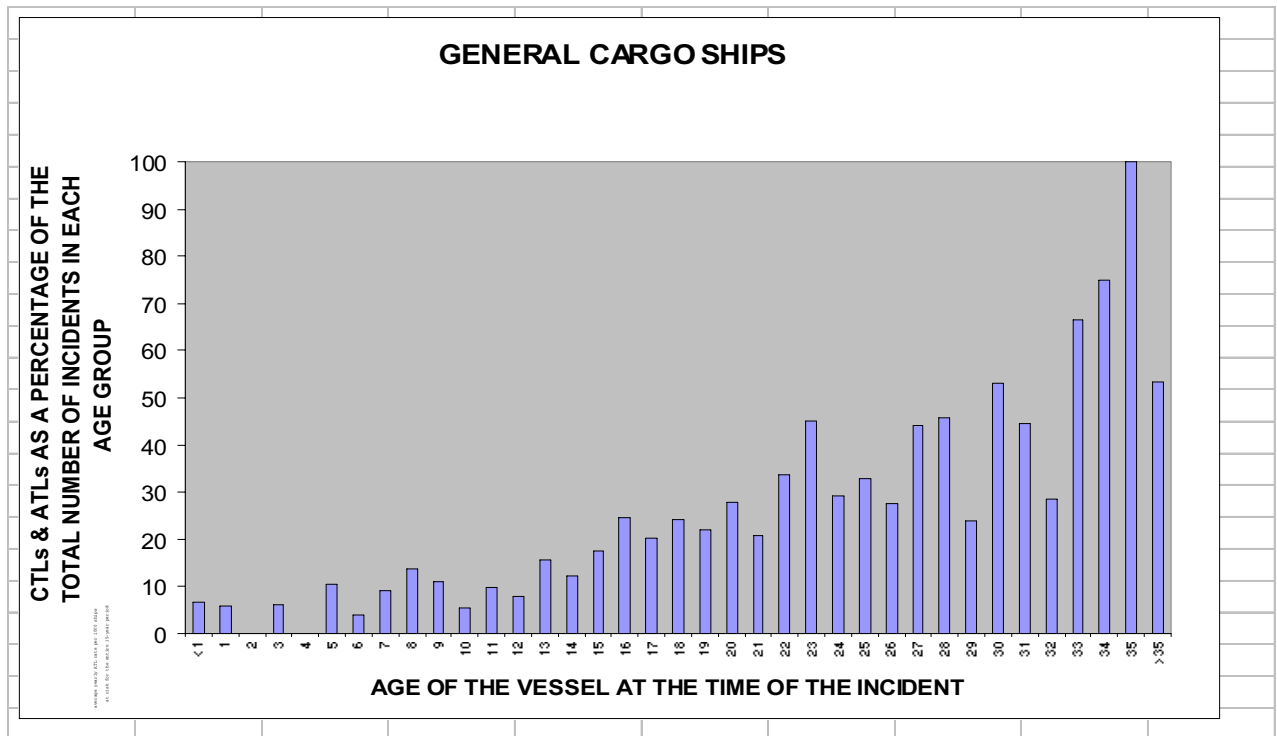
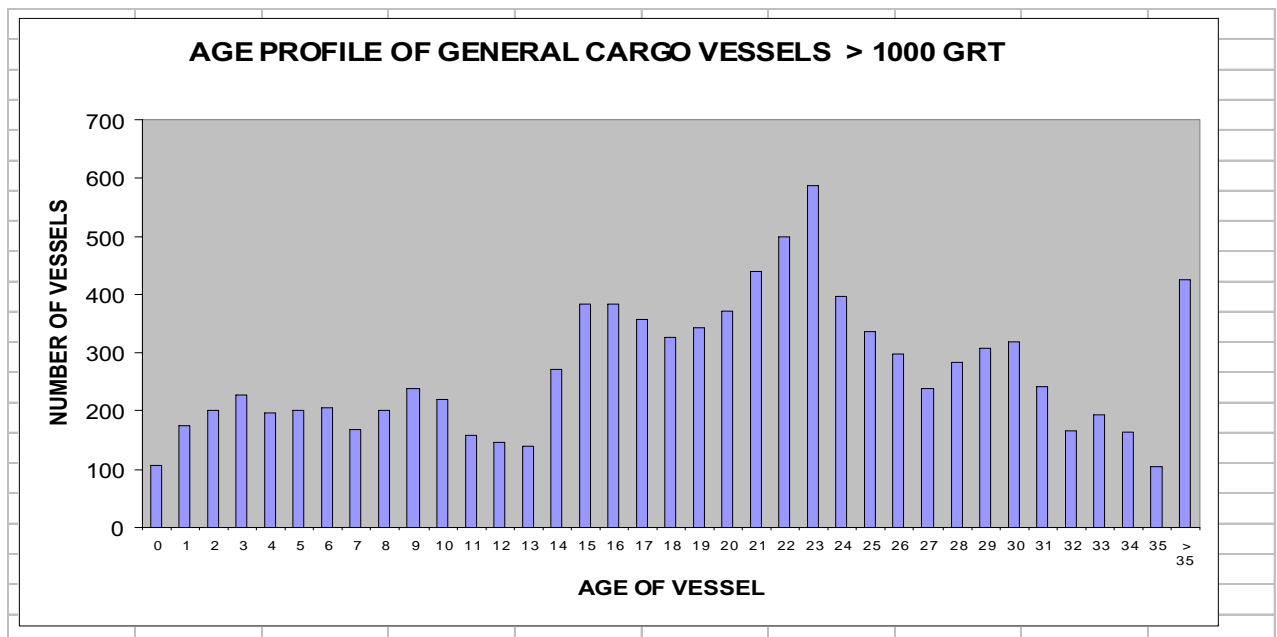


Figure 12



**Figure 13**

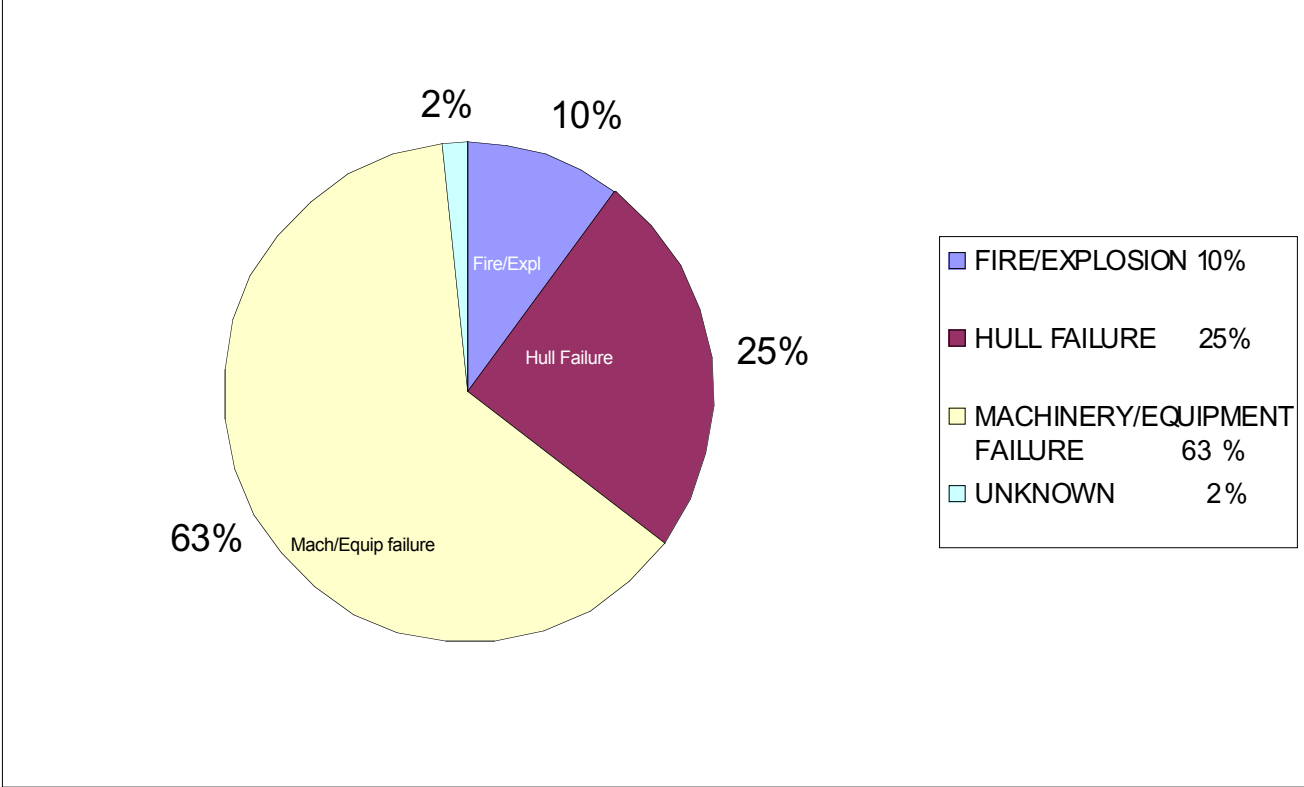
Figures (14A & 14B) reflect the general age profile of general cargo vessels worldwide. However, the results also indicate that serious incidents of a similar nature to those associated with total losses can occur on any vessel irrespective of the age of the vessel. These phenomena would suggest that other influencing factors such as vessel design, maintenance and operation are also direct contributing factors.



DEADWEIGHT	TOTALS			0-4 YEARS		5-9 YEARS		10-14 YEARS		15-19 YEARS		20-24 YEARS		25+ YEARS		COMPLETIONS	
	No.	Dwt	Age	No.	Dwt	No.	Dwt	No.	Dwt	No.	Dwt	No.	Dwt	No.	Dwt	No.	Dwt
499 or less	2 210	676 887	29	137	46 662	202	66 107	301	92 908	235	79 698	185	60 204	1 143	331 308	6	2 993
500 -	999	2 517	24	130	89 747	315	215 445	304	203 575	261	178 015	349	245 506	1 157	832 095	6	4 299
1 000 -	1 999	3 189	21	233	348 165	357	524 938	444	639 417	521	754 517	499	724 953	1 135	1 557 612	12	19 026
2 000 -	2 999	1 778	21	121	285 572	207	498 022	185	457 537	240	600 865	319	795 933	705	1 732 217	12	31 275
3 000 -	3 999	1 612	18	134	463 779	265	905 809	170	559 851	304	1 013 688	271	916 135	467	1 599 955	16	56 857
4 000 -	4 999	925	16	175	782 950	153	667 762	61	271 264	150	671 823	145	638 911	240	1 058 525	20	90 200
5 000 -	5 999	655	17	114	621 969	79	432 297	76	407 670	105	559 707	94	505 714	183	1 038 008	23	125 965
6 000 -	6 999	731	18	78	507 178	68	447 911	68	447 624	194	1 248 193	153	969 141	170	1 071 173	17	109 406
7 000 -	7 999	510	18	47	348 616	69	503 003	63	466 083	78	581 597	120	902 893	133	996 825	4	29 178
8 000 -	8 999	393	16	95	822 257	28	235 234	28	241 725	67	567 849	113	957 473	62	520 340	18	156 318
9 000 -	9 999	175	16	30	279 252	21	198 413	35	335 244	31	295 212	17	159 587	41	392 134	4	36 589
10 000 -	14 999	742	22	45	525 484	32	386 479	47	636 884	115	1 512 236	262	3 332 346	241	3 033 372	13	159 099
15 000 -	19 999	789	20	19	330 595	33	564 760	81	1 393 404	186	3 135 424	337	5 637 922	133	2 118 942	5	86 403
20 000 -	24 999	365	16	57	1 288 748	20	454 730	38	838 174	66	1 482 039	167	3 735 256	18	388 777	16	343 158
25 000 -	29 999	87	14	27	768 696	1	26 288	12	337 827	15	391 416	26	705 728	6	173 939	..	..
30 000 -	34 999	34	15	8	258 125	..	..	11	352 986	6	188 955	3	95 745	6	195 045	2	65 126
35 000 -	39 999	43	16	5	188 090	..	..	10	387 387	12	466 044	11	424 676	5	193 471	3	109 961
40 000 -	44 999	66	12	16	698 935	8	339 473	17	711 409	13	549 236	12	525 559	..	..	2	86 342
45 000 -	49 999	39	8	17	797 453	10	467 651	7	319 689	..	..	4	181 434	1	47 909	2	92 446
50 000 -	59 999	18	4	16	833 299	..	..	..	..	..	..	2	100 500	..	..	3	153 310
WORLD TOTALS	16 880	79 494	21	1 504	10 285 572	1 870	6 934 322	1 958	9 100 658	2 600	14 276 514	3 091	21 615 616	5 857	17 281 657	184	1 757 951

**Figure 14B**

The third tier analysis confirmed that the previously identified three key areas of concern are still valid. The variation of the relative weighting of each key area is shown in Figure (15), and although different from that seen in the second tier analysis, is indicative of the whole incident data base now being used. The important feature of this incident profile compared with previous profiles is the high frequency of reported machinery/equipment failures.



**Figure 15**

The third tier study focused on each of the above key incident areas.

**(1) Hull Related Incidents.**

The number of incidents associated with hull related issues are 488 compared with 1224 with machinery/equipment. The profile of hull related incidents are shown in the Figure (16). Heavy weather damage accounted for 204 incidents i.e. 42%. Of the majority of the 71 vessels reported lost (foundered/disappeared) no information on the cause of the incident was provided. This is also the case with the majority of the 53 incidents associated with flooding where details of the cause and/or the location of the flooded area were not provided. Of particular significance is the number of incidents associated with engine-room damage and hold damage. Figure (16) also indicates that the integrity of the bow structure, forepeak and forward holds are areas where improvements in structural integrity, inspection and maintenance programs are needed.

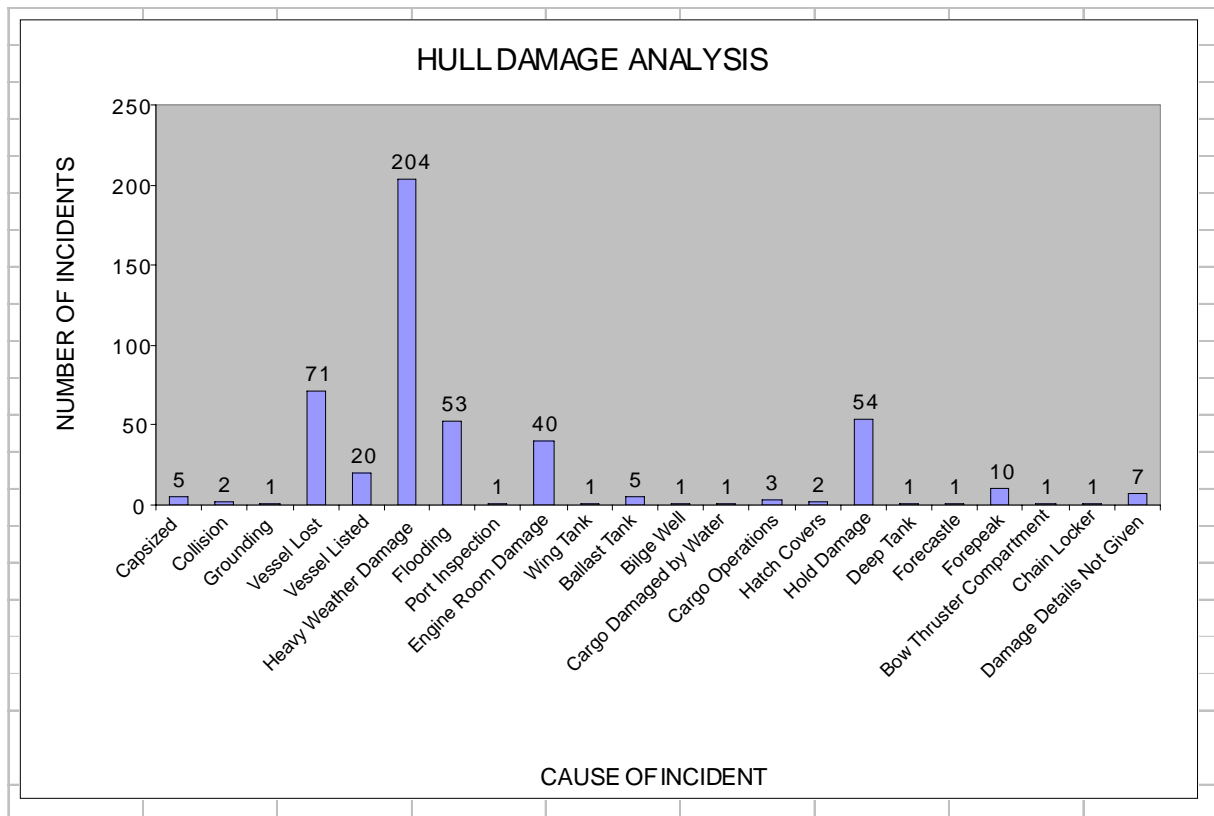


Figure 16

Figure (17) shows the profile of 204 hull-related incidents associated with heavy weather damage and again flooding, machinery and hold-related incidents predominate.

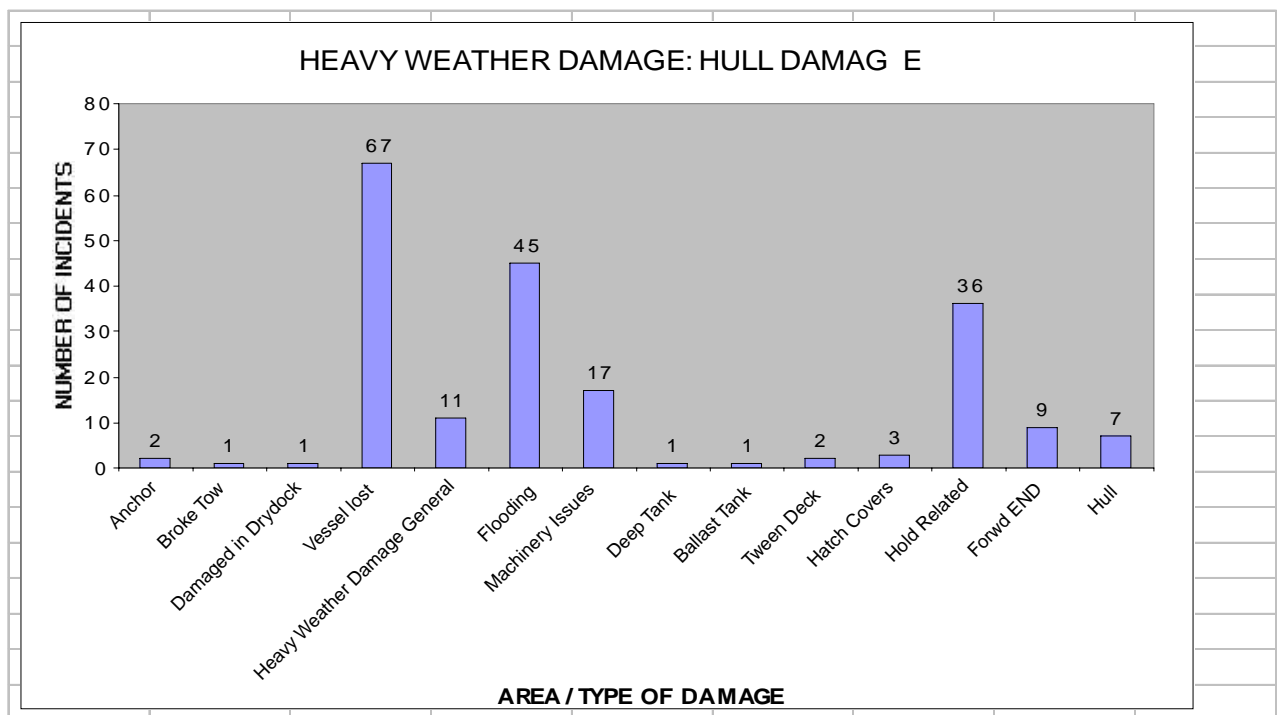
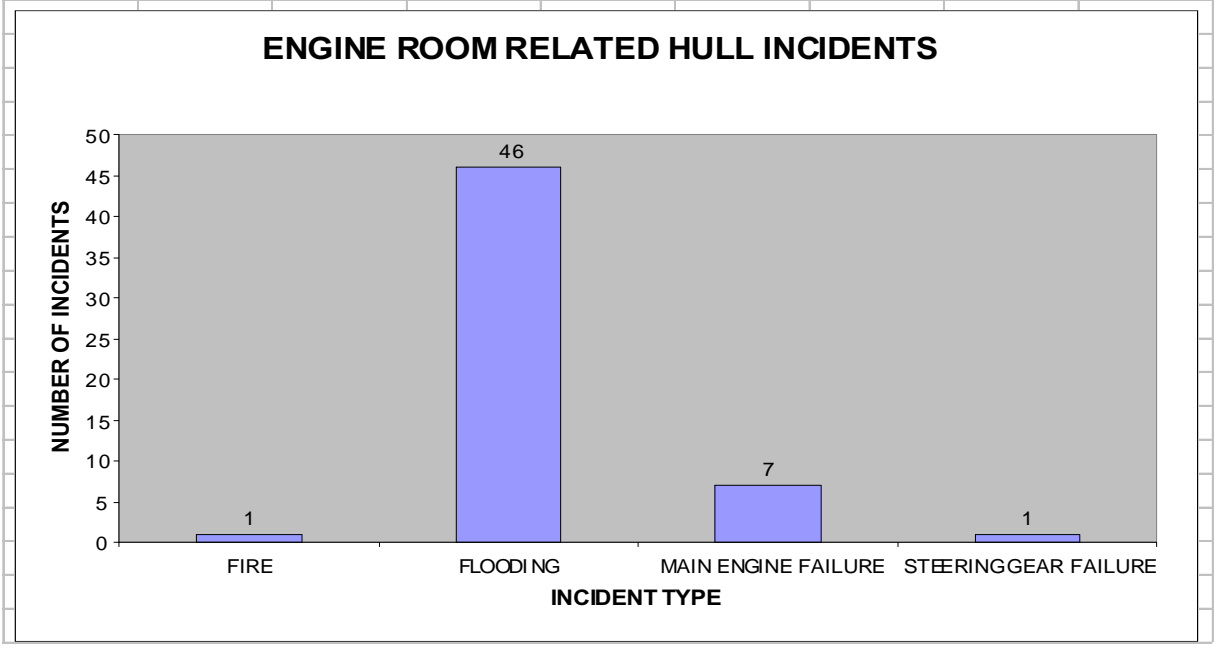


Figure 17

The majority of the engine room area hull related incidents were engine-room flooding (46) compared with 7 incidents associated with main engine failure. (see Figure 18) The available details relating to the flooding incidents, although limited, does suggest that the integrity of the engine room hull fittings and salt water cooling lines and the inspection of engine room load-line issues need to be better addressed.



**Figure 18**

The incidents associated with hold damage were examined in more detail. Of the 90 incidents reported 36 were associated with heavy weather conditions. The type and location of the hold damage (including heavy weather damage) is shown in Figure (19). Although there are 24 cases where the locations of the hold damage/flooding have not been given the remaining data clearly indicates that the frequency of hold damage/flooding is greater in the forward areas of the vessel. This trend is also seen when the hold damage incident data is re-examined without the heavy weather incident data.

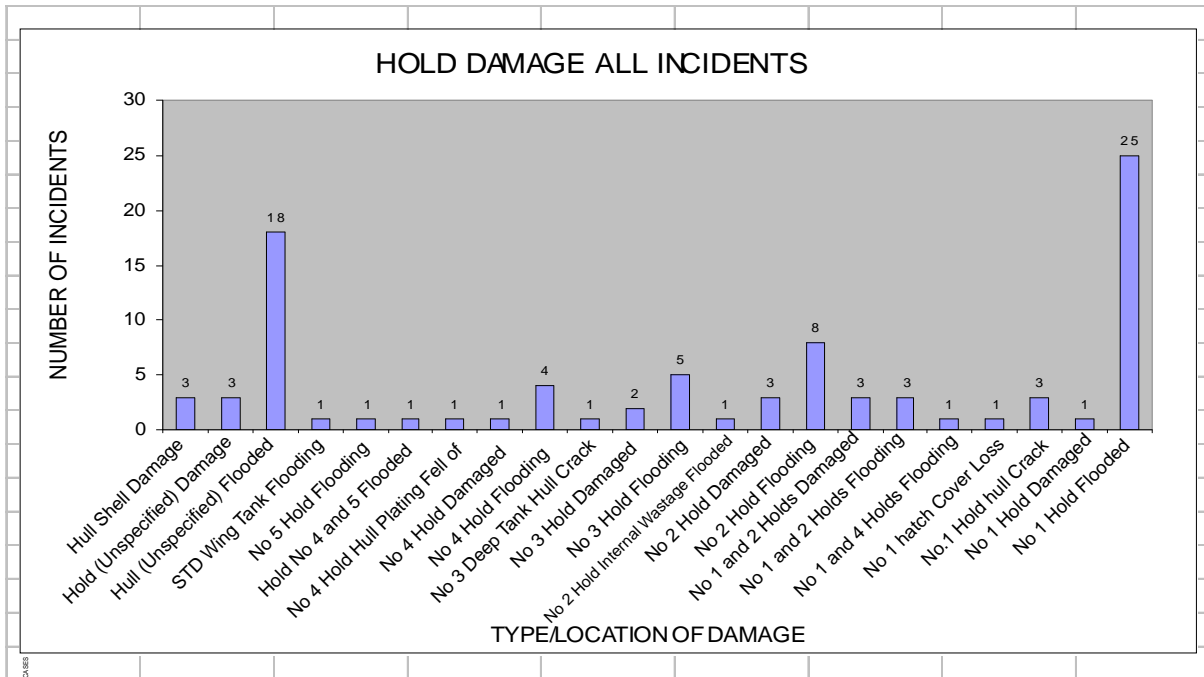


Figure 19

(2) Machinery/Equipment Related Incidents.

There are 1224 incidents on the database associated with machinery/equipment failure of which 794 (65%) are related to the operation of the main engine. (see Figure (20)). Of these main engine related incidents 16% can be attributable to mechanical failure and 5% are associated with heavy weather conditions. Unfortunately the cause of the remaining 79% main engine failure incidents has not been specified in the incident reports.

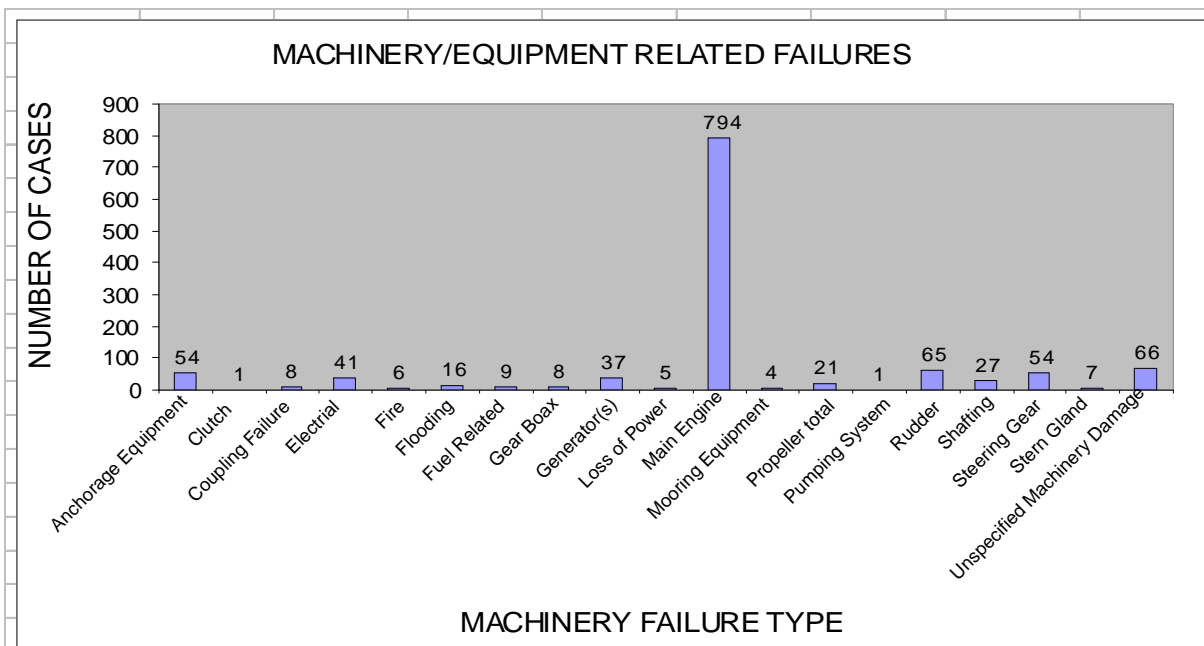


Figure 20

**(3) Fire and Explosion Damage Incidents**

Figure (21) shows the location of the 198 fire/explosion related incidents reported. The majority of such incidents (72%) have occurred in the engine room and 21% in the cargo holds. The lack of detail in the majority of these cases did not allow any further accurate observations to be made. However, the trend clearly shows that there is a need for greater attention to fire safety issues in engine room spaces.

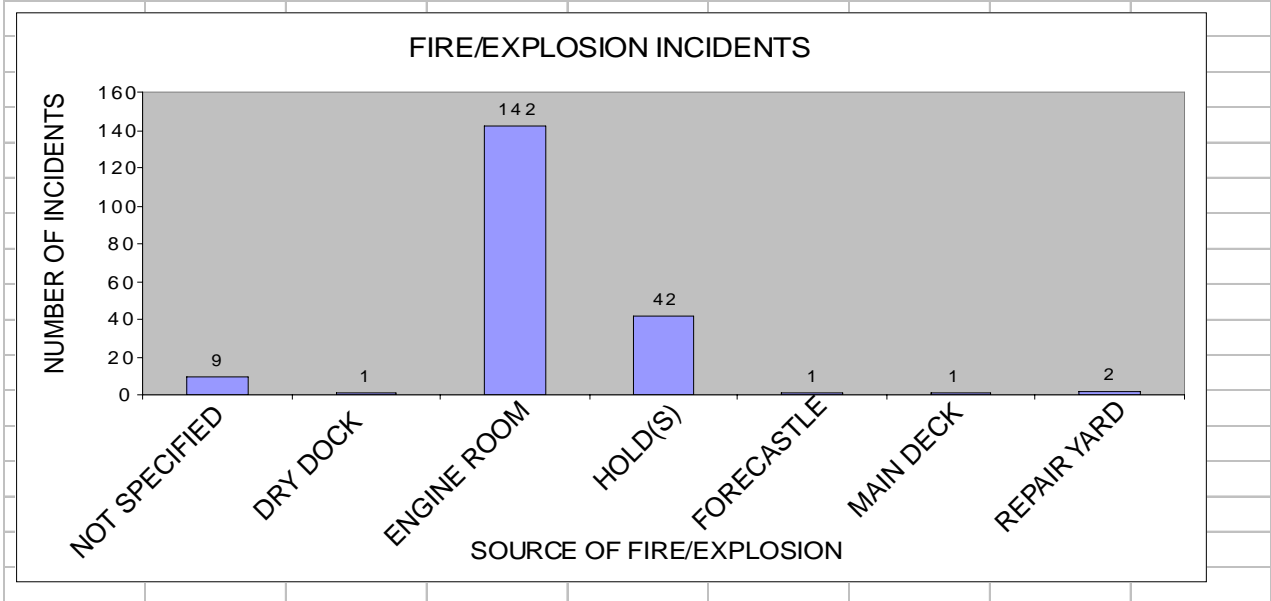


Figure 21



## UR Z11 “Mandatory Ship Type and Enhanced Survey Programme (ESP) Notations”

### Summary

In Rev.6 of this UR, an update was made to maintain the consistency with the outcome of previous work related to the definition of oil tankers which was reflected in UR Z10.1(Rev.25) and UR Z10.4(Rev.18).

### Part A. Revision History

Version no.	Approval date	Implementation date when applicable
Rev.6 (May 2023)	24 May 2023	1 July 2024
Rev.5 (Sept 2015)	21 September 2015	1 January 2017
Rev.4 (Mar 2011)	11 March 2011	1 January 2012
Rev.3 (July 2004)	13 July 2004	1 January 2005
Rev.2 (June 2000)	15 June 2000	-
Rev.1 (1996)	<i>No record</i>	-
New (1993)	<i>No record</i>	-

#### • Rev.6 (May 2023)

##### 1 Origin of Change:

- Suggestion by IACS member

##### 2 Main Reason for Change:

An update of this UR to maintain the consistency with UR Z10.1 and UR Z10.4.

##### 3 List of non-IACS Member classification societies contributing or participating in IACS Working Group:

None

##### 4 History of Decisions Made:

IACS decided to update this UR to maintain the consistency with the outcome of previous work related to definitions of oil tankers reflected in UR Z10.1(Rev.25) and UR Z10.4(Rev.18).

##### 5 Other Resolutions Changes:

None

## **6 Any hinderance to MASS, including any other new technologies:**

None

## **7 Dates:**

Original Proposal : 20 February 2023 (PSU23009\_ISUa)  
Panel Approval : 15 March 2023 (Ref: 37th Survey Panel Meeting)  
GPG Approval : 24 May 2023 (Ref: 23079\_IGb)

## **• Rev.5 (Sept 2015)**

### **1 Origin of Change:**

- Based on the proposal of an IACS Member

### **2 Main Reason for Change:**

Following a query made by a Panel Member seeking the advice whether the self-unloading ships, carrying and self-discharging solid materials in bulk, are to be considered as units subject to the Enhanced Survey Program (ESP).

### **3 List of non-IACS Member classification societies contributing through the TC Forum and/or participating in IACS Working Group:**

None

### **4 History of Decisions Made:**

Survey Panel discussed the matter under PSU15019 and the majority of the Members agreed that a self-unloading ship is to be subjected to the ESP regime when it:

- is a self-propelled ship.
- is constructed generally with single deck, double bottom, hopper side tanks and topside tanks and with single or double side skin construction in cargo length area its midship section.
- is intended to carry and self-unload dry cargoes in bulk.

Panel Members concurred that notwithstanding the configuration (shapes) of the double bottom, of the self-unloading ship, might be different from that traditional, e.g. flat or slightly inclined toward the center line, this does not prevent the application of the ESP scheme.

According to the above Panel agreed to the modification of the UR Z11. This has been modified by introducing the new category of ships (self-unloaders) which is inclusive of the sketches of the most typical sections.

No TB is expected for this revision.

### **5 Other Resolutions Changes**

None

## 6 Dates:

Original Proposal: *17 March 2015 (Made by a Member)*

Panel Approval: *14 August 2015 (Ref: PSU15019)*

GPG Approval: *21 September 2015 (Ref: 15139\_IGc)*

- **Rev.4 (Mar 2011)**

### 1 Origin of Change:

- Suggestion by an IACS member

### 2 Main Reason for Change:

Since UR Z11 contains single hull arrangements, include a provision which states vessels that do not comply with MARPOL I/19 may be subject to International and/or National Regulations requiring phase out. Also, include double hull arrangements for "ORE/OIL CARRIER".

### 3 List of non-IACS Member classification societies contributing through the TC Forum and/or participating in IACS Working Group:

None

### 4 History of Decisions Made:

Discussed at Spring 2010 Survey Panel meeting and completed through correspondence.

### 5 Other Resolutions Changes

None

## 6 Dates:

Original Proposal: *25 February 2010 Made by: Survey Panel*

Panel Approval: *October 2010*

GPG Approval: *11 March 2011 (Ref: 11039\_IGb)*

- **Rev.3 (July 2004)**

To amend Z11 to take into account the adoption of URs Z10.4 and Z10.5, and amendments to UR Z10.2 relating to hybrid hold arrangements, clarification in respect of combination carriers and ore carriers and new definition of bulk carriers and double hulled oil tankers (WP/SRC Task 117).

See TB in Part B.

- **Rev.2 (June 2000)**

To reflect the IMO interpretation of 'single side skin construction' in the Z11.2.2 definition of a 'bulk carrier'. WP/S submitted the draft revision to Z 11. Approved by GPG 48.

See TB in Part B.

- **Rev.1 (1996)**

No TB document available.

- **New (1993)**

No TB document available.

## **Part B. Technical Background**

List of Technical Background (TB) documents:

Annex 1      **TB for Rev.2 (June 2000)**

See separate TB document in Annex 1.

Annex 2      **TB for Rev.3 (July 2004)**

See separate TB document in Annex 2.

Annex 3      **TB for Rev. 4 (March 2011)**

See separate TB document in Annex 3.

**Note:** *There is no separate Technical Background (TB) document for New (1993), Rev.1 (1996,), Rev.5 (Sept 2015) and Rev.6 (May 2023).*

**(Rev.2, Z11)**

**Technical Background to changes proposed in respect of Z11.2.2  
Bulk Carriers**

The objective of the proposal is to reflect the IMO interpretation of 'single side skin construction' in the Z11.2.2 definition of a 'bulk carrier'. The Working Party on Strength discussions yielded unanimous agreement and no matters remain unresolved.

S E Rutherford  
Chairman IACS WP/S

4<sup>th</sup> May 2000

## **Technical Background UR Z 11 (Rev. 3)**

### **1. Objective**

To amend Z11 to take into account the adoption of URs Z10.4 and Z10.5, and amendments to UR Z10.2 relating to hybrid hold arrangements, clarification in respect of combination carriers and ore carriers and new definition of bulk carriers and double hulled oil tankers (WP/SRC Task 117).

### **2. Background**

When approving UR Z10.5 and reviewing draft amendments to Z10.2 in 2003/2004, GPG found it necessary to amend UR Z11 in order :

- ∞ to take into account hybrid cargo hold arrangements in Z11 ;
- ∞ to introduce new definitions of bulk carriers, ore carriers and combination carriers;
- ∞ to clarify application of UR Z10s to various types of ships according to their hull arrangements.

### **3. Amendment**

GPG tasked WP/SRC to amend UR Z11 accordingly. Task 117 given. Outcome reported on 11 May 2004 (4072bNVa).

[Due to the implementation date of Z10.5 being 1 January 2005, changes introduced in Rev.3 to Z11 are to be implemented from 1 January 2005]

2 July 2004  
Prepared by the Permsec

## **Technical Background for UR Z11 Rev.4, Mar 2011**

### **1. Scope and objectives**

Since UR Z11 contains single hull arrangements, include a provision which states vessels that do not comply with MARPOL I/19 may be subject to International and/or National Regulations requiring phase out. Also, include double hull arrangements for "ORE/OIL CARRIER".

### **2. Engineering background for technical basis and rationale**

N/A

### **3. Source/derivation of the proposed IACS Resolution**

IMO MARPOL Annex I Regulation 19

### **4. Summary of Changes intended for the revised Resolution:**

A provision was added for each which states vessels that do not comply with MARPOL I/19 may be subject to International and/or National Regulations requiring phase out. Also, include double hull arrangements for "ORE/OIL CARRIER".

### **5. Points of discussions or possible discussions**

None

### **6. Attachments if any**

None



## UR Z13 "Voyage Repairs and Maintenance"

### Part A. Revision History

Version no.	Approval date	Implementation date when applicable
Rev.3 (Jan 2011)	05 January 2011	1 July 2011
Rev.2 (Feb 2010)	11 February 2010	1 January 2011
Rev.1 (1995)	<i>No Record</i>	-
NEW (1995)	<i>No Record</i>	-

#### • Rev.3 (Jan 2011)

##### .1 Origin for Change:

- Suggestion by an IACS member

##### .2 Main Reason for Change:

A member queried the definition of 'extreme' in the phrase 'extreme emergency circumstance'. The phrase was introduced in Rev.2 to Z13. The document MSC/Circ.1070, upon which the amendments in Rev.2 were based, does not refer to 'extreme emergency circumstances'. It was therefore decided to delete the word 'extreme', referring only to 'emergency circumstance'.

##### .3 List of non-IACS Member classification societies contributing through the TC Forum and/or participating in IACS Working Group:

None

##### .4 History of Decisions Made:

The matter was raised by the member prior to the Autumn Survey Panel Meeting, and discussed at the meeting. It was agreed that to define an 'extreme emergency circumstance' would be problematic, and in order to closer align Z13 with MSC/Circ.1070 it was agreed that the word 'extreme' should be deleted.

##### .5 Other Resolutions Changes

None

##### .6 Dates:

Original proposal: *September 2010 Made by a Member (PSU 10038)*  
 Panel Approval: *16 September 2010*  
 GPG Approval: *05 January 2011 (Ref. 10166\_IGd)*

- **Rev. 2 (Feb 2010)**

**.1 Origin for Change:**

- Suggestion by IACS member

**.2 Main Reasons for Change:**

According to the fact that MSC/Circ.1070 substitutes MSC/Circ.807 and the latter is no longer valid, existing UR Z13 which has made reference to MSC/Circ.807 needs to be modified in order to correspond with MSC/Circ.1070.

**.3 History of Decisions Made:**

Hull Panel chairman advised Survey Panel chairman that UR Z13 may have to be revised in order to correspond to the requirements of MSC/Circ.1070 instead of MSC/Circ.807, which is no longer valid, via the e-mail, 'PH9018\_IHa, Response to industry question - Mr Isbester - Application of MSC/Circ.1070' dated 10 September 2009. According to this e-mail, the panel members discussed about this issue and the panel concluded that UR Z13 should be revised under Task 69 (PSU9031). CCS has introduced the draft amendments to UR Z13 'Voyage Repairs and Maintenance' at the 10th Survey Panel meeting (16 - 17 September 2009), and based on the drafts the panel members discussed about proper texts to insert in the existing UR Z13.

**.4 Other Resolutions Changes**

None

**.5 Any dissenting views**

None

**.6 Dates:**

Original Proposal: *September 2009, made by Hull Panel*  
Panel Approval: *January 2009, made by Survey Panel*  
GPG Approval: *11 February 2010 (Ref. 10003\_IGd)*

- **Rev. 1 (1995)**

No TB document available.

- **New (1995)**

No TB document available.

## Part B. Technical Background

List of Technical Background (TB) documents for UR Z13:

Annex 1. **TB for Rev.2 (Feb 2010)**

See separate TB document in Annex 1.

Annex 2. **TB for Rev.3 (Jan 2011)**



See separate TB document in Annex 2.



**Note:**

1) *There are no separate Technical Background (TB) documents for UR Z13 New (1995) and Rev.1 (1995).*

## **Technical Background for UR Z13 Rev.2, Feb 2010**

### **1. Scope and objectives**

To amend UR Z13 (Rev.1) for the harmonization with the requirements of the MSC/Circ. 1070 which supersedes MSC/Circ. 807.

### **2. Engineering background for technical basis and rationale**

Remove technical discrepancies between the referenced IACS documents and IMO documents.

### **3. Source/derivation of the proposed IACS Resolution**

- MSC/Circ.1070
- IACS UR Z13 (Rev.1)

### **4. Summary of Changes intended for the revised Resolution:**

1) In case of extreme emergency circumstance, emergency repairs are always to be effected immediately, and the repairs should be verified by the classification society in near future.

2) Review of the application of repair coating is to be carried out as appropriate, as part of the survey of voyage repairs.

3) Riding repairs to primary hull structures is prohibited except in extreme circumstances.

### **5. Points of discussions or possible discussions**

Compare IACS UR Z13 with MSC/Circ. 1070 and develop the wording to be inserted into UR Z13 for harmonizing two documents.

## **Technical Background for UR Z13 Rev.3, Jan 2011**

### **1. Scope and objectives**

To amend Z13 by removal of the word 'extreme' from the phrase 'extreme emergency circumstance' and thereby further align Z13 to MSC/Circ. 1070.

### **2. Engineering background for technical basis and rationale**

Further remove technical discrepancy between referenced IACS documents and IMO documents. It was further agreed that to define an 'extreme emergency circumstance', as opposed to any other emergency circumstance, would be problematic.

### **3. Source/derivation of the proposed IACS Resolution**

- MSC/Circ.1070
- IACS UR Z13 (Rev.2)

### **4. Summary of Changes intended for the revised Resolution:**

To remove the word 'extreme' from the phrase 'extreme emergency circumstance' in Para 2 of UR Z13.

### **5. Points of discussions or possible discussions**

A member raised the issue of defining an 'extreme emergency circumstance', a phrase that had been introduced in Rev.2 of Z13. Various attempts were made to define this. Z13 Rev.2 had been introduced to harmonise requirements with MSC/Circ.1070, though it was noted that this source document made no mention of extreme emergencies, referring only to 'emergency repairs'.

Consequently it was decided that rather than define an extreme emergency, the word 'extreme' should be removed from Para 2 of UR Z13.

### **6. Attachments if any**

None

## UR Z15 “Hull, Structure, Equipment and Machinery Surveys of Mobile Offshore Drilling Units”

### Summary

This revision is to harmonize the terms of ‘recommendation’ and ‘condition of class’ with only the term ‘condition of class’ being retained.

### Part A. Revision History

Version no.	Approval date	Implementation date when applicable
Rev.3 (May 2018)	30 May 2019	1 July 2020
Rev.2 (June 2018)	05 June 2018	1 July 2019
Corr.1 (Oct 2016)	10 October 2016	-
Rev.1 (Jan 2015)	12 January 2015	01 January 2016
New (Aug 2002)	30 August 2002	-

#### • Rev. 3 (May 2019)

##### .1 Origin of Change:

- Suggestion by an IACS member

##### .2 Main Reason for Change:

This revision is to address the policy decision made by GPG using the common terminology ‘Condition of Class’(CoC) instead of the terms ‘Recommendation/ Condition of Class’ based on the outcome of III 5.

##### .3 List of non-IACS Member classification societies contributing through the TC Forum and/or participating in IACS Working Group:

None

##### .4 History of Decisions Made:

During the 29th panel meeting, the panel discussed about the comments of members, and concurred with the view to retain the present definitions of CoC in the IACS resolutions with the wording ‘Recommendation’ to be removed. The panel also agreed to use the term ‘Statutory Condition’ for the ‘recommendation’ of the statutory certificates in IACS resolutions and RECs, and when discussing the proposal of a member to consider the harmonization of the terms of ‘recommendation’ and ‘condition of class’ in RO Code, the panel unanimously agreed to take no action on the IMO instruments, leaving the relevant actions to be decided by the relevant IMO

bodies when IACS feeds back to IMO the IACS action on the harmonization of the two terms.

Panel members concurred with the view that it is not necessary to develop a new procedure requirement, and agreed to set the implementation date of these IACS resolutions (other than RECs) as 1st July 2020.

Before the implementation date of 1st July 2020 for using the common terminology 'Condition of Class' only, 'Recommendations' and 'Condition of Class' are to be read as being different terms used by Societies for the same thing, i.e. requirements to the effect that specific measures, repairs, surveys etc. are to be carried out within a specific time limit in order to retain Classification.

No TB is expected for the present revision.

#### **.5 Other Resolutions Changes:**

The following IACS resolutions and Recommendations (RECs) were agreed to be revised:

- Procedural Requirements: PR1A, PR1B, PR1C, PR1D, PR1 Annex, PR3, PR12, PR20, PR35 and the attachment of PR16;
- Unified Requirements: Z7, Z7.1, Z7.2, Z10.1, Z10.2, Z10.3, Z10.4, Z10.5, Z15 and Z20
- Unified Interpretations: GC13
- Recommendations: Rec.41, Rec.75, Rec.96, Rec.98

#### **.6 Any hinderance to MASS, including any other new technologies:**

None

#### **.7 Dates:**

Original Proposal: 14 January 2019 tasked by GPG (17044bIGm)  
Panel Approval: 22 March 2019 (PSU19010)  
GPG Approval: 30 May 2019 (17044bIGu)

### **• Rev.2 (June 2018)**

#### **.1 Origin of Change:**

- Suggestion by IACS members

#### **.2 Main Reasons for Change:**

To address the FUA 11 of C73, raised by the Council of the IACS in respect to the future work directions on the implications of new technology on survey regime. A revision of UR Z15 is in order to consider the new technologies on Remote Inspections (RIT).

**.3 List of non-IACS Member Classification Societies contributing through the TC Forum and/or participating in IACS Working Group:**

None

**.4 History of Decisions Made:**

Members discussed under Panel task PSU 16056 the issue allocated by GPG on 21th October 2016. The subject deals with the review of the UR and Recommendation under Panel responsibility in order to determine whether a revision could need in order to consider the new technologies on Remote Inspections (RIT). The Panel Members concurred to discuss the possible revisions of the UR Z7 in order to address the issue.

New paragraphs 1.2.16 with definition of RIT and & 9.2.3 with means for access, as well as the new section 1.4 "Remote Inspection Techniques (RIT)" were agreed and inserted in the present revision of UR Z15.

No TB is expected for the present revision.

**.5 Other Resolutions Changes**

UR Z3, UR Z7, UR Z7.1, UR Z7.2, UR Z10.3, UR Z17

**.6 Dates:**

Original Proposal: 21 October 2016 assigned by GPG  
Panel Approval: 15 May 2018 by Survey Panel (Ref: PSU16056)  
GPG Approval: 05 June 2018 (Ref: 16151\_IGw)

**• Corr.1 (Oct 2016)**

**.1 Origin of Change:**

Suggestion by an IACS member

**.2 Main Reasons for Change:**

To correct the title of paragraph 5.2 of the UR Z15 relevant to tailshaft survey

**.3 List of non-IACS Member Classification Societies contributing through the TC Forum and/or participating in IACS Working Group:**

None



#### **.4 History of Decisions Made:**

Following the re-examination of the revision 1 of UR Z15, in order to verify the applicability of the UR Z21 also to MODU, a Member noted that the original title of paragraph 5.2 might be misleading in respect to the contents of the paragraph.

Moreover it has replaced the wording "tailshaft" with "propeller shaft" so that the terminology used in UR Z15 and UR Z21 will be coherent.

Accordingly a rewording of the title has been agreed by the Panel which concurred that this is a merely correction of the UR because nor technical contributions nor substantive modification have been applied to the text

#### **.5 Other Resolutions Changes**

Nil

#### **.6 Dates:**

Panel Approval: 09 September 2016 (Ref: PSU16031)

GPG Approval: 10 October 2016 (Ref: 16162\_IGb)

#### **• Rev.1 (Jan 2015)**

##### **.1 Origin of Change:**

- Other: GPG tasked Survey Panel to review UR Z15, identify if it is indeed outdated, make the necessary draft changes (message 12139\_IGa C65 FUA 28 – QACE 2011 Annual Report: Review UR Z 15 in light of amendments to UR Z7 (Rev.18))

##### **.2 Main Reasons for Change:**

Review UR Z15 and propose changes to update the requirements, in particular, those for close-up inspections and scope and procedures for thickness measurements that need to be aligned with the development of similar requirements for ships (UR Z7).

##### **.3 List of non-IACS Member Classification Societies contributing through the TC Forum and/or participating in IACS Working Group:**

None

#### **.4 History of Decisions Made:**

Following the GPG request (GPG item 12139) the Survey Panel has been tasked to review the UR Z15 in order to verify if amendments needed to be applied. All Panel Members agreed that the matter should be dealt with by experts in order to prepare the draft modification to the UR Z15. Members concurred that a dedicated PT should be established. Upon GPG agreement the PT no. 22(2013) was set and tasked to:

- develop the revision 1 of UR Z15 (under Survey Panel item PSU12033)

- develop a draft Unified interpretation relevant to the permanent means of access for MODU (initially under Survey Panel item PSU 12035 and subsequently merged under PSU 12033)

Panel discussed the drafted revision 1 of UR Z15, as prepared by PT, under item PSU12033 and following minor adjustments related to exclusion of the MODU surface units (drilling ships) from the applicability of Z1, Z3, Z6, Z7, Z18 , Z21 and Z22, except when noted in the text, finally Panel agreed the revision 1.

#### **.5 Other Resolutions Changes**

Nil

#### **.6 Dates:**

Panel Approval: 20 November 2014 (By: Survey Panel)

GPG Approval: 12 January 2015 (Ref: 12139\_IGi)

- **NEW (Aug 2002)**

Refer to the TB document in Part B, Annex 1.

## Part B. Technical Background

List of Technical Background (TB) documents for UR Z15:

Annex 1. **TB for Original Resolution - NEW (Aug 2002)**

See separate TBs document in Annex 1.



*Note: There are no separate Technical Background (TB) documents for Rev. 1 (Jan 2015), Corr.1 (Oct 2016), Rev.2 (May 2018) and Rev.3 (May 2019).*

**Technical Background Document  
WP/SRC Task 1  
UR Z 15 – Proposed**

**Objective and Scope:**

To review existing UR D 12 and relocate it as a UR under UR Z.

**Source of Proposed Requirements:**

WP/SRC members discussed and reviewed the requirements contained in UR D 12 through correspondence and their meeting. Reservations against UR D 12 were also dealt with at this time as contained in the proposed draft.

**Points of Discussion:**

WP/SRC unanimously agreed to the proposed draft UR Z 15.

## Technical Background Document

### New UR Z 15 and deletion of D12 (Survey after Construction, MODUs)

#### Objective and Scope:

Re-locate the current MODU survey requirements from UR D12 to a new UR Z.

#### Source of Proposed Requirements:

WP/SRC Chairman reported in his annual progress report(March 1999, GPG 46) that WP/SRC Members had discussed and reviewed the requirements contained in UR D 12 through correspondence and at their last meeting and had relocated the text of D 12 to a new UR Z15.

The task was carried out as part of Annual review of Implementation of IACS Requirements.

#### Points of Discussion:

WP/SRC unanimously agreed to the proposed draft UR Z 15.

Council in May 1999 decided that the proposed draft paragraph 2.2.2 should be deleted since it would require Members to periodically check all CSDU's lightship characteristics as a condition of class in the event that it was not checked as a statutory requirement.

Paragraph 2.2.2, which has now been deleted, read as follows:

- 2.2.2 For Column Stabilized Units, a deadweight survey is to be conducted as part of classification surveys at interval not exceeding 5 years or at time of Special Surveys, or as part of statutory surveys at interval specified by the Flag Administrations. Where the deadweight survey indicates a change from the calculated light ship displacement in excess of 1% of the operating displacement, an inclining test is to be conducted.

#### Note:

Council Chairman announced approval of UR Z15(ex D12) on 15 May 1999 subject to the following conditions:

- Deletion of paragraph 2.2.2;
- Adoption of UR Z18(ex M20) for Z15.5.1 and Z15.6.1;
- Editorial corrections.

UR Z18 was finally approved on 23 November 2001(9056aIAe, 29/01/2002):

- M20 was deleted;
- Z18 "Periodical Survey of Machinery" created excluding tail shaft survey requirements;
- Z21 created for the tail shaft survey requirements.

ABS suggested to re-word Z15.5.1 to avoid the need for filing of reservations on Z15.5.1 simply because it invokes the requirements of Z21. Agreed.

\*\*\*\*\*

Date of submission: 14 August 2002  
By the Permanent Secretariat

## UR Z16 “Periodical surveys of cargo installations on ships carrying liquefied gases in bulk”

### Summary

This corrigendum is to correct a wrong reference, i.e. reference to Rec.35 in note of Section 4.2 is corrected to Rec.120.

### Part A. Revision History

Version no.	Approval date	Implementation date when applicable
Corr.1 (May 2022)	09 May 2022	-
Rev.4 (Oct 2013)	11 October 2013	1 July 2014
Corr.1 (Feb 2011)	11 February 2011	1 July 2011
Rev.3 (Mar 2010)	03 March 2010	1 July 2011
Rev.2 (May 2007)	14 May 2007	-
Rev.1 (Mar 2006)	03 March 2006	-
New (June 1999)	28 June 1999	-

#### • Corr.1 (May 2022)

##### 1 Origin of Change:

- Based on the proposal of an IACS Member

##### 2 Main Reason for Change:

To correct a reference, Rec.35 to Rec.120 in note of section 4.2.

##### 3 List of non-IACS Member classification societies contributing or participating in IACS Working Group:

None

##### 4 History of Decisions Made:

One panel member raised a question on the reference, Rec.35. Panel reviewed and found that Rec.35 was divided into two Recommendations, for tankers (Rec.120) and ships other than tankers (Rec.35), and UR Z16 was not updated accordingly.

No TB is expected for the present corrigendum.

##### 5 Other Resolutions Changes:

None

## **6 Any hinderance to MASS, including any other new technologies:**

None

## **7 Dates:**

Original Proposal : 27 May 2021 (Made by Survey Panel Member)  
Panel Approval : 15 April 2022 (Ref: PSU21020)  
GPG Approval : 09 May 2022 (Ref: 22061\_IGb)

### **• Rev 4 (Oct 2013)**

#### **.1 Origin of Change:**

Based on the proposal of an IACS Member

#### **.2 Main Reason for Change:**

An IACS member proposed to review IACS UR Z16 section 2.2.8 and to better define "significant differences" with a view to achieving more uniform and consistent application of the requirement by IACS Societies.

#### **.3 List of non-IACS Member classification societies contributing through the TC Forum and/or participating in IACS Working Group:**

None

#### **.4 History of Decisions Made:**

A project team was formed to review SBTT results among members with vessels having a glued secondary barrier. Due to the formation of the project team, the system designer proposed new acceptance criteria which require additional testing once a threshold value is exceeded. The project team reviewed the new criteria and recommended the changes to UR Z16. The changes were approved by the Survey Panel.

#### **.5 Other Resolutions Changes:**

The project team also recommended a revision to UI GC12 regarding testing of the SBTT at the time of construction.

#### **.6 Dates:**

Panel Approval: 18th Panel Meeting (4-5 September 2013) (Ref: PSU12029)  
GPG Approval: 11 October 2013 (Ref: 6179aIGj)

- **Corr.1 (Feb 2011)**

**.1 Origin for Change:**

- Suggestion by IACS member

**.2 Main Reason for Change:**

UR Z16 was amended in Mar 2010 in order to clarify NDT requirements for Type C LNG tanks. However the amendment might lead to misunderstanding that it also applies to Type A LNG tanks. In order to eliminate the misunderstanding, the UR amendment is corrected.

**.3 List of non-IACS Member classification societies contributing through the TC Forum and/or participating in IACS Working Group:**

None

**.4 History of Decisions Made:**

A Survey Panel member pointed out the issue in September 2010, and the subsequent discussion at Survey Panel meeting in September 2010 led to the agreement that the UR should be corrected to avoid the any misunderstanding.

**.5 Other Resolutions Changes**

None

**.6 Dates:**

Original Proposal: *September 2010 by a Survey Panel Member*

Panel Approval: *September 2010*

GPG Approval: *11 February 2011 (Ref: 10168\_IGf)*

- **Rev.3 (Mar 2010)**

**.1 Origin for Change:**

- Suggestion by IACS member

**.2 Main Reason for Change:**

Further to a finding raised during an IACS audit, a clarification was requested within the Survey Panel on paragraph [2.2.6] and paragraph [2.2.3.1] of UR Z16, for Non-Destructive Examination of independent cargo tanks of type C.

**.3 History of Decisions Made:**

Various discussions were carried out by the panel by correspondence and it was also dealt with in '10th Survey Panel meeting' (held during 13 to 14 September 2009). During discussion, interpretation on "as deemed necessary by the Surveyor" in



[2.2.3.1] was mainly dealt with. And, through correspondence among members after the meeting, a final wording for amendments to UR Z16 was made under agreement of majority of the panel.

#### **.4 Other Resolutions Changes**

None

#### **.5 Any dissenting views**

None

#### **.6 Dates:**

Original Proposal: *24 December 2008 made by Survey Panel*

Survey Panel Approval: *November 2009*

GPG Approval: *3 March 2010 (Ref. 9656\_IGd)*

- **Rev.2 (May 2007)**

Survey Panel Task 40 (Secondary Barrier Testing) – See TB in Part B.

- **Rev.1 (Mar 2006)**

Machinery Panel Task PM5401 – See TB in Part B.

- **New (June 1999)**

WP/SRC Task 1 – See TB in Part B.

## **Part B. Technical Background**

List of Technical Background (TB) documents for UR Z16:

Annex 1. **TB for New (June 1999)**

See separate TB document in Annex 1.

Annex 2. **TB for Rev.1 (Mar 2006)**

See separate TB document in Annex 2.

Annex 3. **TB for Rev.2 (May 2007)**

See separate TB document in Annex 3.

Annex 4. **TB for Rev.3 (Mar 2010)**

See separate TB document in Annex 4.

Annex 5. **TB for Rev.4 (Oct 2013)**

See separate TB document in Annex 5.

*Note: There is no separate Technical Background (TB) document for Corr.1 (Feb 2011) and Corr.1 (May 2022).*

**Technical Background Document  
WP/SRC Task 1 – Z16**

**Objective and Scope:**

To review the existing UR G4, Periodical surveys of cargo installations on ships carrying liquefied gases in bulk and relocate it as a UR under UR Z.

**Source of Proposed Requirements:**

The proposed requirements were developed by WP/SRC members through their experience in the survey of cargo installations on ships carrying liquefied gases in bulk. The existing UR G4 was reviewed and re-organized to follow formats consistent with other UR Z.

**Points of Discussion:**

WP/SRC unanimously agreed to the draft UR.

**Technical Background**  
**UR Z16(Rev.1, March 2006), paragraph 4.3**

**Machinery Panel Task PM5401**

The contents of paragraph 4.3, Electrical equipment, of Z16 'Periodical surveys of cargo installations on ships carrying liquefied gases in bulk' was to be reviewed and recommendations to be made for any changes deemed appropriate.

The revised paragraph 4.3 of UR Z16 consolidates proposals made by both the Machinery Panel and the Survey Panel.

The following changes were made:

1. 2<sup>nd</sup> bullet: delete 'flameproof' as this should apply to all types of enclosures
2. 6<sup>th</sup> bullet: delete 'and are to be carried out within an acceptable time period' as this expression is considered too vague.
3. Change last bullet to a 'Note'. Rec. 35 is not mandatory but including it in the UR would make it so.

Submitted by Machinery Panel Chairman  
17 February 2006

## **Technical Background**

### **UR Z16 (Rev. 2, 2007)**

**PSU Task 40:** Review issues raised in the Statutory Panel concerning survey requirements for paragraphs 4.10.4 and 4.10.16 and paragraph 1.5.4 for issuance of certificates of the IGC Code regarding the first loaded voyage of ships carrying liquefied gases in bulk.

#### **1. Objective**

Review the issues raised in the Statutory Panel NK (SP5034\_NKc) regarding the IGC Code verification and inspection following the first loaded voyage to define survey requirements for paragraphs 4.10.4 and 4.10.16 , and amend UR Z16 accordingly.

#### **2. Background**

LR Statutory Panel member requested that the Panel should determine if testing requirements should be created for the secondary barriers of LNG carriers.

#### **3. Methodology of Work**

The Survey Panel has progressed its work through meetings as well as a Survey Panel Project Team consisting of ABS (Chair), BV, DNV, GL, LR and NK. The proposed scope of work as well as the draft recommendation by the Project Team was circulated to all Members for comment and agreement.

#### **4. Discussion**

The first part of the task concerned survey requirements for paragraphs 4.10.4 and 4.10.16 of the IGC Code regarding the first loaded voyage of ships carrying liquefied gases in bulk.

The Project Team reviewed the requirements of the International Code for the Construction and Equipment of Ships Carrying Liquefied Gases in Bulk and discussed current practice among each Society.

The team discussed the survey requirements for the first loading and unloading. The requirements were developed based upon items that the team felt should be surveyed due to the vessel being fully loaded rather than the limited loading at gas trials.

The current practice of testing the secondary membrane was discussed and found only one shipyard was currently testing the secondary barrier after gas trials and most of the others refusing to test after gas trials.

The team also considered the leakage of the secondary barrier by two vessels after delivery which resulted in the vessels being removed from service to be repaired. After investigation, it was felt that the vessel may have developed the leaks on gas trials, though no evidence exists to support this allegation.

It was concluded by the team that the only way to ensure that the secondary barrier was satisfactory when delivered was to require tightness testing of the secondary barrier after gas trials for vessels with glued membranes.

The team also considered the current acceptance criteria by the containment system designer and felt that the criteria had proven to be questionable. Due to the lack of acceptance criteria, the team decided that values obtained before and after initial

cooldown shall be evaluated. If significant differences are observed in the before and after results for each tank or between tanks or other anomalies occur, an investigation is to be carried out.

The team then reviewed the requirements of UR Z16 and proposed a revision to incorporate the comparison of previous results and values obtained at Special Survey using the same approach of investigating differences in the before and after results for each tank or between tanks.

The Project Team and all Survey Panel members agreed to the proposed amendments to UR Z16.

(Permsec Note: IACS UI GC12 and GC13 were also developed as a result of this task)

Submitted by the Survey Panel

22 June 2007

## Technical Background for UR Z16 Rev.3, March 2010

### 1. Scope and objectives

To amend UR Z16 (para. 2.2.3.1) to clarify the relevant parts of Non-Destructive Examination of independent cargo tanks of type C

### 2. Engineering background for technical basis and rationale

Application of paragraph [2.2.6] of UR Z16 at 2nd, 4th, 6th, etc. class renewal survey, and of paragraph [2.2.3.1] at 1st, 3rd, 5th class renewal survey.

### 3. Source/derivation of the proposed IACS Resolution

Meaning of "...including welded connections as deemed necessary by the Surveyor" in [2.2.3.1].

Addition of the following sentence for the sake of clarity: "However, this does not mean that non-destructive testing can be dispensed with totally."

### 4. Summary of Changes intended for the revised Resolution:

To prevent "as deemed necessary by the Surveyor" in [2.2.3.1] from being interpreted as 'no Non-Destructive Examination of independent cargo tanks of type C can be done.'

### 5. Points of discussions or possible discussions

Clarifications on paragraph [2.2.6] and paragraph [2.2.3.1] UR Z16, for Non-Destructive Examination of independent cargo tanks of type C.

### 6. Attachments if any

None

## Technical Background for UR Z16 Rev.4, Oct 2013

### 1. Scope and objectives

To review IACS UR Z16 section 2.2.8 and to better define "significant differences" with a view to achieving more uniform and consistent application of the requirement by IACS Societies.

### 2. Engineering background for technical basis and rationale

The system designer issued new acceptance criteria for SBTT testing which is reflected in revised UR Z16.

### 3. Source/derivation of the proposed IACS Resolution

UR Z16 and GTT External Document No. 1136.

### 4. Summary of Changes intended for the revised Resolution:

The following amendment is made to UR Z16:

#### 2.2.8

1) For membrane and semi-membrane tanks systems, inspection and testing are to be carried out in accordance with programmes specially prepared in accordance with an approved method for the actual tank system.

2) For membrane containment systems a tightness test of the primary and secondary barrier shall be carried out in accordance with the system designers' procedures and acceptance criteria as approved by the classification society. Low differential pressure tests may be used for monitoring the cargo containment system performance, but are not considered an acceptable test for the tightness of the secondary barrier.

3) For membrane containment systems with glued secondary barriers, if the designer's threshold values are exceeded, an investigation is to be carried out and additional testing such as thermographic or acoustic emissions testing should be carried out. ~~the values obtained shall be compared with previous results or results obtained at newbuilding stage. If significant differences are observed for each tank or between tanks, the Surveyor is to require an evaluation and additional testing as necessary.~~



**5. Points of discussions or possible discussions**

None

**6. Attachments if any**

None

## UR Z17 “Procedural Requirements for Service Suppliers”

### Summary

In Corr.1 to Rev.18 of this UR, reference to Resolution MSC.388(94) which amended IMO Resolution A.761(18) in November 2014 was added in Section 5 of Annex 1 to this UR.

### Part A. Revision History

Version no.	Approval date	Implementation date when applicable
Corr.1 (May 2023)	17 May 2023	-
Rev.18 (Feb 2023)	02 February 2023	1 July 2023
Rev.17 (July 2022)	01 July 2022	1 July 2023
Rev.16 (Aug 2021)	16 August 2021	1 January 2022
Rev.15 (Oct 2020)	02 October 2020	1 July 2021
Rev.14 (Mar 2019)	18 March 2019	1 January 2020
Rev.13 (Jan 2018)	16 January 2018	1 January 2019
Rev.12 (Nov 2015)	28 November 2016	1 January 2018
Rev.11 (June 2015)	03 June 2015	1 July 2016
Rev.10 (Jan 2015)	20 January 2015	1 January 2016
Corr.1 (Aug 2012)	08 August 2012	-
Rev.9 (June 2012)	26 June 2012	1 July 2013
Rev.8 (Jul 2008)	10 July 2008	-
Rev.7 (Nov 2007)	30 November 2007	1 January 2008
Rev.6 (Jun 2007)	14 June 2007	1 January 2008
Rev.5 (Feb 2004)	27 February 2004	-
Rev.4 (Jul 2003)	08 July 2003	-
Rev.3 (Jul 2002)	27 July 2002	-
Rev.2 (Nov 1999)	02 November 1999	-
Rev.1 (Jun 1999)	11 June 1999	-
New (1997)	10 December 1999	-

#### • Corr.1 (May 2023)

##### 1 Origin of Change:

- Suggestion by IACS member

##### 2 Main Reason for Change:

Reference to Resolution MSC.388(94) which amended IMO Resolution A.761(18) in November 2014 was added in Section 5 of Annex 1 to this UR.

### **3 List of non-IACS Member classification societies contributing or participating in IACS Working Group:**

None

### **4 History of Decisions Made:**

As reference to Resolution MSC.388(94) was missing, correction was made.

### **5 Other Resolutions Changes:**

None

### **6 Any hinderance to MASS, including any other new technologies:**

None

### **7 Dates:**

Original Proposal	: 2 March 2023	(PSU23014_ISUa)
Panel Approval	: 15 March 2023	(Ref: 37th Survey Panel Meeting)
GPG Approval	: 17 May 2023	(Ref: 22082_IGe)

### **• Rev.18 (Feb 2023)**

#### **1 Origin of Change:**

- Suggestion by IACS member

#### **2 Main Reason for Change:**

To delete the requirement for an ISO/IEC accreditation for service suppliers for BWMS Commissioning Testing.

### **3 List of non-IACS Member classification societies contributing or participating in IACS Working Group:**

None

### **4 History of Decisions Made:**

One survey panel member suggested to delete the requirements regarding the ISO/IEC 17025 accreditation to the service suppliers for BWMS Commissioning Testing. ISO/IEC 17025 accreditation is for a specific analysis method and suitable for analyses carried out in accordance with an international standard method in a laboratory. However, for BWMS commissioning testing, the ballast water sampling and subsequent indicative analysis of the samples is carried out on board the ship and does not require any laboratory work. There are currently also no international standard methods for sampling and indicative analysis. As a result, accreditation bodies are currently not offering an ISO/IEC 17025 accreditation specific to sampling and indicative analysis of ballast water on board a ship.

At the 36<sup>th</sup> Survey Panel meeting, several members raised the urgency of this issue and the panel decided to publish the revision as soon as possible.

No TB has been expected for the revision.

## **5 Other Resolutions Changes:**

None

## **6 Any hinderance to MASS, including any other new technologies:**

None

## **7 Dates:**

Original Proposal	: 09 June 2022	(Made by Panel Member)
Panel Approval	: 22 September 2022	(Ref: PSU22033_ISUd)
GPG Approval	: 02 February 2023	(Ref: 22182_IGf)

## **• Rev.17 (July 2022)**

### **1 Origin of Change:**

- Suggestion by IACS member

### **2 Main Reason for Change:**

- 1) To clarify verification requirements for practical demonstration at initial and renewal audits to allow by documentary review of jobs undertaken since the previous audit and that have been accepted by a QSCS certified Society.
- 2) To update requirements on inflated rescue boats which are needed to be re-categorised under section 13 from section 5 of Annex 1 due to the introduction of MSC.Rec.404(96).
- 3) To update references of MSC.1/Circ.1318, MSC.1/Circ.1312, A.Res.1120(30) and MSC.1/Circ.1432 and delete references MSC.Circ.799 and MEPC.Res.279(70)

### **3 List of non-IACS Member classification societies contributing or participating in IACS Working Group:**

None

### **5 History of Decisions Made:**

- 1) One survey panel member suggested to clarify the requirements regarding practical demonstration due to the result of an external audit. This issue had been discussed several times (PSU13025/13030/15027/18009/18047) because of continuous comments during external audits/inspections, especially by EMSA.

Although UR Z17 did not require 'witnessing' such practical demonstration before certificate is issued, so it could be done by documentary review of jobs undertaken

since the previous audit and that have been accepted by a QSCS certified Society, EMSA did not accept it.

Therefore, survey panel decided to modify the wording to make clear.

- 2) Survey panel discussed regarding overlapped area between Section 5 and 13 of URZ17 for the servicing inflated rescue boats due to MSC.Res.404(96). MSC.Res.404(96) contains *Requirements for maintenance, thorough examination, operational testing, overhaul and repair means the Requirements for maintenance, thorough examination, operational testing, overhaul and repair of lifeboats and rescue boats, launching appliances and release gear*, adopted by the Maritime Safety Committee of the Organization by resolution MSC.402(96), so survey panel decided to remove rescue boats from UR Z17 Annex 1 section 5 as section 13 could be deemed as covering requirements to use an approved service supplier
- 3) References of MSC.1/Circ.1318, MSC.1/Circ.1312, A.Res.1120(30) and MSC.1/Circ.1432 were updated, and MSC.Circ.799 and MEPC.Res.279(70) were deleted.

No TB has been expected for the revision.

#### **5 Other Resolutions Changes:**

None

#### **6 Any hinderance to MASS, including any other new technologies:**

None

#### **7 Dates:**

Original Proposal:

- |   |                                 |
|---|---------------------------------|
| 1) 01 December 2021   | Made by Panel Member (PSU21056) |
| 2) 27 July 2021   | Made by Panel Member (PSU21034) |
| 3) 05 August 2021   | Made by Panel Member (PSU21033) |
| 4) 19 September 2021  | Made by Panel Member (PSU21041) |
| 5) 19 April 2022  | Made by Panel Member (PSU22022) |
| Panel Approval : 31 May 2022 (PSU21056/21034/21033/21041/22022) |                                 |
| GPG Approval : 04 July 2022 (Ref:22082_IGc)                     |                                 |

### **• Rev.16 (Aug 2021)**

#### **1 Origin of Change:**

- Suggestion by IACS member
- Based on IMO Regulation (MSC.1/Circ.1222/Rev.1)
- Based on IMO Requirement (UR W33)

## **2 Main Reason for Change:**

- 4) To develop the qualification of the service supplier for BWMS commissioning tests since BWM circular on Guidance for the commissioning testing of ballast water management systems was approved by MEPC75.
- 5) To strengthen the requirements of UR Z17 para. 5.1 Submission of documents.
- 6) To update the revised reference of IMO Circular MSC.1/Circ.1222/Rev.1.
- 7) To be aligned with UR Z23 and UR Z28, "watertight" was added at relevant places regarding cable transits/cable transit systems.
- 8) To be aligned with the decision for Revision 1 of UR W33, all "NDE" terms were switched to "NDT".
- 9) To make a term clear to avoid misunderstanding

## **3 List of non-IACS Member classification societies contributing or participating in IACS Working Group:**

None

## **4. History of Decisions Made:**

- 4) BWM circular on Guidance for the commissioning testing of ballast water management systems was approved by MEPC75 for dissemination as BWM.2/Circ.70/Rev.1.

When reviewing the Guidance, EP members agreed to the benefits of developing a unified approach towards the required qualifications for the service supplier which carry out sampling and sample analysis, and UR Z17 should be updated accordingly.

It is also noted some Administrations released relevant instruction that the test facility engaged on conducting the commissioning test shall be independent of the manufacturer of the BWMS and accepted by the RO which issues the IBWMC.

Considering Survey Panel is responsible for maintaining UR Z17, therefore, GPG was suggested by EP to task Survey Panel to consider this issue. After consideration, GPG tasked Survey Panel to consider updating UR Z17 to include the required qualification of the service supplier for BWMS commissioning tests.

After communication with Environmental Panel, it was agreed that the "qualification requirements of the service supplier for BWMS commissioning test" is to be developed by EP before Survey Panel proceeds to the work of updating UR Z17.

- 2) One survey panel member proposed strengthening the requirements because it has had some occasions where service supplier technicians have provided falsified reports, so it was agreed to request service supplier one more document regarding the code of conduct.

- 3) Since IMO Circular MSC.1/Circ.1222 was revised (MSC.1/Circ.1222/Rev.1), it is needed to update the reference.
- 4) One survey panel member pointed out that UR Z23 and Z28 used terms "watertight cable transits" and "watertight cable transit systems" while Z17 did not. Panel discussed about it and concluded to add "watertight" at proper place in UR Z17.
- 5) SURVITEC raised a question regarding a term "Authorization" in the para.5.11 because service suppliers do not need to be "authorized" by manufactures in accordance with MSC.402(96), and normally Administration "authorizes" and manufactures "certifies". Survey panel replied that the para.5.11 is a general requirement for all kinds of service suppliers, specific requirements are listed in annexes. However, survey panel agreed that the term may cause misunderstanding and revised to "Certification" to avoid possible misunderstandings.

No TB has been expected for the revision.

## 5 Other Resolutions Changes:

None

## 6 Any hinderance to MASS, including any other new technologies:

None

## 7 Dates:

Original Proposal:

- |                     |                                 |
|---------------------|---------------------------------|
| 1) 10 July 2020     | Made by GPG (20098)             |
| 2) 10 December 2020 | Made by Panel Member (PSU20055) |
| 3) 12 November 2020 | Made by Panel Member (PSU20047) |
| 4) 17 March 2021    | Made by Panel Member (PSU21011) |

Panel Approval: 26 July 2021 (Ref:20098\_PYc)

GPG Approval: 16 August 2021 (Ref: 20098\_IGh)

## • Rev.15 (Oct 2020)

### 1 Origin of Change:

- Suggestion by IACS member

### 2 Main Reason for Change:

- 10) A global unified standard is required to improve the installation and maintenance of Pressure-Rated MCT/Transit systems. In order to properly maintain Ship and Mobile Offshore Unit structures and promote vessel safety during water ingress a better method is necessary to document and manage installation, maintenance, and repair of MCT/Transit systems. By improving documentation during initial installation, incorporating the installation information into a systemized maintenance plan, and using knowledgeable authorized/approved service entities to conduct inspections, the risks of MCT failures will be reduced.

This will mitigate potential safety and environmental incidents as a result of service oversights and exposure to onboard flooding conditions.

- 11) Subcontractors providing the services of the approved service supplier are to be separately approved and certified, but relevant requirements are not clear in the current UR Z17.

### **3 List of non-IACS Member classification societies contributing or participating in IACS Working Group:**

None

### **4 History of Decisions Made:**

- 1) A member of the Survey Panel raised the issue of survey requirements during the 24th Survey Panel Meeting. In detail under discussion is the concept for the preparation of an IACS tool (a Recommendation or an UR, whichever deemed more appropriate) which addresses the complicated and arduous activities associated with the particular inspections required for class to accept the continuous integrity of the multi cable transit from the time of their installation till to the end of the ship's life.

In this respect the Survey Panel discussed the topics and agreed that a PT dealing with the matters would be advisable in order to provide suggestions for the possible revisions of the relevant IACS Resolutions (e.g. Z23, Z7, Z15, and Z17)

PT PSU32/2017 was established, and made revisions to URs Z23, Z7 and Z17.

PT's proposal was submitted to the Survey Panel on 11 August 2017, panel members concurred with comments on PT's submission and proposed actions were taken by the PT. Survey Panel reviewed the drafts which was further amended and agreed by Survey Panel on 14 March 2019 during the 29th Panel Meeting.

Realizing that the UR for approval of Service Suppliers for the inspection of Cable Transits is newly developed by IACS, before enough Service Suppliers being approved, it might be premature to push out the UR for the inspections to the cable transits of ships in service, the members agreed to push out the IACS URs step by step, and firstly to work out the revision to UR Z23 to include the requirement of the "Register" for new construction ships, and the revision to UR Z17 for the details of the approval requirements of the Service Suppliers for the inspection of Cable Transits, and secondly to complete the draft of the new UR Z (other than revising URs Z7 and Z15) in a later time with all the survey requirements to the cable transits, leaving the mandatory requirements for the service supplier to be considered in the future.

After the 30<sup>th</sup> Survey Panel meeting, the panel finalized the new UR Z28 and the revisions to URs Z23 and Z17.

Refer TB Document in Annex 9 of Part B.



2) A member of Survey Panel initiated the issue of approval of subcontractors providing the services of the approved service supplier which is not clearly stated in UR Z17. Survey Panel discussed and agreed that the subcontractors shall be separately approved and certified, and decided to revise Section 5.2.9 and 5.5.3 to make the requirements clear.

No TB has been expected for the revision.

## **5 Other Resolutions Changes:**

URs Z23, Z28

## **6 Any hinderance to MASS, including any other new technologies:**

None

## **7 Dates:**

Original Proposal:

- 1) W.r.t new requirements - 29 September 2016 Made by a Survey Panel Member
- 2) W.r.t revision of sections 5.2.9 and 5.5.3 - 11 February 2020 Made by a Survey Panel Member

Panel Approval:

- 1) W.r.t new requirements - October 2019 (Ref: PSU16049)
- 2) W.r.t revision of sections 5.2.9 and 5.5.3 - 29 April 2020 (Ref: PSU20011)
- 3) W.r.t GBS - 21 September 2020 (Ref: 16222\_PYg)

GPG Approval: 02 October 2020 (Ref: 16222\_IGv)

## **• Rev.14 (Mar 2019)**

### **1 Origin of Change:**

- Suggestion by IACS Member

### **2 Main Reason for Change:**

Taking into account that the provisions of IMO resolutions MSC.402(96) and MSC.404(96) will enter into force on 01 January 2020, it is noted that UR Z17 needs to be amended regarding the requirements for service suppliers "Firms engaged in the servicing and maintenance of lifeboats, launching appliances, on-load release gear and davit-launched liferaft automatic release hooks".

### **3 List of non-IACS Member Classification Societies contributing through the TC Forum and/or participating in IACS Working Group:**

None

#### **4 History of Decisions Made:**

Survey Panel concurred with the following:

- 1) Section 13 of Annex 1 to Z17 is based on the MSC.1/Circ.1277 and MSC.1/Circ.1206/rev.1
- 2) Section 13 of Annex 1 to Z17 should be revised for aligning with the requirements of the Annex to MSC.402(96).

Survey Panel members noted that MSC.402(96) was corrected by MSC 96/25/Add.1/Corr.1 on 2017-03-31.

Survey Panel agreed with the following:

- As implementation date of MSC.402(96) is 1 January 2020, the applicability of the amendment to UR Z17 is to be also from 1 January 2020, but the new revisions may be early implemented based on request from service supplier.
- Paragraphs 4.1.1 is to be revised for aligning with MSC.402(96).
- The title of Section 13 of Annex 1 to Z17 is to be amended as follows in line with MSC.402(96):  
"Firms engaged in maintenance, thorough examination, operational testing, overhaul and repair of lifeboats and rescue boats, launching appliances and release gear".
- The references mentioned in Section 13 of Annex 1 are to be changed to MSC.402(96) /Corr.1, i.e. MSC.402(96) as corrected by MSC 96/25/Add.1/Corr.1 in place of MSC.1/ Circ. 1206/ Rev.1 and MSC.1/Circ. 1277.
- Paragraphs 13.1, 13.2.2, 13.3.1, 13.3.2, 13.3.4, 13.3.5 and 13.6 of Section 13 of Annex 1 are to be revised respectively according to paragraphs 2.1, 7.1, 8.1, 8.2.1, 8.2.3, 8.3.1 and 5.3 of the Annex of MSC.402(96).
- Paragraph 13.3.6 of Section 13 of Annex 1 is to be newly inserted according to 8.3.2 of the Annex of MSC.402(96).
- The term "make and type" in Section 13 of Annex 1 is considered to be the same as the term "makes and models" contained in the paragraph 5.1.1 (No.4 item) of the main body of Z17 and paragraphs 5.4 and 9.2.1 of Annex 1 of Z17.

No TB has been expected for the present revision.

#### **5 Other Resolutions Changes:**

None

#### **6 Dates:**

Original Proposal: 03 May 2017 raised by Survey Panel Member

Panel Approval: 16 January 2019 by Survey Panel (Ref: PSU17019)

GPG Approval: 18 March 2019 (Ref: 18214\_IGg)

• **Rev 13 (Jan 2018)**

**1 Origin of Change:**

- Suggestion by IACS Member

**2 Main Reason for Change:**

To address the FUA 11 of C73, raised by the Council of the IACS in respect to the future work directions on the implications of new technology on survey regime. A revision of UR Z17 is in order to consider the new technologies on Remote Inspections (RIT).

To revise UR Z17 to provide clarity by specifying the applicability of mobile offshore drilling units (MODU). The relevant text in Recommendation 77 and PR19 are also revised to be aligned with the UR Z17.

**3 List of non-IACS Member Classification Societies contributing through the TC Forum and/or participating in IACS Working Group:**

None

**4 History of Decisions Made:**

According to the task assigned by GPG on 21th October 2016 the Panel analysed the issue under PSU16056 by concluding that the UR Z17 needed to be modified in order to:

- Update the annex 1 section 3 by adding the ROV (Remote Operated Vehicles)
- Add a new paragraph to the annex 1 dealing with the certification of the suppliers providing services related to the surveys carried out with RIT (Remote Inspection Techniques)

During the 25<sup>th</sup> Survey Panel meeting the members agreed the updating of the paragraph 3 of annex 1.

During the 26<sup>th</sup> Survey Panel meeting, the new paragraph 16 was agreed by the panel.

The proposed amendments by panel member were discussed and agreed under the task PSU17015. The applicability of mobile offshore units had been agreed to be inserted into the content under merged discussion with PSU16056 during the 26<sup>th</sup> Survey Panel meeting.

No TB as been expected for the present revision.

**5 Other Resolutions Changes:**

UR Z3, UR Z7, UR Z10.3

**6 Dates:**

Original Proposal: 21 October 2016 assigned by GPG

05 May 2017 raised Survey Panel Member

Panel Approval: 08 December 2017 by Survey Panel (Ref: PSU16056+PSU17015)

GPG Approval: 16 January 2018 (Ref: 16151\_IGq)

- **Rev 12 (Nov 2016)**

### **1 Origin of Change:**

- Suggestion by IACS Member

### **2 Main Reason for Change:**

- To provide clarity for the provisions for the certifications of the Supervisors and the Operators of certified service suppliers engaged in thermographic testing of primary and secondary barriers of gas carriers with membrane cargo containment systems.

### **3 List of non-IACS Member Classification Societies contributing through the TC Forum and/or participating in IACS Working Group:**

None

### **4 History of Decisions Made:**

Panel Members examined the request of clarification related to the different scheme of certification for Supervisors and Operators expected by paragraphs 15.4.3, 15.4.4 and 15.4.6 of the section 15 of the Annex 1 to UR Z17. In particular two issues have been highlighted:

- 1) The apparent contradiction between the allowed standard SNT-TC-1A, for certification and the sentence "*Certification by the supplier is not allowed and must be obtained through an independent certification body*" contained in paragraphs 15.4.3, 15.4.4 and 15.4.6, since the standard is an industry standard which can be used by the service suppliers to develop their employer-based in-house training and certification managed by themselves
- 2) The fact that the paragraphs 15.3.2, 15.3.3 & 15.3.5 have not such limitation (for instance that the certification of the Supervisor and Operators should be obtained through an independent body).

Panel through the help of the PT Manager of PT PSU 23/2014, which developed the draft of the section 15 of Annex 1 to UR Z17, sought the explanation of the limitation that paragraphs C imposes to the use of the standard STN-TC-1A.

PT Manager explained that the limitation was imposed because PT considered the recommendation by the system designer of membrane tanks that the thermographic non-destructive examination was a new procedure of test of the secondary barriers for cargo tank system of the gas carrier and thus the operators and technicians of such tests should not be certified through an employer certification scheme. So PT took precautions and restricted the requirements for thermographic testing just because this was a new procedure

Members concurred with the explanation provided by the PT Manager but at the same time agree the need to eliminate the contradiction present in the texts. The qualified majority of the Panel agreed the modification of the text of paragraphs 15.4.3, 15.4.4 and 15.4.6 by removing the sentence related to the limitation and introducing a new sentence which clarifies the use of the SN-TC-1A certification standard.

No TB as been expected for the present revision.

## **5 Other Resolutions Changes:**

None

## **6 Dates:**

Original Proposal: April 2014 Made by Statutory Panel  
Panel Approval: 08 September 2016 by Survey Panel (Ref: PSU16020)  
GPG Approval: 28 November 2016 (Ref: 16160\_IGe)

## **• Rev 11 (June 2015)**

### **1 Origin of Change:**

Suggestion by IACS Members

### **2 Main Reason for Change:**

- To verify the compliance of the UR Z17 with the provisions of the R.O. Code (in particular paragraphs 4.2.4, 5.9 and 5.10).

### **3 List of non-IACS Member classification societies contributing through the TC Forum and/or participating in IACS Working Group:**

None

### **4 History of Decisions Made:**

At the 20<sup>th</sup> IACS Survey Panel Meeting, The Chairman of the Panel highlighted to the Members that in all probability this will be a matter of discussion when the UR Z17 will be revised against the R.O. Code. As a consequence of this argument the Chairman recalled that the PT originally in charge of URZ 17 amendments replied to the comment of above GPG Members that the PT was not originally tasked to verify the consistency of UR Z17 towards the requirements of R.O. Code and that it did not perform any action in this sense because the task will require several time in order to be completed.

Members commented that probably a new PT will be necessary in order to comply this duty and that sooner or later the new PT will need to be dealt with, also considering that R.O. Code will enter into force on 1<sup>st</sup> January 2015. In addition Members argued that the UR Z17 is only one of the matters that should be verified towards the provision of R.O. Code and probably more than a PT will be required if Panel want to consider the same activity for all PRs, URs and UIs that may be interested by the Code.

Some Members expressed it would be better to carry out an Impact Analysis of the R.O. Code whilst other Members were of the opinion that it would be better to have only a PT that deals with all aspect of R.O. code instead of a fragmentation of PTs.

All members agreed with the proposal to set up a new PT in order to verify the compliance of the UR Z17 in respect to the R.O. Code.

The Chairman proposed to establish a new PT so that it will be submitted as a proposal to GPG.

At the IACS GPG 77 Meeting, it had been decided to request the Panel to consider a one man PT for this task in order to try to save time and speed up the matter.

PT 25/2014 (one man PT) dealt with the matter of the revision 11 of UR Z17. PT drafted a proposal of modification which was discussed and commented by the Panel by correspondence.

In conjunction Survey Panel examined three substantial comments, made by a GPG Member during the approval of the revision 10, assigned to the Panel by GPG with the recommendation to deal with them in the course of the current revision of the UR Z17. Members concurred with all the comments and the UR Z17 has been modified accordingly.

During the 21<sup>st</sup> Survey Panel Meeting members finalised the revision 11 of UR 17 which addresses:

- the compliance to the R.O. Code (MSC 349(92))
- the three substantial comments received by the GPG.

See TB document in Part B.

## **5 Other Resolutions Changes:**

None

## **6 Dates:**

Original Proposal: October 2014    *Made by: Statutory Panel*  
Panel Approval: 31 March, 2015 by Survey Panel (Ref: PSU14034)  
GPG Approval: 03 June 2015 (Ref: 14184\_IGd)

## **• Rev 10 (Jan 2015)**

### **1 Origin of Change:**

- Suggestion by IACS Members

### **2 Main Reason for Change:**

-To clarify the manufacturer's authorization /approval regarding the service suppliers to perform the services.

-Proposals of Members to revise/add the provisions of UR Z17 in order to comply with the mandatory conventions.

-introduction of a new category of service suppliers that performs acoustic and/or thermographic emissions.

### **3 List of non-IACS Member classification societies contributing through the TC Forum and/or participating in IACS Working Group:**

None

### **4 History of Decisions Made:**

During reply to an external inquiry Statutory Panel identified some changes/additional requirements to UR Z17 and suggested GPG to instruct Survey Panel for considering these amendments to UR Z17.

After reviewing the amendments identified by Statutory Panel, Survey Panel proposed GPG to form a Joint PT with Statutory Panel considering that statutory items are entangled with UR Z17.

GPG agreed to discuss the amendments to UR Z17 by a PT and approved the formation of a joint Survey/Statutory Panel PT under the leadership and budget of Survey Panel.

PT discussed the changes/additional requirements identified by Statutory Panel as well as other additional proposals of IACS Members and finally produced draft revised UR Z17.

Draft revised UR Z17 submitted by PT was further reviewed by both the Survey and Statutory Panels. Survey Panel discussed and revised the draft as appropriate. PT was re involved to review the comments/revisions made by Statutory and Survey Panels. Finally, Survey Panel, in consultation with Statutory Panel, agreed with the latest draft revised UR Z17.

Following the examination by part of GPG some substantial comments raised. The drafted revision 10 of UR Z17 was returned to Survey Panel with all GPG Comments.

Panel and PT dealt with the comments by agreeing modifications to be applied to the draft. Final version of the revised draft, which will include the provisions for the new category of Service Suppliers carrying the global vacuum testing of primary/secondary barriers, acoustic and thermographic emissions test (agreed under Survey Panel task PSU 13040), has been approved by Survey Panel at 20<sup>th</sup> Meeting (September 2014).

### **5 Other Resolutions Changes:**

None

### **6 Dates:**

Original Proposal: October 2010, made by: Statutory Panel  
Panel Approval: 3 September 2014, by Survey Panel (Ref: PSU10039)  
GPG Approval: 20 January 2015 (Ref: 9644aIGq)

- **Corr.1 (August 2012)**

**1 Origin of Change:**

- Suggestion by an IACS member

**2 Main Reason for Change:**

Reference to PR34 was removed from UR Z17 in Rev.9, however the changes in Rev.9 do not become effective until 1 July 2013 whereas PR34 was deleted on 1 July 2012. Therefore it was considered appropriate to issue a correction to UR Z17 Rev.9 to clarify that the changes of the references to PR34 become effective immediately.

**3 List of non-IACS Member classification societies contributing through the TC Forum and/or participating in IACS Working Group:**

None

**4 History of Decisions Made:**

The proposal was made by an IACS GPG member. PermSec drafted the correction.

**5 Other Resolutions Changes:**

None

**6 Dates:**

Original Proposal: *6 July 2012 Made by a Member*  
GPG Approval: *08 August 2012 (Ref:11090\_IGq)*

- **Rev 9 (June 2012)**

**1 Origin of Change:**

- Based on IMO Regulation (MSC.288(87))

**2 Main Reason for Change:**

Imminent need for paint industry to produce approved products prior to the statutory entry into force of the resolution (1 January 2012), while requirements will be mandatory on 1 January 2013.

**3 List of non-IACS Member classification societies contributing through the TC Forum and/or participating in IACS Working Group:**

None



#### **4 History of Decisions Made:**

EG/Coating discussed this issue and, due to disbanding EG/coating, passed it onto the Statutory Panel through GPG.

The proposed revision of UR Z17 was discussed and agreed by the Statutory Panel through correspondence and 13th Statutory Panel Meeting.

Survey Panel also reviewed and agreed with the proposed revision of UR Z17. Moreover, agreed conclusion of Survey Panel discussed under PSU 11026 regarding the requirement for in-water survey firms was included to the present revision of UR Z17.

#### **5 Other Resolutions Changes:**

None

#### **6 Dates:**

Original Proposal: *30 September 2010 Made by EG/Coating*  
Panel Approval: *October 2011 by Statutory Panel (Ref: SP11012)*  
*April 2012 by Survey Panel (Ref: PSU12011)*  
GPG Approval: *26 June 2012 (Ref: 9638fIGf)*

- **Rev.8 (Jul 2008)**

Text added to Annex 1 section 13 to refer to new Recs 101 & 102, and also text covering approval of labs with which Members are involved (Ref: 7693\_).

No TB document available.

- **Rev.7 (Nov 2007)**

New Section 13 added to Annex 1 covering requirements for firms engaged in testing of coating systems in accordance with IMO Res. MSC.215(82) and PR34 (Ref: 5093h).

No TB document available.

- **Rev.6 (Jun 2007)**

See TB document in Part B.

- **Rev.5 (Feb 2004)**

See TB document in Part B.

- **Rev.4 (Jul 2003)**

WP/SRC Task 99 VDRs included. WP/SRC Task 107 LL lighting and sound pressure level measurement included. Ref: 0126g

No TB document available.

- **Rev.3 (Jul 2002)**

See TB document in Part B.

- **Rev.2 (Nov 1999)**

See TB document in Part B.

- **Rev.1 (Jun 1999)**

See TB document in Part B.

- **New (1997)**

No TB document available.

## **Part B. Technical Background**

List of Technical Background (TB) documents for UR Z17:

Annex 1. **TB for Rev.1 (Jun 1999)**

See separate TB document in Annex 1.

Annex 2. **TB for Rev.2 (Nov 1999)**

See separate TB document in Annex 2.

Annex 3. **TB for Rev.3 (Jul 2002)**

See separate TB document in Annex 3.

Annex 4. **TB for Rev.5 (Feb 2004)**

See separate TB document in Annex 4.

Annex 5. **TB for Rev.6 (Jun 2007)**

See separate TB document in Annex 5.

Annex 6. **TB for Rev.9 (June 2012)**

See separate TB document in Annex 6.

Annex 7. **TB for Rev.10 (Jan 2015)**

See separate TB document in Annex 7.

Annex 8. **TB for Rev.11 (June 2015)**

See separate TB document in Annex 8.

Annex 9. **TB for Rev.15 (Oct 2020)**

See separate TB document in Annex 9.

*Note: There are no separate Technical Background (TB) documents available for New (1997), Rev.4 (July 2003), Rev.7 (Nov 2007), Rev.8 (July 2008), Corr.1 (Aug 2012), Rev.12 (Nov 2016), Rev.13 (Jan 2018), Rev.14 (Mar 2019), Rev.16 (Aug 2021), Rev.17 (July 2022), Rev.18 (Feb 2023) and Corr.1 (May 2023).*

**Technical Background Document**  
**WP/SRC Task 1-A**  
**UR Z 17 – Proposed Rev. 1**

**Objective and Scope:**

To review existing UR Z 17 to which a reservation has been lodged with a view to eliminating the cause for the reservation and achieving full implementation.

**Source of Proposed Requirements:**

WP/SRC members discussed and reviewed the reservation lodged against the UR. A proposal based upon the member's experience with service suppliers was agreed to and contained in the proposed draft. An additional item was changed to clarify the use of ultrasonic thickness measuring devices in Annex 1.

**Points of Discussion:**

WP/SRC unanimously agreed to the proposed draft UR Z 17.

Date of submission: 6 May 1999  
By WP/SRC Chairman's e-mail

**Technical Background Document  
WP/SRC Task 68  
UR Z17 – Proposed Draft Revisions 9 (Rev.2 1999)**

**Objective and Scope:**

Revise UR Z17 to meet the requirements of IMO Res A.789(19) for Radio Specialists and other small companies such as diving and gauging.

**Source of Proposed Requirements:**

The proposed requirements were developed by WP/SRC members through correspondence and their meeting by incorporating the requirements of IMO Res A.789(19) into UR Z17.

**Points of Discussion:**

1. 4.2.2 was amended to allow external training where internal training was not possible. The members were all in agreement.
2. 4.2.3 was amended to clarify that for a one person company, that person must meet the requirements of a supervisor. The members were all in agreement.
3. Annex I / 6.4 was amended to include the specific requirements of Res A.789(19). The members were all in agreement.
4. A proposal to require an intermediate audit for a one person supplier did not receive the support of the members.

submitted by WP/SRC Chairman  
on 12/10/1999

**Technical Background Document  
UR Z 17 – Rev. 3  
(approval of TM Firms and Life-raft servicing stations)**

**Objective and Scope:**

1. To require that new or renewed approval of TM Firms should be valid for the maximum 3 years.
2. To reflect the GPG 52 (March 2002) decision that IACS should seek agreement from the flag Administrations to:
  - approve the service stations in accordance with UR Z17;
  - accept the service stations approved by the flag Administration itself or other authorized ROs; or
  - accept the service stations approved by other SOLAS contracting governments.

**Points of Discussion**

**1. TM Firms**

- As a result of the first Quality Management Review at Council 44 (December 2001), Council decided that:
    - the validity of approval certificate of TM Firms should be 3 years maximum.Council instructed GPG to amend relevant URs accordingly
  - IACS should develop a database to record any change in the status of TM Firms and post it to the IACS web page.
- Table VII of Z10.1 (Table V of Z10.2, Table VII of Z10.3) reads that “Renewal or endorsement of the Certificate is to be made at intervals not exceeding 3 years by verification that original conditions are maintained”.
- GPG introduced the same wording to Z17. See section 5.2 of Z17(Rev.3).

**2. Liferaft servicing stations**

- A member submitted a draft revision to UR Z17 on 19 April 2002 (0126cABb, GPG 52 FUA 61). It is to allow Members to accept statutory service suppliers which had been approved by organizations acceptable to the Flag of the ship with a view to facilitating Members removing their reservations against UR Z17 which were declared when they realized that they were accepting service suppliers approved by the government of the country where the service supplier is located without knowing whether this is acceptable to the Flag Administration. See section 1.2 of Z17(Rev.3).
- Meanwhile, noting that there were still many Administrations who had replied “No” to the question “Accept other governments’ approval”, GPG agreed that IACS submit a paper to IMO MSC 76 with the UK’s sponsorship suggesting that they allow Members to accept such approvals when acting on their behalf. This paper proposed that the same consideration be given to servicing stations servicing inflatable lifejackets, MESs and inflatable rescue boats.

(For actual action taken by GPG, refer to GPG correspondence under 9126c.  
This note was added on 31 July 2002)

\* \* \* \* \*

Date of submission: 13 May 2002  
Permanent Secretariat

## Technical background UR Z17 Rev.5

### Background

A member requested a clarification of the uniform scope of application of requirements for approved TM firms in UR Z17. The member's position was that certification of thickness measurement firms are only required for ESP vessels as there is no mention in UR Z7 requiring this certification.

Furthermore, current revision 3 of Z17 in Annex I state: quote "1.6 Reporting. The report shall be based on the guidelines given in UR Z10.1, Z10.2 or Z10.3, as relevant." unquote. This to the member indicates that when the wording originally was established, ESP vessels only were to comply with this requirement.

### WP Discussion

The WP/SRC discussed this issue at two meetings and by correspondence.

1. It appeared that there was little support in the Working Party for the member's position that UR Z17 only requires approval of TM firms doing thickness measurements of ESP vessels. Several members require a UR Z17 certified TM firm for all hull thickness measurements on all types of ships. The majority of the members agreed with the member that there were practical problems applying the full certification requirements of Z17 to all vessels, in particular for small vessels, in small yards and in remote areas.

2. Member then requested that the Working Party should consider to exclude the certification of TM firms for non-ESP vessels under 90 meters in length from the scope of Z17.

3. However, there was a clear majority in the Working Party for the view that UR Z17 need not apply to non-ESP ships below the SOLAS limit of 500 gross tonnage and also to except all fishing vessels.

### WP Conclusion

The conclusion of the discussion in the Working Party is that the wording of UR Z17 is proposed to be changed as follows:

#### 3.1.1 Class services

- Firms engaged in thickness measurements on ships except non-ESP ships less than 500 gross tonnage and all fishing vessels
- Firms engaged in tightness testing of hatches with ultrasonic equipment
- Firms carrying out in-water survey of ships and mobile offshore units
- Firms engaged in the examination of Ro-Ro ships bow, stern, side and inner doors.

and Annex I of Z17 be changed as follows:

1.1 Extent of engagement - Thickness measurement of structural material of ships except non-ESP ships less than 500 gross tonnage and all fishing vessels.

1.6 Reporting. The report shall be based on the guidelines given in UR Z10.1, Z10.2, Z10.3, Z10.4, Z10.5 and UR Z7.1 as relevant.

Furthermore, UR Z7 has to be amended to include a requirement for certification of TM companies for ships of 500 gross tonnage and above except fishing vessels.

12 February 2004 3006hIAb

(similar to para 6.2 and Table IV of UR Z7.1)

### **GPG discussion**

GPG concurred, except that a member reserves on the lower size limit, holding to a limit of 90m length vice 500gt.

### **Council discussion**

Council approved it on 25 February 2004. a member recorded as follows:

**"Quote"**

Subject: 3006hxxx: WP/SRC-Task 3-UR Z17-TM firms. (Date: 26 Feb 2004)

In reply to ICa, 12 Feb:

1. the revision of UR Z17 circulated with IAb, 12 Feb, is not acceptable to the member.
2. As we have pointed out in the WP/SRC and in GPG, member classes a large fleet of small vessels and we know that:
  - a. there are very extensive practical problems in getting approved TM firms for the taking of the relatively limited gaugings required on smaller vessels, in small yards, in remote areas and locations; and that
  - b. small vessels (under 90m L) do not have longitudinal strength issues of large ships--for which very extensive and controlled gaugings are essential--they have local strength issues which can normally be easily identified. Controls of the TM process can, in these cases, be much simpler while still wholly effective.
3. member therefore maintains the reservation declared at GPG against this revision of this UR as stated in the TB attached to IAb. (i.e. member will not require approved TM firms for gauging of non-ESP ships less than 90 m in Length.)
4. Though Chairman has concluded that the revision of the UR has been adopted, we again encourage Members to reconsider their position on this revision of this UR and to agree with member' proposed limits for the use of approved TM firms for structural gaugings.

Regards,

IACS Council Member

**"Unquote"**

\*\*\*\*\*



## **TECHNICAL BACKGROUND**

### **UR Z17 (Rev.6), June 2007**

#### ***(Survey Panel Task 1 – Annual Review of Implementation of IACS Resolutions)***

#### **1. Objective**

To keep IACS Resolutions up to date through annual reviews.

#### **2. Background**

To keep IACS Resolutions up to date through annual reviews.

#### **3. Methodology of Work**

Survey Panel members through correspondence.

#### **4. Discussion**

Survey Panel members were of the opinion that UR Z17 was not in line with current practice of members' methods of acceptance of technicians as external specialists, through the audit of only the headquarters of a company that had in place an accepted quality system that the company and its field offices followed.

Members agreed that relevant sections of UR Z17 needed to be amended to account for quality systems in place for companies that are accepted as external specialists.

Members also agreed that references to applicable quality standards (ISO 9000 series) needed to be updated to reference current standards, throughout the UR.

#### **5. Implementation**

The Survey Panel is of the view that the Members need 6 months from the adoption date to implement these amendments into their Procedures. Assuming that GPG and Council approve to the amendments, the Survey Panel would propose January 2008 as an implementation date.

Submitted by Survey Panel Chairman  
22 May 2007

#### **Permanent Secretariat note (June 2007):**

Amendments to UR Z17, with implementation date of 1 January 2008, adopted 14 June 2007 (7576\_IGe).

## Technical Background for UR Z17 Rev.9, June 2012

### 1. Scope and objectives

To provide the same guidelines provided for MSC.215 (82) given in section 13 of annex 1 to UR Z17 for MSC.288 (87).

### 2. Engineering background for technical basis and rationale

Owing to the difference of testing environment between MSC.215 (82) (coating systems for ballast water tanks) and MSC.288 (87) (coating systems for cargo oil tanks of crude oil tanker), another set of test laboratory approval procedure is required.

### 3. Source/derivation of the proposed IACS Resolution

None

### 4. Summary of Changes intended for the revised Resolution

Revised to meet the requirements of MSC.288 (87)

### 5. Points of discussions or possible discussions

1. In general, the EG/Coating agreed that there is a need to develop a new procedure for the approval of testing laboratories against MSC.288 (87).
2. The EG/Coating agreed, rather than revising existing section 13 of UR Z17, create a new section on PSPC-COT testing laboratories so that the laboratory can choose whether they will conduct testing only for MSC.215 (82), or MSC 288 (87) or both.
3. The EG/Coating developed the draft text of the new section 14 of UR Z17. However, noting that the requirements has not been coming into force yet, and noting the precedence of the IACS Recommendation on Expert Parties Engaged in Visual and/or Sampling Checks for Preparation of Inventory of Hazardous Materials, the Group developed a draft text of new recommendation with a view to incorporating this recommendation into UR Z17 at a future occasion.
4. After this matter was passed onto Statutory Panel, GPG instructed the Statutory Panel to develop a draft revision of UR Z17 using the draft Recommendation developed by EG/Coating as a basis.

### 6. Attachments if any

None

## **Technical Background for UR Z17 Rev.10 (Jan 2015)**

### **1. Scope and objectives**

- To consider the revision of UR Z17 in order to clarify the manufacturer's authorization /approval regarding the service supplier to perform the service
- To identify any other revisions required for UR Z17 by evaluating the proposals of Members

### **2. Engineering background for technical basis and rationale**

Manufacturer's approval regarding the service supplier to perform the service was considered. Approval and utilization of service suppliers for classification and statutory services were discussed and clarified. Accordingly, approved service suppliers were categorized which are not mandatorily required unless otherwise instructed by the flag administration (with respect to the scope of statutory certification).

### **3. Source/derivation of the proposed IACS Resolution**

None

### **4. Summary of Changes intended for the revised Resolution**

- New section 'definitions' was introduced to clarify the terms related to the approval of Service suppliers.
- Requirements for manufacturer's approval regarding the service supplier were included.
- Requirements regarding the utilization of service suppliers for classification and/or statutory services were clarified.
- Procedures for firms engaged in servicing and maintenance of lifeboats, launching appliances and firms engaged in measurements of noise levels were newly introduced.
- Approval procedures for firms listed in Annex 1 were amended/updated in order to comply with the mandatory conventions.
- The requirements for the new category of service suppliers, carrying global vacuum testing of primary/secondary barriers, acoustic and thermographic emissions tests, has been introduced. This new category is related to Statutory and Class services, and concerns the tightness test of the membranes of the cargo vessels (of the gas carriers). Requirements have been drafted by a dedicated project team (PSU 23/2014) under the Survey Panel Task PSU 13040. The final attachment to the UR Z17, containing the requirements, has been agreed by the Panel at 20<sup>th</sup> Meeting (September 2014).

### **5. Points of discussions or possible discussions**

1. PT discussed the changes/additional requirements identified by Statutory Panel members as well as other proposals of IACS members and produced draft revised UR Z17.
2. Survey Panel reviewed the proposed amendments submitted by PT. Survey Panel rearranged the main part of the UR Z17 regarding the services of the approved service suppliers to be required mandatorily or not.

3. Statutory Panel reviewed the draft revised UR U17 which was further amended and agreed by Survey Panel. Comments made by Statutory Panel were further reviewed by PT.
4. GPG reviewed the draft and made substantial comments which were further re-examined by the Survey Panel and by the PT. Comments led to perform small modification in to the drafted text.

**6. Attachments if any**

Nil

## **Technical Background for UR Z17 (Rev.11, June 2015)**

### **1. Scope and objectives**

- To verify the compliance of the UR Z17 with the provisions of the R.O. Code (in particular paragraphs 4.2.4, 5.9 and 5.10).
- The objectives of this PT are related to the alignment of the UR Z17 Revision 10 with the provisions of the R.O code

### **2. Engineering background for technical basis and rationale**

The PT has performed a gap analysis between the RO code i.e. MSC.349(92) and MEPC.237(65) and the latest version of UR Z17, as developed by the Survey Panel under PSU10039 and referred to as Rev 11.

### **3. Source/derivation of the proposed IACS Resolution**

None

### **4. Summary of Changes intended for the revised Resolution**

1. It was decided that it was not necessary to implement the paragraph 4.2.4 of the RO code into the UR which concerns the subcontracting of radio surveys to non-exclusive surveyors.
2. Existing paragraph 3 of the UR, where the definition of the Service Supplier has been aligned with the part 2 para. 5.9.2 of the RO code. In fact the provided services carried out address either a ship or a mobile offshore drilling unit.
3. With reference to part 2 para. 5.9.1 of the RO code, a new paragraph 4.13 has been added into the UR. it encompasses the services provided by a third party except the references to outsourcing or subcontracting which are not the aim of the UR Z17.
4. Existing paragraphs 4.2 and 4.3 of the UR, where the results provided by the service suppliers are used by the Society in making decision affecting class and statutory certification. The two above paragraphs have been aligned with the part 2 para. 5.9.2 of the RO code.
5. Existing paragraph 5.2.5 of the UR has been aligned with the part 2 para. 5.10.4 of the RO code. This amendment takes account cases where equipment has been shown to be defective or outside specified limits and/or requirements, the Society shall examine the effect of the defect on previous tests. The Society shall verify any possible biased measurement that could have been performed with defective equipment and therefore, the relevant records are to be kept available on board.
6. With reference to part 2 para. 5.10.5 of the RO code, a new paragraph 5.2.6 has been inserted into the UR, It covers the control of data in monitoring and measuring equipment, in particular when computers are used for the acquisition,

processing, recording, reporting, storage, measurement assessment and monitoring of data, the computer software developed by the supplier shall be suitably validated as being adequate for use. Commercial software, as provided by equipment suppliers, may be considered as sufficiently validated if used within their application range.

7. The requirements have been drafted by a dedicated project team (PSU 25/2014) under the Survey Panel Task PSU 14034. The final attachment to the UR Z17, containing the new requirements, has been agreed by the Panel at 21<sup>st</sup> Meeting (March 2015).
8. In addition to the above the following three substantial comments to revision 10, received by the GPG, have been examined by the Panel:
  - UR Z17 should not refer to the service supplier's actions as a "survey" ; this should be checked throughout the document. Perhaps we should to identify their actions as inspections and the classification society's overview as the survey.
  - the last sentence of the fourth bullet of 5.1.1 gives no guidance: "Possible terms of termination of such authorization are to be considered in connection with the renewal of the service supplier's certificate." Does IACS even need the last sentence of that bullet given that the first sentence of 6.2 states "Renewal or endorsement of the Certificate is to be made at intervals not exceeding five (5) years by verification through audits that approved conditions are maintained or, where applicable, on expiry of the supplier's approval received from an equipment Manufacturer, whichever comes first?"
  - With respect to 5.2.8, why are subcontractors providing subcontracted personnel excepted from the obligations of 5.2 and 5.5, and training in particular? According to the definitions the subcontractor is to assume the obligations of the service provider. If the assumption is that the primary service provider will fulfill all the general requirements of 5.2, and in particular supply the training to the subcontracted personnel this should be stated.

Panel concurred with the suggested modifications which have been applied to the revision 11

## **5. Points of discussions or possible discussions**

1. PT discussed the results of the gap analysis between the RO code and the Rev 10 of UR Z17 Statutory Panel members and produced draft revised of UR Z17.
2. Survey Panel reviewed the proposed amendments submitted by PT. Survey Panel rearranged the main part of the UR Z17 regarding the wording of certain new requirements

## **6. Attachments if any**

Nil

**Technical Background (TB) document for UR Z17 (Rev.15 Oct 2020)  
and UR Z23 (Rev.7 Oct 2020) and UR Z28 (New Oct 2020)**

**1. Scope and objectives**

For addressing the complicated and arduous activities associated with the class inspections required for assuring the integrity of the pressure rated multi-cable transit (MCT) systems installed onboard ships or mobile offshore units (MOUs) from the time of their construction till the end of the ship's life, IACS took the decision:

- to develop new unified requirements on the survey of MCT systems, to be included in URs Z23, Z7 and Z15, based on the use of approved service suppliers to conduct the inspections of MCT systems; and consequently,
- to develop the relevant criteria for the certification of these service suppliers, to be included in UR Z17.

**2. Engineering background for technical basis and rationale**

IACS Survey Panel, based on the information provided by various MCT system OEMs to the specific Project Team (PT) established for this task, identified the following items to be considered for drafting the survey requirements:

- A. conduct regular inspections to assure good condition of MCT systems, identify possible problems and address repairs in a timely manner;
- B. assure the traceability and product document for MCT systems through their lifecycle;
- C. apply easy to use technologies (digitization, RFID etc.) to store MCT system condition information;
- D. utilize external specialists to perform inspections and to supplement Surveyor's efforts;
- E. analyze repair-data to identify trouble-prone components or systems for proactive attention;
- F. standardize inspection and test methods in accordance with OEM recommendations.

IACS Survey Panel acknowledged the following added values in the use of external specialists for the inspection of MCT system and in the adoption of a MCT system register:

- A. a means to uniformly carry out the inspection of MCT system across all the class societies;
- B. an expert focus on an acknowledged weak-point of bulkhead integrity through the life cycle of a vessel or marine asset;

- C. a system by which MCT systems installation can be tracked throughout their life cycle.

### **3. Source/derivation of the proposed IACS Resolution**

- A. Industry feedback originating from known casualties and repetitive incidents of poorly installed and maintained equipment.
- B. OEM best practices and standards for installation and maintenance.
- C. OEM methodologies for documenting and tracking changes, disruptions, repairs or maintenance of MCT system installations.

### **4. Summary of Changes intended for the revised Resolution:**

Changes to Z23 will include new requirements which mandate the adoption of a Multi Cable Transit Seal Systems Register.

The Register, in hard copy or digitized media, will require any MCT system installation to be documented at time of ship's construction. The Register will include a marking / identification system, documentation referencing manufacturer manual(s) for each type of cable transit installed, the Type Approval certification for each type of transit system, applicable installation drawings, and a recording of each installed transit documenting the as built condition after final shipbuilder inspection in the shipyard.

The Register will also include sections to record any inspection, modification, repair and maintenance.

A recommendatory sample Cable Transit Seal System Register will be included in UR Z23 as an attachment.

A new item 8.6 is to be newly inserted into the Table 1 of UR Z23.

Subsequently, a new URZ will be developed in order that the Register will serve as an on board document maintained to track inspections, modifications and repairs and ensure such activities are properly performed by qualified personnel. The Register will also provide the Class Society Surveyor with a tool to improve the effectiveness of periodic inspections on marine vessels at the time of annual and special surveys.

In view of the above, UR Z17 will be revised to include the requirements for the approval of a new category of service suppliers for the inspection of Cable Transit Seal Systems, who will be tasked to verify MCT systems installation. This will assist to promote adherence to proper installation and maintenance procedures.

A new section 17 will be inserted in UR Z17.

### **5. Points of discussions or possible discussions**

5.1 Survey Panel concurred with the view that the fire rated MCT systems and the pipe penetrations should not be considered under this topic, since this task was specifically dealing with Watertight Cable Transits as proposed by the member initiating this issue.



5.2 Survey Panel and PT agreed to define in the Ship Construction File of UR Z23 a document 'Cable Transit Seal System Register' to record the details of watertight cable transits of a ship installed while under construction and throughout its life, including sections to record any inspection, modification, repair and maintenance.

5.3 Survey Panel concurred with the view that criteria should be established to support electronic formatting of the 'Cable Transit Seal System Register', which is the most operationally effective path to assist owners with installation, inspection, maintenance, and repairs throughout the MCT lifecycle, and agreed to include the recommendatory sample of the Cable Transit Seal Systems Register prepared by PT as Appendix 3 of UR Z23.

5.4 Survey Panel agreed to insert a new hull inspection item 8.6 for Watertight Cable Transit Seal System into Table 1 of UR Z23. When discussing whether to enter in the 'Survey Requirements for Classification' with "tightness", some members were of the view that after installation a leak test may be carried out but it is hard to check the actual watertightness of the CTSS, while the other members preferred to testing the watertightness of the CTSS after installation, and finally the panel agreed to leave the requirements of testing of the watertightness of CTSS to be decided by each society individually.

5.5 Survey Panel and PT deemed it necessary to use approved service suppliers to conduct inspections to the MCT/Transit systems, and developed the Section 17 of UR Z17 for the approval of the service suppliers engaged only in the inspections of Cable Transit Seal Systems, with a view that it will be impractical to use an approved service supplier every time for installing or maintaining the Multi Cable Seal Systems, such as when renewing a single cable.

5.6 Provisions for authorization were included in paragraph 17.2.3 of UR Z17 to allow for cases where the transit system OEM is no longer in business or does not provide technical support.

5.7 In paragraph 17.2.1 of UR Z17, it was agreed to include the contents to approve manufacturers or shipyards equally when they are acting as Service Suppliers.

5.8 Other than revising UR Z7 and UR Z15 for the survey requirements of CTSS for ships in service, Survey Panel agreed to develop a new UR Z28 applicable to all vessels and Mobile Offshore Units (MOUs) contracted for construction on or after 1st July 2021, in addition to the requirements of URs Z23, Z7 and Z15.

5.9 Survey Panel agreed to insert item 1.3 to UR Z28, and apply the survey requirement of item 8.6, Table 1 of UR Z23 to MOUs.

5.10 For the paragraph 4.1.3 of UR Z28, one Survey Panel member was of the view that the approved service supplier should also be permitted to undertake inspection of any disruption to the cable transits or installation of new cable transits, otherwise the use of having an approved service supplier is significantly reduced, while the other members supported to confirm those situations by the attending surveyor, and thus the wording "by the attending surveyor" is retained.

**6. Attachments if any**

Nil.

## UR Z18 "Survey of Machinery"

### Summary

This revision to UR Z18 is to include the annual and special survey requirements of the towing winch emergency release systems subject to IACS UR M79.

### Part A. Revision History

Version no.	Approval date	Implementation date when applicable
Rev.9 (Apr 2020)	09 April 2020	1 July 2021
Rev.8 (July 2018)	16 July 2018	1 July 2019
Rev.7 (June 2017)	29 June 2017	1 July 2018
Rev.6 (Aug 2016)	9 August 2016	1 July 2017
Rev.5 (Apr 2015)	07 April 2015	1 July 2016
Rev.4 (Sep 2014)	17 September 2014	1 July 2015
Rev.3 (Apr 2013)	30 Apr 2013	1 January 2014
Rev.2 (Oct 2006)	29 Oct 2006	1 January 2008
Rev.1 (Jan 2006)	31 Jan 2006	1 January 2007
New (Nov 2001)	23 Nov 2001	-

- **Rev. 9 (Apr 2020)**

**.1 Origin of Change:**

- Suggestion by an IACS member

**.2 Main Reason for Change:**

As a reaction on the MAIB Report No. 17/2008, IACS Machinery Panel drafted a new UR M79 "Towing Winch Emergency Release Systems" and then inquired Survey Panel about the survey requirements of such systems, and then Survey Panel agreed to develop relevant survey requirements of such systems.

**.3 List of non-IACS Member classification societies contributing through the TC Forum and/or participating in IACS Working Group:**

None

**.4 History of Decisions Made:**

Machinery Panel suggested to separate the part relevant to survey requirements from the newly drafted UR M79 and include them into UR Z18 (Periodical Survey of Machinery) as a new section.

Survey Panel discussed this matter under Task PSU16030, and agreed with the proposal of Machinery Panel to include the annual and special survey requirements of towing winch emergency release systems into UR Z18 as a new paragraph 5, with the following discussions:

- The purpose of the newly developed paragraph 5 is only for the vessels subject to UR M79.
- The panel concurred with the view that the requirement for strong points to be used for testing of winch emergency release system is also the part of information "documented method for annual survey", and agreed not to include this requirement in paragraph 5.1.1.
- In view of that the performance requirements of Section 3.1 of UR M79 are not deemed to be always and actually feasible to verify at the time of the annual survey, more feasible provisions are entered into annual survey items 5.1.2 and 5.1.3 for verifying the compliance of the emergency source with the requirements set by UR M79 para 3.1.5 and 3.1.7;
- Realizing that UR M79 – para. 3.1.3 defines a maximum time delay for emergency release system, but not its documentation at operating positions, Panel members agreed to use the wording in para. 5.1.5 similar to UR M79 – para. 4.1.3.

When consider the survey requirements of annual survey according to UR M79, Survey Panel noted that:

- 1) At the time of the annual surveys, it is to be ascertained that the documentation required by para 3.2.10 is available on board, and the survey of the winch emergency release system is to be carried out in accordance with such a documentation; and
- 2) In the new M79 there are no indication/requirements about the responsibilities for the preparation and the review/acceptance (or approval) of the procedure required by 3.2.10.

Survey Panel concurred with the view that these issues should be clarified by Machinery Panel before the draft revision to UR Z18 being finalized, and then raised these issues to Machinery Panel, with the following recommendations: 1) para 3.2.10 of UR M79 may be considered to be absorbed into para 4.1.3, 2) para 3.2.11 of UR M79 may be moved into section 4 and the wording is to be updated to include 'Special Survey'.

Machinery Panel after a long-term consideration, further revised UR M79 and submitted Revision 1 of UR M79 to GPG under task No. PM19919.

Survey Panel then finalized the draft revision to UR Z18 based on the TB and the text of Revision 1 of UR M79.

The implementation date of this revision was agreed to be set as 1<sup>st</sup> July 2021.

No TB is expected for the present revision.

**.5 Other Resolutions Changes:**

None

**.6 Any hinderance to MASS, including any other new technologies:**

None

**.7 Dates:**

Original Proposal: November 2016 Made by Machinery Panel (Ref: PM11909\_PMb)  
Panel Approval: 17 December 2019 (Ref: 19235\_PYa)  
GPG Approval: 09 April 2020 (Ref: 19235\_IGj)

**• Rev.8 (July 2018)**

**1 Origin of Change:**

- Suggestion by IACS members

**2 Main Reason for Change:**

To address the FUA 11 of C73, raised by the Council of the IACS in respect to the future work directions on the implications of new technology on Remote Monitoring/Diagnosis (RMD) and Condition Based Inspecting/Maintenance (CBM). Survey Panel discussed the issue and agreed to establish a PT to provide suggestions for the possible revisions of the relevant IACS Resolutions and Recommendations (e.g. UR Z18, UR Z20, Rec.74) and the draft of new Recommendations/Guidelines which may help the concrete application of these technologies.

**3 List of non-IACS Member Classification Societies contributing through the TC Forum and/or participating in IACS Working Group:**

None

**4 History of Decisions Made:**

Survey panel discussed this issue under Panel task PSU16057 allocated by GPG on 21th October 2016. The subject deals with the review of the UR and Recommendation under Panel responsibility in order to determine whether a revision could need in order to consider the new technologies on Remote Monitoring/Diagnosis (RMD) and Condition Based Inspecting/Maintenance (CBM).

In this respect the Survey Panel discussed the topics and agreed that a PT dealing with the matters would be advisable in order to provide suggestions for the possible revisions of the relevant IACS Resolutions and Recommendations (e.g. UR Z18, UR Z20, Rec 74) and the draft of new Recommendations/Guidelines which may help the concrete application of these technologies.

PT PSU34/2017 was established, and made revisions mostly addressing the following:

- Insert new paragraph "1.5 Planned Maintenance Scheme".
- Insert new paragraph "1.6 Condition Monitoring / Condition Based Maintenance".

During the 26th Survey Panel meeting, panel members concurred with comments on PT's submission and proposed actions were taken by the PT. Survey Panel reviewed the drafts which was further amended and agreed by Survey Panel.

Refer to TB Document in Annex 4.

## **5 Other Resolutions Changes:**

UR Z20, UR Z27

## **6 Dates:**

Original Proposal: 21 October 2016 assigned by GPG  
Panel Approval: 28 June 2018 by Survey Panel (Ref: PSU16057)  
GPG Approval: 16 July 2018 (Ref: 16151\_IGz)

- **Rev.7 (June 2017)**

### **.1 Origin of Change:**

- Based on the proposal of an IACS Member

### **.2 Main Reason for Change:**

Provision of survey requirements for on-board test of propulsion systems and their controls, discussed under task No. PSU16052.

### **.3 List of non-IACS Member classification societies contributing through the TC Forum and/or participating in IACS Working Group:**

None

### **.4 History of Decisions Made:**

As reaction on MAIB Report no. 09/2012 and 31/2014 Machinery Panel drafted UR M25 Rev.4 "Astern power for main propulsion" and sought advice of Survey Panel on the related survey requirements.

Survey Panel discussion was carried out under PSU16052. Panel members agreed that there is no need to issue a new UR and the UR Z18 will be modified accordingly in order to accommodate the issues proposed by the Machinery Panel, and developed a newly added paragraph 4.2 to UR Z18 which aims to the provision of survey requirements for on-board test of propulsion systems and their controls;

Survey Panel also agreed to amend the title of UR Z18 from "Periodical Survey of Machinery" to "Survey of Machinery", and to move the "Note" in the end of the URZ to paragraph 1 as "1.4 Surveys of Commercial Vessels Supporting Military Use".

For Rev.7 no TB is provided.

**.5 Other Resolutions Changes:**

None

**.6 Dates:**

Original Proposal: October 2016 Made by Machinery Panel (PM12601\_PMa)

Panel Approval: 15 June 2017 (Ref: PSU16052)

GPG Approval: 29 June 2017 (Ref: 12095\_IGk)

**• Rev.6 (Aug 2016)**

**.1 Origin of Change:**

- Based on the proposal of an IACS Member

**.2 Main Reason for Change:**

A Panel Member proposed the discussion about the surveys of boilers that may have not sufficient spaces to grant the surveyor accessibility, such as some smoke type boilers of cylindrical construction, or that may present components of limited dimensions (e.g. some water drums in certain watertube boilers or coil type steam generators/boilers with no direct access to the coil internal surfaces).

**.3 List of non-IACS Member classification societies contributing through the TC Forum and/or participating in IACS Working Group:**

None

**.4 History of Decisions Made:**

Survey Panel discussed this issue during the 23<sup>rd</sup> Survey Panel by concurring that a modification of the paragraph 2.1 of the UR Z18 needed. Further the Panel Secretariat prepared a first draft of the intended modification and the discussion take place also considering the possibility of include the remote inspection technology as explained in to the IACS recommendation 42. The initial proposal was supplemented by other suggested by some Members. In addition, the meaning of "limited size of the internal spaces" for boiler without adequate space for inspection was discussed and it was agreed that establishing a common standard for all such boilers would be difficult because of differences in the body size of surveyors.

Finally the qualified majority of the Panel Members agreed the draft text of the modification.

A new sentence has been introduced at the end of paragraph 2.1.

No TB is expected for this revision.

## **.5 Other Resolutions Changes:**

None

## **.6 Dates:**

Original Proposal: March 2016 Made by a Member

Panel Approval: 07 June 2016 (Survey Panel task, Ref PSU16014)

GPG Approval: 09 August 2016 (Ref: 16116\_IGc)

## **• Rev.5 (Apr 2015)**

### **.1 Origin of Change:**

- Based on the proposal of an IACS Member

### **.2 Main Reason for Change:**

Following a query made by a Panel Member seeking the advice of the in granting an extension of the Boiler Survey when the due date of the survey coincides with the due date of the Class Renewal Survey for which an extension has been already granted. The query was completed with the proposal of modification of the paragraph 2.1.

### **.3 List of non-IACS Member classification societies contributing through the TC Forum and/or participating in IACS Working Group:**

None

### **.4 History of Decisions Made:**

Survey Panel discussed this issue under PSU 14046 and the majority of the Members agreed that the paragraph 2.3 of the UR Z18 is sufficient to cover all cases of extension of the boiler survey and that there is not necessity to modify the paragraph 2.1 of UR Z18.

Notwithstanding the concurrent views, Members agreed that the provisions with which an extension of the boiler periodical survey may be granted, set in paragraph 2.3, shall be moved in paragraph 2.1 where are established the periodicity of the surveys. A new sentence has been introduced in paragraph 2.1 and paragraph 2.3 has been modified accordingly.

During the discussion a Member highlighted that the text of the foot note which defines the Exceptional Circumstances (under which the extension may be granted) needed to be clarified because it contained the wording "e.g." before the list. Panel agreed that this wording left undefined and opened to interpretation the list of the exceptional circumstances, therefore Panel concurred to delete it.

Having cancelled the wording of paragraph 2.3 to which the above footnote was referenced, it has been provided to move the footnote under the paragraph 2.1 by referencing it to the new sentence introduced with the modification described above.



No TB is expected for this revision.

**.5 Other Resolutions Changes:**

None

**.6 Dates:**

Original Proposal: December 2014 Made by a Member  
Panel Approval: 23 February 2015 (Survey Panel)  
GPG Approval: 07 April 2015 (Ref: 15028\_IGd)

• **Rev.4 (Sep 2014)**

**.1 Origin of Change:**

- Based on the proposal of an IACS Member

**.2 Main Reason for Change:**

Consider appropriate text in IACS document regarding class period for lengthy conversions according to the similar changes applied to UR Z 7 series and UR Z10 series.

**.3 List of non-IACS Member classification societies contributing through the TC Forum and/or participating in IACS Working Group:**

None

**.4 History of Decisions Made:**

Survey Panel discussed this issue under PSU 14014 and agreed to modify the UR Z18 similarly to what done at paragraph 2.1.3 of the Rev. 21 of UR Z7, Rev. 10 of UR Z7.1, Rev. 5 of UR Z7.2, Rev. 21 of UR Z10.1, Rev. 31 of UR Z10.2, Rev. 16 of UR Z10.3, Rev. 12 of UR Z10.4 and Rev. 14 of UR Z10.5.

Modification introduces the possibility, for the Owner of a ship carrying an overdue Special/Renewal Survey (e.g. in case of long period of lay-up, or major modification, etc..) to elect if instead of the ascertainment of the expired survey those relevant to the next due Special/Renewal Survey are carried out. This possibility allows that the new period will have 5 years of duration starting from the date of the Special/Renewal Survey completion.

The modification has been applied to paragraph 1.1.3.

**.5 Other Resolutions Changes:**

None

**.6 Dates:**

Original Proposal: May 2014 Made by a Member  
Panel Approval: June 2014 (Survey Panel)  
GPG Approval: 17 September 2014 (Ref: 13064aIGb)

- **Rev.3 (Apr 2013)**

**.1 Origin of Change:**

- Based on the proposal of an IACS Member

**.2 Main Reason for Change:**

An IACS member proposed to discuss and clarify the provisions of dock trial expressed in paragraph 4.1 of UR. Z18 because auditors asked for the evidence during an audit that in occasion of all dry docks the trials, at least the dock trials, are to be carried out.

This IACS member expressed that the request of dock trial should be not directly related to the fact that the ship was docked. It should be more pertinent to relate dock trial as an operation to be carried out in order to complete a periodical (renewal) or an occasional machinery survey, as appropriate.

**.3 List of non-IACS Member classification societies contributing through the TC Forum and/or participating in IACS Working Group:**

None

**.4 History of Decisions Made:**

Survey Panel discussed this issue under PSU 12010 and agreed to clarify the provision of dock trial in order to eliminate future audit findings. Panel agreed to amend the text in Para 4.1 of UR Z18 *'At the time of drydocking'* by the text *'As Part of the Special Survey of Machinery'* for better clarity.

**.5 Other Resolutions Changes:**

None

**.6 Dates:**

Panel Approval: 16<sup>th</sup> Survey Panel Meeting 2012 (Ref: PSU12010)  
GPG Approval: 30 April 2013 (Ref: 13064\_IGc)

- **Rev.2 (Oct 2006)**

Refer to TB document in Part B (Annex 3).

- **Rev.1 (Jan 2006)**

Refer to TB document in Part B (Annex 2).

- **New (Nov 2001)**

Refer to TB document in Part B (Annex 1).

## Part B. Technical Background

List of Technical Background (TB) documents for UR Z18:

Annex 1. **TB for New (Nov 2001)**

See separate TB document in Annex 1.



Annex 2. **TB for Rev.1 (Jan 2006)**

See separate TB document in Annex 2.



Annex 3. **TB for Rev.2 (Oct 2006)**

See separate TB document in Annex 3.



Annex 4. **TB for Rev.8 (July 2018)**

See separate TB document in Annex 4.



*Note: There are no separate Technical Background (TB) documents available for Rev.3 (Apr 2013), Rev.4 (Sep 2014), Rev.5 (Apr 2015), Rev.6 (Aug 2016), Rev.7 (June 2017) and Rev.9 (Apr 2020).*

**Technical Background Document**  
**WP/SRC Task 1**  
**New UR Z 18, Z21 and deletion of M20**  
**(+ Rev.8 of Z7)**

**Objective and Scope:**

To review existing UR M 20 and relocate it as a UR under UR Z.

**Source of Proposed Requirements:**

WP/SRC Chairman reported by e-mail 6 May 1999 that WP/SRC Members had discussed and reviewed the requirements contained in UR M20 through correspondence and at their last meeting and had relocated the text of M20 to a new UR Z18. A proposal for resolving ABS' existing reservations against M20 is included in the proposed UR Z18.

**Points of Discussion:**

WP/SRC unanimously agreed to the proposed draft UR Z 18.

Note by the Permanent Secretariat

GPG did not accept WP/SRC's proposal for resolving ABS' reservations since the proposal would not, in fact, lead to any greater uniformity in practice than by simply retaining ABS' existing reservations, and therefore did not approve the proposed UR Z18, pending receipt and consideration of an acceptable means of resolving ABS' reservations from the ABS GPG representative. The ABS GPG representative reported to GPG, at its 51<sup>st</sup> meeting on 2-4 October 2001 that ABS was not prepared to change its practice and that he could not identify any means of resolving ABS' reservations without significant change to other Members practices, which other Members were not prepared to accept.

Therefore, GPG expressed its preparedness to live with ABS reservation to the tail shaft survey requirements of ex M20 (now Z21), agreed to isolate it from Z18.

Outcome:

- Delete M 20;
- Create new Z18 excluding tail shaft survey requirements;
- Create new Z21 for the tail shaft survey requirements.
- Revision 8 of Z7 to have the same descriptions of special survey as those in Z10s and Z18.

(GPG considered it prudent to keep Revision 8 of Z7 in abeyance until WP/SRC complete its Task 83 "revision of Z7".)

Date of submission: 6 May 1999  
By WP/SRC Chairman's e-mail

**Survey Panel Task 5 – Amend Survey Intervals for Boilers**  
**Survey Panel Task 6 – Develop Requirements for Survey of Boiler Pressure Relief Arrangements**  
**Survey Panel Task 7 – Amend Z18 to consider surveys of Exhaust Gas Heated Economizers**  
**\* Note The three Tasks above are all to amend UR Z18**

**Technical Background**  
**UR Z18 (Rev.1, Jan 2006)**

**1. Objective**

To amend the requirements of UR Z18 to address the survey panel tasks as described above.

**2. Background**

Task 5 & 6 as listed above were tasked by GPG to better align survey Intervals as requested by GPG Member from RINA and by the WP/MCH to expand the requirements for pressure relief arrangements to all boilers respectively.

Task 7 as listed above, was tasked due to a report from the MCA MAIB report on the “Island Princess” casualty.

**3. Methodology of Work**

Survey Panel member from LR proposed amendments to deal with Task 5 and Task 6 at the February 2005 Survey Panel meeting and with that, correspondence has continued until the Fall meeting, as to acceptable amendments (including the inclusion of Task 7 amendments to UR Z18) to come to a final submittal.

**4. Discussion**

With the submission of proposed amendments from LR as noted above the Survey Panel members through correspondence has the following comments which led to the Panel’s final submittal:

ABS Panel member made the following comments:

In paragraph 2.1, ABS is of the opinion that IACS should include a provision to allow extensions of boiler surveys in order to align with drydocking surveys or in case of exceptional circumstances.

This can be done by including the wording from one of the two methods noted below:

1. Consideration may be given for extensions Boiler Surveys beyond the due date.

or

2. An extension of examination of the boiler up to 3 months beyond the due date can be granted in exceptional circumstances. (Note if use this option then we need to define exceptional circumstances as per Z3).

NK Panel member comments:

2.1 Last sentence of existing UR Z18.2.1 requires the examination and test only for boiler safety valve relieving gear at each boiler internal survey. NK considers that boiler safety valve body should be included in this requirement.

2.2 Inspection item for safety/protective devices and safety valves at annual survey is not specified in the existing UR Z 18.2.2. NK considers that test requirements for safety/protective devices and safety valves at annual survey should be included in UR Z18.2.2.

Some members disagreed with the provisions for allowing extensions to the boiler surveys and with that RINA responded with the following:

As regards DNV's disagreement on the introduction of a provision allowing an extension of boiler surveys, we point out that it does not seem consistent to provide more flexibility to intermediate and special surveys (and to drydocking survey as well) than to boiler survey. And it is just this less flexibility that UR Z18 allows to boiler survey with respect to those above mentioned that we are often faced by cases where boiler survey interval exceeds the "fatal" 36 months. In fact, if a boiler survey is carried out concurrently with the special survey and credited with same date, the next boiler survey will be due after 36 months (without possibility of extension!!!), while the intermediate survey may reach the 39th month.

We are therefore in favor to introducing a provision for an extension to boiler survey up to three months, but without stating "in exceptional circumstances". We prefer to introduce a requirement for a specific "extension survey" which is to be of the same scope of the examination at annual survey.

All members agreed at the Fall Survey Panel meeting that having the provision for an extension of the boiler survey was acceptable.

Regarding Survey Panel Task 7 members discussed through correspondence the extent of weld examinations to be carried out during exhaust gas heated economizer surveys, and the proposal for the extent of NDT to be carried out. At the Fall Survey Panel meeting it was agreed by all Panel members that all accessible welded joints be visually examined and NDT be carried out as necessary.

## **5. Implementation**

The Survey Panel is of the view that the Members need 12 months from the adoption date to implement these amendments into their class rules. Assuming that GPG and Council approve to the amendments, the Survey Panel would propose January 2007 as an implementation date.

## **6. GPG consideration**

In its consideration for adoption of the amended UR, GPG posed questions to the Survey Panel in 4069jIGx, 30 Nov 05, to which the Survey Panel replied in 4069jPYb, 06 Jan 06, advising that Survey Panel concluded that no further amendments to item 2.4 of UR Z18 are necessary.

\*\*\*

## TECHNICAL BACKGROUND

### UR Z3 (Rev. 4), Z 7 (Rev. 14), Z18 (Rev. 2) and Z21 (Rev. 2)

#### Survey Panel Meeting March 2006 New Business Item – Applying UR Z3, Z7, Z18 and Z21 for Military Vessels.

#### 1. Objective

To add the following new paragraph to UR Z3, Z7, Z18 and Z21 to reflect that special consideration may be used for military vessels:

**“Special consideration may be given in application of relevant sections of this Unified Requirement to military vessels or commercial vessels owned or chartered by Governments, which are utilized in support of military operations or service”.**

#### 2. Background

This task was originally discussed during the Survey Panel meeting, which took place at ABS Houston on the 1<sup>st</sup> to 3<sup>rd</sup> March 2006; it was subsequently recorded under paragraph 3 “new business” of the minutes of this meeting.

This initial started as a proposal for ABS to remove their reservation (see below) for military vessels against UR Z3 and Z7s. However all of the members agreed to the proposal.

Current ABS Reservation: “ABS allows variations in survey interval in agreement with US Government for military vessels or commercial vessels owned or chartered by the Government which are utilized in support of military operations or service.”

#### 3. Methodology of Work

Survey Panel members through correspondence.

#### 4. Discussion

Survey Panel member from ABS raised this issue at the March 2006 Survey Panel meeting and volunteered to propose amendments to the applicable URs for Panel members to review and comment on through correspondence. At the Fall meeting of the Survey Panel, it was agreed upon by all Panel members that the proposed amendments for UR Z3, Z7, Z18 and Z21, which were proposed by ABS, were acceptable.

#### 5. Implementation

The Survey Panel is of the view that the Members need 12 months from the adoption date to implement these amendments into their class rules. Assuming that GPG and Council approve to the amendments, the Survey Panel would propose January 2008 as an



implementation date. However due to other on going revisions to UR Z21 this UR will be held abeyance until the other revisions are completed.

**6. Discussion at GPG:** GPG amended the proposal by deleting the phrase “military vessels or” on the basis that military vessels and other government ships operated for non-commercial purposes are out of the scope of IACS URs. The adopted amendment therefore reads:

**“Special consideration may be given in application of relevant sections of this Unified Requirement to commercial vessels owned or chartered by Governments, which are utilized in support of military operations or service”.**

Submitted by Survey Panel Chair, October 2006  
Updated by GPG to reflect their discussion

## **Technical Background (TB) document for UR Z18 (Rev.8 July 2018)**

### **1. Scope and objectives**

Upon the investigations of new technologies' implications on survey regime, IACS developed this unified requirement to the approved Condition Monitoring and Condition Based Maintenance schemes applying to the machinery components and systems where the condition monitoring results are used to influence the scope and/or frequency of Class survey, including the requirements of software, onboard working, documentation, personnel, approval and survey for applying the scheme, and survey/audit for maintenance of the scheme.

### **2. Engineering background for technical basis and rationale**

As far as the PT members have been able to conclude, the CBM is a set of maintenance actions based on real-time or near-real time assessment of equipment condition which is obtained from embedded sensors and/or external tests & measurements taken by portable equipment. From a Classification Society's consideration, the RMD embraces similar principles of monitoring. Apart of CBM and RMD there exist various systems of monitoring based on acquisition and processing of information and data that indicate the state of a machine over time. With emerging technologies such as Radio Frequency IDentification (RFID), various sensors, Micro-Electro-Mechanical System (MEMS), wireless tele-communication, Supervisory Control and Data Acquisition (SCADA) and Product Embedded Information Devices (PEID) there are expected to be rapidly used in the world such systems for gathering and monitoring the status of components. Moreover, the CBM scheme in general can be treated as a method used to reduce the uncertainty of maintenance activities and embraces various condition monitoring/diagnosis technologies and techniques such as lubricant/fuel, wear particle, bearing temperature, infrared thermography and motor current signature analysis.

Having recognized that, the PT agreed the subsequent Guidelines shall not be limited only by CBM and RMD systems and decided to leave opportunity for implementation existing and forthcoming systems based on the principals of the condition monitoring/diagnosing intrinsic to the CBM.

### **3. Source/derivation of the proposed IACS Resolution**

The PT reviewed the current IACS Resolutions and Recommendations and detected paragraphs potentially impacted.

### **4. Summary of Changes intended for the revised Resolution:**

The PT prepared a draft of a new document UR Z27 covering Condition Monitoring and Condition Based Maintenance schemes where the condition monitoring results are used to influence the scope and/or frequency of Class survey. Besides, the PT proposed a draft of corrigenda to the UR Z18, UR Z20 and Recommendation 74.

## **5. Points of discussions or possible discussions**

The task was triggered by GPG to review and set the future work directions on the implications of new technology on survey regime, in relation with other technologies, especially the Remote Monitoring/Diagnosis (RMD) and the Condition Based Inspecting/Maintenance (CBM). A project team was agreed to be established, and the Form A and Form 1 were agreed by GPG on 24/03/2017.

PT manager submitted the PT outcomes to the Survey Panel meeting on 25/08/2017, and some comments were got from panel members before the 26th panel meeting.

During the 26<sup>th</sup> Survey Panel meeting, a Member introduced their comments and indicated that as a minimum requirement, the related UR shall include the minimum parameters to be checked in order to monitor the condition of the various machinery for which this type of maintenance is accepted; The panel agreed with the view of a Member that for ease of understanding and implementation, revisions should be made in UR Z20 only, to include the elements of the proposed new UR instead of having two separate URs.

The PT suggested:

- that elaborating on requirements would likely to limit UR's applicability for ensuing technologies, thus no changes are required.
- to steer a course of action had been embarked on during the team joint work and be committed to have a separate UR Z27 instead of merging the requirements with UR Z20.

Based on preceding discussion it was concluded that qualified majority of the Panel Members agreed with PT's opinion that a separate UR for CM/CBM as designed by PT was the appropriate course of action.

PT, after examination of the Panel's comments, prepared

- a new version of the draft UR addressing the comments and suggestions, and
- the technical justifications/explanations.

On October 2017 PT sent to the Panel the new version of the draft.

Finally, the qualified majority of the Panel Members agreed the draft text of the UR Z27 and modifications to UR Z18, UR Z20 and Recommendation 74.

## **6. Attachments if any**

None

**Technical Background Document**  
**WP/SRC Task 60**  
**UR Z 19 – Proposed**

**Objective and Scope:**

To develop a Unified Requirement with regard to calibration of inspection, measuring and testing equipment used to verify products to be certified or classified by a Member Society or to be used in the re-classification process.

**Source of Proposed Requirements:**

WP/SRC members discussed this issue through correspondence and their meeting. The requirements were developed through the Member's experience with the calibration of equipment used by the Surveyor.

**Points of Discussion:**

WP/SRC unanimously agreed to the proposed draft UR Z 19.

## UR Z20 “Planned Maintenance Scheme (PMS) for Machinery”

### Summary

This revision is to harmonize the terms of ‘recommendation’ and ‘condition of class’ with only the term ‘condition of class’ being retained.

### Part A. Revision History

Version no.	Approval date	Implementation date when applicable
Rev.2 (May 2019)	30 May 2019	1 July 2020
Rev.1 (July 2018)	16 July 2018	1 July 2019
New (May 2001)	May 2001	-

- **Rev. 2 (May 2019)**

**.1 Origin of Change:**

- Suggestion by an IACS member

**.2 Main Reason for Change:**

This revision is to address the policy decision made by GPG using the common terminology ‘Condition of Class’(CoC) instead of the terms ‘Recommendation/ Condition of Class’ based on the outcome of III 5.

**.3 List of non-IACS Member classification societies contributing through the TC Forum and/or participating in IACS Working Group:**

None

**.4 History of Decisions Made:**

During the 29th panel meeting, the panel discussed about the comments of members, and concurred with the view to retain the present definitions of CoC in the IACS resolutions with the wording ‘Recommendation’ to be removed. The panel also agreed to use the term ‘Statutory Condition’ for the ‘recommendation’ of the statutory certificates in IACS resolutions and RECs, and when discussing the proposal of a member to consider the harmonization of the terms of ‘recommendation’ and ‘condition of class’ in RO Code, the panel unanimously agreed to take no action on the IMO instruments, leaving the relevant actions to be decided by the relevant IMO bodies when IACS feeds back to IMO the IACS action on the harmonization of the two terms.

Panel members concurred with the view that it is not necessary to develop a new procedure requirement, and agreed to set the implementation date of these IACS resolutions (other than RECs) as 1st July 2020.

Before the implementation date of 1st July 2020 for using the common terminology 'Condition of Class' only, 'Recommendations' and 'Condition of Class' are to be read as being different terms used by Societies for the same thing, i.e. requirements to the effect that specific measures, repairs, surveys etc. are to be carried out within a specific time limit in order to retain Classification.

No TB is expected for the present revision.

#### **.5 Other Resolutions Changes:**

The following IACS resolutions and Recommendations (RECs) were agreed to be revised:

- Procedural Requirements: PR1A, PR1B, PR1C, PR1D, PR1 Annex, PR3, PR12, PR20, PR35 and the attachment of PR16;
- Unified Requirements: Z7, Z7.1, Z7.2, Z10.1, Z10.2, Z10.3, Z10.4, Z10.5, Z15 and Z20
- Unified Interpretations: GC13
- Recommendations: Rec.41, Rec.75, Rec.96, Rec.98

#### **.6 Any hinderance to MASS, including any other new technologies:**

None

#### **.7 Dates:**

Original Proposal: 14 January 2019 tasked by GPG (17044bIGm)

Panel Approval: 22 March 2019 (PSU19010)

GPG Approval: 30 May 2019 (17044bIGu)

### **• Rev.1 (July 2018)**

#### **1 Origin of Change:**

- Suggestion by IACS members

#### **2 Main Reason for Change:**

To address the FUA 11 of C73, raised by the Council of the IACS in respect to the future work directions on the implications of new technology on Remote Monitoring/Diagnosis (RMD) and Condition Based Inspecting/Maintenance (CBM). Survey Panel discussed the issue and agreed to establish a PT to provide suggestions for the possible revisions of the relevant IACS Resolutions and Recommendations (e.g. UR Z18, UR Z20, Rec.74) and the draft of new Recommendations/Guidelines which may help the concrete application of these technologies.

### **3 List of non-IACS Member classification societies contributing through the TC Forum and/or participating in IACS Working Group:**

None

### **4 History of Decisions Made:**

Survey panel discussed this issue under Panel task PSU16057 allocated by GPG on 21st October 2016. The subject deals with the review of the UR and Recommendation under Panel responsibility in order to determine whether a revision could need in order to consider the new technologies on Remote Monitoring/Diagnosis (RMD) and Condition Based Inspecting/Maintenance (CBM).

In this respect the Survey Panel discussed the topics and agreed that a PT dealing with the matters would be advisable in order to provide suggestions for the possible revisions of the relevant IACS Resolutions and Recommendations (e.g. UR Z18, UR Z20, Rec 74) and the draft of new Recommendations/Guidelines which may help the concrete application of these technologies.

PT PSU34/2017 was established, and made revisions mostly addressing the following:

- Delete paragraph 1.2.2.
- Delete paragraph 2.2.1(vi)(vii), 2.2.2(iii) and renumbered the following items
- Delete paragraph 2.3.3(ii)(iii)
- Delete paragraph 3.2.7 and renumber the following item 3.2.8

During the 26th Survey Panel meeting, panel members concurred with comments on PT's submission and proposed actions were taken by the PT. Survey Panel reviewed the drafts which was further amended and agreed by Survey Panel.

Refer to TB Document in Annex 1.

### **5 Other Resolutions Changes:**

UR Z18, UR Z27

### **6 Dates:**

Original Proposal: 21 October 2016 assigned by GPG

Panel Approval: 28 June 2018 by Survey Panel (Ref: PSU16057)

GPG Approval: 16 July 2018 (Ref: 16151\_IGz)

### **• New (May 2001)**

No history file or TB document available.

## Part B. Technical Background

List of Technical Background (TB) documents for UR Z20:

Annex 1. **TB for Rev.1 (July 2018)**

See separate TB document in Annex 1.



*Note: There are no separate Technical Background (TB) document available for New (May 2001) and Rev.2 (May 2019).*



## **Technical Background (TB) document for UR Z20 (Rev.1 July 2018)**

### **1. Scope and objectives**

Upon the investigations of new technologies' implications on survey regime, IACS developed this unified requirement to the approved Condition Monitoring and Condition Based Maintenance schemes applying to the machinery components and systems where the condition monitoring results are used to influence the scope and/or frequency of Class survey, including the requirements of software, onboard working, documentation, personnel, approval and survey for applying the scheme, and survey/audit for maintenance of the scheme.

### **2. Engineering background for technical basis and rationale**

As far as the PT members have been able to conclude, the CBM is a set of maintenance actions based on real-time or near-real time assessment of equipment condition which is obtained from embedded sensors and/or external tests & measurements taken by portable equipment. From a Classification Society's consideration, the RMD embraces similar principles of monitoring. Apart of CBM and RMD there exist various systems of monitoring based on acquisition and processing of information and data that indicate the state of a machine over time. With emerging technologies such as Radio Frequency IDentification (RFID), various sensors, Micro-Electro-Mechanical System (MEMS), wireless tele-communication, Supervisory Control and Data Acquisition (SCADA) and Product Embedded Information Devices (PEID) there are expected to be rapidly used in the world such systems for gathering and monitoring the status of components. Moreover, the CBM scheme in general can be treated as a method used to reduce the uncertainty of maintenance activities and embraces various condition monitoring/diagnosis technologies and techniques such as lubricant/fuel, wear particle, bearing temperature, infrared thermography and motor current signature analysis.

Having recognized that, the PT agreed the subsequent Guidelines shall not be limited only by CBM and RMD systems and decided to leave opportunity for implementation existing and forthcoming systems based on the principals of the condition monitoring/diagnosing intrinsic to the CBM.

### **3. Source/derivation of the proposed IACS Resolution**

The PT reviewed the current IACS Resolutions and Recommendations and detected paragraphs potentially impacted.

### **4. Summary of Changes intended for the revised Resolution:**

The PT prepared a draft of a new document UR Z27 covering Condition Monitoring and Condition Based Maintenance schemes where the condition monitoring results are

used to influence the scope and/or frequency of Class survey. Besides, the PT proposed a draft of corrigenda to the UR Z18, UR Z20 and Recommendation 74.

## **5. Points of discussions or possible discussions**

The task was triggered by GPG to review and set the future work directions on the implications of new technology on survey regime, in relation with other technologies, especially the Remote Monitoring/Diagnosis (RMD) and the Condition Based Inspecting/Maintenance (CBM). A project team was agreed to be established, and the Form A and Form 1 were agreed by GPG on 24/03/2017.

PT manager submitted the PT outcomes to the Survey Panel meeting on 25/08/2017, and some comments were got from panel members before the 26th panel meeting.

During the 26<sup>th</sup> Survey Panel meeting, a Member introduced their comments and indicated that as a minimum requirement, the related UR shall include the minimum parameters to be checked in order to monitor the condition of the various machinery for which this type of maintenance is accepted; The panel agreed with the view of a Member that for ease of understanding and implementation, revisions should be made in UR Z20 only, to include the elements of the proposed new UR instead of having two separate URs.

The PT suggested:

- that elaborating on requirements would likely to limit UR's applicability for ensuing technologies, thus no changes are required.
- to steer a course of action had been embarked on during the team joint work and be committed to have a separate UR Z27 instead of merging the requirements with UR Z20.

Based on preceding discussion it was concluded that qualified majority of the Panel Members agreed with PT's opinion that a separate UR for CM/CBM as designed by PT was the appropriate course of action.

PT, after examination of the Panel's comments, prepared

- a new version of the draft UR addressing the comments and suggestions, and
- the technical justifications/explanations.

On October 2017 PT sent to the Panel the new version of the draft.

Finally, the qualified majority of the Panel Members agreed the draft text of the UR Z27 and modifications to UR Z18, UR Z20 and Recommendation 74.

## **6. Attachments if any**

None

## UR Z21 “Surveys of Propeller Shafts and Tube Shafts”

### Part A. Revision History

Version no.	Approval date	Implementation date when applicable
Rev.4 (Oct 2015)	9 October 2015	1 January 2017
Rev.3 (Feb 2015)	26 February 2015	1 January 2016
Rev.2 (Oct 2006)	29 October 2006	1 January 2008
Rev.1 (Apr 2006)	10 April 2006	1 July 2007
New (Nov 2001)	23 November 2001	-

#### Rev.4 (Oct 2015)

##### .1 Origin of Change:

Other (*Suggestion by GPG*)

##### .2 Main Reason for Change:

The task was triggered following the analysis of the comments to the revision 3 received by GPG.

##### .3 List of non-IACS Member classification societies contributing through the TC Forum and/or participating in IACS Working Group:

None

##### .4 History of Decisions Made:

During the approval of the revision 3 of UR Z21, GPG provided some comments/hints to the Survey Panel for their consideration and action as appropriate. Panel members during the 21<sup>st</sup> Survey Panel meeting analyzed the comments with the aim to verify whether a new revision of UR Z21 was necessary.

Panel, having examined the comments, agreed that the UR Z21 needed to be revised in order to apply small modifications which made more clear the text. Moreover a Panel Member raised comments on the wording of the definition of “alternative means” since the definition does not clearly exclude from the application of the UR Z21 the shaft’s arrangements which are provided with a monitoring system of the working parameters such as the “Tailshaft Monitoring System”.

As outcome of the 21<sup>st</sup> Survey Panel Meeting most of the comments were addressed and only one, related to the alignment of survey periodicity for propulsion shafts having the propeller coupled with the keyed system to those of shafts having the propeller coupled with keyless system, remained unresolved since a clear qualified majority was not expressed.

The task continued by correspondence with the aim to find possible solutions which might avoid future reservations. For what concerned the comment about the survey periodicity, the Society who raised it provided its technical background in order to explain the reasons behind its request. At the same time Some Panel members proposed new wordings which might resolve the concerns related to the definition of the "Alternative Means".

After some correspondence rounds the majority of the Panel Members concurred that there is no sufficient technical background to consider the alignment of the survey periodicity: only two members (the proposing Society and another Member) expressed their preference for this modification.

For what concern the rewording of the definition of Alternative Means the majority of the Members finds a common view. Only one Member expressed its dissent view about the proposal since his understanding is that the revision 3 of UR Z21 is applicable also to propulsion shaft arrangements which are provided of monitoring system devices.

At 22<sup>nd</sup> Survey Panel meeting, the modifications of the UR Z21 have been finalized by issuing the draft of the revision 4.

It is to note that notwithstanding several tentative by part of the Survey Panel members it was not possible to provide a draft which may resolve all the possible concerns that might avoid the issue of reservation.

The outcomes of the analysis of the GPG comments are recorded in the Technical Background associated to this revision.

#### **.5 Other Resolutions Changes:**

None

#### **.6 Dates:**

Original Proposal: *January 2015* made by GPG

Panel Approval: *16 September 2015* by Survey Panel at 22<sup>nd</sup> Survey Panel meeting (Ref: PSU15006)

GPG Approval: *9 October 2015* (Ref: 12080\_IGo)

### **Rev 3 (Feb 2015)**

#### **.1 Origin of Change:**

- Suggestion by an IACS member
- Other (*Suggestion by GPG*)

#### **.2 Main Reason for Change:**

The task was triggered in 2006 following the reservations, raised by some IACS Members, against the contents of UR Z21 relevant to the periodicity and modality of survey of Propeller Shafts and Tube Shafts.

The expected benefits of the work are focused to achieve the harmonization of the survey criteria between members on a fundamental matter related to the classification (e.g. in view of the TOC), taking also in account new building technologies (e.g. the new kind of water lubrication technologies used in order to protect the environment against possible pollution) .

The new revision should also achieve the goal to avoid any possible future reservations against its content.

### **.3 List of non-IACS Member classification societies contributing through the TC Forum and/or participating in IACS Working Group:**

None

### **.4 History of Decisions Made:**

The task was initiated by the Panel on 2006, following the issue of reservation by part of some Member Societies against the contents of revision 2.

Notwithstanding several tentative by part of the Survey Panel members it was not possible to reach an agreed position mainly for what concern the periodicity of the surveys in relation to the different typology of propeller shafts layout and used lubrication media.

On June 2012 Survey Panel Chairman communicated to GPG that, despite the various endeavours, a common agreed position was not reached. As consequence GPG tasked the Survey Panel to establish an Inter Group Project Team (Survey/Machinery) with the following objective:

*"to update the existing UR Z21 taking in account the all the Survey schemes individually applied by the Members and finding a common approach for related surveys"*

with the aim to remove all existing reservations, avoiding any possible future reservation.

PT 20/2013 has been set, the following work item have been assigned (according to form A):

- Collection of the survey schemes of all IACS Members;
- Collection of the proposal of revision coming from all Survey/Machinery Panel Members
- Investigation (in cooperation with Machinery Panel member representatives) about the new building technologies that may allow new schemes of surveys
- Preparation of a(the) new harmonized scheme(s) of survey and introduction in a revision of UR Z21.

PT presented to Survey Panel the first draft of the revision 3 on August 2013. After reviewing the amendments identified by PT, Survey Panel members provided their comments to the drafted revision.

PT, after examination of the comments, prepared

- a new version of the draft addressing the comments and suggestions, and
- the technical justifications/explanations.

On February 2014 PT sent to the Panel the new version of the draft.

Draft was revised by the Panel at 19<sup>th</sup> meeting (March 2014) and further revised by correspondence. At 20<sup>th</sup> Survey Panel Meeting the final version of the draft has been agreed by the Panel members.

See TB document in Part B.

#### **.5 Other Resolutions Changes:**

None

#### **.6 Dates:**

Original Proposal: October 2006      *Made by an IACS member*  
Panel Approval: 5 September, 2014 by Survey Panel at 20<sup>th</sup> Survey Panel  
meeting (Ref: PSU5013)  
GPG Approval: 26 February 2015 (Ref: 12080\_IGk)

- **Rev 2 (Oct 2006)**

Survey Panel meeting of March 2006: review the UR Z21 with the aim of consider its special application for Military Vessels.

See TB document in Part B.

- **Rev 1 (Apr 2006)**

Survey Panel Task 24: Review UR Z21 and determine whether any revision is necessary to clauses 1(a)(i) and 1(b) based on service history and experience in the application of Z21, by member Societies.

See TB document in Part B.

- **NEW (Nov 2001)**

WP/SRC Task 1: to review existing UR M 20 and relocate it as a UR under UR Z.

See TB document in Part B.

## **Part B. Technical Background**

List of Technical Background (TB) documents for UR Z21:

Annex 1. **TB for NEW (Nov 2001) and Corr.1 (Jan 2004)**

See separate TB document in Annex 1.

Annex 2. **TB for Rev.1 (Apr 2006)**

See separate TB document in Annex 2.

Annex 3. **TB for Rev.2 (Oct 2006)**

See separate TB document in Annex 3.

Annex 4. **TB for Rev.3 (Feb 2015)**

See separate TB document in Annex 4

Annex 5. **TB for Rev.4 (Oct 2015)**

See separate TB document in Annex 5



**Technical Background Document  
WP/SRC Task 1  
New UR Z 18, Z21 and deletion of M20  
(+ Rev.8 of Z7)**

**Objective and Scope:**

To review existing UR M 20 and relocate it as a UR under UR Z.

**Source of Proposed Requirements:**

WP/SRC Chairman reported by e-mail 6 May 1999 that WP/SRC Members had discussed and reviewed the requirements contained in UR M20 through correspondence and at their last meeting and had relocated the text of M20 to a new UR Z18. A proposal for resolving ABS' existing reservations against M20 is included in the proposed UR Z18.

**Points of Discussion:**

WP/SRC unanimously agreed to the proposed draft UR Z 18.

Note by the Permanent Secretariat

GPG did not accept WP/SRC's proposal for resolving ABS' reservations since the proposal would not, in fact, lead to any greater uniformity in practice than by simply retaining ABS' existing reservations, and therefore did not approve the proposed UR Z18, pending receipt and consideration of an acceptable means of resolving ABS' reservations from the ABS GPG representative. The ABS GPG representative reported to GPG, at its 51<sup>st</sup> meeting on 2-4 October 2001 that ABS was not prepared to change its practice and that he could not identify any means of resolving ABS' reservations without significant change to other Members practices, which other Members were not prepared to accept.

Therefore, GPG expressed its preparedness to live with ABS reservation to the tail shaft survey requirements of ex M20 (now Z21), agreed to isolate it from Z18.

**Outcome:**

Delete M 20;

Create new Z18 excluding tail shaft survey requirements;

Create new Z21 for the tail shaft survey requirements.

Revision 8 of Z7 to have the same descriptions of special survey as those in Z10s and Z18.

(GPG considered it prudent to keep Revision 8 of Z7 in abeyance until WP/SRC complete its task to revise Z7.)

Date of submission: 6 May 1999  
By WP/SRC Chairman's e-mail



**Survey Panel Task 24 – Review UR Z21 and determine whether any revision is necessary to clauses 1(a)(i) and 1(b) based on service history and experience in the application of Z21, by member Societies.**

**Technical Background**

**UR Z21(Rev.1, April 2006)**

**1. Objective**

To determine revision necessary, if any, to UR Z21 based on reservations submitted by GL.

**2. Background**

GL reservation for the applicable section of Z21 regarding omitting the fillet radius of the aft propeller shaft flange for a controllable pitch propeller by an approved crack detection method.

**3. Methodology of Work**

Panel member discussion through email correspondence.

**4. Discussion**

GL GPG member in June 2005 filed a reservation against UR Z21 as follows:

“Clauses 1(a)(i) and 1(b).

We reserve our position to omit the fillet radius of the aft propeller shaft flange for a controllable pitch propeller from the examination by an approved crack-detection method, provided that the design is proven and has been approved to be in full accordance to the rules.

The rationale behind this is that

1. Not a single damage has been detected in all such crack-tests performed so far under GL's supervision.
2. The fillet radius area of flanges for CPPs can in most cases only be crack-tested after a big and risky dismantling job.”

Additionally, at the time of this request, a request was made to have the Survey Panel review UR Z21 to make amendments as necessary to address the GL reservation.

All members were requested to review their Societies vessels with CPP systems and determine if any problems have been found at the aft propeller shaft flange.

All members found that their vessels had not encountered any problems in the subject area and agreed to amend UR Z21 as necessary.

After correspondence by members, all agreed that in section 1(a)(i) 3, amendments could be made to NDT requirements, where NDT of the fillet radius of aft propeller shaft flanges may be required if visual exam is not satisfactory, and in (ii)(b) amendments were made where the crack detection test of the aft flange could be dispensed with for solid flange couplings at the end of shafts.

In addition, the Panel member from DNV proposed to amend the first paragraph of Z21 to allow shafts to not be removed for examination if alternative means are provided to assure the condition of the shaft, where alternative means are further describes in the latter paragraphs of Z21.

## **5. Implementation**

The Survey Panel is of the view that the Members need 12 months from the adoption date to implement these amendments into their class rules/procedures. Assuming that GPG and Council approve the amendments, the Survey Panel would propose July 2007 as an implementation date.

Ref: 5074\_IGj, 29 Mar 2006

## TECHNICAL BACKGROUND

### UR Z3 (Rev. 4), Z 7 (Rev. 14), Z18 (Rev. 2) and Z21 (Rev. 2)

#### Survey Panel Meeting March 2006 New Business Item – Applying UR Z3, Z7, Z18 and Z21 for Military Vessels.

#### 1. Objective

To add the following new paragraph to UR Z3, Z7, Z18 and Z21 to reflect that special consideration may be used for military vessels:

**“Special consideration may be given in application of relevant sections of this Unified Requirement to military vessels or commercial vessels owned or chartered by Governments, which are utilized in support of military operations or service”.**

#### 2. Background

This task was originally discussed during the Survey Panel meeting, which took place at ABS Houston on the 1<sup>st</sup> to 3<sup>rd</sup> March 2006; it was subsequently recorded under paragraph 3 “new business” of the minutes of this meeting.

This initial started as a proposal for ABS to remove their reservation (see below) for military vessels against UR Z3 and Z7s. However all of the members agreed to the proposal.

Current ABS Reservation: “ABS allows variations in survey interval in agreement with US Government for military vessels or commercial vessels owned or chartered by the Government which are utilized in support of military operations or service.”

#### 3. Methodology of Work

Survey Panel members through correspondence.

#### 4. Discussion

Survey Panel member from ABS raised this issue at the March 2006 Survey Panel meeting and volunteered to propose amendments to the applicable URs for Panel members to review and comment on through correspondence. At the Fall meeting of the Survey Panel, it was agreed upon by all Panel members that the proposed amendments for UR Z3, Z7, Z18 and Z21, which were proposed by ABS, were acceptable.

#### 5. Implementation

The Survey Panel is of the view that the Members need 12 months from the adoption date to implement these amendments into their class rules. Assuming that GPG and Council approve to the amendments, the Survey Panel would propose January 2008 as an

implementation date. However due to other on going revisions to UR Z21 this UR will be held abeyance until the other revisions are completed.

**6. Discussion at GPG:** GPG amended the proposal by deleting the phrase “military vessels or” on the basis that military vessels and other government ships operated for non-commercial purposes are out of the scope of IACS URs. The adopted amendment therefore reads:

**“Special consideration may be given in application of relevant sections of this Unified Requirement to commercial vessels owned or chartered by Governments, which are utilized in support of military operations or service”.**

Submitted by Survey Panel Chair, October 2006

## Technical Background for UR Z21 Rev.3 (Feb 2015)

### 1. Scope and objectives

-To consider the revision of UR Z21 in order to evaluate the possibility to rationalize the survey methodology and survey schedule in order:

- a) to consider the technological progress of the:
  - propulsion shafts and propeller;
  - their methods of lubrication,.
- b) to address the existing reservations against the revision 2 of the UR Z21
- c) to study the shaft surveys rules of each Society in order to draft a new common survey scheme that may be adopted in lieu, keeping in consideration the possible differences among the rules of the Societies.
- d) To identify any other revisions required for UR Z21 by evaluating the proposals of Members.

### 2. Engineering background for technical basis and rationale

To achieve the scope and objectives the Survey Panel established ad hoc joint panel (Survey/Machinery) PT (PT 20/2013) with the aim to prepare the first draft of the Revision 3 of UR Z21. Leading role of the PT was assigned to Survey Panel.

Following the examination of the survey criteria for propulsion shafts set into the revision 2 of UR Z21, PT has investigated on the possibility to reconsider the interconnection of the request to carry a complete survey of the entire shaft (complete) in consequence of the type of coupling between shaft and propeller.

In addition, PT has considered the new systems of shaft lubrication, based on the use of fresh water in a closed loop similar to the one used for oil lubricated shafts.

New materials employed for shaft protection, against the corrosion, have been also taken under consideration in order to widen the family of those shafts which are allowed to work in a corrosion environment (sea water or moisture of sea water).

PT has also evaluated the information received by Panel Members relevant to their experience and feedbacks, especially for what concern the fresh water lubricated shafts in closed loop. In particular two Panel Members contributed with their wide experience on this kind of lubrication system by submitting their experience as follow:

Member 1: in Member1's experience, for closed loop Fresh Water lubricated systems, there is no objection to the proposed 15 year interval (between complete survey) in view we have significant experience under Condition Monitoring of these types of system. This is provided the appropriate controls are in place, whose include:

- Water analysis at 6 monthly intervals.
- The pumping and water filtration systems are considered part of the continuous survey cycle and are subject to Periodical Survey.
- The shaft is to either be constructed of corrosion resistant material or protected with a corrosion resistant protective liner or approved coating.
- The glands are to be capable of being replaced without withdrawal of the shaft
- There is to be a shaft starting/clutch engagement block to inhibit starting the shaft until lubricating water flow has been established.

Member 2: The philosophy used in facilitating extended intervals (of shaft lubricated by fresh water in closed loop) aims to achieve an equivalent level of safety in design and monitoring aspects in force for condition based survey schemes for oil lubricated stern tubes (Tailshaft Monitoring).

The salient technical and classification aspects are addressed by ensuring satisfactory:

- a) Corrosion protection of shafting and system.
- b) Control and monitoring of quality of lubricant and system.
- c) Performance monitoring of shaft and bearings.
- d) Integrity
- e) Periodical follow up inspections in service.
- f) Relevant documentation.

The PT work has been extended also to the evaluation of the possibility to:

- confirm, as per actual Revision 2 of the UR Z21, that for flanged coupling system between propeller and shaft no dedicated verifications are necessary among the purposes of shaft survey (unless dismantled for other reasons).
- to extend the periodicity of the inspection intervals of the shaft taper for keyless coupling system between shaft and propeller.

On the basis of the technical feedbacks the PT confirmed that the actual provisions for flanged couplings (between shaft/propeller) are still applicable. For what concern the inspection of the shaft cone of the keyless couplings (between Shaft/Propeller) PT proposed to extend its periodicity from 10 to 15 years. In making the proposal PT evaluated the positive experience of the PT members relevant to the possible cases of damages affecting the shrinkage area of the shaft cone: these are quite rarely so that it can be assumed that the actual provisions for shaft design and selection of construction material are reliable. Moreover PT deemed appropriate to consider the fact that the area where the propeller is connected to shaft is working in the same environment (sea water) independently by the kind of shaft lubrication (oil closed loop, or fresh water closed loop, or water in open circuit): therefore the possibility to apply the periodicity of 15 years between to subsequent controls has been extended also to shaft lubricated by water in open circuit.

PT during the drafting of the revision has taken into consideration the principle that the new harmonized scheme needs to be flexible so that it can be applied by all Members. The aim has been achieved by finding and setting the minimum necessary requisites, for each kind of shaft survey, in order to grant that these cover the scope of the survey, granting its reliability. The flexibility of the harmonized system should leave the possibility to each Society to enforce the requirements in its rules as deemed necessary.

### **3. Source/derivation of the proposed IACS Resolution**

None

### **4. Summary of Changes intended for the revised Resolution**

- New section 'definitions' was introduced to clarify the terms related to the shaft surveys.
- New scheme of harmonized shaft surveys has been introduced. The scheme expects the following:

Oil Lubricated Shafts: three methods of surveys (Method 1, Method 2, Method 3) having increasing severity, from less (Method 3) to high (Method 1)

Fresh Water Lubricated shafts (closed loop): three methods of surveys (Method 1, Method 2, Method 3) having increasing severity, from less (Method 3) to high (Method 1)

Water Lubricated Shafts (open loop): one method of survey (Method 4)

- The criteria of extension surveys, their scope and application methodologies have been introduced. The scheme expects the following:
  - Oil Lubricated Shafts: three kinds of extension surveys (2,5 years extension survey, 1 year extension survey and 3 months extension survey).
  - Fresh Water Lubricated shafts (closed loop): three kinds of extension surveys (2,5 years extension survey, 1 year extension survey and 3 months extension survey).
  - Water Lubricated Shafts (open loop): two kinds of extension surveys 1 year extension survey and 3 months extension survey).
- The survey requirements for each kind of survey contemplated inside the revision 3 of the UR Z21

## **5. Points of discussions or possible discussions**

1. PT proposed a first draft of the revision according to the assigned task (among the scope and objectives) .
2. Survey Panel reviewed the proposed amendments submitted by PT. Survey Panel proposed a list of comments to be sent to PT for clarification.
3. PT reviewed the Panel comments and the drafted revision 3 UR Z21 which was further amended.
4. PANEL reviewed the PT technical justifications and the new version of drafted revised UR Z21
5. At 20<sup>th</sup> Survey Panel meeting the draft was further amended and consolidated. Panel Noted that for what concern the analysis of the lubricating fresh water there will be necessary the development of an IACS recommendation that follows the principle of the IACS recommendation 36 for oil lubricated shafts.

## **6. Attachments if any**

Nil

## **Technical Background (TB) document for UR Z21 (Rev.4 Oct 2015)**

### **1. Scope and objectives**

Analyse the GPG comments to the revision 3 of UR Z21 and verify the possibility to address them by drafting a new revision.

### **2. Engineering background for technical basis and rationale**

With the revision 3 of UR Z21 it has been introduced new survey criteria for propulsion shaft systems based on the typology of shaft lubrication media and the methodology of propeller coupling to the shaft.

### **3. Source/derivation of the proposed IACS Resolution**

Survey Panel Members, in consultation with their own Society's experts.

### **4. Summary of Changes intended for the revised Resolution**

- 1) Editorial modifications as suggested by GPG Members
- 2) Revision of the criteria to apply the extension surveys
- 3) Rewording of the definition of "alternative means" in order to clearly exclude the shaft arrangements provided with the system for monitoring the working parameters from the application of the survey criteria set in the UR Z21 (Rev.3).

### **5. Points of discussions or possible discussions**

The comments to revision 3 have been examined and technically dealt with as follows (reference is made to the corresponding paragraph of UR Z21):

- Paragraph 1.2.1 - Recommend changing "could mean" to "includes": the Panel concurred with the suggestion since clarify the sentence,
- Paragraph 2.3.1.2, 2.3.1.3, 2.4.1.2, 2.4.1.3 and table 2.5- We do not agree that there should be a difference for intervals of keyless and keyed connections and recommend the two sections be combined and include items A, B, and C.. The Society who issued the comments provided the following TB as support of its understanding

#### **QUOTE**

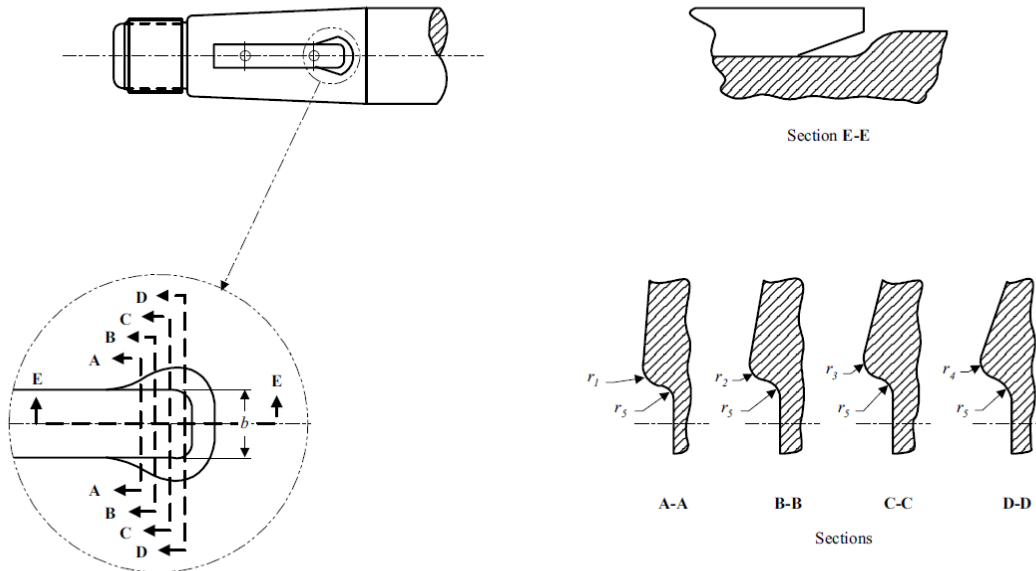
Keyed propeller shaft connections for large sea going vessels have not been used for probably the last 25 – 30 years. Therefore, very few vessels in service with an oil lubricated tail shaft have a keyed propeller connection. Most of the keyed connections for existing vessels are found on saltwater lubricated tail shafts which require the shaft to be drawn and NDE carried out in the keyway.

The "old style" simple keys with no relief in the keyway forward are no longer accepted by IACS UR M68 and the Society recognizes the keyed type with spooned keyways for the longer survey interval. (Refer to drawing below on spooning). The spooning relieves the stress from the forward end of the key where fractures used to be found.



The limitations and details addressed for keyways, shaft dimensions and barred ranges, and the arrangement envisioned for keyed propeller shafts results in the same service experience considered for keyless propellers/shaft connections.

Typical Spooning of Keyway in Propeller Shaft



The Society has not required keyed connection to carry out a Method 1 or Method 2 survey at 5 year intervals for more than 35 years. We have not had any reported failures by allowing a 15 year interval for carrying out NDE in the keyway.

UNQUOTE

Majority of the Panel members (8 on 12) agreed that the technical background presented does not provide sufficient technical information to grant that cone part of a shaft, having a keyway in its tapered section, might not be affected by defects due to the stresses at keyway edges, notwithstanding the spooned design, after a long period (e.g. 15 years) of working. Majority of the Members deems that the actual periodicity and methodology of survey of the taper, when a keyway is present, grant a safe margin in respect to the detection of the possible deficiencies which may affect the keyway edges and so the shaft cone. These considerations are confirmed by the long experience in the application of the provision of the UR Z21 and the ancestor unified requirement M20.

- Paragraph 2.3.2, 2.4.2 and table 2.5: it is proposed to modify the method of application of the various extension surveys as follow:
  - Extension up to a maximum of 1 year, no more than two consecutive "one year extensions" can be granted. No further extension, of other type, can be granted. In the event an additional extension is requested the requirements of the "2.5 year extension" are to be carried out and the shaft survey due date, prior to the previous extension, is extended for a maximum of 2.5 years.
  - Extension up to a maximum of 3 months, no more than one "three months extension" can be granted. In the event an additional extension is requested the requirements of the "one year extension" or "2.5 year extension" are to be carried out and the shaft survey due date, prior to the previous extension, is extended for a maximum of one year or 2.5 years.

Majority of the Members concurred with the suggestions considering that the maximum allowable period of extension that can be granted is 2,5 years from the shaft survey due date. Therefore if an extension survey granting 1 year or 3 months is applied at the shaft survey due date and later on a more long extension is required, this last might be allowed by applying the survey criteria corresponding to the extension required and by crediting the new extension from the original shaft survey due date.

- Table 2.5: it is proposed to modify the position of note h, related to the application of survey method 1, to shafts lubricated by fresh water in close loop. Majority of the Panel Members concurred with the suggestion that make clear the table contents. Moreover, it is worth to note that in the GPG Member comment there was the proposal to split the note "h" in two notes and rewording them as follow:
  - *h: maximum of two consecutives Method 2 or Method 3 surveys. The maximum interval between two surveys carried out according to Method 1 shall not be more than 15 years.*
  - *i: maximum of two consecutives Method 2 surveys. The maximum interval between two surveys carried out according to Method 1 shall not exceed 15 years.*

This last proposal has not deemed necessary in order to clarify the table since the first part of the text, i.e. "maximum of two consecutives Method 2 or Method 3 surveys" does not correspond to the real scope of the note. In fact the note shall explain to the reader that a survey carried out according to method 1 shall be carried every 15 years (unless an extension of three months is granted). Thus in the time frame of 15 years there should be at least other two periodical surveys but this requirement should not prevent the interested parties to carry out more than two periodical surveys in the captioned time frame (it might be decided by the interested parties to carry three or more periodical surveys, instead of two, in between two surveys carried out according to method 1).

Taking present the above also the paragraph 2.3.1.2.C has been modified accordingly.

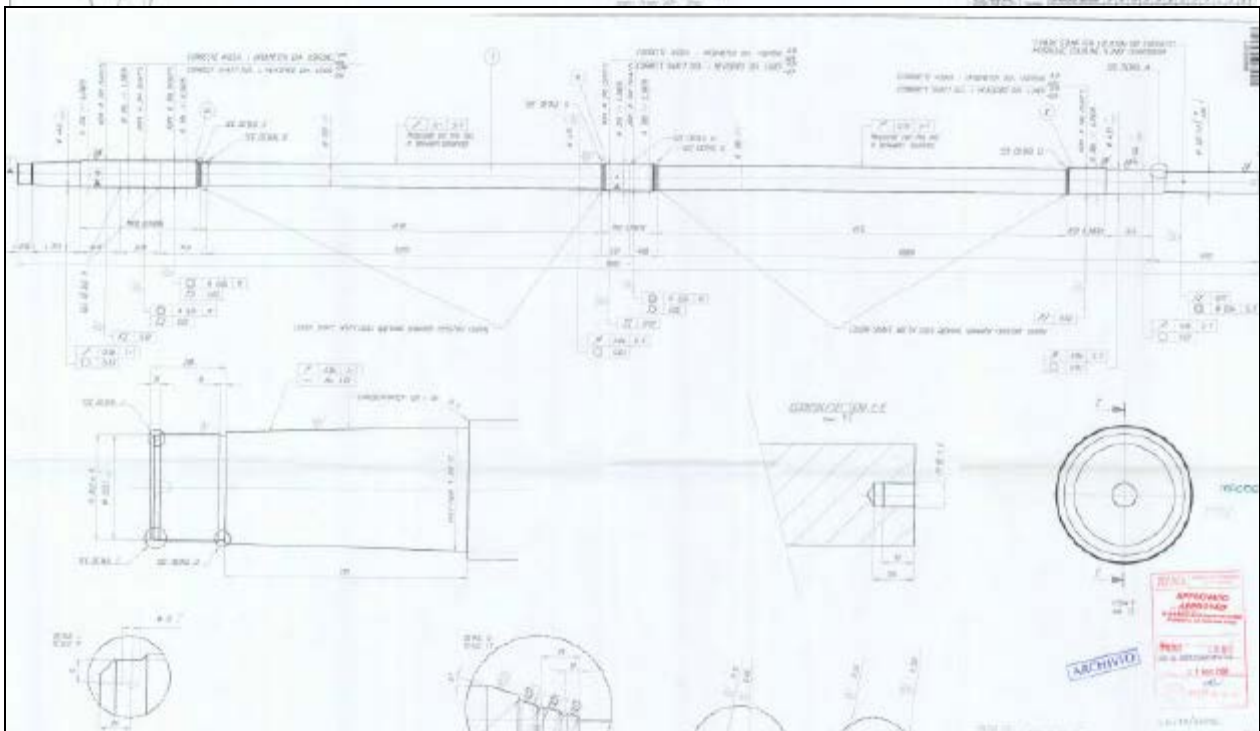
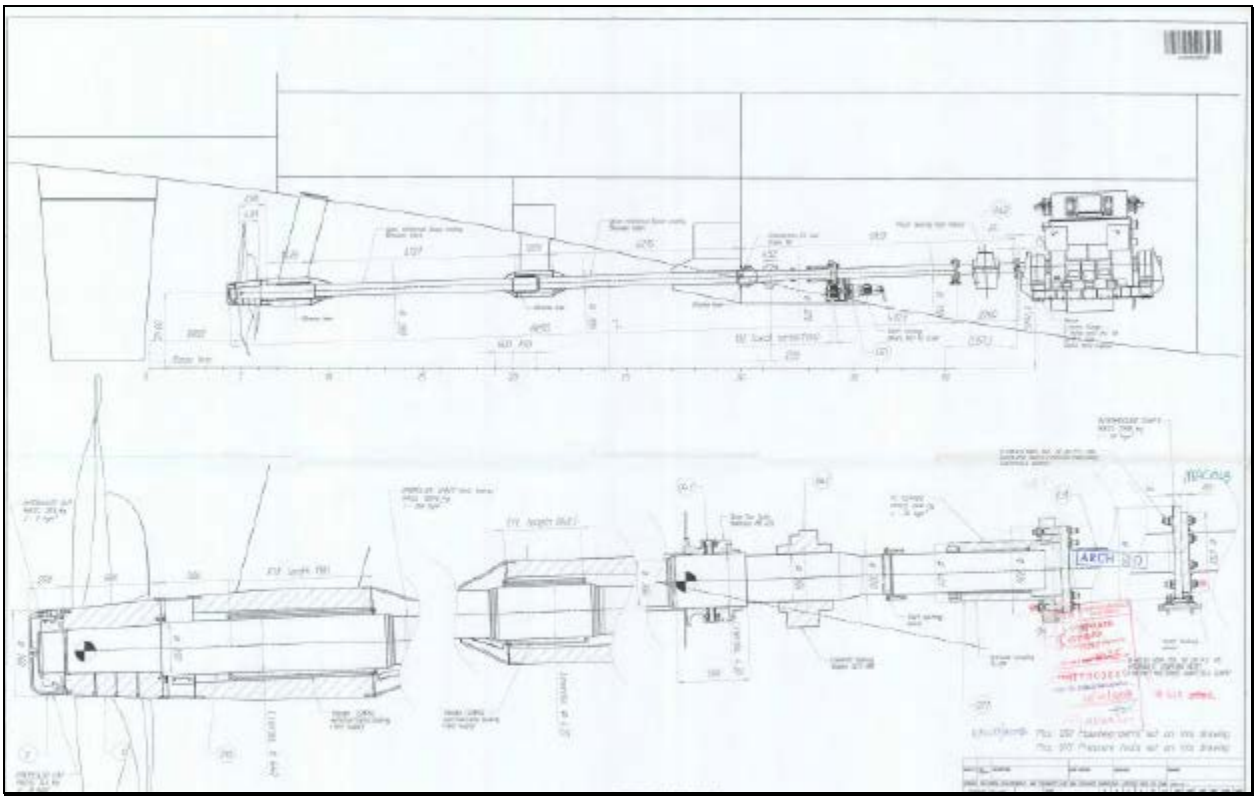
- Paragraph 3.1.1: it is proposed to reduce the periodicity of examination, through NDE (Non Destructive Examination), of the cone of propulsion shafts lubricated by water in open circuit, having the propeller coupled with keyless method, from 15 years to 5 years (i.e. in conjunction with the application of method 4 which expects the complete drawn of the shaft). The grounds of the proposal are the following:
  - The wearing of the bearings of a propulsion shaft lubricated by water in open circuit is different from that of a shaft lubricated by oil in closed circuit, hence the stresses are different and might affect the area of the propeller coupling.
  - that the propeller needs to be dismantled in order to draw the shaft.

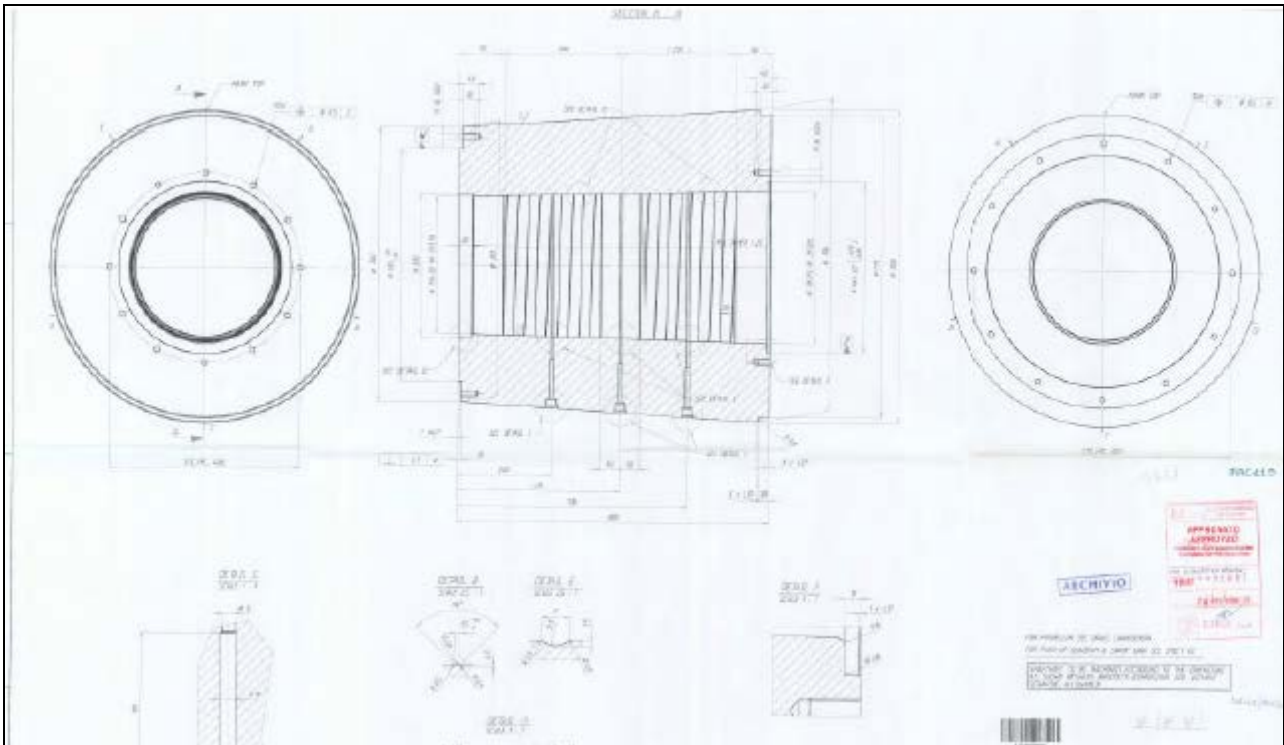
Panel already examined both issues during drafting of the revision 3 of UR Z21 with the help of the PT.

The first issue has been already examined, during the approval of Revision 3 of the UR Z21, on the basis of the hundreds positive feedbacks coming from hundreds propulsion shaft surveys performed and the precaution that every five years the clearance of the shaft/bearings, as well as the shaft wear, shall be measured and evaluated and compared with the previous (trend analysis). Therefore an anomalous bearing wearing

is easily detected and so there is no possibility to generate potential dangerous loads on shaft due to the failure of its supports (bearing). Moreover the issue was also satisfactorily reviewed by the members of PT 19 (who dealt with the revision 3 of UR Z21 and where one of the members was selected by the Machinery Panel), whose promoted the periodicity of 15 years for propeller coupled with keyless methodology.

The second issue was already examined by the Survey Panel on the grounds of the following shaft arrangement where in order to examine the propulsion shaft and the tube shaft, both lubricated by sea water, it is not necessary to uncouple the propeller:





Considering that there is at least one existing arrangement to which the provision of paragraph 3.3.1 might be applied the majority of the Panel Members deemed to retain the paragraph as is. Moreover it has been considered that for the keyless coupling connection, of shafts lubricated by water in open circuit, most of the Societies possess positive records which demonstrate that this kind of coupling, if designed according the provisions set in UR M68, are reliable and for shafts/propellers not affected by other mechanical damages, e.g. due to contact or improper use, where the propeller is installed according to the manufacturer procedures do not shows any kind of defects when inspected (e.g. due to excessive shrinkage). However Panel also considered that the requirements of paragraph 3.3.1 do not prevent a Society to set more stringent requirements in its own rules.

## 6. Attachments if any

None.

## **Technical Background Z 22 (New. Dec 2002)**

### 1. Scope and objectives

1.1 Following a casualty which had been partly attributed to water ingress through broken automatic air pipe heads, the AHG/FDF was charged with the following:

#### Objectives

- To establish design and inspection requirements for automatic "floating ball type" air vents, situated on deck, especially on oil and chemical tankers.

#### Work Specification

- To identify current industry standards and practices.
- To consider problems identified on such a type of air vents, including design requirements, installation precautions, frequency of inspections, maintenance and replacement of elements, subject to deterioration.
- To consider improved means of protection against corrosion (treatment, coating) of the inner casing.
- To improve the design to facilitate the inspection and maintenance of the parts mostly exposed to corrosion (the connecting pipe inside the casing and air vent pipe).
- To take into account a better protection of air vents against green seas.

1.2 Members agreed that although the Form A specified only oil and chemical tankers, the UR should be applicable to a wider range of ship types. It was thus agreed to recommend extension to all cargo ship types, with consideration to passenger or other ship types and locations other than the exposed deck, to be given according to the requirements of each Society. This recommendation was included with the submitted UR to IACS for their consideration.

### 2. Points of discussions and possible discussions

2.1 The type and working principle of automatic air pipe heads have been discussed by the group. Also information about the mentioned casualty have been collected and discussed. Taking into account the existing requirements in UR P3, and additional design recommendations made by the AHG to WP/MCH, it was considered that the main item to be improved was the survey requirements of automatic air pipe heads.

2.2 The AHG considered a proposal that the survey regime for stainless steel heads may be reduced. On advice from LR's Chief Metallurgist, the group were informed that most normal grades of stainless steel react rather badly to the chlorine in sea water, causing a susceptibility to pitting corrosion. This pitting can occur even faster than the normal corrosion of mild steel, and in some cases has been found to cause penetration through the plate in a short time. Certain grades of stainless steel with a high pitting resistance – super duplex or super austenitic - would be acceptable, but these would increase the cost substantially. In view of this, and the difficulty for a surveyor of ascertaining the grade of stainless steel used in an existing head, it was decided not to reduce the survey regime for this type of head.

2.3 However, with possible future development of air pipe heads constructed from corrosion resistant materials, and proven good survey experience, a review of the regime specified in this UR may be

considered appropriate.

3. Source / derivation of proposed requirements

The group collected information regarding current automatic air pipe heads service and noted that, in some cases it is not possible to fully inspect an automatic air pipe head from outside and that dismantling from its air pipe, would be necessary for accessing the internal parts. It was therefore decided to clarify the matter, in respect of extension and procedures for inspections for such a kind of automatic air pipe heads.

4. Decision by voting if any

The proposed UR was considered by all Members of the AHG and was agreed unanimously.

5. Note by the Permanent Secretariat

WP/SRC had reviewed Z22 and the AHG/FDF recommended Council as follows:

	WP/SRC	AHG/FDF
1	Z22.1.1: It should apply to all ships except passenger ships.  Suggests that the AHG develop requirements for air pipe heads of passenger ships.	AHG agreed.  Council tasked GPG to consider.
2	Z22.2. Suggests that the requirement for removal of the head from the air pipes should be deleted.	In view of the aforementioned casualty, the AHG recommends that it should be left as is.
3	Z22.2. Suggests that recoating according to the paint manufacturers' procedures should be required if the zinc coating has broken down.	This should be for individual Societies to determine effective repairs as is their current practice.
4	A reference to Z22 should be included in Z7.  Internal conditions of the pipes in the area of weld connection with the deck has not been considered. It should be addressed in a UR.	Agreed. WP/SRC Chairman is to bear this in mind.  Survey requirements for air/vent pipes is a separate issue to be addressed in Z7 or in a separate UR. GPG is to further consider.

- Adopted on 23 December 2002
- Council tasked GPG to examine the remaining issues as summarized in the Table above. There are two remaining issues:  
Question 1. Whether to develop separate survey requirements to air-pipes on passenger ships,  
(Yes: DNV, CCS;

No: ABS, KR, RINA, BV, NK, LR, GL, RS)

Question 2. Whether to develop uniform survey requirements for air-vent pipes including the welded connection to deck ( as a separate UR with reference to this UR in Z7).  
(Yes: ABS, RS, DNV, GL, KR, CCS, BV, RINA)  
(NK, LR and GL: to be decided by GPG)

For further developments, refer to correspondence under s/n 2172a.

\*\*\*\*\*

## UR Z 23 “Hull Survey for New Construction”

### Summary

To update the reference in appendix 2 due to adoption of Resolution MSC.454(100) which revoked Resolution MSC.296(87)

### Part A. Revision History

Version no.	Approval date	Implementation date when applicable
Corr.2 (May 2023)	17 May 2023	-
Corr.1 (Oct 2022)	04 October 2022	-
Rev.7 (Oct 2020)	02 October 2020	1 July 2021
Rev.6 (Nov 2016)	25 November 2016	1 January 2018
Rev.5 (Feb 2015)	24 Feb 2015	1 July 2016
Rev.4 (Mar 2014)	14 March 2014	1 July 2016
Rev.3 (June 2013)	05 June 2013	1 July 2016
Corr.1 (Aug 2012)	08 August 2012	-
Rev.2 (Apr 2009)	14 April 2009	1 July 2010
Corr.1 (Oct 2007)	05 October 2007	-
Rev.1 (Mar 2007)	22 March 2007	-
New ( July 2006)	31 July 2006	1 January 2008

#### • Corr.2 (May 2023)

##### 1 Origin of Change:

- Suggestion by IACS member

##### 2 Main Reason for Change:

As Resolution MSC.296(87) was revoked by Resolution MSC.454(100), the reference in appendix 2 was to be updated accordingly.

##### 3 List of non-IACS Member classification societies contributing or participating in IACS Working Group:

None

##### 4 History of Decisions Made:

As Resolution MSC.296(87) was revoked by Resolution MSC.454(100), the reference in appendix 2 was to be updated in a similar manner to Corr.1 of this UR.



**5 Other Resolutions Changes:**

None

**6 Any hinderance to MASS, including any other new technologies:**

None

**7 Dates:**

Original Proposal : 12 January 2023 (PSU23004\_ISUa)  
Panel Approval : 15 March 2023 (Ref: 37th Survey Panel Meeting)  
GPG Approval : 17 May 2023 (Ref: 22142\_IGd)

• **Corr.1 (Oct 2022)**

**1 Origin of Change:**

Suggestion by IACS member

**2 Main Reason for Change:**

As ISO18001 (OHSAS18001) was replaced by ISO45001, the reference in appendix 1 is to be updated to ISO45001.

**3 List of non-IACS Member classification societies contributing or participating in IACS Working Group:**

None

**4 History of Decisions Made:**

As ISO18001 (OHSAS18001) was replaced by ISO45001, the reference in appendix 1 is to be updated to ISO45001.

**5 Other Resolutions Changes:**

None

**6 Any hinderance to MASS, including any other new technologies:**

None

**7 Dates:**

Original Proposal : 26 August 2022 (Made by a Survey Panel Member)  
Panel Approval : 08 September 2022 (Ref: PSU22046)  
GPG Approval : 04 October 2022 (Ref: 22142\_IGb)

- **Rev.7 (Oct 2020)**

### **1 Origin of Change:**

- Suggestion by IACS member
- Request by non-IACS entity (*IMO GBS auditor*)

### **2 Main Reason for Change:**

2.1 A global unified standard is required to improve the installation and maintenance of Pressure-Rated MCT/Transit systems. In order to properly maintain Ship and Mobile Offshore Unit structures and promote vessel safety during water ingress a better method is necessary to document and manage installation, maintenance, and repair of MCT/Transit systems. By improving documentation during initial installation, incorporating the installation information into a systemized maintenance plan, and using knowledgeable authorized/approved service entities to conduct inspections and manage repairs or alterations, the risks of MCT failures will be reduced. This will mitigate potential safety and environmental incidents as a result of service oversights and exposure to onboard flooding damage conditions.

2.2 During the initial GBS compliance audit of the CSR for BC&OT the IMO GBS auditors observed that there is no established process for accepting the use of fabrication standards in lieu of IACS Rec. 47. Therefore, IACS received an "observation" as a Finding of the GBS audit.

2.3 During the IMO GBS 2018 audit it was observed that in UR Z23 Rev.5, Table 1 lines 1.4 and 1.5, "NDE" is amended to "NDT" several times which are inconsistent with the term NDE remaining unchanged in 5.1.5.2c) and 5.1.5.2h) of the revised Z23 and in the CSR-BC&OT (2018) in 4 of Ch. 12 Sect. 2. Therefore, IACS received an "observation" as a Finding of the GBS audit.

2.4 As Recommendation 20 is to be deleted, and the newly developed UR W33 is to be uniformly implemented on or after 1st July 2021, the items 1.3c, 1.4 and 1.5 of Table 1 are to be updated with the term "Recommendation 20" being replaced with "UR W33".

### **3 List of non-IACS Member classification societies contributing or participating in IACS Working Group:**

None

### **4 History of Decisions Made:**

4.1 A member of the Survey Panel raised the issue of survey requirements during the 24th Survey Panel Meeting. In detail under discussion is the concept for the preparation of an IACS tool (a Recommendation or an UR, whichever deemed more appropriate) which addresses the complicated and arduous activities associated with the particular inspections required for class to accept the continuous integrity of the multi cable transit from the time of their installation till to the end of the ship's life.

In this respect the Survey Panel discussed the topics and agreed that a PT dealing with the matters would be advisable in order to provide suggestions for the possible revisions of the relevant IACS Resolutions (e.g. Z23, Z7, Z15, and Z17)

PT PSU32/2017 was established, and made revisions to URs Z23, Z7 and Z17, with the following of UR Z23 being addressed:

- Insert new paragraph 10.2.5.1 to the main text.
- Insert new paragraph 3.1.1.9.1 to the Appendix 2.
- Insert new Appendix 3, Recommendatory Sample of Cable Transit Seal Systems Register

PT's proposal was submitted to the Survey Panel on 11 August 2017, panel members concurred with comments on PT's submission and proposed actions were taken by the PT. Survey Panel reviewed the drafts which was further amended and agreed by Survey Panel on 14 March 2019 during the 29th Panel Meeting.

Realizing that the UR for approval of Service Suppliers for the inspection of Cable Transits is newly developed by IACS, before enough Service Suppliers being approved, it might be premature to push out the UR for the inspections to the cable transits of ships in service, the members agreed to push out the IACS URs step by step, and firstly to work out the revision to UR Z23 to include the requirement of the "Register" for new construction ships, and the revision to UR Z17 for the details of the approval requirements of the Service Suppliers for the inspection of Cable Transits, and secondly to complete the draft of the new URZ (other than revising URs Z7 and Z15) in a later time with all the survey requirements to the cable transits, leaving the mandatory requirements for the service supplier to be considered in the future.

As proposed by one member, Survey Panel further considered to insert a new hull inspection item of Watertight Cable Transit Seal System into Table 1 of UR Z23, and agreed to insert a new item 8.6 for this purpose. During the 30th Survey Panel meeting, the panel finalized the contents of item 8.6 of Table 1 of UR Z23.

After the 30<sup>th</sup> Survey Panel meeting, the panel finalized the new UR Z28 and the revisions to URs Z23 and Z17.

Refer TB Document in Annex 5 of Part B.

#### 4.2 For addressing an IMO GBS observation made during the 2015 IMO Audit (PSU18004)

IACS decided to address all observations made by the GBS Audit Teams. Therefore the Hull Panel PT PH36 team assigned to address this observation prepared a GBS Corrective Action Plan submitted to the IMO in Dec 2015. It was decided to add a procedure for accepting the use of a recognized fabrication standard (RFS) in lieu of Rec. 47 in paragraph 7.4 of UR Z23.

This topic is also mentioned in Pt 1, Ch 12, Sec 1, [1.2.1] of the CSR for BC&OT, therefore reference to paragraph 7.4 of UR Z23 is made in the technical background of this CSR rule section.

#### 4.3 For addressing an IMO GBS observation made during the 2018 IMO Audit (PSU19051)

During the discussions, the qualified majority of Survey Panel agreed to use the term "NDE" in the Table 1 of UR Z23 other than "NDT", consisting with the main text of this UR, with the relevant contents in IACS CSR for BC & OT being unchanged.

#### 4.4 Deletion of Recommendation 20

As Recommendation 20 is to be deleted, and the newly developed UR W33 is to be uniformly implemented on or after 1st July 2021, the items 1.3c, 1.4 and 1.5 of Table 1 were updated with the term "Recommendation 20" being replaced with "UR W33".

### 5 Other Resolutions Changes:

URs Z17, Z28, W33

### 6 Any hinderance to MASS, including any other new technologies:

None

### 7 Dates:

- 7.1 Original Proposal: 29 September 2016 Made by A Survey Panel Member  
Panel Approval: 8 December 2019 (Ref: PSU16049)  
GPG Approval: 02 October 2020 (Ref: 16222\_IGv)
- 7.2 Original Proposal: 13 Feb 2018 Made by: PT PH36  
Panel Approval: 18 Nov 2019 (Ref. PH15014\_IHbi)  
GPG Approval: 02 October 2020 (Ref: 16222\_IGv)
- 7.3 Original Proposal: 31 October 2018 Made by: EG/GBS(18122a)  
Panel Approval: 25 November 2019 (Ref: PSU19051)  
GPG Approval: 02 October 2020 (Ref: 16222\_IGv)
- 7.4 Original Proposal: 28 November 2019 Made by: GPG (13202\_IGzg)  
Panel Approval: 8 December 2019 (Ref: PSU16049)  
GPG Approval: 02 October 2020 (Ref: 16222\_IGv)
- 7.5 Panel Approval: 21 September 2020 (Ref: 16222\_PYg)  
GPG Approval: 02 October 2020 (Ref: 16222\_IGv)

### • Rev 6 (Nov 2016)

#### .1 Origin of Change:

- Suggestions by IACS member
- Other (Corrective Action of the OBS 7 to the IACS CP1 on GBS)

#### .2 Main Reason for Change:

To address the Observation 07, raised by the IMO Auditing Team 5 of the IACS common package 1 in respect to the functional requirements (FR) 9-15

To address the Observation 04, raised by the IMO Auditing Team 5 of the IACS common package 1 in respect to the functional requirements (FR) 9-15.

**.3 List of non-IACS Member Classification Societies contributing through the TC Forum and/or participating in IACS Working Group:**

None

**.4 History of Decisions Made:**

- a) In order to address the Observation 07, related to the provisions to ensure that areas of high stress or fatigue risk are surveyed, Panel discussed, under tasks PSU 16006 and PSU16006b, the modification of the table 1 annexed to UR Z23. During the 24<sup>th</sup> meeting Panel Members concurred that the areas subjected to high stress fatigue, and in general the critical structural areas, should be subjected to witnessing in lieu of the patrolling. Panel Members agreed to modify the "Survey method required for the classification" of the item 2.5, of table 1, from "patrol and review" to "witness and review" according to the definition of Patrol, Review and Witness provided at paragraphs 2.3.1, 2.3.2 and 2.3.3. of UR Z23.
- b) Following to a GPG Member's proposal Panel examined, under the task PSU16017, the possible modification of the UR Z23 in order to include the activity of the verification of the Ship Construction File (SCF) before the ship's delivery. The suggested text was discussed by the Members and it was concurred that since the issue might be regarded as a proactive extension of the corrective action to OBS 04 this should be added in appendix 2 of the UR Z23. Members examined the proposed text and the relevant proposal of its modification. During the 24<sup>th</sup> Survey Panel meeting agreed to add the new paragraphs 3.2, 3.2.1 and 3.2.2 into the appendix 2 by noting that the use of the word "review" in paragraph 3.2, according to the definition of paragraph 2.3.2 of UR Z23, has the following scope:

"REVIEW" means the examination of the SCF that is carried out by the surveyor, at the end of the newbuilding process, in order to confirm that:

- drawings and documents required under the paragraph 3 of the appendix 2 to the UR Z23, plus
- the possible additional drawings/documents provided by the shipyard, as per the Ship Constructional File (SCF) list of drawings/documents

are present in the copies of the SCF stored on board and in the ashore archive. The "REVIEW" is not to be intended as an assessment of the drawings/documents in order to verify their compliances with the applicable Rules/Regulations"

During the 24<sup>th</sup> Panel meeting Members concurred to merge the conclusion of the task PSU16017 to those of PSU16006b (former 16006) so that only a single revision of UR Z23 (revision 6) is produced.

## 5 Other Resolutions Changes:

None

## 6 Dates:

Panel Approval: 09 September 2016 (Ref: PSU16006b & PSU16017)

GPG Approval: 25 November 2016 (Ref: 15124bIGk)

### • Rev 5 (Feb 2015)

#### 1 Origin of Change:

- Suggestions by IACS members

#### 2 Main Reason for Change:

To address a finding raised by a Quality Auditor relevant to the missing recording of the patrolling activity expected into the table 1 annexed to UR Z23.

To modify the scope of the Survey Method required for Classification of the items 1.3c, 5 and 6 of table 1 annexed to UR Z23 in order to indicate the appropriate methodology of survey.

#### 3 List of non-IACS Member classification societies contributing through the TC Forum and/or participating in IACS Working Group:

None

#### 4 History of Decisions Made:

- a) During the 19<sup>th</sup> Survey Panel Meeting a Member sought the Panel opinion about a finding raised during a quality audit and relevant to the no satisfactory recording of the patrolling activities.  
Each Members of the Survey Panel explained its own Society's procedure used in order to record the patrolling activity. Members decided to explore the possibility to create an IACS form in order to reporting it.  
Panel discussed the proposal under PSU 14006. During the discussion it has been observed that the majority of the Societies already possess proper software where patrolling activities are recorded.  
Panel acknowledged that the creation of a dedicated form may lead to uncomfortable modifications of the software of each Society; hence Panel decided that the reasonable solution is to formalize, inside the UR Z23, that at least the deficiencies found during the patrolling activities shall be recorded. The new paragraph 9.2 has been added to UR Z23, this establish a minimum data requirements in order to record each deficiency.  
No technical background has been expected for this modification.
- b) Following the examination of the survey requirements listed in table 1, a Member noted that the requirements for the item no. 5 (Tightness testing, including leak and hose testing, hydropneumatic testing) were not correctly addressing the intended activity.

Panel discussed the modification to be applied under the task no 14018 and following the revision of the table it has been noted that also item 1.3c and item 6 needed to be analysed and modified.

The following wording has been respectively agreed:

- Item 1.3c of table 1: from "*Patrol*" to "*Review and patrol*"
- Item 5 and item 6 of table 1: from "*patrol of the process and witness of the test*" to "*Review and witness of the test*".

The items 5 and 6 have been agreed by correspondence while item 1.3 has been agreed at 20<sup>th</sup> Survey Panel meeting.

At the Panel meeting Members concurred to merge the conclusion of the task PSU14018 with those of PSU14006 so that only a single revision of UR Z23 (revision 5) is produced.

## **5 Other Resolutions Changes:**

None

## **6 Dates:**

Panel Approval: 05 September 2014 by Survey Panel (Ref: PSU14006 and PSU14018)

GPG Approval: 24 February 2015 (Ref: 15012\_IGc)

## **• Rev 4 (Mar 2014)**

### **1 Origin of Change:**

- Request by non IACS entity (INTERTANKO, BIMCO)

### **2 Main Reason for Change:**

To consider the comments made by industry (INTERTANKO, BIMCO) during the review of URZ23.

### **3 List of non-IACS Member classification societies contributing through the TC Forum and/or participating in IACS Working Group:**

None

### **4 History of Decisions Made:**

- c) During the review of previous revision to UR23 (Rev.3) which was revised to comply with IMO GBS guidelines external entities INTERTANKO and BIMCO proposed some amendments to UR Z23.
- d) GPG tasked Survey Panel to review the modifications/suggestions proposed by the Industry which were not relevant to IMO GBS guidelines and advised to revise the URZ23 as appropriate.
- e) Panel discussed the proposals received from Industry and revised UR Z23. Present revision of UR Z23 reflected only the proposals of Industry which were agreed by the Survey Panel (PSU13043).

f) Moreover, item 7.1 of Table 1 was editorially amended as per the outcome of Panel task PSU13044.

## **5 Other Resolutions Changes:**

None

## **6 Dates:**

Panel Approval: 7 November 2013 by Survey Panel (Ref: PSU13043)  
GPG Approval: 14 March 2014 (Ref: 10060fIGs)

## **• Rev 3 (June 2013)**

### **1 Origin of Change:**

Based on IMO Regulation (MSC.287(87), MSC.290(87), MSC.296(87))

### **2 Main Reason for Change:**

At C62, IACS Council noted the report on the CSR/GBS gap analysis related to identified gaps which should be covered by the harmonised CSR. On that occasion, Council noted that there are gaps which will not be covered by the Harmonized CSR and which could be closed by modifying existing IACS technical resolutions to comply with GBS Guidelines.

### **3 List of non-IACS Member classification societies contributing through the TC Forum and/or participating in IACS Working Group:**

None

### **4 History of Decisions Made:**

Survey Panel discussed to revise UR Z23 in order to comply with the IMO Ship Construction File (SCF) Guidelines and relevant requirements of the GBS Guidelines related to design transparency and construction surveys.

A Small Group (SG) was formed under Survey Panel consisting 3 Panel Members which submitted the proposed revised draft UR Z23 to Survey Panel during 15<sup>th</sup> Survey Panel meeting. A whole new appendix ( 'Appendix 2') has been added to the existing UR Z23. Proposed revision of UR Z23 was agreed by the Survey Panel at 16<sup>th</sup> Panel meeting.

## **5 Other Resolutions Changes:**

None



## 6 Dates:

Panel Approval: 19 September 2012 by Survey Panel (Ref: PSU11025)  
GPG Approval: 05 June 2013 (Ref: 100060fIGn)

- **Corr.1 (August 2012)**

### 1 Origin of Change:

Suggestion by an IACS member

### 2 Main Reason for Change:

To remove the reference to PR34 in UR Z23 as PR34 was deleted on 1 July 2012.

### 3 List of non-IACS Member classification societies contributing through the TC Forum and/or participating in IACS Working Group:

None

### 4 History of Decisions Made:

The proposal was made by an IACS GPG member. PermSec drafted the correction.

### 5 Other Resolutions Changes:

None

## 6 Dates:

Original Proposal: *6 July 2012 Made by a Member*  
GPG Approval: *08 August 2012 (Ref:11090\_IGq)*

- **Rev 2 (April 2009)**

EG/NCSR task (Ref: 9529\_)

See TB document in Part B.

- **Corr.1 (Oct 2007)**

Contracted for Construction - standard footnote added (Ref: 7546a)

- **Rev.1 (March 2007)**

GPG62 FUA 36-1 (Feedback on IACS UR Z23 – Delete the last sentence in para.7.5 from the reply letters to INTERTANKO / INTERCARGO and dispatch them. Circulate UR Z23 (Rev.1) to Members/Industry for records/implementation) (Ref: 4009a).

No TB document available.

- **New (2006)**

Ref: 4009

See TB document in Part B.

## **Part B. Technical Background**

List of Technical Background (TB) documents for UR Z23:

Annex 1. **TB for New (July 2006)**

See separate TB document in Annex 1.

Annex 2. **TB for Rev.2 (April 2009)**

See separate TB document in Annex 2.

Annex 3. **TB for Rev.3 (June 2013)**

See separate TB document in Annex 3.

Annex 4. **TB for Rev.4 (Mar 2014)**

See separate TB document in Annex 4.

Annex 5. **TB for Rev.7 (Oct 2020)**

See separate TB document in Annex 5.

*Note: There are no separate Technical Background (TB) documents available for Rev.1 (March 2007), Corr.1 (Oct 2007), Corr.1 (Aug 2012), Rev.5 (Feb 2015), Rev.6 (Nov 2016), Corr.1 (Oct 2022) and Corr.2 (May 2023).*

**Technical Background Document**

**(UR Z23, New. July 2006)**

**(TB: Post - External Review of the draft UR Z23, issued July 2006)**

**&**

**(TB: Pre - External Review of the draft UR Z23, issued December 2005)**

## **Technical Background Document (UR Z23, New. 2006)**

### **(Post - External Review of the draft UR Z23)**

#### **Notes from Meeting EG/NCSR 24<sup>th</sup> and 25<sup>th</sup> May 2006**

##### **Prepared by the expert group for New Construction Survey Requirements**

A meeting of the expert group was held on the 24<sup>th</sup> and 25<sup>th</sup> May 2006. The purpose has been to review the comments to the draft UR which have been made by industry and to discuss the next stages of the EG's work. The EG's response to industry comments is shown below. The EG would like to thank industry for the comments, some of the comments have been incorporated into the draft, our response to other comments are shown in this technical document. Wherever possible we have referred to paragraph numbers from the individual industry response letters.

There is an overriding comment from the shipowner groups and EMSA that the UR does not provide consistency. To counter this, it is proposed to modify table 1. The final column "Classification society proposals for the project" needs to have the ability to be expanded to allow classification comment to be added and to remove the criticism that the column is merely a check box. This can be achieved by issuing the table electronically. No other changes to the table are proposed.

The appendix has been extensively amended – and re-titled – to reflect the purpose of the examination of the shipyard, i.e. to review facilities. The amended appendix is also enclosed.

##### **SAJ comments**

1. Agree
2. Paragraph 10.2 purpose is to provide documents to facilitate inspection, repair and maintenance and should remain in the UR as shown. One advantage of the table will be as an aide memoire for surveyors, rather than for them to check back to the UR. Also, it provides clarity as to the documents which IACS do not require, this will eventually assist both shipbuilder and shipowner. We understand SAJ's concern about shipowners requiring information without giving too much thought as to the implications of their request, stating "not required" can help them. As an example, we would not expect a list of welding consumables to be listed in the SCF because this could be construed in the future as the only consumables which could be used in a future repair, when in fact any compatible consumable would be allowable.

Propose to modify 10.2.

It is recognised that the purpose of documents held in the Ship Construction File on board the ship, is to facilitate inspection (survey) and repair and maintenance, and, therefore, is to include in addition to documents listed in table 1, but not be limited to:

Delete 10.2.10

3. Table 1 is intended to be an aide memoire for surveyors. The table includes both recommendations as well as requirements and the comment is added to remind surveyors of the difference.
4. Answered separately.

### **Chinese Shipbuilders comments**

1. It is confirmed that the builder may not provide formal certification for items such as hatch covers which have been manufactured in shipyards and only provide documents such as endorsed inspection records. This is acceptable documentary evidence provided that it has been endorsed by the classification society as required by 3.3
2. No requirement for re-assessment on a periodic basis if active in the shipyard and where no major changes have occurred.

Return to definition of impact

The purpose of the assessment is to assist the classification society to plan for survey of the newbuilding and the individual society must carry out its own assessment

3. It is proposed to modify paragraph 10.1 as follows:

The shipbuilder is to deliver documents for the Ship Construction File. In the event that items have been provided by another party such as the shipowner and where separate arrangements have been made for document delivery which excludes the shipbuilder, that party has the responsibility to deliver the documents.

### **INTERTANKO comments**

1. Concerning coatings, it is proposed that no further changes are made until instructions are made by IACS.

UR paragraph number

- |       |  |
|-------|--|
| 1.1   | Amended  |
| 2.1.f | refers to ILLC only, piping supports covered by 2.1.g  |
| 2.1.g | amended  |
| 2.3   | Propose that the term "Patrol" is maintained. Verification can take place at all three stages of patrol, review and witness. Comment on documentation covered by paragraph 9.1 |
| 3.3   | amended to "shall".  |
| 4.1   | Comments noted but no change to text proposed.   |

- 5.1.5.2.i Assume that this should read “straightening” and not “strengthening”, this already covered in table 1 row 2.2 – also amended to add “fairing”. No other changes proposed.
- 6 This paragraph is to provide information for the classification society to understand capability of the shipyard, it is not meant to be a quality assessment of the shipbuilder. It is agreed, as stated in the UR, that it is also applicable to sub-contractors.
- 7.1 “Patrol” to be maintained – previous comments refer. No need to state that class will make the meeting record. Comment noted but no further amendment proposed.
- 7.4 Plan approval is not covered by this UR. Plan approval will make reference to any specific tolerances over and above normal shipyard building standards. The builder and shipowner must have the option to mutually agree to use a national or their own standards providing they are acceptable to the classification society – the text of the UR reflects this. No changes to the text are proposed.
- 7.5 Fully accept that it is beneficial to the project if the other interested parties attend the kick off meeting and the classification society will have no objections in them doing so. No change to text proposed.
- 7.6 Propose to add the following sentence. “ Notwithstanding this, the benefits of a new shipowner attending a kick-off meeting for an existing series of ships for a project cannot be underestimated and would receive the full support of the classification society.”
- 8.1 This plan is very often approved by the surveyors attending in the shipyard and not by the plan approval office, no change to text therefore proposed.
- 9.2 Comments noted but propose that no changes to the UR are made. Current text is adequate.
- 10.2.1 Propose addition to row 4 “details required” for ship construction file, no addition to paragraph 10.2.1
- 10.2.4 Outwith this UR, covered by other IACS working group
- 10.2.11 statutory issue – to be covered by the green passport, propose that this paragraph is deleted
- 10.2.12 outside of the scope of this UR, propose that this paragraph is deleted

### **Intercargo comments**

- 1.1 Paragraph amended, no further amendment proposed.
- 1.2 Comment noted, no amendment to UR proposed.
- 2.3.1,2,3 Comments noted, patrol is primarily visual. It verifies that the shipbuilding processes are being performed in a satisfactory manner. It aims to detect systematic errors, early detection of possible deviations. It is part of the process to ensure that traceability is in place. The proportion between scheduled and unscheduled will vary between shipyard to shipyard and between different ship types. It will depend upon the repetitive nature of the production process as well as the amount of mechanisation in place in the shipyard. It can even vary within workstations within a shipyard depending upon the complexity

of the operations. Concerning the comment “What is the verification/correction requirement for the unscheduled and scheduled site survey results?” – the classification society will draw the attention of the shipbuilder to any problems found, through direct contact with the shipbuilder through agreed channels of communication.

2.3.3 “Examination” as defined in paragraph 1.1 covers the whole process of classification – no further definition proposed.

3.1.b Amended

3.2 Paragraph 1.1 amended to refer to statutory

3.5 Comment noted

4.1 Comment noted but is covered by existing paragraph 9.1

5.1 Remedial work will be carried out using agreed procedures which can be based upon Recommendation 47, classification rules, or agreed shipyard fabrication standards. The columns of “Survey Requirements”, “Survey Method” and “Specific activities” are adequate – the classification society’s response will be more detailed and will be defined at the kick off meeting.

It is acknowledged that column “Classification society proposals for the project” in table 1 may give the impression of a “tick box”. This is not the intention. It is proposed to modify table 1 so that the classification society can enter a fuller description as to how the survey will be carried out for all activities.

6.1.3 Coatings are outwith this UR other than the extent mentioned in table 1

7.2 Comments noted but no changes to text proposed. All IMO and flag requirements applicable at contract agreed dates will be adhered to provided that the classification society is made aware of the contract requirements.

7.5 Fully accept that it is beneficial to the project if the other interested parties attend the kick off meeting and the classification society will have no objections in them doing so. No change to text proposed

8.1 Comment already covered by paragraph 8.2

10.2.1 Comment noted about as built drawings, however, this UR makes reference to IACS only and not IMO documents.

Comment concerning materials already covered in the paragraph.

Concerning welding procedures, these are the copyright of the shipbuilder who will be under no obligation to provide them to the ship. Also, a welding procedure is governed by local conditions and



procedures would likely need to be re-approved in the event that remedial work is carried out a different location using a different contractor, material and consumables. No changes to the text proposed.

10.2.11 statutory issue – to be covered by the green passport, propose that this paragraph is deleted

10.2.12 outside of the scope of this UR, propose that this paragraph is deleted

### **EMSA comments**

1. The draft UR concentrates on the hull survey of new construction and only deals with statutory aspects where they co-incide. It is the intention to deal with statutory aspects in the next phase of development of the UR. As an example, fire aspects of Safety Construction certification are not included in the present phase of the UR.

IMO Res.A.948 (23) has not been explicitly referred to in the UR, neither has any other IMO resolution or circular. Our group has continually referred to such IMO documents throughout the period that we have developed the UR, however, we understood that we only needed to make reference to IACS and not IMO documents.

Problems with checklists noted.

2. Comments noted. Paragraphs 1.1 to 1.4 define a scope, the text defines how the scope is dealt with. For example, “and by whom” – in paragraph 1.3 – is dealt with in paragraph 4. IACS has clear requirements for the qualification and monitoring of surveyors.

3. Comments noted and paragraph 2.3 has been amended

4. Comments noted. There is a whole process involved in surveying new construction in accordance with approved plans. It is the responsibility of the shipbuilder to ensure that the information shown in the most up to date version of approved plans has been passed into the production cycle and for the classification surveyor to ensure that this is the case.

5. The assessment of the production facilities is not an assessment of the quality of the shipbuilder (or Sub-contractor). It is to assist the classification society to assess how best to deal with the survey of the shipbuilding project in question. The whole purpose of the classification process is product verification for a specific project. Appendix 1 – as shown - is still under development.

The situation of a shipyard which is in a state of development is taken into account – this is done through the kick-off meeting referred to in paragraph 7.

The remaining comments in paragraph 5 acknowledged and appreciated

6. Concerning shipbuilding standards. IACS recommendation 47 is a guide. Established national standards may exist which have different tolerances than IACS recommendation 47 – such standards have been developed and based upon satisfactory service history – and are acceptable. This is reflected in Table number 1. Comments noted about developing shipyards.
7. EMSA's concerns appreciated. The members of this group stated that there is no uniform retention period and further discussion on the subject is required. It is proposed that this comment is referred to IACS Council for discussion on the relevant legal/quality group.
8. The extent of surveyor involvement has to be agreed project by project at the kick off meeting, which is described in section 7. It is acknowledged that column "Classification society proposals for the project" in table 1 may give the impression of a "tick box". This is not the intention. IACS Council is requested to provide this table in electronic format to enable column "Classification society proposals for the project" to be expanded to allow sufficient comment to be made for each activity by the classification society. The classification society may wish to use this table in paper or electronic format. The examples quoted at the end of paragraph 8, i.e. paragraphs 1.4, 2.5 and 3 will also be covered in table number 1.

### **General comment**

Many industry comments refer to coatings, this subject has not been discussed in depth by the EG. At the time of our meeting we were not aware of consensus from IACS. It is also understood that IMO are involved in this subject and it is proposed that this subject is further discussed by this EG during the next phase when we have been asked to review statutory issues.

The EG members agreed that the present incumbent chairman retains the position to assist in any discussions required with industry.

Under cover of document dated 25<sup>th</sup> January 2006, the EG have been tasked to develop a UI for initial statutory surveys at new construction. The EG members have requested confirmation if Form A will be issued for this task.

The next meeting of the EG is planned for September/October 2006 and the intervening period will be spent reviewing this task and entering a period of data gathering.

The EG requests confirmation that the task does not involve interpretation of statutory requirements – it is considered that this is the task of other statutory groups within IACS.

## **Conclusion**

The EG chairman will be pleased to provide further clarification if required.

Once more, on behalf of the EG, thank you for the opportunity to be involved in the development of this UR and we wish IACS success in its dealings with industry.

J.J. Finch

IACS EG Chairman - New construction survey requirements

19<sup>th</sup> June 2006

\* \* \*

### **Permanent Secretariat Note:**

1. Council concluded that the EG/NCSR is to be tasked to develop a UI for initial statutory surveys at new construction. This task does not involve interpretation of statutory requirements. Task Form A to be submitted. 4009\_ICn, 14 Aug 2006.
2. EG/NCSR is to further discuss the issue of coating in its review of statutory issues, consulting with the EG/Coating, the development in IMO should also be taken into account.

### 3. Concerning Table 1:

The 2<sup>nd</sup> paragraph of the preamble of this TB (page 1) reads as follows:  
There is an overriding comment from the shipowner groups and EMSA that the UR does not provide consistency. To counter this, it is proposed to modify table 1. The final column "Classification society proposals for the project" needs to have the ability to be expanded to allow classification comment to be added and to remove the criticism that the column is merely a check box. This can be achieved by issuing the table electronically. No other changes to the table are proposed.

It was confirmed that Table 1 should be made available to users in an Excel format, so that comments can be added to the column '*Classification society proposals for the project*'.

**END**

## Technical Background Document (Pre - External Review)

### New UR on New Construction Survey Requirements

Prepared by the expert group for New Construction Survey requirements

#### 1. Objectives

The EG was guided by the objectives in the Form A which had been decided at C50/GPG 58:

1. Develop comprehensive Unified Requirements for surveys, focusing on hull structures, as part of the classification and statutory certification process of a new building to verify that ships comply with the relevant Rules and Regulations (i.e. before being put into service for the first time).
2. Establish a link between the classification and statutory surveys (where delegation applies), the developed URs and draft goal based standards being developed at the IMO, aiming at ensuring the clear, comprehensive and consistent application of classification rules and relevant statutory requirements, including UIs, at the shipyards and their sub-contractors.
3. With reference to the draft UR developed by AHG/NCSR, ensure that a more comprehensive and more robust UR, meeting the expectations of industry (i.e. shipbuilders and shipowners) and flag Administrations, is developed. In order to meet these expectations the new UR shall ensure that all survey items contained in individual Members' Rules and the relevant statutory requirements are covered.

#### 2. Background

The form A also provided a background which is repeated below.

To further develop and complete the draft UR prepared by the AHG/NCSR on requirements for survey of hull structures during ship construction in order to ".....ensure a **more comprehensive and more robust UR meeting the expectations of Industry.**" as requested by IACS Council at C 50, December 2004.

Prior to the first meeting, the group changed from a 'working' to an 'expert' group and received a directive to report direct to Council and not the GPG.

#### 3. Discussion

The EG held two meetings on 20<sup>th</sup> to 22<sup>nd</sup> July and 15<sup>th</sup> and 16<sup>th</sup> September 2005. The EG was aware of the tight schedule and the members have endeavoured to stay within it.

The group has once more, progressed the work by consensus.

C51 was held just prior to the first meeting of the EG. The relevant draft minutes of C51 concerning surveyor manning changed prior to final release. The EG therefore agreed that the subject should not be included in to the UR until Council gave a clearer directive.

The EG had the advantage that the majority of the members had worked together on the previous ‘ad hoc’ group – KR, DNV and BV provided new members for the EG.

The EG has progressed by developing the draft UR submitted in November 2004.

The major differences between the first and second URs which have been submitted are as follows:

Definitions and applications are now in separate sections.

The EG agreed there were four factors to demonstrate consistency of surveys,

Comments on qualification and monitoring of personnel were expanded, inspectors are used by classification societies for repetitive survey work. The EG propose to Council that consideration should be given to acknowledge the training/education requirements for inspectors. A comment has also been raised concerning the use of seconded surveyors, and it is proposed that this can be dealt with in the future.

In addition to the section on ‘survey of hull structure’, three new sections have been added:

Assessment of the shipyard’s construction facility

Newbuilding survey planning

Examination and test plan for newbuilding activities

The table of surveyable items referred to in ‘survey of hull structure’ has been developed with the aim to satisfy the work instruction of the Form A:

“specific lists and definition of appropriate evidence to be prepared and given to the surveyor”

The document for the assessment of the shipyard’s construction facilities is based upon NK’s procedure and remains to be completed, the draft, shown as an appendix, however, indicates the thinking of the EG.

Concerning newbuilding survey planning, comments have been raised to be more specific about defining the use of sub-contractors, e.g. for NDE. The use of NDE sub-contractors has been an issue raised by the original ad hoc group

as well as the Eg and consideration needs to be reviewing them further in the future.

Concerning the proof of consistency of construction surveys. Members have expressed concern about survey documents being provided to third parties during the course of an audit. It is the intention of this UR that any audits are carried out by responsible bodies empowered by law, convention or IACS.

Concerning the Ship Construction File, the EG would propose that documents concerning wastage, diminution and renewal thicknesses should be included in the UR as soon as IACS are able to provide clear guidelines on requirements, Council comment would be appreciated on this subject. Further consideration is needed by the EG to propose who should check and verify the contents of the ship construction file, if it becomes a classification item then it could become an issue to withhold the classification certification at delivery. This needs to be discussed further.

The original 'Ad Hoc' group raised some queries in the first submission in 2004, these are repeated below and Council comment would be appreciated.

The treatment of sub-contract NDE operators in the shipyards.  
The non-uniform application of UR S14

References to UR S6 in Recommendation 20 are not consistent

A comment concerning health, safety and the environment has been included in the UR, it was agreed by the EG that any further reference to the subject should be made in other IACS documents.

#### **4. Conclusion**

The EG Chairman would be please to provide any clarification, answer any questions or provide any further comment if required.

Finally, on behalf of the members of the EG, thank you for the invitation to work together on this subject, it has been a great pleasure to do so and we all hope that we have been able to make a contribution to the success of IACS and our industry.

J.J. Finch

29/09/2005

#### **5. Council Considerations**

In adopting the UR, Council considered that the proposed Forward was inappropriate for the UR but should be retained and recorded in the TB as follows:

The UR on Hull Survey for New Construction:

- 1.1 is to verify that ships are in accordance with the relevant Rule and Statutory requirements as part of the classification and statutory certification as part of the new building process (i.e. before being put into service for the first time),
- 1.2 is focused on the hull structure,
- 1.3 establishes a link between the classification and statutory surveys. It establishes a link with the draft goal based standards being developed at the IMO (78th session MSC 78/6/2 5 February 2004),
- 1.4 aims to ensure clear, comprehensive and consistent application of classification rules and statutory requirements at the shipyards and their sub-contractors,
- 1.5 gives guidance on the specific requirements involved in the construction of the ship to support the surveyors,
- 1.6 assumes delegation of authority for the flag state is a prerequisite to verification of Statutory Regulations by the classification society as indicated herein,
- 1.7 assumes that compliance with this UR does not remove the responsibility from the shipbuilder which is to ensure and demonstrate that a satisfactory level of quality has been achieved,
- 1.8 assumes that the shipbuilder should bring to the attention of the classification society any deviations from the rules and statutory requirements found during construction.
- 1.9 assumes that shipbuilder has the primary contractual responsibility to ensure that ships are built to meet the functional requirements and safety objectives of the draft goal based standards and that it is the role of the classification society to verify this through survey.
- 1.10 assumes that health, safety and environment protection measures during new building survey should be provided by the shipbuilder in accordance with the classification societies' requirements.

6. **Council 52 Consideration (13-15 Dec.2005)**

Concerning the 2<sup>nd</sup> sentence of paragraph 9.2, Council discussed its impact and decided to delete it because it was a negative proposal which should not be broadcast.

- 9.2 For audit purposes, the ~~actions and~~ information specified in 9.1 is to be made available. ~~Evidence of other surveyors' activities such as patrolling or review of documents other than those specified in 9.1 need not be provided.~~

\*\*\*



## TECHNICAL BACKGROUND

### UR Z23 (Rev.2, April 2009)

#### **January 2009 Update to “(Post - External Review of the draft UR Z23) TB, July 2006”:**

- 1 The comments raised by the QC after their Auditability Review in Feb. 2008 were generally accepted by the EG and Z23 was updated to reflect the comments.
- 2 Paragraph 6 – Review of the Construction Facility was amended to further clarify and confirm the purpose of the review.
- 3 The requirements for the timing and requirements for New Building Survey Planning for series vessels were clarified.
- 4 There was discussion around the requirements for the supply of information for the Ship Construction File given in Table 1 of the UR when the SCF was not yet a mandatory requirement of Goal Based Standards.
  - a. It was agreed that the information on the Hull Construction required by this UR for inclusion in the Ship Construction File should be reviewed for content and confirmed that it has been placed on board.
- 5 Table 1 was updated to include a reference to the requirements for PSPC in accordance with the instructions from GPG.
- 6 It was agreed by the EG that Appendix 1 was included as an example of the form but that each Society would make their own Review Record.
- 7 There were various minor editorial corrections to clarify the text throughout.

Submitted by EG/NCSR Chairman  
27 February 2009

#### **Permanent Secretariat note (April 2009):**

Rev.2 of UR Z23 was approved by GPG, with an implementation date of 1st July 2010, on 14 April 2009 (ref. 9529\_IGd) together with new UIs SC234, LL76 and MPC96 covering ‘Initial Statutory Surveys at New Construction’.

## **Technical Background Document UR Z23, Rev. 3 (June 2013)**

### **1. Scope and objectives**

To revise UR Z23 taking into account the IMO Ship Construction File (SCF) Guidelines and relevant requirements of the GBS Guidelines related to design transparency and construction surveys.

### **2. Engineering background for technical basis and rationale**

- Survey Panel reviewed the IMO documents with respect to the key words 'Ship Construction File (SCF)', 'Construction Survey' and 'Design Surveys' in order to ensure the consistency of URZ23 with the IMO GBS standards and Guidelines.
- Existing UR Z23 has been revised by including a new appendix (Appendix2 ) for goal based ship construction standards for bulk carriers and oil tanker in order to comply with IMO requirements for design transparency, ship construction file , construction surveys mentioned in IMO Res.MSC.287 (87), IMO Res.MSC.296 (87),IMO Res.MSC.290(87) and MSC.1 /Circ. 1343.

### **3. Source/derivation of the proposed IACS Resolution**

None

### **4. Summary of Changes intended for the revised Resolution**

Para 1 of "Appendix2" has provisions as per the IMO GBS requirements regarding examination and test plan for new building activities.

The design transparency requirement of IMO Res.MSC.287 (87) and IMO Res.MSC.296 (87) has been included in Para 2 of "Appendix2".

Para 3 of newly added "Appendix 2" is related to the IMO requirements of Ship Construction File (SCF) which requires that any alternatives to the rules, structural details and equivalency calculations to be included to SCF. It also requires that the SCF shall be maintained and updated throughout the ship's life at any major event, including, but not limited to, major repair, conversion/modification of ship structure in order to facilitate safe operation, maintenance, survey, repair and emergency measures.

### **5. Points of discussions or possible discussions**

None

### **6. Attachments if any**

None

## **Technical Background for UR Z23 Rev.4, Mar 2014**

### **1. Scope and objectives**

Review the comments made by industry (INTERTANKO, BIMCO)

### **2. Engineering background for technical basis and rationale**

Panel reviewed the feasibility to the proposals received from Industry (INTERTANKO, BIMCO). Panel found some of the comments did not fall under the responsibility of class surveyors and not within the scope of UR Z23. Thus Panel did not include these proposals to the present revision of UR Z23.

### **3. Source/derivation of the proposed IACS Resolution**

None

### **4. Summary of Changes intended for the revised Resolution**

Following changes are made to UR Z23:

- a) Sec. 2.3.3: Term 'or equivalent' deleted from the text.
- b) Sec.7: This section modified based on the comments made by industry. Term "series ship production" was introduced.
- c) Table 1, Hull Surveyable Items Activities Table, Item 7.1 (Application of Protective Coatings for Dedicated Seawater Ballast Tanks in all Types of Ships and Double-Side Skin Spaces of Bulk Carriers subject to PSPC) - Documentation available to classification surveyor during construction – Coating Standard revised to Signed and Verified Tripartite Agreement.

### **5. Points of discussions or possible discussions**

None

### **6. Attachments if any**

None

## **Technical Background (TB) document for UR Z17 (Rev.15 Oct 2020) and UR Z23 (Rev.7 Oct 2020) and UR Z28 (New Oct 2020)**

### **1. Scope and objectives**

For addressing the complicated and arduous activities associated with the class inspections required for assuring the integrity of the pressure rated multi-cable transit (MCT) systems installed onboard ships or mobile offshore units (MOUs) from the time of their construction till the end of the ship's life, IACS took the decision:

- to develop new unified requirements on the survey of MCT systems, to be included in URs Z23, Z7 and Z15, based on the use of approved service suppliers to conduct the inspections of MCT systems; and consequently,
- to develop the relevant criteria for the certification of these service suppliers, to be included in UR Z17.

### **2. Engineering background for technical basis and rationale**

IACS Survey Panel, based on the information provided by various MCT system OEMs to the specific Project Team (PT) established for this task, identified the following items to be considered for drafting the survey requirements:

- A. conduct regular inspections to assure good condition of MCT systems, identify possible problems and address repairs in a timely manner;
- B. assure the traceability and product document for MCT systems through their lifecycle;
- C. apply easy to use technologies (digitization, RFID etc.) to store MCT system condition information;
- D. utilize external specialists to perform inspections and to supplement Surveyor's efforts;
- E. analyze repair-data to identify trouble-prone components or systems for proactive attention;
- F. standardize inspection and test methods in accordance with OEM recommendations.

IACS Survey Panel acknowledged the following added values in the use of external specialists for the inspection of MCT system and in the adoption of a MCT system register:

- A. a means to uniformly carry out the inspection of MCT system across all the class societies;
- B. an expert focus on an acknowledged weak-point of bulkhead integrity through the life cycle of a vessel or marine asset;

- C. a system by which MCT systems installation can be tracked throughout their life cycle.

### **3. Source/derivation of the proposed IACS Resolution**

- A. Industry feedback originating from known casualties and repetitive incidents of poorly installed and maintained equipment.
- B. OEM best practices and standards for installation and maintenance.
- C. OEM methodologies for documenting and tracking changes, disruptions, repairs or maintenance of MCT system installations.

### **4. Summary of Changes intended for the revised Resolution:**

Changes to Z23 will include new requirements which mandate the adoption of a Multi Cable Transit Seal Systems Register.

The Register, in hard copy or digitized media, will require any MCT system installation to be documented at time of ship's construction. The Register will include a marking / identification system, documentation referencing manufacturer manual(s) for each type of cable transit installed, the Type Approval certification for each type of transit system, applicable installation drawings, and a recording of each installed transit documenting the as built condition after final shipbuilder inspection in the shipyard.

The Register will also include sections to record any inspection, modification, repair and maintenance.

A recommendatory sample Cable Transit Seal System Register will be included in UR Z23 as an attachment.

A new item 8.6 is to be newly inserted into the Table 1 of UR Z23.

Subsequently, a new URZ will be developed in order that the Register will serve as an on board document maintained to track inspections, modifications and repairs and ensure such activities are properly performed by qualified personnel. The Register will also provide the Class Society Surveyor with a tool to improve the effectiveness of periodic inspections on marine vessels at the time of annual and special surveys.

In view of the above, UR Z17 will be revised to include the requirements for the approval of a new category of service suppliers for the inspection of Cable Transit Seal Systems, who will be tasked to verify MCT systems installation. This will assist to promote adherence to proper installation and maintenance procedures.

A new section 17 will be inserted in UR Z17.

### **5. Points of discussions or possible discussions**

5.1 Survey Panel concurred with the view that the fire rated MCT systems and the pipe penetrations should not be considered under this topic, since this task was specifically dealing with Watertight Cable Transits as proposed by the member initiating this issue.

5.2 Survey Panel and PT agreed to define in the Ship Construction File of UR Z23 a document 'Cable Transit Seal System Register' to record the details of watertight cable transits of a ship installed while under construction and throughout its life, including sections to record any inspection, modification, repair and maintenance.

5.3 Survey Panel concurred with the view that criteria should be established to support electronic formatting of the 'Cable Transit Seal System Register', which is the most operationally effective path to assist owners with installation, inspection, maintenance, and repairs throughout the MCT lifecycle, and agreed to include the recommendatory sample of the Cable Transit Seal Systems Register prepared by PT as Appendix 3 of UR Z23.

5.4 Survey Panel agreed to insert a new hull inspection item 8.6 for Watertight Cable Transit Seal System into Table 1 of UR Z23. When discussing whether to enter in the 'Survey Requirements for Classification' with "tightness", some members were of the view that after installation a leak test may be carried out but it is hard to check the actual watertightness of the CTSS, while the other members preferred to testing the watertightness of the CTSS after installation, and finally the panel agreed to leave the requirements of testing of the watertightness of CTSS to be decided by each society individually.

5.5 Survey Panel and PT deemed it necessary to use approved service suppliers to conduct inspections to the MCT/Transit systems, and developed the Section 17 of UR Z17 for the approval of the service suppliers engaged only in the inspections of Cable Transit Seal Systems, with a view that it will be impractical to use an approved service supplier every time for installing or maintaining the Multi Cable Seal Systems, such as when renewing a single cable.

5.6 Provisions for authorization were included in paragraph 17.2.3 of UR Z17 to allow for cases where the transit system OEM is no longer in business or does not provide technical support.

5.7 In paragraph 17.2.1 of UR Z17, it was agreed to include the contents to approve manufacturers or shipyards equally when they are acting as Service Suppliers.

5.8 Other than revising UR Z7 and UR Z15 for the survey requirements of CTSS for ships in service, Survey Panel agreed to develop a new UR Z28 applicable to all vessels and Mobile Offshore Units (MOUs) contracted for construction on or after 1st July 2021, in addition to the requirements of URs Z23, Z7 and Z15.

5.9 Survey Panel agreed to insert item 1.3 to UR Z28, and apply the survey requirement of item 8.6, Table 1 of UR Z23 to MOUs.

5.10 For the paragraph 4.1.3 of UR Z28, one Survey Panel member was of the view that the approved service supplier should also be permitted to undertake inspection of any disruption to the cable transits or installation of new cable transits, otherwise the use of having an approved service supplier is significantly reduced, while the other members supported to confirm those situations by the attending surveyor, and thus the wording "by the attending surveyor" is retained.

**6. Attachments if any**

Nil.

## UR Z24 "Survey Requirements for Shell and Inner Doors of Ro-Ro ships"

### Part A. Revision History

Version no.	Approval date	Implementation date when applicable
Corr.1 (July 2011)	15 July 2011	1 January 2012
New (Nov 2010)	16 Nov 2010	1 January 2012

- **Corr.1 (July 2011)**

**.1 Origin of Change:**

- Suggestion by IACS member

**.2 Main Reason for Change:**

To revise the definition of the Ro-Ro ship as defined in 2.1 of UR Z24 because some Ro-Ro ships are not fitted with a loading ramp, but rather utilize a shore-based ramp since these vessels are on a common trade route.

**.3 List of non-IACS Member classification societies contributing through the TC Forum and/or participating in IACS Working Group:**

None

**.4 History of Decisions Made:**

The matter was discussed by Survey Panel under PSU 11015 and all members agreed with the revised wordings of Ro-Ro ships. Panel also agreed to consider this revision as a correction with the same implementation date of 1 January 2012.

**.5 Other Resolutions Changes**

None

**.6 Dates:**

Original Proposal: *June 2011*

Panel Approval: *28 June 2011 by: Survey Panel*

GPG Approval: *15 July 2011 (Ref: 11112\_IGc)*

- **New (Nov 2010)**

**.1 Origin of Change:**

- Other (The new unified requirement UR Z24 was developed based on the Internal Guideline No. 8 which therefore became obsolete)



**.2 Main Reason for Change:**

N/A

**.3 List of non-IACS Member classification societies contributing through the TC Forum and/or participating in IACS Working Group:**

None

**.4 History of Decisions Made:**

N/A

**.5 Other Resolutions Changes**

None

**.6 Dates:**

Original Proposal: *Sept 2007*

Panel Approval: *15 October 2010*

GPG Approval: *16 November 2010 (Ref: 8558bIGf)*

## **Part B. Technical Background**

List of Technical Background (TB) documents:

Annex 1      **TB for New (Nov 2010)**

See separate TB document in Annex 1.



*Note: There is no separate Technical Background (TB) document for Corr.1 (July 2011).*

## **Technical Background for UR Z24 New, Nov 2010**

### **1. Scope and objectives**

The Project Team was instructed to review IACS IG8 to determine whether the IG8 should be changed to a new UR or is to be implemented into UR Z7. The Project Team decided to develop a new UR Z24 Survey Requirements for Shell and Inner Doors of Ro-Ro ships.

### **2. Engineering background for technical basis and rationale**

N/A

### **3. Source/derivation of the proposed IACS Resolution**

The new UR Z24 is based on the previous IG8.

### **4. Summary of Changes intended for the revised Resolution:**

N/A – new unified requirement

### **5. Points of discussions or possible discussions**

During a meeting in Hamburg in September 2007, the Project Team drafted a new UR Z24 Survey Requirements for Shell and Inner Doors of Ro-Ro ships. Further comments were discussed through correspondence and sketches added to the UR. This version was forwarded to the Panel for final decisions at the Spring meeting in March 2008 in Daejeon, Korea.

Point 3.3.3 of the new UR concerning the minimum thickness of hinging arms, securing, supporting and locking devices was forwarded to the Hull Panel and finally agreed upon in May 2010.

### **6. Attachments if any**

None

## UR Z25 “Periodic Survey of Fuel Installations on Ships other than Liquefied Gas Carriers utilizing gas or other low flash point fuels”

### Part A. Revision History

Version no.	Approval date	Implementation date when applicable
Rev.1 (Sep 2017)	12 September 2017	01 January 2019
New (Jan 2017)	23 January 2017	01 January 2018

- **Rev.1 (Sep 2017)**

**.1 Origin for Change:**

- Other (Suggestion by IACS Representative of IMO CG on HSSC survey guidelines)

**.2 Main Reason for Change:**

During discussions about the HSSC survey items relevant to IGF Code drafted by IMO CG on HSSC survey guidelines with the reference to IACS UR Z25, the IACS Representative of the correspondence group proposed revisions to IACS UR Z25 on the requirements about randomly selected internal examinations and tests to PRVs of gas fuel bunker lines.

**.3 List of non-IACS Member Classification Societies contributing through the TC Forum and/or participating in IACS Working Group:**

None.

**.4 History of Decisions Made:**

During discussions about the HSSC survey items relevant to IGF Code drafted by IMO CG on HSSC survey guidelines with the reference to paragraph 2.2.4.ii) of IACS UR Z25, the IACS Representative of the correspondence group proposed revisions to IACS UR Z25 on the requirements about randomly selected internal examinations and tests to PRVs of gas fuel bunker lines.

Survey Panel members agreed that all PRVs should be opened for internal examination and testing within the 5 year survey cycle, and the random selections of the valves to be internally examined and tested at the time of renewal survey should be only applicable to the PRVs which are overhauled and tested between the previous and the present renewal surveys.

The revisions to paragraph 2.2.4.ii) of IACS UR Z25 were agreed by Survey Panel.

No technical background is expected.

## **.5 Other Resolutions Changes**

None.

## **.6 Dates:**

Original Proposal: 6 June 2017 Made by: IACS Representative of IMO CG on  
HSSC survey guidelines

Panel Approval: 23 August 2017 (Ref: PSU16045a)

GPG Approval: 12 September 2017 (Ref: 16095f\_IGg)

## **• New (Jan 2017)**

### **.1 Origin for Change:**

- Suggestion by IACS member

### **.2 Main Reason for Change:**

During discussions at the September 2015 Survey Panel Meeting, the members supported developing common survey requirements for gas fuelled ships considering the implementation of the IGF Code on ships constructed on or after 1 January 2017.

### **.3 List of non-IACS Member Classification Societies contributing through the TC Forum and/or participating in IACS Working Group:**

None.

### **.4 History of Decisions Made:**

The Survey Panel formed a Project Team to review the IGF Code to develop periodical survey requirements for the gas fuel systems. The Form A and Form 1 were approved by GPG on 10 February 2016. The project team held a workshop in Genoa on 14 March 2016 to develop the draft UR which was progressed through correspondence. During the development of the draft UR, it was decided to also include ships utilizing other low flashpoint fuels. The project team submitted a draft UR to the Survey Panel on 29 June 2016 for their approval. The Survey Panel raised comments which were sent to the project team for consideration on 9 August 2016. The project reviewed the comments and submitted a revised draft UR to the Survey Panel on 31 August 2016. The draft UR was discussed and finalized at the Survey Panel Meeting held 7 – 9 September.

No technical background is expected.

## **.5 Other Resolutions Changes**

None.

## **.6 Dates:**

Original Proposal: 17 September 2015 Made by: IACS Member

Panel Approval: 09 September 2016 (Ref: PSU15009)

GPG Approval: 23 January 2017 (Ref: 16003\_IGg)

## Part B. Technical Background

List of Technical Background (TB) documents for UR Z25:

**Note:**

*1) There are no separate Technical Background (TB) documents for New (Jan 2017) and Rev. 1 (Sep 2017).*

## UR Z26 “Alternative Certification Scheme (ACS)”

### Part A. Revision History

Version no.	Approval date	Implementation date when applicable
New (Feb 2015)	27 February 2015	1 July 2016

- **New (Feb 2015)**

#### .1 Origin for Change:

- Request by non-IACS entity (AHG CMC)
- Suggestion by IACS members
- Based on Other Standards [IACS members’ current rule related alternative certification scheme, EN 10204(2004) and ISO 10474 (1991)]

#### .2 Main Reason for Change:

An individual certification scheme and an alternative certification scheme are the two current certification procedures for both engines and parts. The existing IACS URs addressing machinery inspection and certification were solely focused on individual certification. The two currently operated schemes need to be reviewed in light of possible alternative certification schemes as proposed by AHG CMC, and an update and/or revision of the current certification procedures for both engines and parts.

#### .3 List of non-IACS Member classification societies contributing through the TC Forum and/or participating in IACS Working Group:

None

#### .4 History of Decisions Made:

It was decided at the kick-off meeting (held in 24 – 25 April 2008) of the Project Team that ACS, which could be used parallel to traditional approaches, should be developed based on the members’ current ACS requirements. The draft of the ACS was developed by the PT and submitted to the 12<sup>th</sup> Machinery Panel meeting for its review. The draft was finalized at the 15<sup>th</sup> Machinery Panel meeting.

The agreed version, finalized in the 16<sup>th</sup> panel meeting, was submitted to the Survey Panel for their agreement and/or comments. In addition we requested the Survey Panel to agree to issue the UR as a Z.

The Survey Panel agreed to issue the UR as Z and gave 3 comments which have been handled in the Machinery Panel.

The Panel, at the 12<sup>th</sup> meeting, agreed that the ACS be developed solely for the engine products, without considering the mutual recognition concept. However, at the 15<sup>th</sup> Panel meeting, the majority agreed not to limit the scope of the ACS to machinery only, with at least two Societies proposing to limit the scope to engine products only.

The Survey Panel had 3 comments to the draft UR which was subject to the Machinery Panel review.

## **.5 Other Resolutions Changes**

UR M14 and M5 are to be deleted.

## **.6 Dates:**

Panel Approval: 08 January 2015 (By: IACS Machinery Panel)  
GPG Approval: 27 February 2015 (Ref: 7569\_IGw)



## **Part B. Technical Background**

List of Technical Background (TB) documents of UR Z26:

Annex 1. **TB for New (Feb 2015)**

See separate TB document in Annex 1.



## **Technical Background (TB) document for UR Z26 (New Feb 2015)**

### **1. Objective and background.**

The existing IACS requirements for machinery have inspection by the Surveyor as the sole option for survey in connection with certification for class. ISO and EN standards, however, offer several other options. In spite of the fact that IACS requirements do not prescribe ways to take advantage of Quality Systems, some Societies have been practicing alternative certification schemes for several years. In connection with the revision of 10 UR-Ms, the Project Team (PT3 consisting of 7 members) considered that the unification of alternative certification schemes was necessary.

### **2. Methodology of Work.**

A draft of the UR was put together from existing rules from those Societies having implemented alternative certification schemes. The other members added improving comments to the draft.

### **3. Engineering background**

The ACS complements traditional certification schemes as required by a Society's rules. Under the ACS a Surveyor need not be present at all inspections and testing.

### **4. Points of discussion or possible discussions**

There was no significant dispute about the contents of the draft.

At the 16<sup>th</sup> meeting, and due to comments from societies, the draft was subject to thorough examination:

Main changes:

The definition has been changed to remove "agreement" as not all societies make an agreement.

The definition of certificate type was moved to M72 as an ACS is limited to the Society Certificate.

A general tidying up of the content was also made.

The comments from the Survey Panel were circulated in the Machinery Panel and discussed at the 17<sup>th</sup> meeting.

It was agreed not to add the proposed definition: "For the purposes of ACS; Conformity Assessment, Unit Certification and Factory Acceptance Testing will be synonymous terms" as the ACS regards equipment and systems requiring Society Certificate only. It was agreed to include specific items on current drawings and Rules and standards. It was agreed to delete the "issuing the Society Certificate" and include "e.g. declaration of conformity".

### **5. Attachments if any**

None

## UR Z27 “Condition Monitoring and Condition Based Maintenance”

### Summary:

IACS developed this new unified requirement for the approved Condition Monitoring and Condition Based Maintenance schemes applying to machinery components and systems where condition monitoring results are used to influence the scope and/or frequency of Class survey, including the requirements of software, onboard working, documentation, personnel, approval and survey for applying the scheme, and survey/audit for maintenance of the scheme.

### Part A. Revision History

Version no.	Approval date	Implementation date when applicable
New (July 2018)	12 July 2018	1 January 2020

- **New (July 2018)**

#### 1 Origin of Change:

- Suggestion by IACS members

#### 2 Main Reason for Change:

To address the FUA 11 of C73, raised by the Council of the IACS in respect to the future work directions on the implications of new technology on Remote Monitoring/Diagnosis (RMD) and Condition Based Inspecting/Maintenance (CBM). Survey Panel discussed the issue and agreed to establish a PT to provide suggestions for the possible revisions of the relevant IACS Resolutions and Recommendations (e.g. UR Z18, UR Z20, Rec.74) and the draft of new Recommendations/Guidelines which may help the concrete application of these technologies.

#### 3 List of non-IACS Member Classification Societies contributing through the TC Forum and/or participating in IACS Working Group:

None

#### 4 History of Decisions Made:

Survey panel discussed this issue under Panel task PSU16057 allocated by GPG on 21th October 2016. The subject deals with the review of the UR and Recommendation under Panel responsibility in order to determine whether a revision could need in order to consider the new technologies on Remote Monitoring/Diagnosis (RMD) and Condition Based Inspecting/Maintenance (CBM).

In this respect the Survey Panel discussed the topics and agreed that a PT dealing with the matters would be advisable in order to provide suggestions for the possible revisions of the relevant IACS Resolutions and Recommendations (e.g. UR Z18, UR

Z20, Rec 74) and the draft of new Recommendations/Guidelines which may help the concrete application of these technologies.

PT PSU34/2017 was established, and newly drafted the UR Z27 "Condition Monitoring and Condition Based Maintenance"

During the 26th Survey Panel meeting, panel members concurred with comments on PT's submission and proposed actions were taken by the PT. Survey Panel reviewed the drafts which was further amended and agreed by Survey Panel. Finally, the qualified majority of the Panel Members agreed the draft text of the UR Z27 and modifications to UR Z18, UR Z20 and Recommendation 74.

Refer TB Document in Annex 1.

## **5 Other Resolutions Changes:**

UR Z18, UR Z20

## **6 Dates:**

Original Proposal : 21 October 2016 assigned by GPG  
Panel Approval : 15 June 2018 by Survey Panel (Ref: PSU16057)  
GPG Approval : 12 July 2018 (Ref: 18076\_IGd)

## Part B. Technical Background

List of Technical Background (TB) documents for UR Z27:

Annex 1. **TB for New (July 2018)**

See separate TB document in Annex 1



## **Technical Background (TB) document for UR Z27 (New July 2018)**

### **1. Scope and objectives**

Upon the investigations of new technologies' implications on survey regime, IACS developed this unified requirement to the approved Condition Monitoring and Condition Based Maintenance schemes applying to the machinery components and systems where the condition monitoring results are used to influence the scope and/or frequency of Class survey, including the requirements of software, onboard working, documentation, personnel, approval and survey for applying the scheme, and survey/audit for maintenance of the scheme.

### **2. Engineering background for technical basis and rationale**

As far as the PT members have been able to conclude, the CBM is a set of maintenance actions based on real-time or near-real time assessment of equipment condition which is obtained from embedded sensors and/or external tests & measurements taken by portable equipment. From a Classification Society's consideration, the RMD embraces similar principles of monitoring. Apart of CBM and RMD there exist various systems of monitoring based on acquisition and processing of information and data that indicate the state of a machine over time. With emerging technologies such as Radio Frequency IDentification (RFID), various sensors, Micro-Electro-Mechanical System (MEMS), wireless tele-communication, Supervisory Control and Data Acquisition (SCADA) and Product Embedded Information Devices (PEID) there are expected to be rapidly used in the world such systems for gathering and monitoring the status of components. Moreover, the CBM scheme in general can be treated as a method used to reduce the uncertainty of maintenance activities and embraces various condition monitoring/diagnosis technologies and techniques such as lubricant/fuel, wear particle, bearing temperature, infrared thermography and motor current signature analysis.

Having recognized that, the PT agreed the subsequent Guidelines shall not be limited only by CBM and RMD systems and decided to leave opportunity for implementation existing and forthcoming systems based on the principals of the condition monitoring/diagnosing intrinsic to the CBM.

### **3. Source/derivation of the proposed IACS Resolution**

The PT reviewed the current IACS Resolutions and Recommendations and detected paragraphs potentially impacted.

### **4. Summary of Changes intended for the revised Resolution:**

The PT prepared a draft of a new document UR Z27 covering Condition Monitoring and Condition Based Maintenance schemes where the condition monitoring results are used to influence the scope and/or frequency of Class survey. Besides, the PT proposed a draft of corrigenda to the UR Z18, UR Z20 and Recommendation 74.

## **5. Points of discussions or possible discussions**

The task was triggered by GPG to review and set the future work directions on the implications of new technology on survey regime, in relation with other technologies, especially the Remote Monitoring/Diagnosis (RMD) and the Condition Based Inspecting/Maintenance (CBM). A project team was agreed to be established, and the Form A and Form 1 were agreed by GPG on 24/03/2017.

PT manager submitted the PT outcomes to the Survey Panel meeting on 25/08/2017, and some comments were got from panel members before the 26th panel meeting.

During the 26<sup>th</sup> Survey Panel meeting, a Member introduced their comments and indicated that as a minimum requirement, the related UR shall include the minimum parameters to be checked in order to monitor the condition of the various machinery for which this type of maintenance is accepted; The panel agreed with the view of a Member that for ease of understanding and implementation, revisions should be made in UR Z20 only, to include the elements of the proposed new UR instead of having two separate URs.

The PT suggested:

- that elaborating on requirements would likely to limit UR's applicability for ensuing technologies, thus no changes are required.
- to steer a course of action had been embarked on during the team joint work and be committed to have a separate UR Z27 instead of merging the requirements with UR Z20.

Based on preceding discussion it was concluded that qualified majority of the Panel Members agreed with PT's opinion that a separate UR for CM/CBM as designed by PT was the appropriate course of action.

PT, after examination of the Panel's comments, prepared

- a new version of the draft UR addressing the comments and suggestions, and
- the technical justifications/explanations.

On October 2017 PT sent to the Panel the new version of the draft.

Finally, the qualified majority of the Panel Members agreed the draft text of the UR Z27 and modifications to UR Z18, UR Z20 and Recommendation 74.

## **6. Attachments if any**

None

## UR Z28 “Surveys of Watertight Cable Transits”

### Summary

This modification is to correct reference in para. 2.1.1

### Part A. Revision History

Version no.	Approval date	Implementation date when applicable
Corr.1 (June 2021)	30 June 2021	-
New (Oct 2020)	02 October 2020	1 July 2021

- **Corr.1 (June 2021)**

#### 1 Origin of Change:

- Suggestion by IACS member

#### 2 Main Reason for Change:

This modification is to correct a reference in para.2.1.1.

#### 3 List of non-IACS Member classification societies contributing or participating in IACS Working Group:

None

#### 4 History of Decisions Made:

A member of the Survey Panel found one wrong reference in para.2.1.1. Para.2.2.1 gives an example of record “Recommendatory Sample – Cable Transit Seal System register” as appendix 1. However, the appendix 1 is not attached in UR Z28. Survey Panel discussed about it and concluded to put a reference to appendix 3 of UR Z23 rather than to attach the same record into UR Z28.

#### 5 Other Resolutions Changes:

None

#### 6 Any hinderance to MASS, including any other new technologies:

None

#### 7 Dates:

Original Proposal: 17 March 2021 Made by A Survey Panel Member  
 Panel Approval: 21 June 2021 (Ref: PSU21011)  
 GPG Approval: 30 June 2021 (Ref: 16222aIGb)



- **New (Oct 2020)**

#### **1 Origin of Change:**

- Suggestion by IACS member

#### **2 Main Reason for Change:**

A global unified standard is required to improve the installation and maintenance of Pressure-Rated MCT/Transit systems. In order to properly maintain Ship and Mobile Offshore Unit structures and promote vessel safety during water ingress a better method is necessary to document and manage installation, maintenance, and repair of MCT/Transit systems. By improving documentation during initial installation, incorporating the installation information into a systemized maintenance plan, and using knowledgeable authorized/approved service entities to conduct inspections and manage repairs or alterations, the risks of MCT failures will be reduced. This will mitigate potential safety and environmental incidents as a result of service oversights and exposure to onboard flooding damage conditions.

#### **3 List of non-IACS Member classification societies contributing or participating in IACS Working Group:**

None

#### **4 History of Decisions Made:**

A member of the Survey Panel raised the issue of survey requirements during the 24th Survey Panel Meeting. In detail under discussion is the concept for the preparation of an IACS tool (a Recommendation or an UR, whichever deemed more appropriate) which addresses the complicated and arduous activities associated with the particular inspections required for class to accept the continuous integrity of the multi cable transit from the time of their installation till to the end of the ship's life.

In this respect the Survey Panel discussed the topics and agreed that a PT dealing with the matters would be advisable in order to provide suggestions for the possible revisions of the relevant IACS Resolutions (e.g. Z23, Z7, Z15, and Z17)

PT PSU32/2017 was established, and made revisions to the UR Z23, Z7 and Z17.

PT's proposal was submitted to the Survey Panel on 11 August 2017, panel members concurred with comments on PT's submission and proposed actions were taken by the PT. Survey Panel reviewed the drafts which was further amended and agreed by Survey Panel on 14 March 2019 during the 29th Panel Meeting.

Realizing that the UR for approval of Service Suppliers for the inspection of Cable Transits is newly developed by IACS, before enough Service Suppliers being approved, it might be premature to push out the UR for the inspections to the cable transits of ships in service, the members agreed to push out the IACS URs step by step, and firstly to work out the revision to UR Z23 to include the requirement of the "Register" for new construction ships, and the revision to UR Z17 for the details of the approval requirements of the Service Suppliers for the inspection of Cable Transits, and secondly to complete the draft of the new URZ (other than revising URs Z7 and Z15) in

a later time with all the survey requirements to the cable transits, leaving the mandatory requirements for the service supplier to be considered in the future.

As proposed by one member, Survey Panel further considered to insert a new hull inspection item of Watertight Cable Transit Seal System into Table 1 of UR Z23, and agreed to insert a new item 8.6 for this purpose. During the 30th Survey Panel meeting, the panel finalized the contents of item 8.6 of Table 1 of UR Z23.

After the 30<sup>th</sup> Survey Panel meeting, the panel finalized the new UR Z28 and the revisions to URs Z23 and Z17.

Refer TB Document in Annex 1 of Part B.

#### **5 Other Resolutions Changes:**

URs Z17, Z23

#### **6 Any hinderance to MASS, including any other new technologies:**

None

#### **7 Dates:**

Original Proposal: 29 September 2016 Made by A Survey Panel Member

Panel Approval: 21 September 2020 (Ref: 16222\_PYg)

GPG Approval: 02 October 2020 (Ref: 16222\_IGv)

## Part B. Technical Background

List of Technical Background (TB) documents for UR Z28:

Annex 1. **TB for New (Oct 2020)**

See separate TB document in Annex 1.



**Note:** *There are no separate Technical Background (TB) documents for Corr.1 (June 2021).*

## **Technical Background (TB) document for UR Z17 (Rev.15 Oct 2020) and UR Z23 (Rev.7 Oct 2020) and UR Z28 (New Oct 2020)**

### **1. Scope and objectives**

For addressing the complicated and arduous activities associated with the class inspections required for assuring the integrity of the pressure rated multi-cable transit (MCT) systems installed onboard ships or mobile offshore units (MOUs) from the time of their construction till the end of the ship's life, IACS took the decision:

- to develop new unified requirements on the survey of MCT systems, to be included in URs Z23, Z7 and Z15, based on the use of approved service suppliers to conduct the inspections of MCT systems; and consequently,
- to develop the relevant criteria for the certification of these service suppliers, to be included in UR Z17.

### **2. Engineering background for technical basis and rationale**

IACS Survey Panel, based on the information provided by various MCT system OEMs to the specific Project Team (PT) established for this task, identified the following items to be considered for drafting the survey requirements:

- A. conduct regular inspections to assure good condition of MCT systems, identify possible problems and address repairs in a timely manner;
- B. assure the traceability and product document for MCT systems through their lifecycle;
- C. apply easy to use technologies (digitization, RFID etc.) to store MCT system condition information;
- D. utilize external specialists to perform inspections and to supplement Surveyor's efforts;
- E. analyze repair-data to identify trouble-prone components or systems for proactive attention;
- F. standardize inspection and test methods in accordance with OEM recommendations.

IACS Survey Panel acknowledged the following added values in the use of external specialists for the inspection of MCT system and in the adoption of a MCT system register:

- A. a means to uniformly carry out the inspection of MCT system across all the class societies;
- B. an expert focus on an acknowledged weak-point of bulkhead integrity through the life cycle of a vessel or marine asset;

- C. a system by which MCT systems installation can be tracked throughout their life cycle.

### **3. Source/derivation of the proposed IACS Resolution**

- A. Industry feedback originating from known casualties and repetitive incidents of poorly installed and maintained equipment.
- B. OEM best practices and standards for installation and maintenance.
- C. OEM methodologies for documenting and tracking changes, disruptions, repairs or maintenance of MCT system installations.

### **4. Summary of Changes intended for the revised Resolution:**

Changes to Z23 will include new requirements which mandate the adoption of a Multi Cable Transit Seal Systems Register.

The Register, in hard copy or digitized media, will require any MCT system installation to be documented at time of ship's construction. The Register will include a marking / identification system, documentation referencing manufacturer manual(s) for each type of cable transit installed, the Type Approval certification for each type of transit system, applicable installation drawings, and a recording of each installed transit documenting the as built condition after final shipbuilder inspection in the shipyard.

The Register will also include sections to record any inspection, modification, repair and maintenance.

A recommendatory sample Cable Transit Seal System Register will be included in UR Z23 as an attachment.

A new item 8.6 is to be newly inserted into the Table 1 of UR Z23.

Subsequently, a new URZ will be developed in order that the Register will serve as an on board document maintained to track inspections, modifications and repairs and ensure such activities are properly performed by qualified personnel. The Register will also provide the Class Society Surveyor with a tool to improve the effectiveness of periodic inspections on marine vessels at the time of annual and special surveys.

In view of the above, UR Z17 will be revised to include the requirements for the approval of a new category of service suppliers for the inspection of Cable Transit Seal Systems, who will be tasked to verify MCT systems installation. This will assist to promote adherence to proper installation and maintenance procedures.

A new section 17 will be inserted in UR Z17.

### **5. Points of discussions or possible discussions**

5.1 Survey Panel concurred with the view that the fire rated MCT systems and the pipe penetrations should not be considered under this topic, since this task was specifically dealing with Watertight Cable Transits as proposed by the member initiating this issue.

5.2 Survey Panel and PT agreed to define in the Ship Construction File of UR Z23 a document 'Cable Transit Seal System Register' to record the details of watertight cable transits of a ship installed while under construction and throughout its life, including sections to record any inspection, modification, repair and maintenance.

5.3 Survey Panel concurred with the view that criteria should be established to support electronic formatting of the 'Cable Transit Seal System Register', which is the most operationally effective path to assist owners with installation, inspection, maintenance, and repairs throughout the MCT lifecycle, and agreed to include the recommendatory sample of the Cable Transit Seal Systems Register prepared by PT as Appendix 3 of UR Z23.

5.4 Survey Panel agreed to insert a new hull inspection item 8.6 for Watertight Cable Transit Seal System into Table 1 of UR Z23. When discussing whether to enter in the 'Survey Requirements for Classification' with "tightness", some members were of the view that after installation a leak test may be carried out but it is hard to check the actual watertightness of the CTSS, while the other members preferred to testing the watertightness of the CTSS after installation, and finally the panel agreed to leave the requirements of testing of the watertightness of CTSS to be decided by each society individually.

5.5 Survey Panel and PT deemed it necessary to use approved service suppliers to conduct inspections to the MCT/Transit systems, and developed the Section 17 of UR Z17 for the approval of the service suppliers engaged only in the inspections of Cable Transit Seal Systems, with a view that it will be impractical to use an approved service supplier every time for installing or maintaining the Multi Cable Seal Systems, such as when renewing a single cable.

5.6 Provisions for authorization were included in paragraph 17.2.3 of UR Z17 to allow for cases where the transit system OEM is no longer in business or does not provide technical support.

5.7 In paragraph 17.2.1 of UR Z17, it was agreed to include the contents to approve manufacturers or shipyards equally when they are acting as Service Suppliers.

5.8 Other than revising UR Z7 and UR Z15 for the survey requirements of CTSS for ships in service, Survey Panel agreed to develop a new UR Z28 applicable to all vessels and Mobile Offshore Units (MOUs) contracted for construction on or after 1st July 2021, in addition to the requirements of URs Z23, Z7 and Z15.

5.9 Survey Panel agreed to insert item 1.3 to UR Z28, and apply the survey requirement of item 8.6, Table 1 of UR Z23 to MOUs.

5.10 For the paragraph 4.1.3 of UR Z28, one Survey Panel member was of the view that the approved service supplier should also be permitted to undertake inspection of any disruption to the cable transits or installation of new cable transits, otherwise the use of having an approved service supplier is significantly reduced, while the other members supported to confirm those situations by the attending surveyor, and thus the wording "by the attending surveyor" is retained.

**6. Attachments if any**

Nil.

## UR Z29 “Remote Classification Surveys”

### Summary

This UR Z was newly developed to provide remote classification survey requirements for ships in service.

### Part A. Revision History

Version no.	Approval date	Implementation date when applicable
New (Mar 2022)	25 March 2022	1 January 2023

#### • New (Mar 2022)

##### 1 Origin of Change:

- Suggestion by IACS member

##### 2 Main Reason for Change:

It was considered essential to develop common requirements for the implementation of remote surveys as an acceptable form of intervention in some circumstances in response to the accelerated challenges to board vessels to do normal attendance surveys due to the Covid-19 situation. Further, increased and progressive adoption of remote surveys beyond the Covid-19 emergency situation is considered unavoidable due to the advanced technology developments and the possibilities of saving costs and time while ensuring the same quality and safety standards.

To ensure all IACS members have uniform guidance and requirements on remote surveys, a new IACS Unified Requirement has been developed with the objective of allowing remote surveys only in case the quality of survey is not compromised, and the survey is carried out with the same assurance as the ones performed by an on board attending surveyor.

##### 3 List of non-IACS Member classification societies contributing or participating in IACS Working Group:

Türk Loydu

##### 4 History of Decisions Made:

IACS Council C81, FUA 14, tasked the Survey Panel to establish a Project Team (PT) to assess the aspect related to the remote surveys, considering the recommendations 11B of SC/Strategy in July 2020. The PT PSU38/2021 (Survey Panel Task PSU 20033) was established in August-2020 and members prepared the Terms of Reference (ToR) / Scope of Work for PT which was approved by the Council. Task project team specification (Form A and Form 1) was prepared and same was agreed by the GPG in January 2021.



The PT acted in accordance with approved scope as per Form A and Form 1 and worked from February 2021 until the end of December 2021. The PT also collected the information from all members on the present status on what and how class societies are doing the remote surveys to get overall overview of scope and current procedure. It was clarified by the GPG that classification surveys during the new construction and statutory system audits are out of scope of this project. PT proposed that final output of the project shall be a new Unified Requirement, rather than a Recommendation, so that common requirements are applied by IACS members upon transposition of the said UR into individual classification rules. The development of such a UR, rather than a Recommendation, should meet the expectations of other stake holders, regulators, and Administrations.

One of the tasks of the PT was to define the 'Remote Survey', 'Remote Inspection' and 'Remote Examination'. The PT drafted the definition of remote survey, however, decided that there is no compelling reason to define 'remote inspection' and 'remote examination'. The commonly agreed terminology within IMO, EU, flag states and IACS is 'remote survey' for classification and statutory works. In addition, 'remote inspection technique' is already described in the IACS Rec 42. Furthermore, the words 'inspection' and 'examination' have been used at various places in the IACS resolutions, IMO Resolution A.1140(31)- survey guidelines under HSSC, ESP code, and RO code with different meanings. If a new definition of remote inspection/ remote examination is proposed now by the IACS, this would affect the referenced documents, which may need to be re-written to be consistent, and it could also conflict with the existing definitions already available in the industry.

The first draft of the UR was submitted by the PT to the Survey Panel on 28 September 2021. The Survey Panel Chair circulated the document through the IACS TC forum with the participation of Türk Loydu (TL) to all members. After the first round, the Survey Panel Chair tasked the PT to review the resulting comments from the TC forum. After reviewing all comments and making relevant changes, the PT submitted the 2nd draft to the Survey Panel Chair for further discussion within the TC forum on 29 October 2021. The 2nd round resulted in additional comments and amendments to the draft UR with comments as follows.

1. It was agreed that the UR should not define the start date of the remote survey.
2. It was agreed that not all digital information is required to be stored.
3. Majority of members expressed that the additional training required for remote surveys shall be in accordance with societies procedure and shall cover additional aspects as per para 2.2.1 of the UR
4. Majority of members expressed that monitoring of remote surveyor shall be carried out in accordance with IACS PR 6.
5. Majority of members agreed that no further clarification was needed to define "minor" items eligible for remote survey as per the table 1 of section 3.1.
6. Majority of members agreed that the UR should not be applicable for the offshore units.
7. Majority of members agreed not to include a formal definition of "place of survey"

Extensive discussions took place at the PT level and within the TC forum regarding the scope of the eligible survey items. The conclusion of this discussion resulted in the table 1 (Eligible remote survey items) of paragraphs 3.1 of proposed UR. Other discussions took place on information and communication technology requirements, qualification & monitoring of surveyors, performance, assessment and reporting of remote surveys.

The pure statutory scope (not covered by class rules) was also discussed during the development of requirements, however not included in the UR which is for classification items only.

While the UR sets the minimum requirements for Classification Remote Surveys, it also clearly requires that when the classification survey is also related to a statutory item, and the Society is carrying out the statutory survey on behalf of the Flag State Administration, then the Flag State Administration acceptance is required, and possible additional requirements are to be complied with.

The PT also reviewed and discussed the submissions made by China, Korea and EU/US at the IMO MSC 104, as well as current existing flag state instructions in that respect.

#### **5 Other Resolutions Changes:**

None

#### **6 Any hinderance to MASS, including any other new technologies:**

None

#### **7 Dates:**

Original Proposal	: 03 July 2020	Made by GPG (Ref: 20110_IGa)
Panel Approval	: 15 February 2022	(Ref: PSU20033_ISUn)
GPG Approval	: 25 March 2022	(Ref: 20110_IGz)

## **Part B. Technical Background**

List of Technical Background (TB) documents for UR Z29:

Annex 1. **TB for New (Mar 2022)**

See separate TB document in Annex 1.

## Technical Background (TB) document for UR Z29 (New Mar 2022)

### 1. Scope and objectives

With increasing remote surveys activities during the pandemic in the year 2020, It was observed that classification societies individually developed their own procedures without common requirements to carry out such remote surveys. To ensure all IACS members have uniform guidance & requirements, IACS initiated a Project Team (PT) under the Survey Panel in the autumn of 2020. The main task of the project was to develop the Unified Requirements or the Recommendations for classification remote surveys for ships in service. The IACS common requirements have been developed with an objective that the Remote Survey will only be appropriate provided the quality is not compromised, and the survey is carried out with the same assurance as the ones performed by an on board attending surveyor.

The project was carried out as per following objectives (refer approved Form 1):

1. Develop the principles to ensure equivalency between remote survey and traditional survey with surveyor attendance,
2. Establish general definition, application scope, conditions and limitations of remote survey, any gaps/requirements in terms of training of personnel,
3. Review existing IACS resolutions to Identify impediments to remote surveys and any inconsistency which may exist in HSSC Guidelines with respect to remote survey (Refer to UR Z1),
4. Consider the development of a UR or Rec.

The following scope was agreed for the project:

1. To collect members' remote survey application, scope, experience and relevant techniques and technology being used, as well as flag requirements on remote survey, as appropriate.
2. To identify and analyse current/potential expectation and concerns of regulators and the industry, such as DG MOVE, AVC, IMO, Flag, Ship-owner, Insurer, etc.
3. To develop the principles to ensure equivalency between remote survey and traditional survey with surveyor attendance, taking into account current and potential technological innovation, quality assurance and for the benefit of sustainable class/industry development.
4. To establish general definition, application scope, conditions and limitations of remote survey, any gaps/requirements in terms of training of personnel, and further distinguish pertinent terms such as "Remote Survey", "Remote Inspection" and "Remote Examination" used by IACS and Industry.
5. To review existing IACS resolutions to identify impediments to remote survey, and further identify any inconsistency which may exist in HSSC Guidelines (refer to UR Z1).
6. To consider the development of a UR or Rec by drafting:
  - a) minimum requirements for remote survey in order to confirm equivalency to conducting an onboard survey;
  - b) minimum requirements of quality for information communication technologies, including connectivity and speed;
  - c) scope and detailed remote survey processes;
  - d) requirements for evidence/documentation to be recorded and reported.

## **2. Engineering background for technical basis and rationale**

The work was divided into three phases.

Phase A – Info Gathering - collected information on present status on what and how class societies were doing remote survey

Phase B – Equivalence and Impediments – it covered overarching principles to ensure equivalency between remote survey and traditional onboard survey. The project identified gaps and requirements in terms of training of personnel, and further defined pertinent terms such as 'Remote Survey' used by IACS and the Industry. The existing IACS resolutions were reviewed to identify impediments to remote survey, and further identify any inconsistencies which may exist in HSSC Guidelines with respect to remote survey (UR Z1).

Phase C – Summary Phase – based on findings from Phase A and B, considered the development of a UR for Remote Survey. The UR was developed based on the following main items:

- a) Minimum requirements for remote survey in order to confirm equivalency to conducting an onboard survey
- b) Minimum requirements of quality for information communication technologies including connectivity and speed
- c) Scope and detailed remote survey processes
- d) Requirements for evidence/documentation to be recorded and reported.

## **3. Source/derivation of the proposed IACS Resolution**

The proposed UR is not based on any international/national/industry standard. The UR has been developed based on the experiences and procedures developed by the individual classification societies including the experience during the force majeure situation during the COVID-19. Due account was taken to the general policies of flag states and to the principals laid down to the submissions by EU/US, Korea and China.

## **4. Summary of Changes intended for the revised Resolution:**

None

## **5. Points of discussions or possible discussions**

The project's main focus was to develop the common requirements, keeping the principle of equivalency between remote and traditional on board surveys into consideration. Extensive discussions took place at the PT level and within the TC forum regarding the scope of the eligible survey items. The conclusion of this discussion resulted in the table 1 (Eligible remote survey items) of paragraphs 3.1 of proposed UR. Other discussions took place on information and communication technology requirements, qualification & monitoring of surveyors, performance, assessment and reporting of remote surveys.

The PT reviewed and discussed to the submissions made by China, Korea and EU/US at the IMO MSC 104, as well as current existing flag state instructions in that respect.

While the UR sets the minimum requirements for Classification remote surveys, it also clearly requires that when the classification survey is also related to a statutory item, and the Society is carrying out the statutory survey on behalf of the Flag State Administration, then the Flag State Administration acceptance is required, and possible additional requirements are to be complied with.

## **6. Attachments if any**

Appendix – Inconsistency and Impediments to remote survey in the current IACS resolutions

## Appendix

### Inconsistencies in HSSC Guidelines w.r.t Remote Survey:

No specific inconsistencies in HSSC Guidelines w.r.t remote survey have been noticed. Meantime, interpretation of the terminology of "visual examination" which are used in 4.2.2.2.1 & 2 of HSSC Guidelines – General is to be clarified for applying remote survey, and PT concluded that "visual examination" included remote survey using appropriate communication means such as live-streaming two-way video with audio.

### Impediments to remote survey in the IACS resolutions:

Some impediments to remote survey have been noticed in the IACS resolutions as shown in the below table. In various parts of IACS resolutions, the terminologies such as "attended", "attended on board", "be on board", "attendance" and "witnessed" are used and such terminologies, that were normally interpreted as requiring physical attendance/witness (on board), will need to be interpreted in the future as requiring physical or remote attendance/witness.

Scope	PR/UR	Para No.	Regulatory impediment
Extension of special survey	PR1C	A1.1.1	Under "exceptional circumstances", the Society may grant an extension not exceeding three (3) months to allow for completion of the Special Survey provided that the vessel is attended and the attending Surveyor(s) <sup>1</sup> so recommend(s) after the following has been carried out: ...
Single voyage to demolition yard	PR1C	A1.6	When a vessel is intended for a demolition voyage with any periodical survey overdue, the vessel's class suspension may be held in abeyance and consideration may be given to allow the vessel to proceed on a single direct ballast voyage from the lay up or final discharge port to the demolition yard. In such cases a short term Class Certificate with conditions for the voyage noted may be issued provided the attending surveyor finds the vessel in satisfactory condition to proceed for the intended voyage.
Safety Radio during change of class without flag change	PR12	5.2.2 b)	Prior to the issuance of a Cargo Ship Safety Radio Certificate, the gaining Society shall carry out a full Renewal Survey (in case of non-HSSC certification) or a full Periodical Survey (in cases of HSSC certification). In cases where the Cargo Ship Safety Radio survey carried out due to change of class is not to be credited as periodical or renewal survey and the service supplier used by the losing Society is acceptable to the gaining Society, the survey may be limited to a

			general verification by the attending surveyor based on the last service report.
Thickness measurement	PR19	1	Thickness Measurements required in the context of hull structural classification surveys, if not carried out by the Society itself shall be witnessed by a surveyor. The attendance of the surveyor shall be recorded.
		2	This requires the surveyor to be on board, while the gaugings are taken, to the extent necessary to control the process (see Footnote).
Relevant special/intermediate survey for certain ESP ships	PR20	2	This requires that at least two exclusive surveyors attend on board at the same time to perform the required survey <sup>1</sup> ). Where compatible with relevant laws and regulations, on dual class vessels, the requirement for two surveyors may be fulfilled by having one surveyor attend from each Society.
Access to structure	UR Z7 Z7.1 Z7.2 Z10.1 Z10.2  Z10.3 Z10.4 Z10.5 Z15	5.2.1/5.2.2 5.2.1/5.2.2 5.2.1/5.2.2 5.3.1/5.3.2 5.3.1/5.3.2/ 5.3.3/5.3.4 5.3.1/5.3.2 5.3.1/5.3.2 5.3.1/5.3.2 9.2.1/9.2.2	(Example) UR Z7 5.2.1 For survey, means are to be provided to enable the surveyor to examine the hull structure in a safe and practical way. 5.2.2 For survey in cargo holds and ballast tanks, one or more of the following means for access, acceptable to the Surveyor, is to be provided: <ul style="list-style-type: none"> <li>• permanent staging and passages through structures;</li> <li>• temporary staging and passages through structures;</li> <li>• hydraulic arm vehicles such as conventional cherry pickers, lifts and movable platforms;</li> <li>• boats or rafts;</li> <li>• other equivalent means.</li> </ul>
Close-up survey	UR Z7	1.2.3	A Close-Up Survey is a survey where the details of structural components are within the close visual inspection range of the surveyor i.e. normally within reach of hand.
Thickness measurement and close-up survey using RIT	UR Z7	1.4.2	Consideration may be given by the attending Surveyor to allow use of Remote Inspection Techniques (RIT) as an alternative to close-up survey. Surveys conducted using a RIT are to be completed to the satisfaction of the attending Surveyor. When RIT is used for a close-up survey, temporary means of access for the corresponding thickness measurements is to be provided unless such RIT is also able to carry out the required thickness measurements.



Close-up survey using RIT	UR Z7	1.6.3	When using a RIT as an alternative to close-up survey, if not carried out by the Society itself, it is to be conducted by a firm approved as a service supplier according to URZ17 and is to be witnessed by an attending surveyor of the Society.
Examination of bilge/ballast piping systems during special survey	UR Z7	2.2.12	All bilge and ballast piping systems are to be examined and operationally tested to working pressure to attending Surveyor's satisfaction to ensure that tightness and condition remain satisfactory.
Survey for automatic air pipe heads during special survey	UR Z7	TABLE 4 Note (1)	The selection of air pipe heads to be examined is left to the attending Surveyor.
Close-up survey for general dry cargo	UR Z7.1	1.2.4	A Close-up Survey is a survey where the details of structural components are within the close visual inspection range of the surveyor, i.e. normally within reach of hand.
Thickness measurement and close-up survey using RIT for general dry cargo	UR Z7.1	1.4.2	Consideration may be given by the attending Surveyor to allow use of Remote Inspection Techniques (RIT) as an alternative to close-up survey. Surveys conducted using a RIT are to be completed to the satisfaction of the attending Surveyor. When RIT is used for a close-up survey, temporary means of access for the corresponding thickness measurements as specified in this UR is to be provided unless such RIT is also able to carry out the required thickness measurements.
Close-up survey using RIT for general dry cargo	UR Z7.1	1.5.3	When using a RIT as an alternative to close-up survey, if not carried out by the Society itself, it is to be conducted by a firm approved as a service supplier according to UR Z17 and is to be witnessed by an attending surveyor of the Society.
Examination of bilge/ballast piping systems during special survey for general dry cargo	UR Z7.1	2.2.1.3	All piping systems within the above spaces are to be examined and operationally tested to working pressure to attending Surveyor's satisfaction to ensure that tightness and condition remain satisfactory.
Intermediate survey for general dry cargo over 15 years of age	UR Z7.1	4.2.4.1	The requirements of the Intermediate Survey are to be to the same extent as the previous Special Survey as required in 2, except for item 2c) in column 4 of Table II. However, tank testing specified in 2.5, survey of automatic air pipe heads (see Notes in 2.2.1.4 and 2.3.4) and internal examination of fuel oil, lube oil and fresh water tanks (see 2.3.1) are not required unless deemed necessary by the

			attending surveyor.
Thickness measurement for general dry cargo	UR Z7.1	6.1.1	The required thickness measurements, if not carried out by the Society itself, are to be witnessed by a surveyor of the Society. The surveyor is to be on board to the extent necessary to control the process.
Thickness measurement and close-up survey using RIT for liquefied gas carriers	UR Z7.2	1.4.2	Consideration may be given by the attending Surveyor to allow use of Remote Inspection Techniques (RIT) as an alternative to close-up survey. Surveys conducted using a RIT are to be completed to the satisfaction of the attending Surveyor. When RIT is used for a close-up survey, temporary means of access for the corresponding thickness measurements as specified in this UR is to be provided unless such RIT is also able to carry out the required thickness measurements.
Close-up survey using RIT for liquefied gas carriers	UR Z7.2	1.5.3	When using a RIT as an alternative to close-up survey, if not carried out by the Society itself, it is to be conducted by a firm approved as a service supplier according to UR Z17 and is to be witnessed by an attending surveyor of the Society.
Examination and operational test of piping systems within certain spaces during special survey for liquefied gas carriers	UR Z7.2	2.2.1.3	All piping systems within the above spaces, except those covered by UR Z16, are to be examined and operationally tested to working pressure to attending Surveyor's satisfaction to ensure that tightness and condition remain satisfactory.
Thickness measurement for liquefied gas carriers	UR Z7.2	6.1.1	The required thickness measurements, if not carried out by the Society itself, are to be witnessed by a Surveyor of the Society. The Surveyor is to be on board to the extent necessary to control the process.
Examination and operational test of piping systems within certain tanks/spaces during special survey for oil tankers	UR Z10.1	2.2.1.3	Cargo piping on deck, including Crude Oil Washing (COW) piping, Cargo and Ballast piping within the above tanks and spaces are to be examined and operationally tested to working pressure to attending Surveyor's satisfaction to ensure that tightness and condition remain satisfactory. Special attention is to be given to any ballast piping in cargo tanks and cargo piping in ballast tanks and void spaces, and Surveyors are to be advised on all occasions when this piping, including valves and fittings are open during repair periods and can be examined internally.

Intermediate survey for oil tankers 10-15 years of age	UR Z10.1	4.2.3.1	The requirements of the Intermediate Survey are to be to the same extent as the previous Special Survey as required in 2 and 5.1. However, pressure testing of cargo and ballast tanks and the requirements for longitudinal strength evaluation of Hull Girder as required in 8.1.1.1 are not required unless deemed necessary by the attending Surveyor.
Intermediate survey for oil tankers over 15 years of age	UR Z10.1	4.2.4.1	The requirements of the Intermediate Survey are to be to the same extent as the previous Special Survey as required in 2 and 5.1. However, pressure testing of cargo and ballast tanks and the requirements for longitudinal strength evaluation of Hull Girder as required in 8.1.1.1 are not required unless deemed necessary by the attending Surveyor.
Thickness measurement for oil tankers	UR Z10.1	7.1.1	The required thickness measurements, if not carried out by the Society itself, are to be witnessed by a Surveyor of the Society. The Surveyor is to be on board to the extent necessary to control the process.
Survey planning meeting	UR Z10.1	5.7.1	Proper preparation and close co-operation between the attending surveyor(s) and the owner's representatives onboard prior to and during the survey are an essential part in the safe and efficient conduct of the survey. During the survey on board safety meetings are to be held regularly.
		5.7.2	Prior to commencement of any part of the renewal and intermediate survey, a survey planning meeting is to be held between the attending surveyor(s), the owner's representative in attendance, the thickness measurement firm operator (as applicable) and the master of the ship or an appropriately qualified representative appointed by the master or Company for the purpose to ascertain that all the arrangements envisaged in the survey programme are in place, so as to ensure the safe and efficient conduct of the survey work to be carried out. See also 7.1.2.
Examination and operational test of piping systems within certain spaces during special survey for bulk carriers	UR Z10.2	2.2.1.3	All piping systems within the above Spaces are to be examined and operationally tested to working pressure to attending Surveyor's satisfaction to ensure that tightness and condition remain satisfactory.
Intermediate survey for bulk carriers 10-15 years of age	UR Z10.2	4.2.3.1	The requirements of the Intermediate Survey are to be to the same extent to the previous Special Survey as required in 2 and 5.1. However, internal examination of fuel tanks and pressure testing of all tanks are not

			required unless deemed necessary by the attending surveyor.
Intermediate survey for bulk carriers over 15 years of age	UR Z10.2	4.2.4.1	The requirements of the Intermediate Survey are to be to the same extent to the previous Special Survey as required in 2 and 5.1. However, internal examination of fuel tanks and pressure testing of all tanks are not required unless deemed necessary by the attending surveyor.
Survey planning meeting	UR Z10.2	5.7.1	Proper preparation and close co-operation between the attending surveyor(s) and the owner's representatives onboard prior to and during the survey are an essential part in the safe and efficient conduct of the survey. During the survey on board safety meetings are to be held regularly.
		5.7.2	Prior to the commencement of any part of the Special and Intermediate Survey a survey planning meeting is to be held between the attending Surveyor(s), the Owner's Representative in attendance and the TM firm representative, where involved, and the master of the ship or an appropriately qualified representative appointed by the master or firm for the purpose of ascertaining that all the arrangements envisaged in the survey programme are in place, so as to ensure the safe and efficient conduct of the survey work to be carried out. See also 7.1.2.
Thickness measurement for bulk carriers	UR Z10.2	7.1.1	The required thickness measurements, if not carried out by the Society itself, are to be witnessed by a surveyor of the Society. The surveyor is to be on board to the extent necessary to control the process.
Thickness measurement and close-up survey using RIT for chemical tankers	UR Z10.3	1.4.2	Consideration may be given by the attending Surveyor to allow use of Remote Inspection Techniques (RIT) as an alternative to close-up survey. Surveys conducted using a RIT are to be completed to the satisfaction of the attending Surveyor.
Close-up survey using RIT for chemical tankers	UR Z10.3	1.5.3	When using a RIT as an alternative to close-up survey, if not carried out by the Society itself, it is to be conducted by a firm approved as a service supplier according to UR Z17 and is to be witnessed by an attending surveyor of the Society.
Examination and operational test of piping systems within certain	UR Z10.3	2.2.1.3	Cargo piping on deck and cargo and ballast piping within the above tanks and spaces are to be examined and operationally tested to working pressure to attending Surveyor's

tanks/spaces during special survey for chemical tankers			satisfaction to ensure that tightness and condition remain satisfactory. Special attention is to be given to any ballast piping in cargo tanks and cargo piping in ballast tanks and void spaces, and Surveyors are to be advised on all occasions when this piping, including valves and fittings are open during repair periods and can be examined internally.
Intermediate survey for chemical tankers 10-15 years of age	UR Z10.3	4.2.3.1	The requirements of the Intermediate Survey are to be to the same extent as the previous Special Survey as required in 2 and 5.1. However, pressure testing of cargo and ballast tanks is not required unless deemed necessary by the attending Surveyor.
Intermediate survey for chemical tankers over 15 years of age	UR Z10.3	4.2.4.1	The requirements of the Intermediate Survey are to be to the same extent as the previous Special Survey as required in 2 and 5.1. However, pressure testing of cargo and ballast tanks is not required unless deemed necessary by the attending Surveyor.
Survey planning meeting	UR Z10.3	5.7.1	Proper preparation and close co-operation between the attending surveyor(s) and the owner's representatives onboard prior to and during the survey are an essential part in the safe and efficient conduct of the survey. During the survey on board safety meetings are to be held regularly.
		5.7.2	Prior to the commencement of any part of the Special and Intermediate Survey a survey planning meeting is to be held between the attending Surveyor(s), the Owner's Representative in attendance and the TM firm representative, where involved, and the master of the ship or an appropriately qualified representative appointed by the master or firm for the purpose of ascertaining that all the arrangements envisaged in the survey programme are in place, so as to ensure the safe and efficient conduct of the survey work to be carried out. See also 7.1.2.
Examination and operational test of piping systems within certain tanks/spaces during special survey for double hull oil tankers	UR Z10.4	2.2.1.3	Cargo piping on deck, including Crude Oil Washing (COW) piping, Cargo and Ballast piping within the above tanks and spaces are to be examined and operationally tested to working pressure to attending Surveyor's satisfaction to ensure that tightness and condition remain satisfactory. Special attention is to be given to any ballast piping in cargo tanks and any cargo piping in ballast tanks and void spaces, and Surveyors are to be advised on all occasions when this piping, including valves and fittings are open during repair periods and can be examined internally.

Intermediate survey for double hull oil tankers 10-15 years of age	UR Z10.4	4.2.3.1	The requirements of the Intermediate Survey are to be to the same extent as the previous Special Survey as required in 2 and 5.1. However, pressure testing of cargo and ballast tanks and the requirements for longitudinal strength evaluation of Hull Girder as required in 8.1.1.1 are not required unless deemed necessary by the attending Surveyor.
Survey planning meeting	UR Z10.4	5.7.1	Proper preparation and close co-operation between the attending surveyor(s) and the owner's representatives onboard prior to and during the survey are an essential part in the safe and efficient conduct of the survey. During the survey on board safety meetings are to be held regularly.
		5.7.2	Prior to the commencement of any part of the Special and Intermediate Survey a survey planning meeting is to be held between the attending Surveyor(s), the Owner's Representative in attendance, the TM firm representative, where involved, and the master of the ship or an appropriately qualified representative appointed by the master or Company for the purpose of ascertaining that all the arrangements envisaged in the survey programme are in place, so as to ensure the safe and efficient conduct of the survey work to be carried out. See also 7.1.2.
Intermediate survey for double hull oil tankers over 15 years of age	UR Z10.4	4.2.4.1	The requirements of the Intermediate Survey are to be to the same extent as the previous Special Survey as required in 2 and 5.1. However, pressure testing of cargo and ballast tanks and the requirements for longitudinal strength evaluation of Hull Girder as required in 8.1.1.1 are not required unless deemed necessary by the attending Surveyor.
Thickness measurement for double hull oil tankers	UR Z10.4	7.1.1	The required thickness measurements, if not carried out by the Society itself, are to be witnessed by a Surveyor of the Society. The Surveyor is to be on board to the extent necessary to control the process.
Examination and operational test of piping systems within certain spaces during special survey for double skin bulk carriers	UR Z10.5	2.2.1.3	All piping systems within the above spaces are to be examined and operationally tested to working pressure to attending Surveyor's satisfaction to ensure that tightness and condition remain satisfactory.

Selection of representative ballast tanks	UR Z10.5	Table IV	Overall survey of Representative ballast tanks selected by the attending surveyor (the selection is to include fore and aft peak tanks and a number of other tanks, taking into account the total number and type of ballast tanks) The requirements of the previous special survey (see 4.2.3) The requirements of the previous special survey (see 4.2.4)
Intermediate survey for double skin bulk carriers 10-15 years of age	UR Z10.5	4.2.3.1	The requirements of the Intermediate Survey are to the same extent as the previous Special Survey as required in 2 and 5.1. However, internal examination of fuel oil tanks and pressure testing of all tanks are not required unless deemed necessary by the attending Surveyor.
Intermediate survey for double skin bulk carriers over 15 years of age	UR Z10.5	4.2.4.1	The requirements of the Intermediate Survey are to be to the same extent as the previous Special Survey as required in 2 and 5.1. However, internal examination of fuel oil tanks and pressure testing of all tanks are not required unless deemed necessary by the attending Surveyor.
Thickness measurement for double skin bulk carriers	UR Z10.5	7.1.1	The required thickness measurements, if not carried out by the Classification Society itself, are to be witnessed by a Surveyor of the Society. The Surveyor is to be on board to the extent necessary to control the process.
Voyage repairs	UR Z13	ANNEX A.4.	Verification of new materials regarding certification, grade and scantlings. Verified mill sheets to remain on board and to be provided to attending Surveyor examining completed repairs.
		ANNEX A.6.	Verification of the qualification of welders and supervisory personnel, qualification records to remain on board and to be provided to attending Surveyor examining completed repairs.
		ANNEX A.12.	Completed repairs are to be examined and tested as required to the satisfaction of the attending Surveyor.
		ANNEX B.	Any contemplated repairs to primary hull structures, i.e. main longitudinal and transverse members and their attachments, are to be submitted to the Classification Society for review prior to commencing voyage repairs. Riding repairs to primary hull structures should not be permitted except in extreme circumstances. Any repairs to primary hull structures shall require attendance by a Surveyor riding-ship survey or at regular intervals to confirm fit-up, alignment, general workmanship and compliance with

			recommendations. NDT of completed repairs to primary structure to be carried out to attending Surveyor's satisfaction. Repairs to other hull structural parts may be accepted based on examination upon completion of repairs.
Close-up survey using RIT for mobile offshore drilling units	UR Z15	1.4.3	When using a RIT as an alternative to close-up survey, if not carried out by the Society itself, it is to be conducted by a firm approved as a service supplier according to UR Z17 and is to be witnessed by an attending surveyor of the Society.
Survey of the outside of unit's bottom and related items for mobile offshore drilling units	UR Z15	4.2.1. Surface-type Units (ship or barge type units)	<ul style="list-style-type: none"> <li>External surfaces of the hull, keel, stem, stern frame, rudder, nozzles, and sea strainers are to be selectively cleaned to the satisfaction of the attending Surveyor and examined together with appendages, the propeller, exposed parts of stern bearing assembly, rudder pintle and gudgeon securing arrangements, sea chest and strainers, and their fastenings.</li> <li>Propeller shaft bearing, rudder bearing, and steering nozzle clearances are to be ascertained and recorded.</li> </ul>
		4.2.2. Self-Elevating Units	<ul style="list-style-type: none"> <li>External surfaces of the upper hull or platform, spud cans, mat, underwater areas of legs, together with their connections as applicable, are to be selectively cleaned to the satisfaction of the attending Surveyor and examined.</li> <li>At each Drydocking Survey or equivalent, after Special Survey No. 2, the Surveyor is to be satisfied with the condition of the internal structure of the mat or spud cans. Leg connections to mat and spud cans are to be examined at each Drydock Survey or equivalent. Non-destructive testing may be required of areas considered to be critical by the Society or found to be suspect by the Surveyor.</li> </ul>
		4.2.3. Column-Stabilized Units	<ul style="list-style-type: none"> <li>External surfaces of the upper hull or platform, footings, pontoons or lower hulls, underwater areas of columns, bracing and their connections, sea chests, and propulsion units as applicable, are to be selectively cleaned and examined to the satisfaction of the attending Surveyor. Non-destructive testing may be required of areas considered to be critical by the Society or found to be suspect by the Surveyor.</li> </ul>



Internal examination of boiler	UR Z18	2.1	... When direct visual internal inspection is not feasible due to the limited size of the internal spaces, such as for small boilers and/or narrow internal spaces, this may be replaced by a hydrostatic pressure test or by alternative verifications as determined by the Classification Society. ...
Test of safety valves for exhaust gas heated economizer during annual survey	UR Z18	2.2	External survey of boilers including test of safety and protective devices, and test of safety valve using its relieving gear, is to be carried out annually, within the window of the Annual Survey of a ship. For exhaust gas heated economizers, the safety valves are to be tested by the Chief Engineer at sea within the annual survey window. This test is to be recorded in the log book for review by the attending Surveyor prior to crediting the Annual Survey of Machinery.
Machinery verification runs -Dock trial during special survey -Sea trial after significant repair	UR Z18	4.1	As part of the Special Survey of Machinery, a dock trial is to be carried out to attending Surveyors' satisfaction to confirm satisfactory operation of main and auxiliary machinery. If significant repairs are carried out to main or auxiliary machinery or steering gear, consideration should be given to a sea trial to attending Surveyors' satisfaction.
Tightness test during annual survey for shell and inner doors of Ro-Ro ships	UR Z24	4.12	A hose test or equivalent is to be carried out. If the visual examination and function test have shown satisfactory results, the tightness test of shell doors on Ro-Ro cargo ships need not be carried out unless considered necessary by the attending surveyor.
Close-up surveys of doors, locking, securing and supporting devices and fittings for Ro-Ro ships	UR Z24	Table 1	The following is a list of the devices and fittings and associated welding to be subject to close-up survey by the attending Surveyor.